

ENGINEERING FOR ARCHITECTURE 1979

ARCHITECTURAL RECORD

MID-AUGUST 1979



A MCGRAW-HILL PUBLICATION

\$5.50 PER COPY

Kerfed panel edges lock around concealed aluminum splines for quick attachment to all wall surfaces. The mineral fiberboard is easily cut to accommodate doors, windows, outlets, and switches.



Soundsoak™ 85 Wall Panels absorb 16 times more sound than basic bare walls.

If you're designing a work space where speech privacy is essential, Soundsoak 85 Wall Panels may well be essential, too. They have a noise-reduction coefficient of 85%. And in the speech frequency range, average sound absorption is 98%!

Conventional gypsum-board walls, on the other hand, have an NRC of only 5%. They bounce 95% of the sound right back at you.

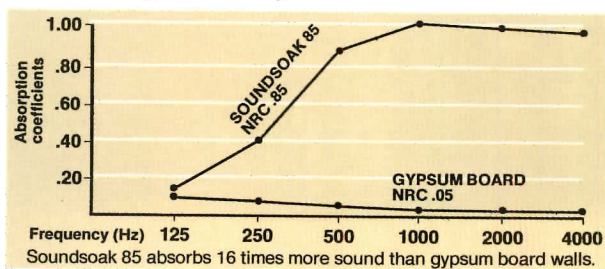

As a result of its absorption, Soundsoak 85 greatly reduces annoying sound reflection, providing an NIC'_F of 20. So Soundsoak 85 is the right specification for open plan spaces.

Along with super quiet, you get super beauty in six natural and six accent colors. Fire-retardant panels are 24" wide by 9' high, and they can be installed overnight.

So, when you want a great looking, easy-to-install acoustical wall panel, the only choice is Soundsoak 85. Sixteen times more sound absorbent than basic bare walls. For a free sample and literature, write Armstrong, Dept. 93NAR, Lancaster PA 17604.

FROM THE  INDOOR WORLD® OF

Armstrong

EDITOR

WALTER F. WAGNER, JR., AIA

MANAGING EDITOR

HERBERT L. SMITH, JR., AIA

SENIOR EDITORS

ROBERT E. FISCHER

MILDRED F. SCHMERTZ, FAIA

ASSOCIATE EDITORS

GERALD ALLEN

GRACE M. ANDERSON

BARCLAY F. GORDON

CHARLES E. HAMLIN

CHARLES K. HOYT, AIA

WILLIAM MARLIN

JANET NAIRN

PRODUCTION EDITOR

ANNETTE K. NETBURN

DESIGN

ALEX H. STILLANO, Director

ALBERTO BUCCHIANERI, Senior associate

ANNA-MARIA EGGER, Associate

MURIEL CUTTRELL, Illustration

J. DYCK FLEDDERUS, Illustration

JAN WHITE, Consultant

EDITORIAL CONSULTANTS

EDWARD LARRABEE BARNES, FAIA

JONATHAN BARNETT, AIA, Urban design

GEORGE A. CHRISTIE, JR., Economics

ERNEST MICKEL, Hon. AIA, Washington

PAUL RUDOLPH, FAIA

Foreign architecture

L'Architecture d'Aujourd'hui, Paris

McGRAW-HILL WORLD NEWS

RALPH R. SCHULZ, Director

9 domestic and 10

international news bureaus:

Bonn, Brussels, Buenos Aires,

London, Milan, Moscow, Paris,

Singapore, Tokyo, Toronto.

CIRCULATION DIRECTOR

RICHARD H. DI VECCHIO

BUSINESS MANAGER

JOSEPH R. WUNK

DIRECTOR OF MARKETING SERVICES

ELIZABETH HAYMAN

PUBLISHER

ROBERT G. KLIESCH

EXECUTIVE DIRECTOR

BLAKE HUGHES

Of particular assistance to the editor in the preparation of this issue were:

Robert E. Fischer, editor-in-charge;

Grace M. Anderson, associate editor;

Annette K. Netburn, production editor;

Donna Protas, assistant to the editors;

Cynthia Miele, production

Jan White, design; Faye Eng, design;

Charles Mazarakes, art production;

Muriel Cuttrel, illustration;

Joseph R. Wunk, production.

ARCHITECTURAL RECORD (Combined with AMERICAN ARCHITECT, ARCHITECTURE and WESTERN ARCHITECT AND ENGINEER) (USPS 132-650)

Mid-August 1979, Vol. 166, No. 3. Title® reg. in U. S. Patent Office, copyright© 1979 by McGraw-Hill, Inc. All rights reserved. Copyright not claimed on front cover and editorial four-color separations. Indexed in Reader's Guide to Periodical Literature, Art Index, Applied Science and Technology Index, Engineering Index, and The Architectural Index.

Quotations on reprints of articles available. Every possible effort will be made to return material submitted for possible publication (if accompanied by stamped, addressed envelope), but the editors and the corporation will not be responsible for loss or damage.

EXECUTIVE, EDITORIAL, CIRCULATION AND ADVERTISING OFFICES: 1221 Avenue of the Americas, New York, N.Y. 10020.

OFFICERS OF McGRAW-HILL PUBLICATIONS COMPANY: president, Gordon L. Jones, group vice presidents: Gene W. Simpson, James E. Boddorf; senior vice presidents: Russell F. Anderson; Ralph R. Schulz, editorial; vice presidents: James E. Hackett, controller; Thomas H. King, manufacturing; Robert Leyburn, circulation; John W. Patten, sales;

Edward E. Schirmer, international.

CORPORATION OFFICERS: Harold W. McGraw, president, chief executive officer and chairman of the board; Robert N. Landes, senior vice president and secretary; Ralph J. Webb, treasurer.

ASSOCIATED SERVICES/McGraw-Hill Information Systems Co.: Sweet's Catalog Files (General Building, Engineering, Industrial Construction and Renovation, Light Residential Construction, Interiors), Dodge Building Cost Services, Dodge Reports and Bulletins, Dodge/SCAN Microfilm Systems, Dodge Management Control Service, Dodge Construction Statistics, Dodge regional construction newspapers (Chicago, Denver, Los Angeles, San Francisco).

SUBSCRIPTIONS: Subscriptions solicited only from architects and engineers. Position, firm connection, and type of firm must be indicated on subscription orders. Please allow 4-12 weeks for shipment. Subscription rates for U.S., U.S. Possessions: \$21.00 for architects, engineers and others in the field served; all others \$29.00. In Canada: \$23.00 for architects, engineers and others in the field served; all others \$31.00. In all other countries: \$45.00 for architects and engineers; all others \$49.00. Domestic and Canadian single copy price: \$5.50 except the

mid-May issue which is \$5.95. Foreign single copy price: \$7.00.

GUARANTEE: Publisher agrees to refund that part of subscription price applying to unfilled part of subscription if service is unsatisfactory.

CHANGE OF ADDRESS: Forward changes of address or service letters to Fulfillment Manager, Group A, ARCHITECTURAL RECORD, P.O. Box 430, Hightstown, NJ 08520. Provide both old and new address, including zip code; if possible attach issue address label.

PUBLICATION OFFICE: 1221 Avenue of the Americas, New York, New York, 10020. ARCHITECTURAL RECORD (UPS 132-650) published monthly except May, August and October when semi-monthly, by McGraw-Hill, Inc. Controlled circulation postage paid at Strasburg, Virginia.

POSTMASTER: PLEASE SEND FORM 3579 to Fulfillment Manager, ARCHITECTURAL RECORD, P.O. Box 430, Hightstown, NJ 08520.

THIS ISSUE is published in national and separate editions.



ENGINEERING FOR ARCHITECTURE

THE RECORD REPORTS

7 Editorial

About commitments:
three cheers (relatively speaking)
for our team

27 Buildings in the news

ARCHITECTURAL BUSINESS

43 Design firm overhead found to be more than twice direct labor costs

121 Product reports

122 Office literature

164 Professional services

166 Advertising index

169 Reader service inquiry card

BUILDING TYPES STUDY 535

53 Engineering for Architecture

...an introduction

54 Industrial materials and techniques

become art at Foster Associates

English architect Norman Foster has succeeded in applying industrialization to architecture with assurance and polish.

66 Conversation with Cesar Pelli

Dean Pelli considers the true elements of technology and its unbreakable bonds with architecture.

68 Le Corbusier: structural mastery supports art

Structural engineer Herman Spiegel, a Gaudi buff, now turns to Corbu whose mastery of structure he feels to be grossly underrated.

76 Round Table: Risk-taking in design and building

At a time when litigation seems to be getting out of hand, architects and engineers ask whether the risks are worth the rewards.

86 Membrane roofs designed to endure

As architects and owners gain more confidence in engineered tents, these structures are being used for major buildings.

94 The Ehrenkrantz Group: where process is the byword

From his systems work on, Ezra Ehrenkrantz has stressed process and the approach seems to work for more and more clients.

102 Engineered daylighting for a major energy company

Studies on models and computer graphics helped CRS evaluate their design for a Houston office building.

106 Three acoustic designs from Europe: a foretaste of the future

Experimentation in Paris, a truly integrated performing arts facility in the Netherlands, and electronics to boost reverberation in England.

Cover: Sainsbury Centre for Visual Arts
Norwich, England
Architects: Foster Associates
Photographer: Ken Kirkwood

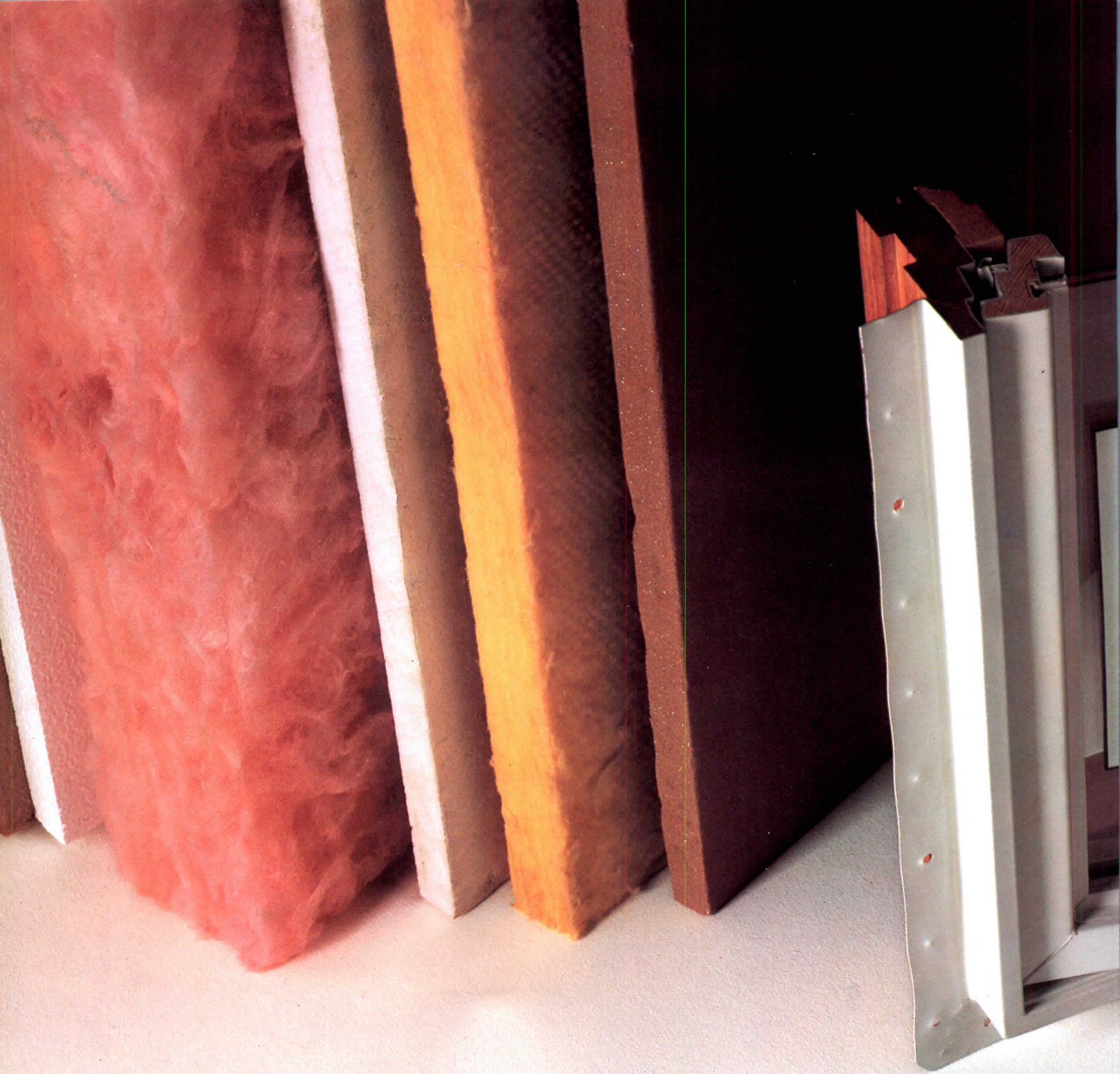

The more you insulate, the

If you're going to insulate a building to its maximum cost-effectiveness, you ought to include quality windows, too.

Andersen® Perma-Shield® windows, for instance, help insulate where heat loss might otherwise be the greatest—in the window area itself.

Compared to windows that only meet minimum industry air-infiltration standards, Perma-Shield windows allow you to increase the window area without increasing the building's heating and cooling costs.

Low air infiltration is one reason. Andersen's snug-

fitting design is two times more weathertight than industry standards require. The better to keep out drafts and keep in comfort.

Andersen's use of double-pane insulating glass is another reason. It's two times more effective at reducing heat loss conducted through the glass

About commitments to energy conservation: three cheers (relatively speaking) for our team

I sit here in my office this steamy August day—with the temperature at 80 degrees even though I've pulled all the blinds against the southern sun and taken all the old bound volumes off the air register to allow the Federally-regulated degree of air conditioning to reach the room—thinking our industry has really done a remarkable job of responding to the energy crisis. And wondering whether other industries—say the auto industry—couldn't do a bit (a bit? a lot!) more to help.

To my certain knowledge, the energy crisis has been a factor in building design since 1971. RECORD's first Round Table on energy conservation was published in January 1972, and most of the comments at that Round Table sound perfectly up-to-date and applicable today. Way back then, Interior Assistant Secretary Hollis Dole said that "it is abundantly clear that despite our best effort, we are simply not going to be able—short of an all-out effort—to meet our essential minimum energy requirements from domestic resources. . . . There are the strongest of reasons, then, for reducing waste and increasing efficiency in energy consumption whenever and wherever we have the opportunity to do so. . . ."

At that Round Table, the panelists listed many of the tools and techniques that have now become everyday design tools. They discussed the changing cost equations that would be implicit in rising fuel costs (and predicted a sharp rise—though probably no one guessed how sharp it would be). The panelists discussed more efficient building operation, changing cost incentives, lowered comfort standards. And finally, the Round Table predicted, quite accurately, that "since it is already government policy to conserve energy, the government could establish rules or standards governing power use in various areas or for various building types."

My point is this: Since that Round Table, architects and engineers and owners have—both for reasons of voluntary incentives and increasing "rules or standards governing power use"—made extraordinary progress in reducing energy usage in buildings.

No reader needs to be told of the consuming interest of clients and owners these days in reducing operating costs—in new or existing buildings. Rare is the architect or engineer who is not designing today with constant consciousness of siting, of more efficient building envelope, of increasingly efficient lighting and hvac systems, of

daylighting, of passive if not active solar considerations. "Thinking energy" is everyday work not just in the design of new buildings, but the retro-fit of others. At a 1977 Round Table on energy an official of the Public Buildings Service estimated that in many existing buildings it had been able to reduce energy consumption by 30 per cent—"doing the easiest, quicker-payoff things"—and was well into cutting "the next 20 per cent, which will come a lot harder." Energy usage in many private buildings has been reduced 30 per cent—in some cases by retrofitting, in many cases simply by more careful and efficient operation of the buildings. The design of new buildings using at least 30 per cent less fuel and energy than similar "pre-crisis" buildings is common.

Contrast this progress with the weeping and "gosh, we just can't's" from the auto industry. While the government is demanding tough standards for building design, it continues to ask the auto makers, very gently, to do something—anything. Those auto makers must have seen—about the time the building industry saw—that we were in for shortfalls and higher prices for fuel. What did they do? Nothing obvious to the average citizen and faithful newspaper reader. Presented in 1975 with a toothless request to build a 27.5 mpg auto by 1985, their response is still that they just can't—at least without a lot of taxpayer money. I've often wondered why the engineers of those large and highly technical companies, if they cannot design such an automobile, just don't buy a foreign car which has no trouble getting 27.5 mpg and take it apart to see how it works. Indeed—and maybe this is the most telling point of all—we now are exposed to advertising for autos which emphasizes how far "The Stylish New Blimp" will go on a *tankful* of gas. The point is not, of course, that they've done anything about fuel economy (the most recent such ad I saw gave an EPA of 14 mpg in very small type), but that the auto maker has stuffed in a giant gas tank. That seems to me to be just plain cynical—the opposite of a commitment.

We *do* need to conserve energy. I think, in comparison with any other industry, that building industry can stand proud of what it has done. And that the kind of pressures that the Government is putting on the building industry might well be shared more equitably by others.

—Walter F. Wagner Jr.

How Johnson Controls gives Jim Markin

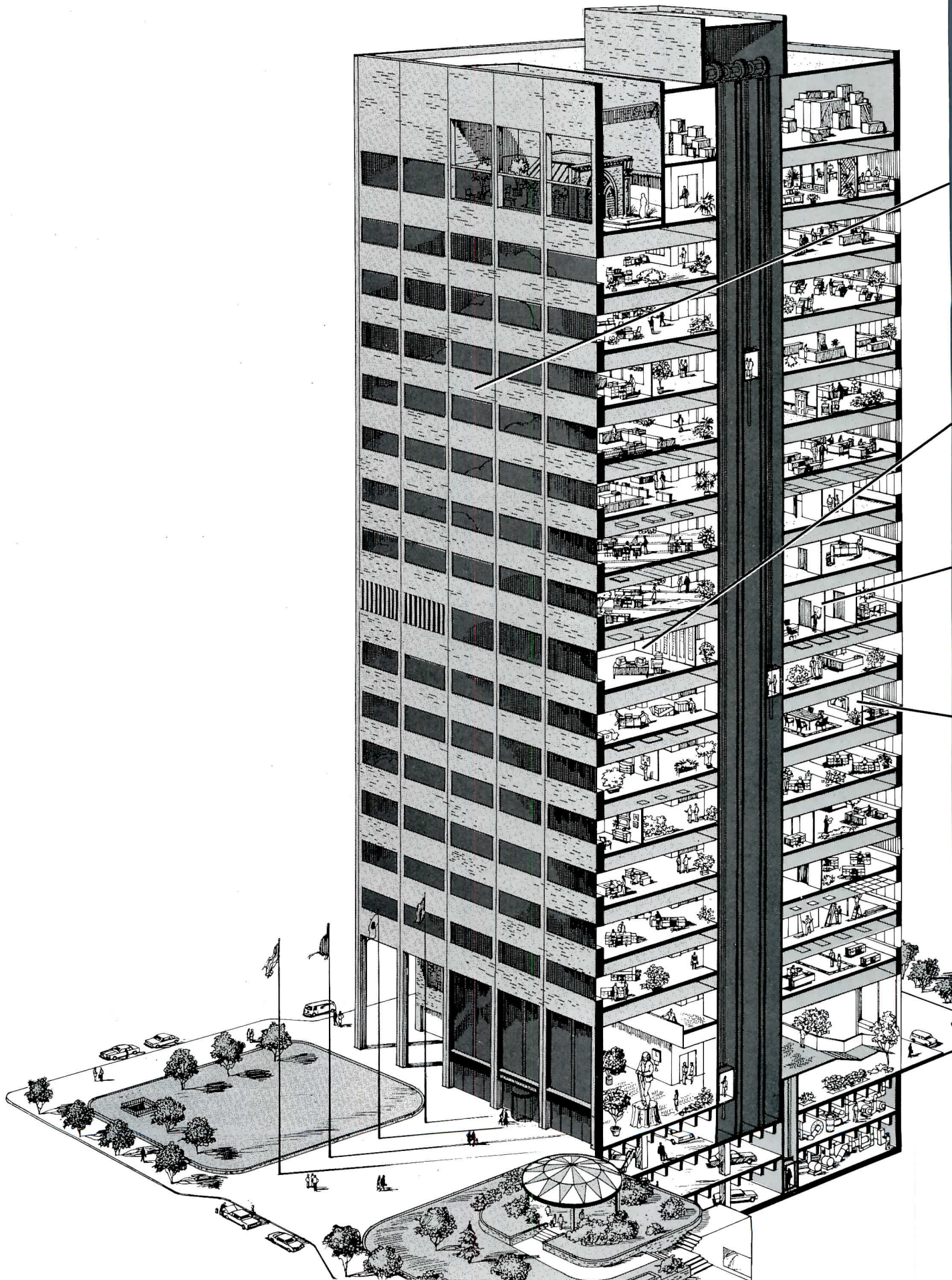

Your single source for design, manufacture, installation and service of automated building controls. Proprietary or time-shared. Energy management, heating, air conditioning, fire management, security and communications. ©1979 Johnson Controls, Inc.

Naval Academy plans athletic center

The \$12 million Physical Education Center to be built at the U.S. Naval Academy will be contemporary in design and energy conservation features, while remaining in scale with the historic buildings of the Annapolis campus. The modern two-story structure with 100,000 square feet of clear space will feature two outdoor heated pools, one for swimming, the other for diving. Plans call for the system to pump the purified pool

water through solar collectors on the roof, while the pools themselves act as heat storage systems. It is estimated that this system could result in a saving of 20,000 gallons of fuel oil a year. Domestic hot water also will be heated by solar energy. Designed by the Eggers Group, the center will also include a wrestling complex, locker rooms, classrooms and offices. Completion is set for the spring of 1981.

—Michele Tuck, *New York*.

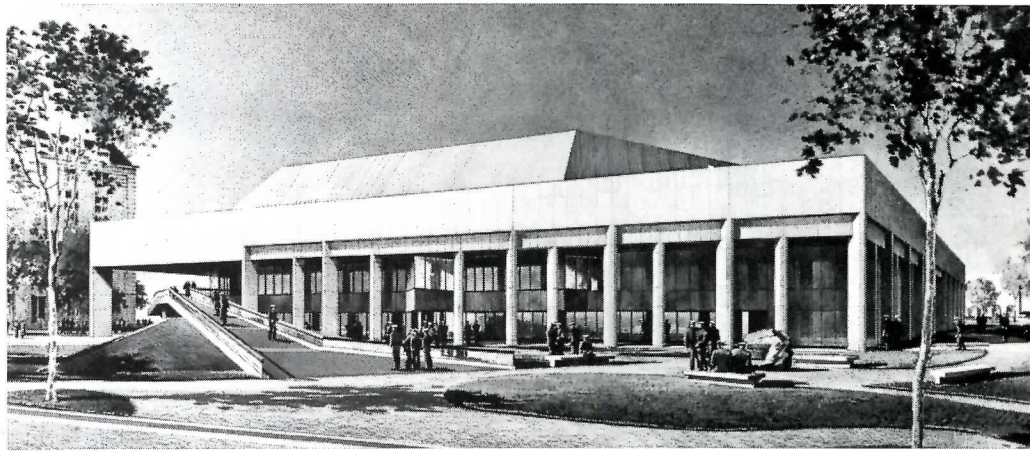

Anshen & Allen design facilities for California research laboratory

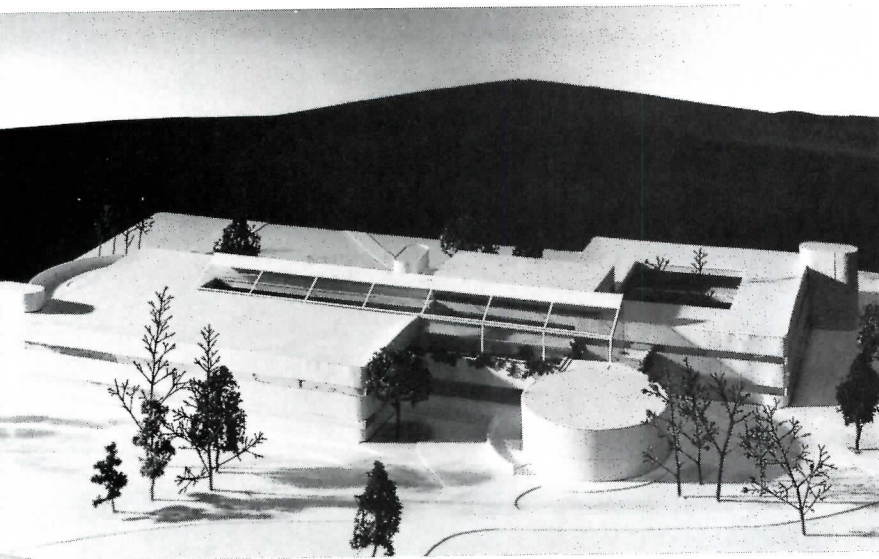

Two buildings in California that are geared to meet special scientific research needs have been designed by San Francisco architects Anshen & Allen for the Lawrence Laboratory in Livermore, operated by the Department of Energy for the University of California. As one of this country's two nuclear weapons design laboratories, now much of its effort is devoted to magnetic and laser fusion energy; biomedical and environmental research; applied energy technology and other research. Both the Magnetic Fusion Energy building and the Core I building will be wood frame (with some steel), with metal

skin and banded with gray-tinted reflective glass. The two-story Magnetic Fusion Energy building will provide offices for the 330 scientists engineers and their support staff. Two wings, offset diagonally, will be linked by the lobby and the data processing and administrative facilities. The lobby, filled with plants, will provide a place for scientific displays and informal conversation. In the west wing, offices and conference rooms on both floors face an open court yard. Centered in the east wing will be a two-story atrium. The conference area, stacks and circulation desk of the library will be set in greenery under a north-facing skylight. Offices and drafting rooms on each floor will have a view of the library-atrium. The controlled-access Core I building, two units bisected by a skylighted and landscaped "street," will house general and administrative support functions for the entire laboratory complex. The "street" is extended at the second floor to form a cylindrical skylighted walkway joining the two sections above their common entrance court. On either side of the entrance court, walls will be curved and extended upward to accommodate the mechanical rooms. Completion of the buildings is scheduled for 1980. —Jenness Keene, *World News, San Francisco*.

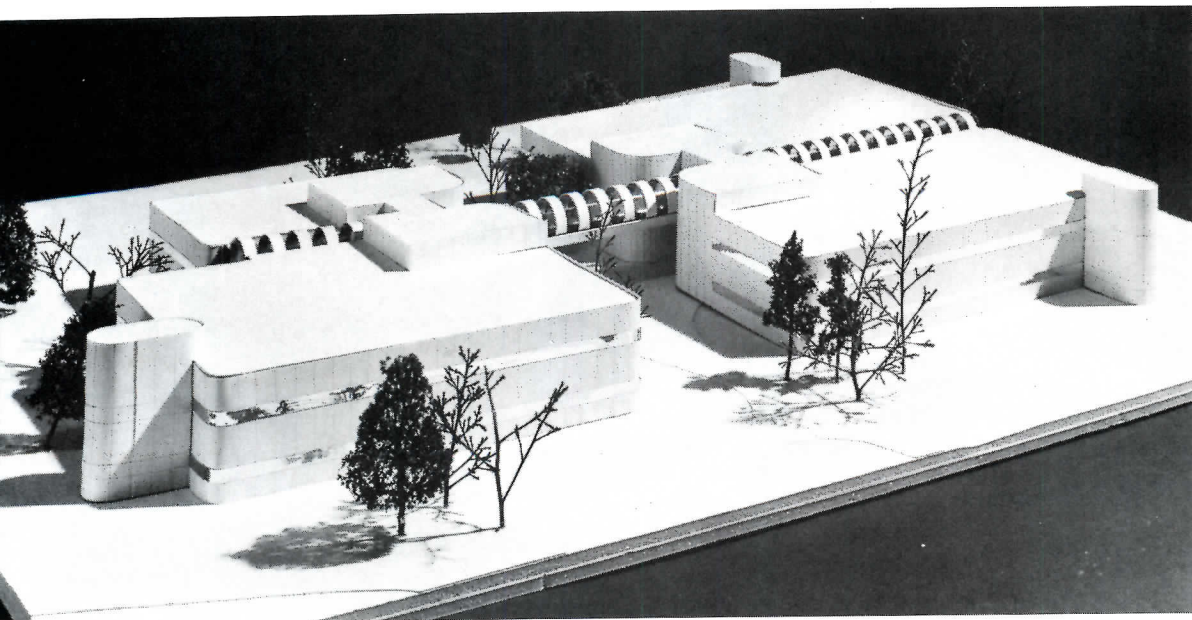



FOUR HEALTHCARE FACILITIES THAT PLANNED FOR FUTURE CHANGE... WITH INTERSTITIAL SPACE DESIGN.

Anyone concerned with the planning and building of healthcare facilities knows that these structures are destined for many changes after completion.

An effective and economical answer to this problem: Interstitial Space Design—a system which incorporates intermediate spaces between working floors.

In these spaces, electrical, mechanical and special service equipment, communications lines and piping and ducts are housed and serviced...allowing the working floors to undergo major changes without interrupting vital services. And maintenance of services need never disrupt normal operation of working floors—a key factor to a hospital which must function around the clock.

Steel for Flexibility and Economy.

Structural steel plays an important part in the concept. Large, column-free, open floor spaces and the long spans necessary to allow major functional changes



Academic Facility for
Rush University at Rush-
Presbyterian-St. Luke's
Medical Center, Chicago, Ill.

Design firm overhead found to be well over twice direct labor costs

One area of great interest to professional service firms is how their overhead expenses compare. This is especially true of firms trying to control their overhead. Unfortunately, little good, comparative data have been published on overhead rates for a number of reasons: 1) every firm seems to keep its books differently; 2) no one (but no one) agrees on common definitions for the various accounting terms; and 3) few adequate surveys have been taken in the past. To fill this information gap, the Professional Services Management Journal (published in Newington, Connecticut) sent a questionnaire to its 1,800 subscriber firms, and received 282 replies or a 16 per cent response. The results of this "Overhead Survey of Professional Services Firms" are summarized in the following report.

The median total staff size of those firms reporting was 60 (average 153) while the median total annual gross revenues was \$1,969,000 (average \$5,199,000); 21 per cent were under 25 persons; 23 per cent fell between 26 and 50 persons; 24 per cent were between 51 and 100; 21 per cent were between 101 and 300; and 11 per cent were over 300.

Thirteen per cent of the firms were architects, 52 per cent consulting engineers, 30 per cent A-E or A-E-P and 5 per cent planners, interior designers, landscape architects or research firms. Fourteen per cent were partnerships and 85 per cent corporations. Ten per cent operated throughout the U.S.; 22 per cent were located in the Northeast, 15 per cent in the South, 27 per cent in the Midwest, 21 per cent in the West, and 4 per cent in Canada.

Not surprisingly, labor is a large share of a design firm's overhead

To keep the questionnaire as simple as possible, PSMJ requested information on only 12 key items. The results were reported as a per cent of Direct Labor (also known as Direct Salary Expense), which is the sum of all gross salaries (before deductions) charged to projects during the most recent fiscal year. It does not include any fringe benefits.

Listed at the right are the mean and median values for each of these 12 items. Due to the large firm skew, PSMJ feels the median values are more representative of the sample.

Revenue for employee was \$30,000; gross multiplier was 2.9

PSMJ also computed the following items:

1) *Revenue per employee*: annual net revenues (not including outside project-related costs such as consultants) divided by total staff (including nontechnical). Median was \$29,231 while mean was \$30,007.

2) *Gross multiplier*: annual gross revenues (including all income) divided by direct labor.

Median was 2.90 while mean was 3.03.

3) *Net Multiplier*: annual net revenues (see item 1 above) divided by direct labor. Median was 2.60 while mean was 2.65.

4) *Marketing per cent*: total marketing cost as a per cent of gross annual revenues. Median was 3.9 per cent while mean was 4.6.

After comparing your own overhead costs with these figures, you will probably want to reduce or at least control some of your overhead expenses. Here are some suggestions:

Charge all legitimate project-related costs to the project. This will reduce overhead expenses, increase the direct labor and thus reduce the overhead rate.

Limit the payroll not charged to projects. Keep workload in balance with staff level; avoid adding non-technical staff; consider using outside consultants for certain exotic specialties that are now in-house.

Use innovative schemes to keep control over fringe benefits.

Avoid the temptation to have the fanciest office or equipment.

Ask the staff what cost-cutting measures to take.

Michael Hough, publisher of PSMJ, noted with surprise that a large number of respondents to the survey had a poor knowledge of their overhead costs. For example, they did not know their indirect (non-project) labor, meaning that they are not controlling their utilization rate. Also, many firms apparently do not know what their total marketing costs are, because they are not requiring proper time allocation by principals.

Mr. Hough recommends firms in this position start recording overhead correctly as the first step to controlling it, and to help, he recommends two publications: ACEC's "Uniform Cost Accounting Manual," or AIA's "Standardized Accounting for Architects."

A copy of the complete 1979 PSMJ overhead survey is available for \$15 by contacting: PSMJ, P.O. Box 11316, Newington, Connecticut 06111.

	Mean*	Median*
Salary overhead (1)	39.4%	33.1%
G & A overhead (2)	89.6	88.0
Total overhead	129.0	125.5
U.S. Govt. unallow. (3)	8.8	6.1
Bonus/incentive (4)	8.6	5.6
Pension, etc. (5)	6.7	5.0
Indirect labor (6)	42.2	39.0
Marketing costs (7)	14.2	11.8
Occupancy (8)	11.8	10.4
Telephone (9)	3.7	3.0
Liability insurance (10)	5.3	4.5
Interest (11)	2.4	1.0

* as per cent of Direct Labor

Definitions:

1) *Salary overhead* includes the legal and customary fringe benefits such as social security, sick leave, vacations, and bonuses, etc.

2) *G & A overhead* relates to administering the firms and includes payroll not charged to projects, rent, marketing, etc.

3) *U.S. Government unallowable overhead* is the portion that Federal agencies do not allow to be charged to them.

4) *Bonus/incentive pay* are cash payments made to employees.

5) *Pension/retirement/profit-sharing* are payments made into a deferred retirement plan.

6) *Indirect labor* is the salary cost of all employees for all time not charged to projects (direct labor plus indirect labor equals total annual salary cost).

7) *Marketing costs* comprise all salary (principals included) plus expenses for all marketing efforts (general plus project-related).

8) *Occupancy* includes rent, utilities and maintenance (substitute equivalent expenses for firms that own their own building).

9) *Telephone* includes basic service plus non-reimbursable toll calls.

10) *Liability insurance* is the premium paid for professional liability insurance.

11) *Interest* is the amount paid on borrowed capital.



Otis elevonics* brings
you new dimensions in
elevator systems

The Otis® LR-MR-HR elevator systems for low-, mid- and high-rise buildings represent an advancement in elevator technology created through the application of elevonics engineering. Whisper-quiet door operators, thoughtful engineering for the handicapped and new electronic and hydraulic controls are some of the new developments.

Typical of Otis research is our COMPUT-O-CHEK™ diagnostic system that brings computer speed and accuracy to elevator maintenance. There are also several modernization packages designed

to bring older elevators up to today's standards.

In the future there is the potential of more energy-efficient elevators and escalators, compact computer control systems...we're even working on a replacement for copper wires. Elevonics...the key to new and better elevator systems from Otis.

*Elevonics is the science of moving people and products through the use of advanced elevator and microelectronic technology.

OTIS ELEVATOR COMPANY

Subsidiary of



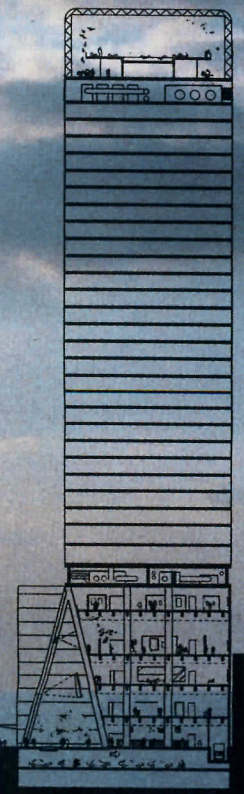
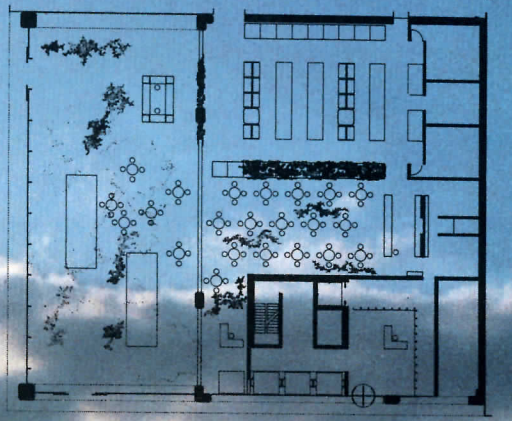
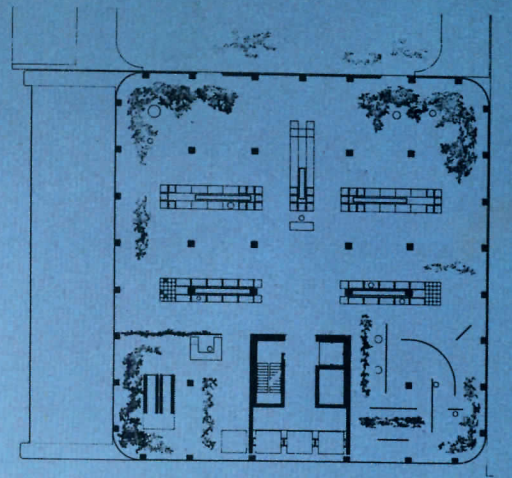
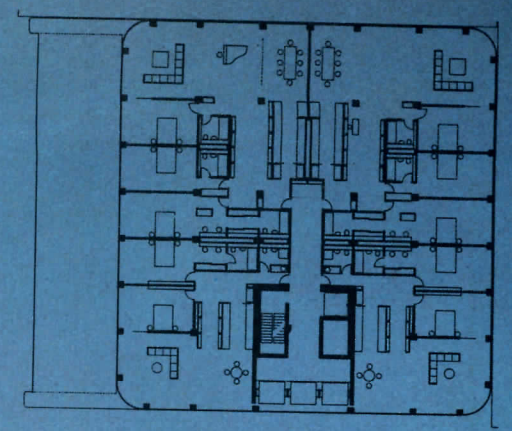
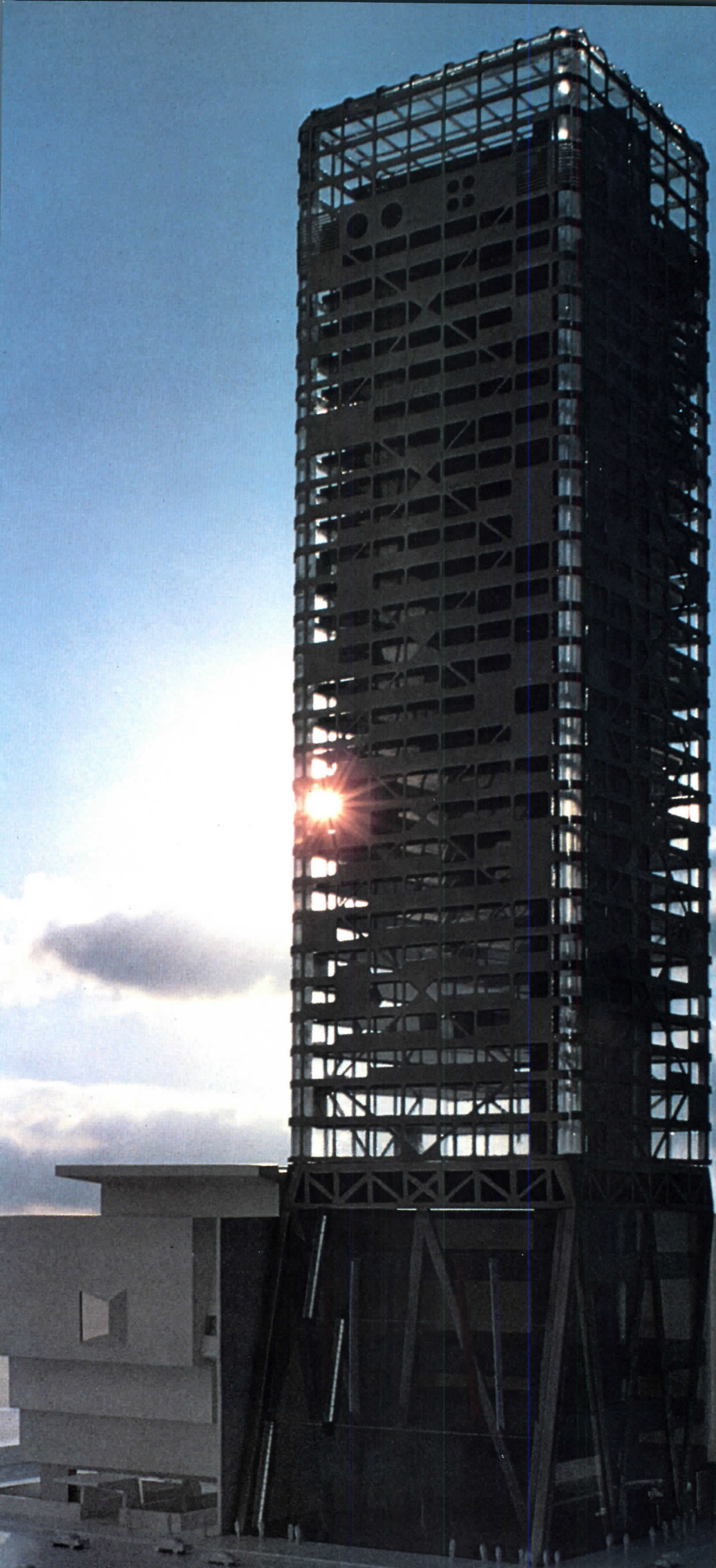

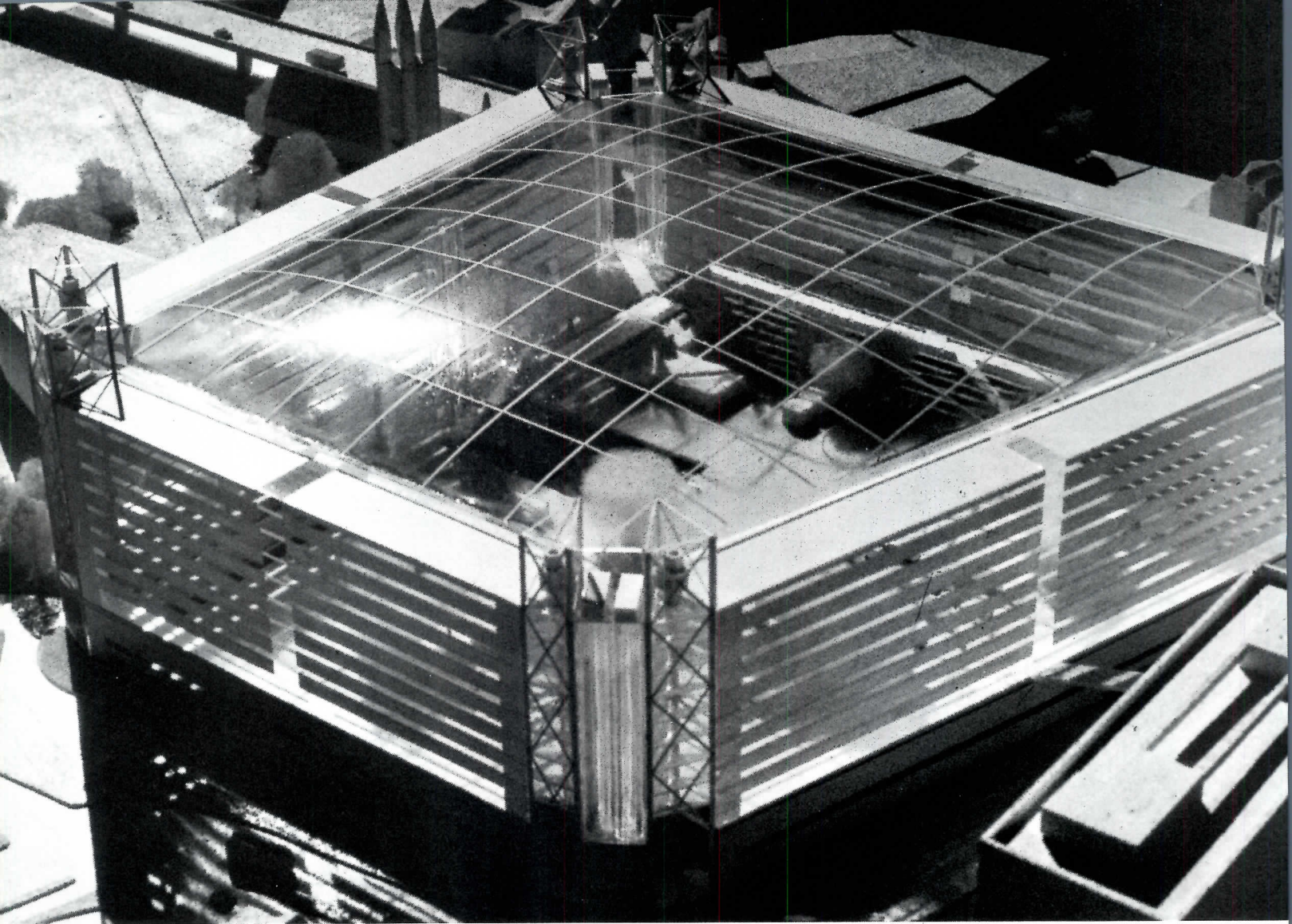

2 A FOUR-ACRE FABRIC ROOF COVERS "PARK" AT HAMMERSMITH

Hammersmith is a borough of London that lies between the West End and Heathrow airport. Near its center, on a six-acre site above a major transit interchange for Underground, buses and cars, the London Transport Executive proposes a complex for mass transit, a bus maintenance facility, parking garages, 500,000 sq ft of offices, retail space and recreation.

Foster Associates designed long narrow office buildings to bound the entire site and to encircle a raised open podium covered by a 4-acre fabric roof. At each corner, paired triangular towers will support roof cables. Their openness will reveal ducts and reception areas at each level in the towers.

HAMMERSMITH CENTRE, London. Client: *London Transport Executive*. Architects: *Foster Associates—Loren Butt, Roy Fleetwood, Spencer de Grey, Birkin Haward, Norman and Wendy Foster, David Morley, Celia Maxwell, David Nelson, Ken Shuttleworth*. Consultants: *Ove Arup & Partners (structural); Geiger Berger—Horst Berger (large-span roofing possibilities); David Belfield and Everest (quantity surveyors)*.

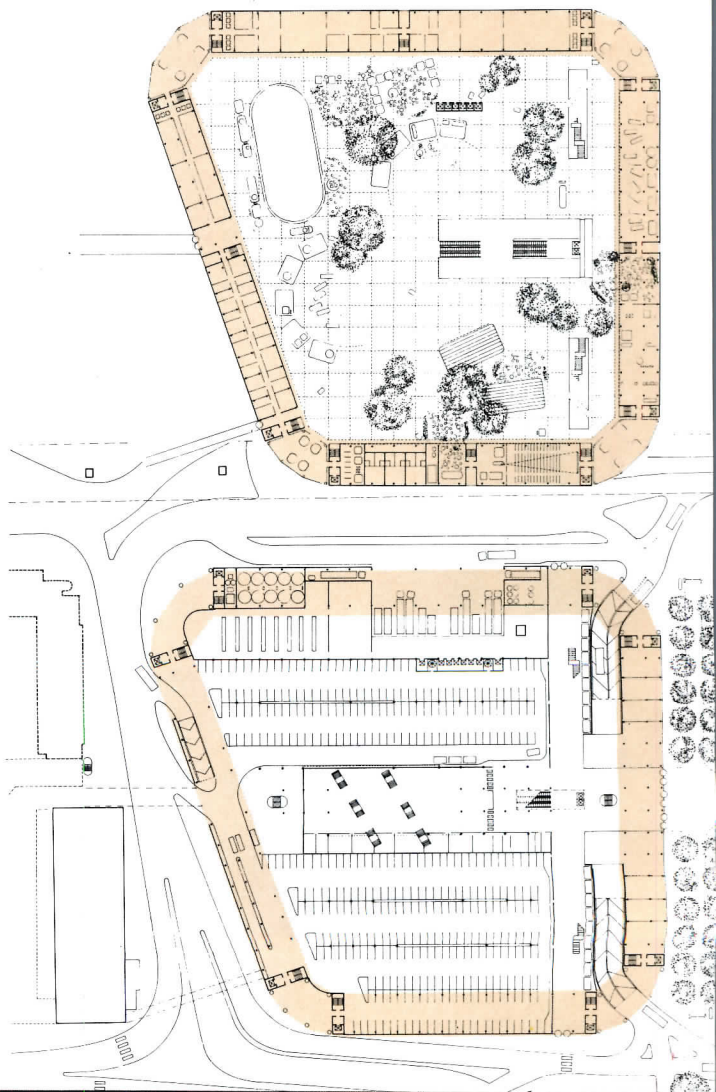

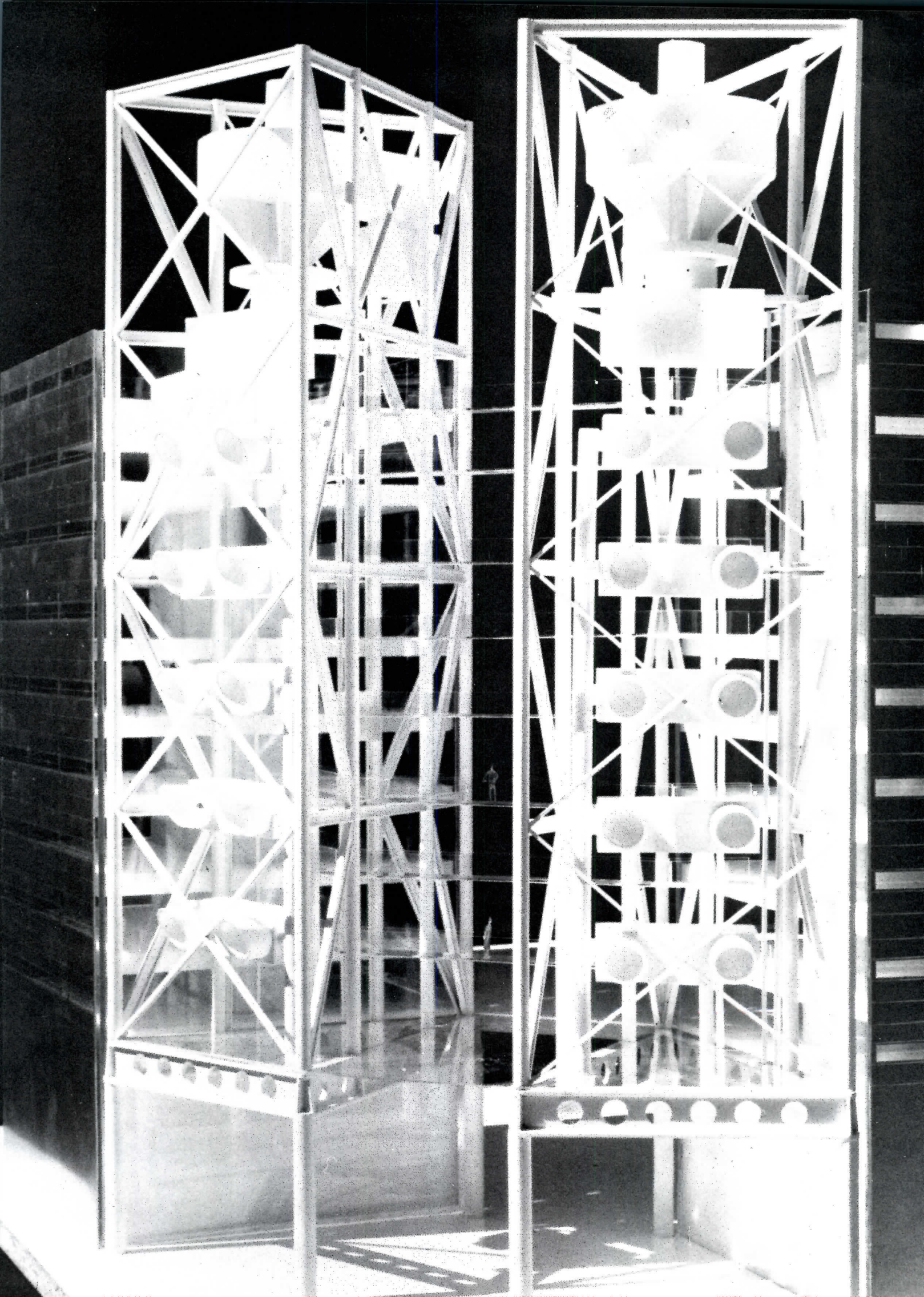

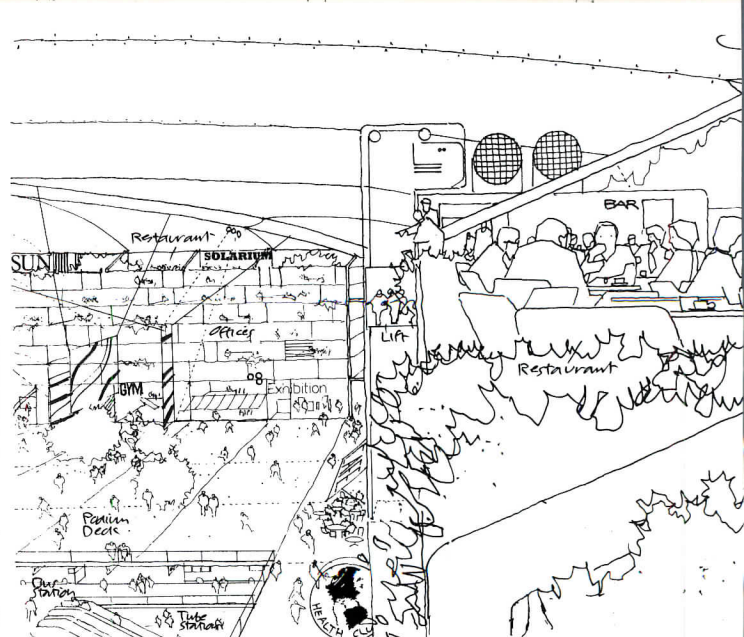
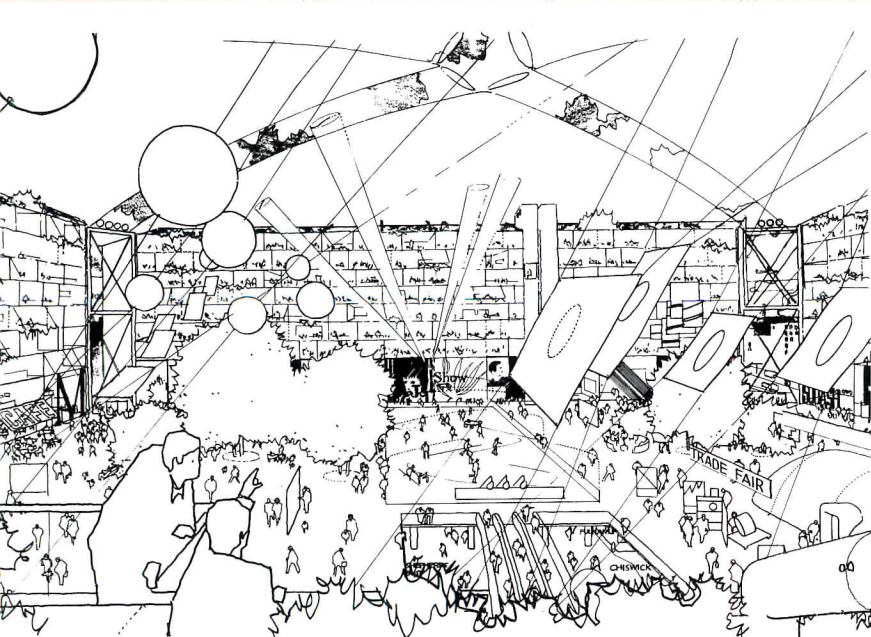
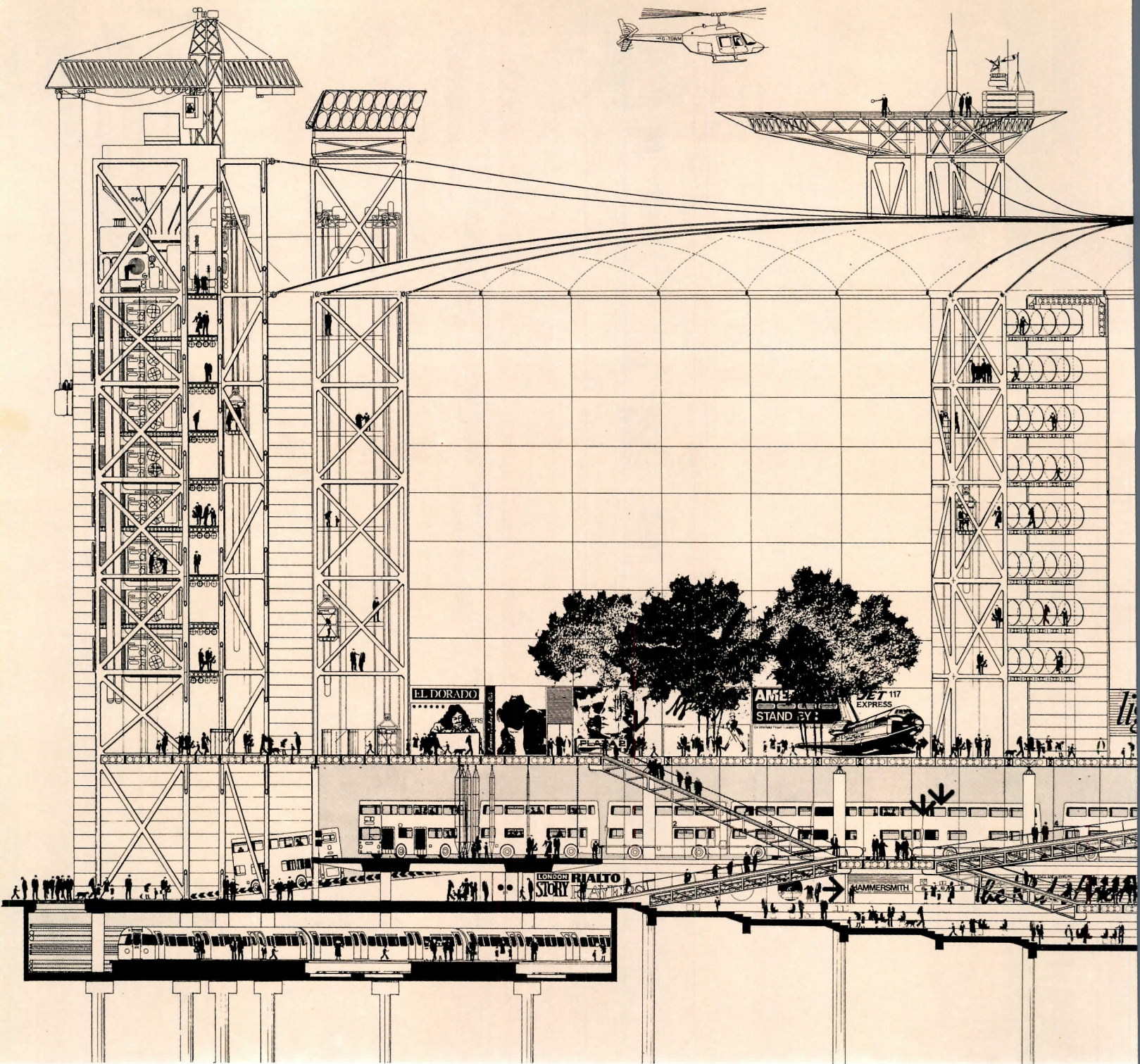

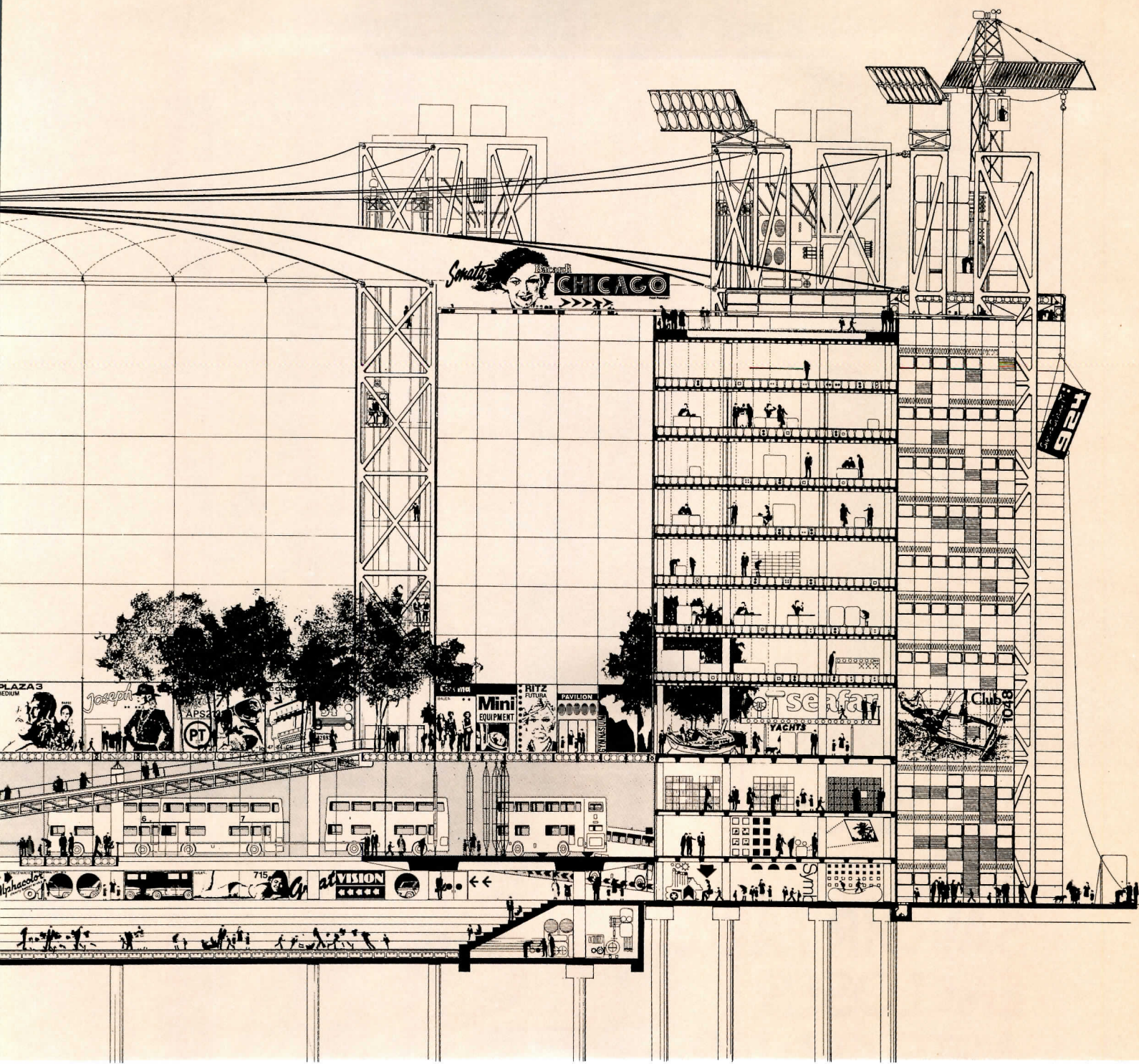

Hammersmith Centre will provide a covered park, with ice rink, as well as open pedestrian circulation for office workers. Parking will be at ground level, the bus concourse 36 ft above it, and the towers will act as portals for both. Foster's reasons for roofing the complex embrace both the social and the environmental. The community will gain all-day, all-weather cultural space. And the reduction of exposed perimeter wall and installation of unitary heat pumps will cut fuel use and prepare the building for the 21st century and costly energy. The architects conducted comparative seasonal studies for solar heat and light gain in both roofed and unroofed spaces (right).

Foster Associates' drawings teem with detail—mechanical

contrivances and furiously industrious people—both at

Hammersmith and in the test rig house on pages 64-65.

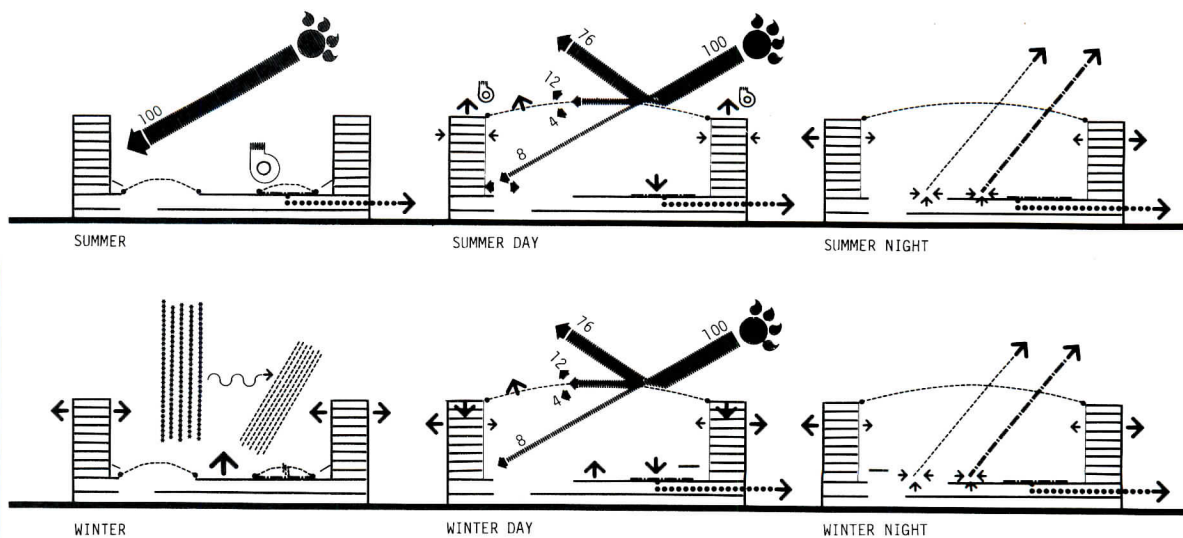



3

METAL SHED WITH SAVOIR FAIRE ENCLOSES ARTS CENTER

Sainsbury Centre makes real the Modernist fantasy of industrialized construction that has haunted architecture for more than a century now. It has also elicited more controversy—and more words—than any other building in recent memory.

Technical polish is no new feat for Foster Associates, though at Norwich they have brought it off with even greater authority than usual. But the building coincides with an anti-Modernist rejection of industrialization, and conceivably criticisms of internal environment and circulation also reflect the architect's dilemma in serving two masters—the Sainsburys as clients/collectors/donors, and the University of East Anglia as user/educator/owner. (The Sainsburys' gift includes their collection of modern and ethnic art, plus a gallery for public display and scholarly study, school facilities, and a restaurant.

Whatever the philosophical merits and passions on either side, however, the plain fact is that Sainsbury's technical finish is superb, and the building's vast open interior and lambent natural lighting are, in the word of one critic, "seductive."

The Sainsburys' first wish for the gallery was that it be accessible to all students, as well as to the public, and that exhibits be "domestic" in scale. Beyond that, they wanted the display space flexible for change and growth, and preferred natural top lighting. The main gallery, located near the

middle of the long open-ended "shed," is divided by low screens to foster an intimate scale and guide circulation. Daylight enters through glazed panels in the roof system; louvers in the interior skin may be automatically "tuned" according to the quality of natural light.



Robert E. Fischer

SAINSBURY CENTRE, University of East Anglia, England. Clients: *Sir Robert and Lady Sainsbury*. Architects: *Foster Associates—Arthur Branthwaite, Loren Butt, Chubby Chhabra, Michael Elkan, Roy Fleetwood, Norman and Wendy Foster, Birkin Haward, Richard Horden, Caroline Lwin, David Nelson, John Yates*. Consultants: *Anthony Hunt Associates (structural); Tony Pritchard (cladding); George Sexton (display lighting); Claude Engle (natural and electric lighting)*.



Ken Kirkwood

Structure, a welded steel "prismatic" truss, provides unencumbered space 25-ft high, 110-ft wide and more than 400-ft long. The same exterior panels enclose both walls and roof, and movable louvers line the interior. The 8-ft space between the two systems contains both structure and heating and ventilating (the building is not air-conditioned).

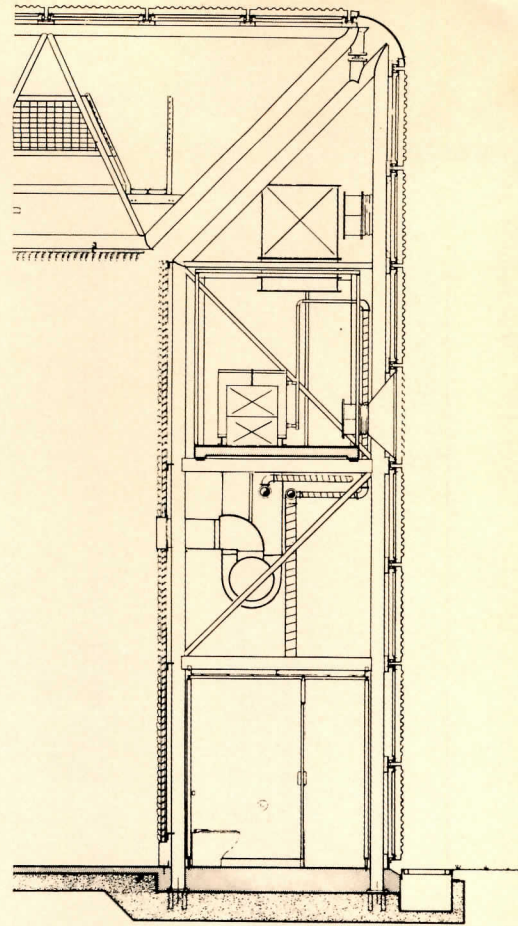

Systems drawings: Jan Kaplisky

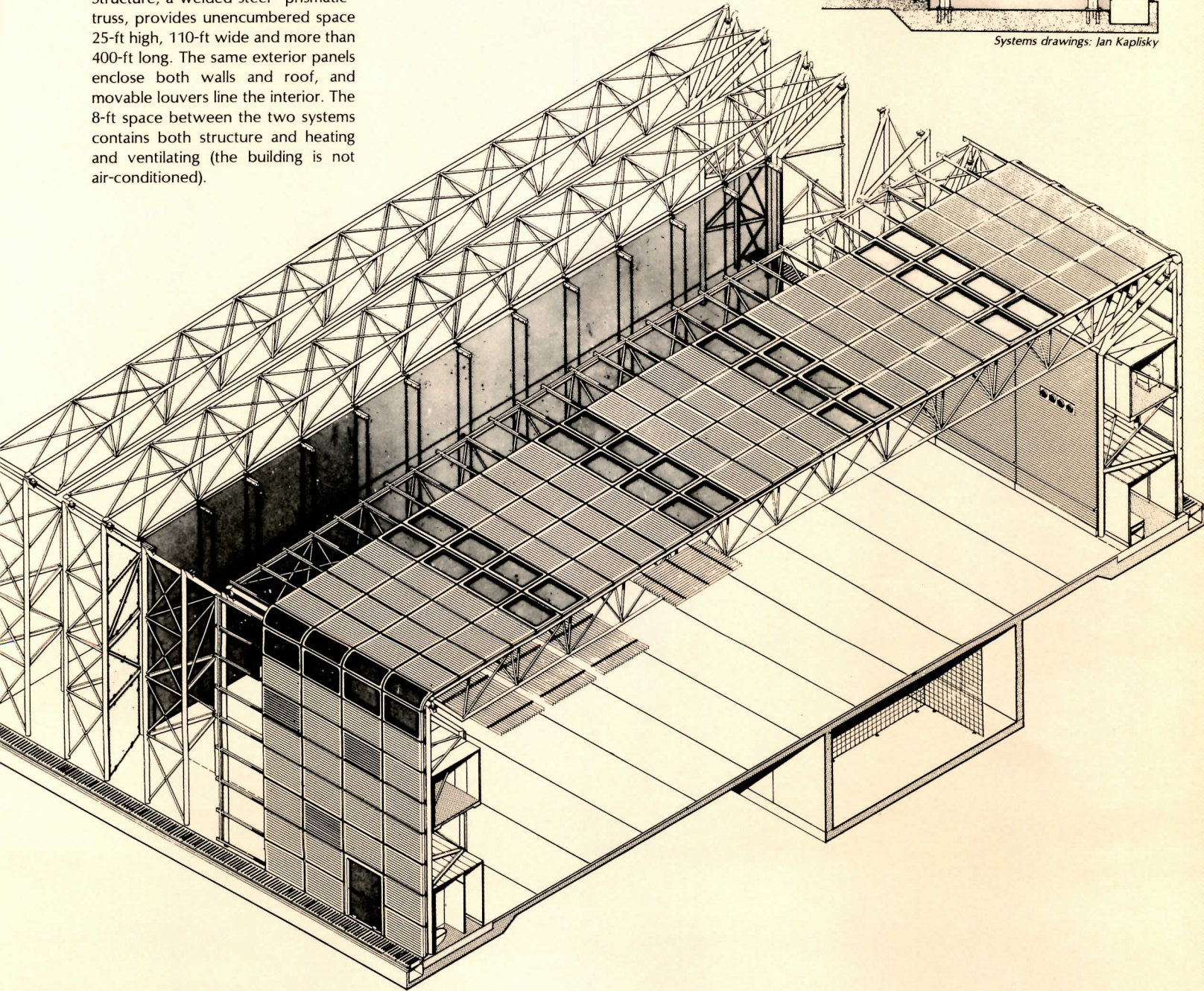

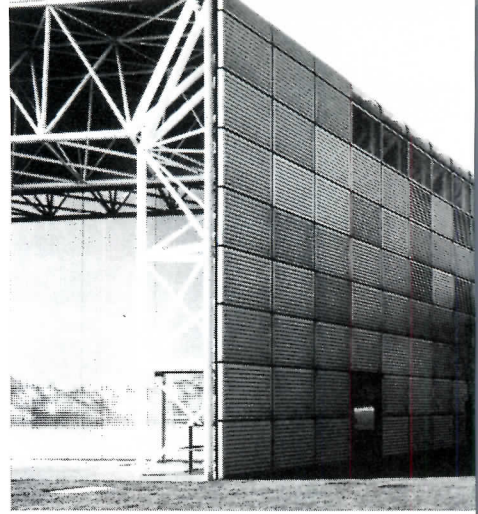
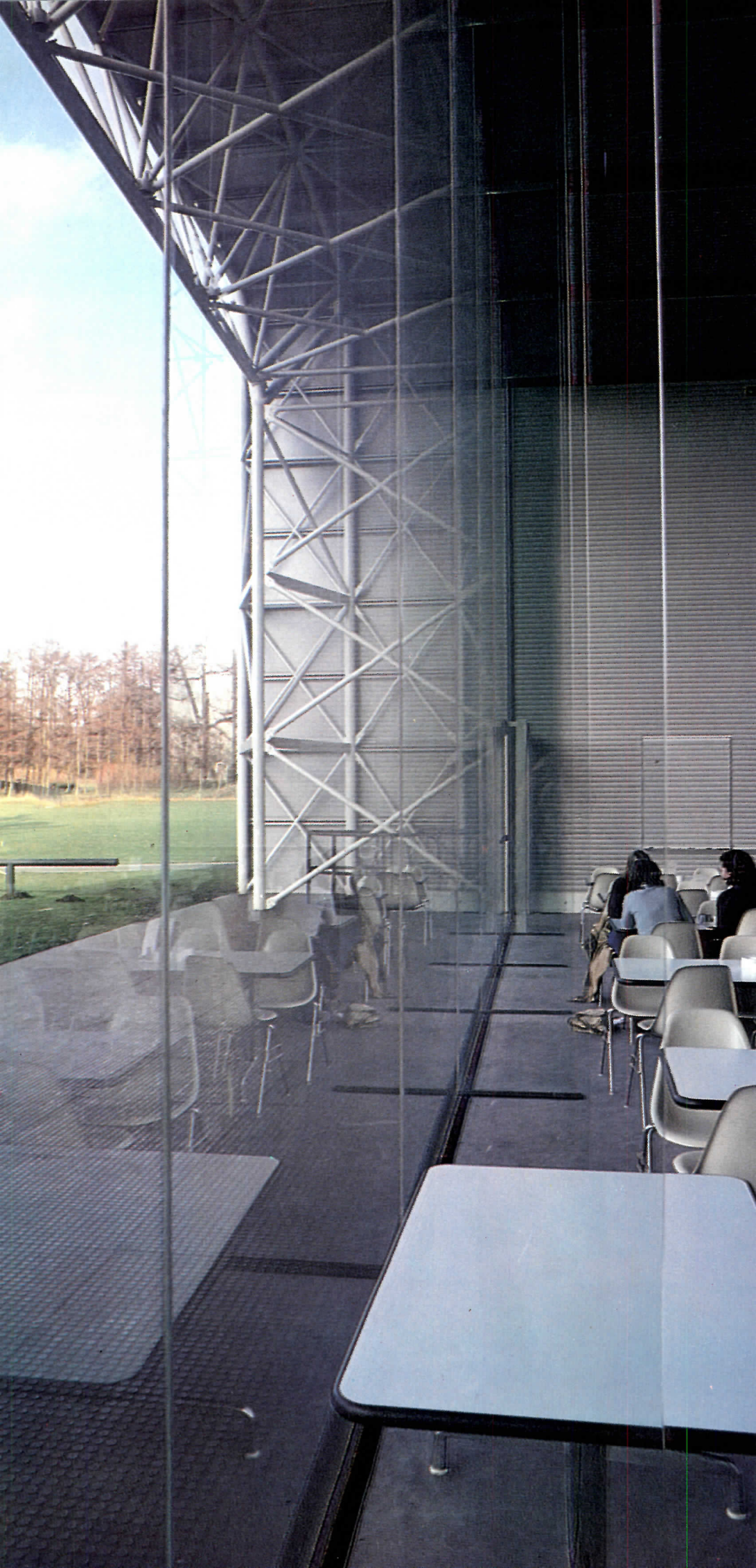

At the end walls of the tube-like Sainsbury building, Foster Associates have exposed the steel space truss and inserted a large expanse of butt-glazed window sunk into a low sill flush with the outdoor terrace (detail below). The windows open up views to the surrounding Norfolk countryside on the university campus—a lake at one end and woods at the other.

The panelization system, enclosing the roof as well as the side walls, offers three basic panel types: solid, grille and glass. As necessary variations, curved panels of all three types turn the corner between wall and roof.

The highly reflective solid panels have an insulating core with an outer skin molded of "superplastic" aluminum, an

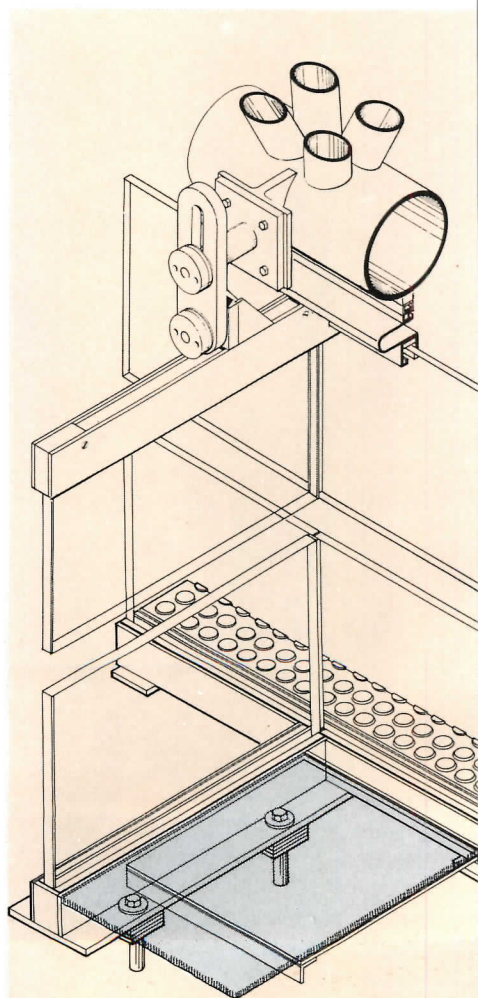

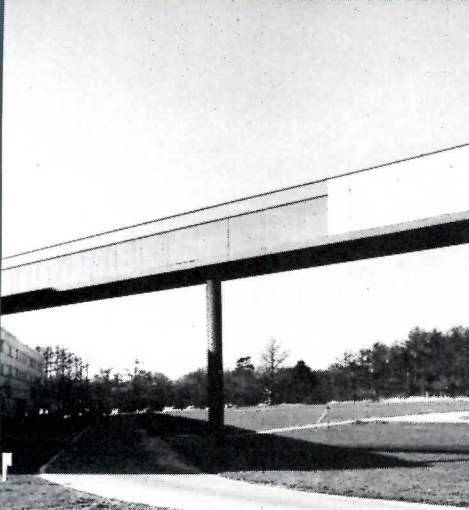

Robert E. Fischer

alloy that can, at a given temperature, be stretched and molded to very fine tolerances. The material has generally found industrial application for parts in aircraft, automobiles and computers.

All panels are sealed with a single web of neoprene gasketing. Sections of the web were delivered to the site (top right) and joints were vulcanized in the field (inset below). Gaskets double as drains.

Each panel requires only six bolts for installation, and the architects say that workmen can change a component in five minutes (bottom right).

A long elevated pedestrian bridge (top) connects other university buildings to the new center, piercing the side wall and leading to a spiral stairway in the special exhibition area.

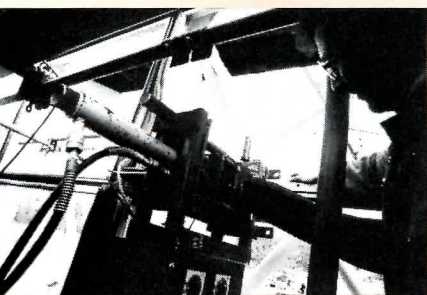
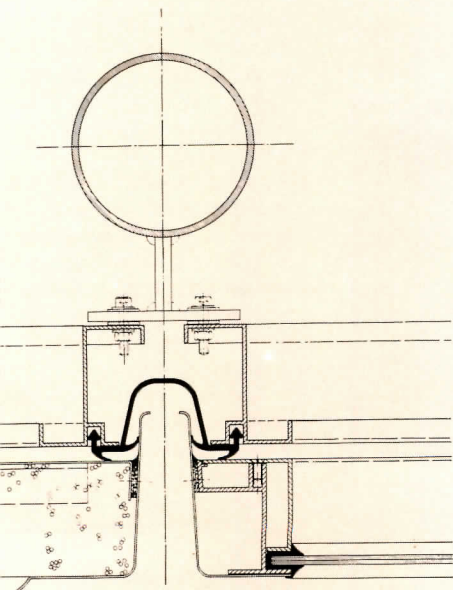
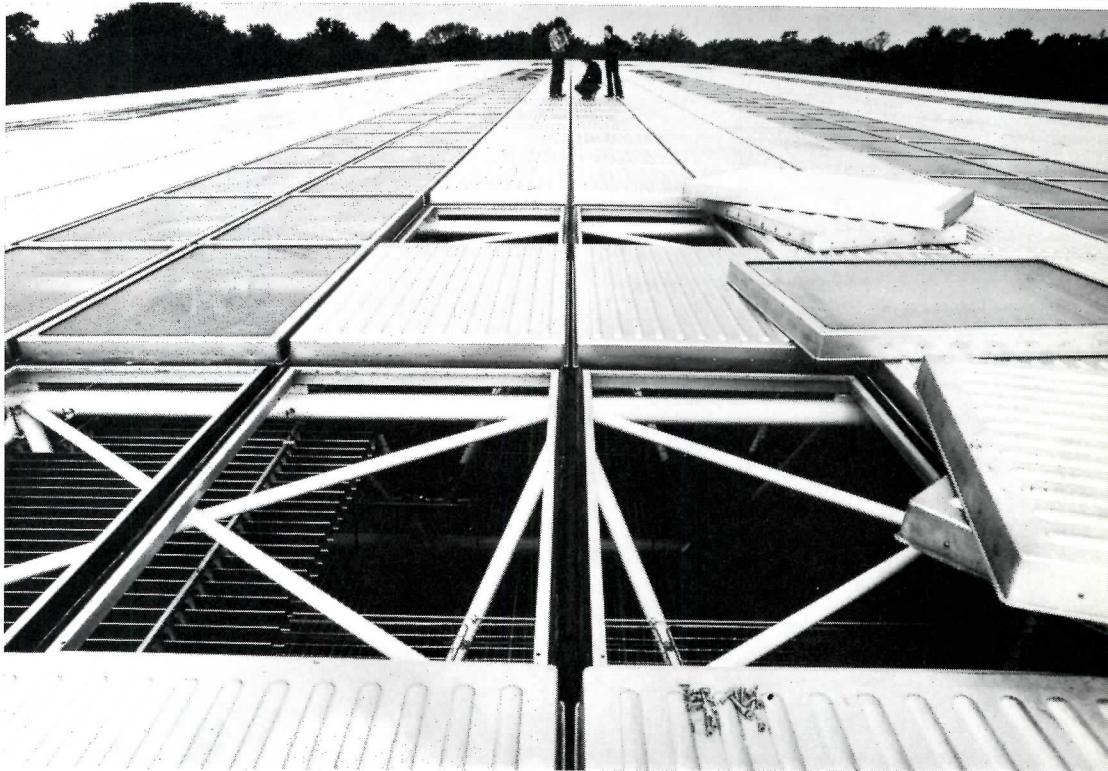

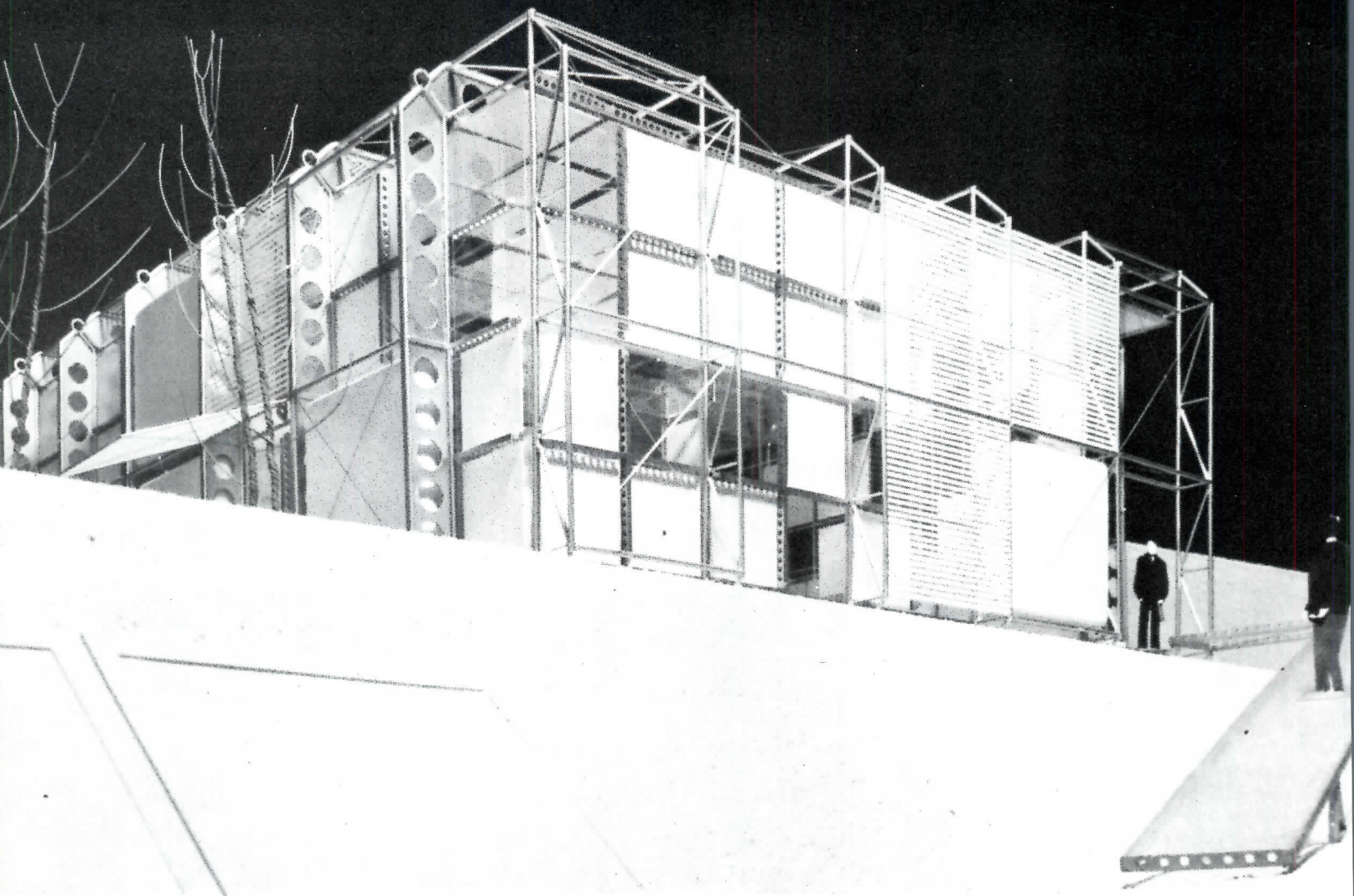

4 "TEST RIG" HOUSE RE-EXPLORES PANELIZATION, ENERGY USE

Like all adventurous architects who tend to push their powers of design, Norman Foster sees residential architecture as a chance to experiment, to get a little extra distance with the push. Hence he calls this house a "test rig."

The house demonstrates a number of Foster's abiding architectural concerns: panelization; interchangeability, not only to accommodate evolving functions but also to allow replacements as improved products become available (or as Foster designs them); and energy use and internal environment.

The structure, a 4- by 4-ft grid, will admit any number of interior and exterior panels that can be "clipped, zipped or bolted on." For enclosure, these include solid, translucent and transparent panels for walls and roof, as well as louvers, insulating panels, lighting, services and solar collectors.

HOUSE/TEST RIG, England. Architects: *Foster Associates—Peter Busby, Norman and Wendy Foster, Richard Horden, Tony Pritchard*. Engineer: *Anthony Hunt (structural)*.



The primary structure of the test rig house is an aluminum frame pinned at the base and at the juncture of beam and column. Members will be built of 1/4-in. perforated aluminum plates riveted to oval aluminum sections at top and bottom. At the end walls, a secondary structure of round and oval aluminum pipes will provide wind bracing. The secondary structure, in addition to accepting screens and louvered panels, can also support "pods" for such purposes as plumbing.

Unitary heat pumps will provide heating and cooling, even though natural gas will for some time be the least expensive energy source in the United Kingdom. But Foster feels strongly that "by applying appropriate techniques for the long-term future, designers can to some degree act as catalysts for research."

Apart from housing services, the space below the raised floor will form a pressurized void for the distribution of warm or cool air. Movable panels for registers will make it possible to "tune" air distribution as experience with the house dictates.

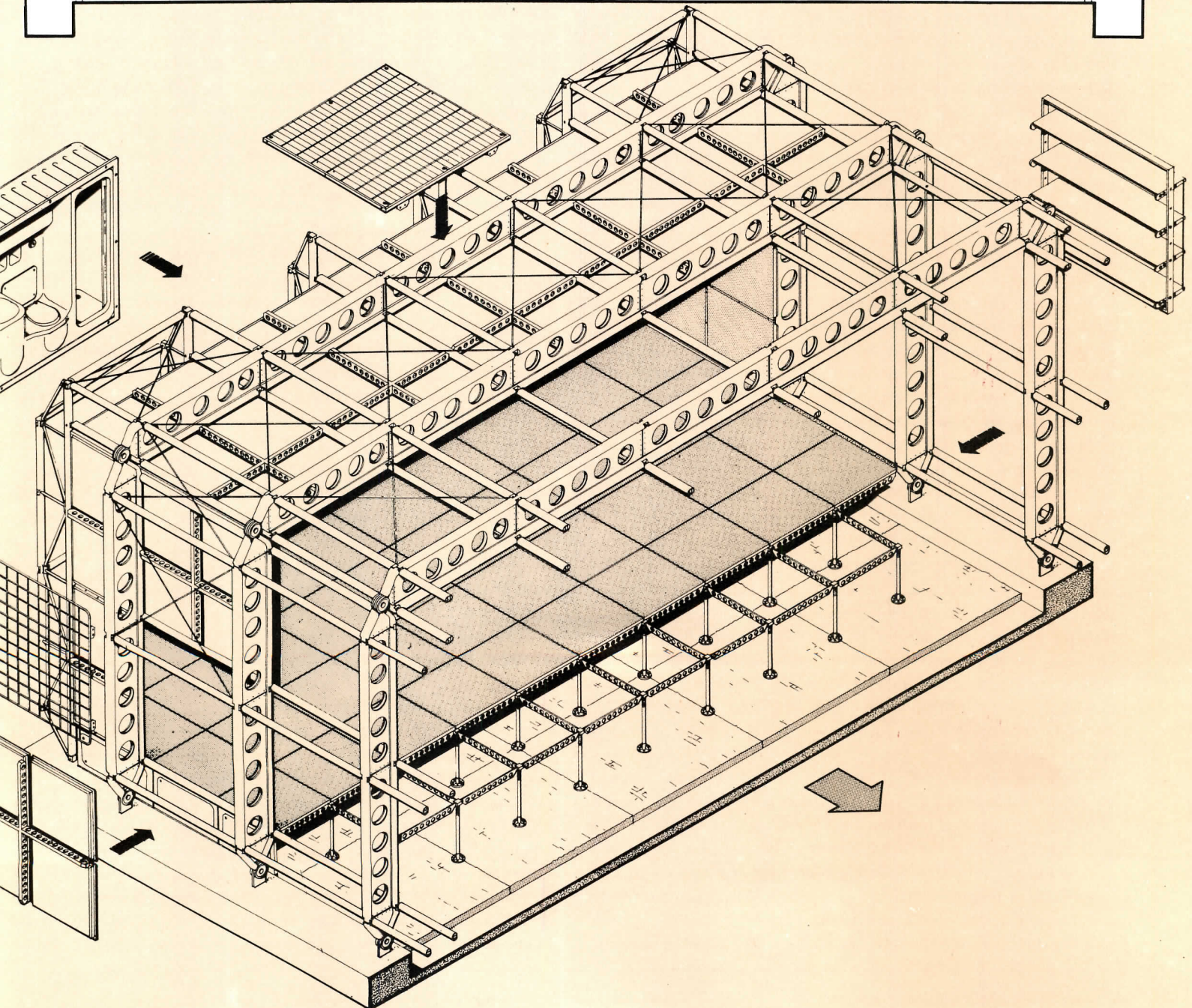
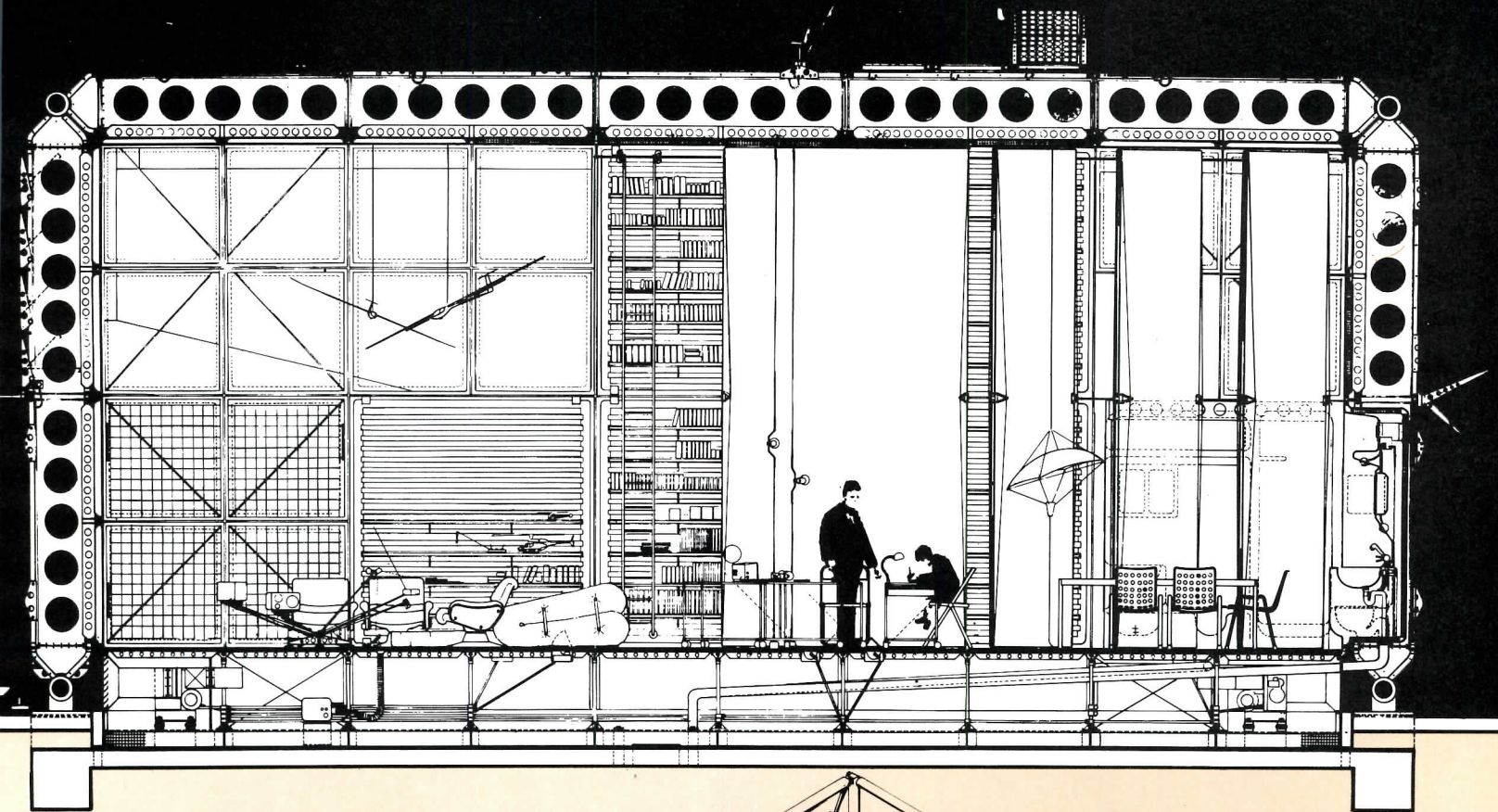

C ONVERSATION: CESAR PELLI ON ARCHITECTURAL TECHNOLOGY

Technology is only one element that architecture deals with, and it's inescapable. Buildings have to be built *with* something, and building technology is simply the way in which materials are used and labor is organized.

The point comes—and this is where it starts to get interesting to me—where we can consider the relationship between design intention and the reality of building. It is my contention that in any healthy architecture these two things cannot be far apart.

One of the basic tenets of the Modern Movement was that whatever you designed had to be closely related to the way it was made. Even more than that—you had to make a point of it. But at present, there are many architects, many very capable architects, who in reaction to the Modern Movement are interested in aspects of design not necessarily related to the way buildings are built. And this creates a disjunction.

In a sense, this is a disjunction with history. Up until the 19th century, the possibilities of construction technique changed very little from century to century. The Renaissance architect could pick up what the Romans designed and not do it very differently, because many things remained unchanged. In the Mediterranean basin, stone was the primary building material. The forms and the esthetic systems grew from stone technology—arches, keystones, capitals, columns, architraves. In a technological sense, you might even consider Renaissance architecture an outgrowth of Classical architecture.

And the labor systems did not change radically until the 19th century. Up into modern times, you could pick up a historical tradition and be technologically consistent. But now stone construction has for all practical purposes disappeared. A few buildings will still be built in stone—stone is beautiful, eh? And you might use it cleverly as cladding. But for its full use, it requires a particular condition—highly skilled labor, very cheap, very abundant. (Interestingly, stone construction revived during the Depression. Those Yale buildings across the street were built then.) This condition has totally disappeared, and our labor unions will make sure that it does not appear ever again.

So when we try today to develop an architectural vocabulary based on stone tradition, we face a problem. There is a cleavage between the historical tradition and technology. And then technology becomes an issue, a difficult and intractable issue.

At the same time, some architects in the Modern tradition are looking for a technology that will symbolically *appear* progressive and *modern*, a *symbol of a new* architecture for a new era. But there is really no "high technology" in architecture. High technology is

what scientists use to send Voyager and Mariner out into space.

In architecture, we have nothing but an *expression* of high technology, the use of things that are slick and simple, purely an esthetical intention. Which is fine, perfectly fine. Artistic expression normally comes of pushing something to its limit. (You should remember that when I am doing architecture I might be more traditional *and* more extreme than I am when thinking about it. The process of observation is different from the process of doing.)

As you can see, neither of these two ideological positions is pragmatic. Neither of them deals with the reality of getting buildings built. They are both idealized tendencies that have been fighting each other.

I personally feel that the only safe ground is the middle ground. And that there's nobody touching it.

One has to make architecture with the things that are available—with the technology that is available, with the social system that is available, with the economics that is available. That's the only healthy architecture.

I don't mean that's the only architecture, but by "healthy" I do mean that's the only architecture that allows the development of forms that can be carried on by other architects and that other generations can develop and transform. They can keep on relating to what's really there.

All this means that you don't need to make an architecture that represents the past (especially if you don't have stone). And you don't need to make an architecture that represents the future (there is no high tech in architecture).

I think that architecture should represent today, should deal with the technology of today—and the technology of today is industrialized.

But not all *that* industrialized.

Some architects are working at the edge, pushing. Some may be pushing for the maximum recollection of history, some for the maximum expression of industrialized materials. But these efforts are really at the edge, not at the center of the road.

Now, you are at the center of the road if you do, let's say, a house, where the most developed technology is wood-frame construction. That's the most economical, the most available, the most developed, and the one that will allow you to do the most. In New England, you would use clapboards or shingles, in Southern California chicken wire and stucco. Those would be the most appropriate technologies, and you will get the best results for the least money. This is what labor knows how to do. This is what we interpret as a house today, and what future buyers will want from a

IN A TAPED INTERVIEW WITH CESAR PELLI, ARCHITECT AND DEAN OF THE SCHOOL OF ARCHITECTURE AT YALE UNIVERSITY, RECORD EDITORS FOUND THAT DEAN PELLI'S REFLEC-

TIONS HAVE CARRIED HIM WELL BEYOND MERE TECHNOCRACY TO A CONSIDERATION OF THE TRUE ELEMENTS OF TECHNOLOGY AND ITS UNBREAKABLE BONDS WITH ARCHITECTURE.

house. And it will be more adaptable to additions and alterations.

And if you are doing a high-rise office building, you really cannot talk of anything except concrete or steel structure, and some sort of enclosure that would not be structure, probably a curtain wall. How you use this for an artistic expression is another issue.

Right now we are dealing with several coexisting artistic systems. Esthetic systems tend to get defined, and architects establish their own standards within them—what's good, what's bad, what's better than the other. But once you use that yardstick to measure another esthetic system, you will find, by definition, that all the good architects are really dreadful, because they don't measure up at all. For example, you cannot judge the architecture of a Norman Foster or a Michael Graves at the same time with the same yardstick. One or the other will appear to be a bad architect.

I am omniverous and like to try as many things as I can. At this moment, I am perhaps readier than others to talk about the different esthetic systems. It helps that the systems depend on different intentions. You can do architecture that depends on a system of proportions, or on a relationship to human beings, or historical traditions. And with any of these, you can end up with a work of art.

Different groups of people react to the same things with different but equal enthusiasm, because they really respond to different parts. As in the theater—we may prefer tragedy or comedy, we may like musical comedy or opera or ballet. In architecture, similarly different possibilities coexist.

Architectural beauty may in some cases depend on the correct interpretation of a literate public. This would be true for instance of the work of Robert Venturi.

Nor does architectural beauty depend only on proportions or placement. A long stretched wall, for instance, has great beauty. The Crystal Palace did not depend on the correct proportions of its doors or its relationship to historical elements. It depended on immensity, on its sheer vigor, on newness, on the extraordinary highlight running across the top. That building could have been a few hundred feet longer and it would have made no difference.

And at the Pacific Design Center the beauty likewise depends just on the expanse of the tight blue wall. That becomes very beautiful in itself. This is the kind of beauty we find in a huge trans-Atlantic liner or an airplane, or rockets.

Or one can find beauty in craftsmanship, technology carried to a high level of control. This is Seagram's. Though its beauty relies to some degree on proportioning, Seagram's does not, like traditional architecture, depend on the relationship of all its parts. It depends on carefully proportioned and extremely well-used technology. You

can see the joints, you can see the bronze, you can see the high level of craftsmanship.

And that high precision is something that we all love and admire. You know, people want to study and handle a beautiful camera, not because it's more beautiful than others but because they sense it's so very well made. I think this is a very human response that we all share, and that is very much part of art. Like 16th-century armor or a Japanese samurai sword—we all adore the love and beauty of the craftsmanship, the high level of precision carried to a higher level.

Architecturally, the pragmatic reality is that you cannot build a building that does not conform to codes and government regulations. You cannot pretend that there are no labor unions. You cannot pretend that there is no steel, no large-scale glass, no concrete, no plastic. You cannot pretend there are no elevators. And you cannot pretend that there is still a high level of craftsmanship. Those facts are pragmatic and real.

But there is also cultural development—ideas and hopes that we share, at least within groups. We cannot ignore those either. I think architects work within the context that happens to coincide with their own particular interests and ways of searching. And those architects will go farthest whose efforts are reinforced by the ideas of the present.

We are now going through a period when ideas and the consensus are shifting rapidly. Certain attitudes toward design that were vigorous ten years ago are no longer. Many people who were working in the midst of the stream have suddenly been left high and dry. Some architects may survive to find themselves again in the stream, but for many the current will just move away.

For many decades, some architects were totally uninterested in historical issues because those did not help their thinking or the way they resolved things.

There used to be two or three trends all concerned with the expression of technology as a means of creating architecture, but they have all weakened considerably in the last few years. I think, however, they are all still germane as one major issue, and I think it is a trend that cannot be ignored. New ways are being found that correspond to the possibilities in our system of construction. For example, an architect working on a technology issue, pushing it just a little bit, may produce things that will be in manufacturers' catalogs and that other architects can use.

Interestingly enough, though, the same thing can happen with architects working on supposedly nontechnological issues. If architects start using capitals, industry will make capitals.

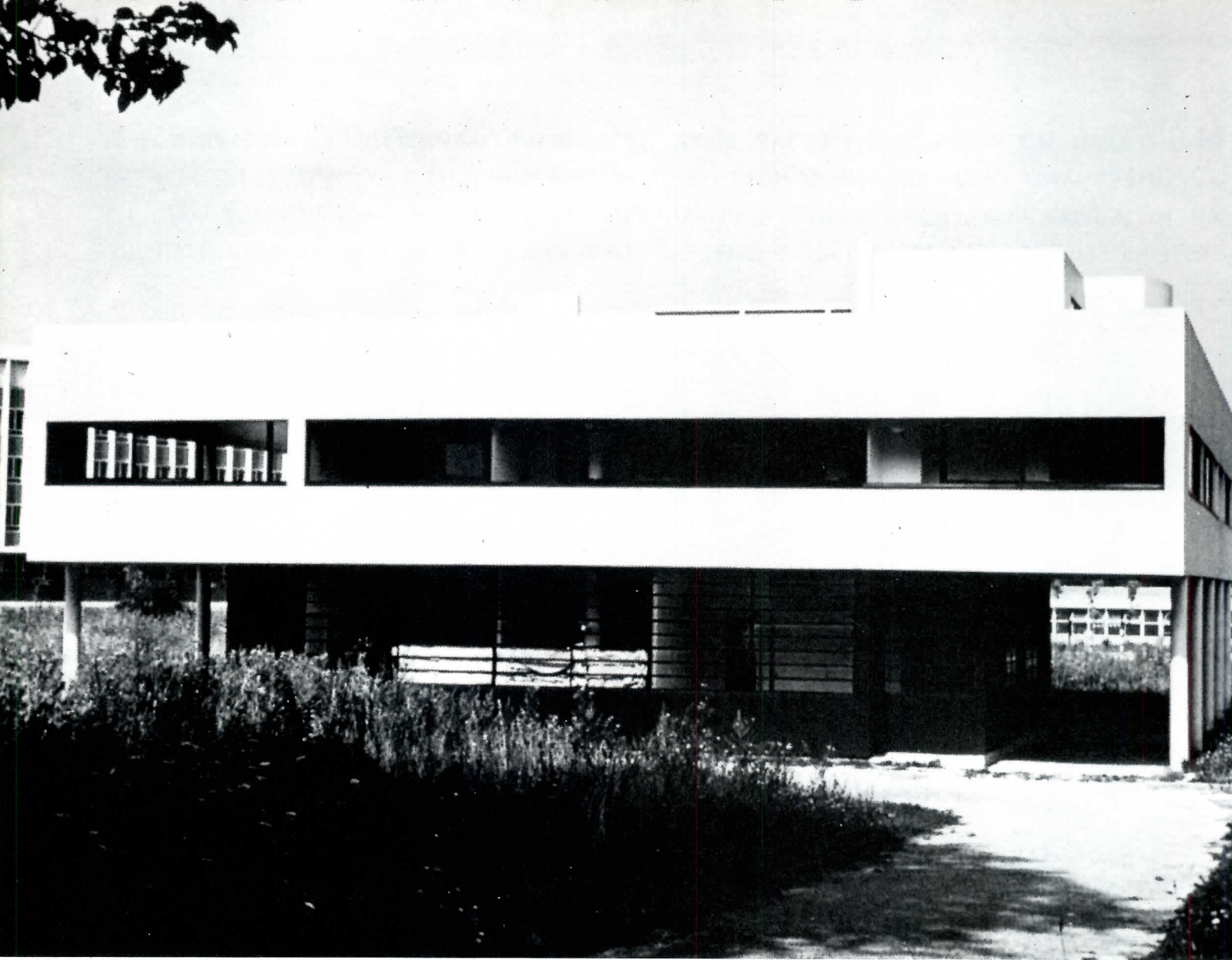

LE CORBUSIER STRUCTURAL MASTERY SUPPORTS ART

"I wonder why, when I walk around Corb's buildings, I see so much of structural interest. I have to figure it's because he knows what the hell he's doing." So says Herman Spiegel, who in 1978's *Engineering for Architecture* turned his structural engineer's eye on Antonio Gaudí's works, and who now turns to the works of a great architect whose mastery of structure he feels to be grossly underrated: Le Corbusier. "Many architects and scholars feel he doesn't care about structure, but the results are so consistent that no one's going to convince me they were accidental. Not even Corb can luck out forever. He does more than just use structural elements visually. He deals with them in a way I can relate to as a practicing engineer. I can get *my* kicks out of his buildings, too."

Spiegel examines two houses, each with a different structural system: the Villa Savoye at Poissy, where the architect used concrete columns and slabs, and the Maison Jaoul at Neuilly, with tile arches and brick bearing walls. And for good measure, he throws in observations on other of Le Corbusier's buildings.

BY HERMAN SPIEGEL
SPIEGEL AND ZAMECNIK, INC., ENGINEERS
NEW HAVEN, CONNECTICUT

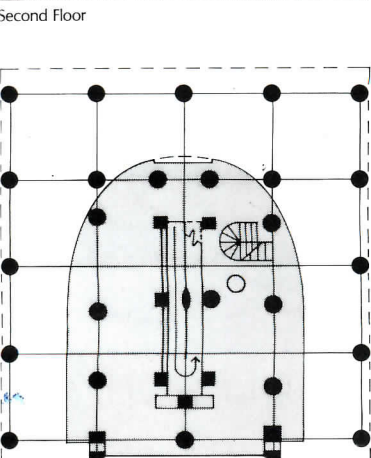
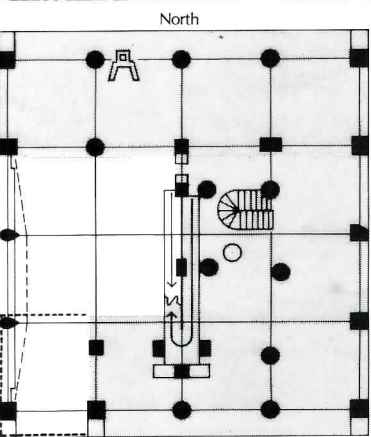
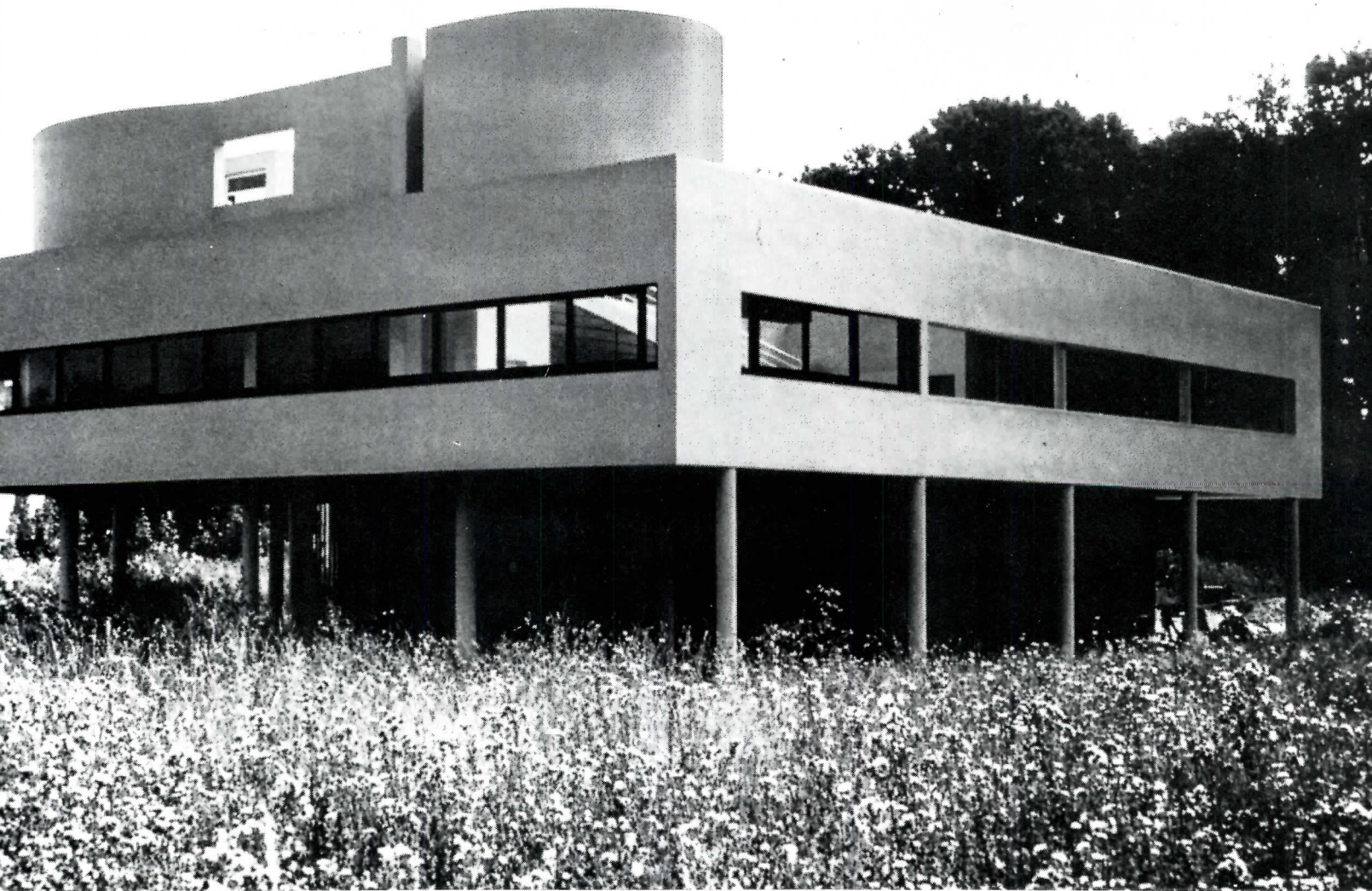

“At Villa Savoye, Corb shows that he doesn’t force structural regularity just for the sake of purity, that he uses structural necessity to create architecture. He establishes a strong column grid, five columns in each direction, set about 15½ feet on center. He sticks to it rigidly as long as he wants you to read it—but destroys it completely inside. As you approach the house from the southeast, you get a really strong image of that grid—five white columns marching along under the cantilever. He obscures it on the south face [top left], but when you turn under the porte cochere on the west, once again you read the columns you saw on the east side, and one row reinforces the image of the other. And then as you turn under the north facade, he reinforces the image again by curving the enclosed portion of the first floor inside two of the columns, so you have a square at each corner.

“The entrance is right smack in the center grid line, and that’s the first puzzle. But Corb clears it up immediately:

as soon as you open the door, you see two columns replacing the one you’d bump into had he left it on the grid. So—in the second row of columns (counting from the north), instead of the five columns you were led to expect from the facades, there are clearly six. And though he violates the grid, he makes it very easy—knock out one column, put two more in, with a short beam notched right through the glass to carry the column above [at right]. That’s pure class. (Our column plan exaggerates sizes to emphasize placement and shapes.)

“Directly inside the front door, you see the long ramp leading to the second floor, and a stairwell off to one side. And in the central column row, he really messes up the grid to accommodate his vertical circulation, using two rows instead of one—let’s say rows two-and-a-half and three-and-a-half—and instead of five columns, he gives you eleven. Corb breaks up the grid because the grid just didn’t suit all the holes he was punching in the slabs.”

Herman Spiegel photos





“On the second floor, Corb gave the house a variety of open spaces—inside, outside, sheltered overhead but open to the breezes. Along the top of an opening to that deck, he really makes an architectural feature out of that beam [left]. It’s the one taking the greatest horizontal force and its bottom flange tapers to show that—deepest in the middle, then tapering back as it passes the tear-drop columns, ultimately matching the thickness of the walls at the far ends. The beam below the opening doesn’t taper, however, and indeed where it joins the wall—you can just see it [center left]—it cuts in at the point where shear is important, not bending. It almost looks as though Corb’s being arbitrary. But I think he is precisely deliberate—and smart enough to look arbitrary. Around the roof garden, the white screens seem to be monolithic when you see them from below. But when you’re on the roof, Corb lets you see the parts—the vertical stiffeners, the horizontal stiffeners, the in-fill. You always see one side juxtaposed against another, smooth wall against ribbed wall, setting up tension and movement, adding to the architectural enjoyment of the space. Gaudí used that ploy, too: it appears to be one thing on one side, another on the other. That cylinder up on top reflects the spiral staircase on the inside. Corb treats the glazing along the ramp like a piece of fabric that he lays across and cuts with scissors. It’s clearly non-structural—there’s no way anyone could think that miserable little mullion has any capacity to carry load. No fussy detailing. He just plows the muntins in relentlessly. And look at that sharp acute angle. I wonder how many pieces of glass they broke getting it! But the French do incredible things with glass.”

C

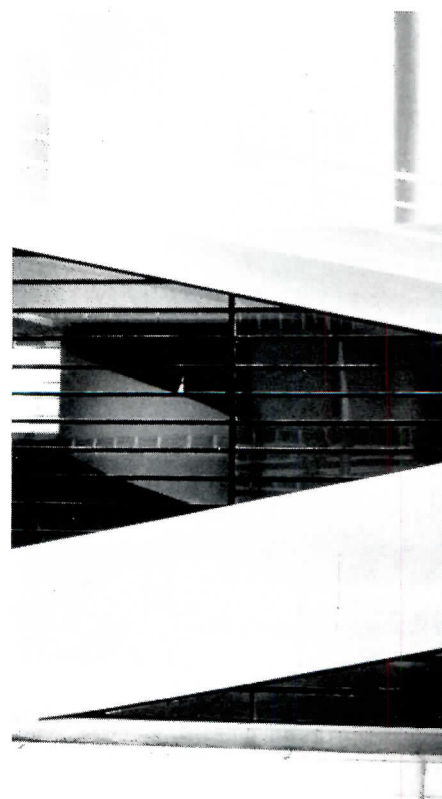
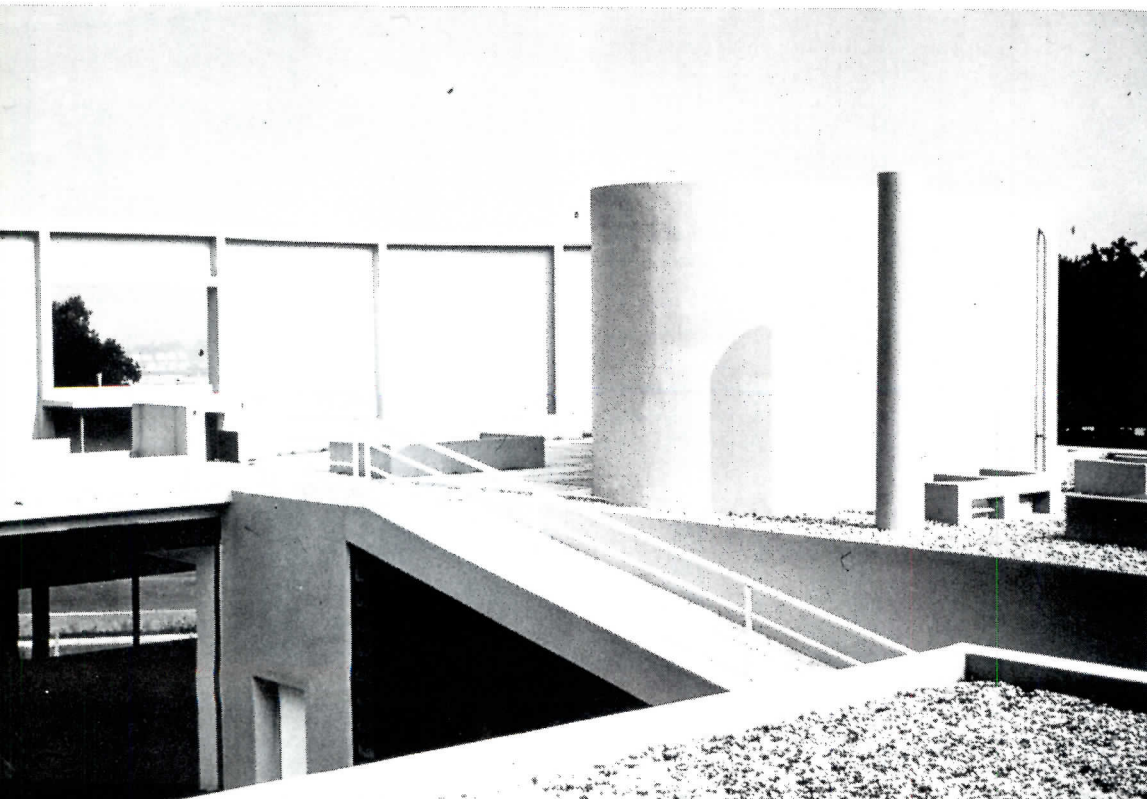

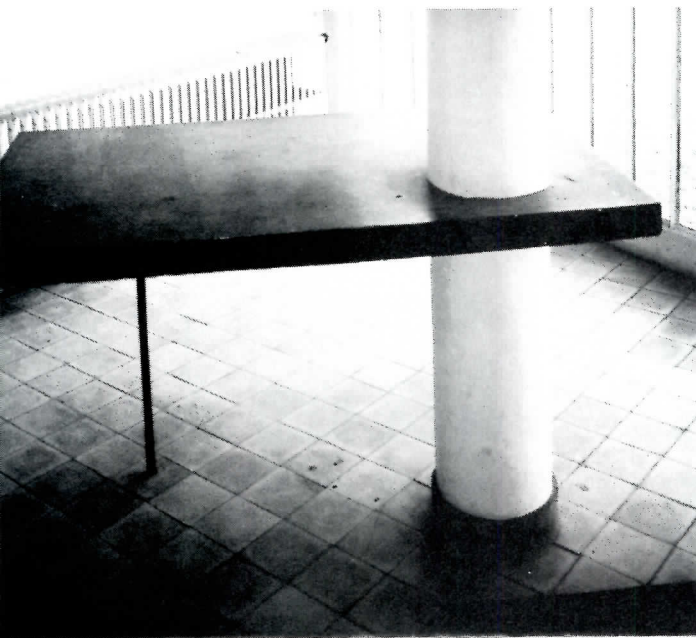
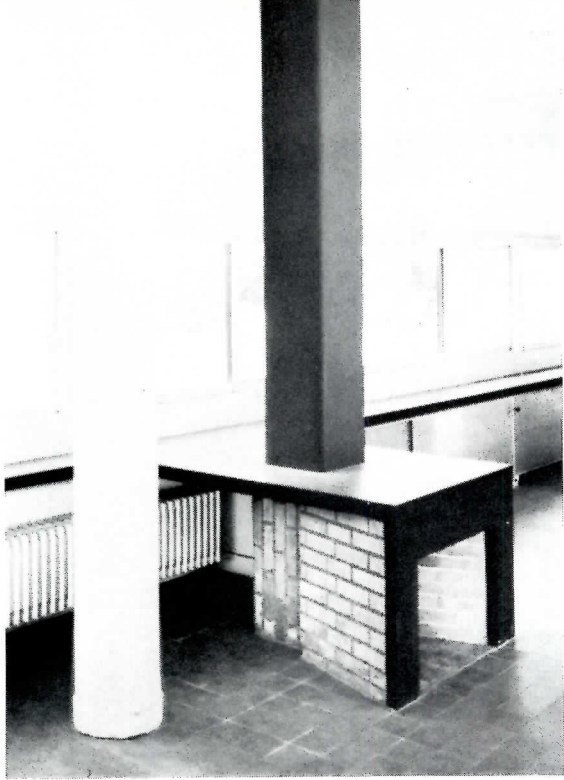

"The house is full of examples of the depth of Corb's imagination in details. Even the way he treats the joints on the fireplace—horizontal on the fire-box, vertical where the flue shoots up. The table just inside the entrance, cantilevered off that big column and supported by that little leg off to one side—an enormous contrast, and great. And the built-in chaise longue, waiting as you climb out of the blue tiled bath. Even the way he articulates treads and risers; he didn't make any attempt to line up the tile joints, and every time you walk up the stairs, you see a clear differentiation between the two. There's a man that pays attention to detail."

"The square column next to the spiral staircase marks the beginning of the grid breakdown. I think the shape is just symbolic—a signal that Corb is doing something different; there's no structural reason to make that column square, and he reverts back to round just above. The column is off the grid to accommodate the stair. Whenever you punch a hole in a flat slab, there's a problem around the edges of the hole, where you have to maintain the continuity of the concrete. Corb just pops in columns and solves the structural problem immediately. An engineer's delight—lots of things to grab on to quickly for short, simple little spans! And he has no hang-ups about consistency: most of the columns are round, but if he should have to fair in a window or a wall, he'll square the column to simplify detailing. Around that thin pipe supporting the railing, you can see a sliver of space where the stair curves around it. That pipe only supports the railing, a kind of structural parasite, and Corb didn't want you to think it was doing something it was not."

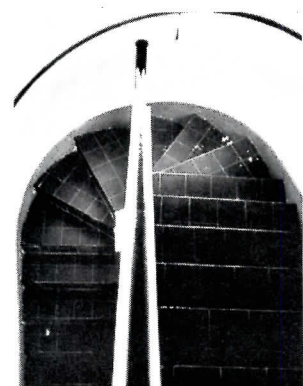
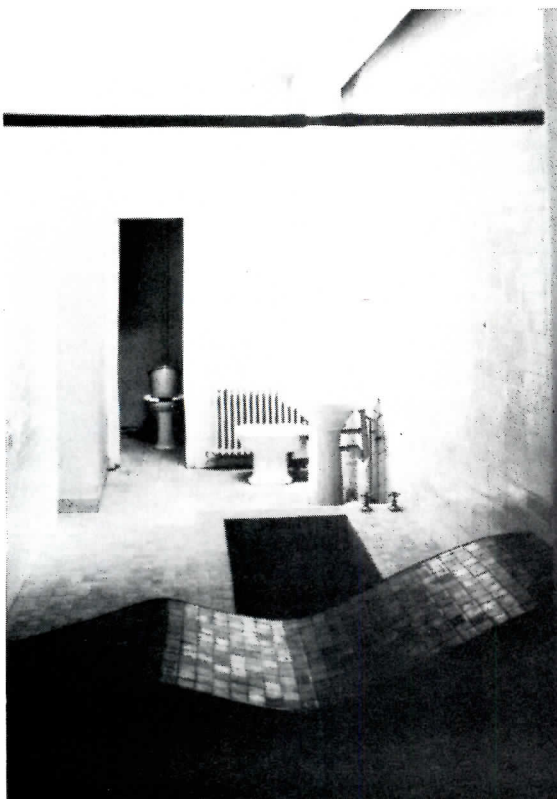



C

"The Maison Jaoul was one of the few masonry bearing-wall structures Corb did, as though he has to show us that brick has no more limitations than any other material for him. The heavy concrete beam is a very powerful structural element in three ways: as a beam in a vertical sense, carrying the masonry wall above it; as a longitudinal bond beam knitting the masonry together; and as a lateral beam for the ties taking out the thrust of the tile arches. That very deep, strong beam gives him architectural flexibility to shift elements around, pop openings in, do whatever he wants. The masonry is indeed bearing wall, transporting all load down to

the foundation. But that beam, which spans the length of the house, spreads the second-floor load to whatever masonry he has on the first floor. He can have masonry above even where there's nothing below—violate his rhythm, create a new one—and do it without straining or sweating at all. Secondly, that's a bond beam, which you need regardless of what you're doing. It doesn't allow the bricks to spread apart over the years and end up on the ground, which is their natural inclination. And thirdly, the beam receives the rods that tie the tile arches spanning between the three bearing walls. You're getting thrust delivered con-

tinuously along the lower edge of the arches, and the beam acts in bending laterally between the ties, taking a thrust out. Corb threaded the rods through the beam, tightened them with bolts and washers, then hid them with those little concrete buttons. An engineer would probably line those knobs up one right over the other. Not Corb. The beam is acting laterally, so he can place ties anywhere he wants (lower left). He does line them up once, as if to say, 'I know how it's supposed to be done, but I don't have to and I have better things to take care of.' (I saw this a few years ago, by the way. The house is closed to visitors now.)"

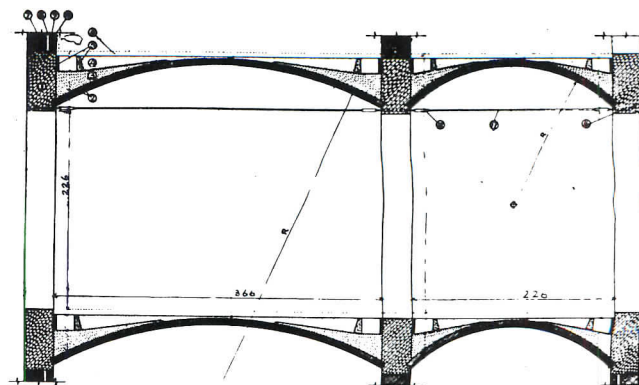
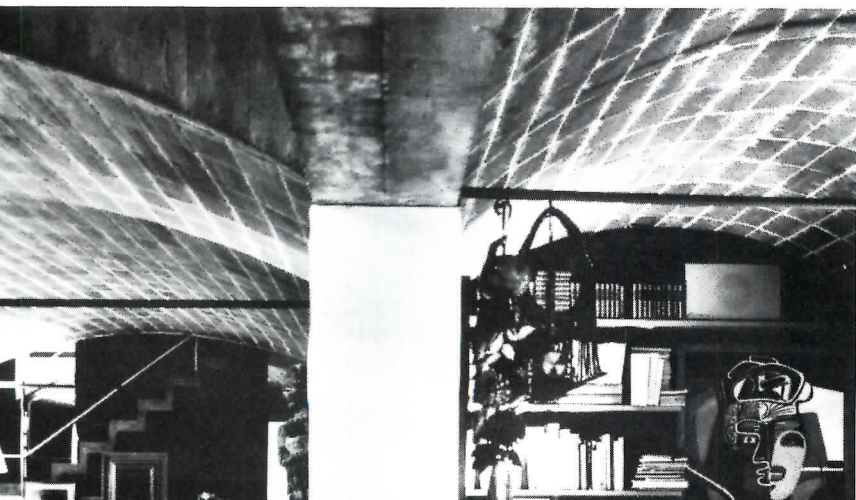



"Corb makes a big feature of the beam with his formwork, breaking it up visually, making it seem as if it's not doing anything. Right at the crowns (across page), where you have horizontal forces pushing against each other, he destroys any expression of these with his formwork. You know, a lot of designers would want to make it look as if the arches were pushing together. But Corb puts a vertical line here, a horizontal line there, and when he comes down to the spring line, he has vertical boards on one side and horizontal boards on the other. He makes it look unstable. He evidently said, 'Aw, you don't have to show everything right away.' His formwork denies the stress lines every time. Nobody could ever convince me that decoration doesn't come from Corb's understanding of structural forces."

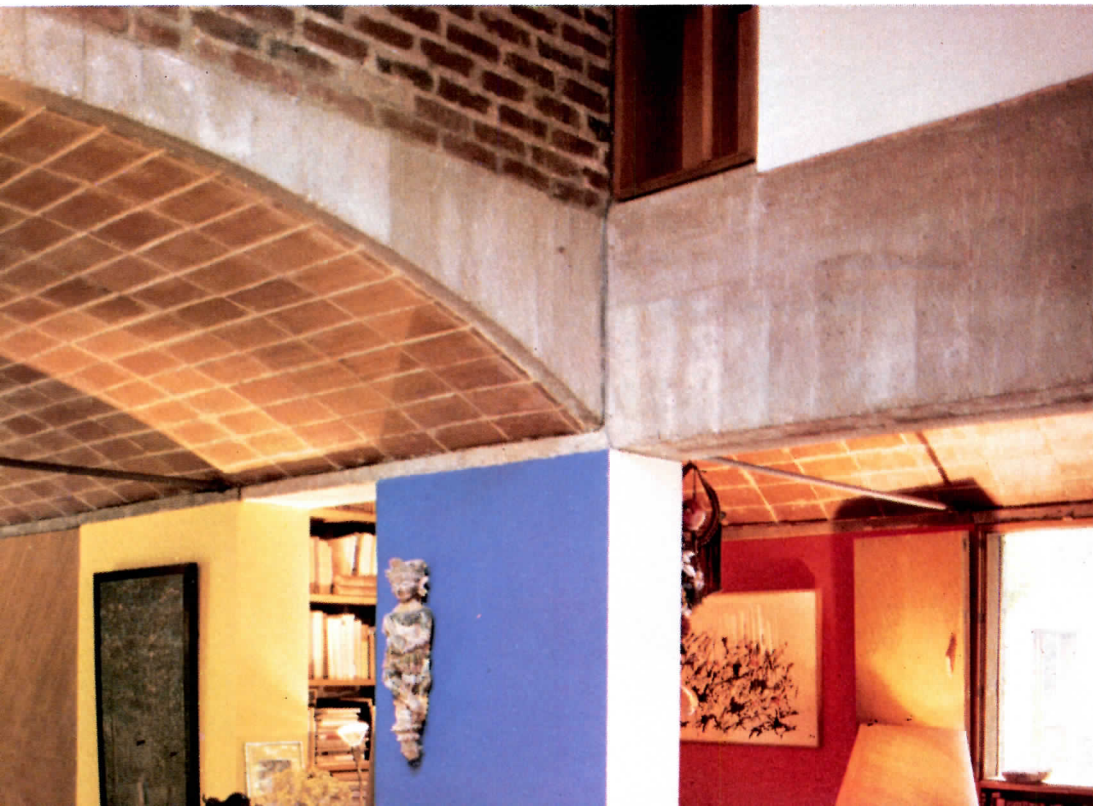

"Corb seems to like canopies and to want to cantilever them so as not to have any columns muddying up the structural picture. So he put that little drainpipe close to the wall instead of at the free end, and then curved it out instead of running it into the ground. You can easily see it has nothing to do with support."

"I'd like to go on record and say I don't think there's ever been an architect that understood structure the way Corb did. Many people think of structure as a gross pain. They wish they could defy gravity, or wind, or seismic or thermal forces. But to ignore these very real forces is somehow not to plug in properly. Corb doesn't deny a damn thing. He creates architecture by a deliberate use of structural elements, and gets double his money's worth out of his structure (he didn't spend too much on it in the first place) by making it very comfortable and by using it to design architectural features."



"At University City in Paris, that's a clever cantilever under the Br Pavilion. In order to resist bending, he used a T beam and turned it upside down. Corb knew a helluva lot about concrete structure—that's basic to the material he worked with. He evidently read everything he could get his hands on, and he understood completely that concrete can't take tension. So he put the flanges at the bottom of the cantilever where they can work in compression. Then he bent the ends up for an extra margin of strength and to offset camber."

"At Villa La Roche, the first thing you see is that round column in the courtyard plowing right through the soffit [below], and lining up exactly with the coupled shear wall in the distance. If you spend any time in the courtyard (the house is now the office of the Le Corbusier Foundation), you're very aware of the column—it seems to be in the way, as if Corb wants you to notice it and ask, 'What's going on?' Because when you get above the column upstairs, you're totally faked out. What you see are those pipes holding up the railing for the ramp. He takes that big column right away from you, and shows you those little skinny pipes coming down to the balcony—that's got to be under there. He didn't want to encumber that open space with a big column, but he put it down below to do the job. And that's his trademark."

C



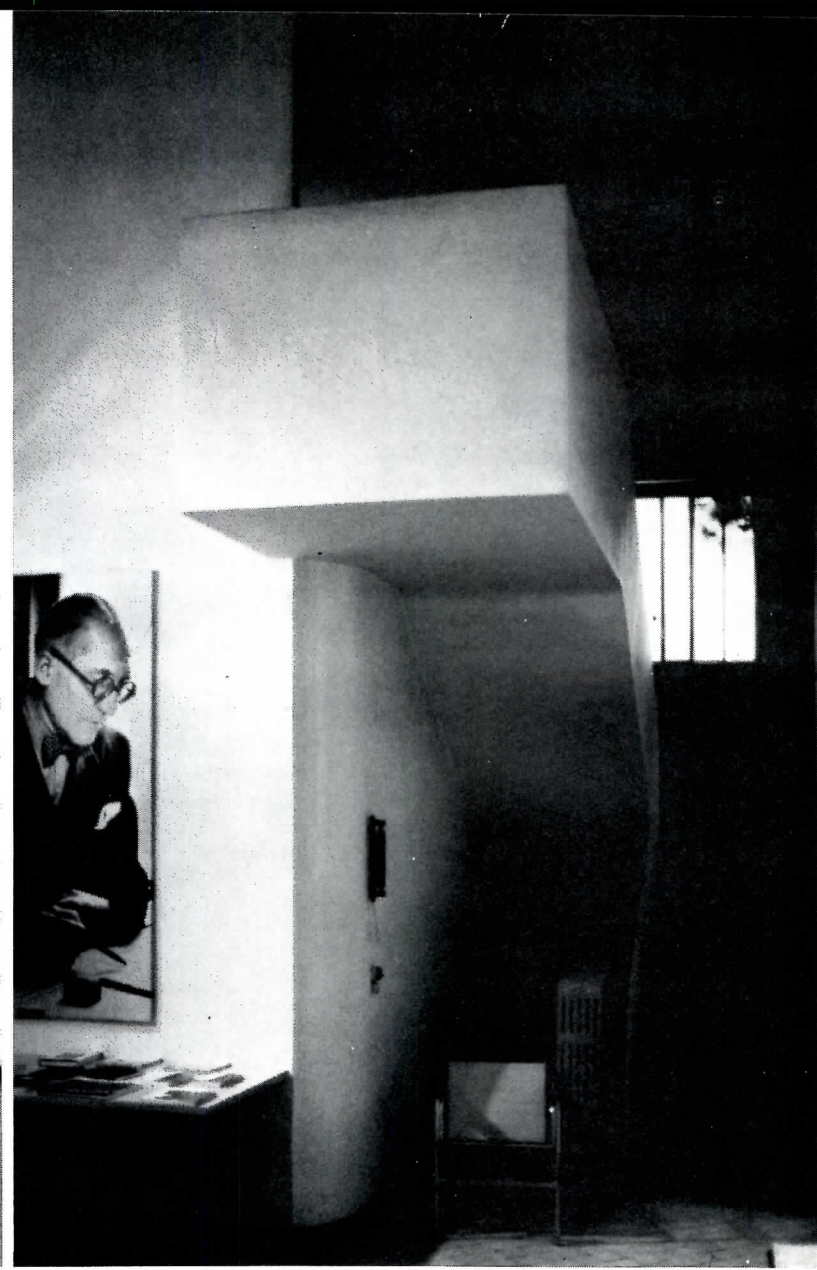

"At Villa La Roche in Paris, at the right above Corb's picture, that looks like quite a cantilever. The eye perceives the cantilevered box overlapping that lighted hard edge—it looks as if it's hanging by its toenails. But then the wall curves around, and from under the box you can see that big wall makes the stair cantilever very short. Very comfortable structurally, but it appears quite daring. He understands structure so well he toys with it."



"At the Salvation Army dormitory in Paris, Corb designed this little receiving shelter and ticket office. He's made that tall corner column so slender, he's pushed the thing right up into the Euler buckling range. But at best, it carries only half the spans in either direction—there's a full wall on the other side—so it's a very small rectangle that delivers load to the column. I think he was holding out hope for the unfortunates who use this place, showing you can carry a burden without that much hard work."

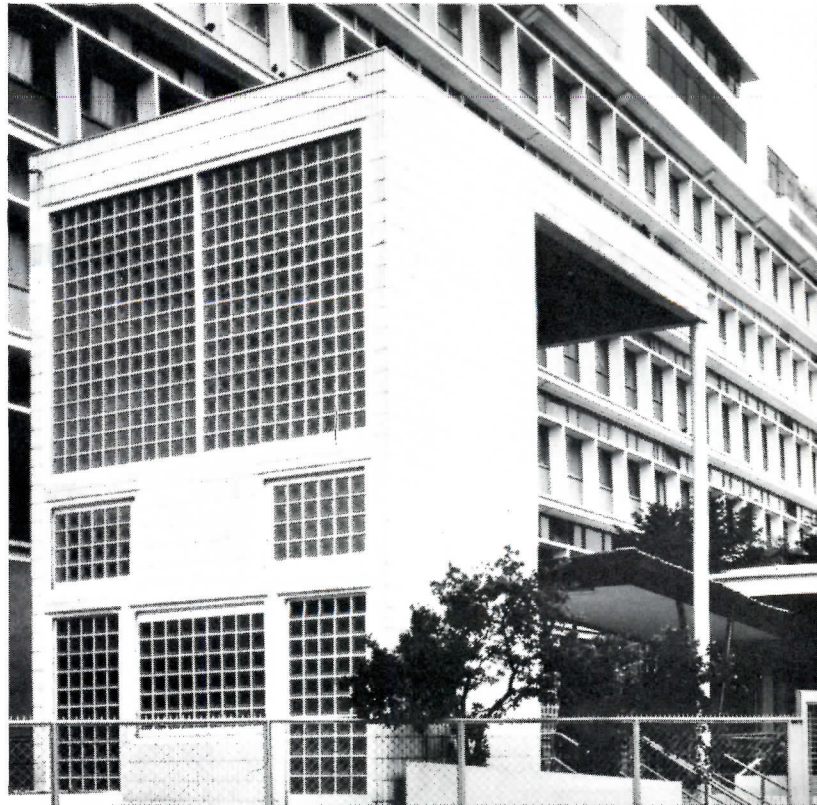

ROUND TABLE

Risk-taking in design and building

This is a time when clients are demanding higher and higher standards of performance; yet it is a time of pressure for lower and lower costs.

This is a time that demands innovation and experimentation, but a time when litigation has become an everyday fact of life.

Questions: Can the risks of design and building, now borne largely by design professionals, be reduced or shared more equitably? Are the risks worth the rewards? Or must professionals—against all their creative instincts—start playing it safe?

To answer those and other questions that today press upon architects and engineers, manufacturers and producers, builders and clients alike, RECORD invited to a Round Table some of the country's most thoughtful (and innovative) architects and engineers, attorneys concerned with both professional and corporate liability, experts on building failures, builders and clients.

The discussion turned not just on the very serious matters of professional liability, but—perhaps more importantly—on the philosophies of professional responsibility for all of the participants in the building process towards each other.

Ezra Ehrenkrantz, an architect perhaps best known for his research and stunning innovations in system design (see article, page 94), got in the first word and listed many of the questions the Round Table discussed through the day: "In designing any building today, we are dealing with a dynamic situation. Life styles are changing, user needs are

changing, perceptions of what is important are changing. The functional requirements of various building types are changing [the open office is a good example]. The demands for energy conservation are demanding major changes in building design.

"If we try to play it safe in terms of meeting all those needs, in terms of cost implications, in terms of resource utilization, we are going to find ourselves being non-responsive. We have to continue to try new approaches—new uses of materials, new kinds of interfaces between materials, new ways to solve acoustical and energy problems. But this involves risk.

"So in many ways you're damned if you do—and damned if you don't.

"Once we agree we have to take some risks, the question becomes: How do we cover ourselves? What has to happen, I think, is to be straight and up-front with the client in terms of what the risks are.

"Then," Ehrenkrantz continued, "there is

the matter of building upkeep—all buildings and their materials have a point at which they become distressed. Terra cotta may last forty years; another finish twenty years; and there is no predictability for some of the newer materials. At what point does the baton pass from designer to owner vis-a-vis maintenance? Should we be providing maintenance manuals on scheduled maintenance as the auto makers do?

"Under life-cycle costing, we are being asked to take more and more responsibility, not just for initial operation of the building but for its performance some years down the line.

"Architect and manufacturer alike need 'test beds' to experiment with new products and systems over a long time-span without forcing any one party—designer or manufacturer—to go out on a limb. Perhaps the government agencies could provide this kind of shelter for experimentation—without it, there will be a tendency not to innovate.

“The question, once we agree that we have to take some risks, is: ‘How do we cover ourselves?’...The answer, I think, is to be straight and up-front with the clients in terms of what the risks are.”

—Ezra Ehrenkrantz

“In all of these areas, we are going to have to find ways to agree on the risks involved, and how they should be shared. Where there is a societal need for innovation, no single part of the society should be expected to take the risks for everyone else...”

Michael Brill, architect and president of BOSTI (Buffalo Office for Social and Technological Innovation) on taking risks: “Design can never be science. Design can never have the certainty that science attempts to move toward; where science has as its goal the development of truth and knowledge, design is really involved with change and control—somehow controlling the future. Design must intervene—that is what it is all about. Science is very much interested in information which can be generalized to a whole lot of other cases; in design there is never a whole lot of other cases, because design is specific to a program. The last major difference, I think, between science and design is that in science if you get a wrong answer, that is still valuable information; in design being wrong is ...well... not nice. Being wrong penalizes the client, the neighborhood, the social structure within which that building is supposed to function, and its users. Design is done all the time with imperfect knowledge, and yet it can’t be wrong. Ergo, conflict built into what it means to design something in the built environment.

“So what the professional *has* to do is take risks, because we are always presented with novel or unique situations. And therefore, professionals are always confronted with a certain amount of risk. But make no bones about it: Altering risk alters design.

“I think the critical issue is that we not try to transfer those risks to others who don’t have the capability to assess them, to understand them, and to try to respond to them. There are strategies that we can adopt that alter the patterns of distribution of risk or the nature of compensation for risk—or even moving into a kind of learning mode using all of what we build as a laboratory. One thing is sure: as designers or owners we cannot assign risk to the people who *use* a building—risk must be shared by consenting adults only.”

With those two broad and thoughtful statements as background, the other architects were asked their views of risk-taking and -sharing

First to speak was Alan Schwartzman of Davis-Brody: “Many of our clients come to us



Albert J. Bartosic
vice president and
general counsel
Rohm & Haas
Philadelphia

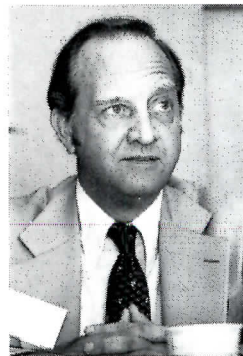

Bernard H. Breymann
attorney-at-law
Chicago



Arthur T. Kornblut
attorney-at-law
Ford, Farquhar Kornblut
& O’Neill
Washington, D.C.



William H. Feldman
project attorney
National Institute of
Building Sciences
Washington, D.C.

because we have a reputation not just for quality design, but for innovative design. But there are many degrees of innovation. At one extreme for us was the United States Pavilion at Osaka. When we designed it, there was no previous experience with a cable-restrained, air-supported structure. The fabric that was used really could not be guaranteed—we used it on the basis of careful and extensive testing. We tested the aerodynamic and structural qualities of the roof in a wind-tunnel. And even though the risks here were shared by the Federal government—which wanted a building that would be a talking point—we nonetheless knew one thing for sure: that if things went wrong and there was a loss of air pressure, the roof would settle very gently and come to rest well above the heads of the occupants.

“But we do have to live with and try to minimize the risks inherent in using new materials and products. The manufacturers and producers must take the responsibility of performing whatever testing is necessary to give us reasonable assurance of performance. Then we, responsibly, can go to the client and be able to say we are specifying this material because we have reasonable assurance that it will perform. We need solutions to problems; and manufacturers cannot wait for five or 10 or 20 years of experience before their products get acceptance. So we do need, and have, a certain sharing of risk with manufacturers and producers.”

Bob Harper of Moore, Harper, Grover, a small and extremely innovative design firm, agreed with the “consenting adult” theory: “A lot of the question of risk through design has very much to do with how well we can talk with the client, and talk with the contractor who is putting up the job, and talk with the people who are supplying the materials for the building.

“One example: We recently had to drop some highly technical and very complicated 20th century laboratories into a 19th century building—a kind of work we’d never done before. Happily, we worked with an in-house contractor familiar with that kind of work—and we talked a great deal with them about new materials and structural elements. On another project, back in the Operation Break-through days, we worked with modular housing from two different manufacturers. In this case, the non-profit sponsor of the housing went with us to interview manufacturers being considered for the project—and he was well prepared to accept the risks involved in building houses in Pennsylvania

“ We live today in a society which demands no risk—an impossible situation. We have no real ability to measure risk as a cost-benefit to the various participants in the design process. . . . ”

—Martin Raab

and putting them on trucks to be placed on a site in Maine. The problems we had—even in this kind of low-budget job where HUD typically expects forty-year life with no maintenance and a bargain basement price—were solved with a minimum of fuss and expense to everybody.”

Harper offered: “One final example: We did an armory for the State of Connecticut, we thought it was a good solar application, and we sold the client on the idea that it was just another plumbing system—that there was a possibility of leaks, pump failures, and so on, but that it should work well. Well, we did have a problem of leaks because of the particular fluid we used, and we are currently replacing some pumps. But because we and the client understood the nature of the risks and rewards, and because we built some contingency into the budget, the whole thing has worked out well. It all boils down to how effectively the client and architect can talk to each other and understand the risks.”

Architect Martin Raab of Haines, Lundberg, and Waehler—a much larger firm noted for its work in more complicated building types such as hospitals and laboratories—argued that: “With buildings like the four hundred or so research labs we have done, I think the risk assessment is a different story.

“We have to point out the risks of not having a flexible building—OSHA may come in today and say ‘You need so much more air’; and come in tomorrow and say ‘You must treat so many chemicals in so many different ways’—and the buildings have to be able to adjust. Our job is to try to assess and inform our clients of the parameters in which risks must be faced, and what the costs of meeting them are.

“Maybe they are one and the same, but I tend to separate our risks of innovating and risks of using new products and materials. You can design a very innovative building and meet all kinds of future and unknown requirements with products and materials and systems that have long histories of performance and satisfactory maintenance, and that clients are comfortable with. Our biggest problem is when we try to innovate with new products and materials and systems. The risk of dealing with new products has been for us the failure of the product. We get caught up in the need to innovate with a proprietary product—you are designing around a single manufacturer and the situation can change between the time we agree on a solution with the client and the manufacturer and the time the product must be bought and



Robert L. Harper
Moore Grover Harper
Essex, Connecticut



J. Karl Justin
Justin Architects
New York City



Roger Lang
project manager
Turner Construction Co.
New York City

installed. Sometimes you get low-balled. Or if you pre-purchase you lose control of costs—the manufacturer blames the sub for jacking up his price because he is unfamiliar with the product, the sub replies ‘Well, this is the price I got.’

Architect Karl Justin, as he often is, was a bit more philosophical about the risks of innovation: “Tell me, what is innovation? Whatever it is, from the comments so far, it is our business. We cannot *not* innovate. We are in a situation where client needs are changing, and technology is changing. So innovate is what we have to do. . . . period. The alternative is to stand still and freeze in the dark.

“We are, to make things more difficult, in a period of transition. We once had existing and accepted and comfortable styles and technology that had been developed and tried over years. You could reach into that vocabulary. Now change is coming faster—and we haven’t yet developed the vocabulary to make it clear to the client what is happening. We may, in this situation, have to stop intimating our own infallibility. . . .”

Engineers, of course, share in these risks—and their attitudes about risk introduced some new thinking

Structural engineer Othar Zaldastani: “I conceive of my role as one which tries to bring order and introduce clarity into the designs of architects. I agree with all of the earlier panelists that innovation involves risk. We live in a dynamic society; we are facing new problems.

“Of course these new problems can be met by way of new solutions or old solutions. That, I would say, is the big responsibility of us designers—to solve those new problems.

“But I would say that when a designer looks at new solutions to *old* problems he runs a different kind of risk. When we look at a familiar problem from a different point of view and try to come up with a new product, a new approach, or a new design—then we must have a justification. There must be a purpose for running that risk; and the purpose is the benefit that someone will get from that innovation. Unless there is a benefit, taking that kind of risk is capricious and meaningless.” From that base. . . .

Dr. Zaldastani argued that the responsibility for risk should be taken by the one who benefits from taking the risk

“If we consider these types of risks, the next question is: Who benefits from the innova-

“Who should take the responsibility for innovation? The responsibility should be taken by the one who benefits from the taking of the risk.”
 —Othar Zaldastani

tion? It could be the owner, it could be the manufacturer, it could be the architect and/or engineer. When you determine who benefits, you automatically arrive at the answer as to who should take the responsibility: The responsibility should be taken by the one who benefits from the taking of the risk. . . .”

. . .and he emphasized the special risks involved in the re-design of old buildings for new use

“The risks on this kind of job have to be clarified from the very beginning. Obviously, there are risks any time you touch an old building, especially if you do not have the drawings and certainly if you do not have the money necessary to investigate completely the nature of the building—its structural framing, its foundation, and so on. This kind of risk cannot be open-ended—you cannot be a wishful thinker and figure that since the building has stood there for a hundred years, it’s bound to go on standing. On projects like this, you have to establish a band of risk you can define—an upper line, some control on the implications of your design. Any risk must be taken with the understanding that you do not go beyond a certain line; a line defined by your evaluation of the consequences of taking the risk!”

Mike Brill broke in: “I think that Dr. Zaldastani’s question—‘Where do you draw the line’—is a critical one. Which risks should we take? At what point do you not take a risk? I think I am hearing two basic models of risk handling: One of them is the ‘Let’s all hang together model’—in which I tell my client I don’t know what I’m doing, but I’m going to tell you so we will all not know what we’re doing together. I don’t mean to be fatally facetious—but the amount of information we bring to many innovative situations is very small. The other model is the ‘That’s life! model’—where we figure that some risks are assumed, like the risk of being hit by an automobile. But risks are not seen that way in architecture—designing a door that opens onto a stairwell is not the same kind of risk.

Engineer John Hanson, whose firm specializes in investigations of failure, introduced some practical specifics

. . .and he thinks that there are a lot of differences in the nature of risks that designers are called upon to make compared with five or ten years ago. Item: “Computers, for example, have had a tremendous impact on the engineering profession in the last 10



Martin D. Raab
 partner
 HLW Architects
 New York City

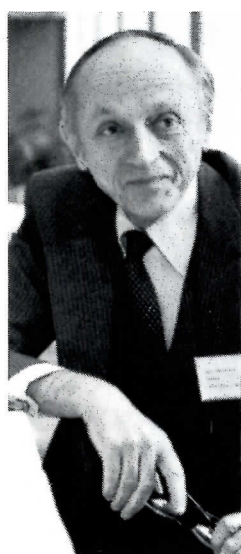

Alan Schwartzman
 partner
 Davis Brody & Associates
 New York City

years—and on the design risks that are undertaken. Engineers can now tackle almost any kind of complex structure—and being engineers they are very prone to do just that. They can now design highly indeterminate and highly complex systems, and run many, many different analyses. The trouble is . . .the problems that occur with structural failures don’t come as a result of this analysis—rather they occur because of the failure to develop details that can go along with these analyses and allow the people out there in the field to build these complex stress structures. Any design that is over-analyzed and under-detailed leads to changes being made out in the field. Whenever anyone out in the field is forced to make field decisions and field changes, the process is hard to control and results in a lot of problems.

“But it is not just sophisticated structures that cause problems. You would think, for example, that by now we could expect a truckload of concrete arriving at a job site to meet specifications—yet we often find problems. The same is true with steel: bar joists must be one of the most-used products in building construction, yet about one-third of the failures that our office investigated this past winter were bar-joist failures under snow load—and the majority of the collapses took place within the designed safety factor.

“People do not appreciate the problems in the control and transfer of work from a design office to the field, or the responsibility involved as a result.

“One more area in which we design in a lot of risk: the interfacing of systems. When we interface, for example, precast concrete with structural steel, many designers don’t bring the two elements together properly. They forget that when you start drilling through concrete you will hit a reinforcing bar and pop out the concrete on the other side. You cannot make a bolt or connector function in single shear the way we envision it in ordinary design practice.

“So if there is any one thing that I would suggest we rethink: We depend too much on single elements in design. If any one simple element can fail and lead to a failure, then there is something wrong with the design.”

Roger Lang, who was a project architect before he became a project manager for Turner Construction, talked about “conceptualizers” and “realizers”

“I don’t want to be interpreted simplistically,” he said, “as thinking that design professionals are conceptualizers and everyone else is a

“We depend too much on one thing in design. When one simple element can fail and lead to a collapse, then there is something wrong with the design.”

—John Hanson

realizer. It's not that simple. But it is critical, in determining and minimizing risk, just how well these conceptualizers and realizers work together and how many (or how few) people there are around who can at least present both sides of the problem at the same time. As Mr. Hanson pointed out: There are a lot of things that can happen at the end of a beam that are difficult to study by computer. There are a lot of details like that which are generally in the heads of the realizers, and that is the kind of detail the conceptualizers need to appreciate and understand in order to be good conceptualizers.

“Perhaps the toughest problem for a builder is to be confronted with a contract document that specifies a certain means or method of construction which he thinks is not right, or with which he has experienced high failure rates. In situations like that, perhaps the riskiest thing the builder can do is to go on record that he disagrees with the way something is specified to be done—and then go ahead and do it. Because in situations like that, the courts are liable to say: ‘Not only did you not give the owner the full benefit of your experience, but you even documented the fact to him that you disagreed with the procedure—and then went ahead and did it.’”

Albert Bartosic outlined the very real concerns of the manufacturers about innovation—and the risk that goes with it

“As vice president and general counsel of a company that makes chemicals and plastics, I am accustomed to using the two terms I have heard most at this Round Table: risk and innovation. I share with Mr. Justin his concern about just ‘what is innovation?’ Perhaps product innovation has been blown out of proportion, perhaps especially in the plastics field—and we have led architects, owners, and users to expect too much.

“My job with Rohm & Haas is to keep us out of product liability suits if possible. The most interesting part of that job is working with the people who work with you architects and engineers to use our products within acceptable limits. There is no such thing as ‘no risk’ for us or you. All plastics are, for all of their good qualities, combustible. When architects started taking our materials and using them as skylights, we were concerned with the risk—what we were doing to the common degree of safety by replacing a non-combustible material, glass, with a combustible material, plastic, to transmit light. We hired a greatly esteemed engineer—retired

from the National Bureau of Standards—to run all kinds of large-scale tests for us. When he finished, along with his technical advice, he gave us this piece of advice: ‘If your salesmen are successful in selling your products, you should so conduct yourselves that you have nothing for which to apologize.’

“When our products spew out of our plants, we have no idea where they are being used—and this means risk is imposed upon us, but we don’t even know about it. Under antitrust laws we cannot control where they are going to be used. So what we do is work with the regulatory and building code officials to reduce the risk—not just for us, but for you architects and owners of buildings. They bring the other disciplines to bear: They have fire marshalls who sit on their committees; they have structural engineers. They work out a pattern of enabling legislation within which our products can be used. . . . I am not saying if our products are used in that manner, you are never going to have a problem; but I do think you are working within an acceptable risk.

“Acceptable risk in our definition is safety—an acceptable risk made by informed people with the best information available and honest disclosure.” In fact, said Mr. Bartosic:

“The best way manufacturers can help with and share risk is through disclosure. . .

...honest disclosure by all manufacturers, not just chemicals and plastics, but steel, wood, concrete and all other products. It is not so much a matter of hanging together; it is working together with the best available information. By doing that, we are going to start reducing our risks down to the level of acceptable risk. I think we have to go back to those basics: Manufacturers should be expected to make the most complete disclosure possible to architects and engineers so they can specify and use materials based on that best information. Architects and engineers, in turn, should be expected in their design and engineering concepts to minimize the risks. And finally, the owner should be expected to provide reasonable maintenance and management of a building as his part in putting risk into perspective. . . .”

Another manufacturer—which provides design service as well as product—argued that too many clients are “lawsuit-happy”

Said John Meeks of Automated Building Components (which manufacturers gang-nail connectors): “Our product was developed as

an innovation in the wood construction business. It’s a small device, but our industry will probably sell over \$100 million worth in this country alone. We keep an engineering department busy designing— every week— about five or six hundred different trusses utilizing our connectors. We do business in almost every country in the world, and this country is the only one that is absolutely lawsuit-happy.

“I think technology is being attacked by society to an unreasonable extent. We have a whole generation of people who have been reared with the idea that they can do no wrong; therefore, if anything bad happens, it must be the fault of someone else. We have all kinds of consumer advocate groups constantly looking for openings leading to lawsuits. Our industry has done a great deal of technical education work—for example, developing standards for bracing wood trusses to eliminate the ‘domino effect’ if there is a sudden wind storm during construction. We have by this effort reduced toppling failures tremendously.

“As others have said, we need to communicate more, we need to be forthright with each other, and architects have got to realize that once they have found a reliable supplier, they have to protect their specifications from low-balling.”

Attorney Bernard Breymann—who was a developer-owner for ten years—talked about the owner’s responsibility, and the tie between risk and reward

“Owners always bear one enormous risk—the risk of in one way or another losing his money on a project—and that risk cannot be transferred. They must deal with the results of the completed project.

“But as a developer I know personally that there are much greater rewards for the developer than there are for the professionals—and the rewards for a designer are not commensurate with his exposure. I think one approach to the sharing of risk is that there should be a relationship between risk and reward. . . .”

“We see an increasing number of insurance companies and other large firms becoming owners; and they are becoming owners for a reason. They can incorporate each project, insulate themselves from a lot of problems; buy a lot of protection. But the medium-sized or small design firm does not have that prerogative—and it takes only one suit to put a small professional out of business.

“ We have a whole generation of people who have been reared with the idea they can do no wrong. Therefore, if anything bad happens, it must be the fault of someone else. ”

—John Meeks

“Also, if you lose money on a project as an owner, you are losing money—and if I may be allowed to say this, money is replaceable. However, one’s professional license is not replaceable. If an architect is held accountable for an error, which may be one of judgment—and reasonable men can differ on whether it is an error and if so who is responsible—a professional is in danger of losing his livelihood by reason of one problem on one project.”

...and he wondered about the concept of agreeing “up-front” on the sharing of risks, perhaps based on reward

“There are several possible ways of sharing the risk,” Mr. Breyman suggested. “As others have said, you can keep the client fully involved and knowledgeable about what you as a designer are doing. We can let the courts settle everything.

“But we already have all kinds of up-front agreements—for instance, what the architect’s fee, the engineer’s fee, the contractor’s fee or profit will be. Why can’t there be a similar range of exposures for liability—based on dollars or reward expected—drafted into contracts up front? This might be a more efficient way of sharing risks than waiting until some incident happens and everyone starts pointing fingers. . . .”

“What if the problem required some special expertise? As was suggested earlier, I think it would be a good idea to establish a ‘finder of facts’—an appeals-on-disputes-mechanism within the construction industry—which is not judiciary but rather a panel of peers. It would examine a situation and make a finding, which would not be binding but which I believe the courts would hold to be very persuasive. And this would certainly speed up the process in our overloaded judiciary system.”

Barbara Schnepf of NIBS talked about the risks associated with process—not technology

“I think the problem is not so much with technology, but with the people in the field, the techniques of construction, the labor market, the perceptions of lenders and the public client. . . .”

“Many of the risks are simply perceived risks: For example, when NIBS [the National Institute of Building Sciences] did a research study on the problems of introducing new technology, we found that lenders felt there was indeed a risk in funding a building with a new system or new product designed in—



John M. Hanson
vice president, operations
Wiss Janney Elstner
& Associates
Northbrook, Illinois



John E. Meeks, PE
vice president,
structural engineering
Automated Building
Components, Inc.
Miami, Florida



Dr. Othar Zaldastani
Zaldastani Associates
Boston

because there might be a financial risk. That is a perceived risk that may or may not be a real risk. Similarly, when I went to work for the Illinois Capital Development Board, which was building about \$1 billion worth of new buildings, we had a system for letting multiple contracts. That’s fine—but it also involved the mechanical contractor having a bond for his part of the work, the electrical contractor a bond for his, and so on down the line. And then we asked the general contractor to have a bond for the *whole* job. All of which meant that we were being very over-protective—at a cost to the public, by the way, of a considerable number of dollars.

“Another example of the cost of ‘perceived risk’: The Board had a set of contract documents about 10 inches high—and we used them whether we were building a state park or a \$60 million teaching hospital. Those contracts seem to be written on the assumption that the public money had to be protected from all those elements in the private world. After much work, we convinced the state Contract Section, the project managers, and the legal counsel, to write a simpler and equitable set of documents that did not assume everyone out there was a thief, and that shared liabilities among the architect, the contractor, and the state. I’m sure that our bids went down sharply as a result.

“Again, I think we can do a lot by improving the processes involved in building, and clearing up unnecessary redundancies and complications in our documents.”

At this point in the Round Table, the lawyers started talking turkey: AIA’s Dale Ellickson traced the rising cost of insurance

“From the AIA’s point of view, liability concerns didn’t really crop up until the late 1940s. In 1947, AIA got actively involved in professional liability by commencing one of its first insurance programs—and that was not a very broad program. By the way, the typical premium was \$50. Until 1947, the architect’s liability was limited to liability between him and his client. But in the late 1940s the concept of privity, as they call it, had been breached; and the architect’s liability became broader. The Institute took the position that the best way to protect against that expanded risk was insurance—but nonetheless, there wasn’t much in the way of insurance until 1957 or 1958, when AIA brought on the amended program with Continental Casualty Insurance Company. Since then, we have had

“With the requirement in construction for such strong contracts...that piece of paper becomes an excuse for not doing a lot of other things that really do need to be given attention...”

—Arthur Kornblut

a long learning process, not without some trials and tribulation. Under the first [early '50s] contract with Continental, claims mounted to well over projections, because we had not projected the long 'tail' of liability between the time a building is complete and some claim that may arise 10 years later. By 1968, Continental had a \$9 million loss on the books and was considering withdrawing its broad coverage from the market. They got a substantial rate increase plus a reserve program, which amounts to 25 per cent of the premium. The most recent crisis occurred in 1975, when there was a more-than-100-per-cent increase in some categories of insurance. Those rates caused many of our members to take a step back and look at insurance: Was this the only way to pursue risk management?

“Prior to 1975, insurance premiums were running one to two per cent of an architect's billings. Since 1975 they have increased to at least two to five per cent, and in some cases around nine per cent, of gross billings. Some of our members feel that this is unreasonable and have changed their approach; going bare (without insurance) or switching areas of insurance on a frequent basis—which is troublesome because of gaps in coverage between carriers.

“There just is no easy answer to the risk management question; no inexpensive way to force your liability off onto an insurance company...”

But Mr. Ellickson did suggest “a sort of two-part arrangement for risk management... .”

“One part is insurance, probably with a very high deductible; the second an office-management program under which the architect undertakes rigid quality-control measures to ensure the highest-quality end product—contract documents. I hate to call an architect's contract documents a 'product'—but they are the service he is providing and have a major impact on his liability.

“To return to the early question: Will this kind of 'quality control' really affect innovation in architecture? I really don't know. But I believe that you can have innovative design and good quality control if you have a systematized method of risk management in the office. In the past, architects have used tests, built mock-ups, relied upon manufacturers' tests and specifications—all good, accepted ways of quality control. I cannot give you a better system for quality control right now...”



Dale Ellickson
attorney
The American Institute
of Architects
Washington, D.C.



Barbara J. Schnepf
director, regulatory &
industry services
National Institute of
Building Sciences
Washington, D.C.



Bruce E. Vogelsinger
managing director
ACEC
Washington, D.C.

Attorney (and architect) Arthur Kornblut argued that the laws of construction are —if complicated—stable and essential

“The laws affecting construction simply set forth some very generalized ground rules for how the participants in the building process are going to conduct themselves and—if they don't—how they will be held liable. The biggest problem—when we look at the construction industry—is that the law operates in its parts—the role of the owner, architect, engineer, contractor, manufacturers, governments, financial institutions. The law as it relates to each one of those participants is quite different—and this is one reason there is very heavy emphasis on contracts in the construction industry. The contract for a particular job establishes specific ground rules for each participant within the general framework of the law.

“Interestingly, for all the talk of changes in the law, the law with regard to professional liability of all types—not just architects and engineers, but all professionals—has been remarkably stable. There was a case last year in Minnesota involving an architect's professional liability. The Minnesota State Court went all the way back to a State of Maine case in 1896 and cited the principle there as justification for its own holding that an architect is not liable in the absence of negligence. There are, today, more opportunities for architects to get sued; as mentioned, the demise of the privity concept, and changes in judicial thinking about statutes of limitation. But the basic fundamental principle in professional liability—'no liability in the absence of negligence'—is a concept that is remarkably stable, and a concept which should not inhibit professionals from being innovative.”

And, Mr. Kornblut argued: “The law has traditionally, and still does, encourage professionals to be innovative. But it does not excuse negligence... .”

“If there were liability in the absence of negligence, if there were liability without fault, there would never be an opportunity for any professional to exercise any sort of innovative thinking; the tendency would be always to go with the tried and true.

“But the law does give professionals protection against liability in the absence of negligence. Thus they can be innovative as long as they are not negligent. Negligence is, very simply, absence of care; approaching a project in a less than careful manner.

“One example of being more careful is

“As a developer, I know personally that the rewards for the developer are much greater than the rewards for the professional—and the rewards for an architect or engineer are not commensurate with his exposure.”

—Bernard Breyman

giving the client information, and involving him in the decision process. For example: From my vantage point, I would suggest that after the architect has made a very careful analysis of a new product or system, regardless of the tests that he or the manufacturer have made, that *he* not make the decision to use it. Rather, he should take the information to the client, present it to him, present him with the advantages and disadvantages of the innovation, and let the client make the decision. Let the client be the one to say back to the architect: "Well, what do you think?"

"The architect will and should say what he thinks—but the client should be involved in the decision-making process. It should not be done on a kind of 'this-is-the-way-it's-going-to-be' basis. That is one way to be more careful in dealing with innovation."

**Attorney Kornblut was asked—
Any change of fewer lawsuits?
Fewer frivolous suits?**

Kornblut told the Round Table that "I would tend to doubt that there will be any change that will lower the quantity of lawsuits.

"Any relief from 'those enormous settlements?' When you look at most cases which advance the frontiers of law, where there may be horrendous punitive damages assessed, it is usually very difficult to look at that case objectively and not feel that the defendant had it coming to him. The sensationalized major cases tend to obscure the fact that most lawsuits are not frivolous."

Dr. Zaldastani challenged: "Frankly, I can take any set of documents and build up a case against any party on any kind of project." Kornblut: "I agree that in any set of construction documents, there are things that are less than perfect, that could have been done differently. But then I see the architect who prepared that set of documents *signing* that contract. Reconcile those two realities! And further, because of the complexity of construction, as mentioned earlier, the law gives the professional considerable protection against error or imperfection—though not protection against negligence."

Karl Justin argued again for the small office: "The large office has an attorney on retainer. But a small office has to come up with \$5000 or \$10,000 even to begin to protect itself in a case which may not only not involve negligence—but be frivolous. This problem—along with some other factors—could begin to wipe out a lot of offices, until we're left with small offices which run the risk of operating with no coverage at all,

and large offices that can afford to defend themselves."

Michael Brill cautioned: "Whenever you gather together a group of people who produce things, all lawsuits are seen as frivolous, and anyone who has an accident is seen as a fool or he wouldn't have had the accident to begin with. When Ralph Nader organizes a group of people, the opposite point of view often prevails. . . ."

Mr. Kornblut estimated—and no one at the Round Table challenged the estimate—that "substantially less than five per cent of complaints—complaints that have to be legally defended in or out of court—can be considered frivolous.

"But Karl Justin's concern about costs for a small firm is a very real one. If he has an insurance policy with a \$10,000 deductible, and he doesn't have the cash flow or contingency funds to finance defending himself, he could be put out of business. I don't think, though, that there is anything in our legal system that is going to prevent that from happening; I don't think there is anything in the system that is going to facilitate having a judge declare, 'That is frivolous. I am not going to hear it.' There are today some very well-established principles of law which were doubtless—when they were first presented by some innovative attorney—considered frivolous."

**Attorney William Feldman of NIBS
brought the Round Table up-to-date
on the FTC's proposed
Uniform Product Liability Law**

"This proposed law—which would not be a Federal law, but a law adopted by the states—could avoid a lot of the confusing characterization of claims that used to exist in product-liability cases. Under existing law, the outcome of otherwise identical cases was changed depending on whether the case was brought on the theory of breach of warranty, torts, traditional negligence, or strict liability in tort, which is a hybrid. Under the proposed draft law, three different standards of responsibility are set forth. Defects in design, and defect by virtue of failure to adequately discharge one's duty to warn of danger or instruct as to use, would be treated roughly in the same manner as traditional negligence cases; in other words, strict liability would not attach. You would have to prove in a balancing test that, given technical and economic situations existing at the time of manufacture, the design was not what it should have been, or the warning and instructions were not

adequate. Defects in manufacture would remain strictly with the manufacturer, who remains strictly liable. The other main point of the draft law would be its development of statutes of repose. They are intricate, but, generally speaking, they would end manufacturer or seller liability for defects in products 10 years after the time of their sale."

Attorney Kornblut suggested attorneys for any company producing products or materials for the industry procure a copy of the proposed legislation and "study it very carefully—it has some peculiar provisions. . . ." Attorney Breyman suggested in addition that house counsel for manufacturers get a copy of at least Volume 1 of the inter-agency task force report on product liability. "It gives some good insights into how they came up with this model draft—and the direction that the Federal agencies are thinking and headed. It makes interesting reading, to say the least."

**Having defined the very broad areas of
risk involved in building, the Round Table
focused on ways to share the risk.**

ACEC's Bruce Vogelsinger offered one list:

"The American Consulting Engineers Council has been involved in and concerned for a long time about professional liability. As has been said often during the Round Table, there are indeed risks inherent in practicing as an architect or engineer in today's atmosphere. And the risks are constantly changing. The risks for each project are different, the risks of each client are different, and there are always new risks. For example, we have been alerting our members that the proposed Federal building energy performance standards create some new liability problems as buildings do not meet the calculated usages. And the question is: How do we manage these risks?

"One suggestion we have offered, which is not yet well accepted, gets to Mr. Breyman's suggestion of limitation of liability. Under this system an engineer's (or an architect's) liability is limited contractually to the amount of his fee, or a given per cent, or a certain dollar figure. One insurance company is promoting this concept, and it has proved successful with soil and foundation, and geotechnical, engineering firms.

"Another way to minimize risk is a system of limiting bidders so that the professional does not have to accept the lowest bidder.

"Another is the in-office quality-control and education programs we've discussed.

“Innovation does carry risk. The question is: How much innovation do we really need?”

—Michael Brill

“A problem that hasn't been discussed is professional fees. Architects' and engineers' fees are not high enough today to compensate for the mounting complexities involved with energy and environmental problems—and I think this is a significant point that the professions must address and try to do something about.”

On the question of insurance, Mr. Vogelsinger led a discussion of the growing list of alternatives

“We should continue to explore new ways to insure. Our organization, back in 1971, started an insurance company—the Design Professional Insurance Corporation. This required a subscription of \$1 million worth of stock, but today it is a fairly successful firm. Last year it wrote about \$24 million in premiums and its profits were about a half million dollars. This firm insures about 56 per cent of our members, as well as some architects.”

Architect Alan Schwartzman interjected that some individual architects, starting in New York, are studying this kind of insurance organization. “The ACEC is an organization of firms, of employers, while the AIA is an organization of individuals. But a small group of us became interested in the Design Professional Insurance Company concept, and invited that firm to come and speak to us under the auspices of the New York Chapter of AIA. We found that DPIC had worked well for the architects it insures in Los Angeles. The main thing is a service DPIC offers, a kind of hot line at the early stages of a problem. Without getting involved in a lot of legal fees, the DPIC will investigate a problem at a very early point to try and resolve a particular issue of liability that seems to be arising. The DPIC also insists on a kind of group policing—the principals of firms involved must undertake the kind of in-house quality control others have spoken of, and must attend obligatory loss-prevention seminars. Architects in many parts of the country, as we in New York are, are investigating the possibilities of setting up organizations to insure ourselves in this non-traditional way.”

Mr. Vogelsinger discussed several other forms of insurance: “The ACEC is supporting legislation that would provide architectural and engineering firms the opportunity to set aside a certain amount of money each year, tax-free, as a reserve fund for use in the event of professional liability suits. This would permit more firms to become self-insurers.

“Another approach: One large engineering firm was paying \$750,000 a year in premi-

ums, and decided to self-insure. They did it by means of a letter of credit from a bank. This is, of course, a method available only to firms that are financially well based.”

Having discussed these alternatives, Mr. Vogelsinger pointed out that “There are a number of firms coming into the professional liability insurance field—which is something of a turnaround.” Asked about this, Arthur Kornblut said, “I think it is no more mysterious than that some insurance companies see this is a business opportunity. The firms that are coming into the field are not those who have left previously. In the twenty-seven years that the AIA and the NSPE have been commending a liability program, something like fifteen insurance companies have attempted to write professional liability insurance; sometimes profitably, sometimes not. Right now there are four or five companies who are interested in the business. . . .”

Having developed this list of ways to insure, Mr. Vogelsinger sounded a most serious note: “Several of our state organizations are trying to introduce legislation attacking ‘frivolous suits.’ I hesitate to put on my attorney's hat, but as Arthur Kornblut has said, frivolous-suit legislation is just not an answer. Frivolous suits are not a major problem. The major problem is negligence on the part of the practicing professional—and we have got to admit it. There is negligence out there, and there is poor performance. We would have less problem with liability if we were able to raise the general level of performance of engineers and architects. . . .”

Towards the end of the Round Table, as participants searched for “answers,” Michael Brill went back to basics:

How much innovation do we really need?

“Most of the strategies we have talked about at this Round Table are ‘post-bad-event’ strategies. We've talked about insurance strategies, about statutes of limitation. But we haven't talked much about front-end strategies. Early in this Round Table, there was a lot of breast-beating about the need for innovation, and the realization that innovation involves risk. As I've listened through the day, I begin to wonder: How much innovation do we really need? Mr. Vogelsinger said it first—and he's right—that there is a fair amount of negligence. One might be more gentle and say: ‘Not wonderful work,’ or ‘Not taking care,’ or ‘Not availing yourself of the information that is available for making decisions. . . .’

“In fact, it seems to me, that the demand

for innovative solutions is remarkably low—and often when we generate new and innovative solutions it is not because they are required by the problem. Only occasionally is innovation required to accomplish cost reduction or energy conservation or some other technological goal. Rather, most innovation seems to be required by something inside ourselves. . . .

“There is no reason why we could not enter a kind of classical period once again, during which we really try to take stock of what we know, try to do it better, and try to reduce the amount of information. We are drowning in information; you cannot keep up. One response has been for architects to increasingly give up responsibility to more and more specialists. And that means that there is, frankly, a loss of control. It seems highly probable that the cost of settlements, the cost of property damage, the cost of the legal apparatus we must maintain may be far greater than the so-called cost benefits we get from innovation. Thus. . .

“At least one major strategy that is available to us is to re-think the whole issue of whether innovation is in fact so critical to what we do.”

In his summary, Ezra Ehrenkrantz argued that true innovation requires some special protections, or “seed beds”

“You can indeed work within existing vocabularies to come up with new imagery. That is probably what happens—and what should happen—in the majority of cases.

“But we sometimes do need to ask for new products or systems to be developed. And when we do, we shouldn't do it capriciously, or without a budget to do it well. Especially for the manufacturers or producers involved, but also for the professionals, I think we need to look for opportunities to provide appropriate test beds. I think wherever there are government funds that go into projects or the support of projects, it becomes appropriate to utilize some of those funds specifically for test projects. That vehicle can be provided in a number of ways.”

“At the same time, it is equally important that every project is not run that way. As we continue to use existing vocabularies, we do have to move toward more systematic testing. Every time we take a familiar product and use it in a new way, we should study how those components work within a new system. This requires work not just in development, but in a continual request to industry to report on precedents where materials and

“ I find our culture’s limits and definitions of risk just fascinating, when you consider that if you live in Amsterdam and drive your car off the edge of a canal, they fine you! ”
 —Roger Lang

products have been used together in a new way—and have worked.

“To comment on the need for redundant systems—not counting too much on any one system. That sounds extremely sensible; but in fact the marketplace pushes you more and more to eliminate redundancies in the cause of lower costs. Perhaps the biggest problem within the professions and the industry is not coming up with definitive cost criteria at the beginning of a job that covers the contingencies. A real estate operator knows where his bottom line is and can rent all the space before he signs the option he has taken out on the property. The architect has the same kind of obligation, I think, to his firm and his personal welfare to be sure—before he moves from programming to schematics—that the bottom line is an acceptable one, financially and from the point of view of risk. There may be times when you simply cannot justify taking the job—no matter how much you ‘need it.’”

Architect/builder Lang’s final word: the definition of risk depends on the society—and has to be shared

“If you live in Amsterdam and drive your car off the edge of a canal, they fine you. And there are no OSHA railings. I think that tells us quite a lot about the definitions our culture has for the concept of risk. A lot of the risk is self-inflicted from the total society’s point of view.

“How can we share or minimize this risk? As has been said well, the demand for innovative solutions is remarkably low. And the demand for idealism is decreasing fast: idealism varies in direct proportion to one’s distance from the problem. Perhaps this is all right; because I think we are now starting to try to solve the right problems, the real problems, rather than the arbitrary problems we might have thought were extremely important ten years ago.

“Nonetheless, there are risks of innovation in almost any building project, and the only real protection, it seems to me, is to share the risk by effective communication with everyone on the building team. It has been said for a long time that architecture is an old man’s business because it takes so long to learn enough to act competently. I think if anything it is a superman’s business today, and the only way you can really assure maximum protection and minimum risk for everyone involved is to involve everyone. It is vital that no one cover up anything in the name of innovation.”



Michael Brill
 president
 BOSTI, Inc.
 Buffalo



Ezra Ehrenkrantz
 The Ehrenkrantz Group
 New York City

These building-industry manufacturers and others audited the Round Table:

- Mario J. Catani, director,
Portland Cement Association
- Kenneth Frobert, director, advertising & design
American Olean Tile Company
- Frank Helle, market supervisor, Monsanto Company
- James Huffine, manager, regional corporate marketing
Johns-Manville Sales Corp.
- Robert S. Knight, division manager,
Matthews International Corporation
- Jack G. Leckie, Jr., residential sales manager
Aluminum Company of America
- Lou Methfessel, manager, advertising
American Olean Tile Company
- Robert W. Moorman, market manager—coil,
Glidden Coatings & Resins
- Heinz J. Pak, industry representative,
U.S. Steel Corporation
- Fred Petersen, managing director,
Metal Building Manufacturing Association
- David M. Smith, vice president and marketing,
Vernitron Medical Products
- Ron L. Warwick, vice president and general manager
Amarlite Anaconda Aluminum
- Robert F. Wellner, assistant manager, sales engineering
Bethlehem Steel Corp.
- James Westerberg, architecture
and construction services
Glass Division, PPG Industries, Inc.
- Armen D. Yazujian, sales program manager
Thiokol Corporation Chemical Division

Dr. Zalastani made his final point on behalf of the owners: That it is the owner who should decide on risk

“I am a trustee of a small college which has undertaken a building program. So in that sense I can speak as an owner. And if you ask me whether I want to take a risk, I would say, ‘No. I just want a good building.’ The owner is the one who has to have the money. He retains the architect, and sometimes the builder. Then the engineers are retained, the manufacturers become involved. In that process, who initiates in the innovation? As we have said before, it comes from the heart; the architect feels he has something to offer and he often takes the risk of innovation without even sharing it with the owner—because very few owners are really willing to take risks. But it is the owner who should really define the need.”

Michael Brill: “I sense there are only three strategies to deal with the issues of risk. . . .

“Two of them deal with ways to try to reduce the possibility of failure. One is to accept the fact that you will deal with less information, and therefore, deal with less innovation; refining what is most familiar to you, reserving innovation for only those situations in which innovation is absolutely required. Another model for reducing risk is deciding what kind of a professional you really are—and if you are a high-technology professional you can try to attract those clients or those situations which are innovative by nature, and you charge fees which are appropriate to the kind of service you provide. Under those two models, you either risk less, or you get a lot smarter so you can think in advance of all the possible failures and make them go away.

“The third model is that you accept a certain amount of risk and failure, but—as we have discussed at length—you devise a method that equitably shares the risk. That is not a rich array of options, but there are obviously a lot of individual styles and mechanisms within each of those. . . .”

And so the day, and the Round Table on Risk-Taking in Architecture ended. Without a stirring resolution. With perhaps as many questions raised as were answered. But with a lot of thoughtful comment from all parts of the industry out on the table where all of us can think about it and make our own choices. Which, perhaps, is all that a Round Table can do. —W.W.

TENT STRUCTURES DESIGNED TO ENDURE

The visual excitement of membrane roofs, supported by poles, or by arches or by air has enchanted many an architect. But the growing acceptance of these roofs for permanent buildings is based more on their favorable construction and energy costs. The translucency plus high reflectivity of the coated fiberglass fabric yield energy benefits that were pivotal to its application for a gargantuan terminal for pilgrims at the Jeddah International Airport in Saudi Arabia, and for an eye-catching Bullock's department store in California.



David Cron

A prototype of the Haj terminal tents comprising two full-size units was installed at Owen-Corning's Technical Center in Granville, Ohio, to simulate actual roof installation procedures,

and to test the structure under a number of adverse conditions. It also allowed the structural engineers to check the reliability of the computer programs used for analysis. The

photo gives a feel for translucency and scale, though the fabric will bleach whiter, and the prototype is 50 ft closer to the ground than the Haj units at Jeddah.

At the airport in Jeddah, Saudi Arabia, the world's largest fabric roof will shelter pilgrims on their way to Mecca

David Cron

For a terminal to shelter Moslem pilgrims on their way to religious rites at Mecca and Medina, Skidmore, Owings & Merrill first conceived a series of 1,500 concrete umbrellas 60 ft or so apart. But that approach produced a good many negative aspects: 1) the umbrellas would take a long time to build; 2) with daytime temperatures ranging from 110 to 130F, the concrete would radiate a heat unbearable to the 30,000 Hajjis who will use the terminal daily; 3) the 60-ft column spacing would appear niggardly; 4) the umbrellas would block off light and air.

By substituting fabric tents for concrete umbrellas, the architects not only eliminated those negatives—they evoked the tents that have sheltered Hajjis for centuries. There is a vast difference in scale, however. The fabric tent modules are 150 ft square and soar from 66 ft at the corners to 110 ft at the center support rings.

The enormous undertaking would have been impossible without a number of advances in the state of the art of tent-making over the last few years. Durability demanded a membrane material with a life of 20 years or more. The requirements were met by a fabric woven of Owens-Corning Fiberglas yarn for strength, and coated with Du Pont Teflon for protection.

The design required the application of sophisticated engineering skills and computer analysis to predict the roof's behavior when tensioned and loaded. For one thing, the structural integrity of the membrane has to be

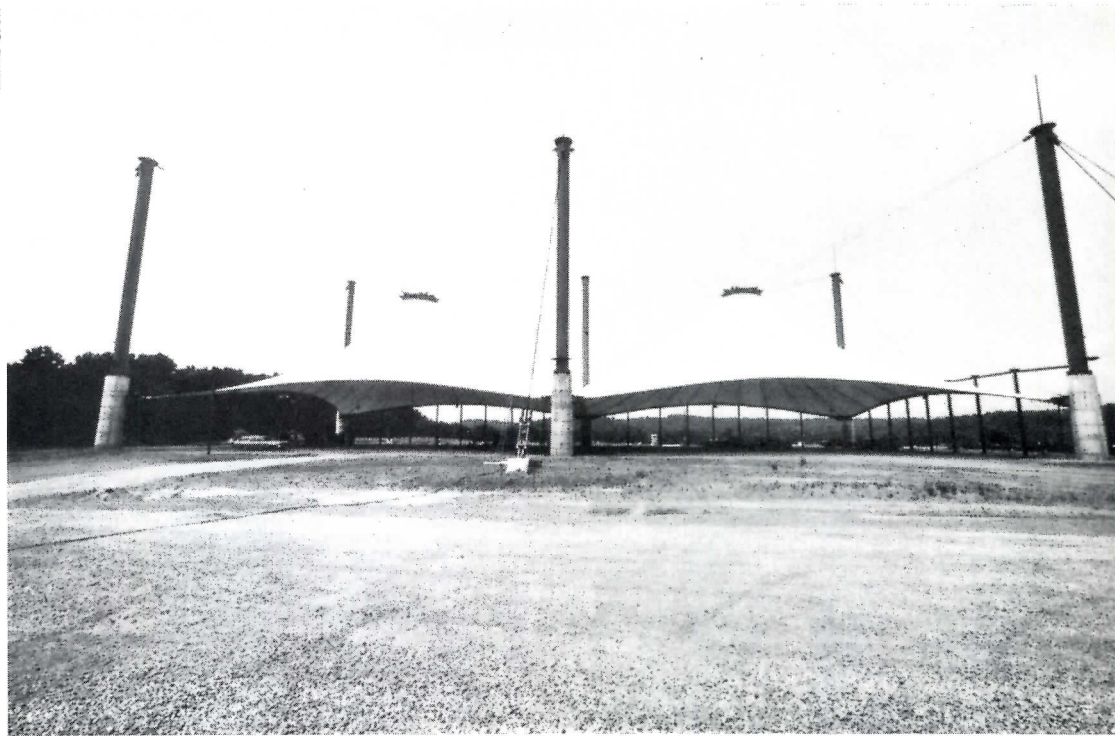

The prototype is 50 ft lower than the Haj tents to reduce costs and make tests easier to conduct. The tent units are suspended from four pairs of cables attached to "skyhook" pylons at the high point and sloping down 40 ft to 16-ft diameter rings at the tops of the tents. Stabilizing cables run from the rings down to tent corners.

The Haj Terminal of the New Jeddah International Airport comprises two identical structures, each with 105 tent units 150-ft square. The tents are grouped in five modules of 21 units for each structure. The two shelters, each with 105 one-half acre tents, cover 105 acres, an area equivalent to 80 football fields. Two four-story air-conditioned customs buildings will be built on the apron sides of the two shelters.

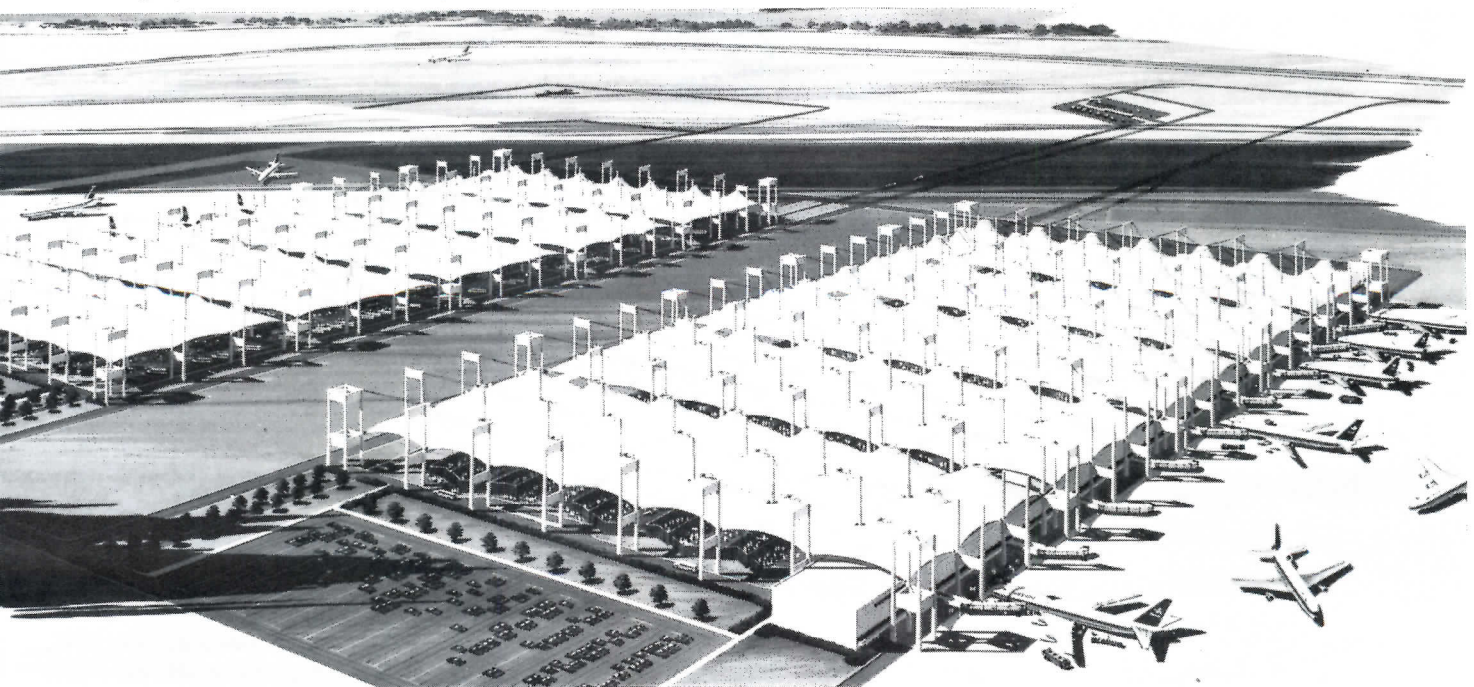

Leonard Sorensen

G. Scott Gilkey

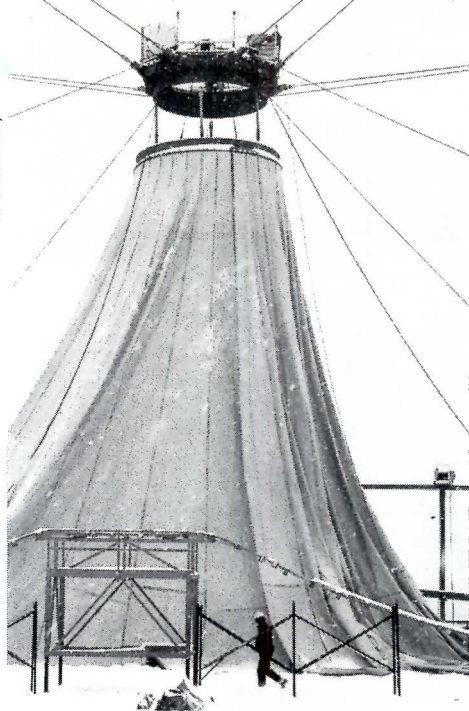

Because of the very tight construction schedule for the Haj project, Owens-Corning had to proceed with erection of their prototype structure during adverse weather conditions. Here the fiberglass fabric has been hoisted by the lower half of the center ring, but edge and ridge cables still have not been attached.

Here, in better weather, edge cables are in place. For tent edges that will abut other tents, the restraint condition was simulated in the prototype by fastening edge cables to the steel frame seen in the right foreground.

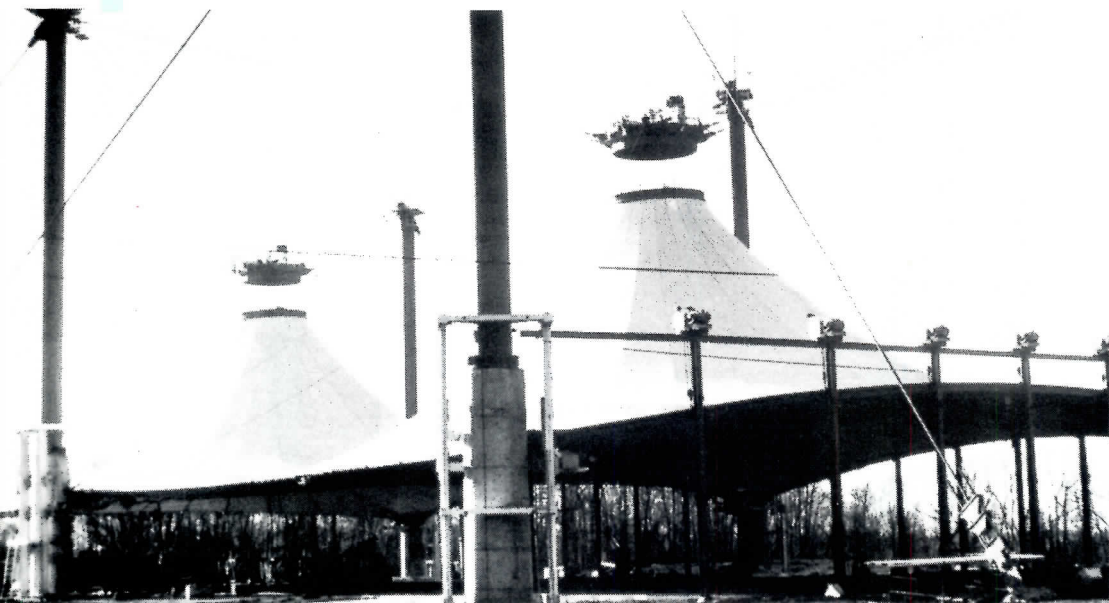

assured. And for another, the roof-panel fabricator, Walter Bird of Birdair/ChemFab needed reliable predictions of stress in order to design cutting patterns that will prevent wrinkling when the roof is drawn taut.

Lastly, it was necessary for organizations such as Owens-Corning's contracting division and Birdair to develop sophisticated erection techniques and equipment commensurate with time and cost constraints.

Though a center-column support system would have been more efficient, SOM chose the perimeter pylon system to gain free space. But in addition, this approach simplified erection because the fabric could be laid out under the center support rings. And as still another benefit, the open ring at the top provides the mechanism for venting stagnant air via stack action.

This approach, however, made structural design more difficult because it created an interactive system that required a very large computer system to solve. This computer analysis was conducted by Geiger Berger Associates, who, along with URS Corporation, were structural engineering consultants to Owens-Corning, the contractor responsible for engineering design in accordance with the "design-construct" bid documents. SOM, under partner Fazlur Khan, performed a structural analysis themselves, which they cross-checked with Geiger Berger results.

Owner: International Airport Projects, Ministry of Defense and Aviation, The Kingdom of Saudi Arabia. Architects and engineers: Skidmore, Owings & Merrill, Chicago and New York. Structural engineers: URS Corporation; Geiger Berger Associates. Fabric roof system contractor: Owens-Corning Saudi Contracting Services Co. Roof fabric technical consultant: Birdair Structures, Inc. Fabric roof panels: Owens-Corning Fiberglass Corporation. Structural steel: Mitsubishi Corporation; Nippon Kokan K. K. Structural cables: Drahtimpex (Brussels); CCG (France).

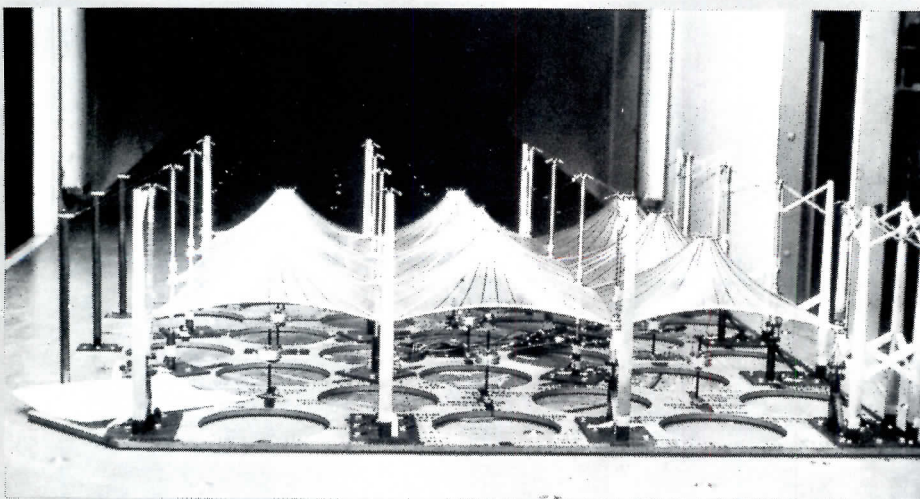

Wind-tunnel tests on a structural model conducted at the University of Western Ontario, simulating 100 mph winds, indicated the structure would not be bothered by flutter.

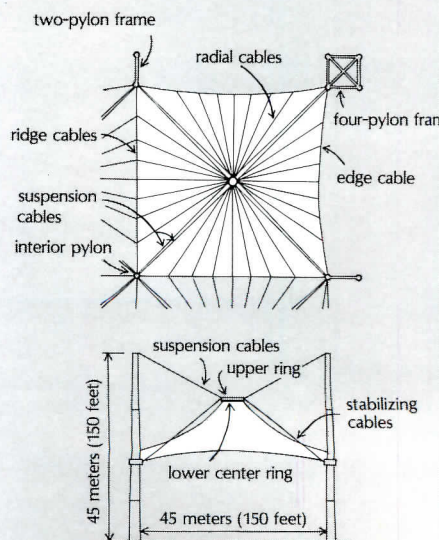

The engineers checked the structural behavior of the tent components during erection of the prototype in several ways. A simple, hand-held device allowed them to measure the average stress in the fabric anywhere on the surface. But the principal measurements were made by hundreds of strain gauges, strain sensors and load cells attached to the fabric, cables, and rings of the two

tent units. The strain gauges on the fabric and their wiring for connection to computer monitoring apparatus can be seen in the photo at the beginning of the article. The testing verified the validity and reliability of shape and analysis computer programs developed by engineers Geiger Berger Associates, consultants to Owens-Corning. The shape and prestress level of all components on the

prototype agreed within 3 per cent of the computer prediction. The computer programs were so sophisticated, says Horst Berger, that the engineers could even simulate the effect of a fabric rip. On the prototype, Owens-Corning monitored response to an actual fabric tear, a broken radial cable, and—the most catastrophic failure—a broken main suspension cable.

G. Scott Gilkey

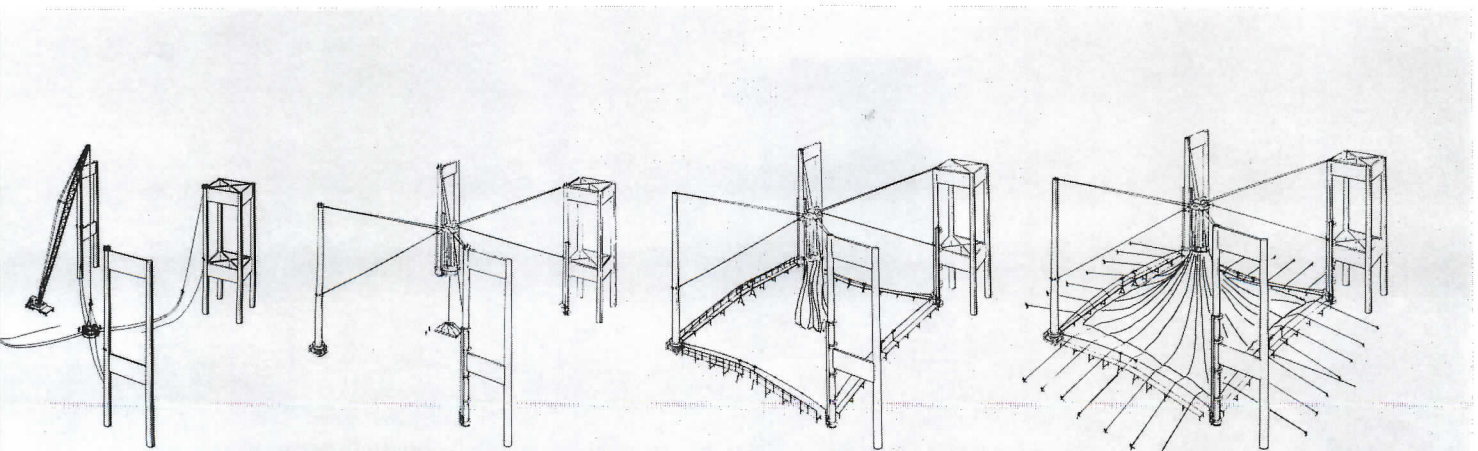

The corners of each tent are fastened to pylons, while the top is attached to a large center ring which has upper and lower sections. The rings are held up by suspension cables and steadied by stabilizing cables. During erection, a crane hoists the joined rings to a

height of 110 ft. The lower ring is then released and let down by hoist and attached to the fabric in a crate. After the fabric is lifted from the crate, the edges are pulled outward (like an umbrella being opened) to be attached to edge cables for the exte-

rior sides and ridge cables for the interior sides. Workers then lace 32 radial cables into vertical sleeves. Lastly, hoisting mechanisms raise the lower rings of 21 of the tent units simultaneously until they meet the upper rings, and then are bolted.

Fabric membrane roof in northern California lights a store naturally and saves energy

Paul Heidrich, chairman of Bullock's of northern California, told Virgil Carter of EPR architects and planners that he wanted "something more interesting and economical than a black box requiring tremendous amounts of energy" for the company's new store in San Jose. Presented this challenge, EPR developed their design based upon the following guidelines: 1) the store should be based upon interior merchandising concepts; 2) the store should find new ways to conserve energy; 3) the store should act as a prototype for "breakthrough" solutions, developing a completely new type of shopping environment suitable for much larger scale.

Early in design development, engineer Horst Berger suggested several different means of support for a fabric roof, including a four-peaked tent solution and cross arches. Initial cost studies indicated that arches would be less expensive, and, at the time, the owner had reservations about the visual dominance of a pole-supported solution. But now, after enthusiastic customer response at the San Jose store, Bullock's is going ahead with an eight-peaked tent for another large store in the Bay Area.

An advantage of the cross-arch solution is that the arches are stable themselves, and the fabric can ride free over their top surfaces. No cables were needed except edge catenaries which help stress the fabric evenly when jacks are applied.

Most of the roof has two layers of fabric—a somewhat conservative response to thermal, acoustical, and fire-protection concerns—whose varied geometrical pat-



Joshua Freiwald

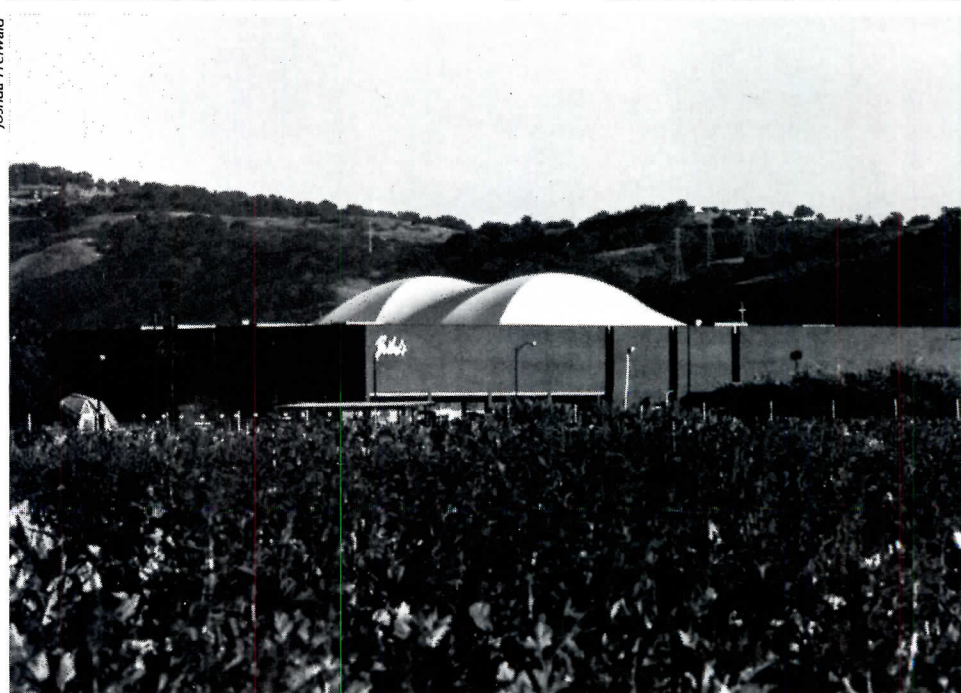

The undulating fabric membrane structure hovering over Bullock's Oakridge department store, and covering one-third of the roof, gives the store unusual distinction in a San Jose, California, shopping center. The application of the membrane roof to this 150,000-sq-ft, two-level store is said to be the first for a retail structure in this country.



Structural support for the fiberglass fabric membrane is two pairs of crossed, laminated arches that rise 22 ft, span 96 ft, and are 32 ft apart. Hand-operated winches hoisted the single-piece, 18,000-sq-ft fabric membrane up over the arch frames. To prevent abrasion of the fabric, a strip of the same material was placed on the top surface of the arches. Originally, five pairs of arches were considered, but to cut costs, the structural engineers, Geiger Berger, suggested eliminating three of five cross-arches and increasing the capacities of the remaining two. There are no cables in the fabric except edge catenaries.



The membrane was stressed by means of hydraulic jacks. It was attached to an encircling concrete curb with a special two-plate clamping system.

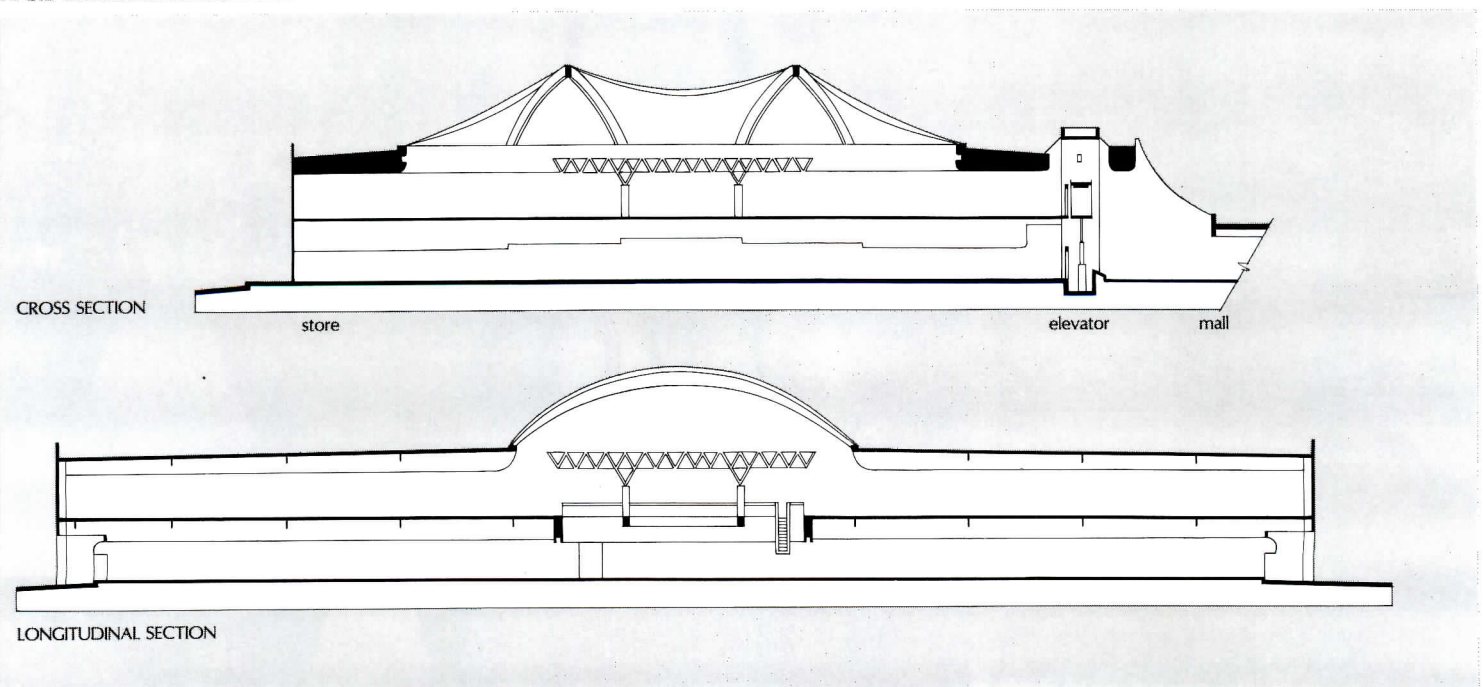

terns and light and darker translucencies provide counterpoints of visual interest. The double layer gives added thermal insulation as a measure to avoid condensation, though the engineers think this can be avoided with proper ventilation. The inner layer is a different fiberglass fabric than the outer layer, and is sound absorptive. The inner layer also gives a second line of defense against burning embers carried by wind (fire officials required the fabric be subjected to the burning brand test used in California, though the engineers feel the test is not meaningful as the brands slide off the surface at angles of 16 degrees or more, according to Berger). Fire officials also thought that the double-fabric layers would trap more heat in the vicinity of sprinklers so they would respond faster in case of a fire from the inside.

On the energy side, the reflectivity of the fabric helps reject solar heat from the outside, but its translucency (16 per cent for a single layer and 7 per cent for a double layer) allows high lighting levels and a vibrant interior appearance. In the climate of northern California, stores could function with little energy for heating and cooling, according to studies made by the engineers.

Cost of fabric roofs, in place, today averages about \$16 per sq ft, in contrast to \$9 per sq ft for a conventional flat rectilinear steel frame. But, say the designers, in addition to the energy and marketing values of the fabric roofs, advantages include being able to provide mezzanine space, having less exterior wall surface, and having no built-up roof.

BULLOCK'S OAKRIDGE, San Jose, California. Owner: *Bullock's of Northern California*. Architects: *Environmental Planning & Research, Inc., Virgil R. Carter, project architect*. Fabric roof designer, structural engineer and mechanical consultant: *Geiger Berger Associates, P.C., Horst Berger, principal-in-charge*. General contractor: *Swinerton & Walberg Co.* Fabric roof fabricator: *Birdair Structures, Inc.* Fabric roof contractor: *Owens-Corning Fiberglas Corporation Fabric Structures Unit.*

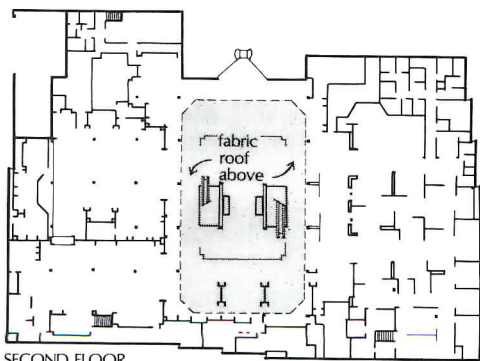

The fabric glows from transmission of daylight, which is suffused throughout the covered space, providing a pleasant ambience while also reducing the use of electric lighting: Bullock's expects to save \$18,000 a year by using daylighting.



A small space frame at the top of the escalator identifies the second level, and is directly under the fabric roof. Besides serving as a focal point for the top floor, the space frame was used to mount lighting equipment. Catenaries of the upper and lower layers of fabric can be seen in the photo below, as can the ties between arches and sprinkler piping.

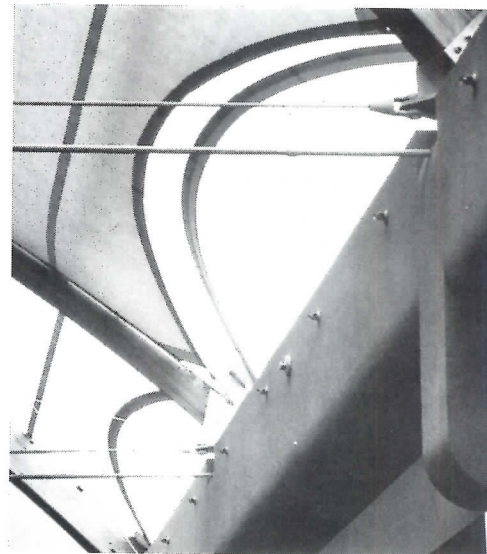

A wide-angled view of Bullock's top floor shows the full support structure of the roof—the crossed pairs of arches, hinged at the top, and braced with struts and tie rods, and the concrete curb around the perimeter of the opening. The space frame incorporates adjustable downlights for accent lighting and uplights to bathe the underside of the roof with

light at night. Most of the roof has a double layer of fiberglass fabric, except for small areas between each pair of intersecting arches. Though this reduces transmission to 7 per cent, as compared with a 16 per cent average for a single layer of fabric, lighting nonetheless averages about 450 to 550 footcandles, enough for indoor plants.

Bill Apton



Because of the enthusiastic response of the public to the stimulating environment of Bullock's Oakridge, and because of the promise of reasonable payback through energy savings, the firm's management was persuaded they should use a total fabric roof for a new store at Mariner's Island in the Bay Area. For the roof structure, Horst Berger of Geiger Berger proposed an octagonal design scheme, 336 ft in diameter with a 70,000-sq-ft fabric roof on eight interior piers 50-ft high, with the center of the roof 35 ft above ground level. Owner: *Bullock's of Northern California (Paul Heidrich, chairman of the board)*. Architects: *L. Gene Zellmar Associates*. Store planner: *Environmental Planning & Research, Inc.* Engineers, roof design and design consultant: *Geiger Berger Associates*.

Horst Berger

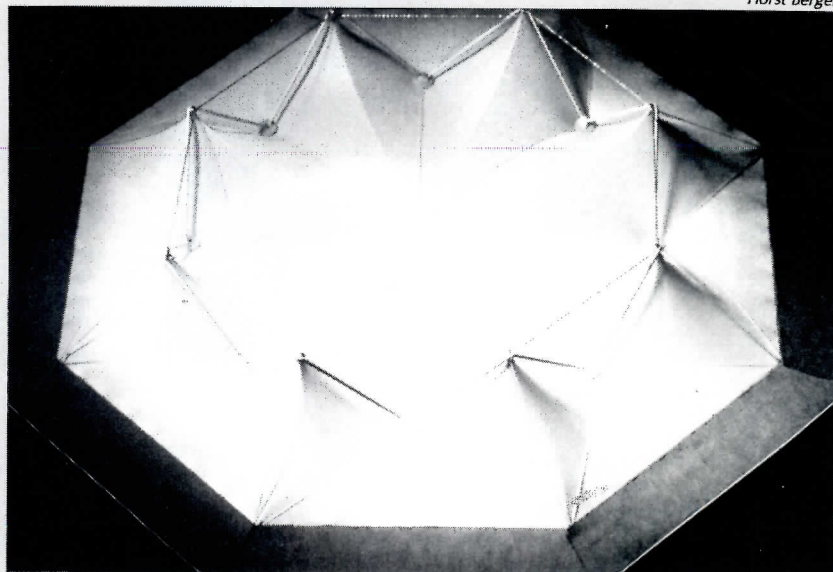

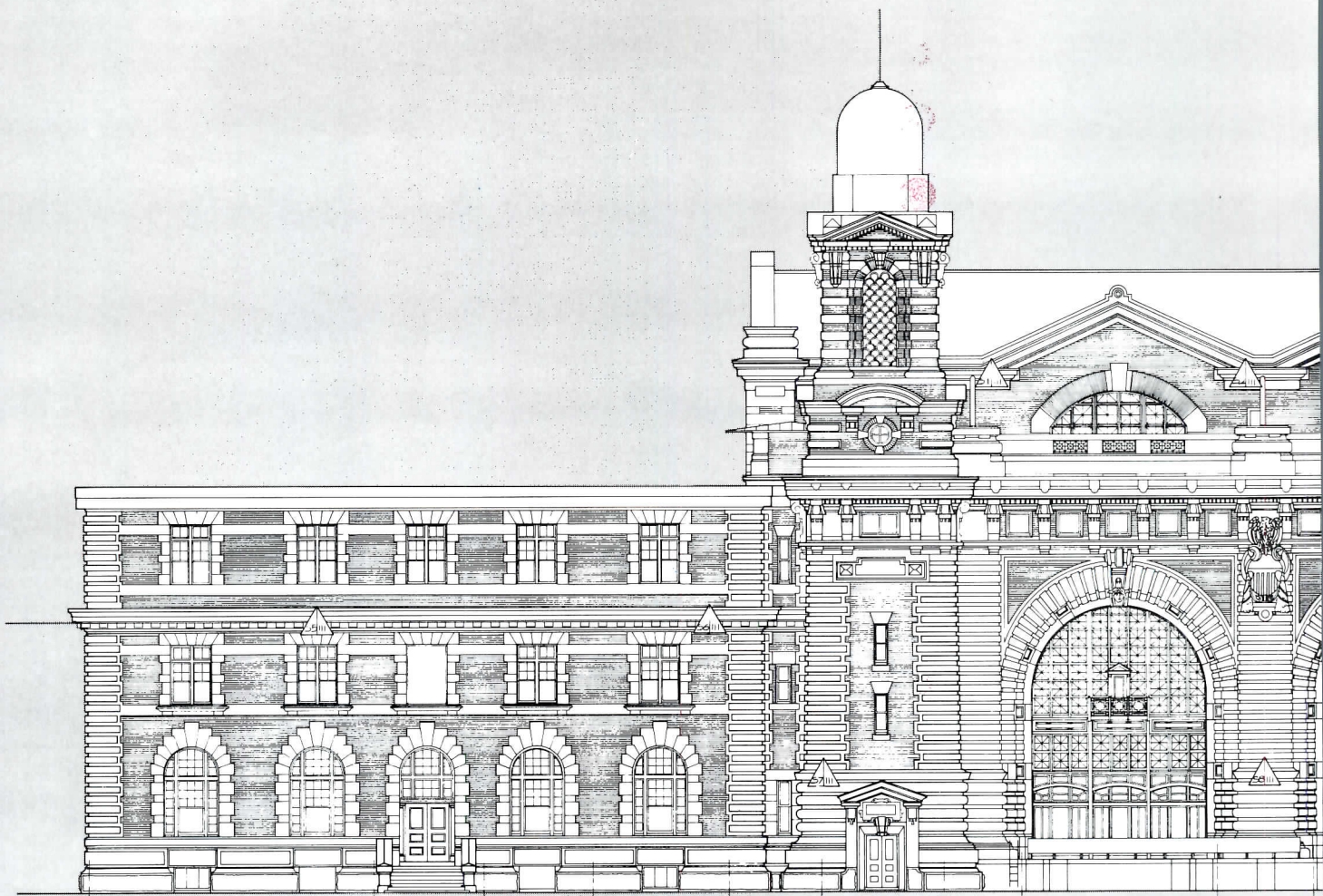

The Ehrenkrantz Group: Bridging the Technical Barrier

Ten years ago Ezra Ehrenkrantz with a small cohort was riding the crest of a wave that many then saw as the future of the building industry. His bulldog advocacy and techno-organizational skills were recognized as the motive force behind the first meaningful forays by the U.S. into the art and science of systems building, the California-based School Construction Systems Development (SCSD) project and its acronymic offshoots.

There has been a sea change.

Today, expanded and relocated in New York City and reconstituted as The Ehrenkrantz Group, the cohort is casting its nets wide and deep, building a diverse practice while taking the lead in articulating a process-oriented, problem-solving approach to planning that some (again) are ready to bill a new wave. Maybe. Or perhaps the approach might more aptly be styled a return to that promise of the earlier decade, a bridge over troubled waters.

BY MARGARET F. GASKIE

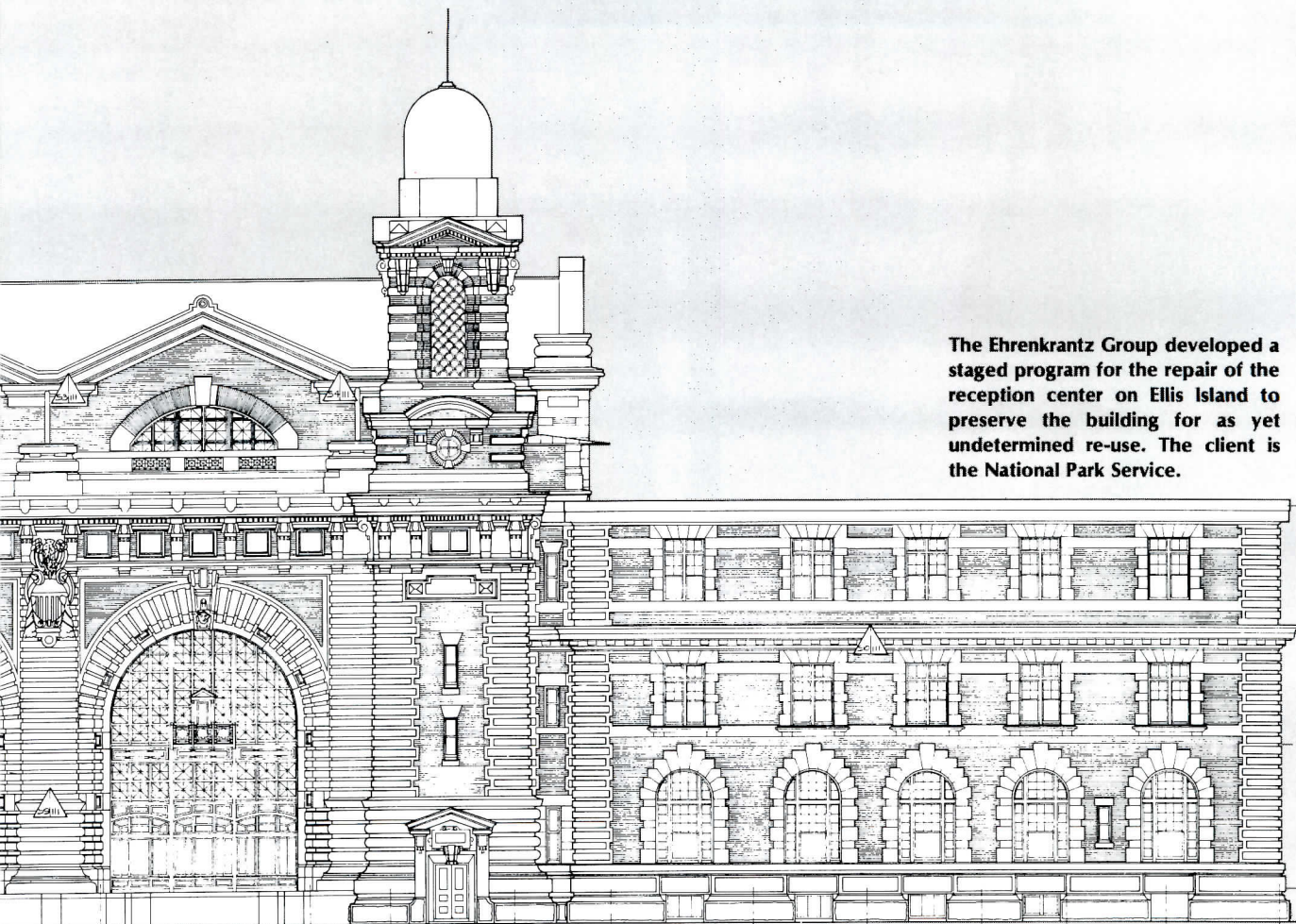

The Ehrenkrantz Group developed a staged program for the repair of the reception center on Ellis Island to preserve the building for as yet undetermined re-use. The client is the National Park Service.

Drawing by Susan Chin

Ehrenkrantz's one-word explanation for the removal to New York—"Reagan"—is only partly facetious. As the '60s drew to a close, so did the heyday of systems development with which his team had been so intimately, if not exclusively, identified. It was a time for consolidation and application via an architectural practice centered on the educational facilities that had been the focus of the development efforts—a logical base, but one that proved precariously narrow under the pressures of demographics, the early '70s recession, and the radical surgery undertaken by the new state administration on the public's educational purse.

"Go East, young man" seemed good advice. A toehold was offered via a joint venture requiring a New York office, which, manned by top principals who seized the opportunity to test the waters for other work, became a beachhead and finally the center of operations. In 1973 the New York expeditionary

force became the headquarters staff of The Ehrenkrantz Group, leaving behind as an affiliated outpost the original California-based Building Systems Development Inc.

From a nucleus of about 18 the office has grown to a "team," asserts the firm brochure, of more than 74 "interdisciplinary professionals representing an unusual breadth and depth of skills, knowledge and experience."

The growth has been deliberate, determined, and fiercely directed to diversity. Vowing never again to be "hostage to a single building type," Ehrenkrantz has concentrated on bringing the firm to a position from which it is poised to tack in a number of directions as the prevailing winds of the building industry shift and quarter.

The firm's present range of projects and expertise seems at first glance both improbable and disjointed: energy studies, building conservation (encompassing work variously defined as preser-

vation, restoration, renovation, conversion, stabilization), systems development, building technology, computer-based program analysis, plus a range of building type specialties—criminal justice, education, housing, health. Moreover, actual work in these areas runs from design back through programming to feasibility studies to development of codes and standards to collection and analysis of raw data. But both the diversity and the high proportion of what one principal describes as "work whose product is not a building" take on a certain inner order in the light of the firm's evolution.

The earlier (and original) vehicles for branching out from the confines of a single-specialty practice were joint ventures through which the fledgling group acquired a seasoning on large and various projects it alone had neither the track record nor the staff and resources to produce. Meanwhile, though, the shaping of the firm to its present (but one suspects far

from final) configuration had begun through a partly conscious, partly fortuitous combination of building on proven strengths—notably the research capacity and orientation honed through the systems work—and of grafting on new capabilities. Ehrenkrantz cites three examples that illuminate the process.

"When the energy crisis began to erupt, we felt that was an area in which we had some credentials, and we started to go after projects." As it happens, the firm's energy credentials were at the time rather slim, resting primarily on Ehrenkrantz's very early interest in what was then called building climatology and in the innovative but tentative approaches to energy efficiency embodied in the SCSD project, which included the analysis of mechanical systems on a life-cycle cost basis.

The firm's research credentials, however, in the person of William Meyer, an alumnus of the original team and now The Ehrenkrantz Group's vice president in



H. Bernstein

Restoration of the terra cotta cladding on the Woolworth Building in New York City, a much-loved histori-

cal landmark, exemplifies research activity of the Ehrenkrantz firm in building conservation technology.

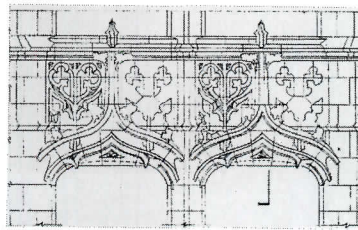

The entire exterior, except for the first four floors, of this 52-story building, designed by famed architect Cass Gilbert, is in matte-finished cream-colored terra cotta. After more than six decades of service, the terra cotta surface needs refurbish-

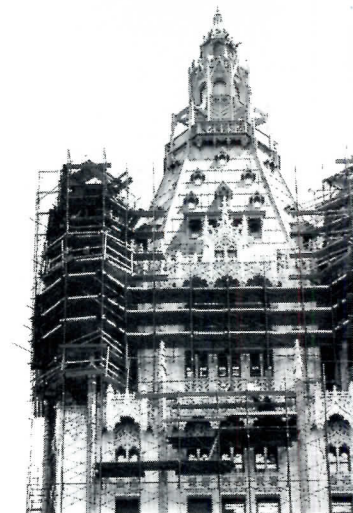

ing, or replacement where the pieces are badly cracked. Failure is manifested by cracking and spalling of the glaze, and cracking caused by moisture absorption, thermal expansion, corrosion of the steel anchoring system, and wind movement.

charge of research activities, were impeccable. Under his direction, projects were sought, brought in, carried through, and The Ehrenkrantz Group had evolved a new and timely area of expertise.

"In restoration, we took the route of conscious acquisition."

Specifically, when the contracting business of a design and construction firm engaged in historic preservation floundered, "We bought out the design side and guaranteed a home for a cadre of people who had developed their own reputation and ongoing effort." Now a subsidiary of The Ehrenkrantz Group, Building Construction Technology operates out of Nashville and Washington, D.C., as a non-architectural consulting firm specializing in building conservation. And key members of the cadre work out of the New York office, under the guidance of restoration architect Theo Prudon, forming the nucleus of an in-house authority for The Ehrenkrantz Group's own considerable activity in the field.

"New areas just evolve now in a very natural way—what we really do is back people."

Kenneth Ricci, who joined the firm as a vice president after a year's "trial marriage," in effect continues his previously established one-man practice in the planning and design of criminal justice and correctional facilities under an enlarged umbrella. "I think," Ricci says, "that the group at the time had targeted criminal justice as an attractive growth area. This arrangement expands my resources but gives me the degree of autonomy and entrepreneurial freedom I need to operate under."

"Our real concern is to develop a mix of people and disciplines that gives us muscle in a whole spectrum of different areas."

The flaw in examples like those Ehrenkrantz cites is that while they may illustrate the various routes of extension and accretion by which the firm has evolved and diversified, they describe only the barest outlines of the resultant entity.

They leave, for example, missing persons—most conspicuously the nucleus that from the beginning formed the backbone of the firm's operations, guiding its growth incrementally toward its present estate by individual effort and mutual motivation.

The roster includes Peter Kastl, like William Meyer one of the original emigres, who has kept tuned the systems string of the firm's bow. Responsible for systems development per se, as in the case of that commissioned by the General Services Administration for a group of Federal office buildings, Kastl is concerned too with expanding the "systems approach" into a rational process embracing existing building technologies and thus capable of serving as an integrative resource for a wide variety of the firm's projects.

William Meyer, as noted, is in charge of research activities but is quick to emphasize that these are not pure research in a scientific sense, but applied. "We are not testing theories so much as evaluating and improving on

new products and technologies." A special effort is made, he adds, to see that the knowledge gained through the research function becomes part of the general body of knowledge that the office operates from—the most notable example being the work in energy which has become part of the vocabulary drawn on for virtually all building projects. In this way, Meyer says, "Some of the research becomes essentially in-house consulting that supports other areas of the firm."

Carl Meinhardt, vice president for design, joined the New York office as soon, he says, as there was in fact an office and a principal design role to be played. Coming from a background of work with "really very strongly building-oriented, design-oriented offices," he provides The Ehrenkrantz Group needed weight in that domain. "But I had always had an interest in process as well as design issues and had come to feel that the traditional approach to design lacked adequate appreciation of the interaction between all the

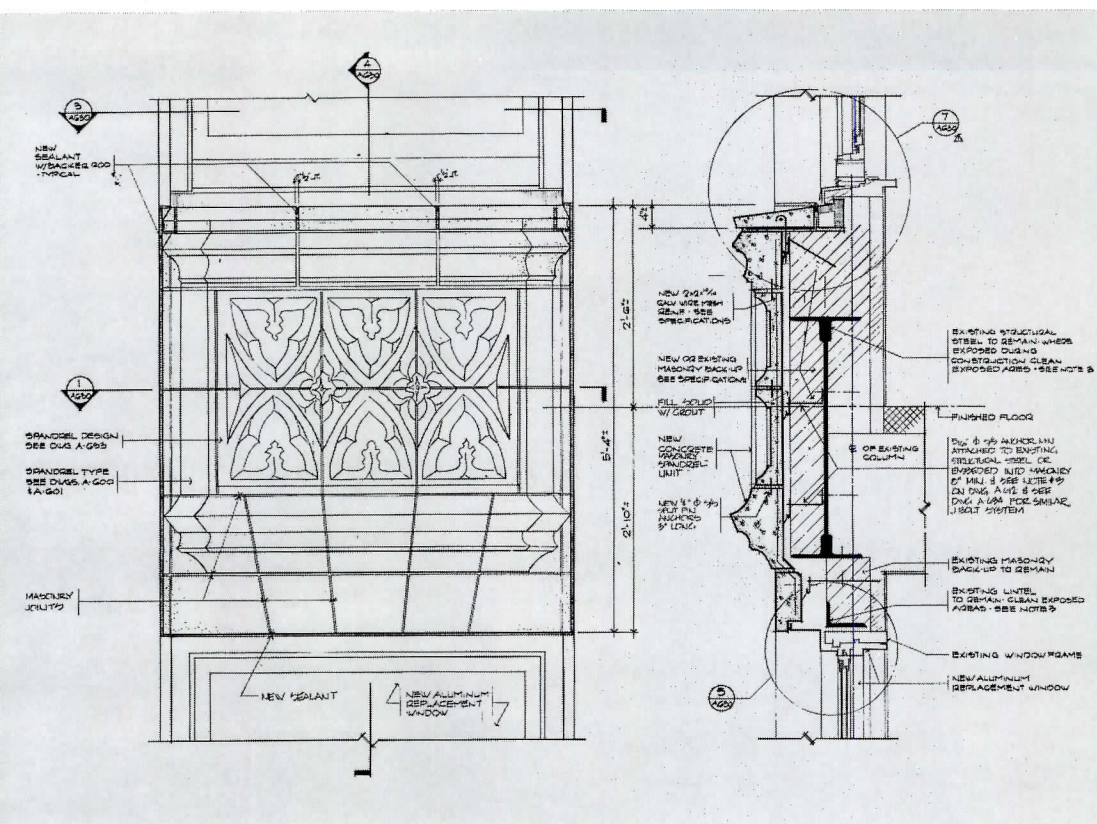

These drawings are performance details illustrating one option for repair of the facade. For example, they call for a new precast concrete

spandrel, painted to match the original terra cotta, stainless steel anchoring pins and anchorages to the structural steel, cleaning and paint-

ing of steel spandrel beams and lintels. New double-glazed aluminum windows would replace wood windows sheathed in bronze.

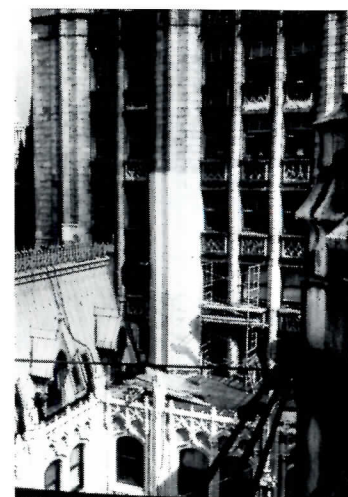

A portion of the terra cotta was cleaned to experiment with protective coatings and replacement materials. Structural engineers are Wiss, Janney, Elstner and Associates; construction managers are Turner Construction Company.

different parts of the building, how they come together, and what happens to the building as it is used. Too often, the architect begins with a concept and the user's needs have to be shoe-horned to fit. The concept here of a unified interdisciplinary approach to the whole building process meshes very well with my own interests."

Vice president Fritz Rehkopf, another early recruit, is the firm's financial and administrative officer. His role, however, extends well beyond that of a glorified office manager. An architect with a practical background in systems applications via the second round of SCSD schools and a self-professed generalist, Rehkopf functions in large degree as alter ego to Ehrenkrantz in questions of management and long-range planning. "I see my role as working with Ezra in developing strategy on a day-to-day basis, whether it involves hiring or the work we pursue or how we solve a problem technically. Lately we have tried to be much more specific about what we

want to do and where we are headed."

"We've tried to develop core capabilities in certain areas, but we've also tried to leave the lines open for people to switch from area to area."

The firm characterizes itself loosely as a triad of across-the-board competencies—in design, in research and in development, which Kastl, whose bailiwick it is, prefers to term building technology. ("And then there's Ezra," muses Meinhardt. "I guess you really have to call Ezra the fourth component.")

These are augmented by the quasi-autonomous fiefdoms of the in-depth experts in particular building types, a tribe the firm would like to see increase—given, Ehrenkrantz qualifies, "the right opportunity, the right people," to expand the office's capabilities into new markets without a disproportionate drain in terms of up-front investment.

Some of the principals bristle at the "trendy technocrat" image they see as lingering over the

firm from its one-note system days. Rehkopf is at pains to note that, common impressions to the contrary, the firm is made up of architects, not "industrial engineers or acousticians or economists or plumbers." According to his location, the firm is with few exceptions composed not of specialists but of generalists with special strengths. "Any of the senior principals is capable of going in many different directions. But we all know our limitations, so we draw off one another to round out our own experience."

On each project, three key roles are defined: technical management, project management, and principal client responsibility. The last role is the most self-evident and is usually, but not always, filled by the person who brought in the work. Project management, too, is the usual task of overseeing production on a daily basis, with the added chore of closely coordinating the other two roles. It is the technical management function that formalizes the concern for synthesis,

representing, Meinhardt says, "the office overview—the quality control factor."

"The research discipline and the generic knowledge they produce are the elements that link every project."

Given the pre-eminence of extra-architectural projects among the firm's list of completed and ongoing commissions, any self-respecting devil's advocate must query the extent to which vocal emphasis on research and development as co-equal with design reflects virtue made of necessity. Do the lads protest too much?

Certainly when the firm was born again in its New York incarnation the new boys in town came equipped with a towering reputation in systems work and, by implication as well as declaration, a fresh approach to the building process, but their baggage included little else save talent and a formidable drive. "Projects whose outcome is not a building" were an obvious opening wedge to areas in which they could compete for work.

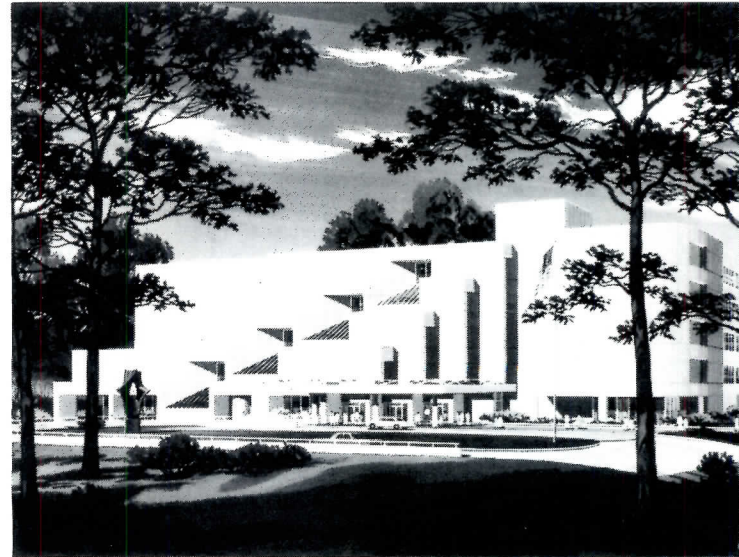
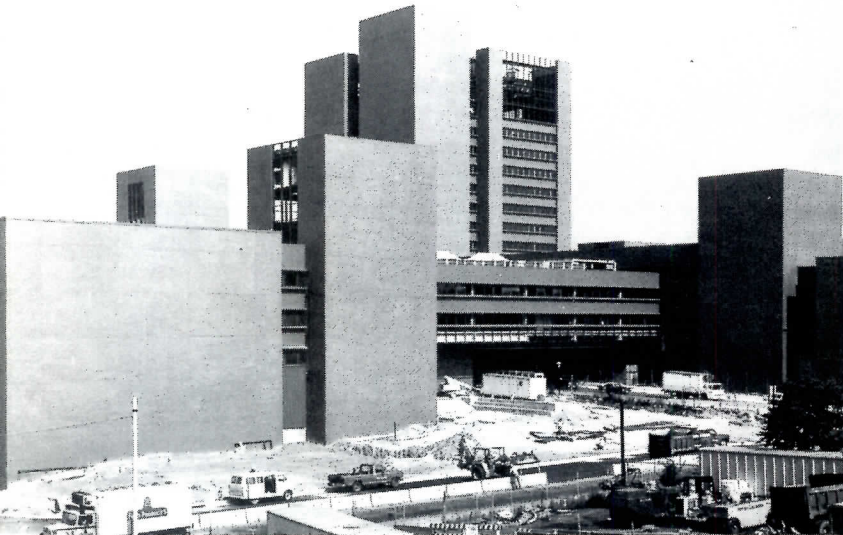
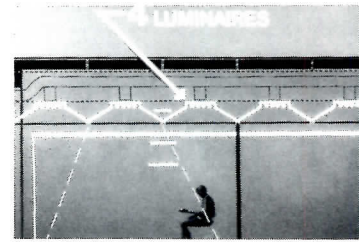
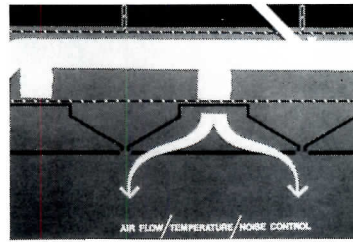
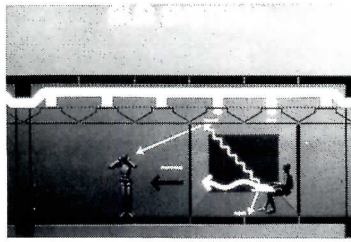
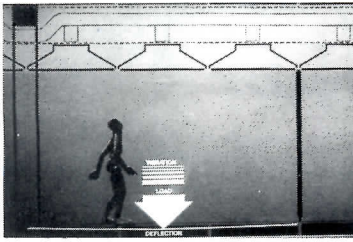

Examples of the firm's work in current systems building are illustrated on these facing pages. The drawings at the top of this page show four of the major subsystems for which entrepreneurial teams had to submit proposals in bidding on the two Social Security Administration Buildings in Baltimore shown

above. For these buildings the technology group of Ehrenkrantz worked with GSA in adapting the government's "peach book" performance specifications so they could be used in two disparate buildings, one a

high-rise office building, and the other a huge, spread-out computer center with only a few offices. For the office building at left above, Metro West in Baltimore, The Ehrenkrantz Group was systems consultant in joint venture with Leo A. Daly, SSA/Metro West, architects

and engineers; The Grad Partnership; The Eggers Partnership; Welton Becket & Associates.

For the SSA Computer Center in Woodlawn, Md. the firm was in joint venture with Leo A. Daly; Ayers/Sain, Inc.; Richter, Cornbrooks, Matthai, Hopkins, Inc.; Geddes, Brecher, Qualls & Cunningham.

The Ehrenkrantz Group billed itself from the beginning, however, as architects and planners, and its growth has been carefully orchestrated to enhance the design component. As the effort succeeds, will a strengthened design capability come to overbalance the now harmonious ensemble of complementary talents?

Meyer, naturally enough, sees the research role as remaining essentially unchanged in relation to the growth of the firm as a whole—a still proportionate slice from a bigger pie. The energy work, he believes, will continue to expand, as will enterprises geared to seeking out and effecting entree to new areas of potential growth.

Similarly, if systems development as such is less chic than it once was, the repertoire of skills it embodies remains very much in vogue—and will become ever more necessary as increasingly complex building requirements come toe-to-toe with new constraints in the realms of energy and economics. Kastl views the

firm's coming role in building technology as one of consolidating as well as expanding such tools as performance specifications, computer-based programming, product development and evaluation, and cost-benefit analysis, perfecting a problem-solving mechanism both indispensable and marketable.

Given so broad an investigative scope, strict distinctions between research and development activities—and the respective roles of their principal practitioners—are predictably honored mostly in the breach.

Rehkopf makes a stab at differentiation with the formulation of research as "the conceptualization of new methodologies" in contrast with the greater concern of development with "application of existing methodologies," the former being primarily additive and the latter integrative. In the dailiness of practice, however, the two appear to be interlocking and to a degree interchangeable, to form the resource base from which The Ehrenkrantz Group proposes to

practice an architecture that if not quite a science is at least a post-industrial craft.

"Synergism is a full-time effort here."

The firm to a man asserts as its peculiar strength its "problem-solving" approach. According to Rehkopf, who notes in passing that the firm wishes neither to appear to be all things to all people nor to be typecast as limited specialists, "What ties us together is our ability to conceptualize a problem, to break it down and then solve it in a logical way." Thus while much emphasis is placed on the generation of internal expertise as a by-product of outside contracts, the process is very much a two-way street. If, as Ehrenkrantz declares, "Half of what we're doing at the forefront of a field like energy has a direct input back into other activities," so too do "other activities" contribute to the firm's inventory of specialized knowledge. Meyer says responsibility for practical applications to building projects pro-

vides feedback to those producing the data base. It is the crucible in which "new ways of looking at things" are tested for their viability as "new ways of doing things."

But symbiosis between the technological disciplines and design breeds pragmatic benefits as well. Although, as Ehrenkrantz believes, the days of signing a contract for a percentage of building cost are gone forever, and the firm routinely bills such work as programming and pre-design analysis as separate contracts over the traditional basic fee, design activities alone could not "keep the infrastructure going to produce the data base on which we rely." On the other hand, he adds, if the data base can be built up in the course of pursuing other projects—"research here, building systems there, other development work"—the needed information can be generated on a self-supporting basis.

The firm has acquired over the years a realistic sense of what research study and other nonde-

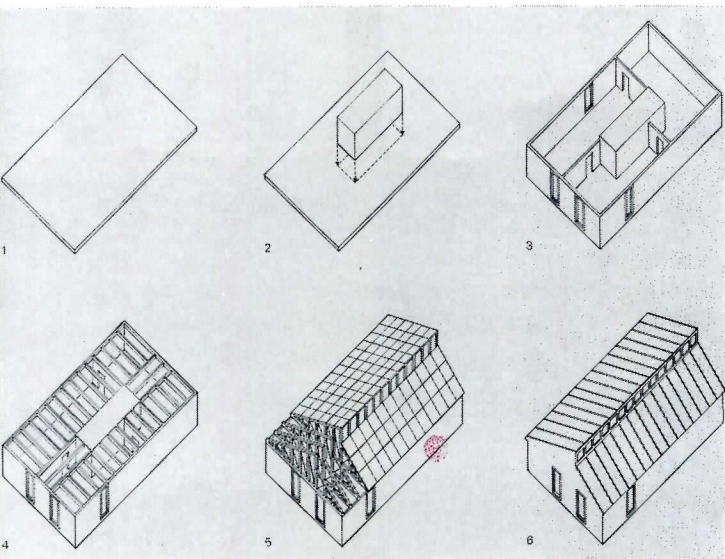

The most recent systems work in progress is this project to develop a housing system for the Office of Foreign Buildings, U.S. Department of State. The State Department wants housing for its foreign officers

that is attractive and comfortable so that families will not mind so much being away from home. At the same time, the Foreign Buildings staff

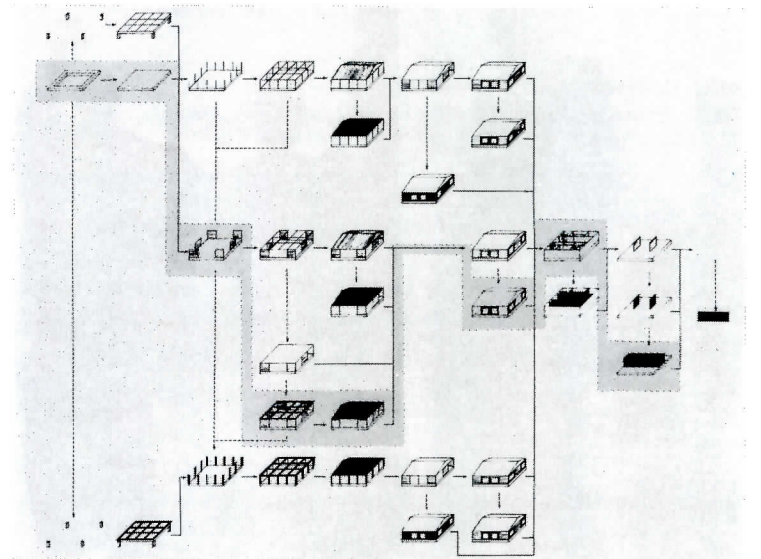

would like to utilize local construction materials as much as possible. This might mean, for example, that much of the building shell could be provided by local builders, but that a plumbing/environmental systems core would come from the U.S. To

help the State Department be flexible in making these choices, Ehrenkrantz developed the decision-tree format shown above.

design work can produce in dollars and cents and what is needed to strike a healthy financial balance between output and return. Although such work may not turn a profit, says Rehkopf, "it pays a lot of overhead." It also builds up the scale of activities to a critical mass of staff capability that allows investigative and design work to be performed more efficiently and economically.

Ricci sees as another by-product of a problem-solving orientation based on the willingness and ability to invest in in-depth study the opportunity to become involved with clients along the whole spectrum of facility-related issues in addition to the traditional—and narrowly conceived—sequence of architectural concerns running from programming and design through construction. Entering the building process earlier in the game by addressing prebuilding concerns, and leaving it later after attention to such long-range considerations as energy use and life-cycle performance, he believes, has obvious advantages for the client

and serves the firm as well, not only by depositing new information in the data bank but as a marketing tool. "By the time you've helped a client sort through some hard policy decisions, done some follow-up studies... you're on the short list to actually do the work."

The spinoffs from development to design have been neither as prompt nor as plentiful as Meinhardt once hoped. Now, however, the design component under his charge is fast gathering momentum. "We are finally getting opportunities on a much broader scale to show that we really can bring the disciplines and abilities we've developed together to turn out a building that solves the particular problem of a particular client." The firm now has nine building projects in various stages from schematics to working drawings, its biggest backlog of design work to date. And all, Meinhardt notes, if not direct spinoffs from earlier, groundlaying work, incorporate special requirements in program-

ming, in complexity of services and mechanical requirements, in needed potentials for growth and change—which shifts them from the realm of straightforward design to the territory of synthesis and coordination the firm proposes to stake out.

"The special things we do here," Meinhardt believes, "are only as important as the ultimate synthesis of all our abilities. Our first two concerns are a better building product for the owner and user and our total effect on the built environment."

"To be a really responsible professional today you have to be able to investigate problems in greater depth and with greater rigor..."

The Ehrenkrantz Group is both persuaded and persuading on the validity of its troika-style, "problem-solving," "knowledge-based," "process-oriented" approach to architectural practice and the value of its carefully nurtured in-house expertise in a number of well-defined areas.

But the descriptors are

unique to the firm neither as concepts nor coinage: indeed, it would be a rare architectural practice that would not confess, if pressed, to engaging in problem solving. So questions nag.

Granted a diversity of activities born at least partly of opportunity snatched from the jaws of adversity, and a willingness to undertake as separate contracts work many firms would either subsume under planning or design commissions or consider outside their proper scope, is the firm's self-concept of a unique analytical capability based as much on new ways of packaging and labeling as on a new product? Is The Ehrenkrantz Group moving systematically toward the evolution of a new process? Or is it merely articulating, step by tiny step, paths architects have long followed?

Ehrenkrantz finesses such questions as distinctions without a difference. Conceding that in some aspects of the firm's practice its functional operations are unusual more in degree than in kind, he suggests that the quanti-



Gordon H. Schenck, Jr.

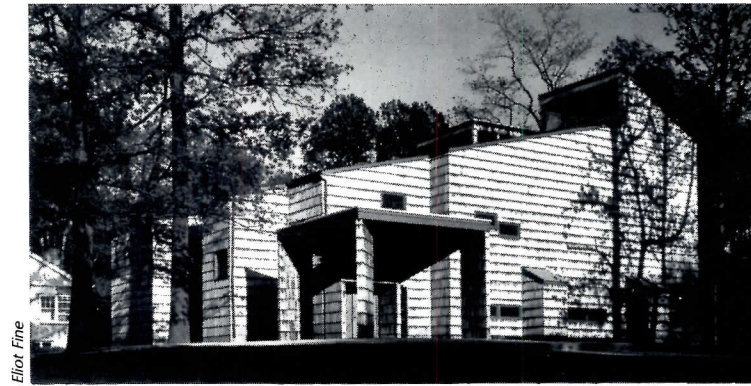

Eliot Fine



Paul McKenna

While architectural design is intrinsic to the Ehrenkrantz practice, it also complements the research and technology disciplines. For example, the solar-heated house above was de-

signed for the Exxon Energy-Efficient House project. The firm's joint venture with John Carl Warnecke and Associates for Henle Student Village at Georgetown University stemmed from its background in systems building projects, though this housing was conventionally designed and built. The wood-shingled synagogue

for Congregation Bais Torah in Suffern, New York, is straightforward architecture in a residential vernacular. In the design of a new trading floor for the American Stock Exchange, the firm drew on human

factors analysis and communications expertise to relieve congestion and accelerate the transfer of orders from buyers to clerks. Space for clerks was moved from the trading floor to two cantilevered balconies. The exchange kept operating all during the construction process.

tative distinctions veer toward the qualitative in the firm's strong commitment to its technological components. Research and development are considered viable professional services in their own right. Within the structure of the firm they stand as partners rather than servants to design.

The importance attached to the availability of extensive, up-to-date, and readily retrieved information in a variety of areas is rooted in Ehrenkrantz's prognosis for the immediate future of the profession as one of rapid, pervasive and unpredictable change—of new challenges that cannot be met by recourse to precedent.

Ehrenkrantz points out that the design process still being applied today evolved in an earlier (though not so very much earlier) time when building problems fell within a consistent and relatively well defined range and could be solved within a stable context. The inflation rate, for example, was negligible or virtually so. New materials were being introduced, but not at a

rate too rapid for their comfortable assimilation. Technologies were being refined, but not revolutionized. Architects, in short, were secure in the use of a reasonably static vocabulary and an established grammar, and could "deal with the design process totally in design terms because the other factors were constant." Today, the once common language has become a Babel from which The Ehrenkrantz Group hopes to recover a stable vernacular.

To do so, Ehrenkrantz says, is a matter of information. "That is why we have to keep the research going, why we have to have people to keep in touch with a variety of areas." And if preserving for the free exercise of design talent a place usurped by the complexities of a changing building vocabulary requires forays into the territory of the usurpers—well, that irony is not missed. Nor is it lessened by the resistance of the design cadre to the least hint that the preserve thus protected be designated a wilderness area.

Meinhardt, who was quick to recognize the value of systematic analysis as a precedent of coherent design, is equally quick to see the givens resulting from the predesign processes as challenges rather than constraints. "Designers have to become more conversant with these complex issues" not merely because they are parameters of design but because they are the common ground for the dialogue with the client that must be maintained if the end product of the transaction is to be both a solution and a statement. "It is very important," says Meinhardt, "that every building have about it a strong—or at least a clear—design idea. I don't think just putting pieces together in a nice way is an idea."

"The key task of an architect today is really to optimize resources. Whether you are a good architect or a bad architect depends on how—and how well—you do it."

The changing nature of dialogue with the client, Ehrenkrantz be-

lieves, is prominent among the manifestations of the new dynamic within which the architect must work. He sees the typical client as an increasingly proficient manager, street-smart if not formally schooled in the emphasis on procedures and accountability that permeates today's managerial environment.

The resulting relationship with the client is far from that of patron to artist. It requires, according to Ehrenkrantz, the assembly of relevant data, the careful study of alternatives, the justification of decisions, the involvement of the client at key points in the problem-solving process—all toward the end of meeting the client's needs within the resources available.

It is a working framework. The Ehrenkrantz Group find congenial—with reservations. One-upping Vitruvius, Ehrenkrantz labels the elements of present-day architecture behavior, environment, economics and image. And he sees the present-day client, himself beset by new complexities and constraints, a

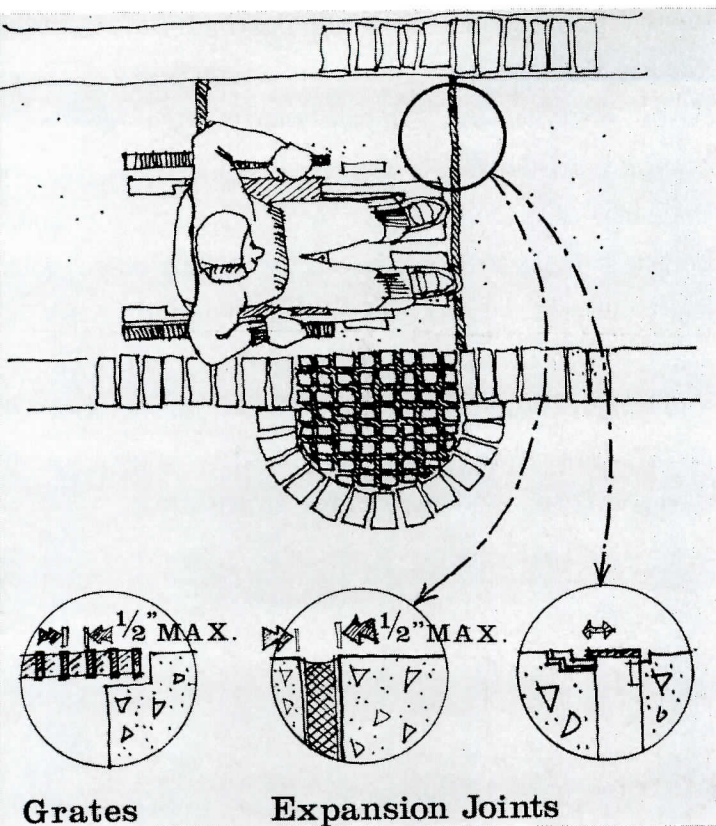

Grates **Expansion Joints**

These drawings above are from the AIA publication "Design criteria: new public building accessibility," an example of the assorted projects

that Ehrenkrantz has done for assorted government agencies. The document is both broad and comprehensive, with a large section devoted to physical disabilities and

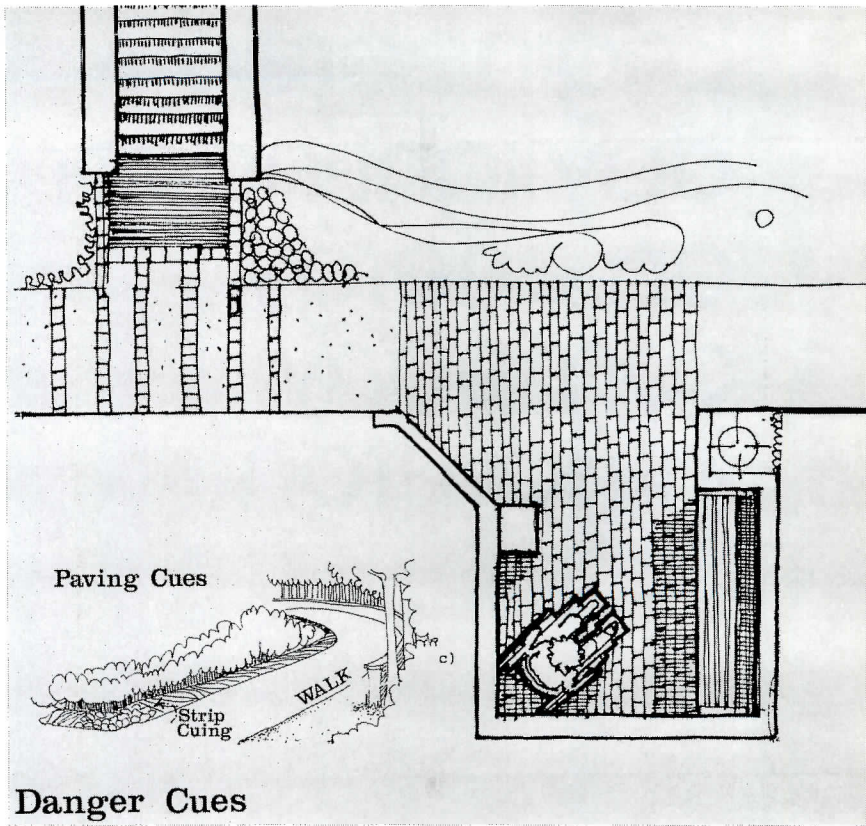

Danger Cues

disabling causes, followed by a list of architectural elements that might be potential barriers. The notes accompanying the above drawings

give recommendations for paving, drains, grates, catch basins and expansion joints, and describe techniques to provide danger cues for the blind.

leaning heavily toward economics, if necessary at the expense of behavior and environment. The image—presumably the revised version of Vitruvius's "delight"—at times can get lost."

Thus part of the architect's function must be to help correct the tendency to imbalance—at a time when, as Ricci puts it, "you have to chase every dollar around the block twice." In this context The Ehrenkrantz Group's reliance on the accumulation and exchange of expertise carries no hint of pulling details from a bottom drawer but becomes a logical device for approaching each problem at a level that optimizes both the client's resources and the firm's.

"The program is the bottom line..."

The cornerstone of the process is to make explicit the nature of the possible trade-offs between needs and means, and to do so before the sought-for balance has been disturbed by preemptively premature decisions.

"There is no point in starting

to design a building and then discovering you're going to have to take out twenty per cent of the job," says Ehrenkrantz. "What we try to do is organize the program in such a way that we're sure it responds fully to the needs of the client and user and that it can be carried out with the available dollars before we begin to design."

Much of the information the firm uses in analyzing and evaluating options is generated and presented on a cost performance basis, and draws heavily on the resources developed through systems work. Given the relative costs of various levels of performance or amenity, the client can readily see the need, as Ehrenkrantz says, "to give on the performance criteria, or settle for a little less space, or change certain other requirements" and can more intelligently weigh such long-term considerations.

This formalization of the decision-making process may seem—and be—at times a needless elaboration, but The Ehrenkrantz Group is persuaded of its

value. At another time and for another profession the maxim was simple: "If you can't explain it, you can't do it." For architecture today, the maxim might run that if you can't elucidate it, then you can't sell it.

Formalizing the predesign process, if nothing else, improves communication with the client.

"We are still going to have to be able to respond to image as well as economics..."

But what does this imply for the buildings that are the end product of the process?

Every pudding needs its proof, and The Ehrenkrantz Group's is for the most part still in the oven.

But perhaps, as architect Karl Justin, a disinterested but largely approbatory observer of the firm's progress, suggests, it doesn't much matter whether the Ehrenkrantz office reaches through its obsession with problem solving and processes the level of design that intuitive approaches often do. "The firm has the ability to look at things

rationality in areas where the conventional intuitive process doesn't take you. The point is that they know what they're doing."

Ehrenkrantz himself expresses much the same thought. "What we are talking about," he says, "is improving certain levels of performance." The faith is that if the building process is structured and organized as the firm attempts to do, the odds are greatly improved for obtaining good, responsible performance on a consistent, continuing basis. Which is not to say that "a gifted individual with tremendous insight as well as talent is not going to come up with a better job."

But "I don't personally believe that you say to yourself, 'I am going to design something great.'" The aim rather is to produce first-rate work that is responsive and responsible while establishing a position from which, given the serendipitous mix of conditions that "spark each other off," the firm's design capabilities are poised for the leap to the "really great."

Engineered daylighting for an energy company in Houston

Interest in daylighting, which flagged after a spurt in the '50s as the country turned to a more mechanically based environment, is again on the upsurge. In the complex for Shell Oil, Caudill Rowlett Scott had the back-up of model tests by daylighting consultant Benjamin H. Evans to reassure them that offices facing skylit atriums would get sufficient daylight for the approach to be practicable. Employees who examined a full-size prototype office were enthusiastic about the architectural design and about the quality of the daylighting for working and for atmosphere.

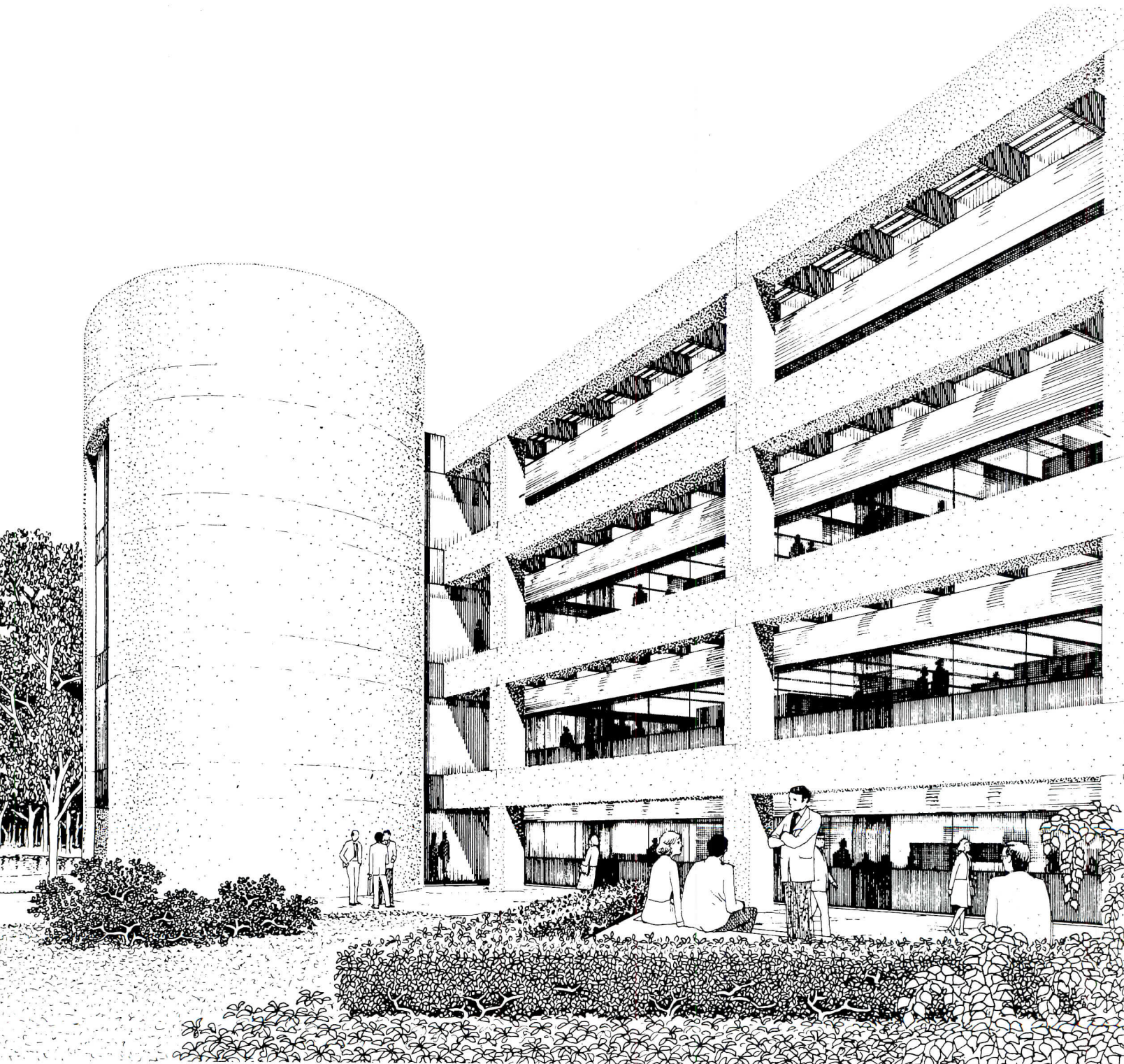

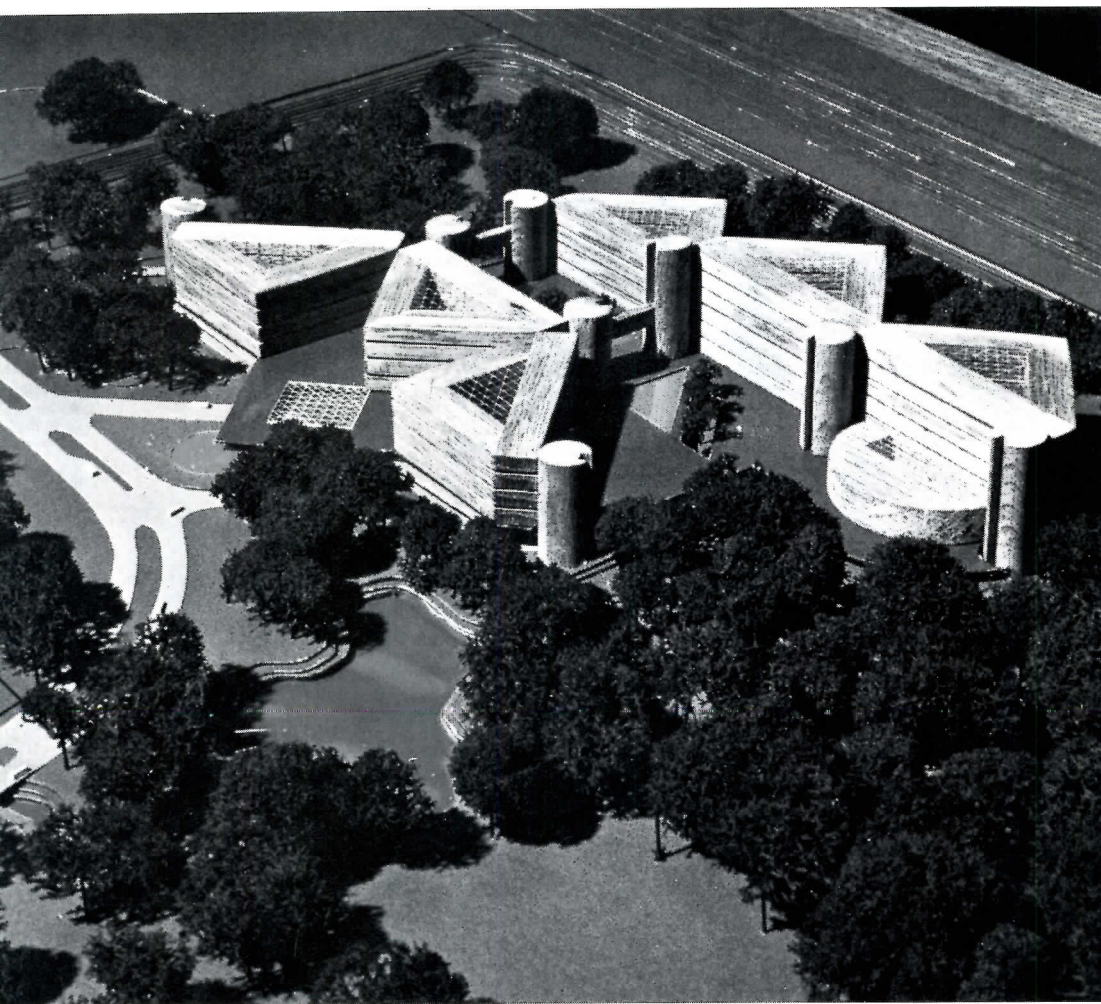

Scheduled for completion in 1980, the Shell/Woodcreek Exploration and Production Office is a campus complex in a wooded setting comprising six triangular buildings totaling 650,000 sq ft.

Reliance upon daylight as a major source of illumination for this 650,000-sq-ft Shell Oil Company office building outside Houston lowered electric power for lighting to an estimated 0.87 W/sq ft based on a conservative projection of annual use.

The daylighting approach developed naturally from the owner's requirement for a maximum number of private offices with outside views in an energy-conscious and efficient building design. Shell asked the architects, Caudill Rowlett Scott, for a facility that would provide a stimulating and pleasant working environment while also preserving the natural beauty of the wooded site.

The requirement for numerous private offices suggested a long narrow building with a central corridor and offices on either side, but this configuration results in a maximum of exposed perimeter for a given floor area. CRS reasoned that if the stretched-out floor plan elements were folded around a skylighted atrium, the exposed perimeter would be halved and a focal point created for each of the operating units of the Woodcreek exploration and production complex. Furthermore, the long, narrow configuration with relatively shallow offices offered exceptionally good conditions for the application of daylighting.

Daylighting, to work well, must be expertly controlled to avoid excessive brightnesses and excessive thermal transfer. To accomplish these goals, CRS designed a precast concrete framing system that extends beyond office spaces to the outdoors, supporting horizontal louvers that prevent penetration of direct sun while reflecting

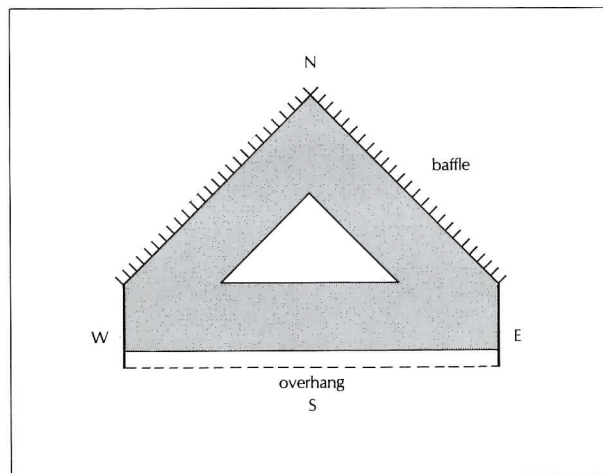

The architects solved the owner's requirements of 100 per cent outside offices in an energy-efficient building—a seeming paradox—by wrapping narrow strips of office floors around air-conditioned atriums. They put core functions in cylindrical towers (half-cylinders in a more recent design), and connected the two groups of buildings with bridges. The study plan here illustrates the possibility of either double- or single-loaded corridors. An early proposal had baffles on west and east and an overhang on the south. Baffles proved to be unnecessary, and now horizontal louvers screen the sun on all sides.

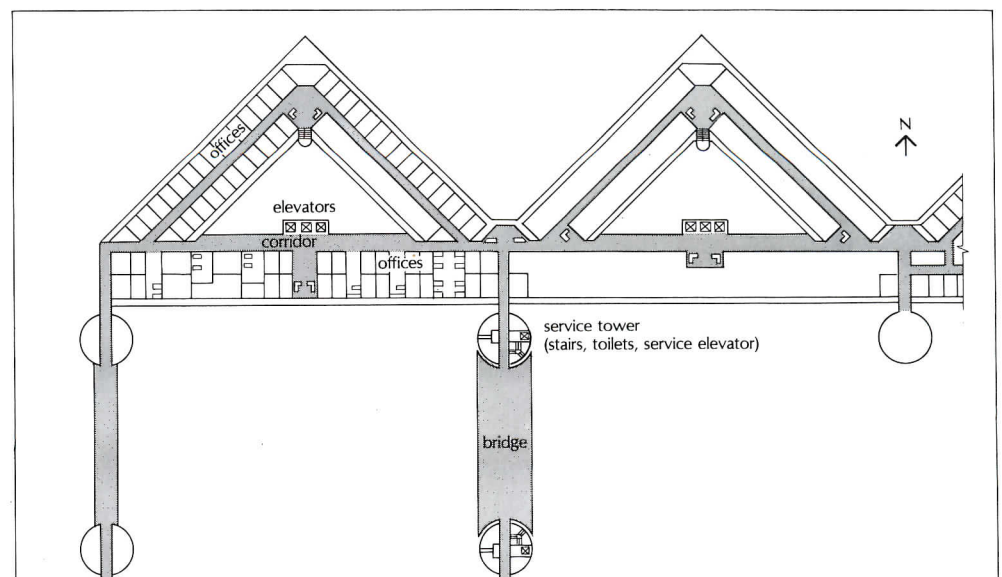

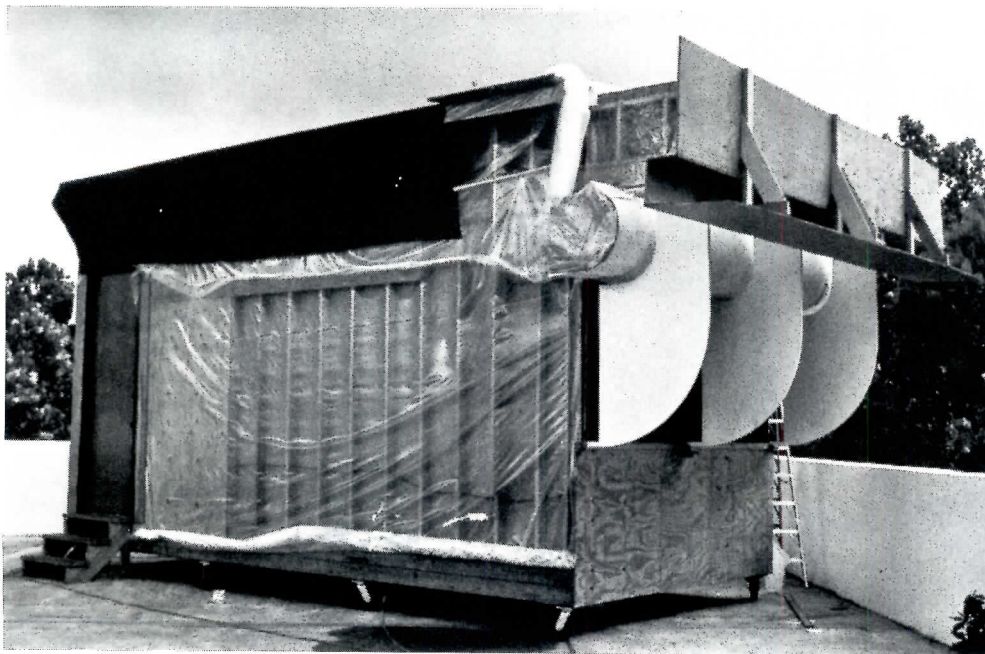

A full-size, furnished office prototype, mounted on a "gypsy wagon," could be turned to any orientation to study lighting conditions. The duct enclosure at head height bounces daylight to the ceiling, and provides a gradation of brightness.

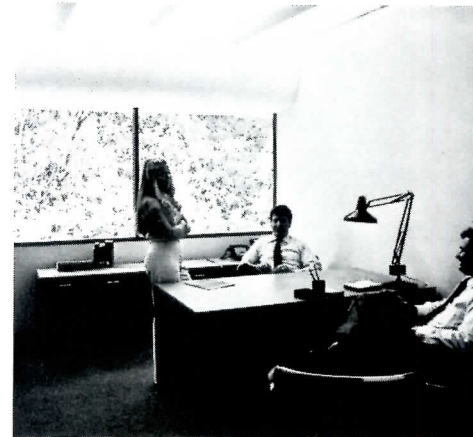

Computer studies of sunlight penetration, which yielded graphs such as the one at right, demonstrated that vertical baffles were not necessary on the northeast and northwest facades of the buildings. In July, for example, very little sun penetrated the tinted vision glass until after 4 P.M.

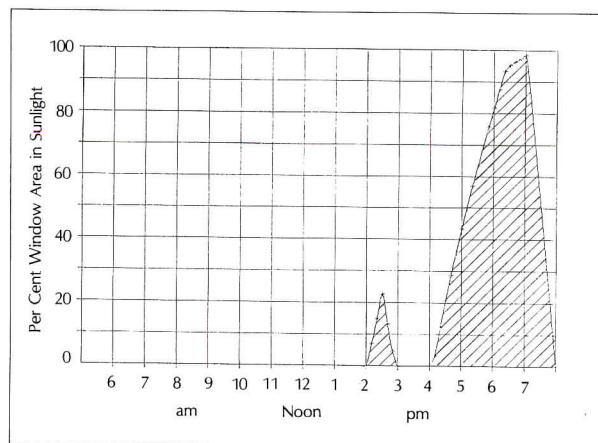

diffuse light into the interior. Computer drawings show that the exterior beams and the "light shelf" (see office cross-section) also block direct sun from the vision glass.

To direct and provide a more even distribution of daylight into offices, the architect designed a perimeter enclosure for the HVAC distribution that extends half inside and half outside the plane of the glass. This design eliminated the need for a hung ceiling, allowing a reduction in floor-to-floor height.

Because daylighting was to be a major determinant of the building design, CRS asked Benjamin H. Evans, professor of architecture at Virginia Polytechnic Institute and State University, and a daylighting consultant, to conduct scale-model studies of the schematic designs. Their purpose was to determine whether the total design scheme was feasible in terms of daylighting, and particularly to find out whether the atrium concept would provide sufficient daylight for the atrium-facing offices. A simple initial model, constructed with the assumption that the atrium had 100 per cent coverage of light-transmitting material, was built and tested by Evans to let the architects know whether or not they were on the right track. Footcandle readings were high enough to assure the designer that daylight from the atrium would be sufficient. Studies on a second model with many more architectural details showed moderate to plentiful illumination.

Concurrently with the model studies, CRS and Shell commissioned a full-scale portable prototype office for observation and study and for daylighting tests. The model studies were not intended to determine whether or not the design would meet specific quantitative lighting levels, but they were used, along with the prototype studies by the architects to arrive at a design that yielded quality architecture with the best possible lighting environment within the constraints given. Impressions of observers using the prototype were that the office environment was pleasing architecturally and that seeing conditions were excellent (even during a heavy rain squall).

These computer drawings in axonometric projection show how the sun "sees" the facade of the western face of the triangular buildings. On July 21 at 2 P.M. one can see that the entire glass is in shade. In the bottom drawing, at 5 P.M., one can see a substantial amount of glass in the sun (40 per cent according to the graph above, center).

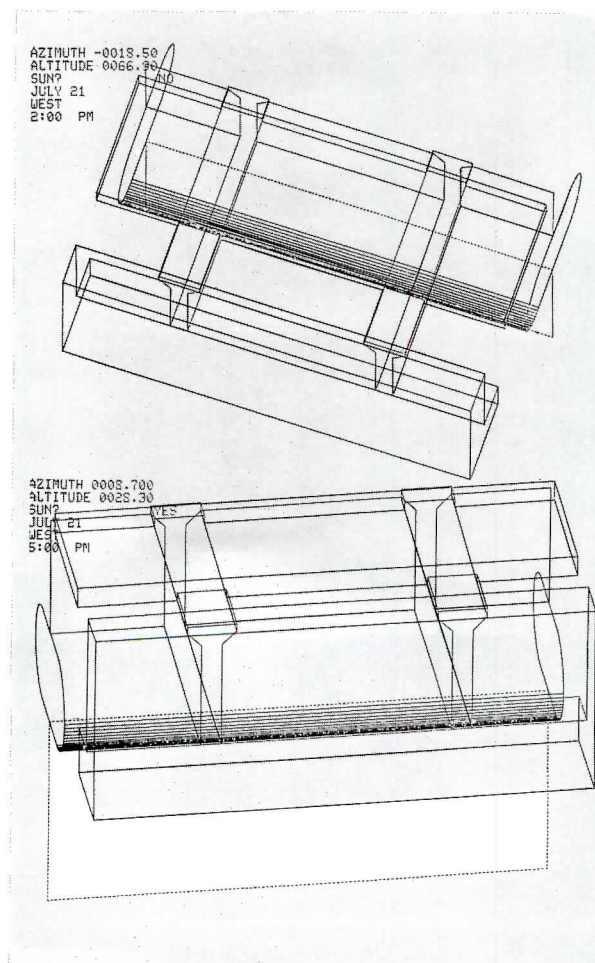

Architects and engineers: *CRS Architects/Planners/Engineers*—project director, James Gatton, AIA; design principal, Charles Lawrence, FAIA; senior project designer, Rey de la Reza. Consultants: Benjamin H. Evans, daylighting; Jules G. Horton, lighting; Michael Sizemore, energy.

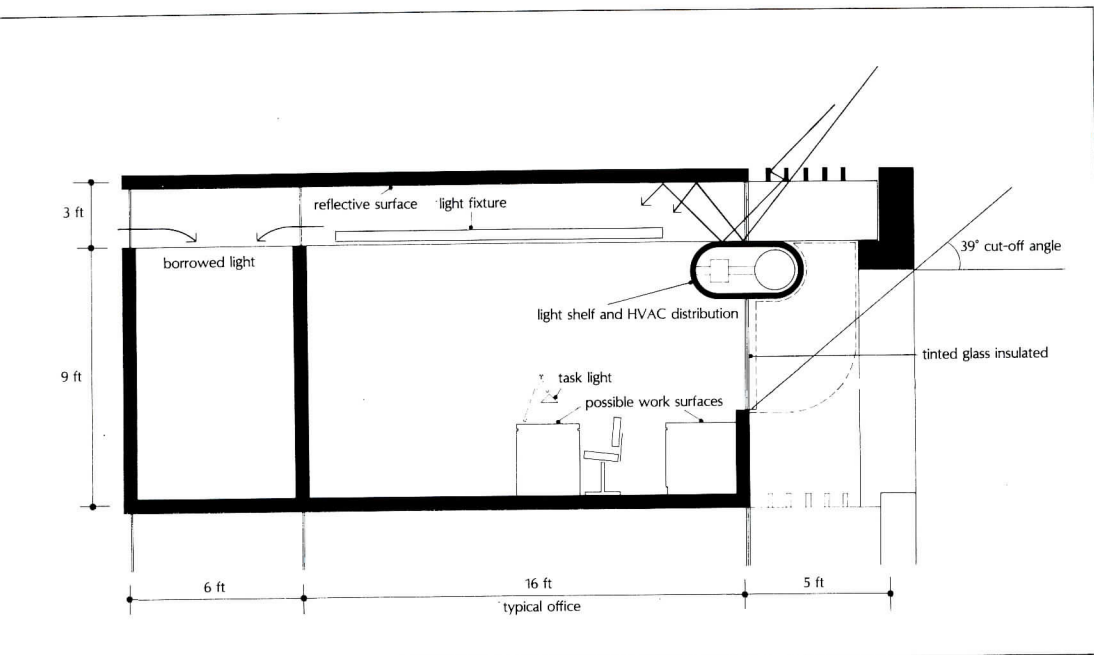

This cross-section illustrates the principles of the daylighting design. Louvers in conjunction with a "light shelf" exclude direct sun, but reflect it into the interior from the white ceiling. The exterior beam blocks sun from the lower part of the window. Two indirect fluorescent fixtures, with switches located conveniently next to the desk, can be used on dark days and at night. Each desk also has a portable task light. The corridors have no lighting fixtures, but borrow light from the offices.

DAYLIGHT TEST RESULTS—Single Office Model

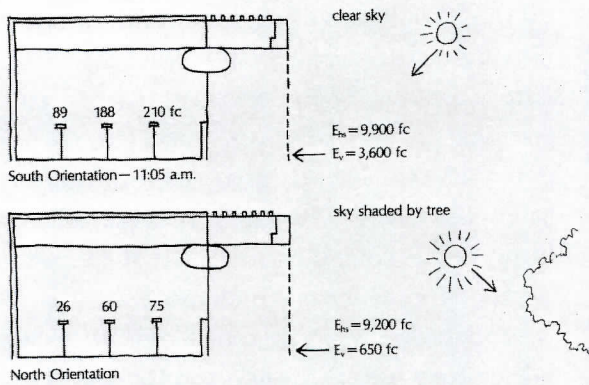

CROSS SECTION OF MODEL (Atrium Area)

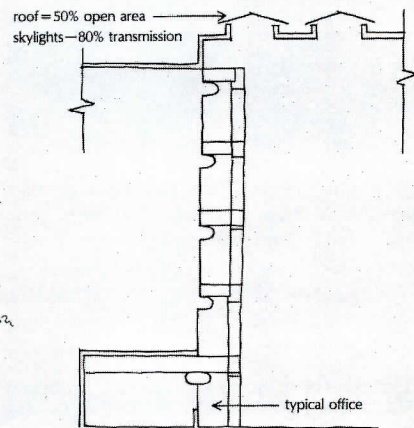

Model tests gave the architects confidence in their daylighting design. Measurements showed that light for perimeter offices would be plentiful. The architects knew that illumination for atrium-facing offices would be less because the windows "see" less sky. For offices nearer the skylights (Room D in drawings), daylighting is sufficient by itself. For offices at the bottom (Room C in drawings), some supplementary electric illumination may be needed, either with desk task lights or overhead indirect fluorescent luminaires. For the atrium model tests, a single office model was moved to four different locations on two walls of the atrium. Daylight measurements were also taken in the full-size prototype, with results shown below for June 15 last year when the sky was partly cloudy. The atrium model tests were conducted on June 1 and June 15.

DAYLIGHT TEST RESULTS—Atrium Model

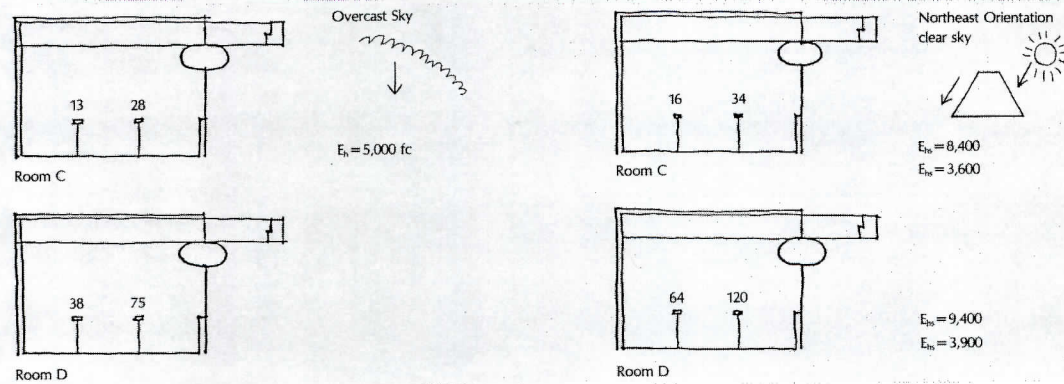

DAYLIGHT TEST RESULTS—Full Scale Prototype (Partly cloudy sky)

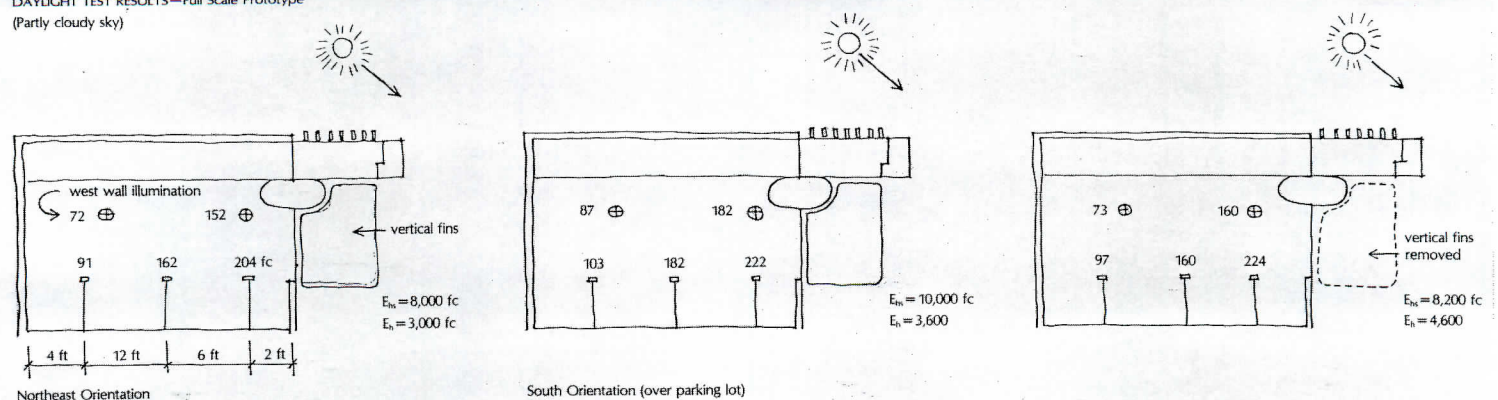

3 ACOUSTIC DESIGNS FROM EUROPE: A FORETASTE OF THE FUTURE

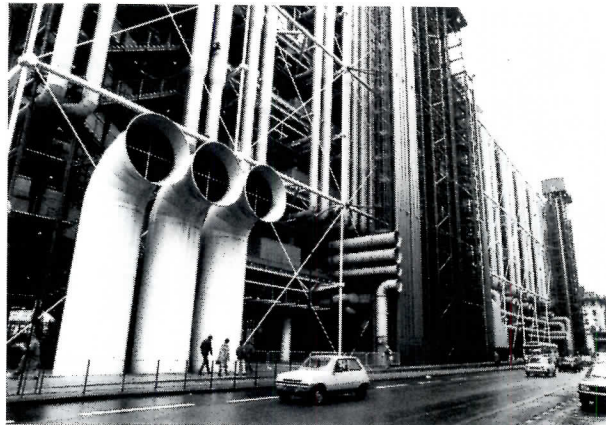

A major facility of the Institute for Research and Coordination Acoustics/Music is the *Espace de Projection*, an experimental hall for scientific investigations, composition, and performances of new music for the

public. The hall has a mobile ceiling system, allowing considerable change in room volume, and ceiling and walls have motorized prismatic acoustic pylons. Above is the Georges Pompidou Center.

Innovative designs in buildings for the performing arts are being developed in response to audiences' desire for more informality and less exclusivity, to rising costs, and to man's timeless urge to push ahead on new frontiers. These changes are occurring on both sides of the Atlantic, and the three buildings described in this article highlight formative examples in Europe: 1) IRCAM in Paris, where computers are used in the search for new forms of music and new musical instruments; 2) the Muziekcentrum Vredenburg in Utrecht, the Netherlands, where shops, cafes and restaurants ring a surround-type concert hall; and 3) the Hexagon in Reading, England, where a multi-purpose arena relies upon electronically generated sound, called "assisted resonance," to vary the acoustical characteristics of the room.

These buildings were visited earlier this year by U.S. acoustician Christopher Jaffe, accompanied by RECORD senior editor Robert E. Fischer. Jaffe, cognizant of the strong research base of European acousticians, was eager to see their latest work, and to learn about Manfred Schroeder's recent research in Göttingen, Germany, on the computer simulation of concert-hall sound. Jaffe, who has pioneered in acoustics for outdoor pavilions, is garnering kudos for his work on surround halls in Mexico and Denver.

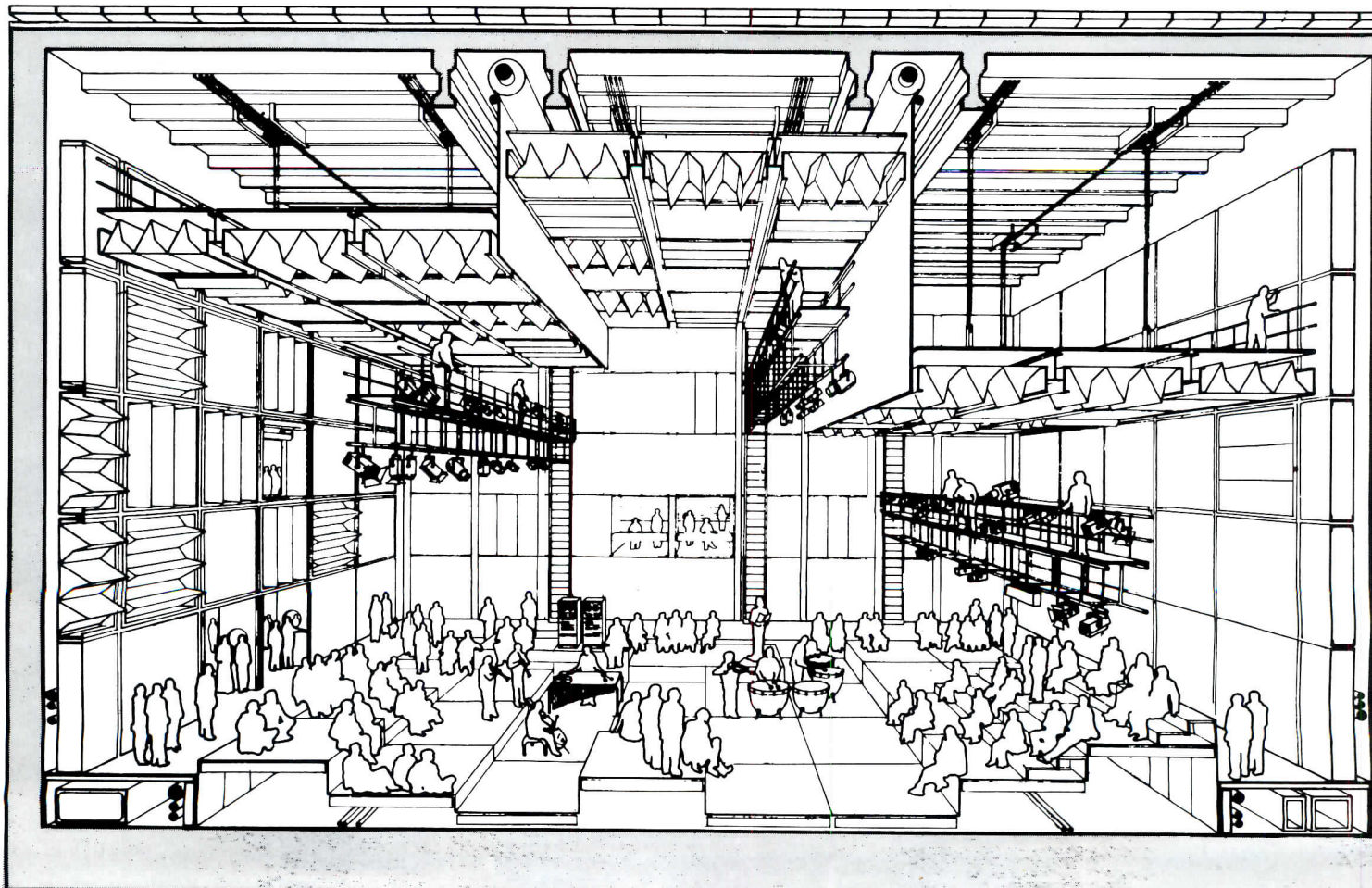

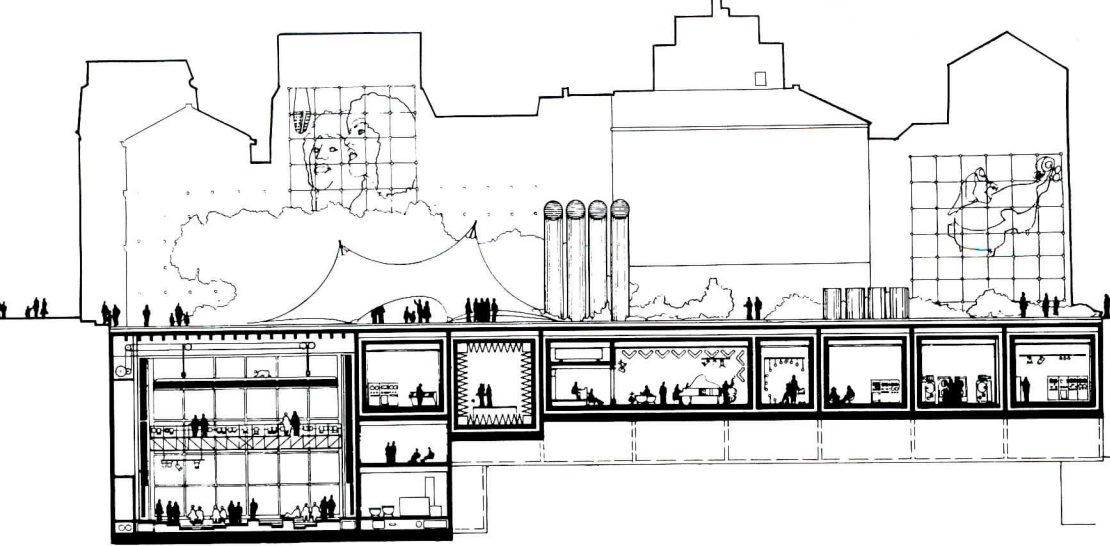

The Georges Pompidou Center is immediately recognizable by its exposed pipes, ducts and ship's funnels. A row of ventilating funnels makes the only visible announcement of IRCAM's presence underground south of the Center. The underground location helps provide acoustic isolation. In addition to the *Espace* (far left in drawing) are studios, a computer room, an anechoic chamber and offices. Architects: *Piano and Rogers*; acoustical consultant: *Victor Peutz*.

**At the Beaubourg,
a unique environment
for collaborating
musicians and scientists**

It is well known that a major motivating force behind the Georges Pompidou National Center of Art and Culture was the French government's desire to regain a leadership position in the visual arts and in the composition of modern music. Pompidou personally invited Pierre Boulez to head up the Center's Institute for Research and Coordination in Acoustics/Music.

IRCAM comprises four small studios, a master recording studio, a large computer room and ancillary space, and the *Espace de Projection* shown here. With its motorized, rumbling acoustic pylons and movable segmented ceiling for altering the acoustic characteristics of the room, the *Espace* will fascinate the visiting architect, but already has bewildered some audiences.

With 1978 being the first full year of use for IRCAM, the musicians and scientists are still getting used to their new toy. Nonetheless, significant research goes forward, and the *Espace* has been used on four occasions for the performance of new compositions. One work used a digital synthesizer called the "4C," in which live instruments controlled its operation. A performance of Boulez' "Explosante Fixe" called for flute and digital synthesizer.

In the instruments department, a new flute is being built for effects called for in contemporary music. Measurements carried out in the *Espace* suggest that some of the classical formulas describing the behavior of sound may need to be revised.



The *Espace* is 46 ft high, 82 ft long and 88 ft wide, and has 172 panels, each with three motorized triangular pylons fitted with a reflecting surface, a diffusing surface, and a highly absorptive surface. There are three rolling bridges, like the one in the photo, for mounting lights and equipment.

The rotating pylons provide six different combinations of reflecting, absorptive and diffusing faces, and have also a seventh position in which air spaces are left between pylons. The reverberation time can vary between 1/2 and 4 1/2 seconds, a range never before attained in a single room. Also the timbre of the sound can be controlled by regulating the absorption of high frequencies and low frequencies.

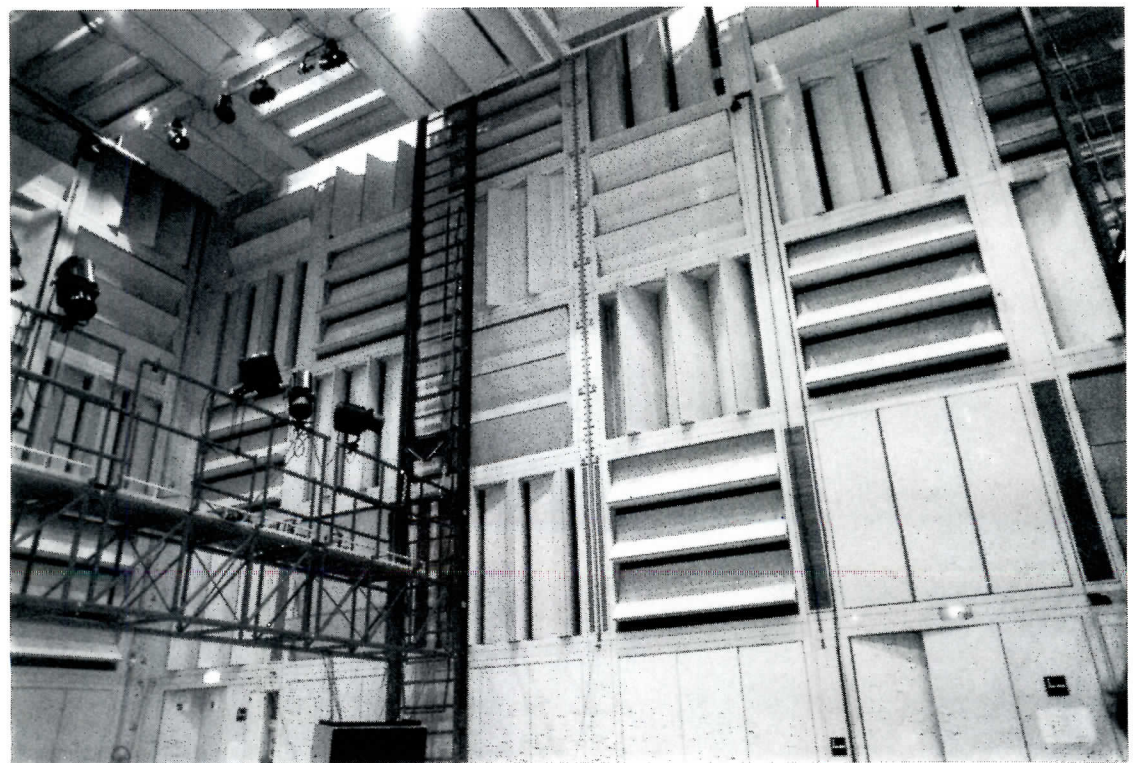

Robert E. Fischer photos

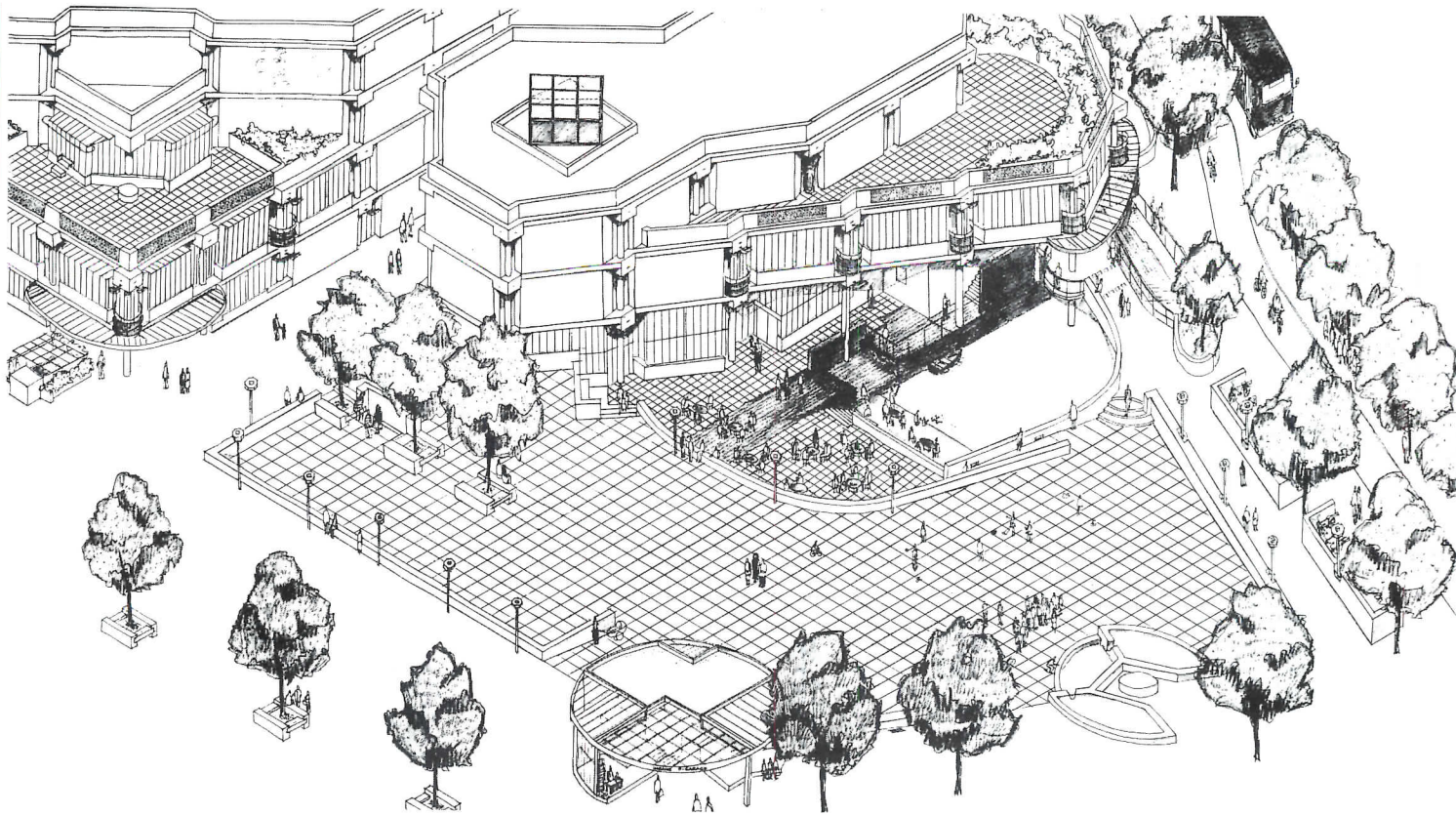

Muziekcentrum Vredenburg, in the commercial heart of the city of Utrecht, opened in January this year. It looks like a shopping complex from the major thoroughfares, but shows that it is also a performing arts center on its inward side that faces a tree-filled plaza (see site plan, rendering and photo across page). It is bounded by a major shopping center on the southwest and by stores and apartments on the northeast.

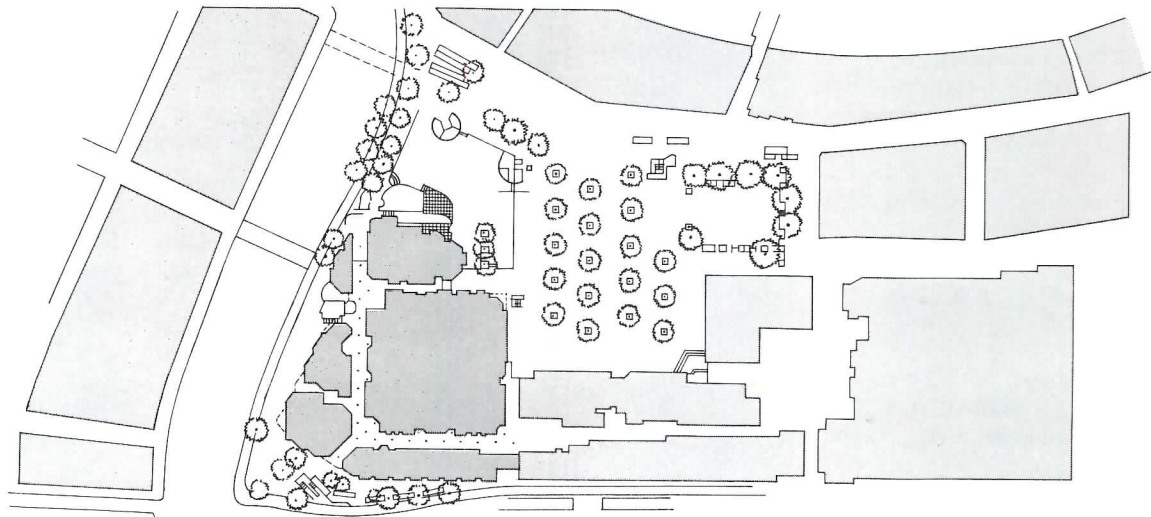

Sited on Vredenburg Square, the complex is accessible by car, bus, train and bicycle. A covered bridge (right in photo) leads to another shopping area and to the railroad station, and is accessible from ground by an escalator. This footbridge spans over the Catharijnebaan, a major highway (at the bottom of the site plan). The 1500-seat concert hall is encircled by shops, an information center and restaurants. The 350-seat recital hall (red on the plan) is on the second floor over the rehearsal studio.



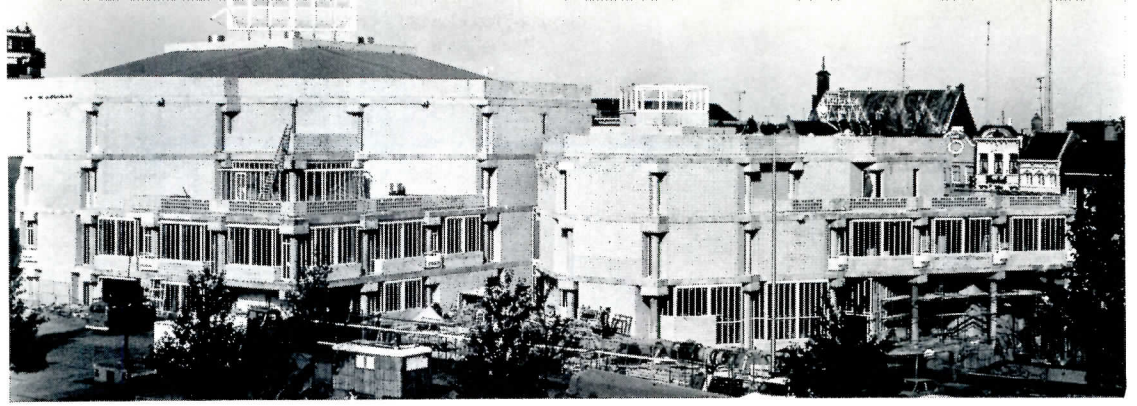

**In the Netherlands:
a truly integrated
performing-arts and
commercial center**

Architects and planners have long maintained that performing-arts facilities should be integrated with the city fabric, and if these professionals seek supporting evidence they need look no further than the Muziekcentrum Vredenburg in Utrecht, the Netherlands, designed by architect Herman Hertzberger. The music center is in the commercial heart of Utrecht—the fourth largest city in Holland with a population of 270,000. Utrecht is a commercial, academic and transportation center 20 miles southeast of Amsterdam.

The music center is named Vredenburg for the square on which it is sited—in the 16th century the location of Castle Vredenburg built by Spain's Charles V. It is the locale now of a market, an annual industries fair, a 61-acre urban renewal project called Hoog Catharijne which includes a large shopping center, and the railway station, and was, until recently, the site of a theater designed by the famed architect Dudok.

The Muziekcentrum is truly an integrated complex, with shops, restaurants, buffets and

an exhibition area wrapped around a 1,500-seat concert hall and a 350-seat recital hall. From the major thoroughfares, one sees the center as a commercial block, but no ordinary one. The block is remarkable both for its scale and its texture. Every effort was made to break down the scale so the block would have an intimacy and be attractive to people. The perimeter commercial areas are only two or three stories high, and the set-back roofs of the concert hall and recital hall slope up to skylights that crown the roofs. These skylights

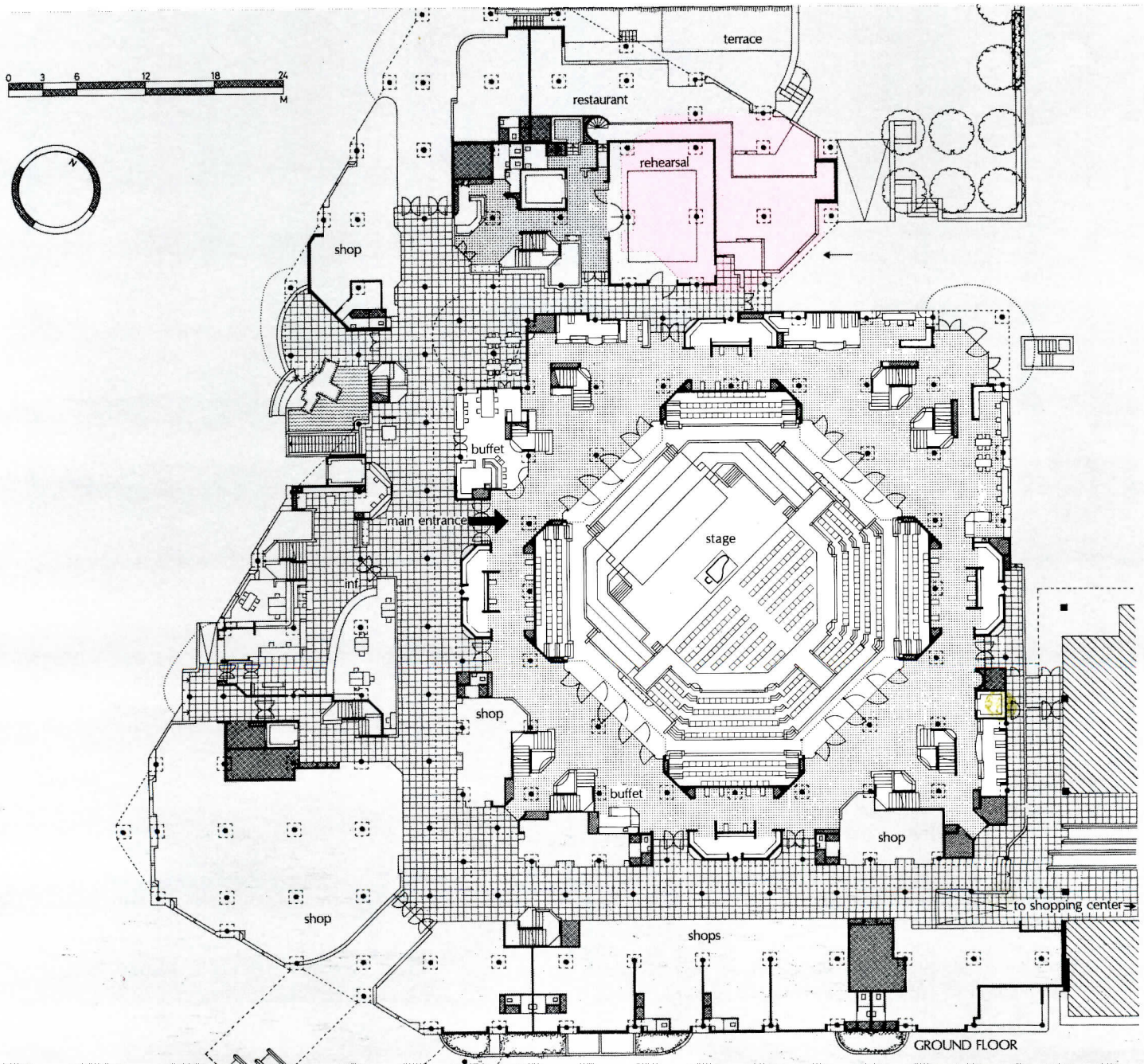

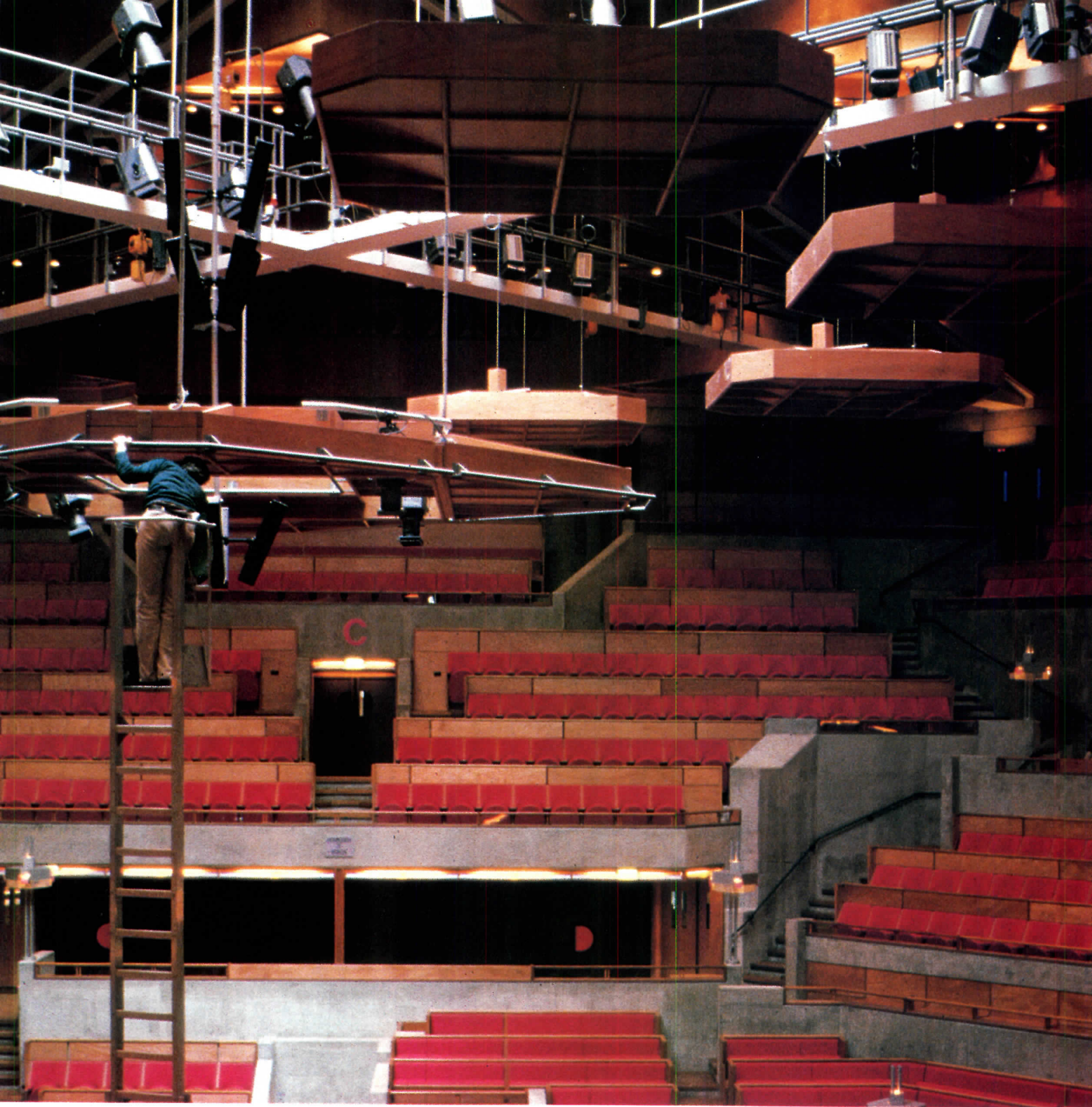

admit light to the halls in daytime (as do high windows in Amsterdam's Concertgebouw), and serve as "beacons" at night.

A great deal is made of texture and surface treatment to animate the broad concrete-block faces of the center. Walls and fenestration are indented so that the perimeter columns and their caps show, and the fenestration in modular patterns and white-painted framing serves as a foil for the concrete.

From the street sides, the building does not divulge its function as a music center, but presents its performing-arts face

only from the plaza side. Only here does Hertzberger let any monumentality show—wanting to avoid the impression of an imposing cultural temple.

The complex is strategically tied to the city in several ways. It is accessible by trains, buses, cars and, of course, by bicycle. It is linked to the Hoog Catharijne shopping center by passageway, and by a bridge to other stores and to the railway station.

The largest element of the complex is the octagonal concert hall which is ringed at ground level by shops, information center, rehearsal studio and a restaur-

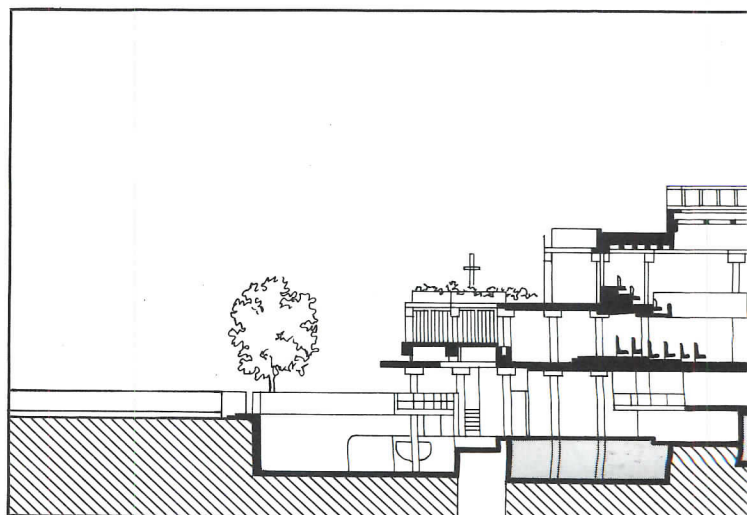

ant. At the second floor, it is circled by a restaurant, stores, music center office, exhibition area, small hall and small hall foyer. Between the large hall and the other components are galleries—covered streets and mezzanines circling the complex.

Openness was stressed by the architect in his design. From a buffet outside the concert hall, customers can look out on the passageway. From the foyer several balconies can be reached as well as roof terraces. Concertgoers can window-shop with coffee in hand. On each level are sitting corners and niches.

Permanent seating of the large hall is apportioned around the eight sides and includes several angled balconies, which in turn are divided into loge-like areas. Movable seating can be set up at the stage level.

Hertzberger was intrigued by the possibility of watching the conductor lead a performance; it is said that he, himself, prefers the seats behind the orchestra in the Amsterdam Concertgebouw. The only other vertical surround halls in the world are the Berlin Philharmonic by Scharoun, which Hertzberger studied, and the new Boettcher Hall in Denver.



The architect designed custom pedestal lamps that signal the exit areas at ground and second floor levels and give human scale and residential character to the hall. He also designed the custom seats that have round seat cushions and contoured upholstered backs with strips of wood paneling at the tops to help enhance the initial reflections of sound from the orchestra that give presence to the hall.

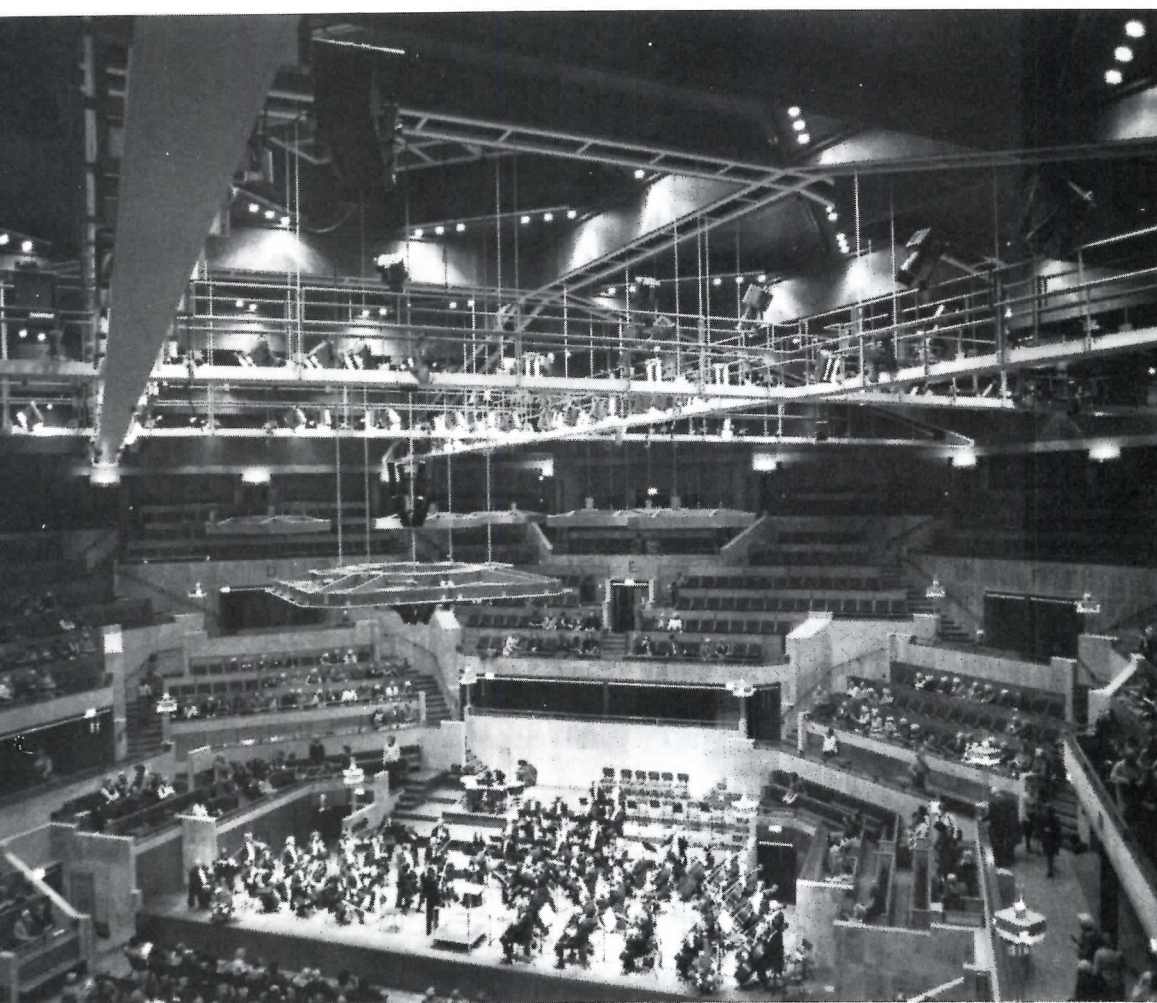

The acousticians for the concert hall, Professor P. A. de Lange and engineer L. G. Booy, both of the Institute of Applied Physics in Delft, stress the indispensability of early, strong lateral reflections. For this reason a considerable amount of exposed concrete surfaces was used surrounding exit areas and around stairs, in addition to the wood panels at tops of seats. The acousticians note that Professor Cremer in the Berlin Philharmonic 15 years ago introduced "vineyard steps," around groups of seats to provide these reflections. Studies by the Delft acousticians on a $\frac{1}{10}$ -scale model reinforced the importance of the reflecting areas for the Muziekcentrum which were specially introduced and designed by the consultants.

In order to attain the proper balance between early- and late-arriving sound energy in the lower part of the hall, the acousticians designed seven reflectors, six at 10 meters height and one at 9 meters, with 0.65-meter facets directed at different spots. Their second function is to help orchestra members hear each other. In the U.S., acousticians have favored more area of suspended reflectors over a greater percentage of the audience.

The reverberation time for the occupied hall with symphony orchestra on stage is between 1.8 seconds and 2 seconds depending upon the type of test signal. The coffered ceiling has many surfaces at right angles to one another. The large daylight opening was insulated so the sound of rain is inaudible.

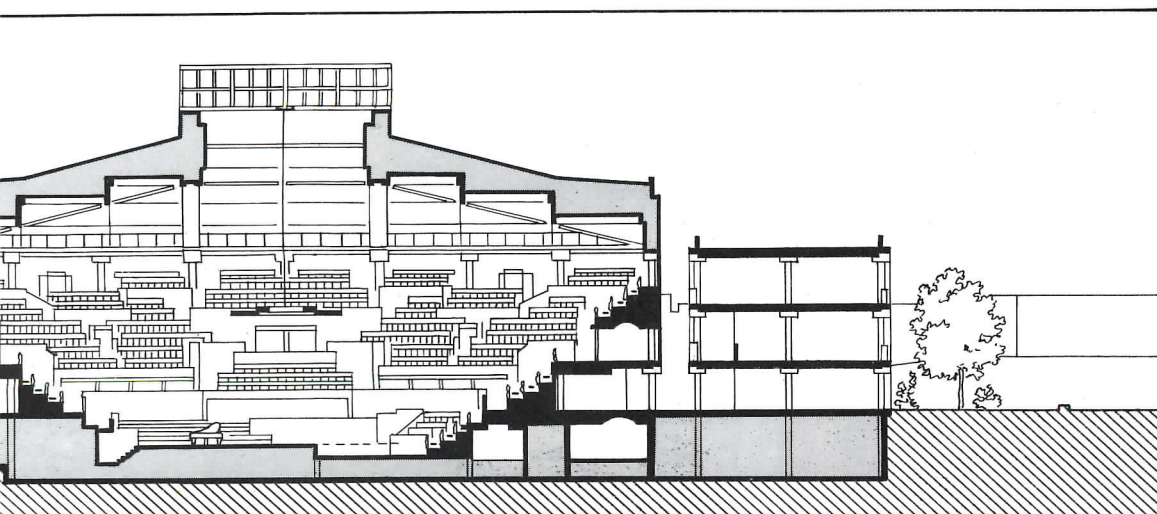

The palette of materials used for the exterior is repeated indoors: concrete block, exposed columns and column capitals, and narrow-sash fenestration. Dozens of different column/fenestration relationships occur throughout the building, with only a small sample being shown at far right. The photo, right, is at a corner on the second level.



Lighting is incandescent—applied judiciously and with considerable sense of purpose. Uplights on the column capitals on both the inboard and outboard sides of the passageway illuminate vertical and horizontal surfaces so that people can comprehend the space and see where they want to go. The passageways are given human scale and made festive by the arbor-like custom fixtures at ground level. In an ingenious touch, the architect provided translucent colored plastic in the leading edge of the indirect fixtures to let people know where the light is coming from, to pace the lighting, and to identify space use (with either yellow or magenta).



The delicately detailed fencing, along with the other construction elements of the complex, seem to carry on the tradition of the modern Dutch movement. The photo below shows a small seat on the upper level and looks across the passageway to colored glass in an inboard wall.

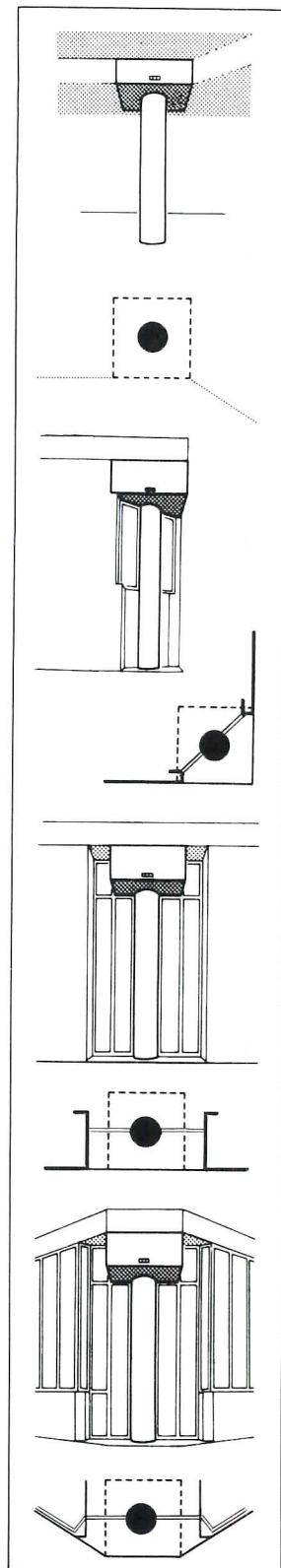
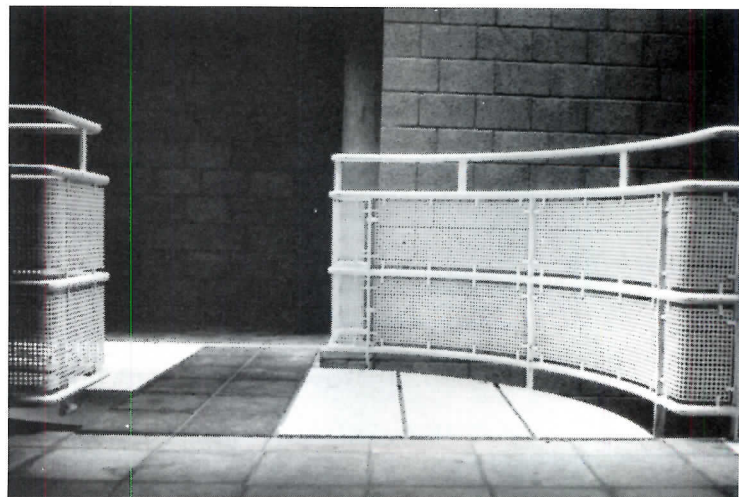
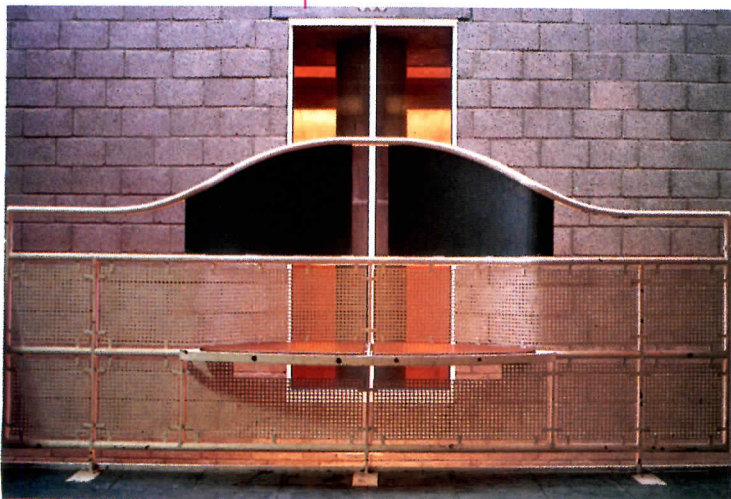

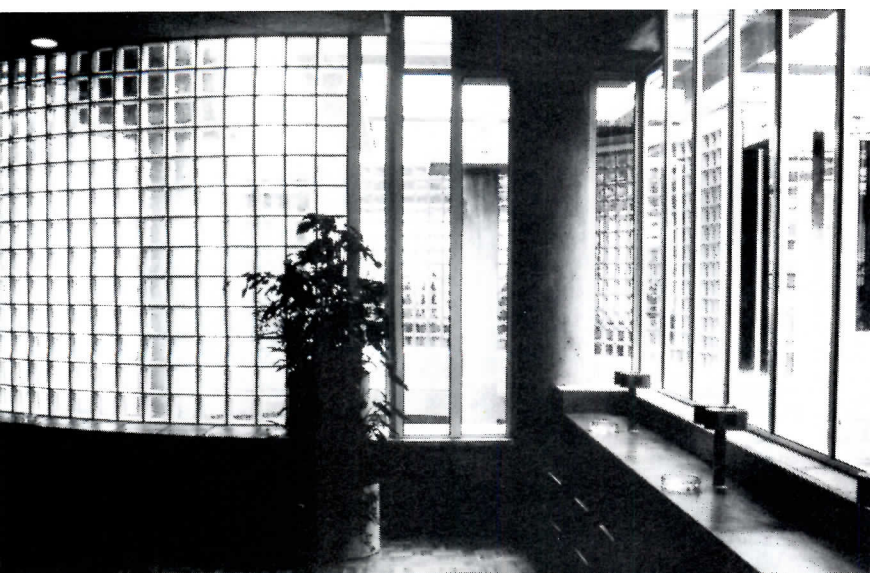
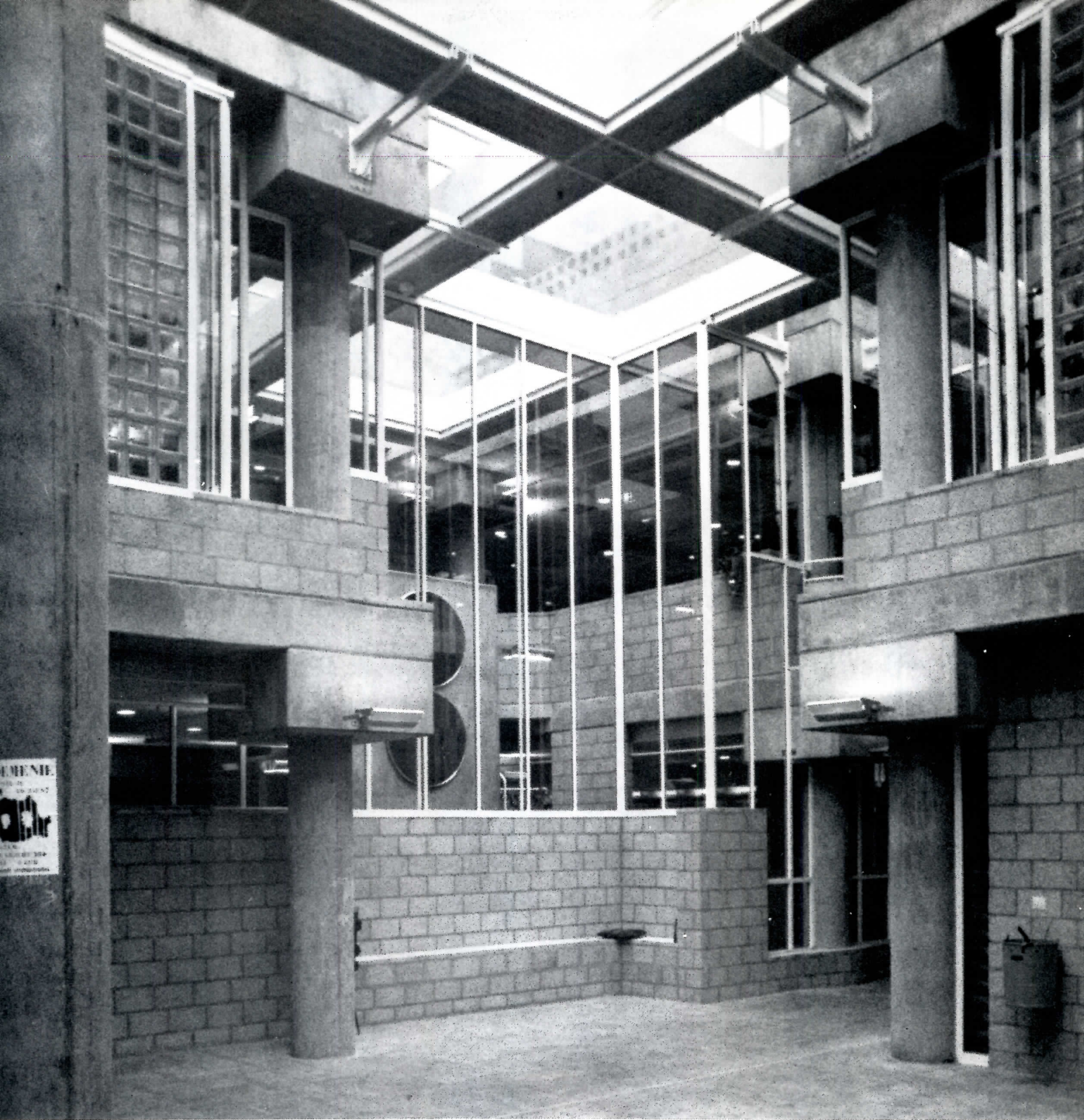

Passageways feed into large open areas with multifaceted planes of concrete block and narrow-sash glazing. Skylights sit atop overhead channels supported by pronged brackets attached to the column capitals. The channels also contain sprinkler piping and wiring for smoke detectors. At a corner near both the small and large halls, glass block adds a counterpoint to the design. Note the typically Dutch seating area for smoking and reading which is near a buffet.

**In Reading, England,
a multipurpose arena
uses electronics
to vary its
reverberation time**

How reverberant a hall sounds depends upon its volume and its absorption. Symphonic music calls for a long reverberation time, chamber music, less, and rock, nearly none. So, ordinarily, different kinds of music are performed in different kinds of halls—or in the case of popular music, the public often must put up with inferior sound. Some large halls have been provided with a limited range of variable reverberation times by mechanical means (movable panels that reduce the hall volume, that have both hard and absorptive surfaces, and movable banners or drapes). This can be expensive in initial and operating costs.

A different approach—electronic—can take a relatively “dry” hall and turn it into a reverberant one by adding sound from loudspeakers, in the frequency range of from about 70 Hz to 1250 Hz, that has been selectively picked up from the natural sound in the auditorium.

The first application of this technique, called “assisted resonance,” by AIRO, the English company that now markets it, was in the '60s in London's Royal Festival Hall to lengthen the reverberation time and increase power of the reverberant sound below 700 Hz.

Though the system originally was used to modify existing halls, and even a lecture room, it is now being designed into new buildings. Its first application for this purpose was in a new facility for the 822-seat Scottsdale (Arizona) Center for the Arts by architect Bennie Gonzales and acoustician Christopher Jaffe. The “assisted resonance” system allows the multipurpose facility to be used for everything from orchestral music to country and western. It subsequently was em-

A view of the Hexagon auditorium from the balcony which is divided into five segments, known as “vineyard terraces” from their use in the Berlin Philharmonic Hall 15 years ago.



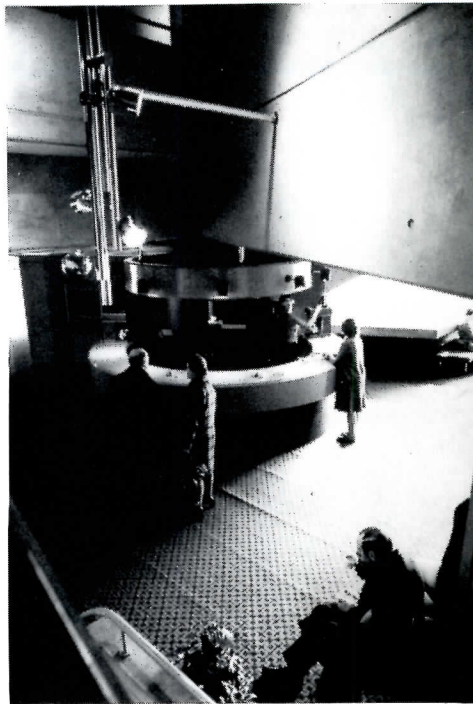

The Hexagon in Reading, England, 40 miles west of London, is sited in the midst of a large shopping center and office building complex. The multi-purpose arena, with maximum seating for 1,550 people serves an area with a population of 2 million. The lounges are available to shoppers and to area residents to have tea or coffee, to rest their feet, or to chat with friends. A feature of the Hexagon is its lunchtime concerts, often staged prior to a matinee drama production. Acoustics of the auditorium are easily changed by means of the "assisted resonance" system.



Main entrance of the Hexagon is down a short flight of steps from the mall level. Weight of the trussed roof structure is supported by an exposed precast concrete structure, in the plane of the standing-seam roof, which transfers its load to buttress-type columns. Architects: *Robert Matthew, Johnson-Marshall & Partners*; acoustics consultants: *the late Henry Humphries; SRL*.

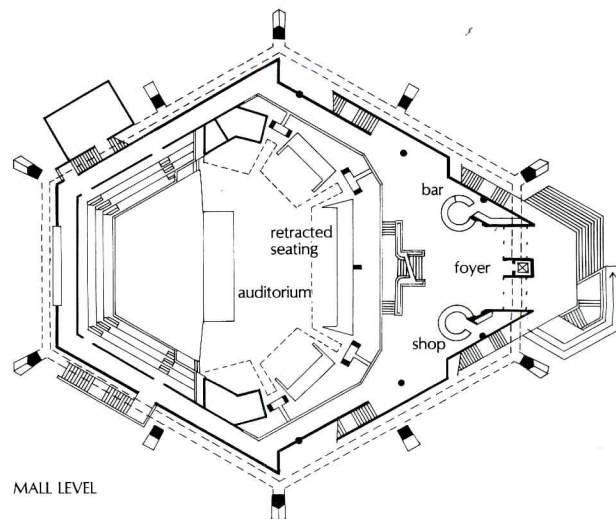
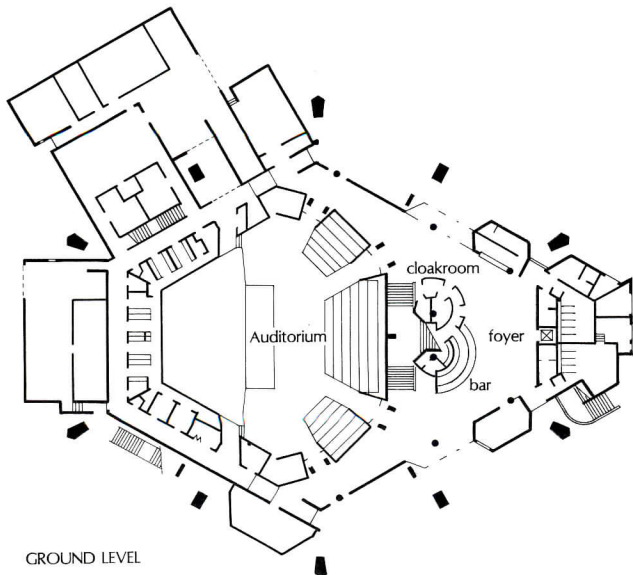

In the "assisted resonance" system, frequency-selective microphone assemblies pick up sound from the auditorium for amplification and reintroduction to the auditorium. For frequencies up to 350 Hz, the microphones are placed in Helmholtz resonators (drawing and photo). For frequencies from 350 to 1,250 Hz, the resonator would be too small, so simple parallel tubes are used (note them to the front and back of the Helmholtz resonator in the photo). The resonators and tubes are installed here in the rigging space next to a catwalk. Exact positioning of the microphones is somewhat a trial-and-error procedure. Microphones, generally, should be as far as possible from their respective speakers.

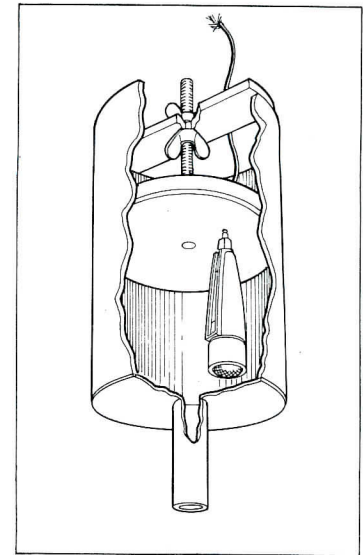
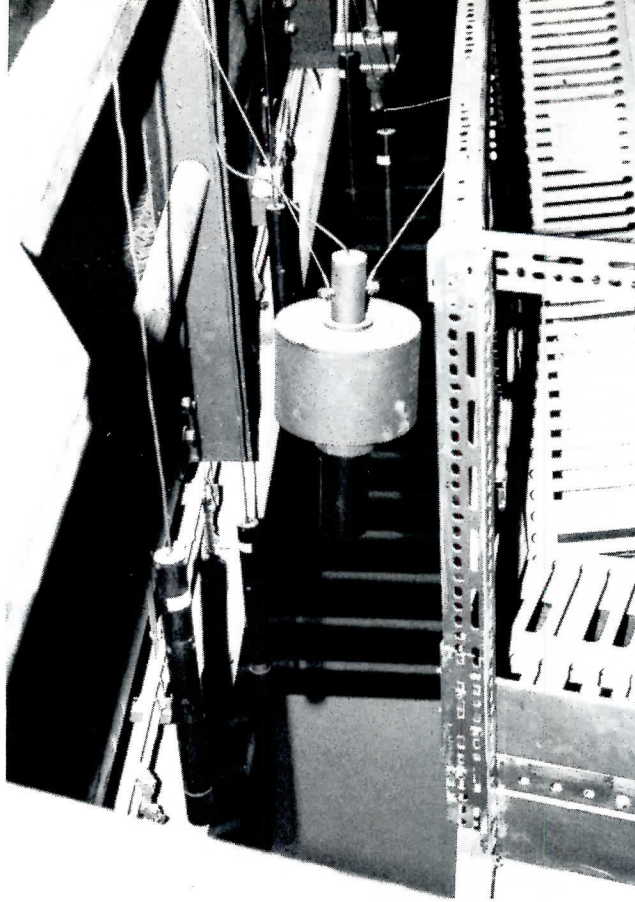

ployed for the 3500-seat outdoor Concord (California) Pavilion designed by architect Frank Gehry with acoustic design by Jaffe, which has a low roof and no side walls to contain the sound.

The building shown here, the Hexagon in Reading, England, named for its shape that reflects the seating arrangement for everything from symphony orchestra to boxing matches, is the most recent building to employ the system. (For the performance of a Bach chorale, the system was adjusted to the reverberation time of the church in which Bach originally conducted the music.) It will be used for an existing building in Kansas City, and is planned for a new performing arts center in Peoria. The system shows promise not only for multi-purpose facilities, but also for halls for which optimum volume to achieve a long reverberation time would be too expensive.

The system comprises microphones mounted inside resonators hung above the auditorium ceiling that respond to discrete frequency ranges in 90 steps from 90 Hz to 1000 Hz. The microphones are connected to amplifiers that feed loudspeakers at the top of the hall.

Basic principle of the "assisted resonance" system is illustrated in the drawing, right. The different curves of reverberation times for the Hexagon, natural and electronic-assisted are shown in the graph. The hall was designed with a relatively short reverberation time for speech, and reverberation is added in steps for musical purposes.

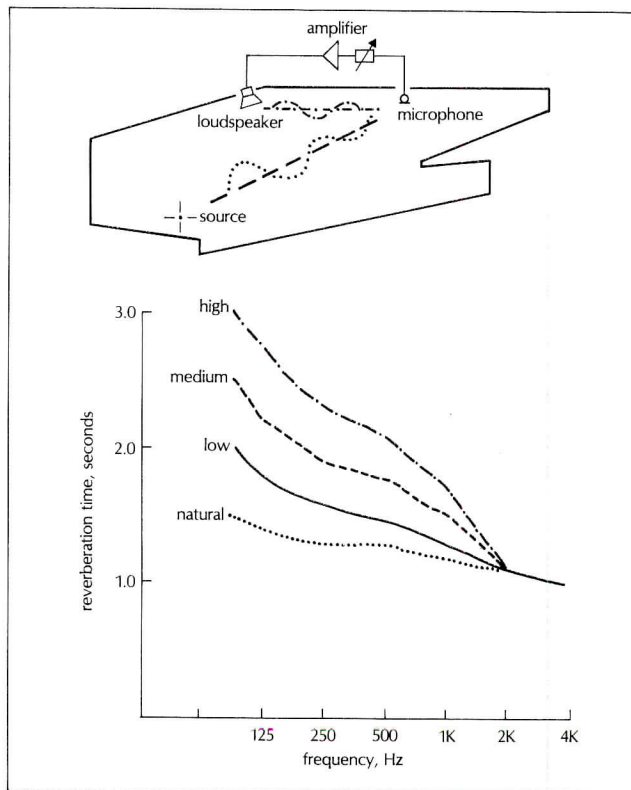

The plans show three different seating arrangements: in the plan at left, the proscenium is in place for theater, opera and musicals; (note the loss of balcony seats at far right and left); in the center plan, seating is arranged for theater-in-the-round or for boxing; in the plan at right the arrangement is shown for movies and for choral performance. Number of seats ranges from 575 for theater-in-the-round, to 1,550 for boxing.

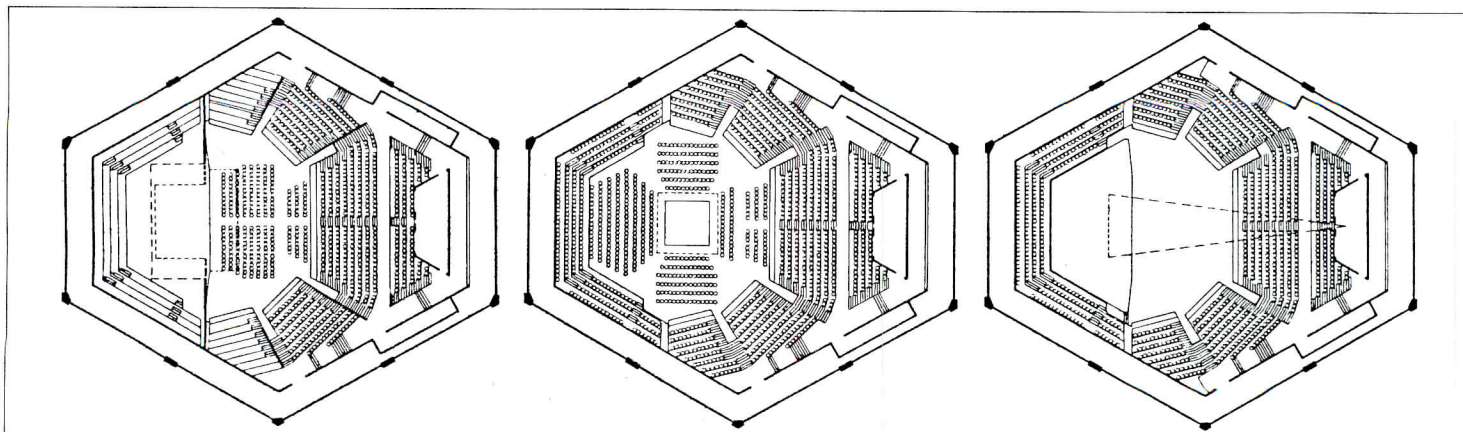

For more information, circle item numbers on Reader Service Inquiry Card, pages 169-170

Energy-conservative incandescent bulb to be available in 1981

Described as derived from a revolutionary development in incandescent light-bulb technology is a new lamp invented by General Electric Company. It is said to last four times longer than conventional incandescent bulbs of today, be three times as efficient, and cost a total of \$20 over its lifetime. Its suggested retail price will be \$10 when made available early 1981. The two-watt "Electronic Halarc" bulb has electronic controls in its base and in its arc tube to

instantly compensate for fluctuations in line voltage. Designed for an average life of 5,000 hours, it yields 250-watts on the "high" setting. According to GE, if during the 1980's one of the new bulbs replaces each 50/100/150-watt three-way lamp across the nation, the new bulb could be operated on high and still provide an energy savings of 40 billion kilowatt hours over its average life. ■ General Electric Co., Cleveland.

circle 300 on inquiry card

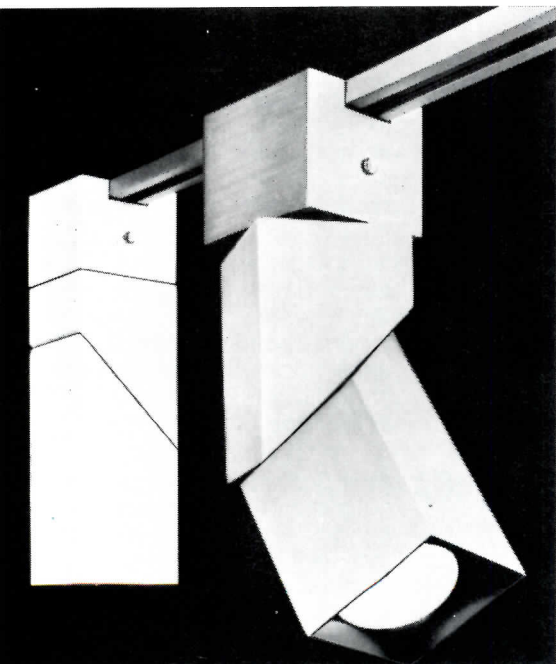
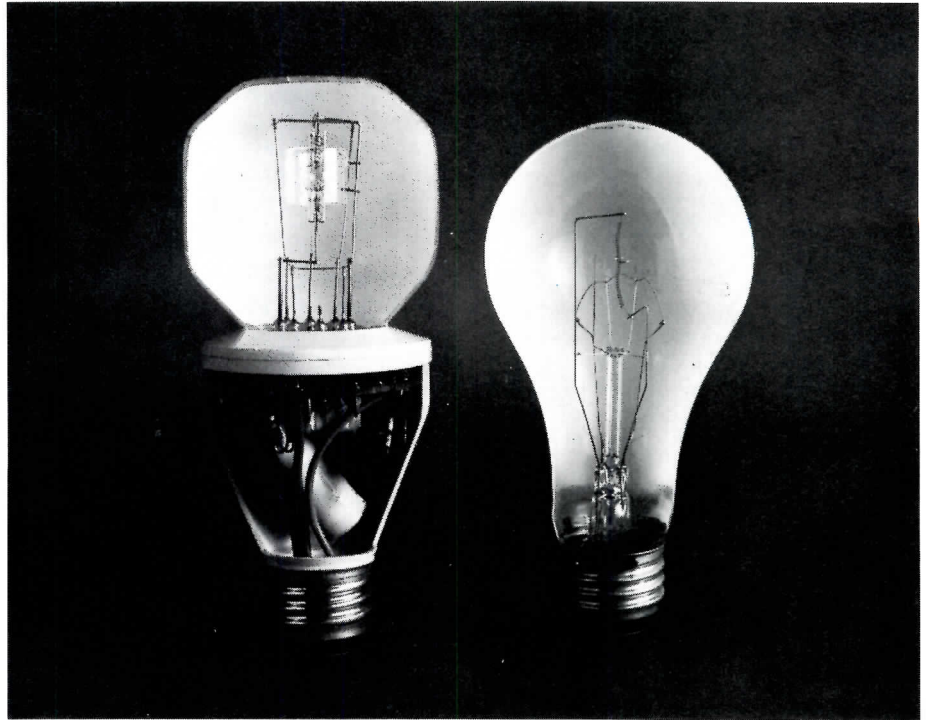

Track lighting has strong geometric form

Starting from the traditional design for track lighting, this fixture has a strong geometric, angular shape, and is totally adjustable. The base swivels 90 degrees and the lamp swivels another 360 degrees diagonally. Because of its design, the "Geometric" unit fits flush to the ceiling or wall, and its post,

harness, wires and connectors are completely hidden. It is available in two sizes, and is finished in polished or weathered brass, polished or satin chrome, or matte black or white. ■ Traklighting, Inc., City of Industry, Calif.

circle 302 on inquiry card
more products on page 125

Curtain wall designed for simplicity of field fabrication and appearance

A stick system, linear curtain-wall designed for inside glazing and readily adaptable to field fabrication is the latest addition to Northrop Architectural Systems. Designated the C-250 Linear Curtainwall, it is 2-in. wide, 5-in. deep and is offered in stock lengths of 24 feet. Because of its minimum projections and simple vertical grid, it has no strong visual character, but the appearance of the exterior can be varied through use of several mullion snap-in covers. ■ Northrop Architectural Systems, City of Industry, Calif.

circle 301 on inquiry card

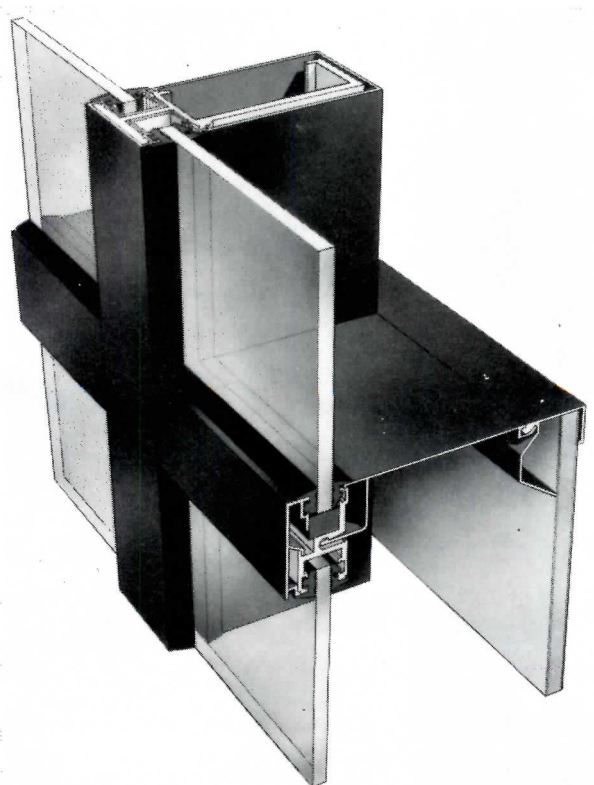

For more information, circle item numbers on
Reader Service Inquiry Card, pages 169-170

COMPOSITE FLOOR SYSTEM / The *Epicore* composite floor system with steel or concrete framing is explained in an eight-page application brochure. Drawings, installation photos and text describe the system, its advantages, and typical applications; technical tables provide data applicable to structures with relatively short spans and heavy loading. ■ Epic Metals Corp., Rankin, Pa.

circle 400 on inquiry card

VENTILATING FANS / A 12-page brochure covers a full line of ventilating fans for residential, commercial and industrial uses. Products shown include whole-house ventilators, window fans, exhaust fans and attic ventilators. Data are given on accessories, air moving capacities, installation tips and warranties. ■ Hunter Div., Robbins & Myers, Inc., Memphis.

circle 401 on inquiry card

ELECTRIC HEAT UNITS / Electric heaters for a variety of residential and industrial uses are shown in an eight-page brochure. Included are convection baseboards, floor drop-in heaters, bathroom ceiling fan/heaters, "snug-away" heaters for kickspace under cabinets, heavy-duty portables, unit heaters, and accessories. ■ Hunter Div., Robbins & Myers, Inc., Memphis.

circle 402 on inquiry card

INDUSTRIAL NOISE CONTROL / Written for professionals responsible for meeting OSHA or EPA noise exposure limitations, this 36-page booklet contains new text data and information on over 18 acoustical products and provides guidelines for problem solving in the industrial acoustical environment. ■ Owens-Corning Fiberglas Corp., Toledo.

circle 403 on inquiry card

OPEN OFFICE / A 32-page general information brochure illustrates the flexibility, versatility and cost savings features claimed for the *ASD* open office system. Offering designs for middle management, executives, secretaries, word processing, energy savings and power and communications, the bulletin describes each category with photos and copy. ■ Westinghouse Architectural Systems Div., Grand Rapids, Mich.

circle 404 on inquiry card

MASONRY SOLAR HOMES / "The Use of Solar Energy Heating Systems in Brick Buildings" is written for the homeowner interested in the applications of masonry construction to energy efficient housing. Their 24-page booklet focuses on "passive" systems, in which the collected heat of the sun is allowed to flow through the areas intended to be heated by natural means, such as convection currents. Combinations of both active and passive systems are shown; examples include brick homes in Virginia, California, Massachusetts and Ontario. The booklet has an extensive bibliography of organizations and publications devoted to solar energy. Published by the Brick Institute of America, 1750 Old Meadow Road, McLean, Va. 22102; copies are available at a cost of \$2.00.

SEISMIC ANALYSIS / An illustrated brochure describes this independent laboratory's test/analysis techniques for seismic qualification of nuclear power plant safety-related equipment. Aspects treated include combined test/analysis in which in-situ non-destructive testing is coupled with a mathematical model to determine dynamic characteristics, primary resonant frequencies and damping, using actual dynamic test results for verification. ■ Wyle Laboratories, El Segundo, Calif.

circle 405 on inquiry card

OUTDOOR PLAY EQUIPMENT / Creative play environments for all ages are shown in a 24-page equipment catalog. Featured are families of "nautical" and thematic play units, climbers, chain networks and equipment for special education requirements. Suggested playground layouts are pictured; space requirements, component specifications and prices are given. ■ Playscape Products, Long Island City, N.Y.

circle 406 on inquiry card

MOVABLE WALL SYSTEM / An illustrated bulletin reports the most recent laboratory-certified acoustic ratings for the *Trackwall* architectural movable wall system: STC 70 for the double-wall version; STC 51 for single *Trackwall*; and a STC of 50 for single walls perforated on one side. Design and engineering characteristics of the overhead-track-mounted room divider are presented, and on-site test data is given for a 16-year-old hotel installation of the *Trackwall* divider. ■ Industrial Acoustics Co., Bronx, N.Y.

circle 407 on inquiry card

INTERIOR LIGHTING / An interior lighting systems catalog describes this maker's complete line of lighting/ceiling components incorporating *Holographane* luminaires, modular suspension systems, air distribution equipment and acoustical materials. Each ceiling featured in the color, 24-page catalog can be arranged in a variety of configurations; photographs illustrate many actual installations. ■ Johns-Manville Service Center, Denver, Colo.

circle 408 on inquiry card

PAINT SELECTION / Published in wall-chart form, the "Guide to Choosing Paint for Interior Surfaces" provides practical information on the correct use of the six generic binders: alkyd, vinyl, epoxy, latex, polyurethane and chlorinated rubber. The chart classifies and rates each paint for its resistance to a wide range of typical exposures; suggests preparatory coats; and gives coverage data for materials such as wood, metal, steel, concrete, drywall and plaster. Ten different interior space designations—offices, lavatories, food preparation areas, etc.—are classified by their level of exposure to water, chemicals, impact, mechanical and food, and each of the six binders is specifically recommended and/or qualified. The professional selection guide is available for a \$2.00 handling charge from the Painting and Decorating Institute, 8705 North Port Washington Road, Milwaukee, Wisc. 53217.

THE dryvit[®] SYSTEM

Learn
Why
It
Makes
Sense!

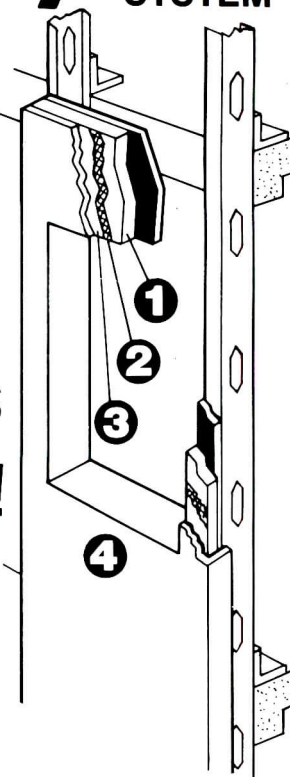

- 1 First a rigid panel of Expanded Polystyrene that offers optimum insulating qualities. It becomes the foundation of any "U" value that is required to really control heating and cooling costs.
- 2 Our specially woven and treated Fiberglass Fabric that prevents surface cracking and that's important — no cracks mean no leaks or maintenance.
- 3 Our special Primus/Adhesive, a unique plaster material mixed with Type I Portland Cement to adhere Dryvit Insulation Board to the back-up surface and to embed Dryvit Reinforcing Fabric on the face of the board.
- 4 Dryvit Finish; a synthetic plaster material having high bond strength, extremely pleasing in appearance in a choice of 14 integral colors and various textures. It provides a water resistant, jointless exterior that is maintenance free.

Lightweight Is Important

Only 7½ pounds per square foot, so you can reduce your steel usage substantially. Thinner walls also increase useable floor space.

DRYVIT SYSTEM, INC.
Warwick, RI—Tulsa, OK

Circle 39 on inquiry card

At Dryvit We Speak A Rare Language...

OUTSULATION™



Out'·su·lā·tion (n)

1: placing insulation on the exterior of the wall. 2: eliminating all thermal bridges. 3: the wall structure itself goes inside the building.

Frankly, the world needed this new word. The phrase "energy savings" has become so abused it is almost hackneyed. From a pup tent to a light bulb, its credibility is being challenged.

On the other hand, DRYVIT has been used as the exterior wall and insulation system on hundreds of projects in the last

decade. From 42-story prestige hi-rises, like the Tiara condominium above, to office buildings, sporting arenas, shopping centers, hospitals, schools and more. The actual energy dollars saved with the DRYVIT "Outsulation" System was much greater than design calculations projected (applying conventional heat loss calculations—R values and U factors).

DRYVIT places insulation on the outside of the structure, the most efficient placement for all building construction.

Thermal bridges are eliminated and the insulation value of the DRYVIT System is constant... unaffected by changes in temperature and moisture.

Make us prove it. We have meaningful case histories on all types of new construction and retrofit. Write or call stating your application.

dryvit®
SYSTEM
INC.

LENNOX BREATHES NEW LIFE INTO OLD BUILDINGS.

The Lennox "Multi-Mod™" floor-by-floor HVAC system brings new comfort, savings and safety to high rise buildings.



An outstanding example of the Lennox "Multi-Mod" system in a retrofit installation is the Neil Anderson building in Ft. Worth, Texas. Owner: 411 Company. Engineer: Love, Friberg & Assoc. Inc. Mechanical Contractors: Freer (Ft. Worth); Berger Eng. (Dallas).



Take it from Dave Lennox. . .

The Lennox "Multi-Mod", floor-by-floor system offers high rise builders and renovators an uncompromising flexibility that central station systems cannot provide:

- Fits into almost any type structural design, new or old, making it ideal for retrofit installations.
- Gives tenants control of their own temperatures and power usage, including "after-hours".

• Depending on the design, significant energy savings can be achieved by:

- Reclaiming heat from building lights
- Outdoor air cooling
- Efficient part occupancy operation
- Low transport energy

• "Multi-Mod" is a low pressure system . . . extremely quiet.

• Costs less to install because the equipment fits in an elevator.

• If a fire occurs, smoke can be confined to that floor.

• Equipment shutdown affects only one floor at a time . . . less disturbing to tenants.

For complete information, write Lennox Industries Inc., Promenade Tower, P.O. Box 400450, Dept. 966, Dallas, TX 75240.

LENNOX

AIR CONDITIONING • HEATING

"Attaboy, Dave!"

SPORTS SURFACES / *Bolltex* textile floor surfacing, originally designed for indoor tennis courts, is offered in several weights for regular and heavy-duty indoor recreational use. The long-wearing material, installed over existing flooring or subflooring, provides true ball bounce and a degree of cushioning that reduces player fatigue. *Bolltex* surfaces are said to lessen glare, absorb sound, and act as an insulating layer. ■ Albany International Corp., Albany, N.Y.

circle 303 on inquiry card



ORNAMENTAL PLASTER / Exact reproduction of original plaster is possible, especially for restorations and renovations. The making of molds and castings of duplicate pieces for restoration of cornices, brackets, anaglyphs and medallions can all be made, and consulting and installation services are available. ■ Dovetail, Inc., Sudbury, Mass.

circle 304 on inquiry card

VINYL SAFETY SIGNAGE / Durable and economical safety and directional signs that meet code and ordinance requirements may be ordered in any ink color and a large variety of type faces. The signs are made of rigid, vandal-resistant vinyl with sub-surface graphics and a strong adhesive backing for easy installation. Standard signage may be combined with the specifier's own artwork. ■ Litho/Color Inc., Detroit.

circle 305 on inquiry card



OFFICE SYSTEMS / The latest generation in the "Design Option" series of office components, "Design Option III" comprises a complete coordinated line of space dividing panels; work surfaces; storage modules; lighting, electrical and communications distribution elements; and accessories such as accent and sound absorber panels. Oak veneer is a new finish option for the redesigned, rounded-corner panels. ■ E. F. Hauserman Co., Cleveland.

circle 306 on inquiry card

circle 40 on inquiry card

DEMAND CONTROLLER / The "Model HES 320" controller monitors kilowatt usage and adjusts demand by eliminating sharp peaks during each preset interval, shedding and restoring power loads automatically. This energy-saving unit has been designed for easy

modification: optional thumbwheel modules on the demand controller panel make load priorities and kW thresholds simple to change. The system's economic justification through rapid payback is centered in installations which typically use 1000 kW or more per demand interval: commercial buildings, educational institutions, hospitals, industrial plants, etc. ■ IEM /Haughton Energy Systems, Toledo, Ohio.

circle 307 on inquiry card

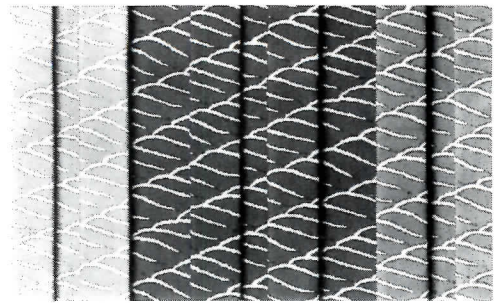

CONTRACT FABRIC / A striking diagonal pattern, "Downhill Print" is based on a classic Japanese design element symbolizing a sloping mountain landscape. The pattern is printed on a 54-in.-wide, *Zepel*-finished linen/cotton fabric, and is offered for contract applications in 15 colorways. ■ Lee/Jofa, New York City.

circle 308 on inquiry card
more products on page 127

Vollrath walk-ins mean royal treatment for any installation



The Biltmore Estate, Asheville, NC

On the grounds of the lavish Biltmore Estate, America's finest castle and North Carolina's outstanding tourist attraction, is Deerpark—the Biltmore dining experience. Only the finest quality refrigeration equipment is good enough for this outstanding facility. That's why a Vollrath walk-in cooler-freezer was specified.

From spec to finished project, Vollrath specialists assist in mechanical/electrical requirements; size, storage and materials data. On time delivery with reliable post-sale service is also a part of Vollrath's royal treatment. And isn't that the way *you* and *your* clients should be treated?



DEERPARK...
where Vollrath's dual temperature walk-in is part of the Biltmore dining experience



Vollrath serves markets world-wide with modular walk-in coolers, freezers, and refrigeration systems... when only the best is good enough.

THE VOLLRATH COMPANY / SHEBOYGAN WISCONSIN



The capable hands of Vollrath build exactly what you want in a quality walk-in cooler/freezer.

Circle 41 on inquiry card

Oasis.



The water cooler that's
built without shortcuts.

OASIS  Ebco Manufacturing Co., Columbus, Ohio 43213

Circle 42 on inquiry card

PADDLE FAN / The "Veranda" fan comes in two sizes: a 36-in. model with 4000 cfm on high speed, 2700 on low; and a 52-in. fan with 8000 cfm on high, 5500 on low. Fan consists of the two-speed motor; housing assembly with switch; ceiling canopy; decorative styrene or cabinet wood blades; and mounting bracket and hardware. A lighting kit is available for all models; there is a choice of 12 UL-listed fan variations. ■ Nutone Div., Scovill, Cincinnati.

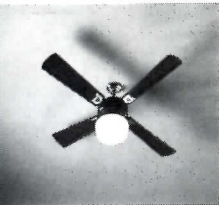

circle 309 on inquiry card

FIRE-BLOCKING SEALANT / This rubber-based silicone penetration seal, designed to block the spread of fire, dust, gas and water through cable, conduit or pipe openings in walls and floors, is now available in small-size containers of up to 20 lb, easily used by air conditioning, plumbing, and electrical contractors as well as by the home owner. The sealant foams-in-place and sets within a matter of minutes; a few inches of foam can withstand direct fire exposure for at least one hour. ■ Dow Corning, Midland, Mich.

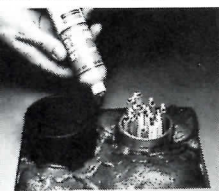

circle 310 on inquiry card

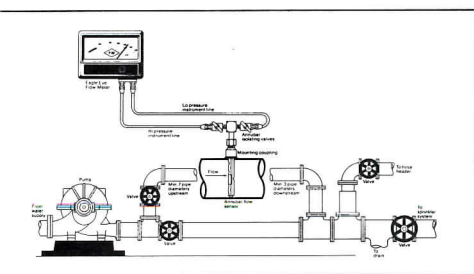

FIRE PUMP FLOW METER / The "Eagle Eye" fire pump flow meter is said to be a reliable, economical and fast instrument for monitoring sprinkler system water flow directly in gpm. The device is portable, and not subject to wear or scale buildup. An *Annubar* flow sensor spans the inside diameter of the sprinkler line, and measures both velocity and static pressures. A single meter with quick connect fittings can be connected to each fire pump's individual *Annubar* installation in turn to test each pump in a multiple fire pump system. ■ Dieterich Standard Corp., Boulder, Colo.

circle 311 on inquiry card

BTU METER / The "Model 2/50" Btu meter measures temperature differences of water and flow to provide six-digit output information in kilowatt-hours. The battery-operated unit consists of the water flow meter with electronic calculator assembly attached, and the remote sensor assembly. Suggested applications include measurement of heat consumption in apartments and condominiums, monitoring solar collector efficiency, and output measuring of hot water heating systems. ■ ISTA Energy Systems Corp., Cranford, N.J.

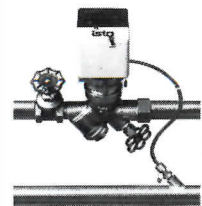

circle 312 on inquiry card

ADD-ON ACOUSTICAL PANELS / Made of one-in.-thick fiberglass wrapped in fabric, "File-Wraps" panels add color, texture and sound absorbency to file fixtures or other metal surfaces in the open office environment. The panels attach to metal surfaces with magnetic tape. A selection of standard fabric colors and panel sizes is offered to coordinate with this manufacturer's acoustical screen line, or to complement other office furnishings. Custom sizes and fabrics are also available. ■ TIW Industries, Inc., Rochester, N.Y.



circle 313 on inquiry card



WOOD TOILET TANK / An addition to a line of oak bathroom products, this wood toilet tank connects to most rear- or top-spud bowls. It is also available with a white, papyrus or sand colored toilet bowl. ■ Heads Up, Inc., Santa Ana, Calif.

circle 314 on inquiry card

Granite.

Beautiful for heavy traffic areas.



Architects: Lawrence Halprin & Associates



Architect: Joe Karr & Associates, Chicago, IL

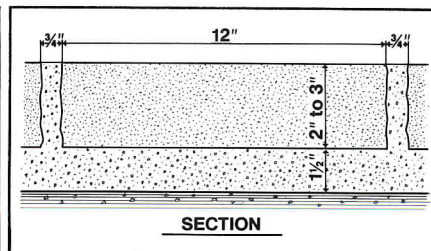
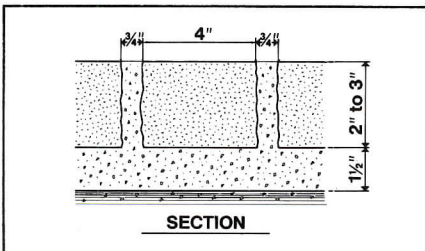

Cold Spring granite is a natural for landscape applications. Its warm colors and natural textures blend beautifully with the environment. And at the same time, granite provides the designer with the flexibility he needs to create areas of unusual and lasting beauty.

At Cold Spring we now have a wide variety of Module Pavers and Durax Blocks available. For more information, plus a packet of full color literature illustrating our products in use, call toll free **800-328-7038**. In Minnesota, call (612) 685-3621. Or write to the address below.



Cold Spring Granite Company, Dept. AR-8B 202 South 3rd Avenue, Cold Spring, MN 56320

Circle 43 on inquiry card

GAF® Scalemaster® Ultra Stable Polyester Intermediates. Toulouse would have envied our stability.



The brilliant Toulouse-Lautrec was almost as famous for his excitable personality as for his Moulin Rouge beauties.

If only he'd had our new Scalemaster® Ultra Stable diazo polyester intermediates around his studio to preserve his lithography, we could reproduce his famous works from those same intermediates today. The reason is that Ultra Stable resists yellowing with age or usage.

As a matter of fact, it is many times more resistant to background yellowing due to room light, sunlight, and the ultra violet light sources of reproduction machines.

Scalemaster Ultra Stable intermediates are available in sepia, with single and double matte versions. You'll also enjoy excellent visual impact from a clear, ultra white background with crisp lines, and excellent reprint capability due to the very high opacity of the images.

In addition to Ultra Stable, GAF offers a premium quality line of Scalemaster polyester intermediates with normal yellowing resistance. Blackline and sepia line products are available in single or double matte versions in 2, 3, or 5 mil weights.

For your convenience, Scalemaster products come in standard and rapid speeds for fluorescent and mercury vapor diazo printers.

Ultra Stable won't turn yellow even in bright sunlight. And we'll prove it. Just send for our sample kit with Toulouse-Lautrec poster.

We'd like you to see how stable we really are, by sending for a free Ultra Stable Intermediates Sample Kit. The kit contains a reproduction master, developed sample of our Ultra Stable film, unexposed sample sheets of our Ultra Stable film, which you can run on your own equipment and instructions so you can test us against whatever intermediate you're using now.

As an added feature, we'll also send you an 18" x 24" poster of the famous "Jane Avril Jardin de Paris" that is suitable for framing. Just mail the coupon today.

So even when things get a little excitable in your studio, you won't have to worry about the background of your intermediates with GAF Scalemaster Ultra Stable Polyester backing you up.



Products for Design

FOR THE MASTER DESIGNERS
OF TOMORROW...TODAY.

Circle 44 on inquiry card

©1978 GAF

GAF Corporation/140 West 51st Street/New York, N.Y. 10020

O.K. Show me how stable your new Ultra Stable is.
Send me a Sample Kit to test against my intermediate.

Name _____

Address _____

Title _____

City _____ State _____ Zip _____

Organization _____

Phone Number _____

There are _____ designers in my studio. We're now using _____ brand intermediates.



Contact Your Volclay Panel Distributor

Internationally Distributed.

For your U.S. distributor call Sweet's Buyline

- England, Ireland, Scotland, Wales: Rawell Marketing Ltd. Telex 628497 Rawell G.
- France: Societe Arpec Telex 610 050 Arpec
- Sweden, Norway, Denmark, Finland: Ahlsell, I. R. Telex 19338 Alsel s
- W. Germany, Benelux, Switzerland, Austria, Saudi Arabia: Huecker and Rasbach Telex 415729
- Venezuela: Tecnoconcret C.A. Cable: Teconcret
- Philippine Islands: Three Fold Marketing Corp. Telex 7222223 RHPPH 3 Fold Manila
- Hong Kong: LEUNG Pak-Hong Cable: HARMONY Hong Kong
- Quebec, Atlantic Provinces, Eastern Ontario: Bemalux Inc. Phone (514) 337-2770
- Western Ontario, Manitoba, Saskatchewan: G. D. Johnson Ltd. Phone (204) 233-4107
- Alberta: Fabrikem Construction Supplies Ltd. Phone (403) 244-3322
- British Columbia: Fabrikem Construction Supplies Ltd. Phone (604) 253-3177



Circle 47 on inquiry card

Firm changes

W. R. Frizzell Architects announce the appointment of Edward R. Chatelain as vice president of marketing.

Howard Rosenfeld, AIA, has joined the executive staff of Froehlich & Kow, Architects as their new administrative project manager.

Geddes Brecher Qualls Cunningham: Architects is pleased to announce that Herbert W. Levy, AIA, has become a member of the firm. Steven Gatschet and Ronald Kobelin have been named associates in the firm, and John Strite has joined the firm as director of GBQC interior planning group.

Gensler and Associates/Architects announce their new associate, Leonard Scott. Joining the firm are Bruce E. Campbell, Jr., Edward K. Connors, Jr., and James Hill.

Geotactics, Inc., an architectural and planning firm, announce that Joan Kleeman has joined its staff.

Golemon & Rolfe, Architects have announced that J.D.F. Boggs and Ed Gonzalez have been elected senior associates. Charles H. Rosenbaum, George E. Newman, Ronald D. Lyle, Dai-Wei Tan, and Tom Robson have been named as associates. Elected to the board of directors are: John S. Crane, AIA, Allen G. Rice, AIA, and John M. Farrell, AIA.

The architectural firm of Gorman/Richardson Associates, Inc. announce that David C. Cary has joined the firm as a principal and vice president.

With the recent appointment of Jack Weinberger, PE as executive vice president, Greenleaf/Telesca Planners, Engineers, Architects, Inc., announce the election of John W. Greenleaf, Jr., PE as chairman of the board and chief executive officer. Francis E. Telesca, AIA has been elected president. He will perform the function of general manager.

R. Garey Goff, AIA, and Jerry Guy, PE, have been named to professional associate posts for the Nashville-based firm of Gresham and Smith. They serve as director of architectural services and director of marketing.

Gruzen & Partners, announce the expansion of its partnership with the promotion to partner of Burton W. Berger, AIA, director of the firm's New Jersey office, and David M. Ziskind, AIA, director of the firm's justice division. In addition, Thomas C. Lehrecke, AIA, and Charles Silverman, AIA have been promoted to associate partner, Barbara Geddis, AIA, to senior associate, and Peter Gumpel, AIA, Marion Hunt, Scott Keller, RA, and Ralph Steinglass, AIA to associates in the firm.

HTB, Inc. announce that Kelly S. Duiker has joined the firm as marketing public relations coordinator.

Haines Lundberg Waehler announce the following appointments: as partner: George P. Labra; as senior associate: Seymour L. Fish; as associates: Michael S. Greenberg, Shahid R. Khawaja, Leevi Kiil, Ju-Chien Ru, Sergio Santurro and Edy B. Zingher. Louis L. Marines has joined the firm as director of business planning and development and Theodore S. Hammer as director of design.

Lois E. James has been named to the public relations position in the firm of Hansen Lind Meyer, P.C., A/E, and John E. Carlson, AIA has been named associate.

Jack A. Ross, AIA, has been named director of the new northern California office of Irwin & Associates AIA, Long Beach, California.

Stephen B. Jacobs & Associates, P.C. Architects and Planners announce that Gerald J. Hallissy, AIA has joined the firm as a partner.

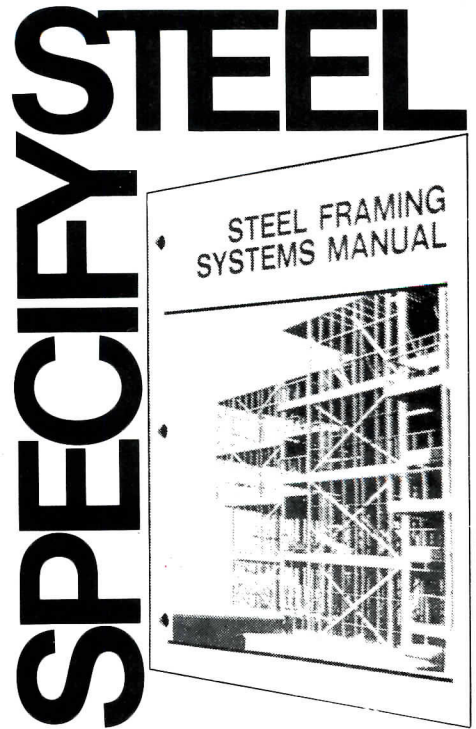

Steel framing is rapidly becoming the system of choice among specifiers for all types of construction.

No wonder. Steel framing systems offer high strength with low structural weight... excellent thermal resistance for energy savings... pre-punched studs to facilitate utility installation... and good fire and sound ratings.

Steel framing systems are also among the fastest to erect — whole sections may be easily pre-fabricated and are compatible with most facing finishes.

All of these advantages mean durability, versatility and design freedom.

Now, you can get the complete information on steel framing in a new publication, "The Steel Framing Systems Manual," from ML/SFA. In it you'll find details on steel framing's many advantages, a specification guide for cold-formed steel framing, and detailed sections on fabrication, connections and erection. The manual is fully illustrated with diagrams, photos and case history reports.

For your FREE copy, write ML/SFA.



Circle 48 on inquiry card

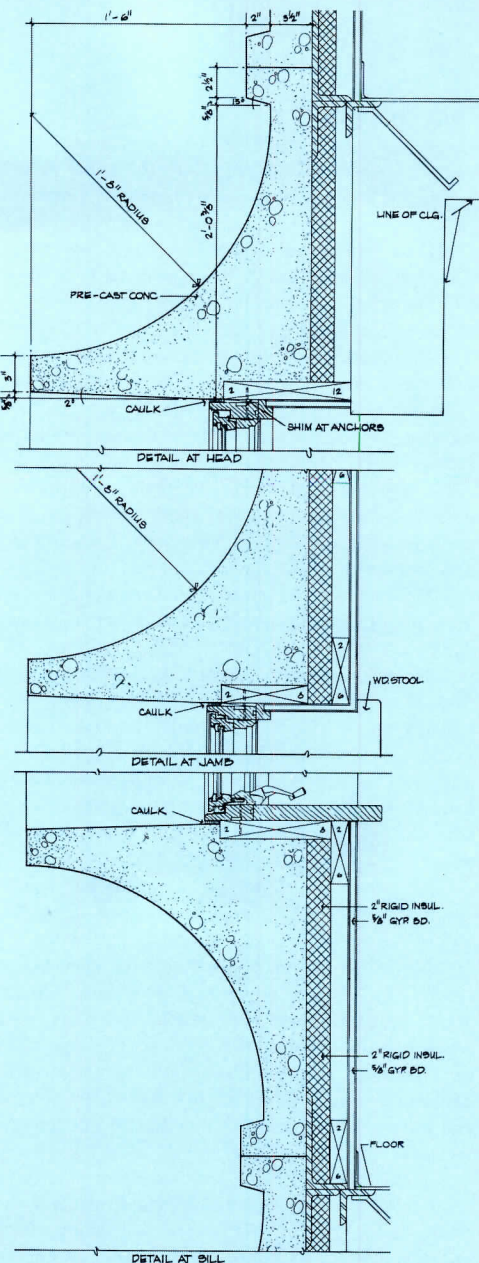

Columbia Court—Housing for the Elderly
Muskegon Heights, Michigan
Architect: Haughey, Black & Associates;
Battle Creek
Installation: Perma-Shield casements
in precast panels

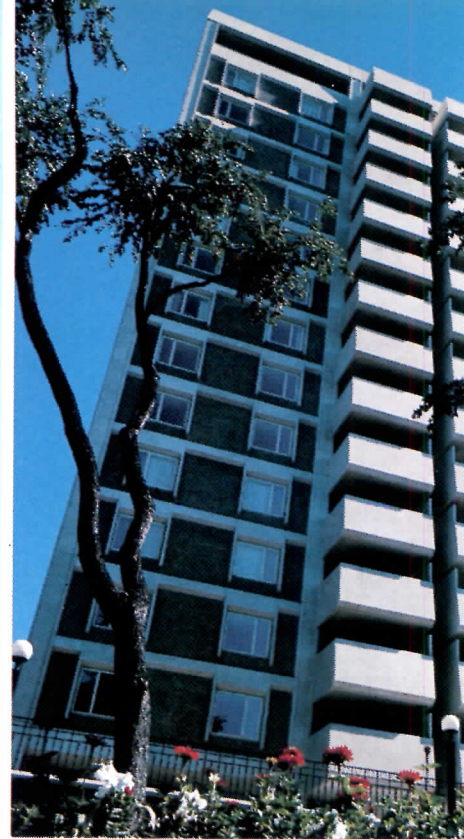

Concrete evidence

Structural harmony was only one of the beautiful reasons why these project architects chose Andersen® Perma-Shield® windows.

They also knew Perma-Shield windows have many of the same long-lasting qualities as their concrete surroundings. Andersen's tough, protective sheath of rigid vinyl won't rust, pit or corrode. Won't need painting every few years.

The architects also liked how easily Perma-Shield windows install into concrete and masonry. And how they keep occupants comfortable while keeping fuel and maintenance costs down. Andersen Perma-Shield windows are made of wood, sheathed in vinyl and built two times more weathertight than industry air-infiltration standard I.S. 2-73 to help seal out dust and drafts. Help seal in comfort.

Hope's reversible series 3000

The big turn-around in custom heavy steel windows

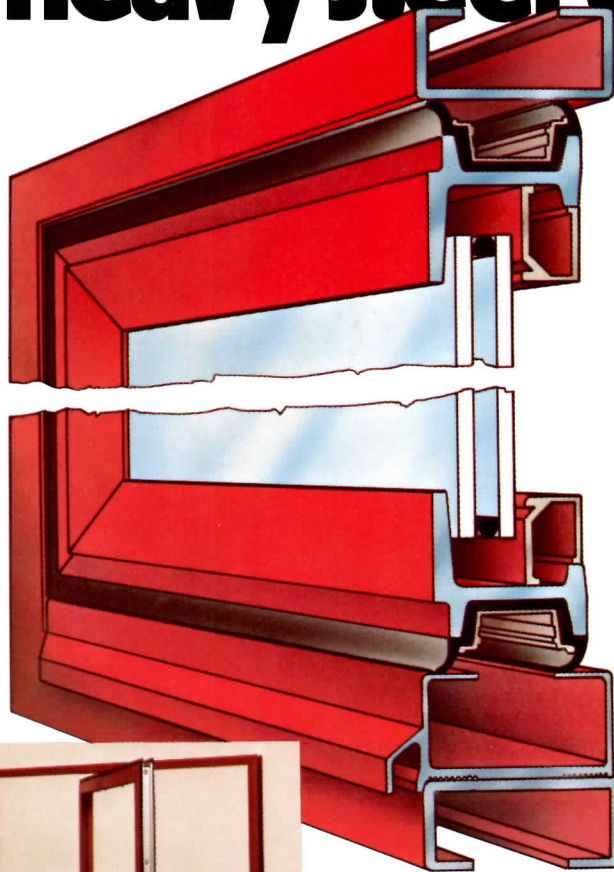

All reversible windows share one obvious advantage. They solve expensive cleaning problems. By 180° rotation, exterior glass surfaces can be safely cleaned from inside the building. But Hope's Series 3000 windows offer other advantages that aren't so apparent. And for a good reason — Hope's believes that strength and operation should never interfere with aesthetics.

Because steel is three times stronger than aluminum, large expanses of glazing can be accommodated without massive framing. This means reversible windows can be designed up to eight feet high and five feet wide, while increasing structural integrity and maintaining graceful sight lines.

Hope's provides two different operating systems — occupant life-safety and custodial. One adds functional good looks, the other can't be seen at all. Of course

every Series 3000 window is fully weather stripped and has a generous glazing space, accepting up to 1" thick insulated glass.

There is one more advantage and it *can* be seen. Hope's unique Ultraclad PVC finish. It is without exception the toughest, most corrosion resistant finish available today.

For more information on the Series 3000 and other custom steel windows, contact the people at Hope's. Steel windows make a building what a building should be. Hope's can make the windows.

ROBLIN
HOPE'S WINDOWS

ROBLIN ARCHITECTURAL PRODUCTS COMPANY
84 Hopkins Avenue • Jamestown, N.Y. 14701 (716) 665-5124

Circle 67 on inquiry card

It knows how to save water. Because it "sees" when to flush.



The Sloan OPTIMA™ **sensor-operated** Automatic Flushing System. No handles. No timer. Flushed by an invisible beam of light.

It's Sloan's great idea for cutting water consumption, while increasing sanitary protection. And the key to it all is the Sloan **OPTIMA** Electronic Sensor.

It "sees" when to flush with an invisible, continuous light beam. When a user approaches the fixture, he reflects the beam back into the **OPTIMA's** scanner. The electronics take over and when the user steps away, the flush valve is tripped by a solenoid.

The **OPTIMA** offers the ultimate in sanitation because the user can't "forget" to flush. And since fixtures flush only when they

are used, precious water is conserved.

The **OPTIMA** is designed for easy, attractive installation. It works with the Sloan Solenoid-Operated Flush Valve that matches your application. This advanced Sloan **OPTIMA** System gives you a trouble-free, water-wise answer to high-volume flushing problems in hospitals, sport complexes, municipal and office buildings, and transportation terminals.

For more information, write for our new brochure.

Sloan Flush Valves. Anything else is a waste of money.



SLOAN VALVE COMPANY

10500 SEYMOUR FRANKLIN PARK, IL 60131

Circle 68 on inquiry card