



GENERAL AMERICAN LIFE INSURANCE HEADQUARTERS BY JOHNSON/BURGEE

THREE NEW LIBRARIES DESIGNED FOR READERS

NEW CORPORATE COMPLEX FOR FLUOR CORPORATION, BY WELTON BECKET ASSOCIATES

BUILDING TYPES STUDY: BUILDINGS FOR INDUSTRY

FULL CONTENTS ON PAGES 10 AND 11

# ARCHITECTURAL RECORD

JULY 1978

7

A MCGRAW-HILL PUBLICATION

FIVE DOLLARS PER COPY

# The commercial sheet vinyl floor from Armstrong. At this West Virginia school, 800 students test its beauty and durability every day.

Architect: Kenneth F. Weimer, AIA, Richmond, Va.  
General Contractor: W. Harley Miller, Martinsburg, W. Va.  
Flooring Contractor: Standard Acoustical Products, Inc., Hagerstown, Md.



Like our Second Look® I and Second Look II ceilings—shown below at far right and center, respectively—Bold Look I brings a whole new look to the overhead world.

It's a look we've artfully designed for both beauty and economy. Because what we've done is to use standard 2' x 4' lay-in panels with an exposed grid in a way that disguises the 2' x 4' repeat. The grid is slightly recessed, blending with score marks which divide the panel into surface squares the size of ceiling tile. What results is an acoustical ceiling that gives you a rich look without a rich price tag.

In the case of Bold Look I, each

handsome rough-textured 24" x 48" panel is scored in both directions with one-inch-wide routings that divide the surface into eight tilelike sections. Second Look I, with its smoother surface, is also divided to simulate 12" x 12" tile, while Second Look II provides the broader look of a 24" x 24" tegular-edge panel.

So what you end up with is a ceiling that combines the beautiful efficiency of a tilelike look with the cost efficiency of an exposed-grid system—a combination you can't beat for good looks or good sense. To learn more, write Armstrong, Dept. 87NAR, Lancaster, Pa. 17604.



Bold Look I



Second Look II



Second Look I



FROM THE  INDOOR WORLD® OF  
**Armstrong**

For more data, circle 2 on inquiry card

## Letters to the editor

I was most pleased to see a short article last month on one firm's attempts to deal with the pending influence of computers upon the architectural profession. [RECORD, April 1978, page 65 *et seq.*] I heartily applaud the efforts at CRS, but, at the same time, wish to put forth a set of concepts and clarifications.

To begin with, one should point out the difference between computer-aided design (usually referred to as CAD) and automated drafting (AD). By the very nature of the terms, one implies partnership and the other replacement. Computerization for the sole purpose of manpower reduction is a shortsighted goal, one which can only invite Luddite attacks in an already overcrowded and underemployed market.

Secondly, automated drafting systems cannot, contrary to vendors' brochures, easily be converted into interactive design systems. Their purpose is specifically oriented to output. Any plans to attach energy analysis or cost estimating routines to such systems can only result in post-design justification, not pre-decision exploration and evaluation.

This mismatched dialogue between a vendor's implications and an architect's intentions is evident in the "bench mark" drawings presented on page 69. It is curious that Autotrol found it necessary to even mimic the "hand lettering" on the CRS trial plan. To accomplish this, it was necessary to create a special font of purposely rough and "sloppy" characters (notice, for instance, that all of the "hand lettered" 2's are identical). A small point indeed, but the implication is that the vendor is so absorbed with the task of getting the computer to duplicate human traits that he has missed the opportunity to improve the qualities of the task to be performed. It is evident that the singular purpose was to produce an identical product, not a better one.

This is also reflected in the decision to eliminate three-dimensional descriptions and interaction from the data base. This is a particular weakness in many systems in that it forces a designer dealing with a three-dimensional concept to translate it into a series of two-dimensional abstractions from which the final three-dimensional form is assembled. One cannot help but imagine a degree of information lost in transcending these dimensional bounda-

ries. Furthermore, the insistence on retaining this two-dimensional framework has propagated a system of design which, in many ways, has outlived its usefulness. It is, as J.W. Patterson, the English architect and computer advocate, put it, "mechanizing existing systems without rethinking the job to be done." It may be argued that this adherence to traditional methodology is the only means by which computer aids will be accepted by the architectural profession, but it is a false and deceptive introduction which will, in the long run, do more harm than good to interactive computer-aided design.

Interaction, in fact, is the very crux of the issue. The creation of lines and text on a display screen and the transmission of this data to a plotter is a rather mundane task. The interactive creation and augmentation of this data in three-dimensional form and the attaching of realistic and quantifiable attributes to it is another matter entirely, one that has yet to be solved to anyone's complete satisfaction.

What is generally agreed upon is that interactive design must develop a smoother and more friendly dialogue directly between designer and machine. Solving "scheduling problems" by interposing an operator/draftsman between the designer and the computer only avoids the issues of interactive input and relegates the procedure to the rather secure area of computer generated output. This field is already populated with hardware and software that so outstrips the design profession's requirements and budgets, that questions of accuracy, realism and resolution are no longer of paramount importance.

To quote Ivan E. Sutherland, regarded by many as the father of computer graphics, "... a degree of realism has been reached which makes it difficult to identify such pictures as computer output. ... Whereas the art of producing such pictures has advanced well, the act of getting suitable data for them into the computer has remained fairly primitive."

In short, it is necessary for any architect exploring computer usage to fully understand the differences and implications of computer aided design (CAD) versus automated drafting (AD); of architectural requirements versus vendor's interpretations; of three-dimensional interaction versus two-dimensional display;

and most important, between present, virtually obsolete, techniques and a rapidly approaching future in which the architectural profession will invoke the computer's power to improve its design and not just its profits.

Nicholas H. Weingarten  
Chicago

## Calendar

### JULY

**10-14** Seminar on Environmental Journalism, sponsored by Harvard's Graduate School of Design and the MIT School of Architecture and Planning; Harvard University, Cambridge, Mass. Contact: Lisa Underkoffler, Harvard University, George Gund Hall, 48 Quincy St., Cambridge, Mass. 02138.

**22-25** The national conference of the American Society of Interior Designers (ASID), "Professional Directions '78"; the Washington Hilton Hotel, Washington, D.C. Contact: Ola M. Pfeifer, American Society of Interior Designers, 730 Fifth Ave., New York, N.Y. 10019.

**23-28** Conference, "The Economic Impact of Energy Conservation," sponsored by the Engineering Foundation and the Congressional Research Service of the Library of Congress; Franklin Pierce College, Rindge, N.H. Contact: The Engineering Foundation, 345 E. 47th St., New York, N.Y. 10017.

**31-Aug. 4** Seminar, "Energy Conservation in Buildings," sponsored by the Energy Educational Services of Connecticut; Hotel Sonesta, Hartford. Contact: Energy Educational Services of Connecticut, 266 Pearl St., Hartford, Conn. 06103. Phone: 203/522-6506.

### AUGUST

**7-8** Seminar, "Effective Management of Costs, Codes and Design in Building Re-Use," sponsored by ARCHITECTURAL RECORD; the Fairmont Hotel, San Francisco. Program will be repeated Sept. 11-12 in New York City and Oct. 23-24 in Chicago. Contact: ARCHITECTURAL RECORD SEMINARS, 1221 Avenue of the Americas, New York, N.Y. 10020. Phone: 212/997-3088.

**13-26** Third session of the Women's School of Planning and Architecture, "Workplaces and Dwellings: Implications for Women"; Bristol, R.I. Contact: The Women's School of Planning and Architecture, Inc., P.O. Box 311, Shaftsbury, Vt. 05262.

ARCHITECTURAL RECORD (Combined with AMERICAN ARCHITECT, ARCHITECTURE and WESTERN ARCHITECT AND ENGINEER)

July 1978, Vol. 164, No. 1. Title® reg. in U. S. Patent Office, copyright® 1978 by McGraw-Hill, Inc. All rights reserved. Copyright not claimed on front cover and editorial four-color separations. Indexed in Reader's Guide to Periodical Literature, Art Index, Applied Science and Technology Index, Engineering Index, and The Architectural Index. Published monthly except May, August, and October when semi-monthly, by McGraw-Hill, Inc.

Quotations on reprints of articles available. Every possible effort will be made to return material submitted for possible publication (if accompanied by stamped, addressed envelope), but the editors and the corporation will not be responsible for loss or damage.

EXECUTIVE, EDITORIAL, CIRCULATION AND ADVERTISING OFFICES: 1221 Avenue of the Americas, New York, N.Y. 10020.

PUBLICATION OFFICE: 1221 Avenue of the Americas, New York, New York 10020. Second-class postage paid at New York, New York 10001 and at additional mailing offices. ID#029520.

OFFICERS OF MCGRAW-HILL PUBLICATIONS COMPANY: Gordon L. Jones, president; Paul F. McPherson, executive vice president; Gene W. Simpson, group vice president; senior vice presidents: Russell F. Anderson; James E. Boddorf, planning and development; David G. Jensen, manufacturing; Ralph R. Schulz, editorial; vice-presidents: Denis C. Beran, European operations; David P. Forsyth, research; Eric B. Herr, economics; James E. Hackett, controller; Robert L. Leyburn, circulation; Edward E. Schirmer, sales.

CORPORATION OFFICERS: Harold W. McGraw, president, chief executive officer and chairman of the board; Robert N. Landes, senior vice president and secretary; Ralph J. Webb, treasurer.

SUBSCRIPTIONS: Subscriptions solicited only from architects and engineers. Position, firm connection, and type of firm must be indicated on subscription orders. Please allow 4-12 weeks for shipment.

CHANGE OF ADDRESS or subscription service letters should be forwarded to Fulfillment Manager, ARCHITECTURAL RECORD, P.O. Box 430, Hightstown, N.J. 08520. Provide old and new addresses, zip code or postal zone number. If possible, attach issue address label. Annual subscription prices: U.S., U.S. possessions: \$19.00 for architects, engineers and other individuals in the fields served; others \$26.00. Canada: \$21.00 for architects, engineers and other individuals in the fields served; others \$28.00. Australia, Brazil, and Japan: \$40.00 to architects, engineers; others, \$45.00. Other countries: \$35.00 to architects, engineers; others, \$45.00. Single copies: \$5.00.

GUARANTEE: Publisher agrees to refund that part of subscription price applying to unfulfilled part of subscription if service is unsatisfactory.

ASSOCIATED SERVICES/McGraw-Hill Information Systems Co.: Sweet's Catalog Files (General Building, Engineering, Industrial Construction and Renovation, Light Residential Construction, Interiors), Dodge Building Cost Services, Dodge Reports and Bulletins, Dodge/SCAN Microfilm Systems, Dodge Management Control Service, Dodge Construction Statistics, Dodge regional construction newspapers (Chicago, Denver, Los Angeles, San Francisco).

THIS ISSUE is published in national and separate editions. Additional pages of separate editions numbered or allowed for as follows: Western Section 32-1 through 32-8. POSTMASTER: PLEASE SEND FORM 3579 to Fulfillment Manager, ARCHITECTURAL RECORD, P.O. Box 430, Hightstown, N.J. 08520





## **Task/Ambient lighting by Keene. Furniture by you.**

*Keene, one of the largest suppliers of commercial lighting fixtures in the world, would like to send you more information on their Taskmaster® task/ambient lighting systems. Please write: Keene Lighting, 2345 Vauxhall Road, Union, N.J. 07083.*

**KEENE**  
CORPORATION  
LIGHTING DIVISION

*For more data, circle 6 on inquiry card*

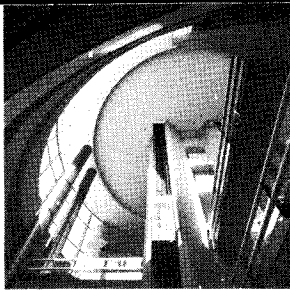

Cover: General American Life Insurance Headquarters  
St. Louis, Missouri  
Architects: Johnson/Burgee  
Photographer: Richard Payne

**EDITOR**

WALTER F. WAGNER, JR., AIA

**MANAGING EDITOR**

HERBERT L. SMITH, JR., AIA

**SENIOR EDITORS**

ROBERT E. FISCHER

MILDRED F. SCHMERTZ, FAIA

**ASSOCIATE EDITORS**

GERALD ALLEN

GRACE M. ANDERSON

BARCLAY F. GORDON

CHARLES E. HAMLIN

CHARLES K. HOYT, AIA

WILLIAM MARLIN

JANET NAIRN

**PRODUCTION EDITOR**

ANNETTE K. NETBURN

**DESIGN**

ALEX H. STILLANO, Director

ALBERTO BUCCHIANERI, Senior associate

ANNA-MARIA EGGER, Associate

MURIEL CUTTRELL, Illustration

J. DYCK FLEDDERUS, Illustration

JAN WHITE, Consultant

**EDITORIAL CONSULTANTS**

EDWARD LARRABEE BARNES, FAIA

JONATHAN BARNETT, AIA, Urban design

GEORGE A. CHRISTIE, JR., Economics

ERNEST MICKEL, Hon. AIA, Washington

PAUL RUDOLPH, FAIA

Foreign architecture

L'Architecture d'Aujourd'hui, Paris

**McGRAW-HILL WORLD NEWS**

RALPH R. SCHULZ, Director

9 domestic and 10

international news bureaus:

Bonn, Brussels, Buenos Aires,

London, Milan, Moscow, Paris,

Singapore, Tokyo, Toronto.

**SALES MANAGER**

ROBERT G. KLIESCH

**CIRCULATION DIRECTOR**

RICHARD H. DI VECCHIO

**BUSINESS MANAGER**

JOSEPH R. WUNK

**ASSISTANT TO THE PUBLISHER**

ELIZABETH HAYMAN

**PUBLISHER**

BLAKE HUGHES

## THE RECORD REPORTS

### 13 Editorial

Notes on the Dallas Convention:  
the big news and the good news

### 4 Letters/calendar

### 33 News in brief

Short items of major  
national interest

### 34 News report

At AIA convention: architects  
relax ethical code to allow  
design/build construction—and  
flock to seminars on architectural  
design. 1978 Reynolds Award  
goes to Pennzoil Place.

### 37 Human settlements: world news

### 40 Buildings in the news

Palace Hotel, Villard Houses, New  
York City. Hotel, Racquet Club,  
New York City. School of  
Architecture, Georgia Tech.  
Kennedy Park development, Cambridge,  
Massachusetts. Kincaid Tower,  
Lexington, Kentucky. Ohio State  
office building, Cleveland.

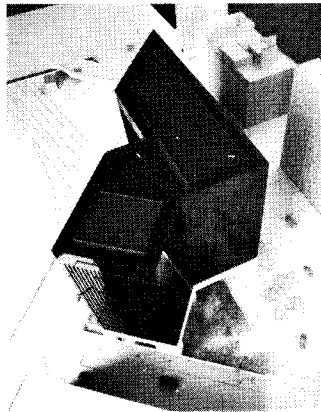

Ralph Marshall

### 43 Required reading

### 64 Office notes

## ARCHITECTURAL BUSINESS

### 55 Business development

#### Design/build debate produces a new code of ethics

The 1978 AIA convention-approved  
ethics change permitting members  
to enter into contracting on  
their projects is reviewed.

### 59 Design and business topics attracted hundreds at learning sessions

Practitioners packed the professional  
development sessions of the 1978  
AIA convention in Dallas.

### 61 Legal perspectives

#### AIA and NSPE, in separate issues, face new liability dilemmas

In the first article of two on the  
subject, attorney Arthur T. Kornblut  
explores the liability issues  
raised by recent events in the  
two major design  
professional organizations.

### 63 Building financing

#### Home mortgage money looks imperiled again

With inflationary pressures mounting  
again, the Federal Reserve  
is on a course that may force  
a new round of "disintermediation."

**FEATURES**

**79 Three designs by Johnson/Burgee**  
 The Headquarters for General American Life Insurance, recently completed and occupied in St. Louis, provides a convenient starting point for examining some of the firm's latest designs—designs that have stirred up enormous controversy. Philip Johnson's own views on AT&T in New York and the Cultural Center for Dade County are challenging and important.

**89 Design for readers**  
 Three libraries designed by different architects for different user groups present interesting design contrasts. What they have in common, in addition to quality, is a joint concern for their surroundings and for the comfort and convenience of those who use them.

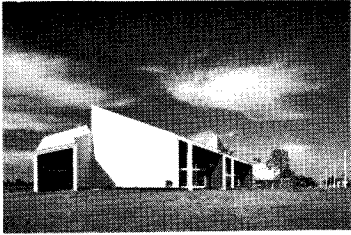

Hedrich-Blessing

**99 A Connecticut house contrasts crisp geometrics with a natural site**  
 Anthony and Anne Woolner have created an attention-getting house of unusual interlocking geometric forms and spaces.

**103 Sparkling showcase for Fluor Corporation**  
 The new headquarter offices for Fluor Corporation and Fluor's Engineers & Constructors, Southern California Division, office building were designed with an energy consciousness that fully integrated the engineering and architectural aspects—providing a showcase for the client. The complex is extremely attractive—almost crystalline in appearance due to its highly reflective facade.

**BUILDING TYPES STUDY 519**

**109 Buildings for industry**  
 There is good news on industrial construction. At last, it is catching up with the current surge of other types and the dollars spent should show a healthy gain of some sixteen per cent this year. Accordingly, RECORD is showing an interesting cross-section of some of the different kinds of industrial construction that has occurred recently.

**110 The Bemis Company factory and warehouse**  
**Omaha, Nebraska**  
 Bahr Vermeer & Haecker, Architects, Ltd., architects.

**112 Pacific Northwest Bell data processing center**  
**Portland, Oregon**  
 Zimmer Gunsul Frasca Partnership, architects.

**116 Sewage pumping station**  
**Staten Island, New York**  
 Warren W. Gran and Associates, architects.

**118 University of North Carolina maintenance building**  
**Charlotte, North Carolina**  
 Clark Tribble Harris & Li, architects.

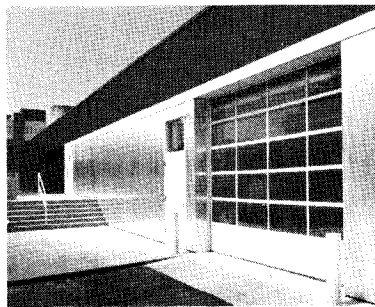

Rick L. Alexander

**120 Textronix, Incorporated factory and warehouse**  
**Wilsonville, Oregon**  
 Zimmer Gunsul Frasca Partnership, architects.

**124 New York Telephone Company data processing center**  
**White Plains, New York**  
 Haines Lundberg Waehler, architects.

**ARCHITECTURAL ENGINEERING**

**127 Floating floor system is made in a new form to cut costs**  
 A handy roll-out mat version plus locally-bought plywood save on shipping costs for a system that reduces airborne noise from machine rooms.

**128 A metal-deck ceiling saves money in correctional institutions**  
 Cellular deck—lightweight, yet strong enough for detention purposes—is economical, clean-looking and multifunctional.

**133 Product reports**

**135 Office literature**

**178 Classified advertising**

**183 Advertising index**

**185 Reader Service inquiry card**

**NEXT MONTH IN RECORD**

**Building Types Study: Elementary and Secondary Schools**  
 Although the statistical curve of school construction is not as awesome as it was during the famous "baby boom," new schools continue to be built apace everywhere in the U.S. for a variety of reasons, ranging from plain obsolescence to new laws and social and educational requirements that must be complied with—often with all possible speed. Earthquake codes, anti-segregation laws, population shifts, energy conservation, and help for the handicapped have all—along with many, many others—had their obvious impact on new school design. This Building Types Study will explore what effects some of these have had on a variety of facilities from California to Massachusetts.

Mary Kay Cosmetics  
Dallas, Texas

No matter what size building you design, Amarlite Anaconda can help you design economy into it.

Our product line of thermally-improved architectural aluminum includes five curtain wall systems and six low-rise framing systems. Each designed to insulate your clients against high energy costs.

By creating an additional thermal barrier against the elements, they help temperatures stay constant inside by keeping nature outside.

And that's vital. Because the wide range of buildings going up today demands that you have access to a wide range of architectural aluminum products.

So, even with our broad line, we never stop improving our thermally-improved products. We're constantly innovating. Refining our refinements. Our challenge is to stay ahead of the challenges facing you.

And that's why each of our systems also comes with a design assistance team. To help you adapt Amarlite's special products to your project's special needs.

So specify Amarlite thermally-improved products.

Not only will your buildings look better outside, they'll look better in a life-cycle cost analysis.

*Whether you're involved with one story, or thirty stories, you'll want to hear our story. Write for our catalogs, "Thermally-Improved Curtain Walls" and "Entrances and Storefront Systems." Amarlite Anaconda, P.O. Box 1719, Atlanta, Ga. 30301. Or read about us in "Sweets 8.1/AN and 8.14/AN." Or call (404) 691-5750.*

**AMARLITE**  
**ANACONDA**  Aluminum Division

For more data, circle 7 on inquiry card

**AMARLITE ANACONDA  
IS BIG IN THERMALLY-IMPROVED PRODUCTS.  
AND SMALL.**

UNITED STATES POST OFFICE  
FORT VALLEY DESIGN BLDG

Ft. Valley Post Office  
Ft. Valley, Georgia



## Notes on the Dallas Convention: the big news and the good news

The big news of the AIA Convention in Dallas was, of course, the decision—by an astonishing 3 to 1 vote—to permit architects to engage in design-build construction and contracting (details in *Record Reports* page 34). While this “experimental” change in the AIA code of ethics was described as a compromise, it does seem unlikely that the new freedom will be withdrawn short of some horrendous result which no one at the Convention could foresee. Faithful readers of this page will know that I argued strongly against this change before the two previous conventions at which it was considered. But that decision has now been made—after the most careful debate—and I think those who are concerned about the impact of this decision should be reassured (as I am) by the fact that there were so many good and thoughtful men on both sides of the question. While some architects may have voted for the change for purely business reasons, many others—obviously including many who will never undertake contracting—voted for the change because they believed it was right for the profession.

One plus is clear: A growing number of clients—especially industrial clients—are demanding single responsibility; and if the general contractor has that prime contract, the architect is not in a strong position to fight for quality. Given the right to take that prime contract and guarantee the price of the building, architects must now demonstrate that they can do better.

One caution: The three-year experiment has been described as a controlled experiment—and I hope that the controls are carefully formulated and administered. I think we must assume the possibility of some abuse of this new freedom (and the corollary new freedom to advertise—see also *Record Reports*). And I hope those few architects who do not maintain the profession’s standard of conduct as they work in “ordinary business” are exposed and invited to leave the AIA at once.

Having said that, let me hope that from now on we accept that a major change has been made, and that we work to implement that change gracefully.

The good news of the Convention was that, for the first time in a long time, there was a lot of talk about good design. And it was good talk.

It was stirred up, of course, by the fact that the Institute awarded the Gold Medal to Philip Johnson, and scheduled two major Convention events (in addition to the Gold

Medal dinner) around that great designer. On Wednesday afternoon, just before the dinner, a series of slide-show presentations were made by architects chosen by Philip—Peter Eisenman, Frank Gehry, Michael Graves, Charles Gwathmey, Charles Moore, Cesar Pelli, Robert Stern, Stanley Tigerman. That visual kaleidoscope was presided over by Roger Clark of North Carolina state. And the place was packed—for four hours!

Next morning, when at most conventions people are checking out, Johnson—reveling in his role as godfather—presided over a discussion by the same design superstars of “the transition in design.” To be sure, there were a lot of students in the huge (at least 1000) audience, but there were also a lot of practitioners who had stayed to hear the talk about design after the first two-and-a-half-day diet of resolutions and business-oriented seminars. (Which were excellent, all well attended, and surely a good new direction for conventions.) It would take a bolder and more intellectual man than I to risk a summation of that heady conversation—I think it is enough to say that it was marvelous that it took place. Some (I surely did) learned some new ideas from it, saw some new ways to think about design and designing. If some disagreed with the philosophies expressed, so what? The panelists were far from agreement among themselves on the “transitions.” The important thing is that, for the first time in a long time, there was a *celebration of design*. With Ehrman Mitchell as the next AIA president, we can surely expect another. Let’s hope it becomes an annual tradition—for we need more reminders that, in the end, what architecture is all about is good design. . . .

A final thought on celebrating design: Without having any idea about how to alter the schedule, I think that instead of presenting the Honor Awards as almost the opening gun of a convention (before an awful lot of people even arrive), the Honor Awards might be presented as the greatest celebration of every Convention—say at an elegant black-tie dinner. Further, I think the Institute should try and find a Gold Medal winner more often. I make no suggestion that the standards of that great honor be lowered or changed—only that those who have met the standards be recognized sooner. I believe there are candidates.

Such celebrations of excellence are surely one of the best ways to show the public what good architecture is—and is all about.

—Walter F. Wagner, Jr.



## **The Acoustic Open Office by Owens-Corning. Because it's not people that make an office noisy. It's the office.**

People can't help but make noise while they work. Not much you can do about that.

What you can do something about are noisy walls, floors, ceilings, and furniture—the hard surfaces that reflect and broadcast every little sound people make.

Design an open office acoustically, and these surfaces can actually be used to *control* noise.

### **Not too noisy, not too quiet.**

The Acoustic Open Office by Owens-Corning is a system of components designed to reduce the

overall noise level *and* create the conditions that allow speech privacy.

It's made up of five basic elements:

An Acoustic Ceiling made of Owens-Corning Fiberglas\* ceiling boards that works so well absorbing sound it's earned a Noise Isolation Class of 20. (The open sky has a perfect rating of 23.)

Sound dividers divide space *and* provide speech privacy. Each divider has a sound-absorbent core of Fiberglas.

Acoustic Wall Panels to soak up deflected sounds that hit the wall.

**The AIA convention voted to permit its members to participate as principals in design/build activities** "where compensation is affected by profit or loss on labor and materials furnished in the building process." The effects of this major change in the Institute's ethical code will be monitored over a three-year experimental period. Delegates also voted to allow "dignified advertisements" in print media. Details on page 34.

**AIA conventioners turned out in force for a pair of design seminars organized by Gold Medalist Philip Johnson.** At the first of these sessions, each of the eight "post-modernist" designers defined his views on architecture; at the second, the eight and Mr. Johnson debated them. Details on page 35.

**Delegates to the AIA convention elected Charles E. Schwing, FAIA, first vice president and president-elect.** He will succeed Ehrman B. Mitchell as president of the Institute at the end of 1979. Details on page 34.

**A bill before Congress would allow professionals to set up trust funds to defray costs of liability protection.** Income used for the purpose would be tax-exempt. Details on page 37.

**In the first four months of 1978, commercial and industrial building ran more than 50 per cent ahead of 1977,** reports George A. Christie, chief economist of the F. W. Dodge Division of the McGraw-Hill Information Systems Company. This activity helped raise April's level of nonresidential contracts 21 per cent above that of April 1977, despite a 2 per cent decrease in institutional building. The fall-off in institutional contracts was attributed to "backlash" from Round II of the Federal public works program, which "overstimulated" publicly financed building at the end of 1977. Residential contracts were up 25 per cent from last April.

**The National Institute of Building Sciences has elected David S. Miller its new chairman.** He is president of David S. Miller and Associates, a Cleveland management consulting firm serving the construction industry, and a past president of the Producers' Council, Inc. William F. Floyd III, vice president of Builders Investment Group, Atlanta, succeeds him as vice chairman of NIBS.

**UCLA has named Charles Moore head of its Architecture/Urban Design Program** in the School of Architecture and Urban Planning. In addition to his writing and his professional practice, Mr. Moore is former Chairman of the School of Architecture at UC Berkeley and Dean of Architecture at Yale University.

**Charles Rusch has joined the University of Oregon as Head of the Department of Architecture.** Mr. Rusch comes to the position from the University of California at Los Angeles, where he most recently served as Associate Dean of the School of Architecture and Planning.

**The notion of recertification, never strongly supported by the profession, appears to be losing ground.** The California Council/AIA, which last year drafted legislation for continuing education as a condition of recertification, now endorses continuing education only on a voluntary basis. Both the American Institute of Architects and the Society of American Registered Architects also oppose mandatory continuing education.

**The Arizona Society of Architects/AIA has established a system of prepaid legal assistance,** designed to encourage its members to seek early legal advice and forestall litigation. Participating lawyers were selected for their experience in architectural and construction law. A fee of \$100 entitles those architects participating in the program to three hours of legal counsel within the first six months.

**A conference on "The Future of Model Building Codes in America" will meet August 1-3** at the Chase Park Plaza Hotel, St. Louis. The National Institute of Building Sciences and the Council of American Building Officials will sponsor the conference, which was prompted by the recent announcement that BOCA, ICBO and SBCC are studying a possible merger. (These three model code groups constitute the CABO organization.)

**The American Institute of Architects has urged "a greater Federal effort in the area of 'passive' solar energy,"** following the President's announcement of a \$100-million addition to Federal spending for solar research and development. In a letter to President Carter, AIA president Elmer E. Botsai said, "The application of passive solar techniques can be accomplished at present without the development of expensive sophisticated technology."

**The American Academy in Rome has opened competition for the Rome Prize Fellowships for 1979-80.** The fellowships are awarded to American artists and scholars, including architects, and carry a stipend, allowances, room and a studio or study at the Academy facilities in Rome, according to Academy president Bill N. Lacy. The deadline for applications is November 15, 1978. For information and application forms: American Academy in Rome, Rome Prize Fellowships, 41 East 65th Street, New York, New York 10021.



At the Dodge/Sweet's party, guests and musicians circulated through the terraces at the new campus of the University of Texas at Dallas, designed by Harwood K. Smith and Partners and the Oglesby Group.

### In its own quiet way, AIA convention makes history

The 1978 convention of the American Institute of Architects seemed in at least two important aspects an historic convention. Delegates concentrated with unaccustomed force on essential concerns that are all too often regarded as antithetical—architecture as profession, and architecture as art.

After three years of debate, the Institute finally resolved the vexatious ethical problem of design/build construction as an acceptable form of architectural practice, and amended the ethical code to allow members to engage in that activity over a three-year experimental period.

And two design seminars, conducted by Gold Medalist Philip Johnson and a cadre of "post-modernist" architects attracted exceptionally large and responsive—not to say rapt—audiences.

The convention, which met in Dallas May 21-25, drew nearly 2,100 architects and architectural students. Among other issues debated at business sessions:

- Advertising: Members evidently agreed with Central States director Thomas R. Teasdale, who confessed that in the face of Justice Department victories in this area, "I have come to the conclusion that my opposition is beside the point." By a margin of 82 per cent, the delegates elected to liberalize the ethical canon against advertising, and to permit "dignified advertisements and listings only in newspapers, periodicals, directories or other publications," including "availability and cost of basic services," but not including "testimonials, photographs or comparative references to other architects."

- ERA and convention sites: In answer to a widespread policy adopted by supporters of the Equal Rights Amendment to boycott conventions in states that have failed to ratify the amendment, the convention voted (2 to 1) to establish a task force to set criteria for AIA convention site selection. The amendment calls for criteria

that "shall include the requirement that, consistent with AIA public policy, location of future conventions shall only be in states that have ratified the [ERA]. The specific criteria shall take effect in 1980 and shall no longer apply after the passage or defeat of the [ERA]." (The resolution will not affect the 1979 convention in Kansas City, although Missouri has not ratified the ERA.)

- Recertification: The convention made clear its opposition to state legislation that would require license renewal or maintenance, though the resolution's wording was changed from "the AIA opposes" to the less demanding "the AIA does not advocate." The delegates also adopted a resolution to continue testing and refining the Institute's Professional Development Measuring System.

During the afternoons, the convention offered an extensive choice of seminars, many of them examining new markets for architectural services—architectural research, land development and adaptive use, among others. Technical seminars included sessions on energy conservation, solar technology, seismic design and water infiltration.

### Bartlett Awards go to seven AIA Honor Award winners

Bartlett Awards, conferred annually on AIA Honor Award winners in recognition of their accessibility to the handicapped, went this year to seven buildings:

IBM Santa Teresa Laboratory, San Jose, California—MBT Associates, San Francisco, architects;

Yale Center for British Art, New Haven, Connecticut—Louis I. Kahn and Pellecchia and Mayers, Philadelphia, architects;

Three "H" Service Center, Houston—John Zemanek, Houston, architect;

Center Stage, Baltimore—James R. Grieves Associates, Inc., Baltimore, architects;

### Members vote 3-1 to extend ethics to include design/build

In an ethical code change that promises to alter greatly the way at least some architects practice, and that may profoundly affect the views of both architects and the public toward the profession, the American Institute of Architects will allow its members to engage as principals in design/build construction and in contracting.

The design/build matter has been an AIA issue for some ten years and four task forces, emerging as a question on the convention floor at Philadelphia in 1976 and narrowly rejected at San Diego in 1977 (see RECORD, July 1977, page 26). At San Diego, still another task force was established to examine possible compromises. Its members included John M. McGinty, FAIA, immediate past president of the Institute and leader of the pro-change forces at last year's convention, Jerome Cooper, FAIA, leader of the opposition last year, and Harold Fleming, Hon. AIA and the public member of the Institute's Board of Directors.

The compromise forged by the task force and approved by the membership calls for an experimental period of three years during which

the Institute will allow its members to participate "as principals in design/build construction activities . . . where compensation is affected by profit or loss on labor and materials furnished in the building process." Safeguards against abuse of the new freedom require members to give their clients "written disclosure of the existence of the member's conflict of interest" and "notice that the member's compensation will be affected by profit or loss on labor and materials furnished on the advice of the member. . . ."

Members approved this new rule by a 3 to 1 majority after a debate that observer Gordon Graham, president of the Royal Institute of British Architects, admired for its "dignity, grace and good manners."

Mr. McGinty, arguing for adoption of the task force's proposal, called it "an opportunity for us to extend the professionalism and discipline of architecture beyond paper and into the execution of design as well. It presents an opportunity for greater control of the process by those committed to quality and bound by professional ethics. . . . I want to see a society in which the



Delegates turned out in force for Tuesday morning's debate on the design/build resolution. Harold A. Fleming, public member of the Board, detailed the proposal drawn up by the task force appointed last year.

### Charles Schwing named AIA president-elect

Delegates to the AIA convention elected Charles E. Schwing, FAIA, first vice president and president-elect of the Institute. He will succeed Ehrman B. Mitchell in 1979. Mr. Schwing, from Baton Rouge, is president of Charles E. Schwing & Associates, Inc.

The delegates also elected three new vice presidents: Robert Broshar, FAIA, a partner in the Waterloo, Iowa, firm of Thorson-Brom-Broshar-Snyder; James M. Harris, AIA, a partner in the Tacoma, Washington, firm of Harris, Reed, Litzenberger & Tsang; and R. Randall Vosbeck, FAIA, a partner in the VVKR Partnership of Virginia and Maryland.

effects of architecture are widespread—even dominant."

Confessing his continued misgivings about the new ethic, Mr. Cooper said, "I still believe that the workings of contemporary society are far too intricate and the construction process far too complex for the architect to believe that he can utilize the design/build process to return himself to the once-hallowed and sometimes mythical position of the master builder. . . ."

"I still believe that if we permit members of this Institute to engage in design/build activities and descend into the quagmire of conflict of interest, then we will have cast ourselves as adversaries with our clients and they will turn to others for objective and unblemished advice."

The point on which both men agreed, however, was the parlous effect on the Institute of continued divisiveness. "Even if this experiment is attempted and fails," said Mr. Cooper, "perhaps we will have developed in the process some substantive arguments with regard to the degree of competency that can reasonably be expected of us as a profession."

The task force recommended that the experiment be monitored

over the three-year period by an Institute committee "utilizing appropriate professional assistance." Observations should answer such questions as the number of AIA members involved in construction, any change in the share of total construction market under control of architects, analysis of risk/reward for the profession (including liability exposure), analysis of impact on the scope of AIA services required (such as construction documents, continuing education, financial management systems, etc.), analysis of any shifts in perceptions of the architect's role in society, and analysis of the extent, if any, to which the new architectural activity brings a higher standard of professionalism to the development of the built environment.

In 1981, the convention will be offered an opportunity to 1) adopt the new rule permanently, 2) withdraw the rule altogether or 3) continue the experiment for another three years, the issue to be resolved for good in 1984. Mr. Fleming said that if the new rule were to be rescinded, the Board intends to give members engaging in design/build construction sufficient lead-time to fulfill existing obligations without incurring disciplinary penalties.

### More Johnson: Pennzoil Place takes Reynolds Award

For Philip Johnson the week was chock-a-block with honors—not surfeited with the Institute's Gold Medal and an honorary degree from Yale University, he also picked up the R. S. Reynolds Memorial Award.

The award, given annually for distinguished architecture using aluminum, went this year to Johnson/Burgee Architects of New York City, and their associated architects, S. I. Morris Associates, of Houston, for the design of Pennzoil Place, Houston. The two firms share the \$25,000 honorarium that accompanies the award.

The twin trapezoidal towers at Pennzoil Place are faced with bronze-colored glass framed by bronze-anodized aluminum mullions, set on 2½-foot centers and projected six inches. The connecting slant-roofed atrium is also framed with aluminum sections. (See RECORD, November 1976, pages 101-110.)

The jurors commended the building for "the ways in which it addresses an urban situation," and added, "It enhances the city as a composition in solid geometry that works in three separate public scales: first, at five miles as a dynamically changing sculpture in large and simple form, experienced in time and motion; second, at the street scale, forming elegant urban spaces in the city's grid; and third, at the site itself, inside the atrium, as an exciting personal space."

Members of the jury were John M. McGinty, FAIA, immediate past

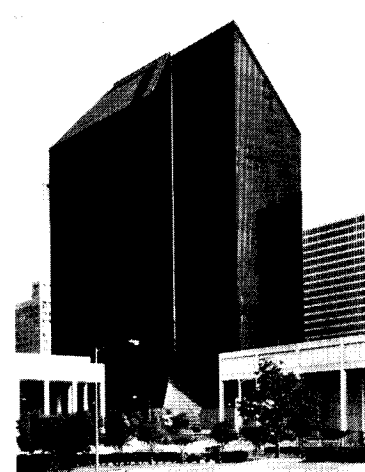

president of the AIA (which administers the award); Hans Hollein of Vienna, who won the award in 1966; and Richard Meier, FAIA, who was last year's winner.

The \$5,000 Reynolds Aluminum Prize for Architectural Students went to Roberto A. Peredes, a fifth-year student at the Georgia Institute of Technology. Mr. Peredes designed a prototype comprehensive medical service center for rural areas.

The jury of architectural deans and students wrote of the winning design, "Appropriately, a taut-skin aluminum envelope wraps the high-technology use areas, while an inflatable aluminum coated mylar skin encloses the 'softer' use areas." The inflatable membrane has nylon support threads between its fabric layers to suspend collector tubes for the solar heating system.



At a luncheon preceding the seminar "Design in Transition," the eight "post-modernist" panelists and Gold Medalist Philip Johnson fielded questions from the press. From left to right, seated: Frank O. Gehry, Charles W. Moore, Mr. Johnson, Stanley Tigerman and Robert A. M. Stern; standing: Michael Graves, Cesar Pelli, Charles Gwathmey and Peter Eisenman.

### Gold Medalist Johnson orchestrates two design seminars

If the first two days of the Dallas AIA convention were taken up by the practical business of architecture, the second two days were devoted to an orgy of high-powered design talk, instigated and orchestrated by Philip Johnson.

This orgy centered, of course, on the Institute's bestowal of its Gold Medal on Mr. Johnson—the first time in six years that the Medal has been given to a living architect.

At the Gold Medal dinner on Wednesday evening, Mr. Johnson began his extemporized acceptance address with thanks to the Institute for "a vote for architecture, which is my passion." With a youthful relish typically belying his 71 years, he observed a current shift in architectural sensibility—"uncertain, uncharted, and absolutely delightful." And in implied response to the controversy surrounding his recent design for the AT&T office tower (see pages 84-88), he insisted that "I am as modern as I ever was." But "the public knew better than I about glass houses and flat roofs."

Mr. Johnson welcomed the post-modernist recognition of history and symbolism as major sources of architectural form, and hailed the "diversity and pluralism" evident in the work of younger architects. He ended his address with the peroration "God bless kids! God bless architecture!"

Diversity and pluralism were on display at two jam-packed seminars conducted by a Johnson-assembled panel that included architects Peter Eisenman, Frank O. Gehry, Michael Graves, Charles Gwathmey, Charles W. Moore, Cesar Pelli, Robert A. M. Stern and Stanley Tigerman. And diversity there was in plenty.

The first of the two seminars, titled "Design in Transition," moderated by Roger Clark of the School of Design at North Carolina State University and described by Mr. Moore as "a *festchrift* for Philip Johnson," was a marathon session at which each of the panelists described, with slides, his present views on design

and on the esthetic direction of architecture. Pluralistic diversity ranged from the cerebral theorizings of Graves and Eisenman through the historical eclecticism of Stern and the eclectic exuberance of Moore to Pelli's adamant refusal to deny the formal implications of structure and technology.

The following morning, at a more free-wheeling session moderated by Mr. Johnson and enlivened by Johnsonian barbs, the same participants argued their opinions with good-humored acerbity. Though Johnson says "we can no longer talk about architecture without talking about history," Pelli does just that: "Technology doesn't go away. We should know how to use it grammatically."

When Graves talks about the search for formal "ambiguity," and Stern about the "nobility" of eclecticism, Gwathmey retorts, "I really don't agree with all this. I still believe in space and volume, and not in borrowed imagery or preconceived style. It's happening too fast. I would rather step back and readdress some critical issues, including the program."

And other participants acknowledge their own uncertainties. "I'm bumping around in the dark," says Gehry, "following a personal path I can't define." And Tigerman, the self-confessed "schizophrenic," still admires Miesian design, "the vestiges of a great man," while welcoming the "opening up to the world of ideas and the possibility of celebrating something besides structure."

Where the group appeared to be at one was in their common determination to accept architecture as art and to reject it as a tool for the creation of a social Utopia.

AIA President-elect Ehrman B. Mitchell, speaking at a press luncheon preceding these seminars, announced that the 1979 convention, to be held at Kansas City, will be a "celebration" of design and the design process.

more news on page 37



**Owens-Corning Wall Panels keep the office quieter.  
Even when things get out of hand.**

These Owens-Corning Wall Panels are hard at work soaking up sound.

So that even the noise from the morning coffee wagon seems softer. Quieter. More bearable.

They do their job handsomely. The fabric-covered panels come in a range of colors—from quiet to loud.

And installation is almost as easy as hanging a picture.

If you're having trouble hearing yourself think, put the walls to work. In offices, schools, auditoriums, hospitals.

For a free color guide and catalogue of acoustical performance, write T. A. Meeks, Owens-Corning Fiberglas\* Corp., Fiberglas Tower, Toledo, Ohio 43659.

\*T.M. Reg. O.-C.F. © O.-C.F. Corp. 1978



For more data, circle 33 on inquiry card

## Trust funds would reduce cost of liability protection

Architects, other professionals and businesses would be able to use tax-exempt dollars for the establishment of individual trust funds to help defray the cost of professional and product liability protection under legislation now under consideration by Congress.

The amount of such a trust fund would not be expected to cover the entire costs of liability protection, but it might permit the purchase of liability insurance with a higher deductible level, and this presumably would lead to lower premium rates.

The House Ways & Means Committee plans hearings on the measure (H.R. 7711) this summer. Its chief sponsor, Representative Charles W. Whalen, Jr. (R-Ohio), says he has rounded up 67 co-sponsors and the endorsement of trade and professional organizations, including the American Institute of Architects.

As presently written, the bill would permit professionals and businesses to set aside 3 per cent of their gross income for the trust funds. This money could be spent to pay liability claims and any cost of litigation.

The funds in the pool could not be diverted for other purposes unless the professional or businessman was prepared to pay retroactive taxes on the amount. But while the funds remain in the account, they could earn interest, and that too would be sheltered from taxes. —William Hickman, *World News, Washington*.

## Federal works program will rehabilitate public facilities

The rehabilitation of existing public facilities is emphasized in a new program that the Carter Administration proposes to provide construction industry jobs for the long-term unemployed in the central cities.

The Administration proposes to funnel \$3 billion into the program over three years. It would give priority to projects that will conserve energy, preserve historic structures and enhance public services.

The local governments contracting for the work will be encouraged to hire minority businesses. But unlike the local public works program that is now winding down, the flat 10 per cent minority business enterprise rule will be replaced by a sliding scale. In areas where there is a large minority population, such as Newark, the MBE goal will be 15 per cent. In areas with few minorities, like Vermont, the goal will be just 2 per cent. The nationwide average would be 10 per cent.

The main purpose of the program, however, is to create employment opportunities for the "disadvantaged, long-term unemployed."

To accomplish these employment goals, the legislation prepared by the Administration requires that at

least 50 per cent of the workers hired be drawn from the long-term unemployed. Each project must have a labor-intensity ratio ranging between 50 per cent and 80 per cent of the project's cost.

Cities will be able to perform 10 to 20 per cent of the projected work with their own employees, and must provide 10 per cent of the project costs.

The funds, \$1 billion each year, will be allocated among the states for distribution to cities, the allocations to be based on the cities' relative unemployment figures. Each state will be guaranteed a minimum allocation each year of \$2.5 million; none will get more than \$125 million.

The Economic Development Administration, which administered the local public works program, is in charge of the effort. It will insist that the local governments coordinate their planning with local manpower organizations, labor unions, and contractors' associations, particularly those of minority contractors.

Reaction to the proposal has been divided. The AFL-CIO Building Trades Council, which was initially cool to the plan, now supports it. But one contractors' organization, the Associated Builders and Contractors, calls it "a totally irresponsible, politically motivated ploy to artificially force down the nation's unemployment figures by requiring 50 per cent more manpower on a job site than needed." —William Hickman, *World News, Washington*.

## GSA selects three finalists for Federal Triangle plan

The General Services Administration has selected three architectural organizations to continue development of a master conceptual design for the Federal Triangle in Washington D.C.:

- the joint-venture firm of Sasaki Associates Inc. of Watertown, Massachusetts, Shepley, Bulfinch, Richardson and Abbott of Boston, and Gindele and Johnson of Poughkeepsie, New York;
- the joint venture firm of Sert, Jackson and Associates, Inc., and Lozano, White and Associates, both of Cambridge, Massachusetts, Jerome W. Lindsey and Associates of Washington, D.C., and the SWA Group of Boston;
- Harry Weese and Associates of Chicago.

The Federal Triangle is on the south side of Pennsylvania Avenue, about midway between the White House and Capitol Hill. It is a major concentration of Federal employment. The plan eventually accepted by GSA is intended to complement redevelopment along the avenue's north side, which is the responsibility of the Pennsylvania Avenue Development Corporation (see RECORD, May 1978, page 35). —William Hickman, *World News, Washington*.

## Human Settlements Commission sets framework for action

The organizational session of the UN Commission on Human Settlements, held in New York City at UN Headquarters April 3-7 managed to achieve agreement on several modest objectives and to establish a broad framework for future action.

The Commission itself was set up in January this year by the UN Economic and Social Council, which had elected 53 of 58 members to rotate three-year terms. Subsequent elections in May filled all the available memberships, with representation fixed on a regional basis.

The Commission's meeting was handicapped because the Executive Director for the Habitat Center for Human Settlements still had not been appointed. It welcomed the assurances of the UN Secretary General that the appointment would be announced shortly, and decided to meet again in Nairobi in 1979, by which time the Habitat Center would be operational (see RECORD, May 1978, page 37).

In its final report, the Commission outlined some of its major concerns, especially the fact that no new resources had been made available for the Habitat Center for development and operational purposes even when it does become established in Nairobi. The Commission urged all states, particularly the developed countries, to increase their voluntary contributions for human settlements activities, especially to the UN Habitat and Human Settlements Foundation, in order to achieve the \$50-million target for the years 1978-81. The Commission was of the opinion that the establishment of definitive institutional arrangements in the UN system now should facilitate generous and early contributions to the Foundation.

In addition, the Commission requested reports from the Executive Director of the Center on a framework for the Commission's activities over

future medium-term periods, including the feasibility of periodic global reviews of human settlements, on total resources available to the Center, and on its technical capabilities.

The Commission requested the Executive Director to submit to its next session a document to be used as a basis for drawing up "global priorities" for action.

It asked member states to convey to the Executive Director by May 15 their views and suggestions on the work of the Center, as well as priorities, to assist him in drawing up proposals for the next medium-term plan for human settlements activities (1980-83), being prepared this year.

The Commission expressed the view that, at the international and interregional levels, the Center's activities should include research and methodology, the promotion and dissemination of information, and assistance for field activities.

At the regional level, programs will be formulated by regional commissions, taking into account national, subregional and regional priorities, focusing on technical assistance and the execution of regional programs.

The Commission further decided that at its next session it would discuss innovations made by "interested countries" in the field of human settlements, as a way of "enriching" the proceedings with considerations of the practical aspects of human settlements activities.

The Commission recommended that the Executive Director of the Center consult as soon as possible with the UN regional economic commissions on their existing and planned programs of work and priorities on human settlements, on the establishment of regional committees, and on the deployment of resources. —Eric Carlson, *UN Habitat and Human Settlements Foundation, Nairobi*.

## UN Habitat Foundation will convoke regional meetings

A series of regional and global meetings on human settlements finance and management are being convoked by the UN Habitat and Human Settlements Foundation, jointly with the UN Environment Programs. Co-sponsors include the UN Development Programs, the regional economic commissions, the U.S. Agency for International Development and the International Union of Local Authorities. All governments of each region are being invited, and a number of participating agencies, including regional development banks, financial institutions and nongovernmental organizations, are also slated to collaborate on the project, as are the host governments.

The schedule of meetings to date is as follows: Africa Region—Nairobi, October 9-14; Latin America and the Caribbean—Mexico City, November 27-December 1; Asia and the Pacific—

Bangkok, April 2-7, 1979; West Asia—during the first half of 1979; Europe—Geneva, May 1979; global meetings—during the second half of 1979.

The conferences, designed to be a follow-up of the Vancouver HABITAT conference, will deal primarily with the mobilization of resources required to meet human settlement needs. The role of national governments, local governments, savings and credit institutions and international finance agencies will be discussed and recommendations formulated.

Key agenda themes will also include the subjects of external aid and development of human settlements, and the prospects of financial and technical cooperation among developing countries; management of human settlements; and the post-HABITAT role of the UN system in human settlements development. —E.C.





# WRAP YOUR NEXT BUILDING IN RIBBONS OF PPG GLASS.

It is called the PPG EFG™ Glazing System 401.

EFG is a structural silicone glazing system. It gives a smooth, flush, seamless look. Which means that you can design buildings with sweeping ribbons of glass.

The mullions are inside. So you can use glass types and thicknesses not previously compatible with butt-joint techniques and their accompanying restraints.

Thinner tinted and reflective glasses can now be used with PPG's EFG System.

In contrast to butt-joint structures where support is

available only at head and sill, PPG's EFG System achieves full four-side stiffening support for both positive and negative windloads. Included is an indoor mullion that is structurally silicone-bonded to the glass.

The silicone also provides an unobtrusive weatherseal at the outdoor vertical joints in the glass. Thus, no outdoor framing members protrude.

And continuous ribbon-like bands of glass become a practical design device.

No other manufacturer has had more experience with structural silicone glazing

systems than PPG. We developed TVS® Glazing Systems back in 1965. It was the first structural glazing use of silicone. And now we are offering you the newest generation of flush glazing for any design your imagination can come up with.

To learn more about how you can employ PPG's EFG Glazing System 401, see Sweet's 8.26Pp. Or write to: Environmental Glass Sales, PPG Industries, Inc., One Gateway Center, Pittsburgh, Pa. 15222.

PPG: a Concern for the Future

## PPG CAN HELP YOU WITH CUSTOM SEAMLESS CURTAIN WALLS, TOO.

If you have a project on your drawing board that could be enhanced by a curtain wall of seamless appearance, PPG would like to share its experience in structural silicone systems with you.

PPG will lend a helping hand on buildings where you want to achieve the look of a total exterior glass wall. With the PPG high-performance glass best-suited for the job.

In fact, PPG can help you create a powerful design statement with either its own EFG System 401 or your own custom seamless curtain wall.

Left: Westinghouse Research Center—Administration Building, Pittsburgh, Pa. Architects: Skidmore, Owings and Merrill Chicago, Ill.

Right: Morgan Center—Butler, Pa. Architects: Burt Hill Kosar Rittelmann Assoc. Butler, Pa.



For more data, circle 34 on inquiry card

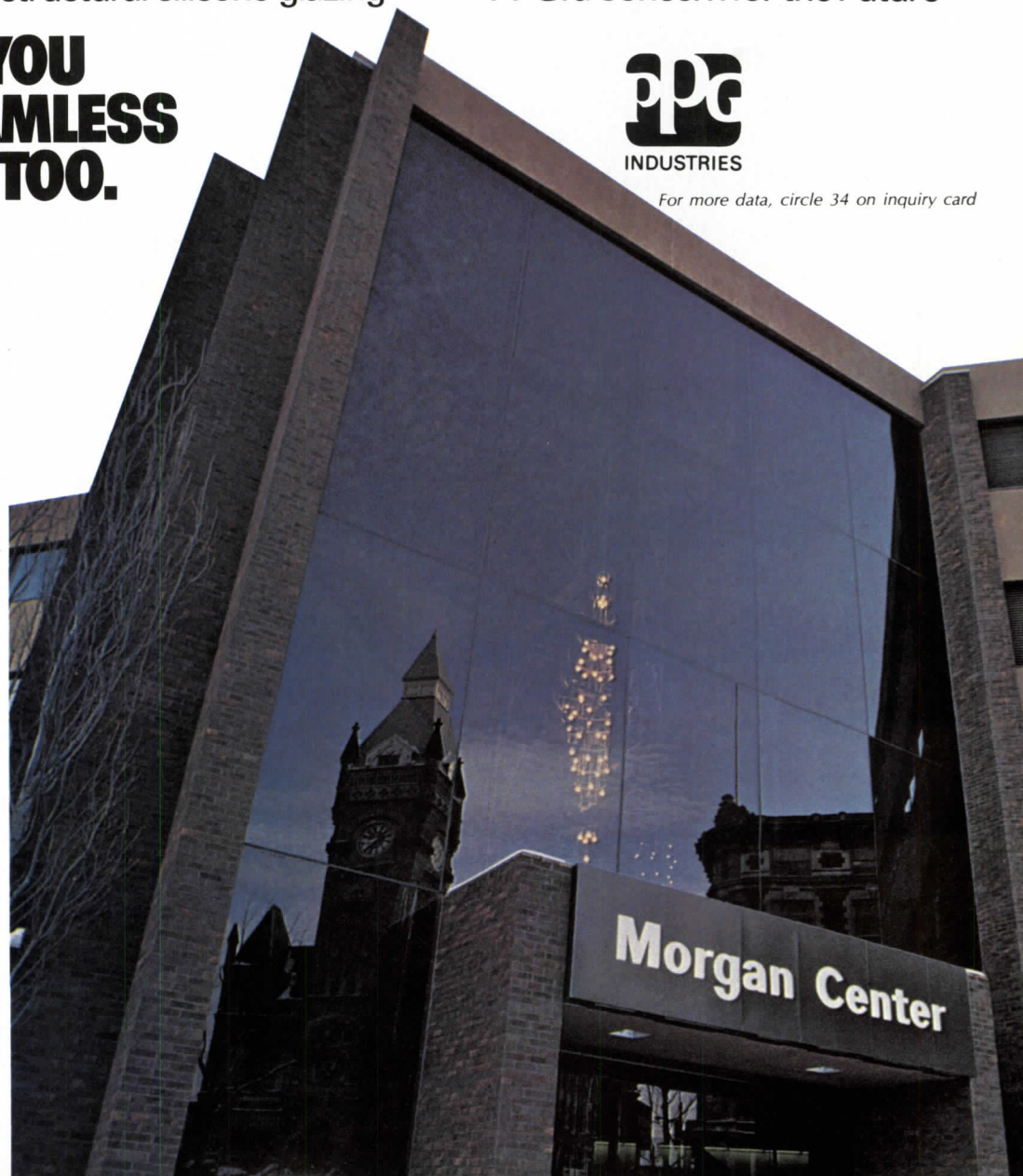



## Hotels top two McKim, Mead & White buildings

Hotels will exploit the air rights of two treasured New York City buildings designed by McKim, Mead & White—behind the Villard Houses (right), the new Palace Hotel, designed by Emery Roth & Sons and developed by Harry B. Helmsley, is under construction; above the Racquet and Tennis Club (below), architects Morse & Harvey have designed a luxury hotel for the Cowperwood Interests, whom the club appointed as developers. The Palace Hotel will maintain the facade and use the courtyard and foyer of the Villard Houses for its own main entrance.

Several of the Houses' rooms, with such ornament as a pair of LaFarge murals and a clock and a fireplace by St. Gaudens, will be preserved and used as public spaces. The Racquet Club, although not a designated landmark like the Villard Houses, is an important element in the urban texture, opposing its heavy Italianate stone to the glassy Seagram Building across Park Avenue and Lever House across 53rd Street. The 320-room luxury hotel would sit well back of the club's facade to minimize its impact on Park Avenue. A restaurant and landscaping will occupy the roof.

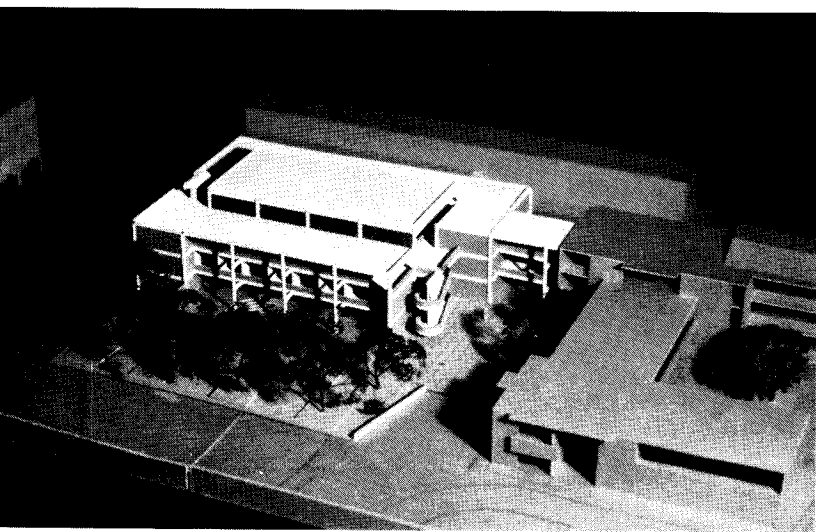
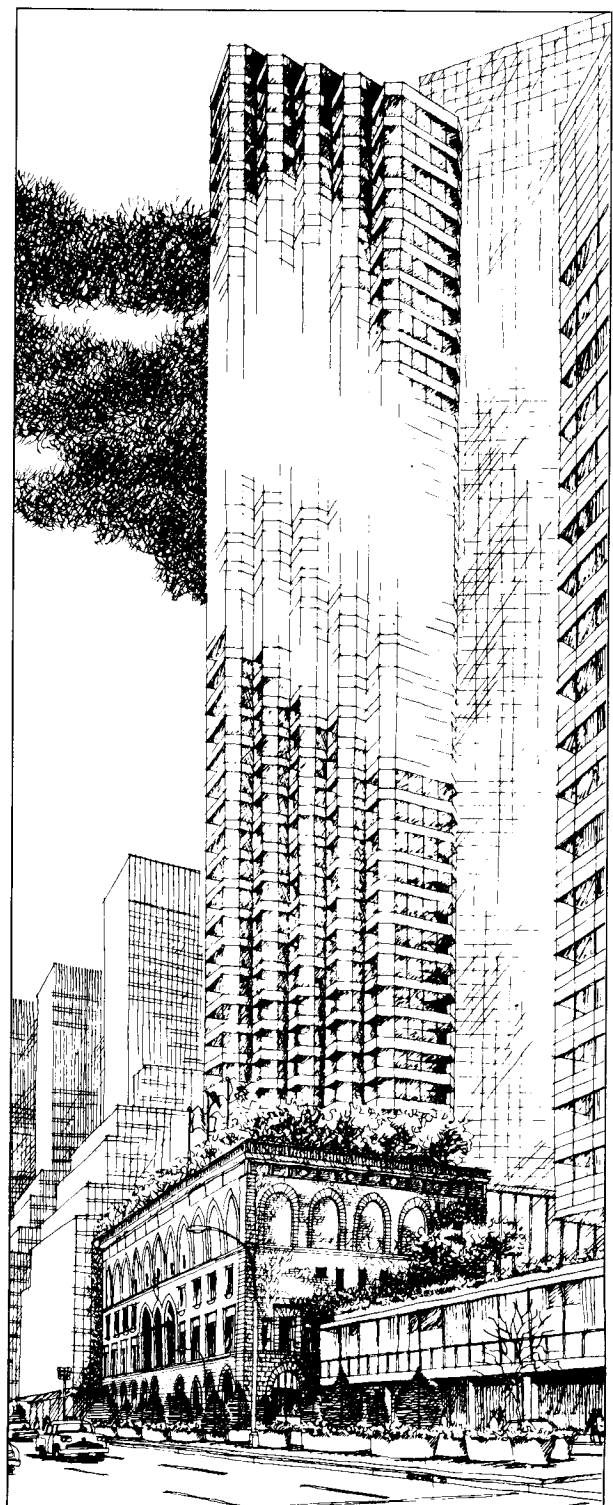

## Georgia Tech will expand its College of Architecture

For the College of Architecture at Georgia Tech, architects Cooper Carry & Associates of Atlanta have planned an addition that could itself serve as an instructional tool. To demonstrate the interdependence of engineering disciplines and ar-

chitectural design, the building will leave exposed the concrete structure as well as hvac, piping and electrical elements. The addition will house computer and research facilities, drafting and seminar rooms, library and faculty offices.

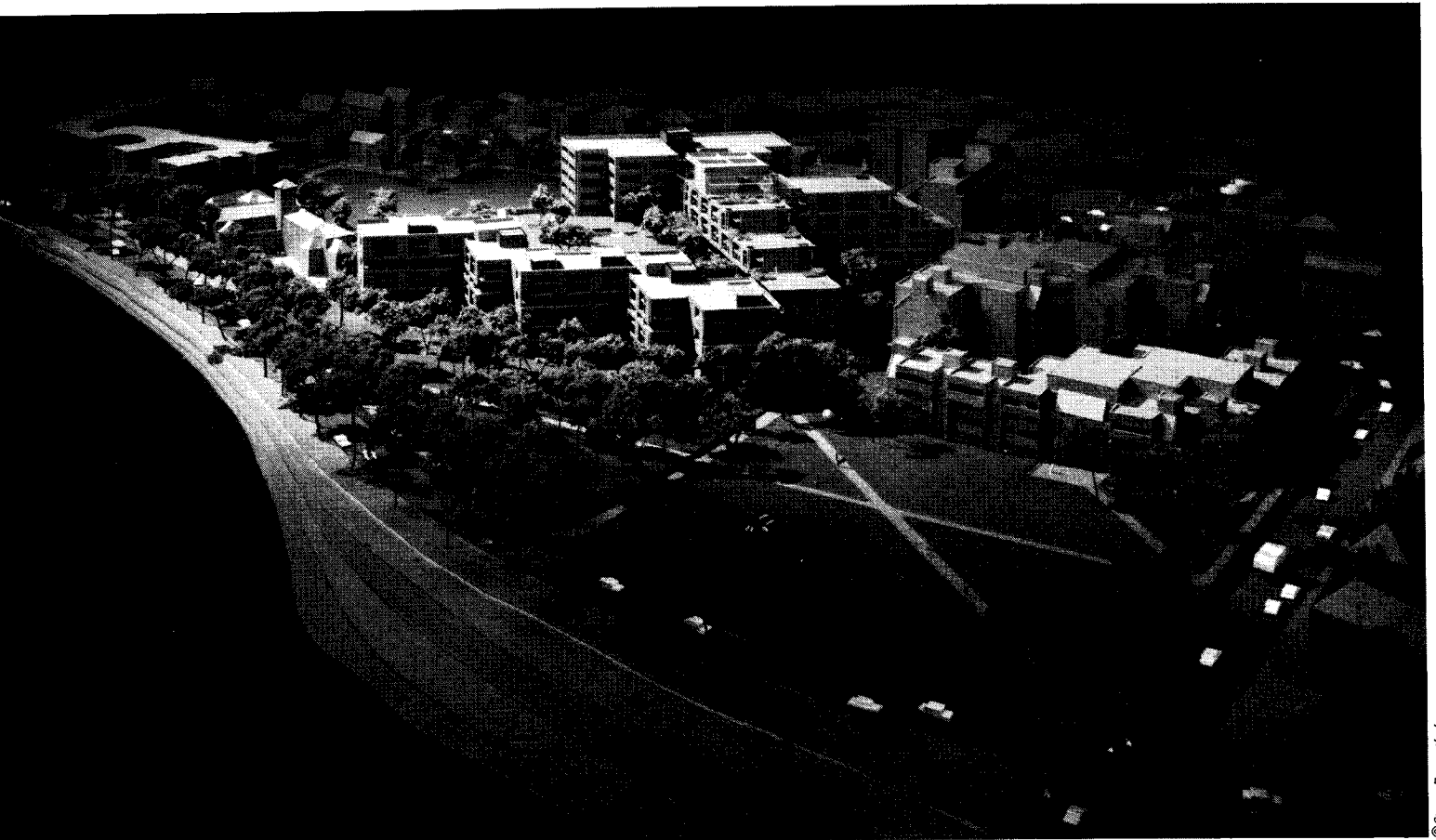

©Steve Rosenthal

**The team of Carpenter/Cambridge Seven wins competition for former Kennedy Library site**

For the development of the Cambridge site formerly intended for the Kennedy Memorial Library, Massachusetts conducted a competition (see RECORD, September 1977, page 35) and has now selected the

developer/architect team of Carpenter & Company and Cambridge Seven Associates. The winning proposal includes condominiums and apartments, overlooking the projected Kennedy Memorial Park and the

Charles River, and a multi-use commercial complex. The complex in turn includes a 210-room hotel, offices and 100,000 sq ft of retail space around an atrium linked closely with nearby Brattle and Harvard Squares.

**Setbacks reduce mass in small-scaled downtown**

The series of setbacks on the Kincaid Tower, now under construction in Lexington, Kentucky, serves a number of purposes simultaneously, according to architects Kohn Pedersen Fox Associates of New York City. First, they reduce the apparent bulk of the tower in the relatively small-scaled downtown area. Second, they allow a variety and multiplicity

of corner offices, a program requirement. Third, they provide physical identity for the five divisions that make up the Kincaid Group. A three-story extension of the tower will house a private cafeteria with terrace on the second floor, and a radio station at the top. A covered bridge connects the complex with a hotel across the street.

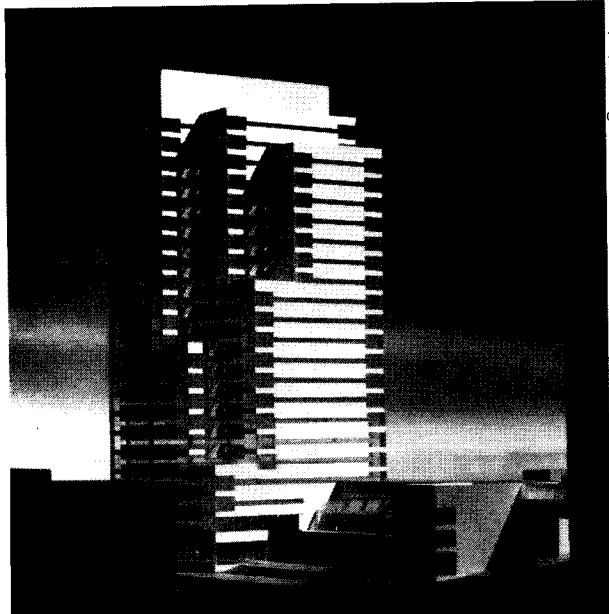

©Louis Checkman

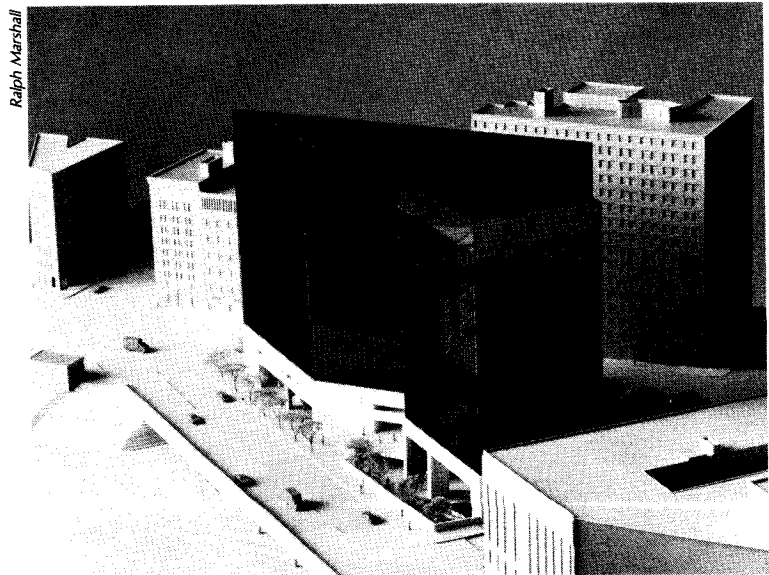

Ralph Marshall

**Black curtain wall faces Ohio State office building**

To reduce solar heat gain in an Ohio State office building designed to require only a quarter of the customary hvac load, the joint venture firm of Toguchi, Madison & Ireland, Associated Architects, designed a black glass and aluminum curtain wall with deep, closely spaced black aluminum mullions. These will support black opaque glass

spandrels and continuous strips of dark gray double-glazed lights. The architects report that only 25 per cent of the wall will be fenestrated. Located in downtown Cleveland, two blocks from Terminal Tower and above transit rails, the building will consolidate facilities for 20 state agencies now scattered around the city.

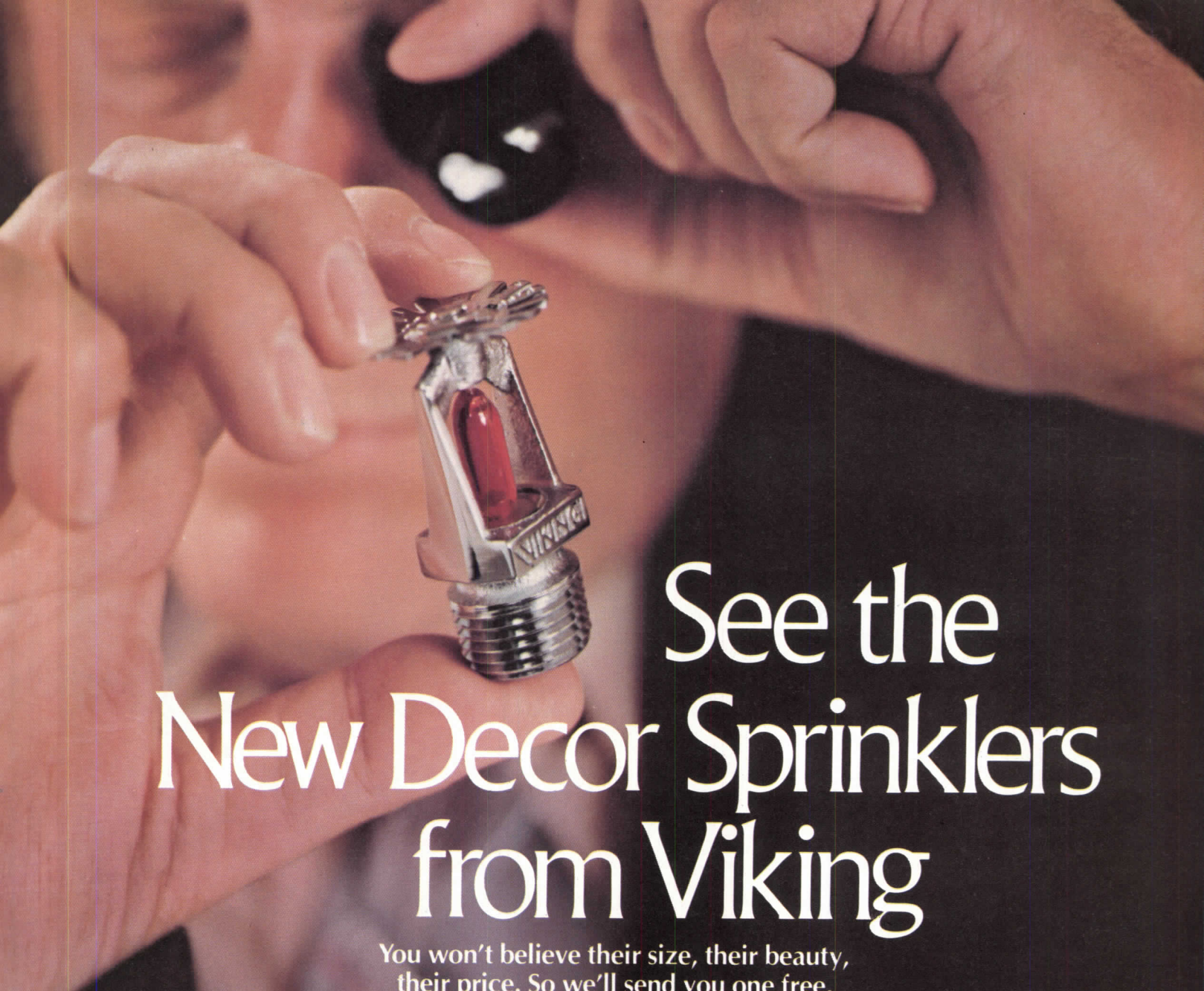

# See the New Decor Sprinklers from Viking

You won't believe their size, their beauty,  
their price. So we'll send you one free.

Decor is the first miniature sprinkler made by an American manufacturer. It's tiny. It's handsomely styled. And it's offered in pendent, upright, or sidewall models. Each comes in satin or polished chrome; natural or polished brass. With a choice of flush or recessed escutcheons. The glass bulbs are color coded for six temperature ratings. And unlike some glass bulb sprinklers, these are fast-acting—not slow. Their price is equally attractive: more than most link and lever models, but less than the flush or concealed sprinklers you've been using.

If you'd just like literature, simply circle the number below. But if you want a free sprinkler,

ask us on your letterhead. Write Gary Begg, Viking Corporation, Hastings, Michigan 49058.



**VIKING**

THE VIKING CORPORATION  
210 N. INDUSTRIAL PARK ROAD  
HASTINGS, MICH., U.S.A. 49058  
TELEPHONE (616) 945-9501  
CABLE:VIKING TELEX: 22-6400

"See us in Sweet's Catalogs"

For more data, circle 35 on inquiry card

## Interpreting Aalto

ALVAR AALTO AND THE INTERNATIONAL STYLE, by Paul David Pearson; *Whitney Library of Design*, \$27.50.

Reviewed by James R. Hunter

Alvar Aalto remains one of the most enigmatic and paradoxical architects of the 20th century. He is commonly acknowledged as one of the "masters of Modern architecture," and yet his reputation and his works seem to increase in interest and importance at just the moment when modern architecture, or at least the International Style, is the subject of severe doubt and questioning. This paradox forms an important question about the man. Just how is it that Aalto and his works seem so secure in a time of "post-modern revisionism" when his international reputation was based so clearly on two canonical buildings of the Modern Movement: the tuberculosis sanatorium at Paimio, and the city library at Viipuri (now Vyborg)?

This question has never been answered by the two sumptuous and expensive books produced by Aalto's studio, which are to date the most familiar presentation of his work. These books seem more like fancy office brochures than an interpretive record of a man's work. This is not to demean them, but only to point out that while they present Aalto's work rather completely, they offer few insights about Aalto's sustaining power as an influential architect. A small paperback book, edited in 1975 by Karl Fleig, and entitled simply *Alvar Aalto*, is a condensed version of the two beautiful hardback portfolios.

Aalto's death in 1976 left the Modern Movement without a living hero, and with virtually no heirs apparent. His death has also begun to engender a series of retrospectives. One such retrospective look at the man and his architecture will come in the form of an exhibition, organized in Finland, which will be on view at the Cooper-Hewitt Museum in the summer of 1979, and elsewhere in America after that. Several books are reputed to be in the works, and one important book, written by David Pearson, has just recently appeared.

Pearson's book, appropriately titled *Alvar Aalto and the International Style*, covers the first twenty-seven years of the architect's professional career, which is coincidentally the first half of Aalto's career. The book, which concludes with the death of Aalto's first wife and professional companion, Aino Marsio, chronicles in great detail Aalto's early provincial career, and rise to international prominence. The portrait of Aalto that emerges, ironically, is

not that of a "Modern Master", but of a much more complex, shrewd, enormously talented man who is far more interesting, appealing, and human than the slightly pretentious term "Modern master" can possibly suggest.

By means of Pearson's immensely detailed book, one can trace Aalto's earliest commissions, sense his awareness of his own provincial limitations, and witness his realization that immediate success and fame meant nothing less than flowing with the strong currents of the new architecture that would later be defined as the International Style. Thus, Aalto's first major architectural triumphs—at Paimio and Viipuri—must be seen not only for their distinctly Aaltoesque qualities, but as the efforts of a bright young designer who had looked long and hard at the new buildings he had seen on his travels to France, Holland, and Germany. There is a certain amount of "Pied Piper dynamics" involved in Aalto's International Style buildings—not exactly what you would expect from a "Modern master."

The main thrust of Pearson's book is to trace Aalto's flirtations with the International Style and its official body, C.I.A.M., and his subsequent disenchantment with and move away from the rather hidebound orthodoxies of the International Style toward a way of making buildings that at once encompassed modernism and local Finnish and other Baltic building traditions. The strength of Pearson's book is that Aalto is de-mystified. The canonical buildings which have generally formed the basis for Aalto's reputation are provocatively re-interpreted as the brilliant efforts of an ambitious young designer who had carefully assimilated the rules of what was then an avant-garde style. Pearson clearly asserts that Aalto's architectural achievements and the acclaim which has correctly come his way rest instead on his sustained efforts over a lifetime to find a personal form of expression. Beyond this new perspective on Aalto's life: the endless competitions he entered together with the judges and politics involved; his movements to Europe and America from year to year, some of which must have involved hair-raising journeys through war-zones; and his international friendships, especially with William Wurster, who brought Aalto to teach at M.I.T. As an added bonus, the book is beautifully illustrated.

All that having been said, it must be pointed out that Pearson's book is not for everyone. The tone of the book is factual, sober, and meticulous. The writing style is dense, dry, and matter-of-fact. Pearson allows himself almost no flights of fancy, no poetic license as a means of explaining Aalto. For all the fascinatingly informative quality of the

book, reading it can often be slow-going. All of which is to say that this book is not meant to be a first introduction to Aalto. For the reader who knows very little about the man, this book would do little to whip up much excitement. On the other hand, for the Aalto aficionado, even one who has seen many of his buildings, Pearson's book will offer new and substantial insights. The book will clearly be a major Aalto resource for years to come, or more correctly, it will be a major resource on the first half of Aalto's prolific career.

This last characteristic of the book I find somewhat troubling. Pearson has produced a prodigiously complete book on half a career, and he has noted to me, ruefully, that it would take another four years adequately to cover the second half of Aalto's career. Especially unsettling, however, is Pearson's epilogue, in which he argues that Aalto assembled a preferred set of architectural motifs during his first 27 years, and during the remainder of his career merely restudied and reused those motifs to produce unique designs. Now I am prepared to believe that a designer might early on assemble forms and motifs that would serve him well for a lifetime, but I am not willing to accept that the first use of a motif is necessarily the most important, mature, or even interesting use. The blue glazed tile skin on the city offices at Seinajoki, for example, may well recall the wooden skin of the Finnish pavilion at the 1937 Paris World's Fair, but it is Seinajoki rather than the Pavilion that exists as an unforgettable image, precisely because of that blue tile skin. Likewise, the interior of the Imatra Church, a late work, may have documentable precedents for each element, but that space still exists as one of the astonishing and unique rooms of this century. I'm inclined to believe, however, that Pearson does not really intend to belittle Aalto's later career, but rather had to find a satisfactory conclusion to a carefully written, understated, and very complete study of an important architect's early career.

The question I posed earlier regarding Aalto's seemingly secure reputation in the contemporary post-modern discussions is not answered or really even addressed by this book. Pearson has placed Aalto in relation to the International Style, as the book's title implies. It remains for the second volume, which Pearson will hopefully undertake, to review the second half of Aalto's career, and to place it into a setting that includes a number of talented younger architects across the world who are indebted to Aalto for inspiration.

Richard Oliver is the Curator of Architecture and Design at the Cooper-Hewitt Museum in New York City, and an architect.



## Design/build debate produces a new code of ethics

In just two hours on May 23, the 1978 national convention of the AIA settled a three-year debate over AIA members engaging in design/build and contracting activities. A majority of 3-to-1 (74 per cent) voted a revision of the Institute's code of ethics and professional conduct to permit a three-year experiment (which some believe will become perpetual) allowing members to profit from construction, provided the owner is fully informed of the architect's vested position. Viewed by proponents as a long overdue response to the marketplace, the revised ethics underline the steady trend to expanded architectural practice (but not necessarily to design/build), and the attempt of many architects to regain a leadership role that they feel has been forfeited, partly in the interest of self-preservation as liability exposure broadened.

Given healthy grassroots support for a more lenient code of ethics regarding design/build, and the exhaustive debate conducted over the last three years, opponents of design/build seem to have been worn down more than persuaded, and ultimately capitulated in the interest of Institute unity.

### Key opposition ultimately gave halfhearted support to design/build

Although the recommendation of the latest three-member AIA Design/Build Task Force assigned to study the issue unanimously endorsed design/build, one task force member long associated with the opposition made no secret of his unhappiness when he addressed the convention as a most unwilling supporter of the ethics revision. Said Jerome M. Cooper, FAIA, of Atlanta, "Everything that has been said on this issue that argues on behalf of *not* permitting members of this Institute to engage in design/build or contracting activities I still believe in my heart of hearts to be right and true."

Nonetheless, he urged the proposed

three-year experiment while alluding to what was undoubtedly the fear of many that the experiment would be only a transition to full acceptance of design/build.

"There are those among us today who believe that having embarked upon this experiment we will never be able to extricate ourselves from it in the event the results show it to have failed. To them, I would say that this is a substantial risk and that there can be no meaningful assurances that this would not occur. But when considered against the present measure of what we now stand to gain as opposed to what we now stand to lose (Institute unity), the risk seems worth the taking."

Other members of that task force were Harold C. Fleming, Hon. AIA (the public member of the AIA Board), and Jack McGinty, FAIA, of Houston. The just-past AIA president, Jack McGinty has been an ardent supporter of design/build, and in speaking once more for the revised ethics, he told the 1978 convention that the design/build proposal is "an opportunity for us to extend the professionalism and discipline of architecture beyond paper and into the execution of design as well; it represents an opportunity for greater control of the process by those committed to quality and bound by professional ethics."

Like Jerome Cooper, McGinty too worried about a house divided when he said, "we need a strong mandate to succeed in this new venture and this proposal represents a carefully considered consensus viewpoint that has earned the support of members whose opinion I deeply respect and whose support we will need in making this idea work. Passing a resolution is not enough. We need a united purpose."

### Substitute motion called on Institute to promote existing design/build options

One last effort by opponents of the design/build proposal took the shape of a

substitute resolution that would direct AIA to inform and instruct the membership in the design/build opportunities available under the then-existing ethics: essentially arrangements in which the architect is retained by the contractor who alone guarantees price to the owner. Speaking for this motion, Thomas Teasdale, Director, Central States, pointed to the liability dangers (see Legal Perspectives, page 61) of a design/build "business" which would not be afforded the legal protections of a "profession." Summing up, he said "I am quite sure that the membership is not fully aware of the design/build opportunities that exist under our present setup, and I am quite certain they were not fully aware of the serious shortcomings inherent in ordinary design/build, until this convention."

Mr. Teasdale also referred to the AIA legal counsel's opinion that by adopting design/build the Institute would be "opening membership to all sorts of people"—and he argued that AIA could well approach "the status of a trade association." This substitute motion did not pass.

The original Board-approved measure did pass however, resoundingly, and its often cited "profound impact on the profession" will be studied over the next three years by an AIA committee as yet to be determined by the president. Among others, the goals of this committee will be to determine: 1) number of AIA members involved in construction; 2) the quantitative effect on membership; 3) the risk/reward for the profession including liability exposure; 4) the change in share of total



Jerome Cooper, FAIA, a member of the Institute's Design/Build Task Force, who voted against the change in ethics in 1977. He urged support for the change in 1978.



Jack McGinty, FAIA, former AIA president, asking the convention to support the Board-approved design/build measure in the interest of extending architecture's professionalism into the construction process.

Adjustable hydraulic back check cushions the opening swing in advance of the built-in stop.

All weather hydraulic fluid eliminates seasonal adjustment to -30°.

Built-in door stop is solid one piece cast malleable iron shoe.

Heavy duty, solid forged steel parallel arm.



High strength cast iron cylinder.

Optional Door Holder holds open at 85°, 90°, 100° or 110°. One piece of hardware closes, stops, and holds the door open.

# CUSH-N-STOP THE DOOR

**The LCN 4110 Cush•N•Stop®.** A heavy duty Smoothee® Closer with a built-in stop that limits door swing. Designed to protect the door and frame from abusive traffic and windy conditions. Sweets, Sec. 8 or send for catalog.

The Jefferson Hall of Justice, Louisville, KY. Design Assoc. Co-partnership: Arrasmith, Judd, Rapp & Assoc.; Hartstern, Campbell, Schadt, Inc.; Louis & Henry Inc.; Miller, Whiry & Lee Inc.; Nolan & Nolan Inc.



LCN Closers, Princeton, IL 61356  
LCN Closers of Canada, Ltd., Mississauga, Ontario L5G4L5



construction market under control of architects; 5) impact upon scope of AIA services required, such as new construction-oriented documents, continuing education, financial management systems, practice aids, government liaison activity, labor relations, etc.; 6) shifts in members' perceptions of their role in society and society's perception of the role of the architect; and 7) the extent to which the members' role in design/construction and/or contracting brings a higher standard of professionalism and ethical performance to the development of the built environment.

#### The new ethics reverse the trend of moving away from construction responsibility

In sharp contrast to the San Diego convention (1977) with its theme of "Tomorrow," the 1978 convention concentrated on the problems of *now*, and the hard work that would be required to solve them. Carrying out the theme, "A Time to Learn," conventioners turned up in standing room only numbers at the educational sessions, the majority of which were on current design issues like energy, building re-use and project delivery and office management topics.

Architects may be "God's chosen" professionals—as President Elmer Botsai effused at the opening business session of the convention—but the public's choice was apparently more important to this assembly. Clearly, architects attending this convention were worried about their failure to make their services indispensable to the public and, more specifically, to those who commission buildings.

In effect, the design/build measure in the AIA code of ethics responds to some

complaints that "the present system of project delivery is not working very well." The preamble to the ethics change observes that the present system "is under increasing attack from non-professional competition and from rising societal expectations of accountability. The tendency has been to counteract this trend by moving away from direct responsibility for construction."

The intent of the three-year experiment in design/build is to see if another strategy—moving *towards* greater control of the process by architects—can produce better results. Said Jack McGinty, "This proposal (accepts) society's challenge to us for a greater involvement by our profession in the building process, and minimizes the risk by some very specific ethical guidelines to help those who elect to practice in this new manner."

#### As re-written, Canon 4 of Code outlines a major new role for architects

The significant change in the ethics occurs in R.405 which prescribes conditions under which a member may engage in design/construction activities where a guaranteed maximum cost is involved. (The intent is to assure that a member's construction activity will be as ethical as a member's other professional activity.) The essential rules are: 1) The owner must receive full, written disclosure of the conflict of interest, and be advised that independent professional advice might be in order (i.e., the owner might want another architect to oversee the design/build architect); 2) The disclosure will not relieve the architect of his responsibility to exercise professional judgment in the interest of the

owner; 3) The owner will have the right to see the sub-contracts and any other cost data; and 4) The owner shall be fully informed of the cost and other consequences of any proposed change or substitution and must approve same.

About item 1 above, the convention was told that "conflict of interest" is a legal term of art, referring only to the fact that there may be mixed feelings. It does not imply that someone is dishonest or unethical, but lets the client know that the architect will profit directly from the use of materials in the project. The design/build task force felt that this fact must be dealt with specifically in the new ethics code.

R.406 addresses architects who engage in activities that involve construction, but that are not purely construction: product sales, mortgage lending or other construction-related activities. As the note appended to wording of this rule states, even though no systematic conflict of interest exists in these activities as it does in design/construction, there are other areas of concern. This rule requires clear recognition of the member's role as a *commercial* rather than a professional one, and prohibits these members from intruding upon the client relationships of members engaged as professionals. As further safeguard of the professional activities of the traditional AIA membership, "commercial" members may not use professional training, credentials or AIA membership to imply professional relationships or otherwise mislead owners or the public. This prohibition applies to employers and employees of members as well.

The experimental period began July 1.



Thomas R. Teasdale, Director, Central States, addressing the convention in support of an alternative to design/build proposal.



Jerome Cooper, FAIA (left), and Jack McGinty, FAIA, listen to design/build debate on the convention floor.



Decathlon Athletic Club, Bloomington, Minnesota.

**Pella  
Wood Folding  
Doors.  
The attractive  
solution to  
space-control  
problems.**

Pella Designer Doors combine the look of richly paneled walls with the design freedom and flexibility you need to bring space into efficient, full-time use. Large areas can be spanned by joining several Pella Doors together. The space can be further divided in an almost unlimited number of ways by using Pella switches and curved track. Pella Folding Doors operate quietly with minimum effort and come in a selection of high quality, genuine wood veneers, or vinyl finishes, over a stabilized wood core.

For more detailed information, send for your free copy of our full color catalog on Pella Wood Folding Doors. See us in Sweet's General Building File, call Sweet's BUYLINE number, or look in the Yellow Pages under "doors", for the phone number of your Pella Distributor.

Name

Firm

Address

City  State  Zip

Telephone

**Mail to:** Pella Windows & Doors, Dept. T3G18, 100 Main St., Pella, Iowa 50219. Also available throughout Canada. Coupon answered within 24 hours.

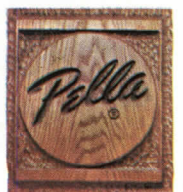

© 1978 Rolscreen Co.

For more data, circle 43 on inquiry card

## Design and business topics attracted hundreds at learning sessions

The 1978 AIA convention, unwilling to make continuing education mandatory for AIA members, nonetheless packed to overflowing many of the professional development sessions offered this year. Although forced continuing education remains controversial (the issue was tabled in the business session), practitioners demonstrated that they had come to Dallas to learn—about business development, but mostly about design (see Editorial, page 13). This year, the membership was surveyed in advance of the convention, on the professional programs to be included. In spite of the "business" tone set at the gathering by the design/build and advertising issues, in the survey design topics (nine) remained on a par with business development and construction management topics (eight) in the professional development portion of the convention.

But attendance figures tell the real story. In what one Institute official considers a precedent, 1200 people stayed beyond the official convention closing to hear Philip Johnson, FAIA, moderate a discussion on "design in transition," this following the convention's second most popular program: a warm-up to Mr. Johnson's Gold Medal dinner delivered by Peter Eisenman, Frank O. Gehry, Michael Graves, Charles Gwathmey, Charles W. Moore, Cesar Pelli, Robert A.M. Stern and Stanley Tigerman.

Attendance also ran high at a program on energy conscious design and at one on solar energy, both of which attracted 750 people (standing room only).

If design was a popular topic at this convention, interest has evidently waned in some of the "hot" issues of late. Programs entitled Legal Aspects of Practice, Urban Design, Hospital-Based Ambulatory Care Services, International Practice, Life Cycle Costing, New Trends in Housing, and Compensation Management were rejected by the 1100 members who responded to the Institute's pre-convention survey.

### Architects told that financial analysis can be a profitable new service

A series of business topics drew capacity audiences of 600. The most popular of these sessions were: Effective Business Planning, Financial Analysis of Building Projects, Managing What You Market, Construction Management for Architectural Firms, Creative Communications for Architects, and The Architect as Land Developer.

In his session on Financial Analysis of Building Projects, Thomas E. Selck, AIA, of Pittsburgh told a capacity audience that if architects hope to continue to serve their clients, "they'd better become experts in real estate financial analysis.

"All too frequently 'go-no go' decisions on a project are made by owners upon the advice of others without even thinking of involving their architect early in the planning stage."

President of both the Selck-Minnerly Group, architects, and of Managed Concepts Corporation, a management consulting firm, Selck noted that "clients' financial advisors seldom, if ever, have hard experience with the realities of the building world. The weight of their recommendations can be well out of proportion to their professional competence as it relates to the total building picture. Frequently, potentially successful projects are prematurely cancelled and, all too often, projects are initiated which should not have been."

Selck told the architects that extremely few corporations had the expertise to accurately assess the value of their property and facilities. (This fact is borne out by some architects who are beginning to offer an assessment service to their clients, particularly institutional ones.) Selck further noted that most companies do not have individuals capable of "creative financial management of real estate," and this lack provides an excellent opportunity for architects who understand financial analysis to provide a profitable additional service to their clients." (For an explanation of the building financial analysis process, see RECORD, December 1977, page 56).

### Architects get insufficient training in financial aspects of buildings

Selck said that the profession has been suffering from unnecessary criticism when "unexpected" cost overruns occur or capital requirements are perceived as excessive by owners. Similarly, architects get blamed for the design of buildings which do not rent, and the profession also suffers from public reaction to the appearance of buildings which did not benefit from the services of an experienced architect. When these criticisms are boiled down to actual conditions, project failure—either financial or esthetic—is generally based upon economic decisions made by the owner and his advisors. Architects are not permitted in the boardroom at financing time, but are expected to perform as though they were.

Selck believes that architects are equipped by training and experience to undertake many types of physical studies and evaluations with a high degree of competence. However, the normal training of an architect does not equip him or her to deal effectively with the financial aspects of building projects.

He further believes that architects must learn this aspect of business if for no other reason than to protect them from investing time and money in financially unsound projects with attendant loss of income when the project fails. Besides providing a service worth additional compensation, an architect who performs a financial analysis can assist owners in determining the true mortgage value of projects. Instead of asking what a project is "worth," the architect can present documentation which tells the lender that the client knows what the project is worth. In many instances the paper work has the effect of increasing mortgage values of a project.

Although architects find such consulting work of value to a variety of clients, Selck's firm has concentrated on corporate and industrial clients. According to Selck, some other markets for this type of service include municipal governments, schools and developers. Capable architects can work with land developers, for instance, in determining the highest and best use for properties.

### A successful new service can provide an architectural practice spin-off

Founded in late April, Management Concepts Corporation was a spin-off of Selck's architectural practice. Left with an ample amount of uncollectible accounts receivable when several developers proved to be overly optimistic about a project, Selck decided to learn about financial analysis seven years ago, and has offered this service separately from his architectural services. The service proved popular enough that the firm decided to found the new MCC in conjunction with a specialty service—solar energy conservation/management—developed with another Pennsylvania architectural firm, Burt Hill Rittlemann Associates.

Architects attending this continuing education session at the convention were given three hours of instruction in preparing a detailed real estate pro forma, and were told how to get paid for doing this. They were also shown how to help clients obtain financing, and how to discern which clients have the financial resources to undertake a given project.

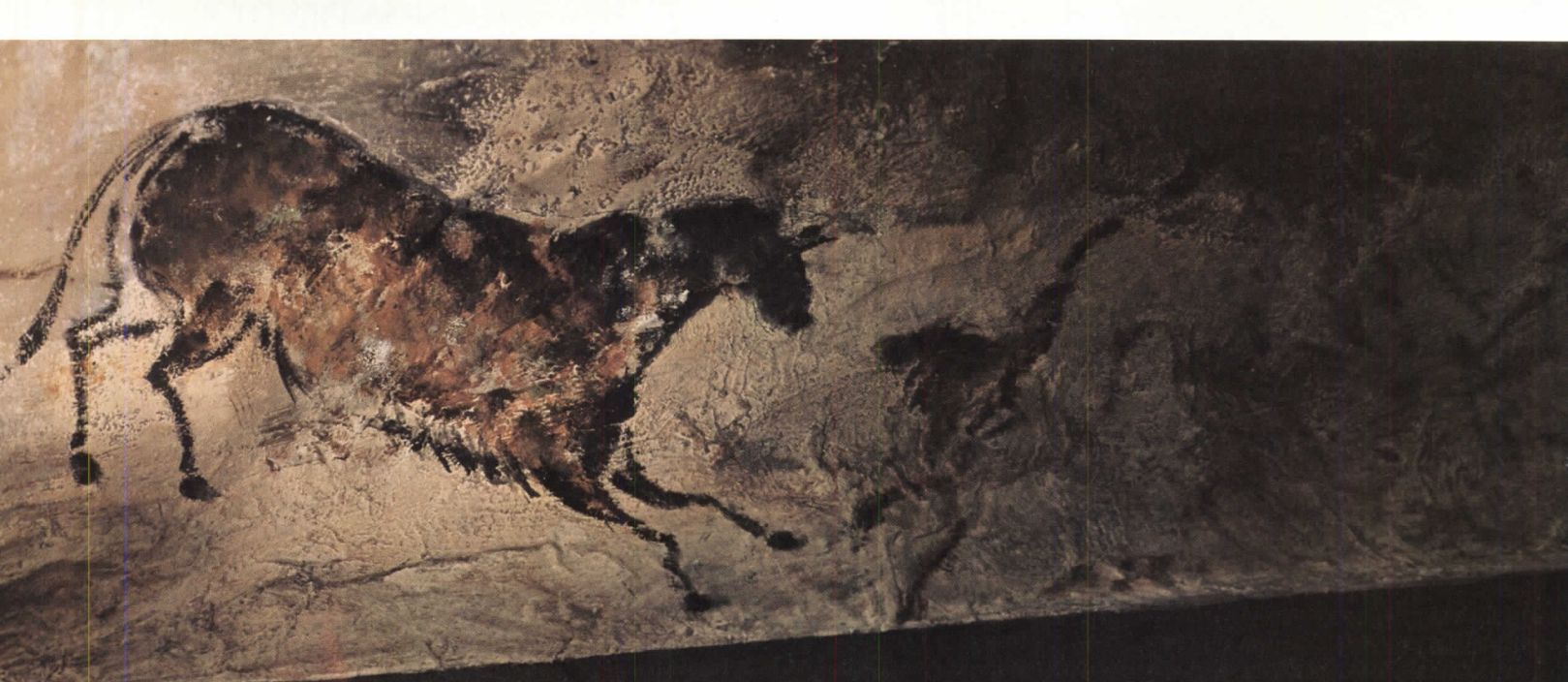

## Flint. A new primitive art form.

The ageless beauty of nature itself is yours to work with. In Flint. An earthy color of American Olean's Primitive™ ceramic tile—the natural thing to use.™

Flint has a warm, rich color. Soft, handcrafted texture. And Flint is unglazed, so its sculptured beauty endures even high-traffic commercial wear. It cleans with just a damp mopping.

Flint and unglazed, earthy Terra Cotta bring to twelve the number of Primitive colors now available. Add to that six distinctive shapes, for endless imaginative design possibilities.

See Flint (shown in 8" x 8") and the entire Primitive line at any American Olean Showroom or Color Center. Or send for a copy of our Primitive Brochure. Write to: American Olean Tile Company, 2490 Cannon Ave., Lansdale, Pa. 19446. Primitive. As new as the world is old.

Available worldwide TELEX 84-6407

CERAMIC TILE  
**American  
Olean**  
A Division of National Gypsum Company

# Home mortgage money looks imperiled again

Considering how credit has tightened in recent months, you're going to be hearing the word "disintermediation" used more frequently in 1978. With inflationary pressures mounting again, the Federal Reserve has increased its efforts at restraining the growth of the money supply (top chart). To the extent the Fed has been successful, interest rates were pushed still higher (middle chart). Since the rate of interest paid on personal savings adjusts slowly to money market conditions, the recent round of credit tightening has widened the gap between yields on savings and on some of the alternatives to time deposits—Treasury bills, certificates of deposit, and other money market instruments. As that spread increases, sophisticated depositors (usually the ones with sizeable deposits) begin shifting their funds.

The bottom chart shows how savings flows are affected by this sequence. As long as the Treasury bill rate remained close to 5 per cent (the T-bill rate is used here as a general indicator of the yield on all alternatives to savings deposits) as it did through most of 1977's first half, savings inflows to the nation's S & L's rose steadily to a peak rate of just over \$65 billion. Then, as money was tightened in the second half, the bill rate rose above 6 per cent in October, and then advanced to 6½ per cent by January. It wasn't long before the flow of savings began to drop off as savers sought more attractive yields. In 1977's fourth quarter savings dropped 25 per cent, and in this year's first quarter, another 25 per cent. Between August, 1977 and March, 1978 the increase of a full percentage point in the T-bill rate had cut the flow of savings nearly in half.

What happens when deposits at thrift institutions begin to shrink? Most of it is transferred to the commercial banking stream and from there to business borrowers offering a higher interest rate. The ultimate loser is the potential home buyer (either new or existing housing) who depends on the thrift institutions for mortgage financing.

After three years of strong savings flows, the thrift institutions are highly liquid, currently holding more than \$22 billion in commitments for future loans. What's more, liquidity can be supplemented in at least two important ways when deposits weaken. S & L's can raise funds by selling existing loans from their portfolios. They can also borrow directly from their "parent," the Federal Home Loan Bank Board. However, neither of these sources is an adequate substitute for a healthy flow of savings. And deposits are expected to dwindle as 1978 wears on.

To help sustain a satisfactory rate of savings under conditions that encourage disintermediation, banking authorities have come up with a new wrinkle—a six-month savings certificate that bears an interest rate which is tied to the Treasury bill rate. In this way, depositors would realize some of the benefit of investing in high-yielding securities without shifting their funds. And not incidentally, the housing market would be better insulated from occasional periods of mortgage drought. This interesting experiment, which began June 1, just might add a margin of ease in 1978's second half.

*George A. Christie  
Vice president and chief economist  
McGraw-Hill Information Systems Company*

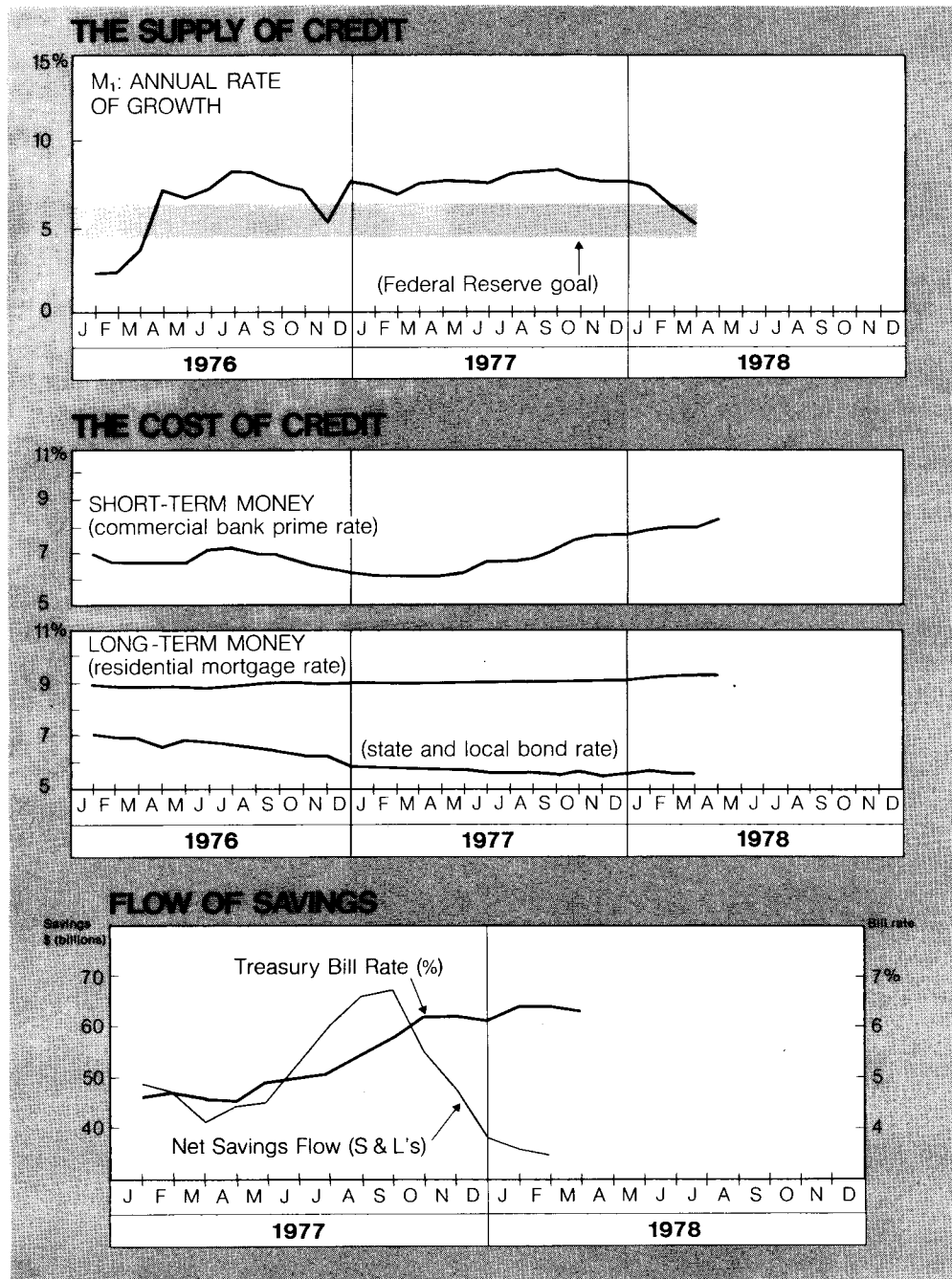

## Offices opened

Laurence Allen and Garth Sheriff have combined their design and architecture practices to form Allen/Sheriff & Associates, 3020 South Robertson Boulevard, Suite 4, Los Angeles, California.

Verner I. Burks has announced the formation of Burks Associates, Architects & Planners, 1221 Locust Street, St. Louis, Missouri.

Fischer/Schutte, Inc., has opened offices at 2312 West Wisconsin Avenue, Appleton, Wisconsin. Jack L. Fischer and Laurent J. Schutte will head the architecture firm.

David R. Johnson and Frank Olney announce the combining of their practices into Johnson Olney Associates, Inc., Architects, 100 Boylston Street, Boston, Massachusetts.

H. James Lentz and Wayne D. Paulk have formed H. James Lentz & Associates, Lewis State Bank Building, Suite 616, Tallahassee, Florida.

William E. Nemmers has established a new private architectural practice with offices at 19 Church Street, Belfast, Maine.

William Paxton & Associates, Inc., consulting structural engineers, has opened two new offices. The new Florida office, to be known as Paxton-Khan & Associates, Inc., will be headed by M. S. Khan and will be located at 8400 Northwest 52nd Street, Miami, Florida. The second office is located at 553 East Jefferson Avenue, Detroit, Michigan.

## Firm changes

Abramovitz-Harris-Kingsland, Architects, have named Gerald I. Schiff and John S. Hagmann as associates.

Robert Abrash, Philip Eddy Architects has named Richard A. Eckhardt as a partner in the firm.

Gunnar Birkerts & Associates announces the advancement of Barbara J. Bos and William A. Wolfe to associates.

Briggs Engineering & Testing Company has announced the appointment of George Hamparian as vice president of materials testing.

Sandra Trubow has been appointed research assistant with Broome, Oringdolph, O'Toole, Rudolf & Associates.

Fred M. VanGaasbeek has been named an associate of Richard Browne Associates.

Cavitt McKnight Weymouth has named Daniel R. Gutierrez and John E. Joiner senior associates and S. Madeline Chu and Gary P. Langlais as associates in the firm.

Corgan Associates, Inc. has announced the appointment of Brent E. Byers and Bryce A. Weigand as vice presidents.

Dames & Moore announce the admission of seven new members. They are: Alexander E. Aikens, A. Peter Campbell, Frederick M. Kessler, Douglas J. Lootens, George W. Nicholas, Albert D. Pernichele, and Pedro O. Ramirez.

Danielian Associates has named Kenneth R. Mullens as an associate.

The architecture and engineering firm of DMJM-Phillips, Reister has changed its name to DMJM-Phillips, Reister, Haley, Inc. with the addition of John L. Haley as vice president.

Fisher Friedman Associates are pleased to announce that G. Mary Bulota has become an associate in the firm.

Gensler and Associates/ Architects has named five new vice presidents. They are: Charles C. Kridler, Steve L. Wintner, Yee Leung, Marvin L. Taff, and Walter A. Hunt.

*Remember!  
Watch "Paul Anka  
in Monte Carlo"  
Sunday, Aug. 27  
CBS*



*We had this original idea. Make an automatic pencil that uses lead so thin it can pass through the eye of a needle. Yet won't break while writing. We did this by ① surrounding the lead with a sliding sleeve ② that protects during writing and ③ fully retracts.*

**Sliding Sleeve™**

**Pentel®**

© 1978 Pentel of America, Ltd.  
® Pentel is the registered trademark of Pentel Co., Ltd.

For more data, circle 46 on inquiry card

# NEW SITELITE 5

*for the added touch of beauty  
in architectural landscapes...*

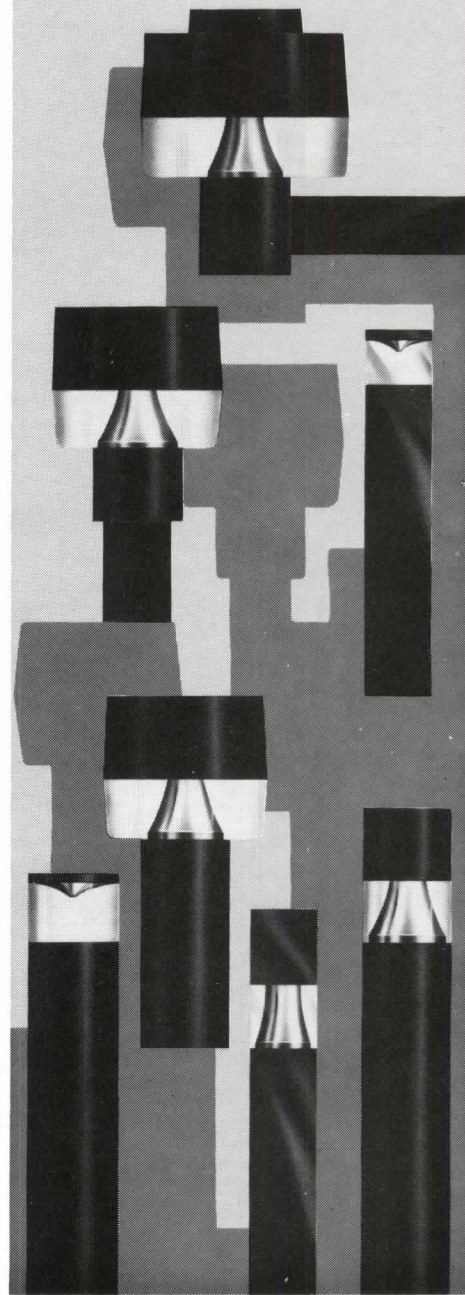

Here's a bright, new design collection of graceful bollards and indirect mid-level post lights... Square and round luminaires and poles, various heights, and companion models for wall mounting. Fresh, harmonious designs to help blend today's newly-created sites with their structures and total environment.

**SITELITE 5** from McPhilben. It's the added touch of beauty from the experts in outdoor lighting.

**mcPhilben®**

**mc PHILBEN LIGHTING**  
EMERSON ELECTRIC CO.

270 LONG ISLAND EXPRESSWAY/MELVILLE, N.Y. 11746  
CANADA: P.O. BOX 150, MARKHAM, ONTARIO

For more data, circle 47 on inquiry card

more Office Notes on page 147

# Three designs by JOHNSON/BURGEE

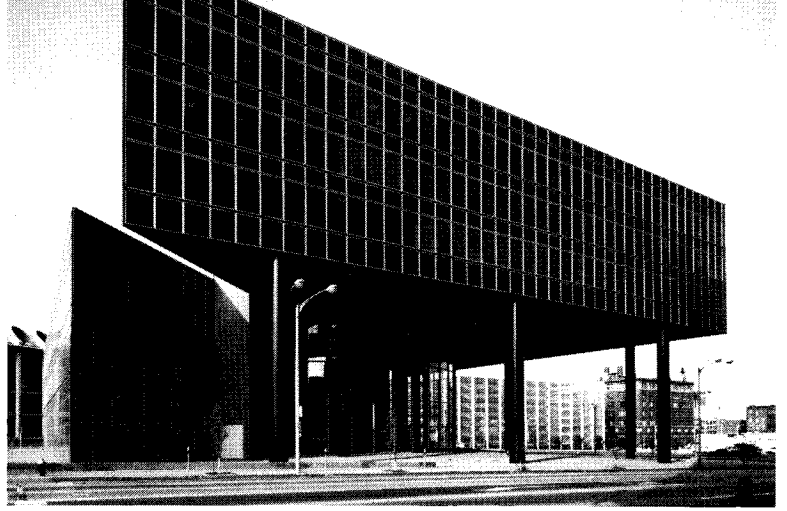

Gold Medalist Philip Johnson is one of a small handful of architects who can make the profession flinch—or at least reverberate with a tremor of incomprehension—by simply holding up a sketch. He has done so before. He and partner John Burgee do so now with the proposed designs for AT&T in New York (sketch center) and the Cultural center for Dade County sketch below). “Neither of these designs is revolutionary,” says Johnson, but each is a departure (perhaps too abrupt to be called “evolutionary”) from the firm’s General American Life Insurance Headquarters (photo above) completed and occupied earlier this year.

The contrasts are striking and the controversy that the two projects have engendered will almost certainly continue. Some have already hailed these projects as liberating gestures intended to free architects from hidebound Modernist dogmas no longer viable. They see parallels here with other theaters of life where pluralistic values have become the rule and where consensus in anything seems harder and harder to achieve. For others, though, the new work is aberrant, archaizing and more than a little irrational. But even those who take the latter view cannot simply dismiss these projects with a careless shrug.

Johnson’s own views, extracted from a talk with RECORD’s editors, are provocative and challenge some of the Modern movement’s most sustaining and consoling myths. Beginning on page 85, he describes his intentions, his outlook and his hopes for architecture’s future. —Barclay F. Gordon

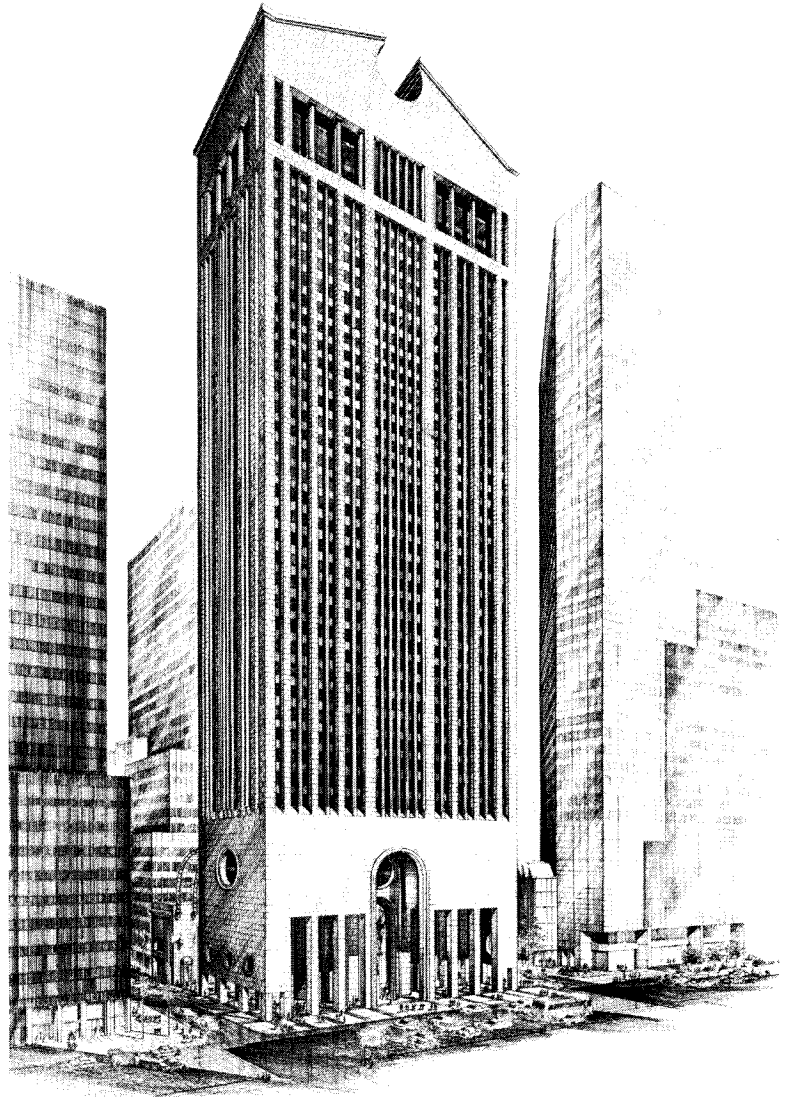

## Aberrant, archaizing, irrational—or welcome liberating gestures?

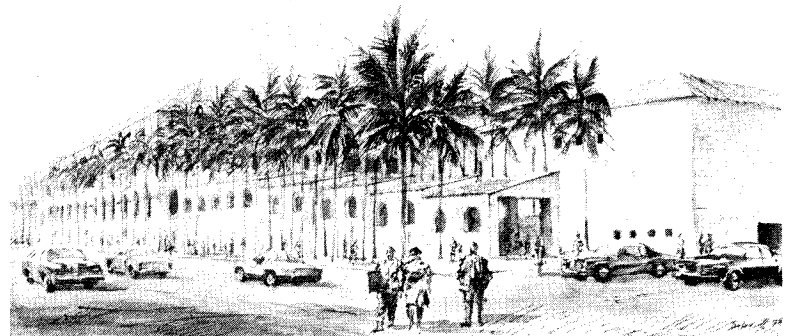







Richard Payne photos

# GENERAL AMERICAN LIFE INSURANCE BUILDING

“The spatial play is devious though the geometry is absurdly simple”  
—Philip Johnson

The temptation to lump projects of like kind in Philip Johnson's work, at whatever risk, is almost irresistible and Johnson himself is quick to point to the obvious similarities between his General American Life Insurance Headquarters in St. Louis and both Pennzoil Place in Houston and the Crystal Cathedral he and partner John Burgee now have under construction in Garden Grove, California. All three are angular, glass-skin designs, their forms elaborately faceted to achieve high visual impact and details of elegant precision. They are gleaming, hard-edged prisms of an increasingly familiar kind; and though there is a visible element of daring in each—none could be considered even a trial flight over the ground of post-Modernism. Pennzoil and General American, in particular, explore a similar and easily recognized set of corporate images and user criteria. But whereas Pennzoil is a skyscraper that appears to slouch a little as if embarrassed by its great height, General American is a low-rise structure that stands tall—and wishes it could stand taller.

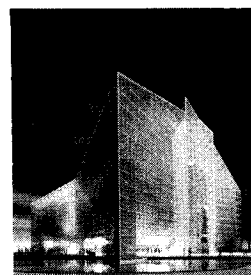
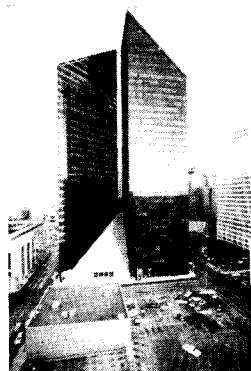

©Louis Checkman

In ground plan it is a 208 foot square, cleaved along one diagonal. The two triangular sections that result are held apart by a slender brick cores but united by a tall, central, cylindrical rotunda. One of the three-story triangular sections moreover is raised on columns some 45 feet to create a large, shaded corner plaza. This vertical thrust, which gives the design its “standing on tiptoe” quality, is the successful product of a conscious effort to lend some grandeur to a building of comparatively modest volume set amid more massive neighbors in St. Louis' downtown Civic Center.

One such neighbor, just to the south, is venerable Busch Stadium, sacred to the memory of Dizzy and Daffy Dean, Pepper Martin, Joe Medwick, Leo Durocher and other members of baseball's famous (or infa-

TYPICAL FLOOR (FOURTH)

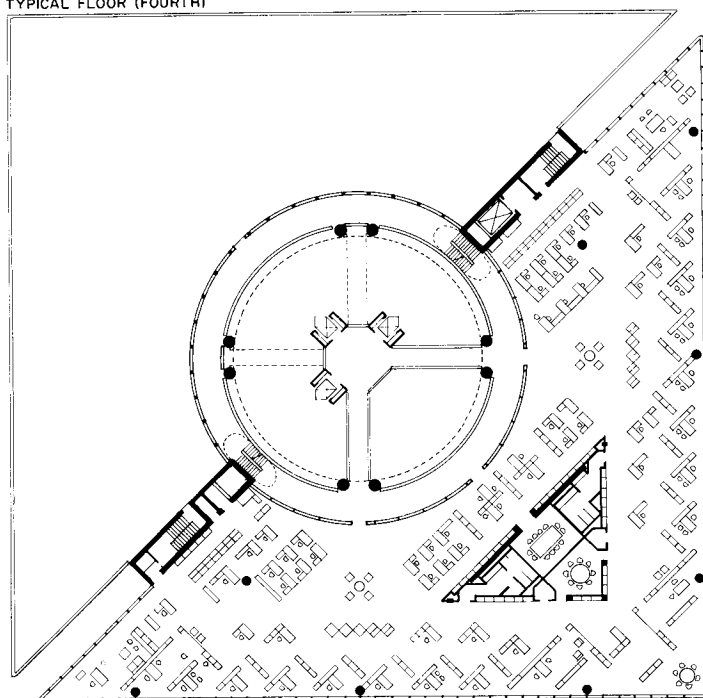

FIRST FLOOR

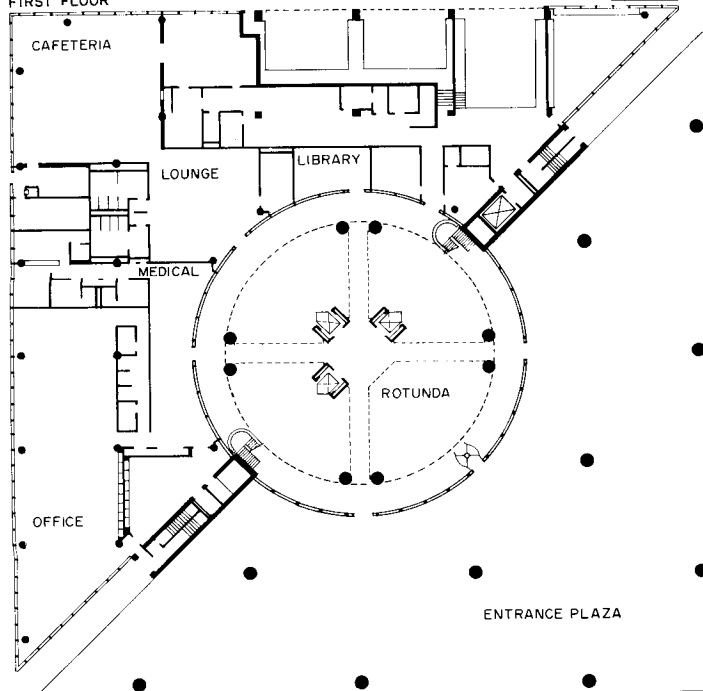





mous) "Gas House Gang." Another is the Old Courthouse with its neo-classical dome rising triumphant four blocks to the east. But more "present" than either of these, though it is not yet as visible, is Louis Sullivan's Wainwright Building just a block to the north. The block that separates General American from Wainwright is scheduled for eventual demolition to make way for a mall. If and when that happens Sullivan and Johnson/Burgee will face each other across a narrow gulf of time and an even narrower gulf of space.

Without discountenancing any of these neighbors, the General American Headquarters makes a vigorous statement of its purpose in a strictly-disciplined geometry of squares, triangles and cylinders—all chastened by the architects to behave, cooperate, or at the very least coexist peacefully. There is, of course, considerable visual emphasis placed on the acute corners of the office floors. These are detailed almost as knife edges and kept out of the same plane by the building's three-story vertical offset.

If the exteriors seem to lack some of the imposing character of Pennzoil's, if they stop a trifle short of the Crystal Cathedral's promised sparkle, the interiors of this St. Louis building are a knockout—as strong in their way as anything that Johnson/Burgee has done. The great rotunda space, 107 feet high and top-lighted, is a supremely powerful and dramatic composition. The vertical lines of force created by the four pairs of columns and the three elevator shafts with their glass-walled cabs are countered by beautifully detailed horizontal bridges that lead from the elevator shafts to the office areas. And uniting everything are sculptured stairs that give expression in a visual shorthand to the building's characteristically offset section.

In discussing his recent work in the broader context of change, Johnson turns most easily and comfortably to metaphor. He sees the modern movement, once a river, now dividing up into rivulets. The fingers of his outstretched hand, palm down, reinforce the analogy. He says the process of division and subordination began slowly a generation ago and is accelerating today. His recent projects with John Burgee (see next pages) are part of this process and respond to altered perceptions of history, of symbol, of community. Whether the rivulets will reform into a river, or whether they will break apart further into streams, streamlets and itinerant meanders—some finally drying up before they reach the sea—he does not know.

He does not, however, discount the possibility of following any direction of flow—including presumably upstream—as new circumstances, intuitions, or opportunities might seem to warrant.

GENERAL AMERICAN LIFE INSURANCE HEADQUARTERS, St. Louis. Architects: *Johnson/Burgee* Engineers: *Severud-Perrone-Sturm-Bandel* (structural); *William Tao Associates* (mechanical/electrical). Contractor: *McCarthy Brothers*.



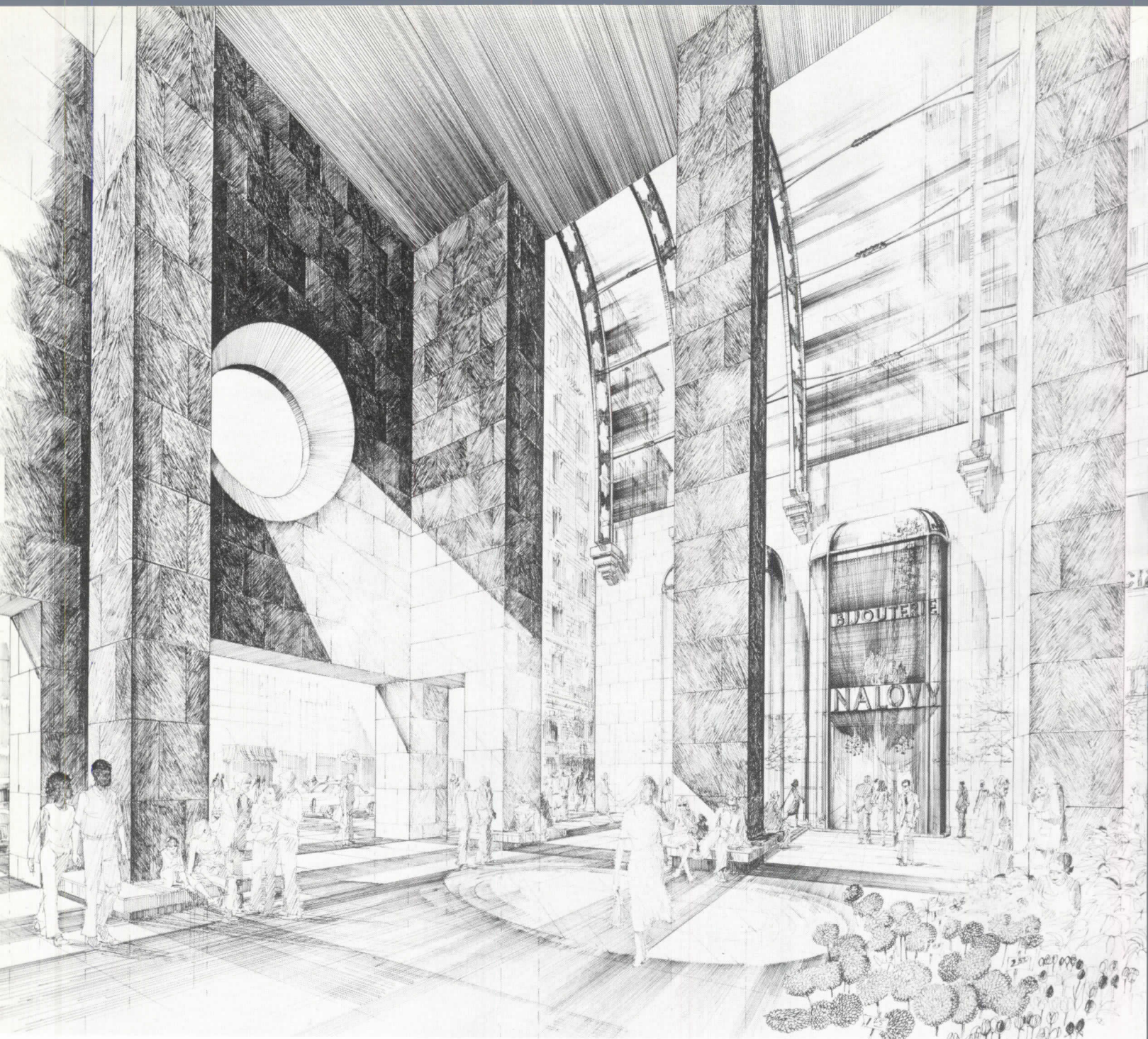

*Gil Amiaga photos*

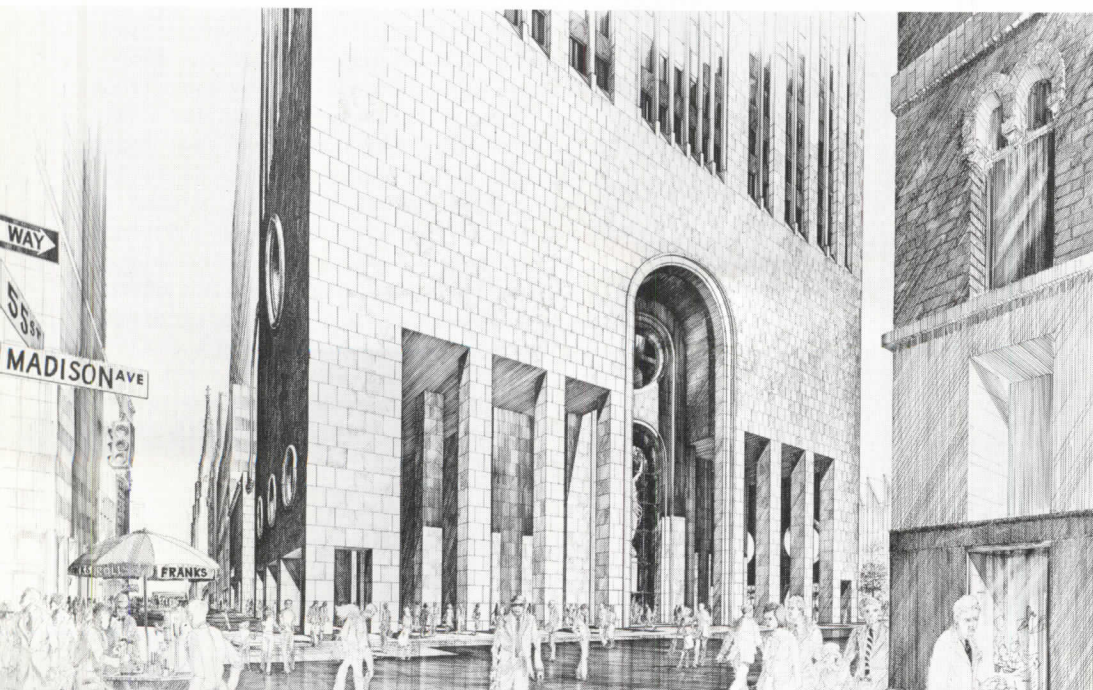

## Headquarters for American Telephone & Telegraph, New York City

This 660-foot-high stone and glass tower will rise on a prominent Madison Avenue site in midtown Manhattan. Johnson proposes a largely open plaza at street level that ties to a mid-block pedestrian arcade to the west. The main building volume begins above the 60-foot-high plaza space shown in these sketches. The office floors with central cores are conventionally designed except that Johnson is aiming at 30 per cent glazing. The remainder will be clad in a pinkish granite. The controversial top, (a "recognition cap" Johnson calls it) will house mechanical equipment.

# TWO CURRENT PROJECTS

"I want McKim Mead and White to triumph in New York but not in Southern California or in Miami, Florida"

Two of Johnson/Burgee's most recent proposals have stirred up gales of controversy both inside and outside the profession. AT&T in New York (shown here) and the Cultural Center for Dade County (next pages) are not, says Philip Johnson, any signal of a revolution. "I don't believe in revolution, I'm not post-anything, and I'm still a functionalist modernist." Rather, he argues the new buildings reflect the new pluralism that has entered American life and thought.

**Johnson sees several reasons for "the new freedom."**

**One is a changing national attitude:**

"Who thinks of the melting pot anymore as a solution for America? We now think of ourselves as a pluralist society. Look at *Roots*. Our basic philosophy as a people has undergone a profound broadening. What's best for one isn't necessarily what's best for all . . . It's the attitude of the consumer that's changed, and what this change has done for the architect is given him a most significant sense of freedom."

**Another: "We got tired of the architect-will-tell-what-you-like morality," the morality that said "we'll-conquer-the-problems-of-the-world-with-architecture . . ."**

"Instead of that, I feel there's a new morality. I feel that architects have been too far from the mainstream of esthetic reaction. The painters showed us the way and we can rejoice once more in the mainstream of taste and public sensibility.

**Another is the desire for symbolism**

"This is a reaction that has been very positive. The attitude of painters toward the common object, starting with Jasper Johns through Warhol and the neo-Realists, has influenced everything we do. It has changed not only our perceptions but our whole notion of progress. Progress once meant killing Indians. Twenty years ago, progress meant modern architecture, modern architecture meant virtue, virtue meant we're all going to come out together somewhere in a great Nirvana. Nobody believes that anymore. Everyone knows, I think, that the problems we're going to meet are entirely different. And we're going to have to analyze the problems differently . . ."

"Linked to this question of symbolism is a new feeling of 'neighborism'. I don't mean by this just the Californians—although Charles

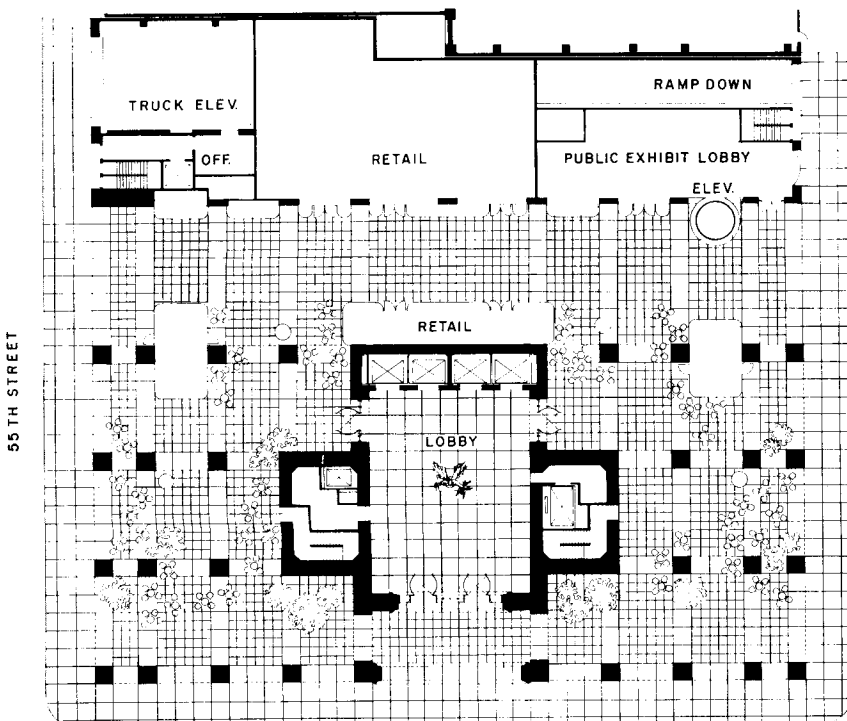

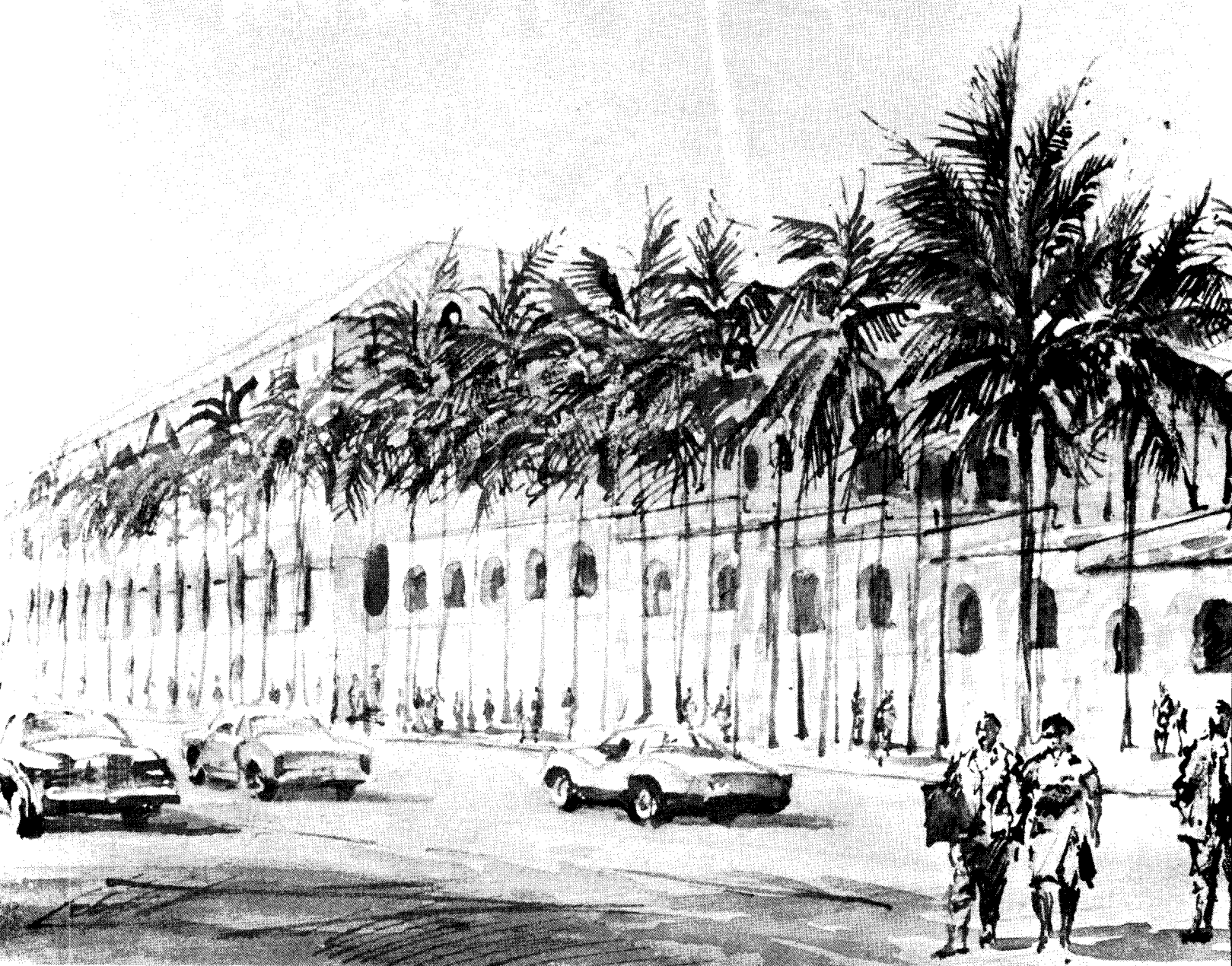

### Dade County Cultural Center, Miami

Designed to occupy a block long section of Miami's Government Center, the Johnson/Burgee project (with associate architects Connell, Metcalf & Eddy) will house two museums, a library, a restaurant and other support facilities. All will be elevated by a broad and unifying pedestrian plaza. If built as designed, the complex will be executed in coral stone and roofed in half barrel clay tile of a reddish-brown hue. Arched openings for shaded porticos and small, "punched out" windows are a response to the climate and the familiar historic buildings of the region.

The design now awaits the approval of local authority.

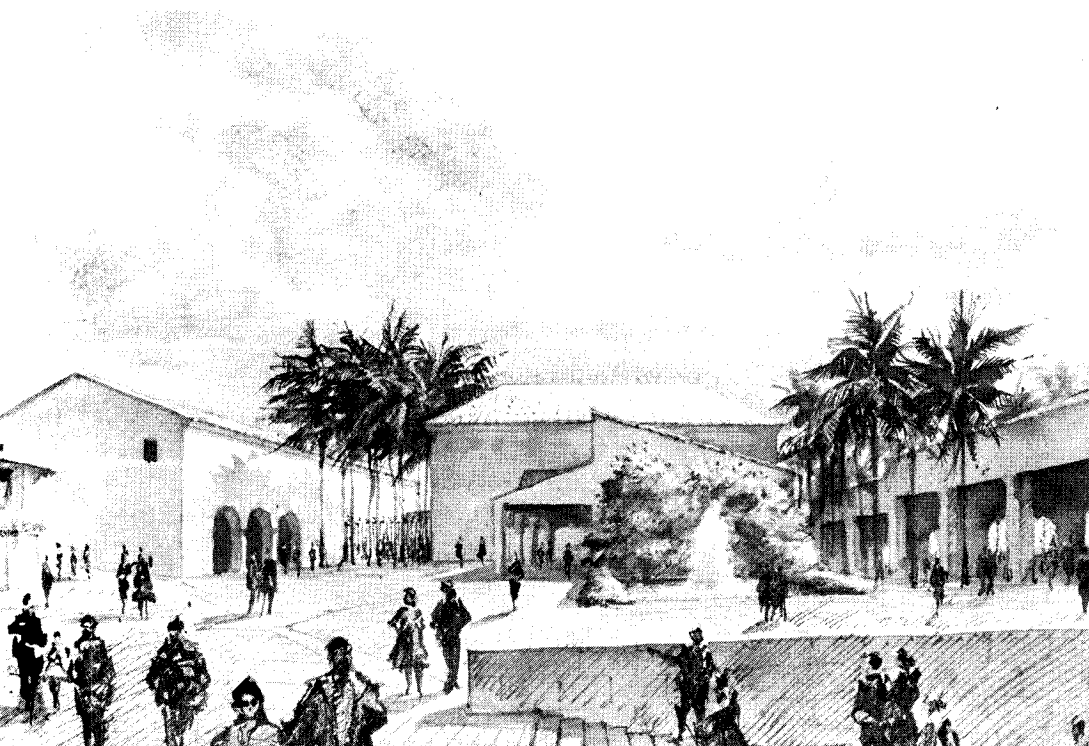

“From the 19th Century  
we didn’t pick arches,  
we didn’t pick pediments,  
we left out porticos entirely”

Moore’s influence has been very strong. I mean the growing feeling everywhere of ‘Aw shucks, let’s build something simple using local materials and local images.’ This delight in inexpensive buildings, unpretentious buildings, has eroded the base of the International Style.”

#### Another is a broader sense of history

As a by-product of our growing interest in both preservation and symbol, argues Johnson, we can look back today and reevaluate (and reappraise) much of what was discarded earlier. “From the 19th century, you see, we picked things that would give us proto-Modern. We picked the Crystal Palace, we picked late Richardson. We didn’t pick arches, we didn’t pick pediments, we left out porticos entirely . . . In today’s point of view, the two greatest architects of that century are Gaudí and Luytens. But from our point of view in the late 1920s, it was Richardson, Bonatz or Boullée. The 19th century, though, as a rich lode of Norman Shaw picturesqueness or of neo-Greek development? Why, we just ignored it entirely. Today we have a different appreciation of 19th century design. We enjoy its mannerism, its picturesqueness, its vision of an imperial architecture—as at Delhi.

#### The reappraisal of the past —especially

some elements of the past ignored by  
ardent modernists—  
finds expression

#### in Johnson/Burgée’s latest designs

“At AT&T, the shaft of the building is symmetrized Raymond Hood: the gathering of columns, the play of shadows, the recessed windows. The bay spacing is on a Renaissance model: 50 feet to 20 feet to 17 feet. At street level, 60 per cent of the space is open—and leaving it open is wonderful. Look at those closed mall solutions where you open the door and go through. Nobody there! The top? Oh, that’s just a recognition cap. People say it looks like a Chippendale something-or-other, but that never occurred to us when we were designing it. To us it is reminiscent only of Hellenistic or Roman design features . . .

“And in the design for Dade County, people down there said it was Mediterranean or Spanish. ‘We’re the fastest growing city in the United States, they said, We’re not Spanish, we’re Anglos.’ Well, the coral stone and red tile roofs we are proposing are fine for a warm climate. I don’t call it a Style. To me it’s not related to anything except vaguely Renaissance, vaguely Tuscan farmhouse . . . Actually I got it from Ludwig Persius who, like all 19th Century Germans, went on the Grand Tour. It’s not really Mediterranean, or Spanish. How can you give a name to something that has been used so ubiquitously and for so long? It’s just a tradition and the fact that it’s neo is all right.

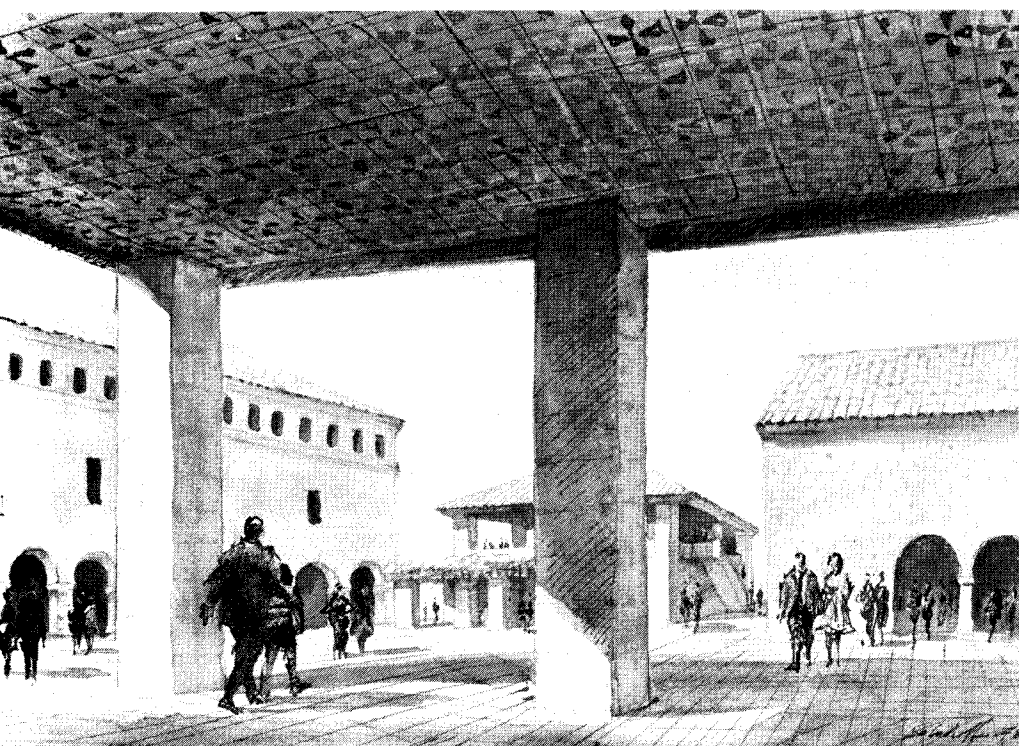
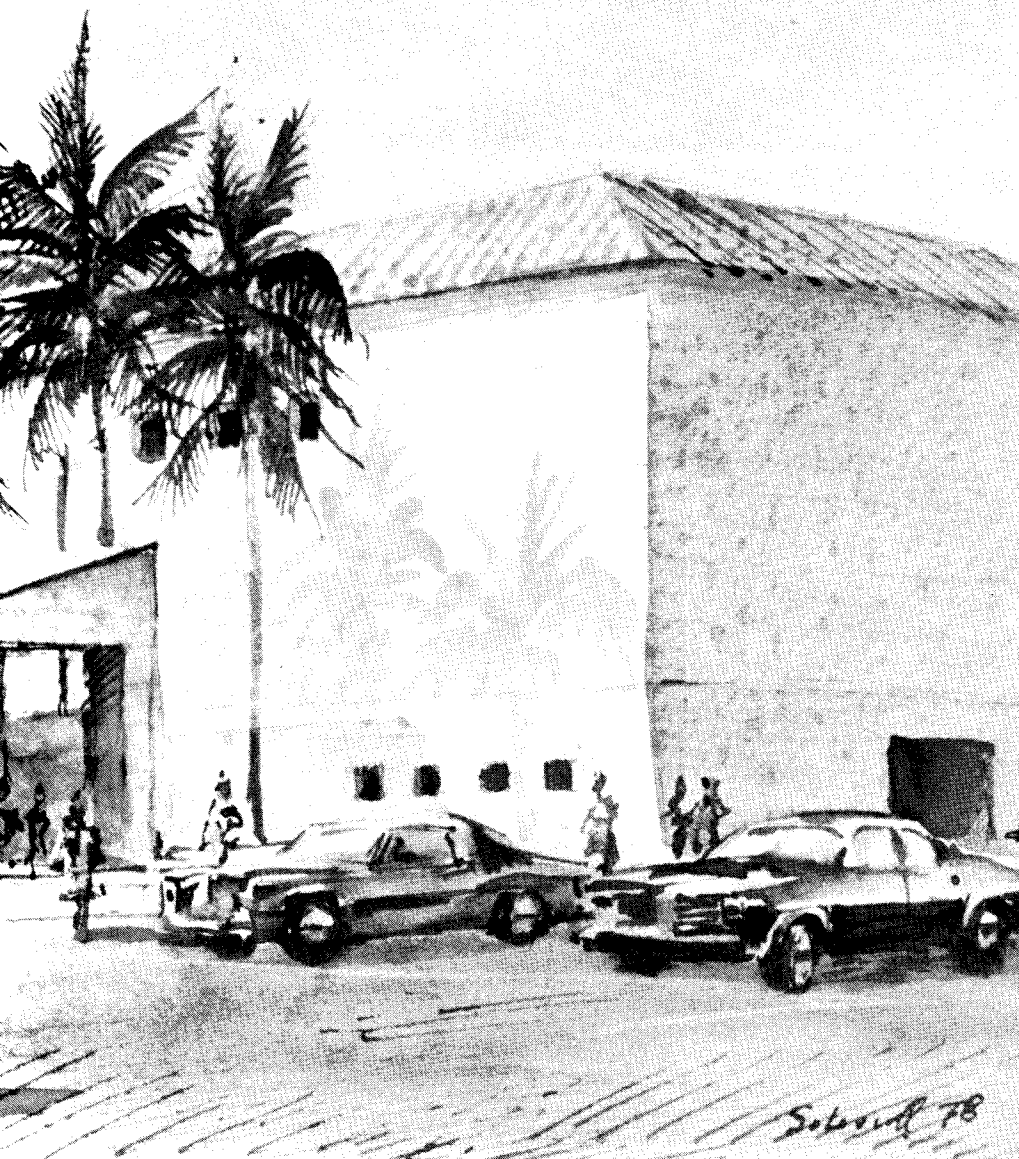

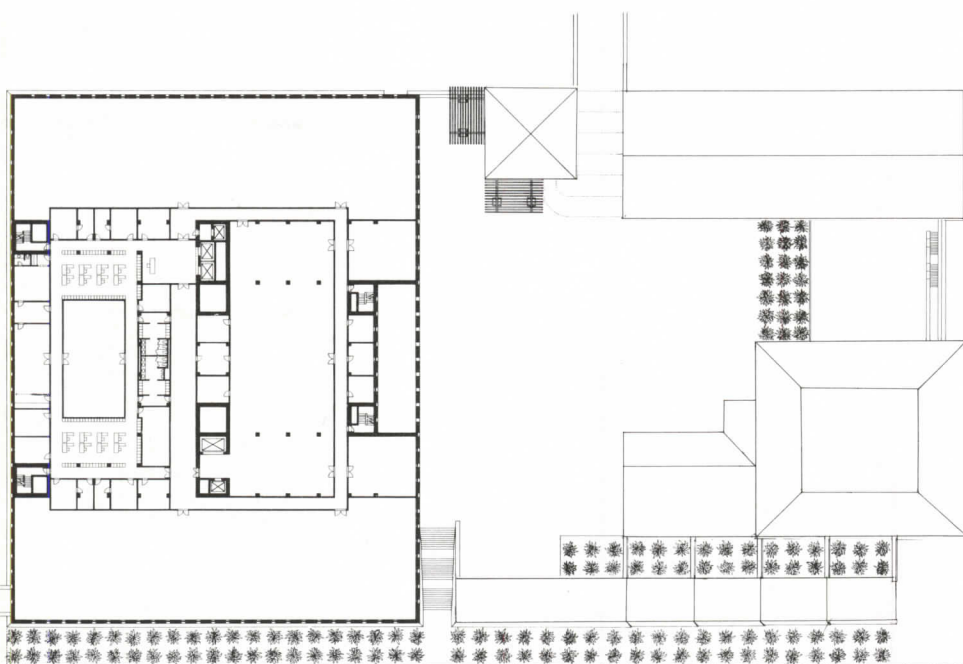
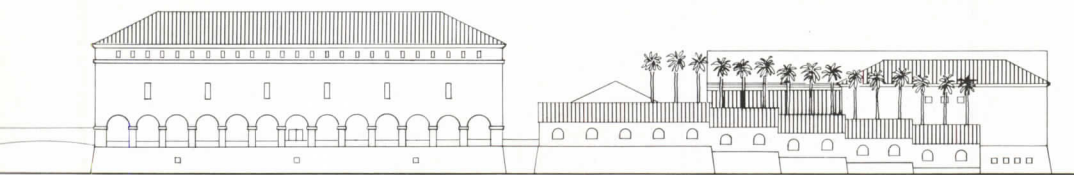

THIRD LEVEL

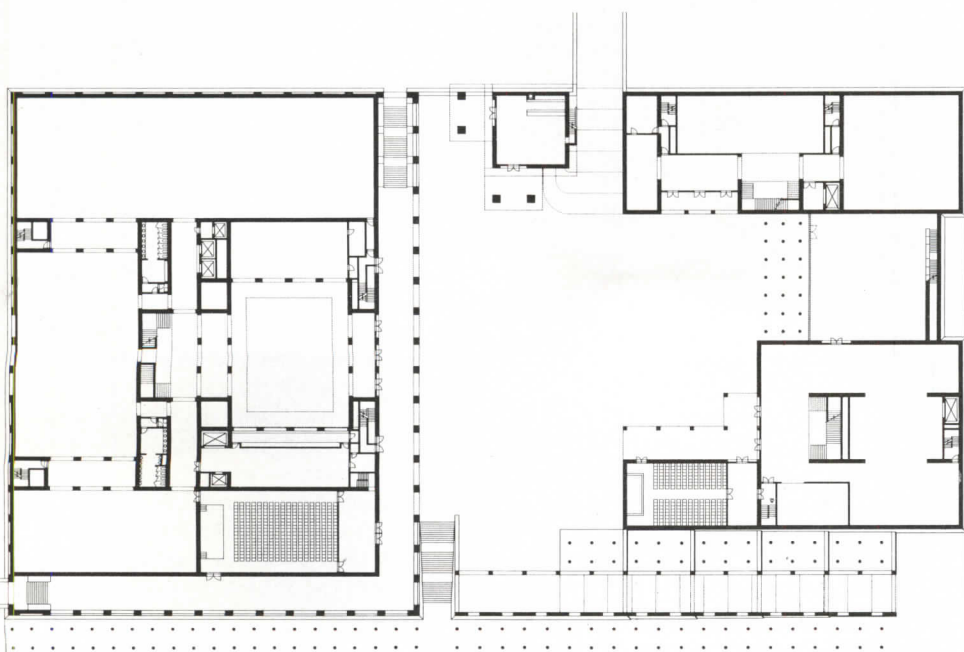

PLAZA LEVEL

“If you can’t do something just because you want to do it, then we’ve all been hemmed in too much”

“We wanted a compact solution in the downtown area for trees, for shade, and pedestrians. You can’t build basementless libraries and museums so we raised everything on a plaza. I think the important point here is that we see contemporary problems and contemporary solutions . . . I can’t stop being a modern architect or become a non-functionalist. I still start with the plan . . . I believe, though, that it’s fitting to build extreme examples of elbow-pushing glass towers one place and Mediterranean or Spanish or whatever you call it somewhere else.

“Divergence is the rule in architecture, not the exception. If you could have said to the Nineteenth Century designers: Sometime in the next century there will be a 50-year period when all the architects wear blinders and are as strict in their application as the Gothic period was, why, they wouldn’t have believed you. Remember, if you didn’t wear Gothic in those days, you weren’t much of a building and nobody would look at you.”

Johnson’s central point, and he comes back to it again, is that none of these features of his new work is revolutionary. “Johnson isn’t post-anything,” he says. “It’s a perfectly normal development. The river has split apart into number of streams and architects are free to follow any stream they wish.

“No one rejoices more than I do in this new era of plentitude. The International Style still goes with the buildings that it’s good for. But to have no choice—to make it a nothing-else-than—is to narrow your palette to such a degree that you cut off your nose to spite your face. Why give up richness? . . . What’s the opportunity? What’s the setting? To build among the new, asparagus towers of Houston in anything *but* geometricized glass would seem out of place to me . . . But I also built my glass house in the middle of a neo-Colonial town. It never occurred to me then to look at the neo-Colonial of the village and try to work with it. I certainly would now.”

**Asked if any of these streams might rejoin to form a river again, he shrugs:**

“If something happens in our philosophy of life such as happened in the Twenties—that is a great belief in progress, in goodness, in the ability of architecture to conquer all—then of course architecture can channelize into a river of fearful strength once again . . . But will it happen again? I don’t know. I don’t think any of us are prophet enough. I think we should just enjoy the freedom and the variety we now have . . . One change that is very important is *homo ludens*, the fact that man can play again, that man can laugh. I mean that’s why I’m not at all bothered by the Chippendale jibes. If you can’t do something just because you want to do it, then we’ve all been hemmed in much too much.”



# DESIGN FOR READERS

The three different architectural firms who designed each of these libraries strove to reach the same design goals and as a result, all three buildings share the same good qualities, although they differ significantly in size and purpose. The smallest—a branch public library for a Cambridge, Massachusetts neighborhood—is 19,000 square feet. In between—30,000 square feet—is the main public library of a Florida resort town. The big one (below) is a 97,250-square-foot addition to the main library of Williams College in New England. Each library was shaped by the scale, materials and landscape of its surroundings. Further, in every case the architects subdivided the interior spaces into small comfortable seating areas with easy access to the stacks. They avoided repetitiveness and monotony in these reading areas by varying sizes, shapes, ceiling heights, fenestration and furniture arrangements. Most importantly, each library was designed to save energy—notably the library at Williams which takes advantage of its mountain climate to depend entirely upon natural ventilation for cooling.—*Mildred F. Schmertz*

*Jim Hedrich, Hedrich-Blessing*



**An understated red brick library designed to fit into a lovely red brick New England campus, and to conserve energy by natural ventilation like the old buildings it adjoins**

The new Sawyer Library at Williams College in Williamstown, Massachusetts is connected by an underground tunnel to the older campus library. It is centered on the east-west and north-south axes of the campus and is free-standing—adding four elegantly proportioned facades to the surrounding campus landscape. Because the entrances from both east and west are of equal importance, the architects, Harry Weese & Associates, devised a ramp-down east-west concourse (section below) with one public stair leading to the control desk on the second floor. Thus the scheme provides two means of access, but one control point.

The width of the structure was deter-

mined by the width of the older library. As the section indicates, there are three stories above the concourse and a basement below. The two upper levels are a combination of open stacks and reading stations arranged around two hollow open courts, for light and air. The basic structural module is a 22-foot-square bay, an easy span which accepts 3-foot-long stack modules which about 1-foot-square columns.

The low horizontal fenestration on the north facade (left middle) and south facade (left bottom and opposite page) of the third and fourth floors relates to the student stations arranged along the walls, providing each student with a view from a seated position.

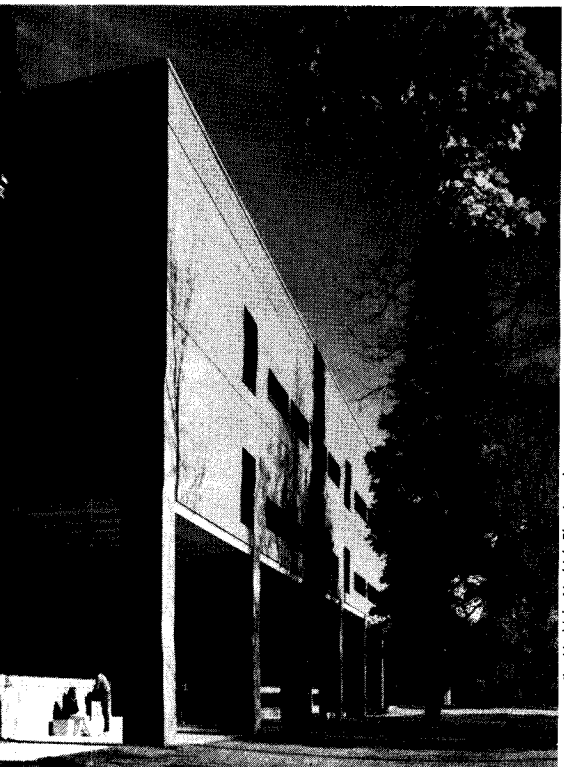
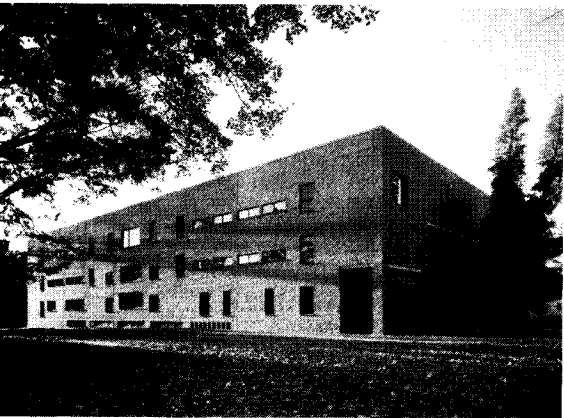
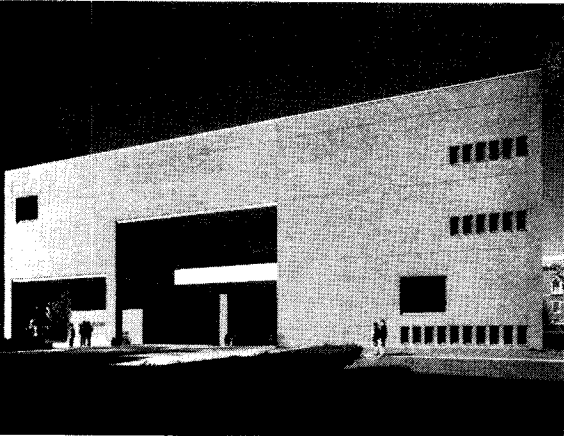

*Jim Hedrich, Hedrich-Blessing photos*

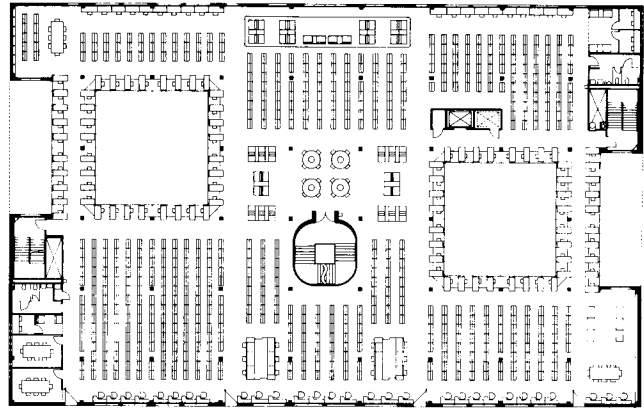

THIRD FLOOR

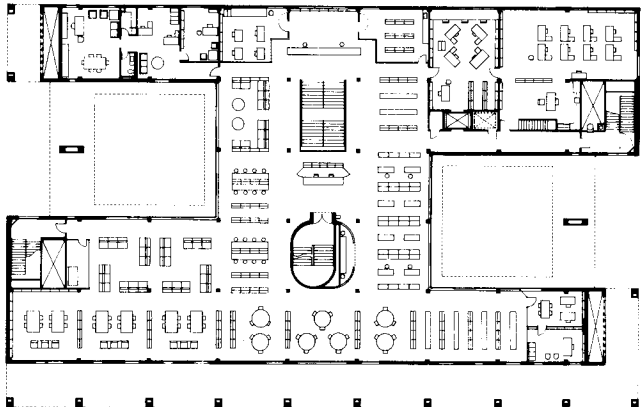

SECOND FLOOR

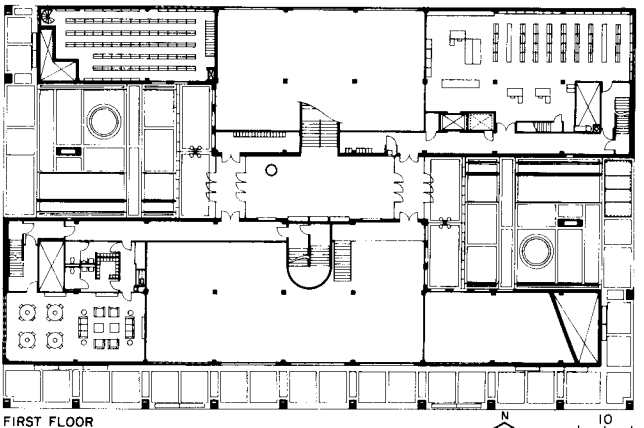

FIRST FLOOR

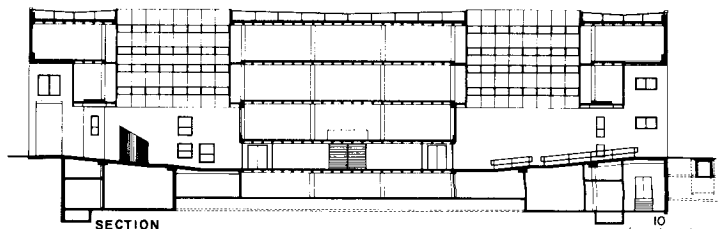

SECTION



Because the campus is located at one of the higher elevations in the Berkshire Mountains, it enjoys cool breezes even in the summer months. The Weese team—headed by Ben Weese, the partner-in-charge—planned a naturally ventilated, non-air-conditioned building. The floor plan of this 489,500-volume library therefore provides a large perimeter of windows with moveable sash on the north and south facades and surrounding the two courtyards framed by the building.

The building was designed for low energy input: a simple peripheral fin-tube hot water system and cold air ventilation through an exposed duct system. The latter can be turned

off when the windows are opened. The building was designed with a double roof (serving the traditional attic function), which has an exhaust fan system to pull off hot summer air.

Light levels throughout the building are low. As can be seen in the photos (opposite page) there are individual task-level lights at the reading stations. To compensate for the low lighting level, a feeling of brightness was achieved by very light decor—white ceilings and ducts, light beige stacks, light grey carpet and bleached ash wood trim.

The area of the building is 97,250 square feet constructed at a total cost of 4.8 million dollars including equipment and furnishings.

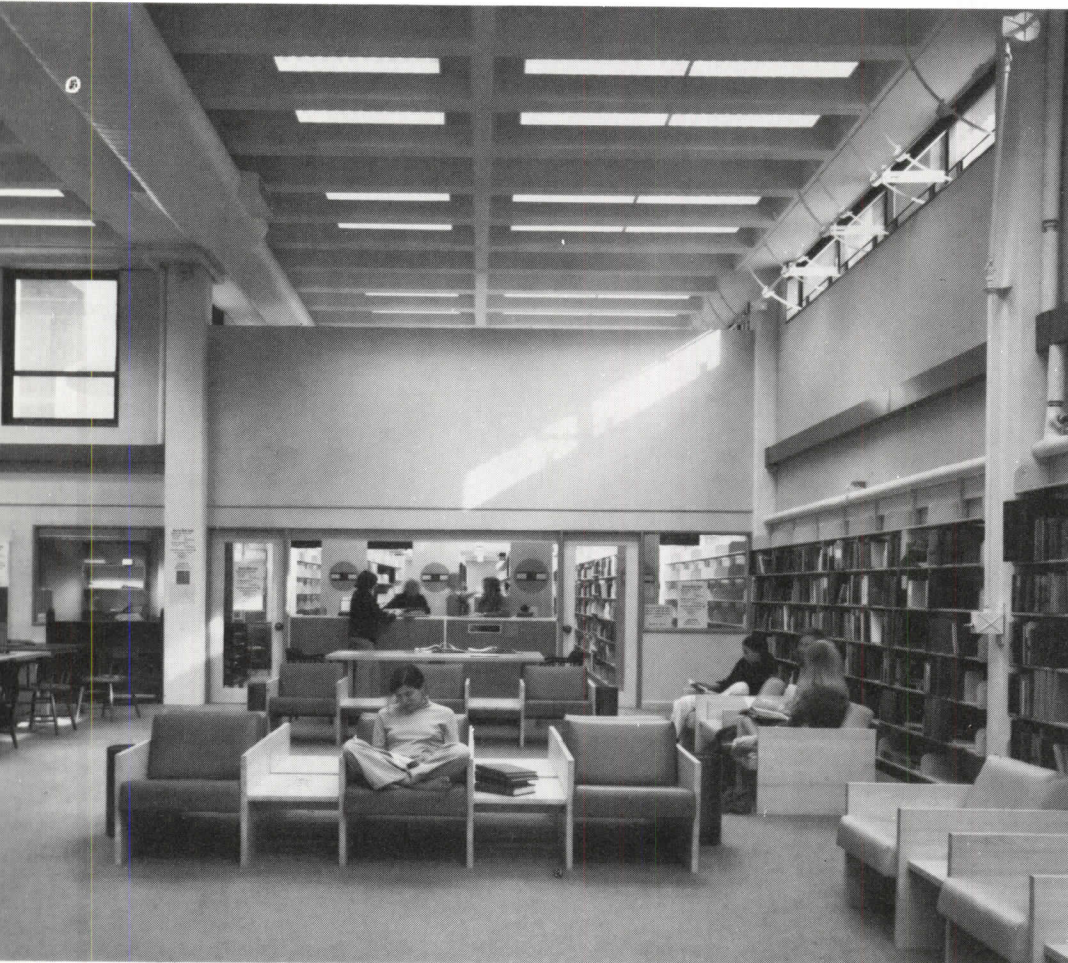

The faculty committee, which assisted in the programming of the library, called for a variety of study and seating configurations within a total seating capacity of 836. New ways of varying the study milieu include the over-under interlocking carrel (opposite page top left).

SAWYER LIBRARY, Williams College, Williamstown, Massachusetts. Architects: *Harry Weese and Associates*—partner-in-charge: *Ben Weese*; project manager: *Carl Klimek*. Consultants: *Severud-Perrone-Sturm-Bandel* (structural); *Consentini and Associates* (mechanical and electrical); *Joseph Karr* (landscape); *Richard Pearce* (costs). General contractor: *Dwight Building Co.*

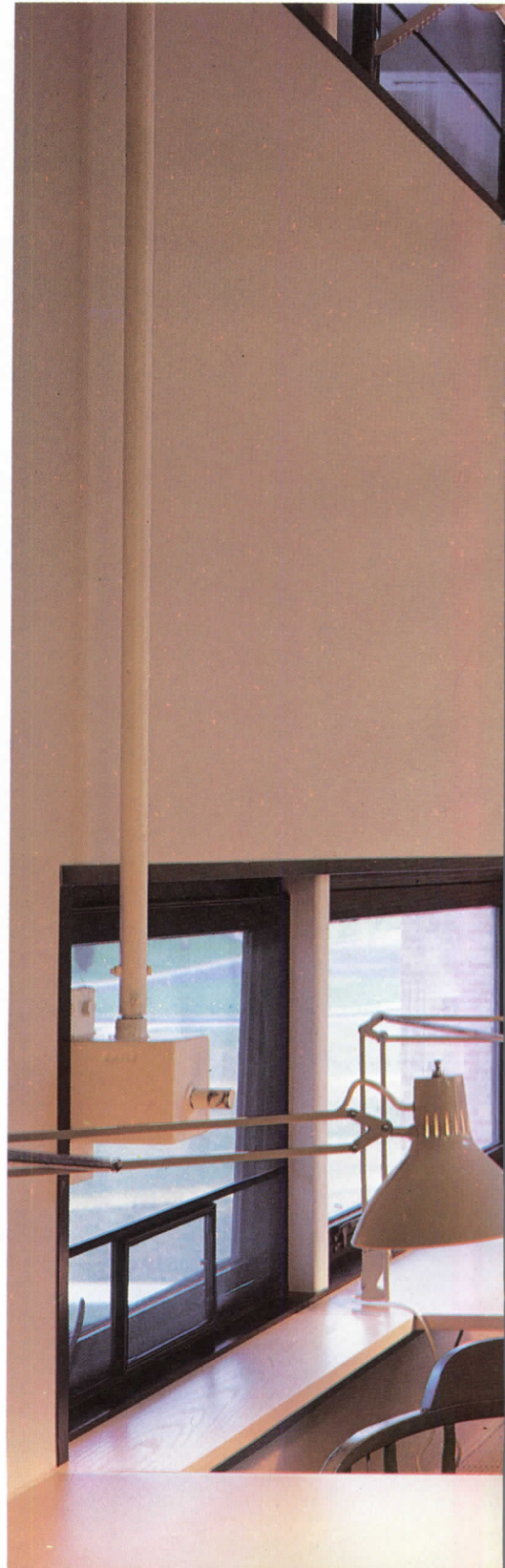



# A small library designed to create a focus and give a sense of place to an old Cambridge neighborhood

This small (19,000 square feet) branch library in Cambridge, Massachusetts was programmed by Monacelli Associates as part of a mixed-use complex master-planned by the firm. This neighborhood development contains 204 housing units for the elderly, offices for the Cambridge Housing Authority, a clinic and community meeting hall, a 10,000-square-foot urban park and a 300-car municipal parking garage. Located in an area which has been in dire need of community services and library facilities, it wasn't until funding for elderly housing and municipal parking became available that such neighborhood services could be realized. The library and the parking structure were

designed by Monacelli Associates and the elderly housing (at right of photo below) by Robert Charles Associates.

The library creates a focus and a sense of place within the residential community. Designed for 40,000 books at a cost of \$654,000 it is organized on three levels. At the ground floor level a pedestrian path connects the entrance from the courtyard to the opposite entrance from the bus stop. Opposite the circulation desk is the periodical and paperback section (opposite page bottom). Two and one-half stories high, it is lit by a skylight. The children's library projects into this multi-story space.

Nick Wheeler photos

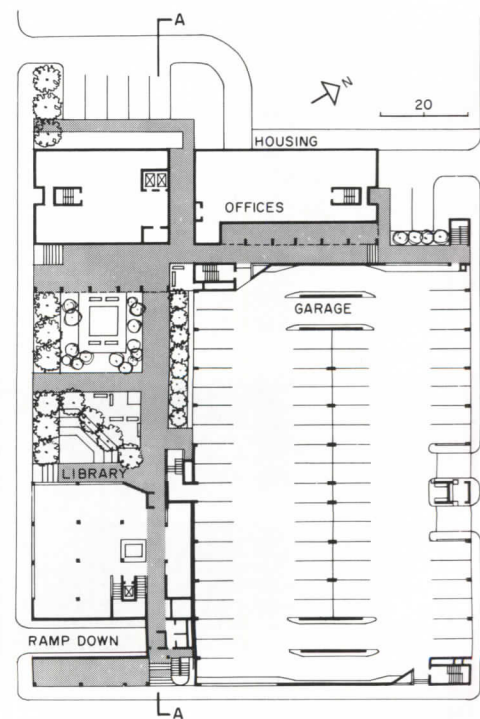
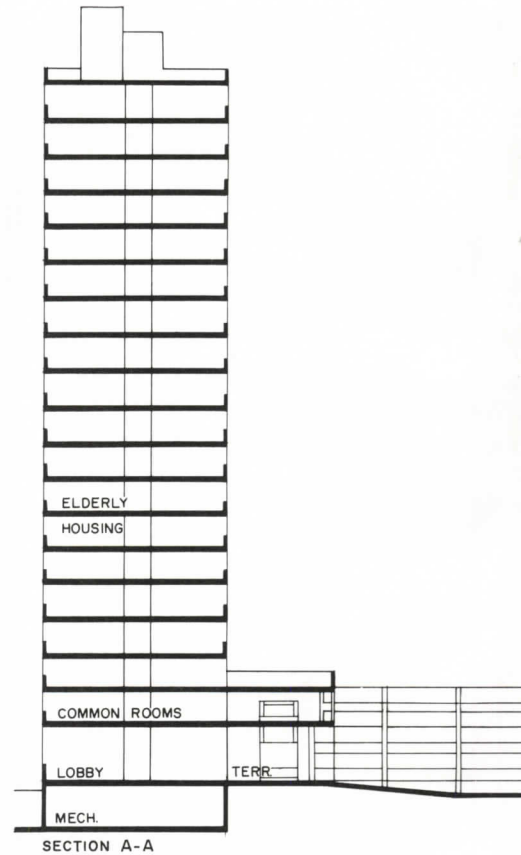

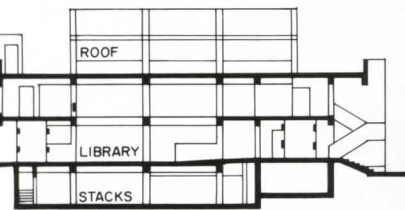
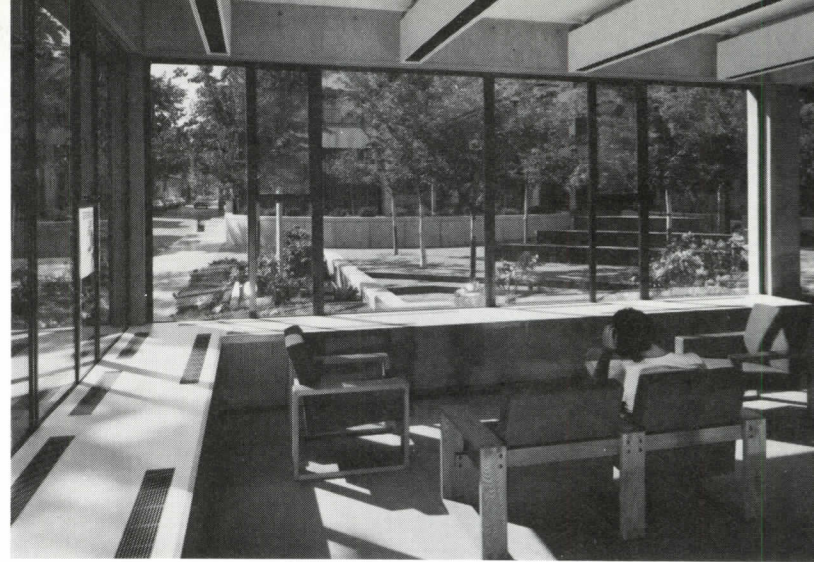
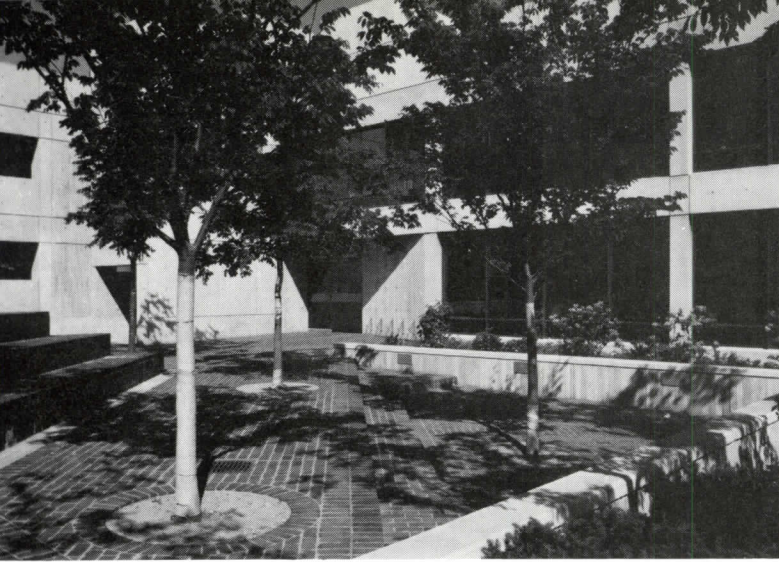

The landscaped courtyard (top left) is well used by the elderly, children, and the rest of the community. It forms an attractive entrance to the library, and enhances the view from the general reading area (top right). The garage (above) is in residential scale as can be seen to the left of the photo.

CAMBRIDGE PUBLIC LIBRARY, CENTRAL SQUARE BRANCH, Cambridge, Massachusetts. Architects: *Monacelli Associates—principal-in-charge: Theodore A. Monacelli; job captain: Robert Heineman.* Consultants: *Souza and True, Inc. (structural); Shooshian Engineering, Inc. (mechanical, electrical and lighting); Bolt, Beranek & Newman, Inc. (acoustics); Hodgdon Design Group, Inc. (interior design); John Wacker & Associates (landscape); Charles B. Solomon (costs).* General contractor: *Northgate Construction Co.*



## A handsome library in a resort town designed to lure the sun-loving public indoors

Overlooking the town's civic center and Sarasota Bay, the Selby Public Library makes the most of its views. SOM partner-in-charge Walter A. Netsch has also endeavored to bring an intimate "living room" scale to all the reader areas. The reading spaces are close to the open stacks and there are many different seating arrangements. In addition to the open stack and reader areas, the 30,000-square-foot, 200,000-volume, 150-carrel library also comprises an outdoor reading area, children's area, special collections and adult learning spaces. Also included are an audio-video center, a space for visually handicapped readers, staff offices, conference rooms and a community

meeting room, which can function while the rest of the building is closed.

Netsch's energy-conserving design incorporates shaded glass areas, light-reflective exterior surfaces, efficient fixture design, individual task light, area light-switching capabilities, and zoned packaged air conditioning units.

In plan the library is made up of ingeniously interlocked hexagonals within a square grid. In the roof plan the hexagonals are divided into triangular and trapezoidal planes each with its own pitch. The tilting planes create a very handsome roof silhouette and add to the interest of the interior spaces. The roof is surfaced in white tile. The walls are of white stucco.

*Jim Hedrich, Hedrich-Blessing photos*

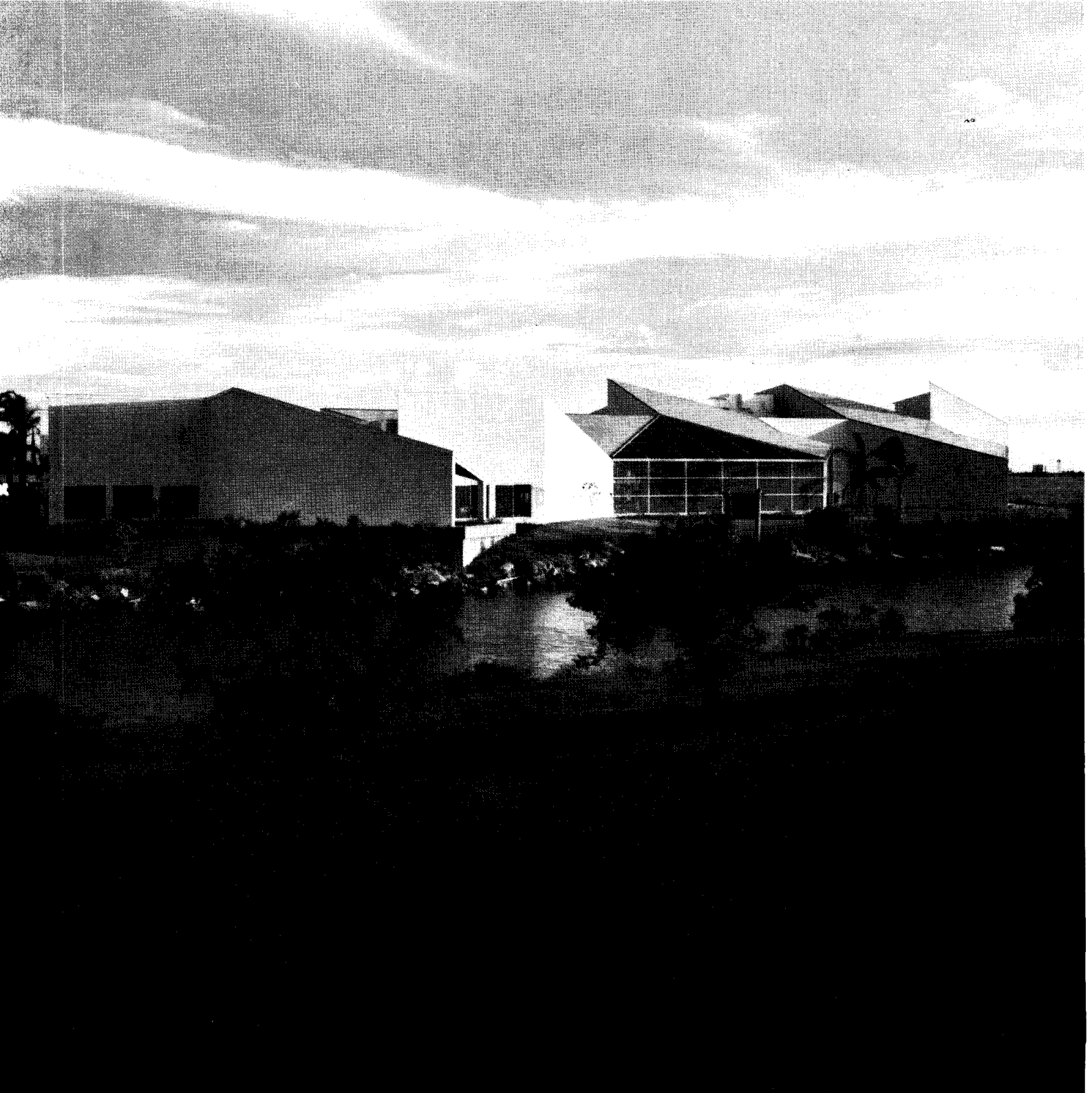



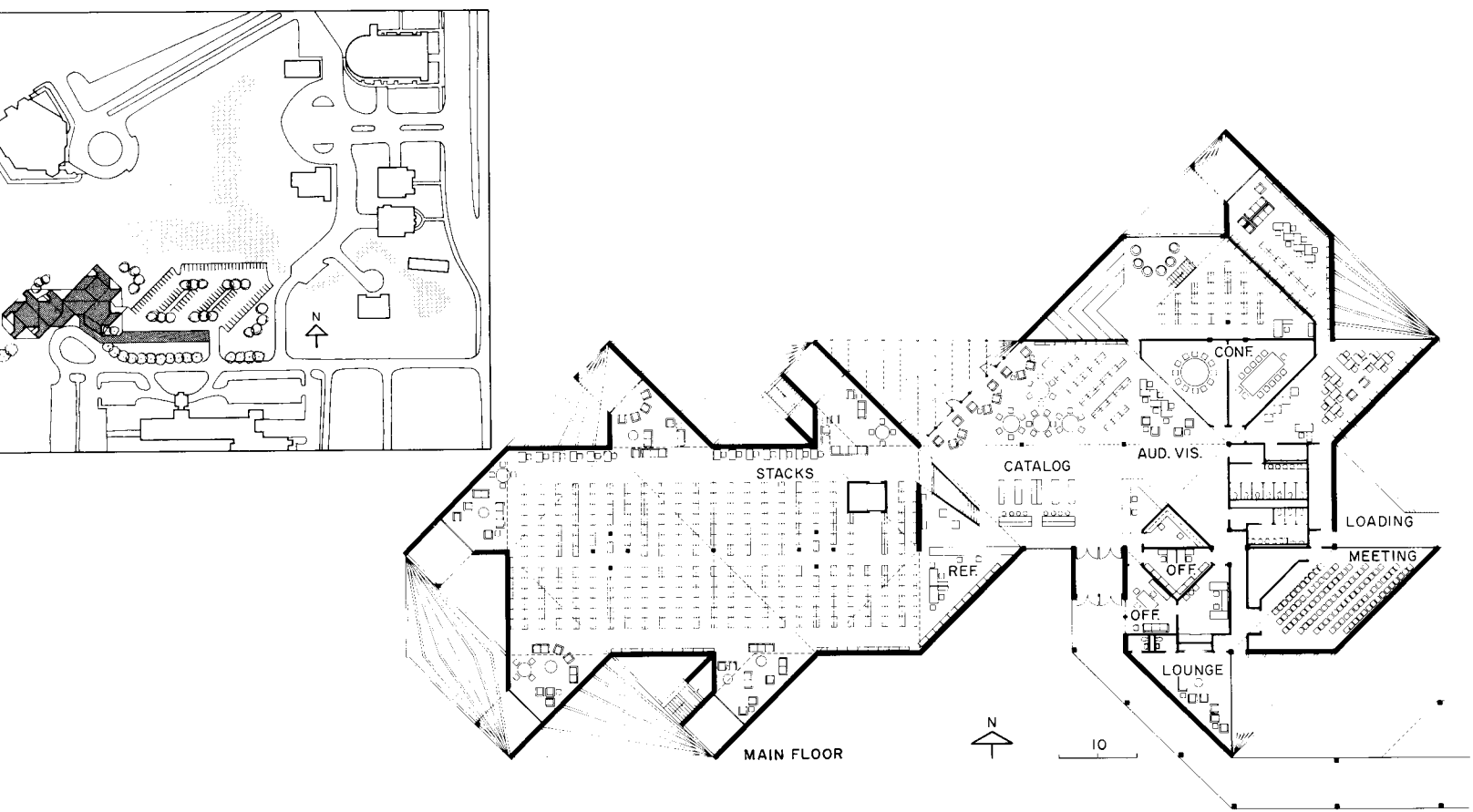
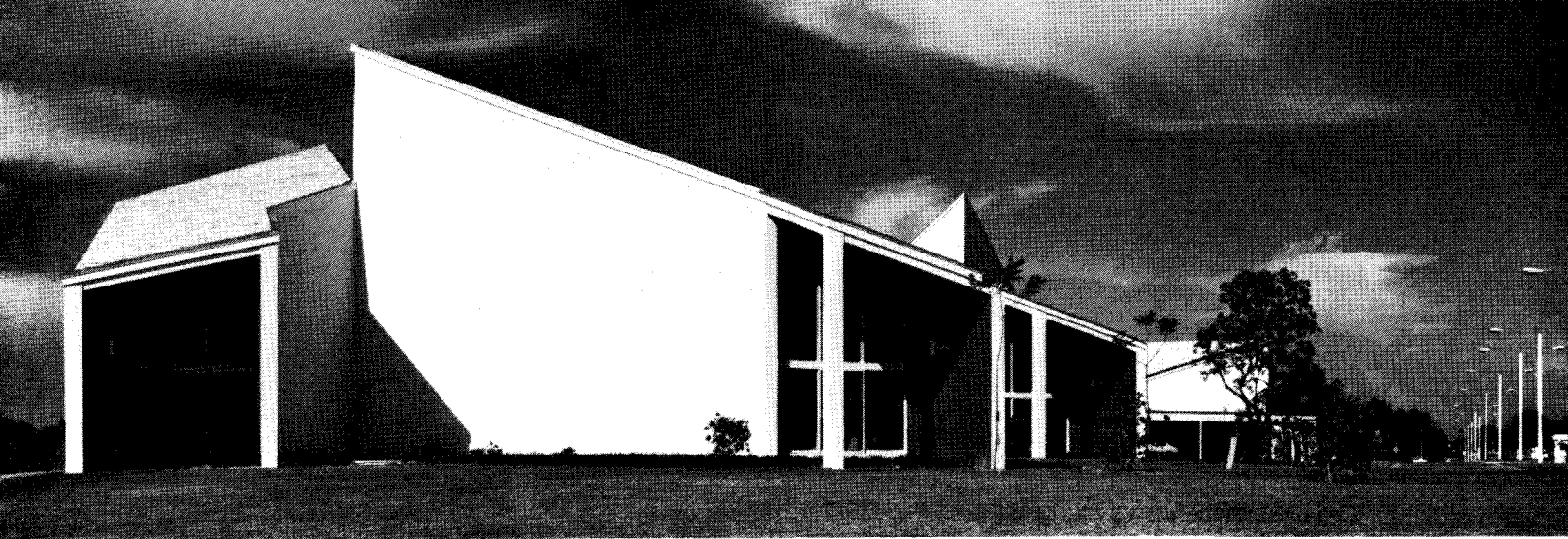

The somewhat unorthodox organization of the plan in this house stems from a strong desire to preserve and make the most of the natural site, to distinctly zone the activities within, and to explore some esthetic ploys—all mixed with dollops of drama and whimsey.

The site has a wilderness quality, with the land rising gradually from a road through a grove of pine trees, topping with a large rock outcrop, then dropping steeply to grassy wetlands and Long Island Sound. Each of the features has not only been preserved but—in effect—incorporated in the design. The stand of pines, along with minimal glass on the west facade, helps screen the house from the road; with its natural redwood siding, the house can barely be seen in summer. By contrast, big glass

areas range the elongated plan on the east facade (photo below) to allow a constantly changing view of the sound.

Use of the rock ledge led to one of the more striking concepts in the house, dubbed by the Woolners as their "Mainland." It is an oval-shaped informal living zone on top of the hill, and is connected by a glassed-in bridge over the rocks to the "Island" or formal living area at the base of the hill. The rock ledge has been visually incorporated into these living spaces and appears from the interior to be part of the house. The whole effect is further dramatized by the great change in scale of the formal living area: as one leaves the bridge and moves down a broad stair, the ceiling soars up on a 45 degree angle, then curves down to the

dropped floor level (photos right).

The openness of the main floor gives the house a great sense of spaciousness; this continues into the informal living zone, where curving work counters separate the kitchen from dining and family areas, and stairs curve up to the bedrooms and roof terrace. The interplay of all these strong forms—which are clearly visible from within and without the house and artfully linked by the circulation system—gives the design an unusual vitality and sculptural strength.

PRIVATE RESIDENCE, Darien, Connecticut. Architects: *Anthony D. Woolner and Anne K. Woolner*. Engineers: *Geiger-Berger Associates (structural/mechanical)*. Contractor: *T. deF. Hobbs, Inc.*



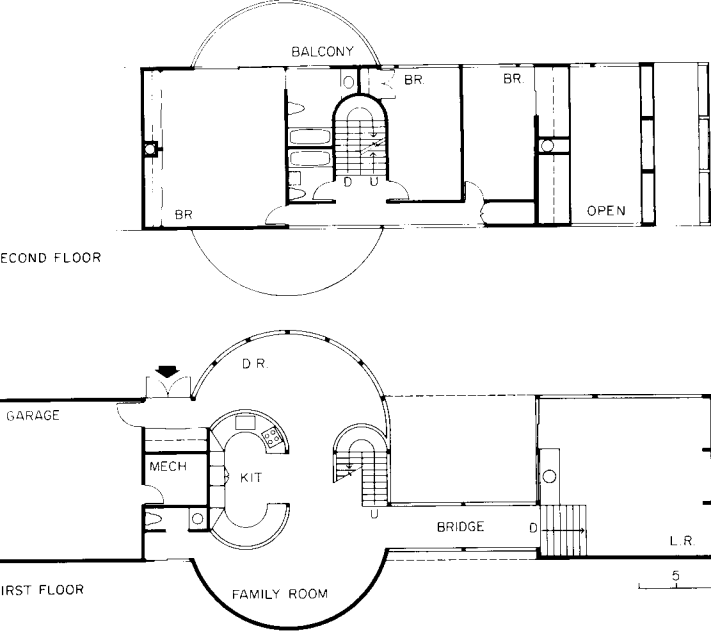

Even with all the strong shapes in the house, the structure is relatively simple and straightforward: concrete block foundation and wood framing with laminated arches and beams. The exterior is surfaced with redwood tongue-and-groove siding given a waterproof finish; exposed structural members are stained white for clear expression. Interior walls and ceilings are white-painted wall-board, and white oak strip flooring is used throughout.

On the east facade of the house (photo left), the three separate glass forms of the dining area, bridge and living area are unified by the mass of the bedrooms on the second floor. Outdoor living areas are provided by a balcony and a roof deck.



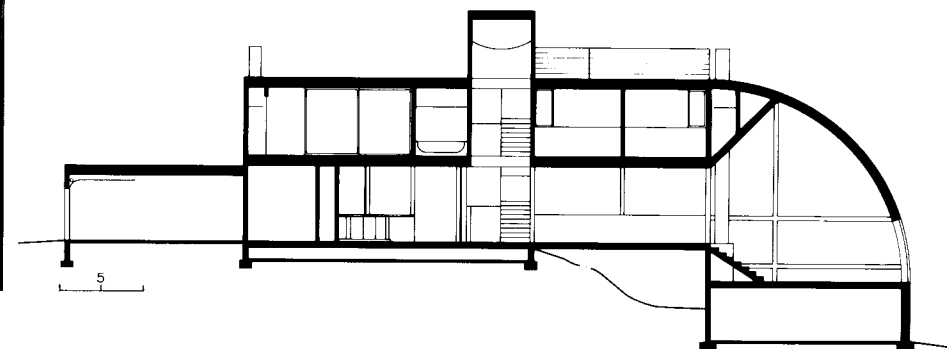
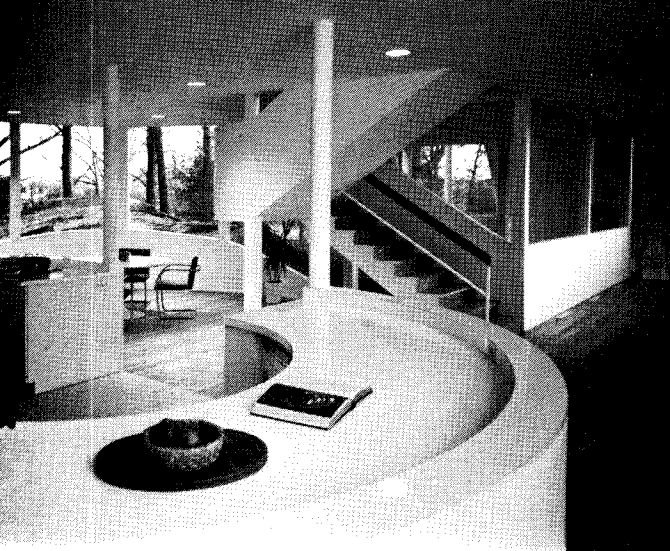

The openness and spaciousness of all the living areas are clearly seen in the photos shown here; a minimum of carefully chosen furniture and plants augments the effect. The oval plan of the informal living zone is completed by an area designed as the "family room" (not shown), which has a solid curved wall for privacy from the nearby road, and to contrast with the openness of the dining area. The open kitchen which separates the two areas can be seen in the photo at upper left.

# SPARKLING SHOWCASE FOR FLUOR CORPORATION

The new offices for Fluor Corporation (an international firm that designs and constructs process plants for petrochemical and related industries) were designed with an energy consciousness that fully integrated engineering and architectural aspects—providing a showcase for the client. Architects Welton Becket Associates designed two structures, both of reflective glass and complementary to each other—one, the offices for Southern California Division of Fluor, and the other, the new corporate headquarters. The Fluor Engineers & Constructors, Southern California Division building consolidated seven offices in the area, while the headquarters building centralized Fluor's world-wide corporate functions. Located on 105 acres in the Irvine, California, industrial park, 35 miles south of Los Angeles, the complex is extremely attractive—almost crystalline in appearance as its highly reflective facade reflects the lushly landscaped site.

*Grant Tucker photos except as noted*



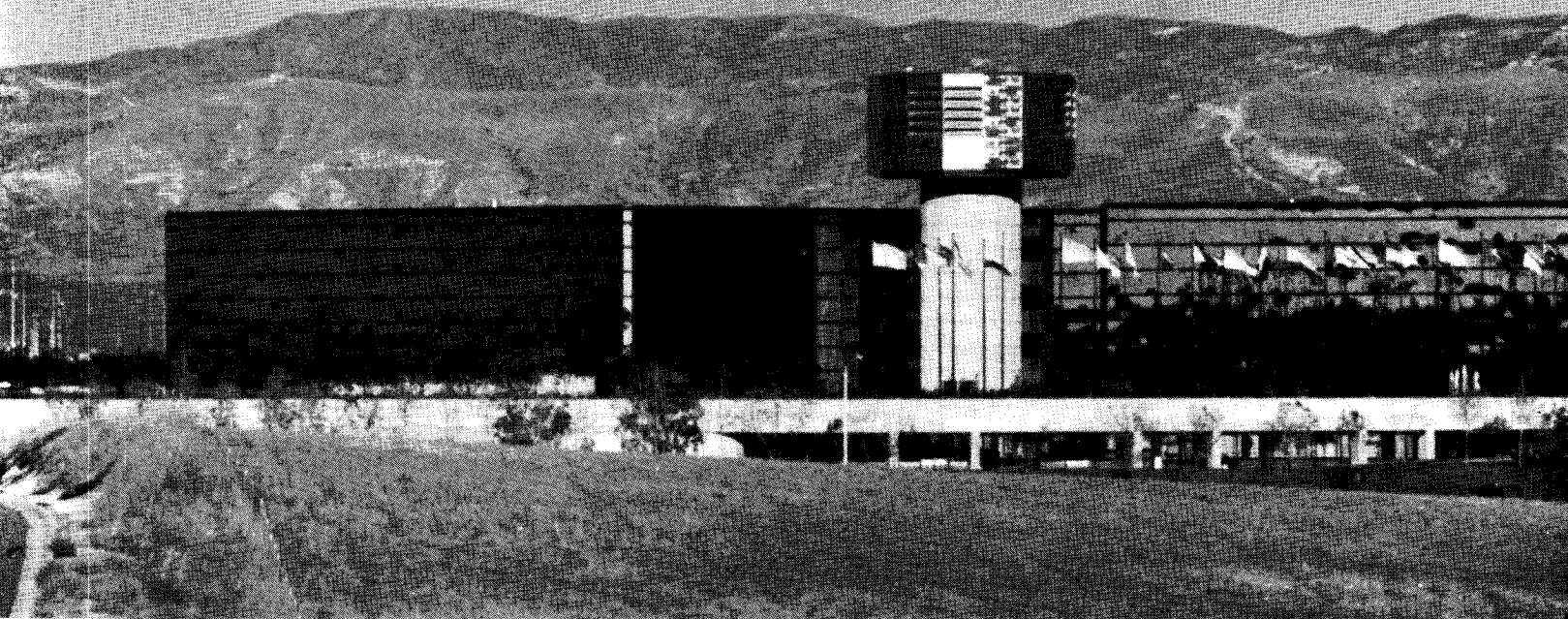

Julius Shulman

The 10-story, 260,000-square-foot headquarters building (right), also wrapped in reflective glass like the Southern California Division building (above), is octagonal in form, with the first eight floors notched-out, establishing visually a relationship between it and the SCD building.

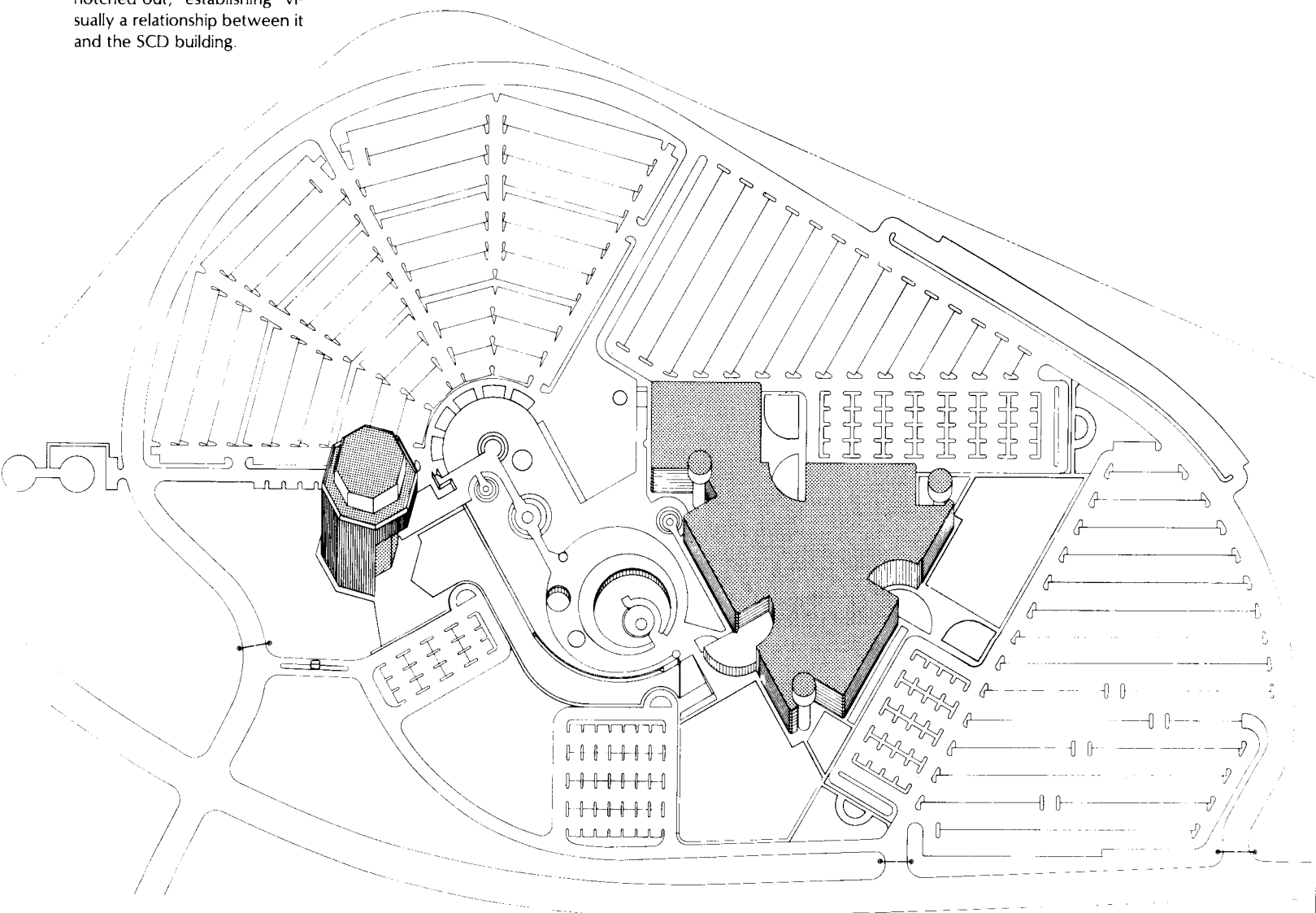

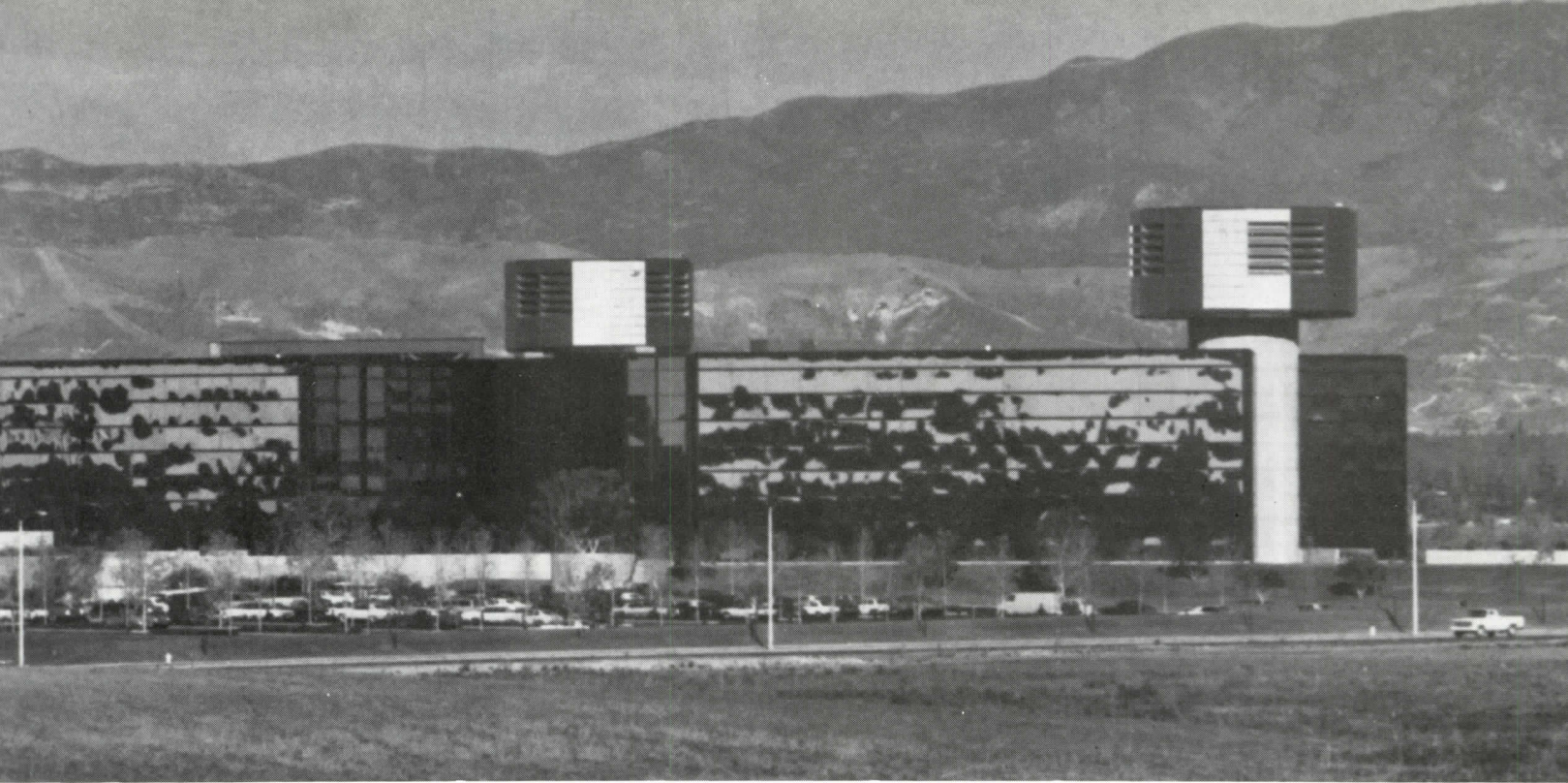

The two new Fluor buildings face each other across a large, sculpted concourse (photos right). The Southern California Division building (above) is the larger of the two and the first completed, providing 1.3 million square feet. The structure is basically triangular, but composed of four rectilinear sections, called "pods" by the architects, to facilitate the client's task force approach to engineering.

An important visual element, but one equally important in function, are three mechanical towers, each set into a niche in the building's facade (bottom right). Each tower is 93 feet high and its mushroom shape directly reflects its function: stairs are located in the shaft and variable-volume fans and cooling equipment in the head. Isolating towers in this manner (as earlier described in *RECORD*, mid-August 1977, pages 76-77) worked advanta-

geously, separating noise and vibrations from the main portion of the building and eliminating clutter on the roofline. The towers also allow flexibility in future building expansion, as each tower at maximum capacity can serve two pods. One tower is used this way now.

The prime factor in the building's energy conservancy is that there is no central heating plant or boiler, but variable volume fans control the quantity of cold air circulated in the office space. Heat for the entire building is furnished from a combination of electric heating panels (along the perimeter of the building and operated by computer on rare cold days), fluorescent lighting and body heat. Reflective glass obviously reduces the heat load on the building, but single-glazing was judged adequate due to the mild climate. Fifty per cent of the facade is vision glass, the rest insulated.



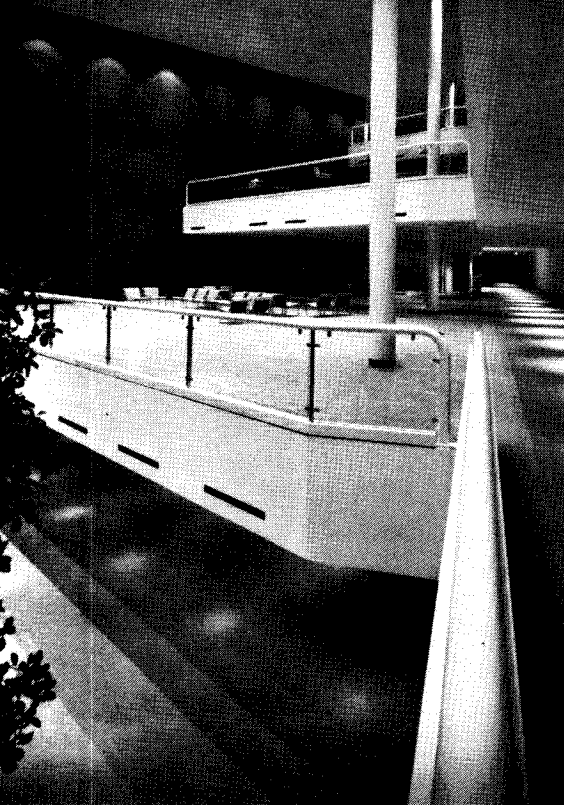

Julius Shulman



Julius Shulman

The interiors of the two structures are quite different, but both are strong and attractive. The architects designed a gloriously light-filled entrance and lobby (right) that looks out over the concourse. Overlooking the lobby are a series of balconies (above left) where large working models of industrial facilities designed by Fluor are often displayed. To accommodate office space for nearly 5,000 persons expandible to 7,000 the office was open-planned with easily movable partitions separating work stations. The environment is brightened by orange, red and burgundy colors and the expansive views of the countryside remain open to all. Few fully enclosed offices exist, but when necessary are positioned away from the exterior wall. One of the most successful interior spaces is the cafeteria (above center), located below the concourse.

CORPORATE HEADQUARTERS FOR FLUOR CORPORATION AND OFFICE BUILDING FOR FLUOR ENGINEERS & CONSTRUCTORS, SOUTHERN CALIFORNIA DIVISION, Irvine, California. Owner: Fluor Corporation. Architects: Welton Becket Associates—Alan Rosen, director of Los Angeles office and coordinating architect; John Parr, project director (Southern California Division building); James Taylor, project director (headquarters); Karl Schwerdtfeger, project designer; Eli Even-Zohar, project captain; Edison Crayne, space planner; Randall J. Myers, interior designer; Noel Davies, graphics designer. Engineers: Brandow and Johnston Associates (structural); James A. Knowles and Associates (mechanical); Brad Karr of Welton Becket Associates (electrical); Shuiman Rogaway & Associates (civil). Landscape architects: Fong Jung Nakaba (Southern California Division building); Fong Jung & LaRocca (headquarters). General contractor: C. L. Peck Contractor.

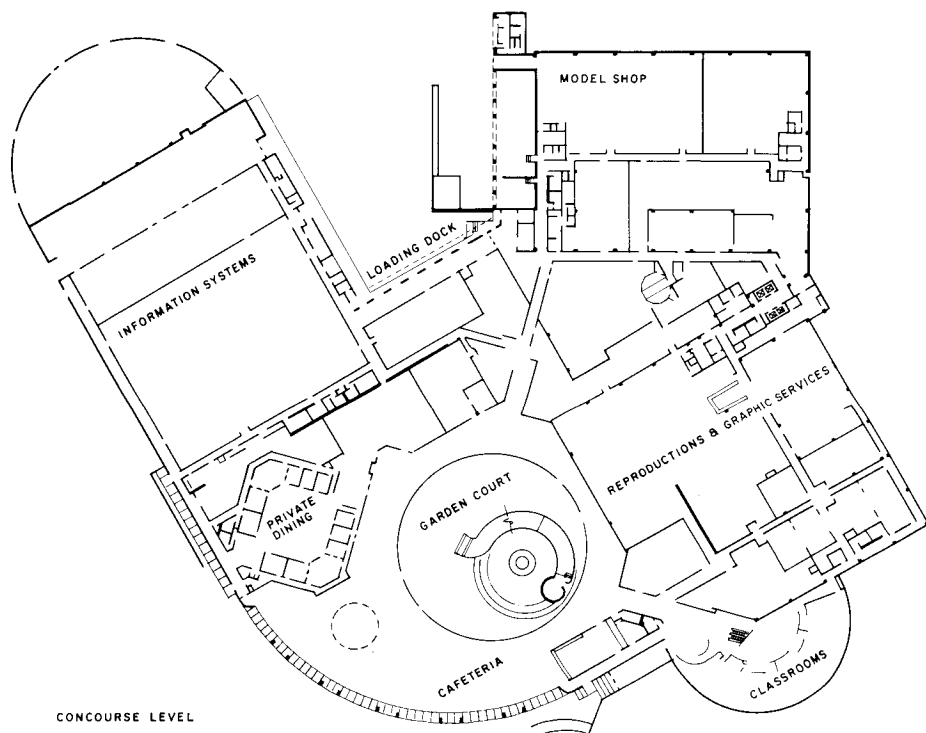
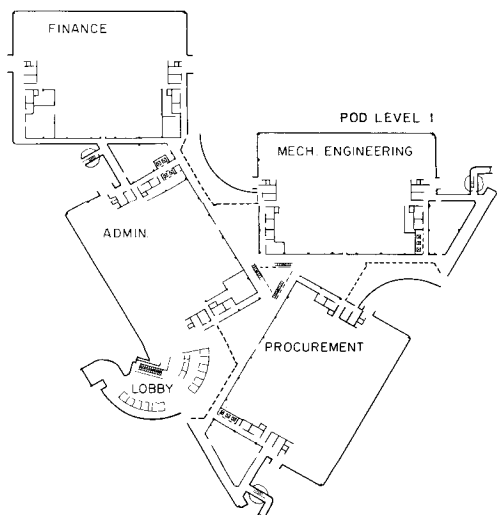
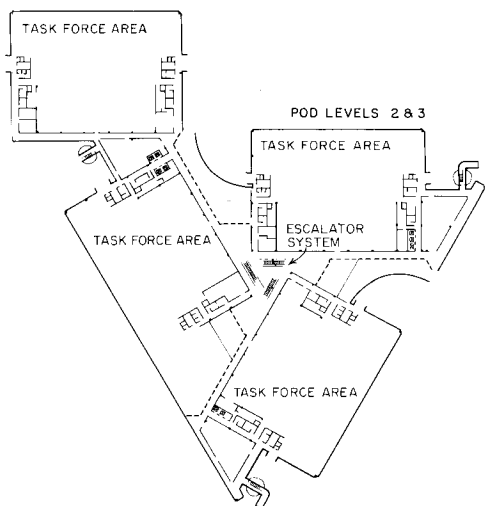

CONCOURSE LEVEL



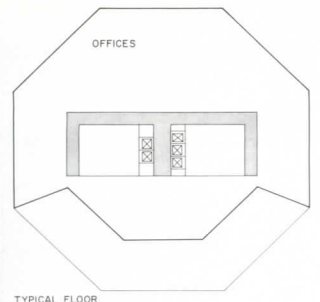
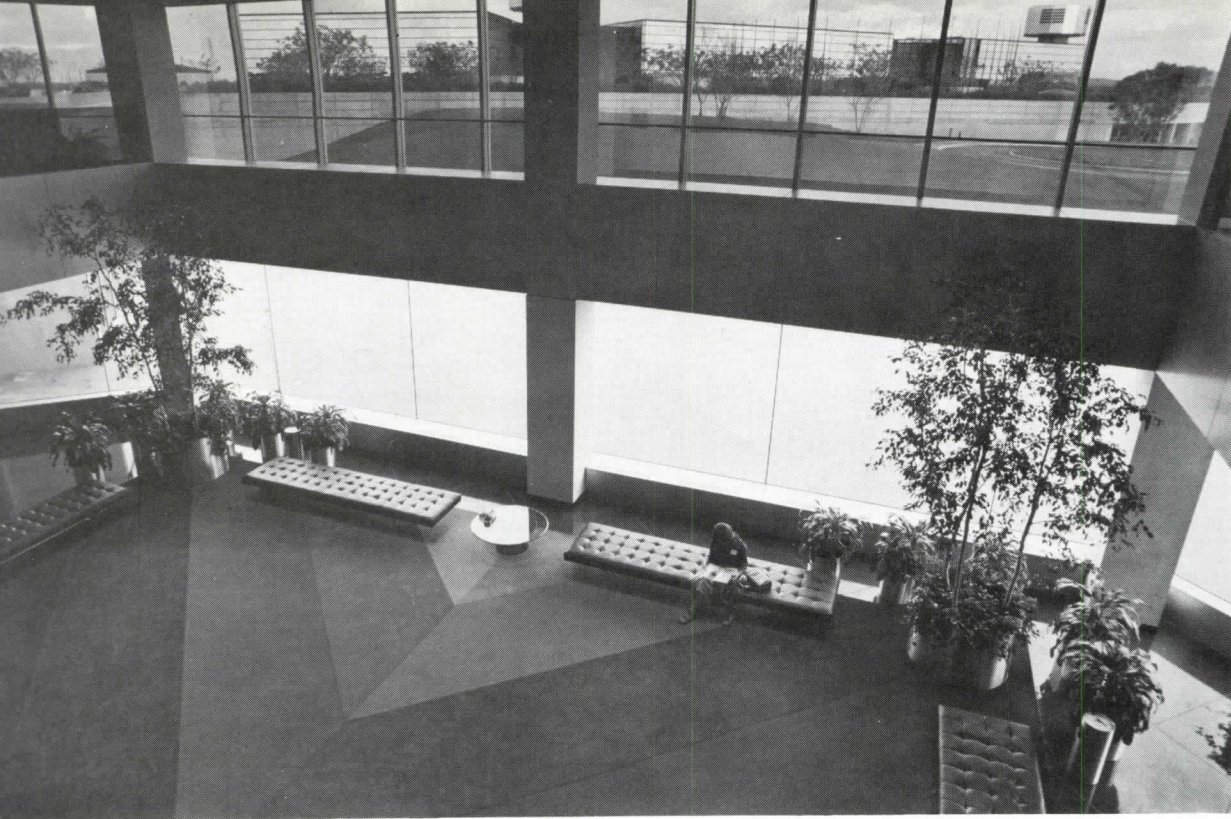

The main lobby of the headquarters building (left) was designed as a two-story space, partially surrounded by a balcony lounge at second-floor level. Through the upper windows, the Southern California Division building can be seen across the concourse. The office spaces on upper floors were open-planned—a system that worked well within the octagonal building shape, and the cut-away portion on the first eight floors on the east elevation. The top two executive floors revert to the full octagonal shape.





Circling the subterranean cafeteria, which looks out onto a garden court, are a variety of facilities for use by employees. A lounge (above left) and recreation rooms are provided in addition to the more standard meeting and private dining rooms. Another aspect of Fluor's Southern California Division building is the circulation system. While the firm's working concept of task forces emerged physically in the design of four separate "pods," the intersection of the pods is the hub of the circulation system, often a myriad number of escalators and stairs (left).



*Sewage Pumping Station/Ramsey Dabby Photo*

# BUILDINGS FOR INDUSTRY

This month's Building Types Study shows a wide range of buildings for industrial uses. One shown in the photo on this page is a tiny sewage-pumping station, in which most of the structure is buried below grade by the necessities of its function. (What is visible from the outside is little more than a playful assemblage of those parts required for ventilation and access.) By contrast, another project is an enormous urban telephone company building, which, with its "no hands" functions, is once again largely buried. The other projects shown on the following pages are more conventionally placed on the ground, instead of in it. But they all illustrate concepts that are useful in all types of industrial construction—be it the ability to develop interesting exterior spaces through such utilitarian requirements as access to a steam pipe (as in the University of North Carolina's maintenance building, page 118) or the just-plain-better-looking design of a commonly used industrial roof type (see overleaf).

The volume of this kind of design work is scheduled to build through the year. According to McGraw Hill Information Systems Company vice-president and chief economist, George Christie, 1978 should be the year when we see industrial construction follow the traditional pattern of being the last to catch up in a construction-volume upswing. While the increase in housing-construction dollars this year may do little more than represent increased costs due to inflation, Christie is predicting a sixteen per cent increase in industrial construction and another healthy gain in 1979—especially if the current relevant tax-incentive bills are made into laws.

While current trends may mean a lot more construction of really large plants made for heavy-duty manufacturing, the lessons learned from the following not-so-heavy duty buildings will obviously be applicable to their future larger cousins. The Building Types Study shows some of the best design in its field, and—while there is a lot of that for light manufacturing—it is still sadly difficult to come across in the really large facilities. Maybe this Study will be an incentive for change.—*C.K.H.*



## THE BEMIS COMPANY

This 180,000-square-foot factory and warehouse for a packaging manufacturer in Omaha, Nebraska, has been recently completed by architects Bahr Vermeer & Haecker for a construction cost of \$3,491,000. This low figure is all the more surprising because the construction required a floor level that had to be partially elevated and partially excavated to match the loading height of railroad cars, because the building embodies long-term energy conservation measures, and of course because it is outstandingly good looking. The architects attribute part of the cost savings to a combination of innovative and standard construction techniques. First, the lightweight steel framing, insulation and steel cladding of the monitor roof structure are a completely standard manufactured system, although the vibrant yellow exterior finish was specially fabricated. The vertical surfaces are pre-manufactured hollow-core concrete panels which

provide foundation and building walls in single pieces with a finish on both sides

Among the energy-conservation measures is provision for the later addition of solar heating panels to be applied to the south faces of the monitors. Due to the natural light from these monitors, the architects cite a 30 per cent reduction in the amount of electric power required on a normal day over that required under a solid roof.

THE BEMIS COMPANY, INC., Omaha, Nebraska. Architects: *Bahr Vermeer & Haecker, Architects, Ltd.*—partner-in-charge: *George Haecker*; project designers: *George Haecker, Gary Bowen*; project architect: *Ronald Mercer*. Engineers: *AD&C Group (structural)*; *Woodward-Clyde, Consultants (foundation/soils)*; *Raymond Alvine and Associates (mechanical/electrical)*. Consultants: *Bolt, Beranek & Newman (acoustical)*; *AD&C Group (costs)*. General contractor: *Peter Kiewit Sons' Company*.



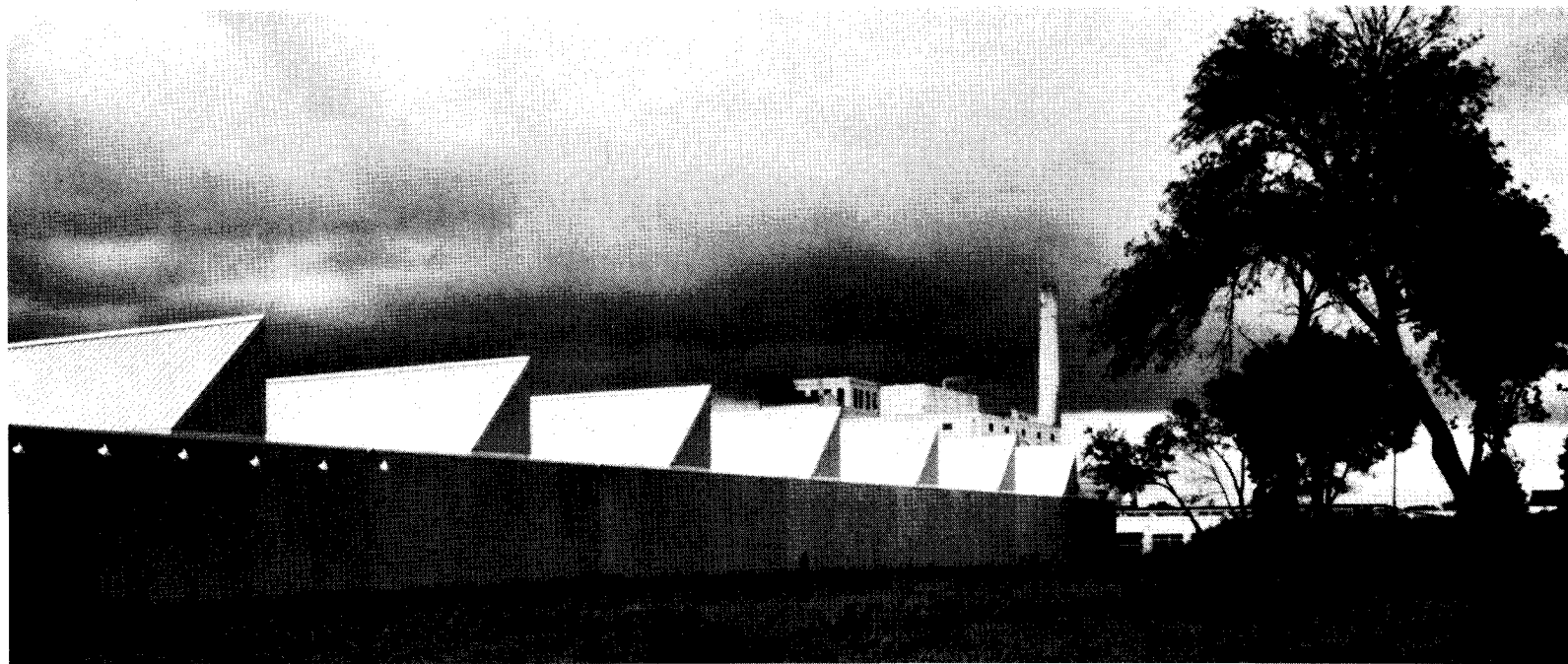

Joshua Freiwald photos

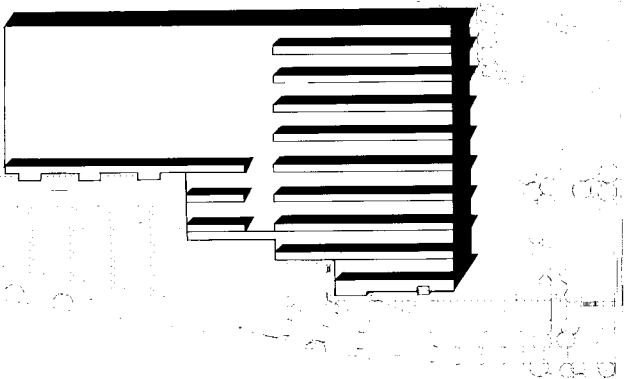
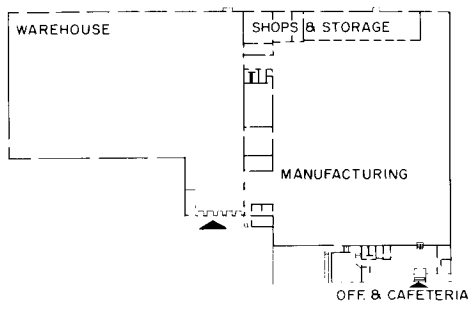

20



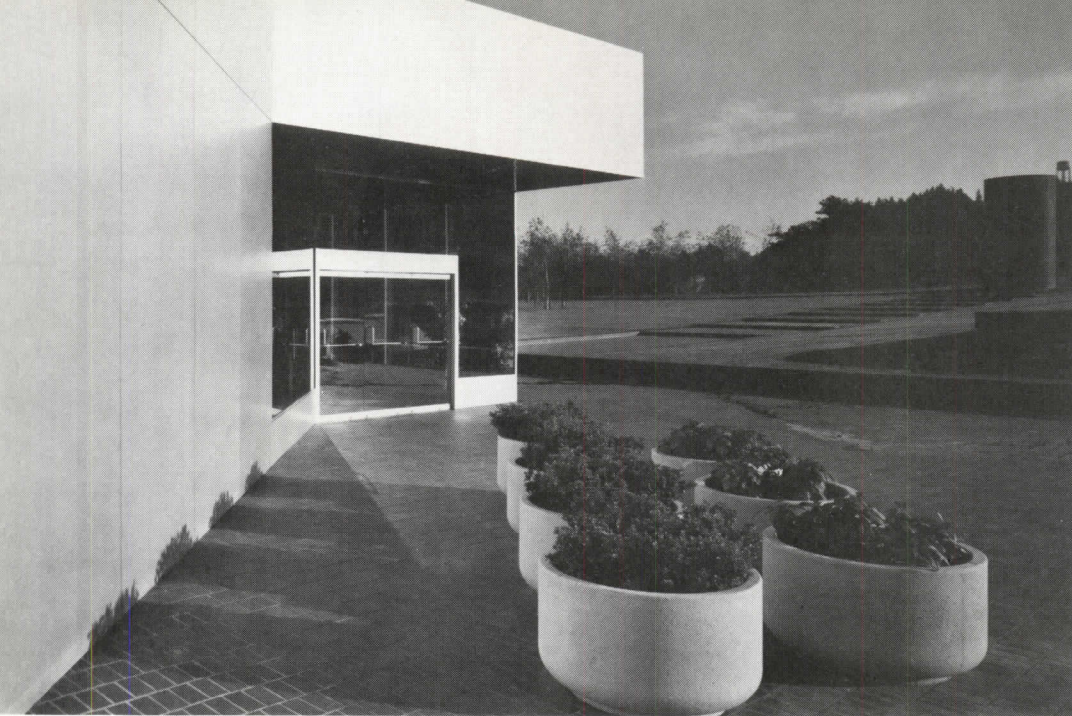

Larry Mills photos except as noted



## PACIFIC NORTHWEST BELL

Architects Zimmer Gunsul Frasca were faced with a program that might have required a three-story windowless and accordingly "faceless" building next to one of Portland, Oregon's most popular pedestrian-scaled amenities, Lawrence Halprin's Lovejoy Fountain (out of the large photo towards the left). The program was for 80,000 square feet of space on a site that was only slightly larger. The space was to be protected from natural light and vandalism for data processing equipment for the telephone company. Also included was twice that area for parking spaces. In the proposed location, a three-story building of such character not only might have intruded on the lively nature of the Fountain, but would have cut off pedestrian access from one side as well.

Instead, the architects have produced what appears to the public as a landscaped lawn containing an airy polished-aluminum and glass pavilion, which forms a pleasant and

reflective screen in front of the blank wall on an older telephone-company facility (visible in the large photo and in the plans overleaf). The new building space is underground. And the "pavilion" is the entrance and employees' cafeteria, where workers can come up for views of the lawn and fountain from their closed environment below.

PNB FOURTH AVENUE OFFICE COMPLEX, Portland, Oregon. Owner: *Pacific Northwest Bell Telephone Company*. Architects: *Zimmer Gunsul Frasca Partnership*—partner-in-charge: *Brooks Gunsul*; design team: *Raymond Boucher, Robert Frasca, Michele Lewis, Jack Walling*; project architect: *Brainard Gannett*. Engineers: *Rose, Breedlove & Mc Connell, Inc. (structural)*; *Shannon & Wilson, Inc. (foundation and soils)*; *C.W. Timmer Associates, Inc. (mechanical)*; *Langton, Mehlig & Associates, Inc. (electrical)*. Landscape architects: *SWA Group*. General contractor: *Todd Building Company*.





Ed Hershberger

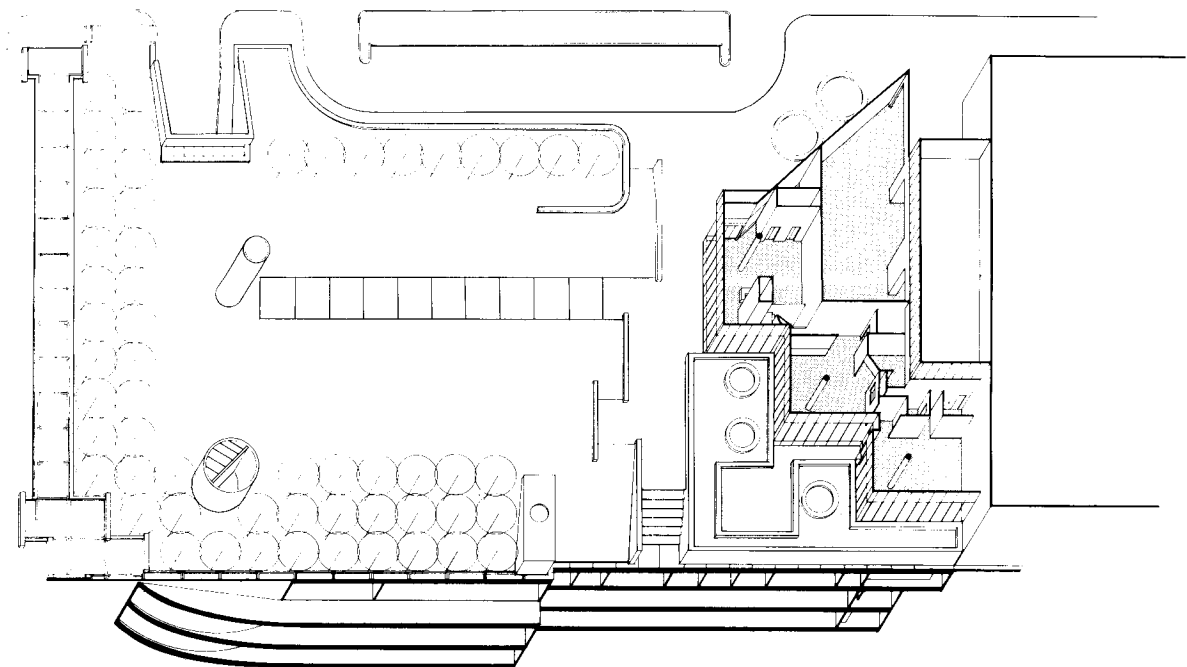

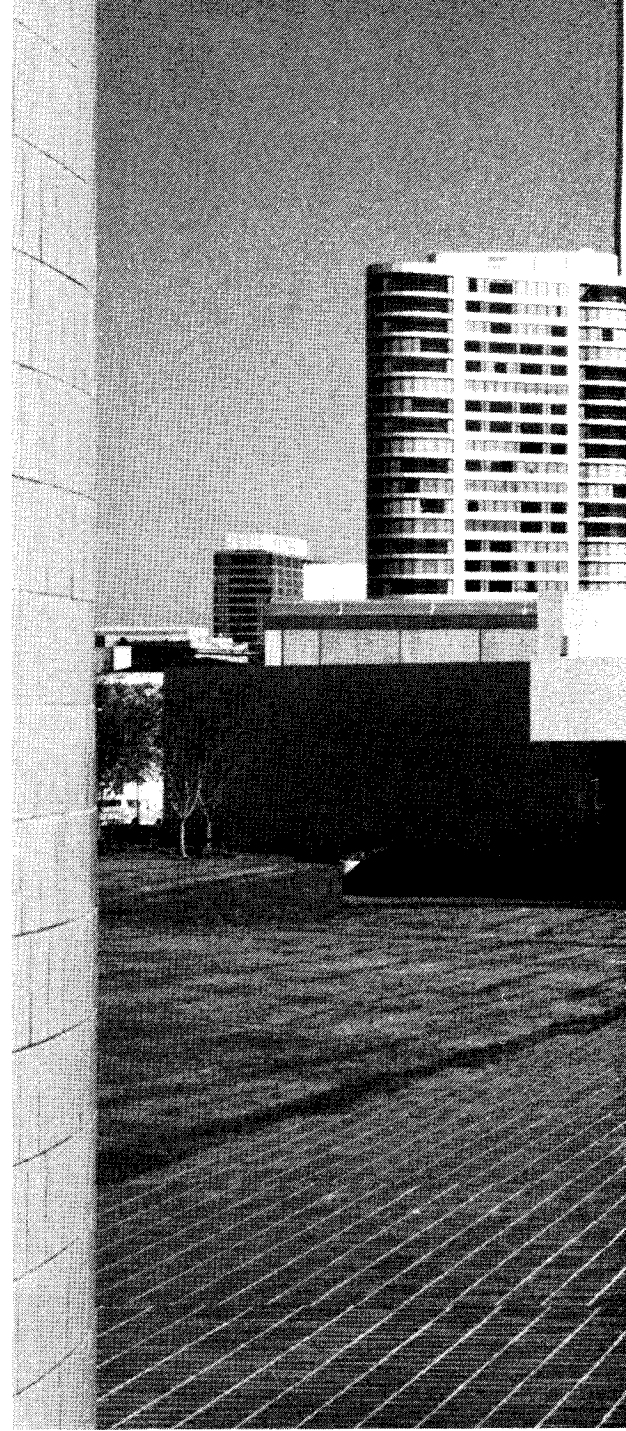
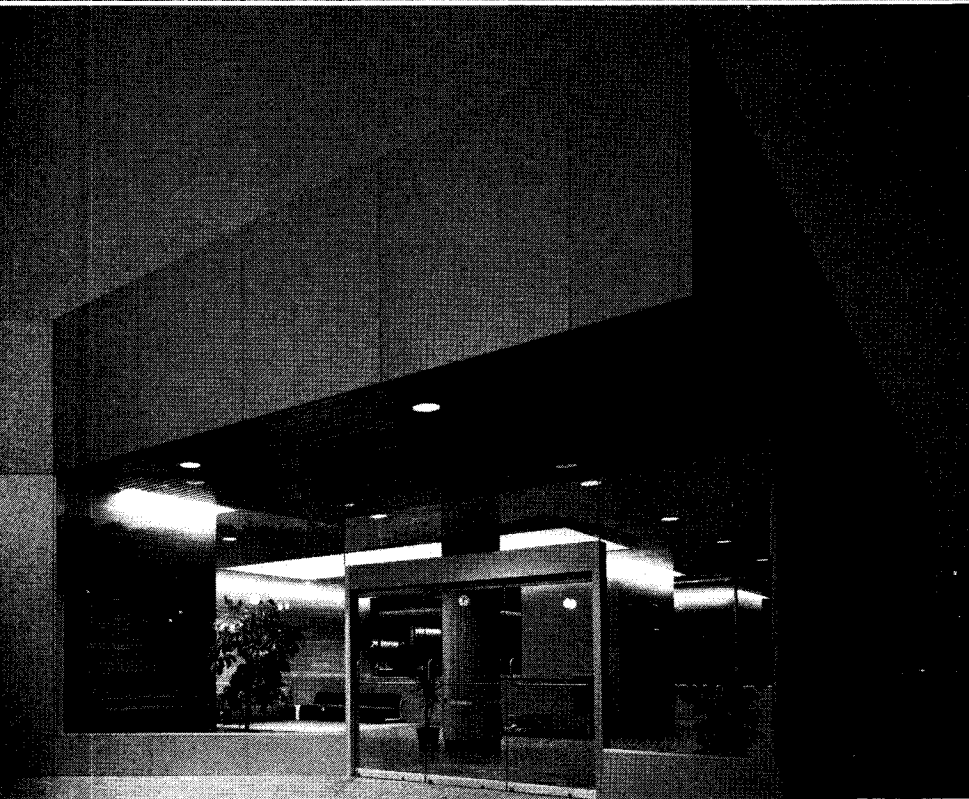

BUILDINGS FOR INDUSTRY

The underground location of Northwest Bell's \$7.3-million facility provides an obvious suggestion for other types of utilitarian structures in urban areas. In the case of NWB, the owners not only received a great public relations benefit from their gesture to the City, but they answered their program of sealed and secure spaces in a most effective way. Further, they have significant energy conservation savings (as much as thirty per cent over an ongrade structure) to help their life-cost calculations.

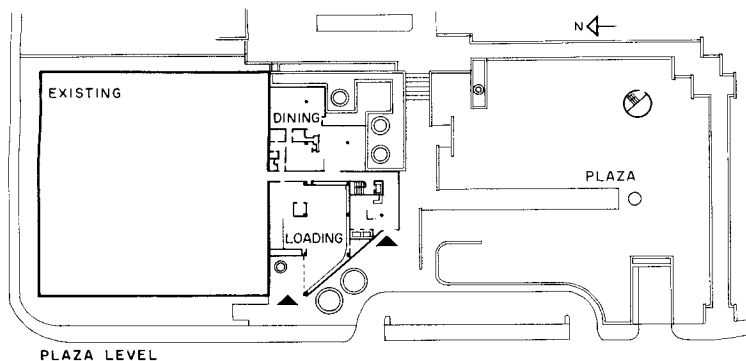

PLAZA LEVEL

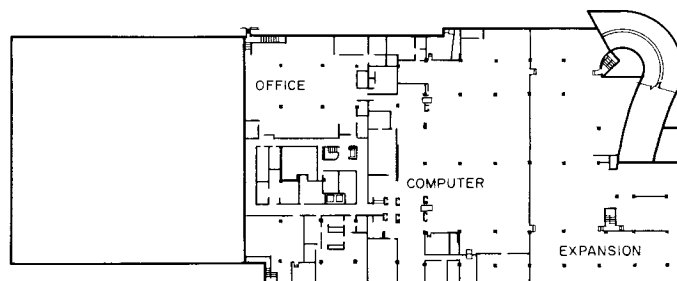

LOWER LEVEL

25





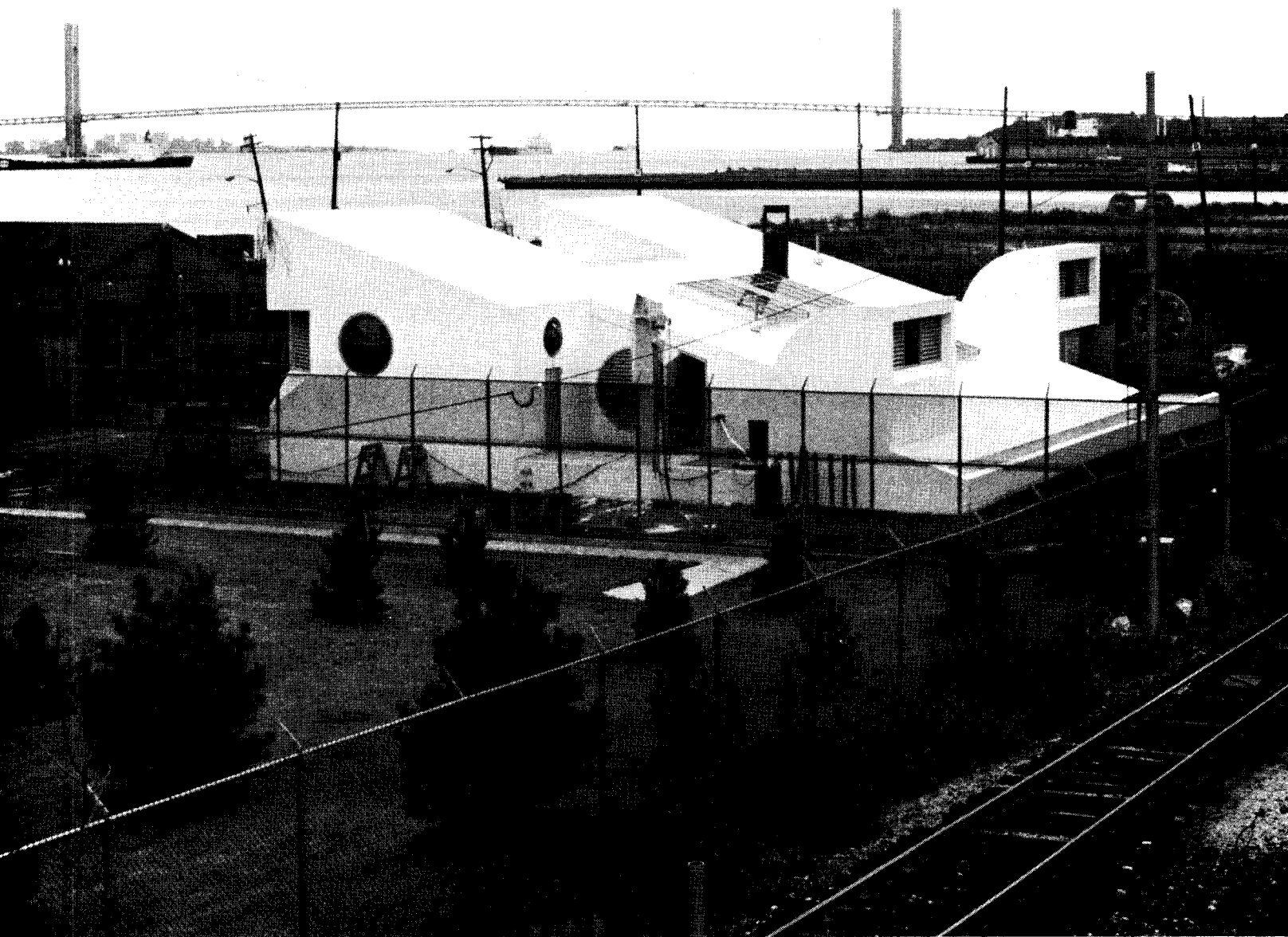

## NEW YORK WATER RESOURCES

More a playful molding of the utilitarian functions required for a subgrade structure than a building in a traditional sense, the visible superstructure of this sewage pumping station creates a spot of brightness and good humor in its run-down environment on Staten Island. According to architect Warren Gran: "Given the amorphous site, the function, and the absence of a building typology, it is simply an abstraction of the functional requirement into a form which we hope delights the eye and seems appropriate." (Gran's own daughters' preference is for what appears to be a colonial house built about the same time on an adjacent site as a water monitoring station, but daily viewers have described the pumping station as so much welcome fun.)

The pumping station is fully automated and people use the interior of both the poured concrete structure and its above-ground extension only for regular inspections which are

aided by the skylights. The station screens the sewage flowing through it, and solid wastes are removed by trucks which are loaded at docks in the two highest elements. What appear to be large port holes in the walls are windows and outside lighting. (Protection from vandalism was a primary concern, which led to the owners eventual enclosure of the site with a chain link fence despite Gran's secure design). The exposed concrete walls are coated with a white neoprene-like finish; and the crane, vent stacks and metal walkways are painted in vivid primary colors.

SEWAGE PUMPING STATION, Staten Island, New York. Owner: *New York City Environmental Protection Administration, Department of Water Resources*. Architects: *Warren W. Gran & Associates—partner-in-charge: Warren Gran*. Engineers: *John J. Baffa Consulting Engineers (structural/mechanical/electrical)*. General contractor: *Thalle Construction Co.*

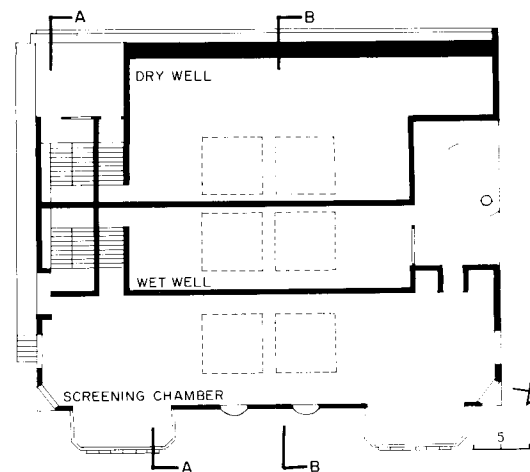

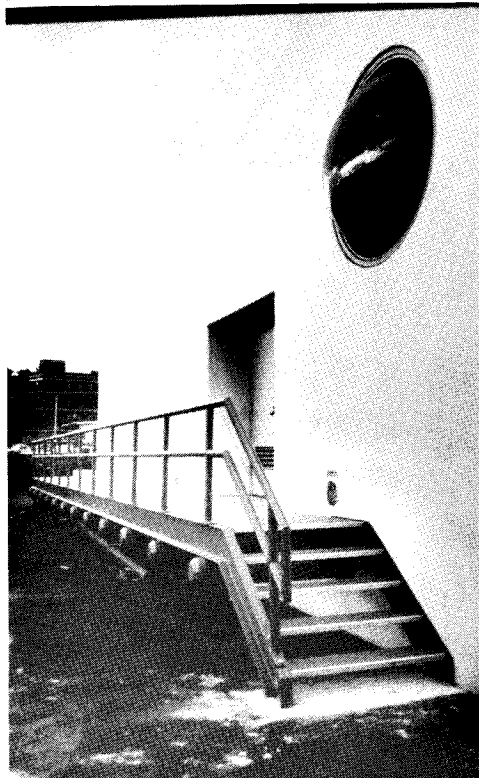
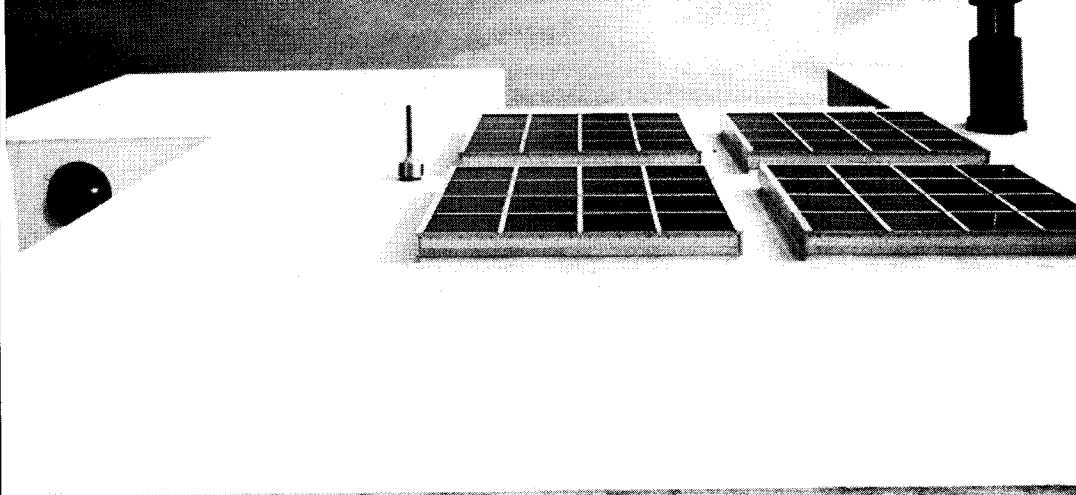
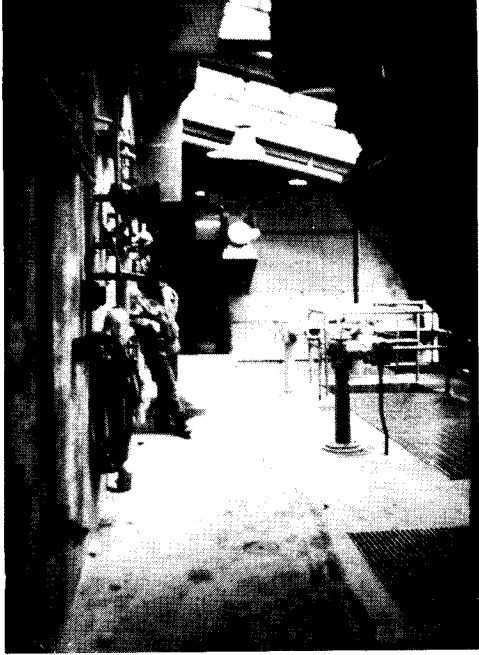

Ramsey Dabby photos.

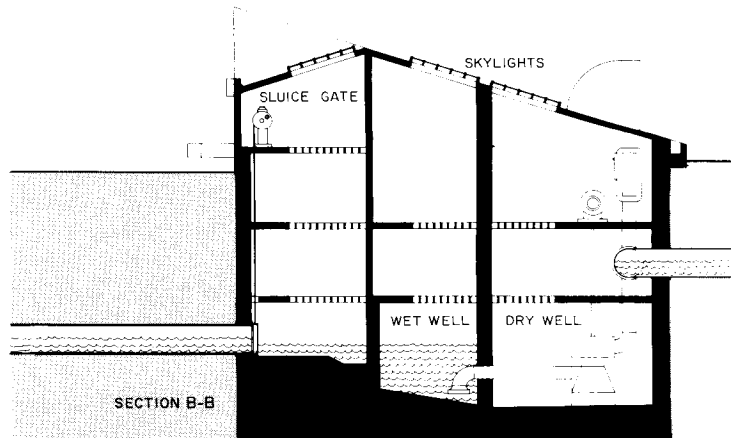
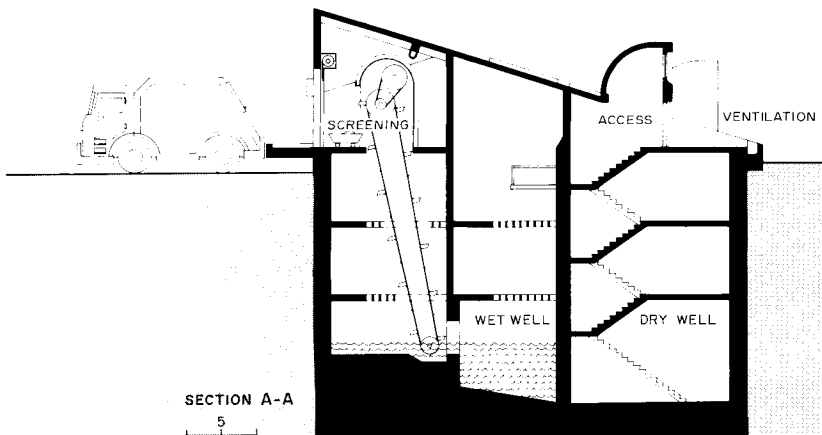

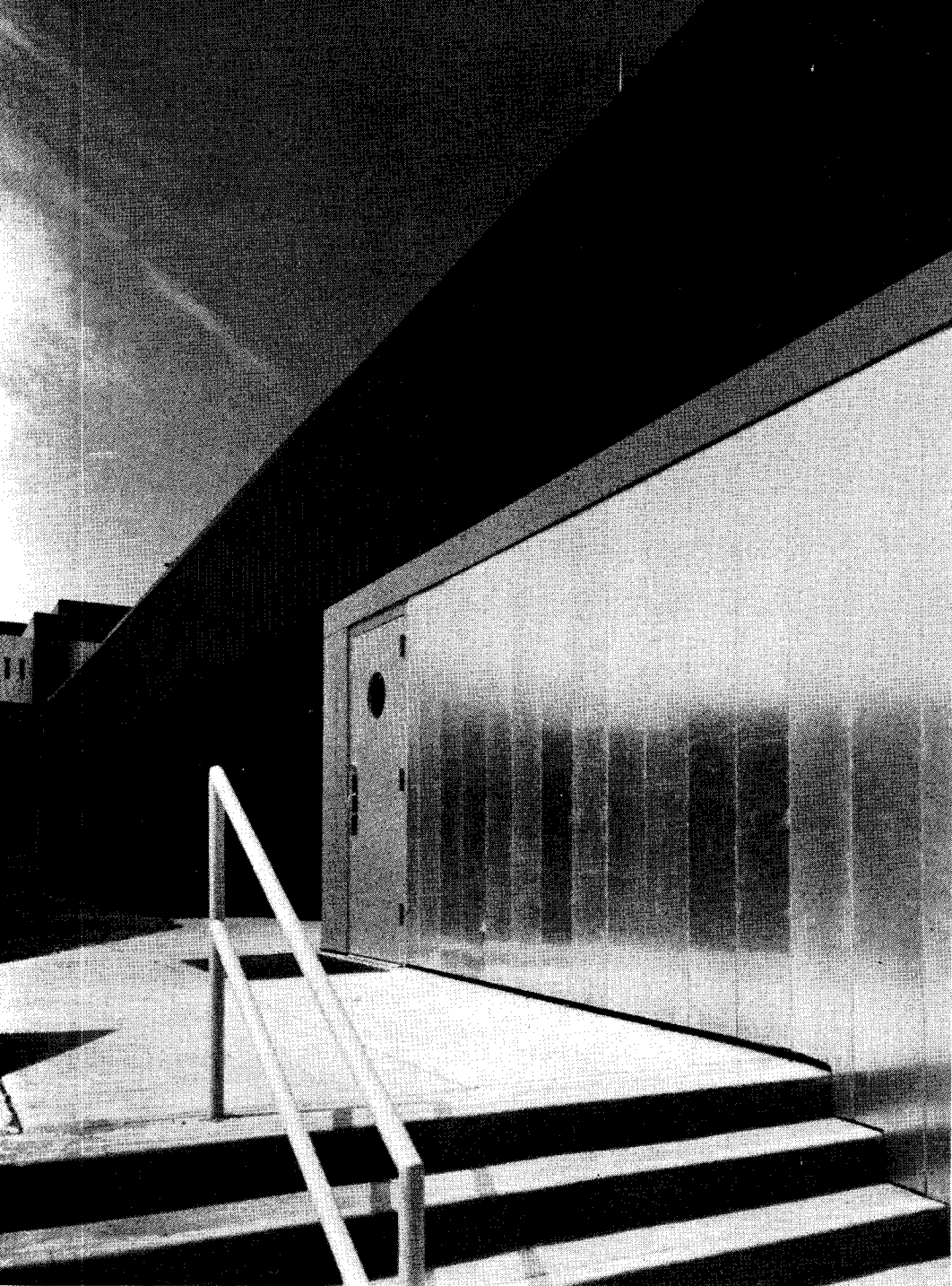

Rick Alexander photos

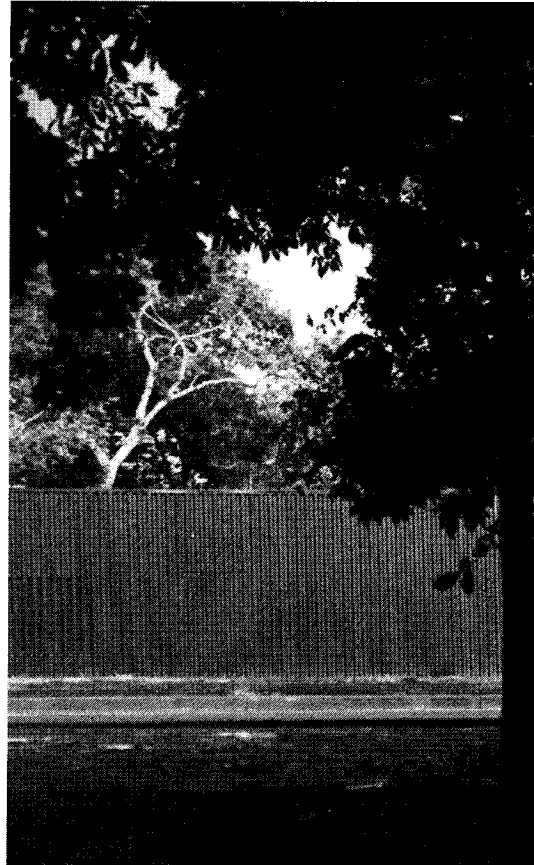
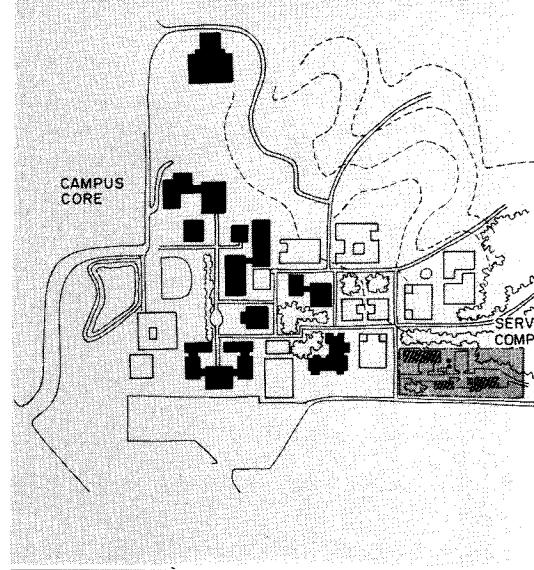

## UNIVERSITY OF NORTH CAROLINA MAINTENANCE

At the University of North Carolina in Charlotte, architects Clark Tribble Harris & Li were given the problem of designing a 10,000-square-foot facility to house the campus maintenance operations at the lowest possible cost. The site was chosen not only to complete an existing service compound, but to closely relate to the main educational buildings to the southwest. Under the site was a maze of utility lines including a steam line, which required the possibility of access along its entire length.

What the architects produced is a simple rectangular volume where natural grades have been used to raise the office area under a constant roof line with that of the higher utility spaces. The location of the steam pipe has produced a pleasant open void within the volume, and this functions as a walkway in the natural direction of traffic to the other service buildings (photo right and top).

The construction is light weight steel joists

on concrete-block bearing walls and steel columns. The block walls are sheathed in metal panels of both polished aluminum and dark-brown ribbed steel. The panels are separated by a bright yellow metal strip. The choice of colors was made to relate to surrounding existing buildings. Because of the change in grade, the side towards the main campus is a low blank facade, with only the opening to the walkway for articulation. The triangular portion of the building isolated by the walkway houses air handling equipment. The project was a winner of a regional AIA honor award.

**PHYSICAL PLANT BUILDING**, Charlotte, North Carolina. Owner: *University of North Carolina at Charlotte*. Architects: *Clark Tribble Harris & Li*. Engineers: *King-Hudson Associates (structural)*; *McKnight Engineers, Inc. (mechanical)*; *Crockford-Hall Associates, Inc. (electrical)*. General contractor: *Price & Hill, Inc.*

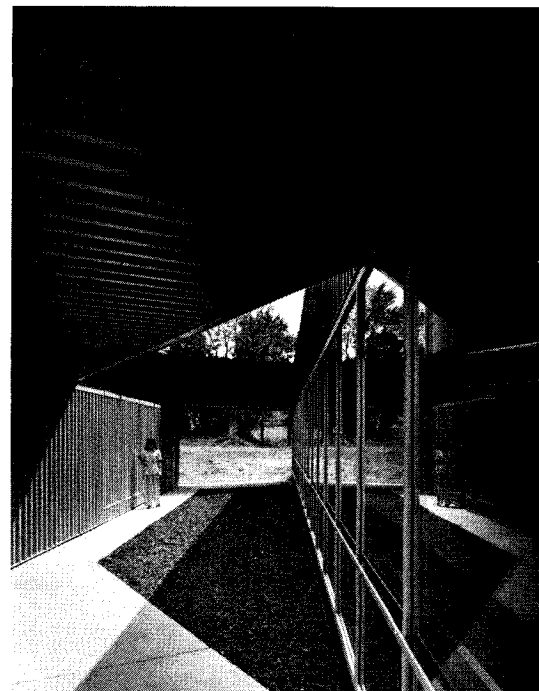

Rick Alexander photos

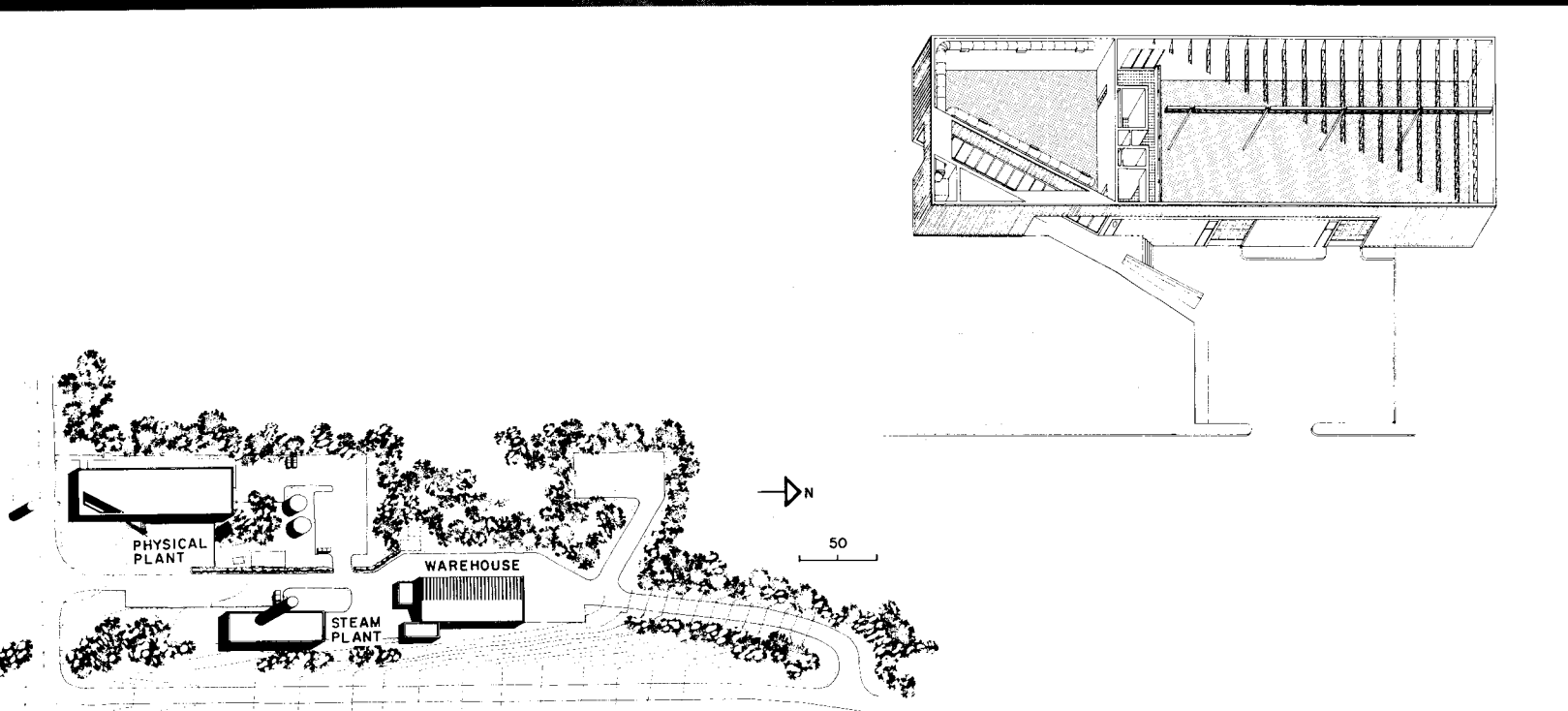
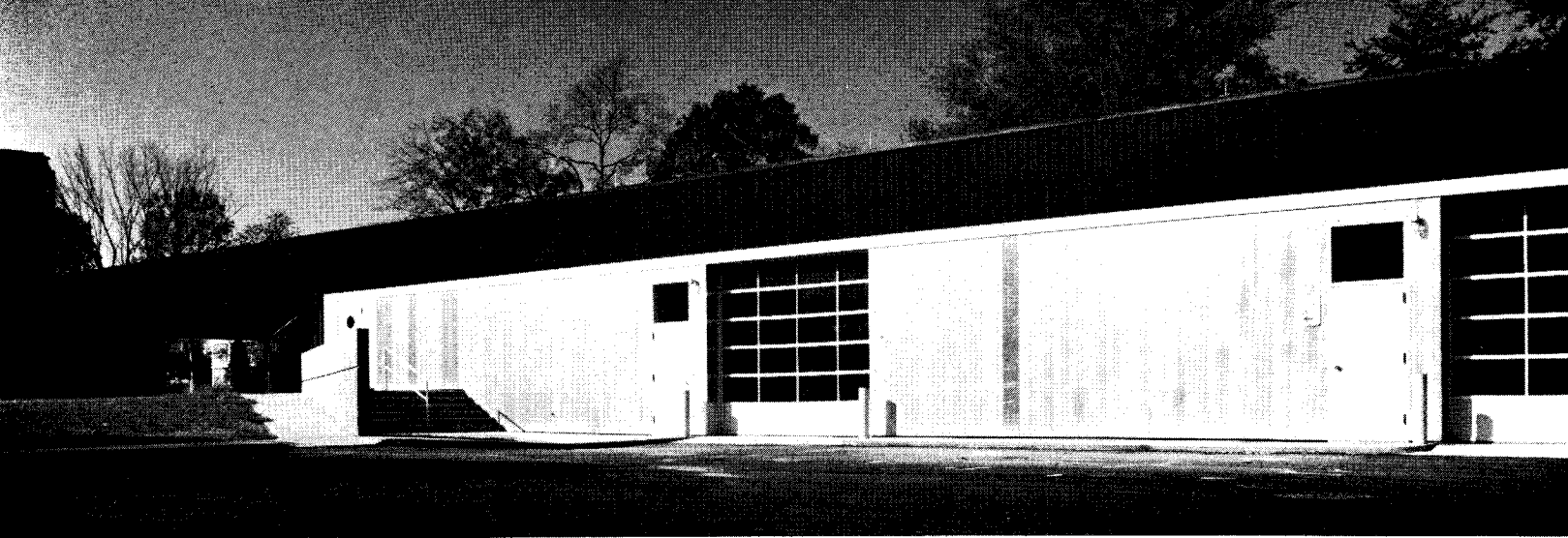

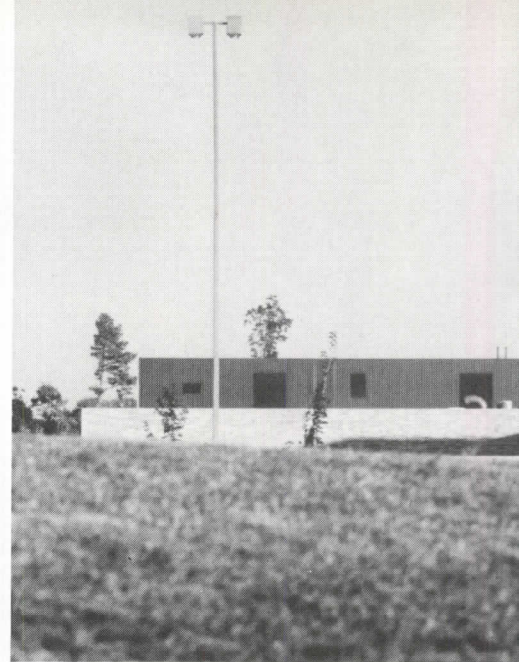

## TEXTRONIX INCORPORATED

This plant for Tektronix, Incorporated (a major manufacturer of electronics items) is the first building on the company's new 240-acre site in Wilsonville, Oregon. A similar size site in nearby Beaverton already accommodates two and a half million square feet of exceptionally high quality buildings by the same architects, the Zimmer Gunsul Frasca Partnership, who are also currently engaged in a master planning study for Wilsonville to determine the best course for its future development. The vast 250,000 square feet of the new building are designed for seemingly conflicting criteria: maximum flexibility in open floor areas, and a need for human scale for the workers. To achieve the latter goal, the architects have divided the basic employee amenities—such as rest rooms and canteens—into a number of units located around the perimeter of the manufacturing spaces. Each one of these units has windows and doors opening onto outside

terraces (see photos overleaf and above). Between units high mechanical equipment enclosures stretch across the open floor spaces to provide visual variety and quick identification of the units' locations (see isometric overleaf).

The structure of the \$6-million building is a combination of steel columns, concrete walls, and concrete and glue-laminated wood beams. The floor and roof decking are wood, and the structure is sheathed with brick. A "low-profile" image from the highway has been established with earth berms and planting.

GENERAL PURPOSE BUILDING 60, Wilsonville, Oregon. Owners: *Tektronix, Inc.* Architects: *Zimmer Gunsul Frasca Partnership.* Engineers: *Shannon & Wilson, Inc. (foundation/soils); C.W. Timmer Associates, Inc. (mechanical); CH2M/Hill (electrical).* Consultants: *Mitchell Associates Planning (landscape); Jim McConnell (food service).* General contractor: *H.A. Anderson Company.*

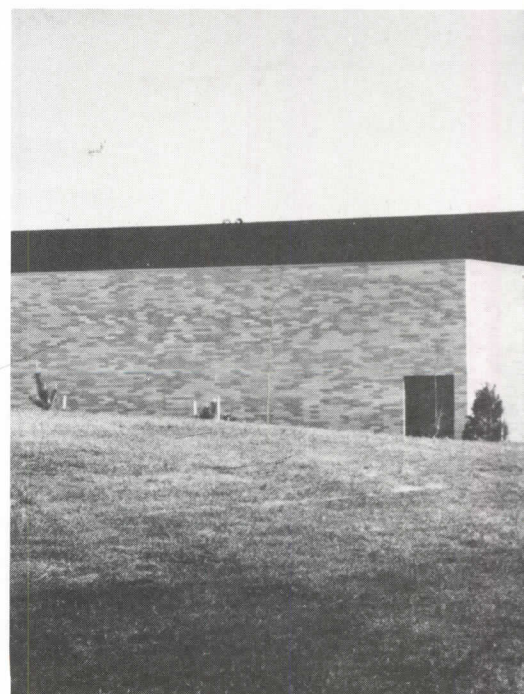

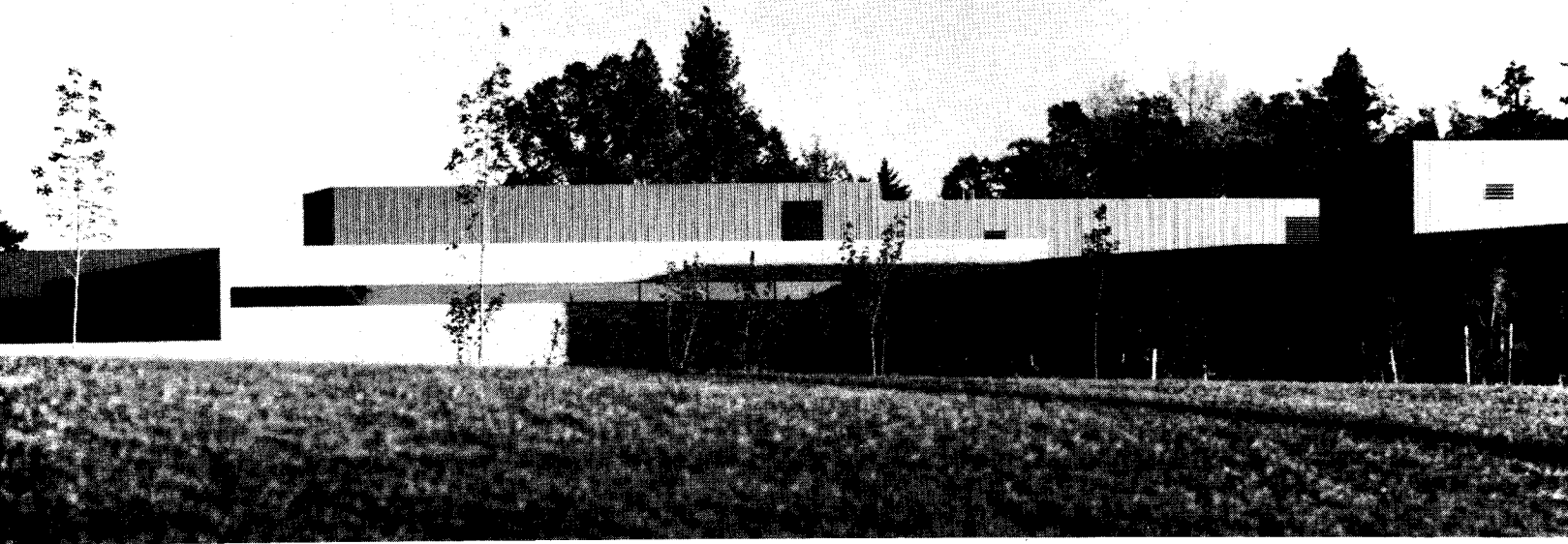

*Ed Hershberger photos*

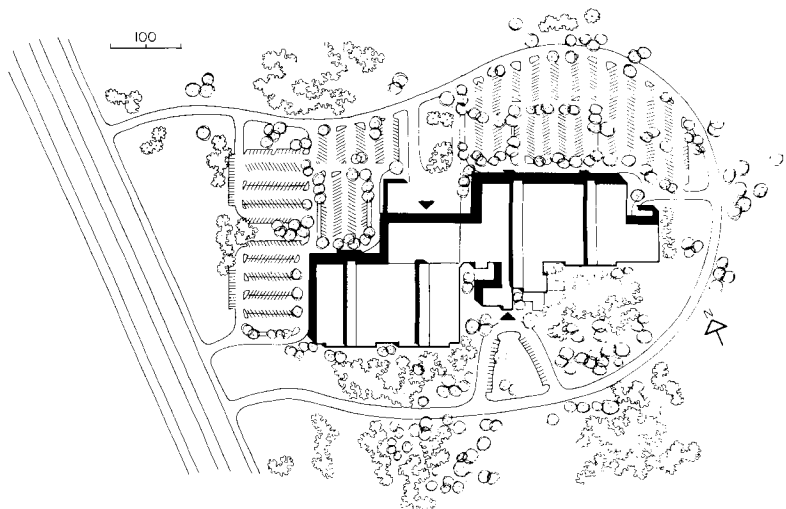



The large manufacturing areas are divided into two parts separated by a warehouse (top of left-hand part of isometric opposite). The principal circulation is along the perimeter walls. The working environment for the employees is enhanced by numerous terraces adjacent to canteens and rest rooms. The many entrances from these terraces provide a more human scale, despite the size of the spaces inside. These large spaces are visually broken down from the exterior by the high mechanical equipment enclosures, which run across the building and join units of rest rooms and canteens—or a unit and the offices in one case (see isometric).







Ed Hershberger photos

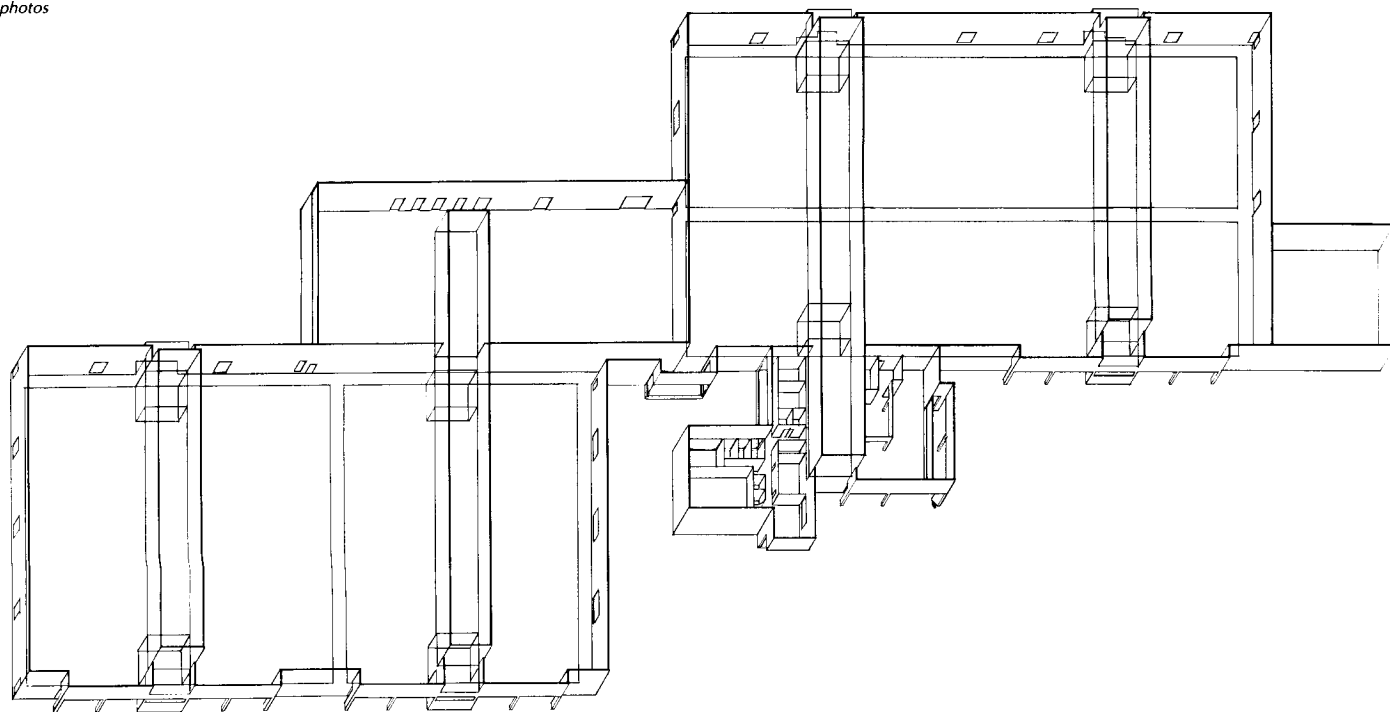

## Easily installed floating floor system buffers fan-room noise

Because architects often find it necessary to place offices directly below mechanical equipment floors, the need for sound isolation has grown more acute, but techniques and materials are available to cope with the problem. The system used for attenuating airborne sound is the floating floor. (This is not a vibration isolation system, however; if needed, this is supplied separately by springs, alone or by springs and inertia blocks.)

The original version of the floating floor manufactured by Peabody Noise Control utilized low-density fiberglass and isolation pads attached directly to 4- by 8-ft sheets of exterior grade plywood which is used as the form for the 4-in. slab that "floats" over the structural slab. (For more detailed information

and examples of the system's use see RECORD, March 1975, pages 157-159.) Now the option is available of a roll-out version of the isolation material, with the contractor obtaining the plywood locally, which saves shipping costs.

With the installation shown here—the mechanical penthouse for the Fluor Corporation Headquarters Building (described on pages 103-108 this issue), the roll-out system reduced first costs because the manufacturer fabricated the material off-site, in Ohio, and installed it in California.

Capacities of the roll material are 100, 200, 300 or 400 lb per sq ft to cover a range of loads. The Fluor penthouse has five areas where high-load material is necessary.

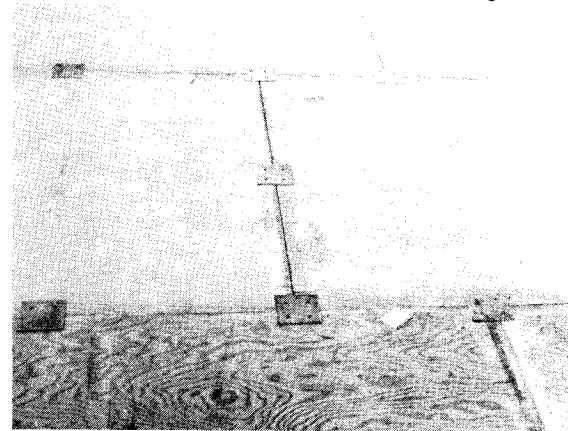

3

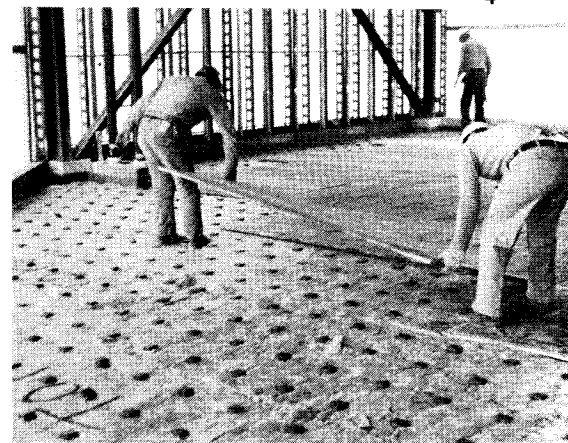

4



5

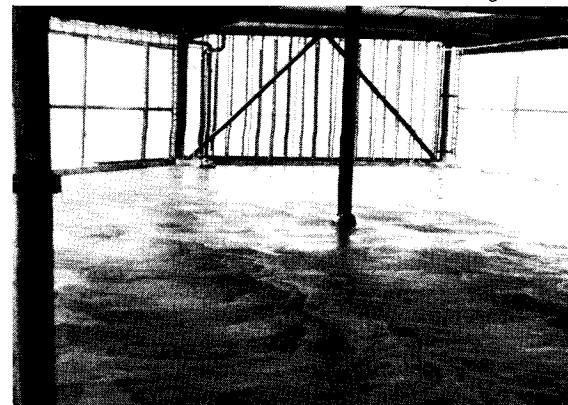

6

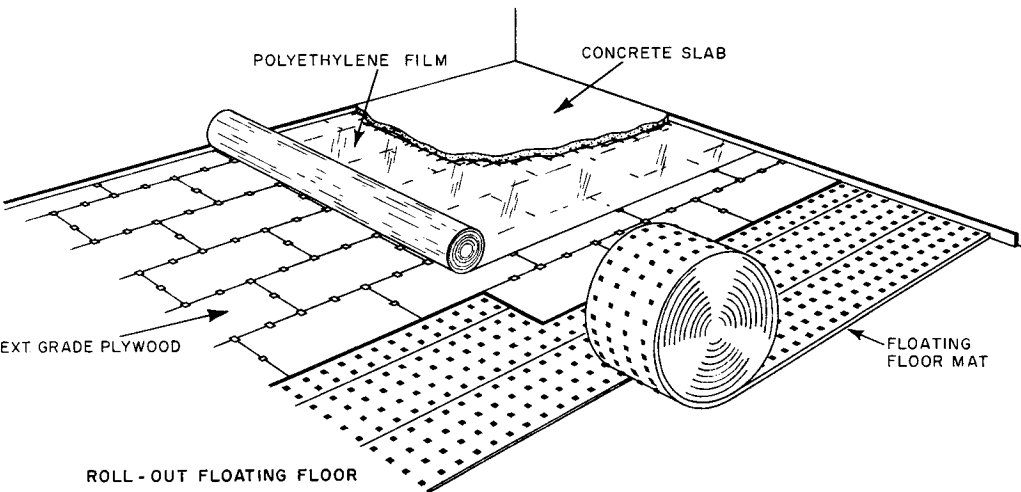

The roll-out mat has low-density fiberglass for sound absorption and isolation pads to "decouple" the top slab and the structural slab. Plywood sheets are the form for the upper slab, and are covered with polyethylene sheet to prevent concrete from seeping through joints, which could reduce the effectiveness of the system. The top slab is separated from walls by isolation board.

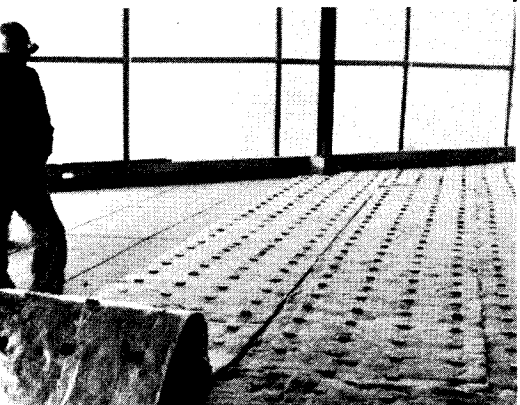
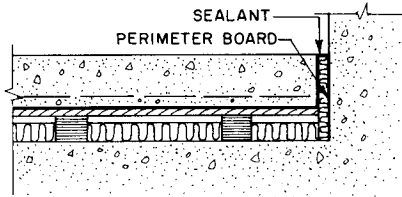

1



2

# Steel-deck ceiling provides low-cost security in a detention center

Providing a better physical environment in jails, prisons and detention centers, while still maintaining security and keeping costs down, is the challenge Prindle, Patrick and Partners have had to face as they have designed correctional facilities for many different cities across the country. To achieve this goal, the firm has correctional specialists for planning, investigation of local requirements, and resolution of design and economic problems.

Finish materials are, of course, a major area of concern—they need to be attractive, yet invulnerable to damage by inmates. For the Lexington-Fayette Urban County Detention Center in Lexington, Kentucky, shown here, the firm was looking for a material to replace steel plate for ceilings because of its high cost. They considered a plastic laminate sandwich, but this also was too expensive.

Prindle, Patrick and Partners then asked H. H. Robertson Company for suggestions, and the company offered a steel deck specially adapted to ceiling use. Because of its 14-gauge construction, the ceiling cannot be damaged by inmates, and, by virtue of its interlocking design for field welding, the panels cannot be pried apart or removed.

The system allows clear spans up to 32 feet, and the exposed surface is embossed and prime painted to allow a finished, attractive appearance. Lighting fixtures can be either recessed or surface mounted. Cellular construction of the ceiling can provide built-in cells for electrical services. The ceiling also permits acoustical control by use of perforated panels with fiberglass pads mounted above them.

In a different application, the Baldwin County Public Safety Building in Milledgeville, Georgia, designed by John J. Harte Associates, the cells of the ceiling also were used to deliver air.

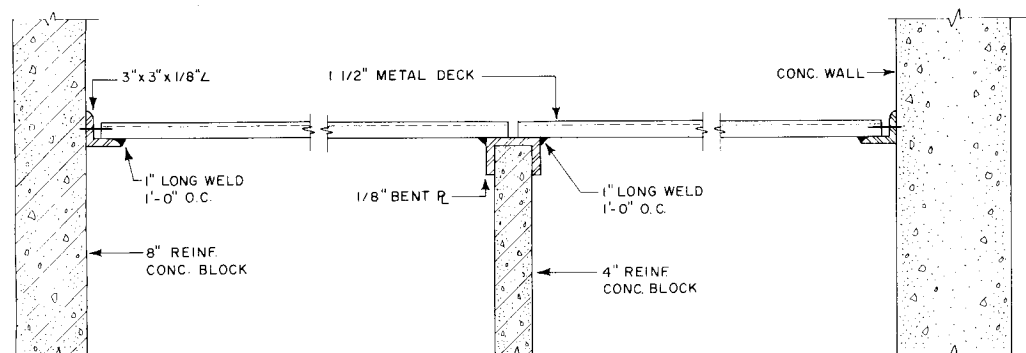
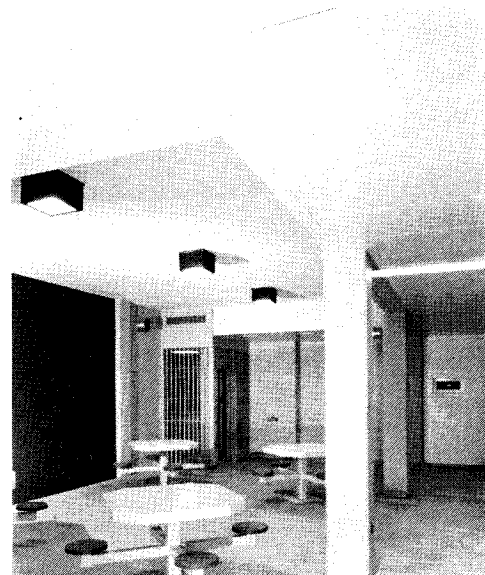
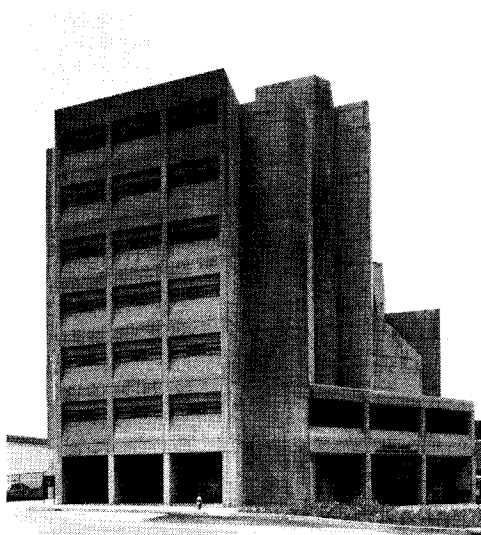

CEILING DETAILS

Structure of the 420-prisoner, \$6.5 million Lexington-Fayette Urban County Detention Center is a combination of precast and poured-in-place concrete. First floor is for administration, while the upper six floors house prison-support facilities and prisoners in 15-man units with cells opening to a central dayroom activity area. The ceiling is 1 1/2-in. deep cellular metal deck. Panels interlock and are welded together. Drawings show typical installation details.

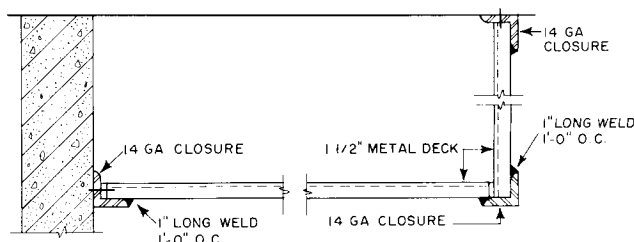

SOFFIT DETAIL

For more information, circle item numbers on Reader Service Inquiry Card, pages 185-186

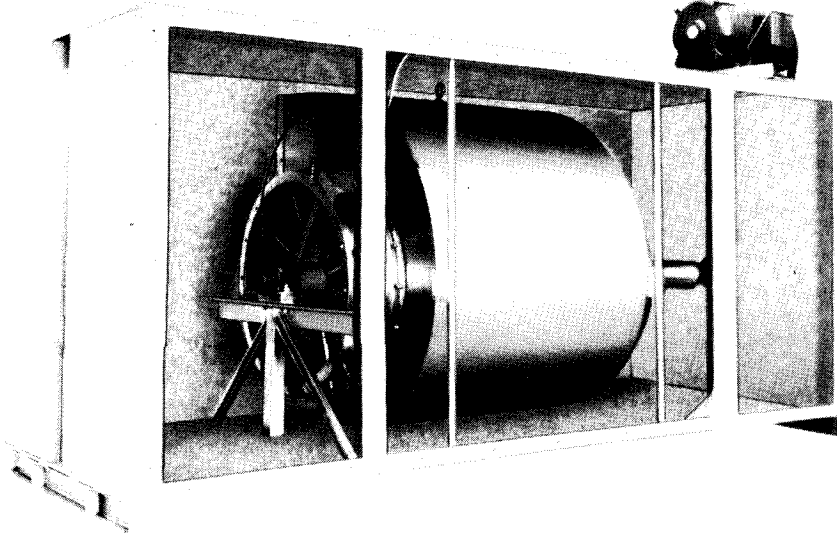

## Air handler reduces power need

The newest model of variable-volume air handlers for Airtherm Manufacturing Company is designed for all low-pressure applications. According to the company, the new units provide higher performance at lower horsepower than many other models available. Only a single large fan is incorporated to allow the use of both back-

ward-inclined and airfoil-type wheels. Inlet guide vanes permit adjustment of the air volume. This design is offered in both single-zone draw-through and multi-zone blow-through units. Compactness and low height are installation advantages. ■ Airtherm Manufacturing Co., St. Louis, Missouri.

circle 300 on inquiry card

## Storage files hang on unused partition panels

A space-saving "File Wall" for storing folders and literature which must be readily accessible has been designed to be hung on unused faces of partition panels. To suit individual needs, the shelves come in more than a dozen different

lengths ranging up to 72 inches (each a standard 12 inches deep) and the file dividers may be spaced at any width desired. Seventeen colors are available. ■ Rockaway Metal Products Corp., Inwood, New York.

circle 301 on inquiry card

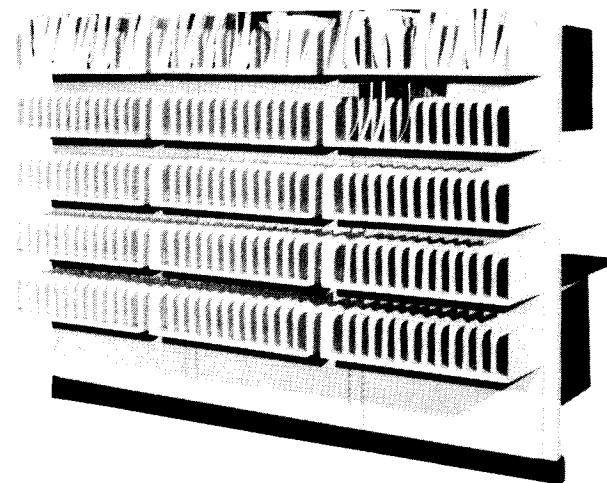

## Digital drafting and measuring compass for drawing circles

A digital drafting and measuring compass is being marketed that enables the draftsman to construct over 200 circles, twelve-thousandths of an inch apart, from a single center point. Designed to eliminate the need for dividing, measuring and trial circles, "Circleometer" can also

be used to measure circles, construct complex geometric figures and to make hidden lines with well-defined starting/stopping points, all with consistent line quality according to the company. ■ Atlantic & Pacific Industries, Irvine, California.

circle 302 on inquiry card

## Retrofit bidet is newest in line of luxury bathroom appliances

A new bidet can be easily installed in place of the conventional toilet seat and requires no extra space. With a complete hook-up kit, the unit connects to the existing water supply through one line and to the nearest electrical outlet through another line. It is outfitted with a water pressure regulator, water directional control, warm air blower and remote control.



Outside of residential use, the unit can be installed in medical facilities and facilities for the handicapped. It requires 8 to 10 ounces of water to operate. A luxury item, the cost ranges from \$250 to \$350 depending on the model and features that have been selected. ■ Rusco American Bidet Corp., Los Angeles.

circle 303 on inquiry card  
more products on page 137

# Now...innovative, versatile fabric structures that last. TEFLON makes it possible.

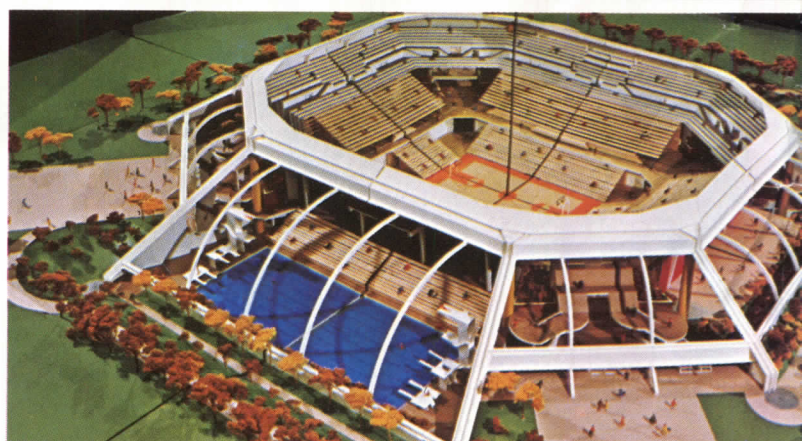
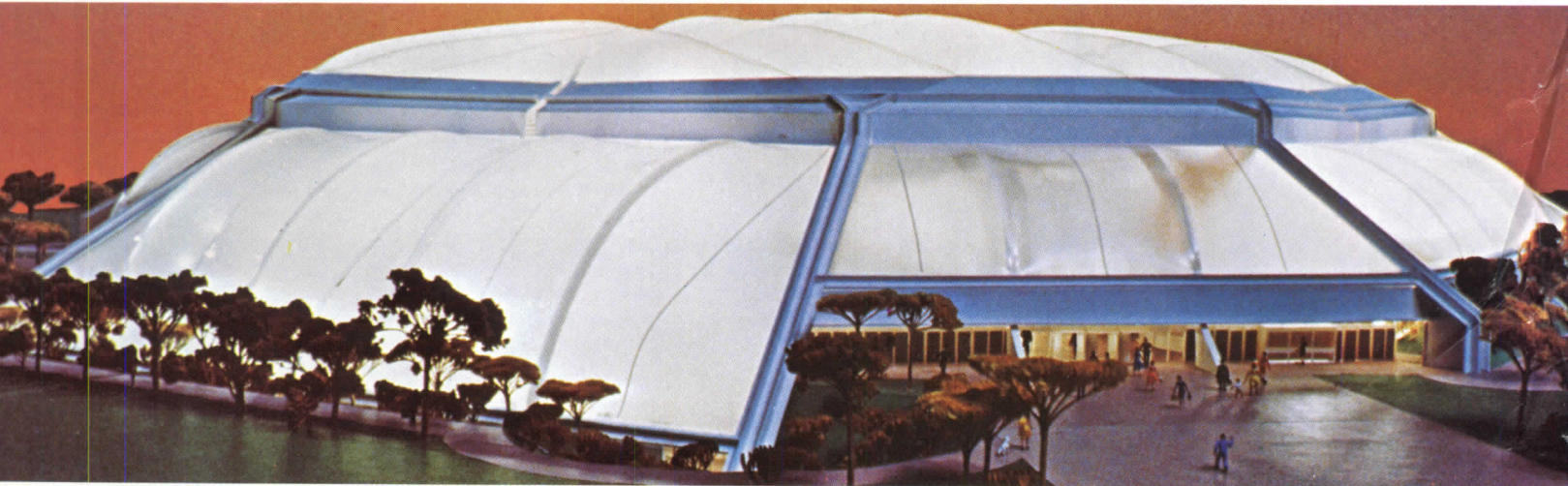

Model of proposed student activities center, University of Florida, Gainesville, Florida. Architects: Caudill Rowlett Scott, Houston, Texas; Moore, May & Harrington, Gainesville, Florida. Engineers: Geiger-Berger Associates, P.C., New York City.

Permanent fabric exterior removed from model to illustrate column-free interior.

The University of Florida at Gainesville needed a new student activities building. They wanted a basketball court, olympic-size swimming pool, high diving area, indoor track, court sports and gymnastic area, locker rooms and administrative offices. They wanted an attractive permanent building...not a temporary structure. And, they had the inevitable limitations of a budget.

The architectural firms of Caudill Rowlett Scott and Moore, May & Harrington met their needs by proposing a permanent building of architectural fabric coated with TEFLON® fluorocarbon resin. Pound for pound stronger than steel, the glass-fiber fabric can be supported by light air pressure or high strength cables providing large, clear spans without bulky, expensive supporting columns. Enclosed space is free and uncluttered. And the translucence of architectural

fabric coated with TEFLON adds to the feeling of openness. It admits enough natural light to grow plants and carry on sports activities even on cloudy days. The new facility is designed to resist Florida hurricane forces.

TEFLON makes it possible. Architectural fabric coated with TEFLON resists sunlight, industrial smogs, aging and weather. It washes clean in rain. Its excellent flame resistance has permitted it to be accepted under all code requirements for permanent buildings for which it was submitted.

To learn more about permanent buildings with architectural fabric coated with TEFLON, send for our free 16-page, full-color brochure. Write: Du Pont Company, Room 35743J, Wilmington, DE 19898. In Europe: Du Pont de Nemours International, S.A. P.O. Box CH-1211, Geneva 24, Switzerland.



REG. U.S. PAT. & TM. OFF.

For more information, circle item numbers on Reader Service Inquiry Card, pages 185-186

**ENERGY SAVINGS** / A guide of practical residential energy saving practices, "The Great Indoors Handbook" deals with "common sense" conservation ideas and discusses the advantages of this manufacturer's heat pumps and gas furnaces.

■ Bryant Air Conditioning, Indianapolis, Ind.

circle 400 on inquiry card

**INTEGRATED CEILING SYSTEMS** / A complete line of acoustical materials, modular suspension systems, *Holophane* luminaires, and air distribution equipment is described in a 24-page catalog. Each of the 10 integrated ceilings featured in the booklet can be arranged in a variety of configurations to meet virtually any design requirement; technical illustrations depict the basic components used in each system. Product performance and code data is included. ■ Holophane Div., Johns-Manville Sales Corp., Denver, Colo.

circle 401 on inquiry card

**ENERGY MANAGEMENT SYSTEM** / A color brochure introduces a computerized energy management system said to be more comprehensive than basic time-clock control systems, but more economical than elaborate computerized installations. The *Enertech 80* controls both comfort levels and demand, and can offer multiplexed interface controls built into major hvac components, minimizing field wiring. The brochure describes how the desk-top microcomputer monitors the outside temperature, compares it to the inside, then computes the amount of heating or cooling time needed to bring the building to the pre-set comfort level—and starts the hvac systems at precisely the right time. The *Enertech* can control up to 80 different loads, with a pre-set peak demand limit: when this is reached, lowest priority equipment is shut down until demand is stabilized at the limit. Up to 12 variable seasonal peak load limits may be programmed. ■ McQuay Group, McQuay-Perfex, Inc., Minneapolis, Minn.

circle 402 on inquiry card

**PORCELAIN ENAMEL COLLECTORS** / A data sheet briefly describes porcelain enamels and their variety of applications, then discusses the characteristics of these coatings when used on solar collectors. Solar-absorbing properties of different types and thicknesses of porcelain enamel over steel, aluminum and glass are shown on a spectral reflectance curve; these coatings are said to be unaffected by temperatures even when exposed to maximum insulation under no-load conditions. ■ Ferro Corp., Cleveland, Ohio.

circle 403 on inquiry card

**STEEL DOORS** / Included in a 32-page bulletin on a full line of side-hinged steel doors for all markets is a selection chart covering frequency of use and impact probability related to type of building and opening location. Data is given on frame components, operating hardware, UL and FM labeled fire doors, and installation and security features. ■ The Ceco Corp., Chicago, Ill.

circle 404 on inquiry card

**GASKET JOINTS** / A technical data bulletin discusses *Ram-Nek* flexible plastic gaskets for sealing precast concrete manholes, wet wells, and other vertical precast structures. Describing the product's general usage, the data sheet contains estimating tables. ■ K. T. Snyder Co., Inc., Houston, Texas.

circle 405 on inquiry card

**SECURITY DOOR** / The *Diplomat* one-way revolving security door is available with either photoelectric curtain or pressure-sensitive mat controls: any attempt to enter the door in the wrong direction activates the control and locks the door. A color brochure explains how the *Diplomat* door, with three revolving wings instead of four, permits easy passage by wheelchairs or baggage carts; one wing always blocks the way to wrong-way traffic. Doors can handle up to 2000 people an hour. ■ Consolidated Aluminum, Architectural Products Div., St. Louis, Mo.

circle 406 on inquiry card

**LARGE-AREA GLAZING** / An eight-page illustrated booklet gives performance and appearance characteristics of the "EFG" system, which is designed to give full four-sided support for glass installations while retaining the appearance of butt-joint glazing. The method allows large glass panels, including tinted and reflective types, to be arrayed edge-to-edge and supported by "hidden" vertical mullions and head and sill frames. The brochure also describes a computer service to provide "EFG" glazing system recommendations to architects and engineers. ■ PPG Industries, Pittsburgh, Pa.

circle 407 on inquiry card

**URETHANE ROOF SYSTEM** / Guidelines for designing, specifying and installing a roof system insulated with spray-on polyurethane foam are given in an illustrated brochure. Sketches indicate techniques for foaming and coating around eaves, parapets, relief vents, walkways, heated pipes or stacks, and pitch pockets. ■ CPR Div., The Upjohn Co., Torrance, Calif.

circle 408 on inquiry card

**VINYL WALLCOVERING** / Vinyl coated and/or vinyl laminated to cotton fabric, *Guard* wallcoverings have a total weight of 16.0 oz per sq yd, and exceed specifications for Type II CCC-W-408a. A tip card provides samples of the "Djakarta" grass cloth pattern in over 30 natural, bright or muted colors. ■ Columbus Coated Fabrics, Div. Borden Chemical, Columbus, Ohio.

circle 409 on inquiry card

**TRANSLUCENT ROOF SYSTEMS** / An eight-page illustrated catalog insert describes insulating skyroof systems that can provide a number of "U" factors of from .15 to .40 with light transmission values ranging between 3 and 83 per cent. The literature shows installations using *Kalwall* and *Permakal* panels, a sandwich of two fiberglass sheets bonded to a grid core of interlocked structural aluminum I-beams, with or without a fiberglass insert for extra insulation. These components are arranged in various ways to achieve the most efficient balance between natural light transmission, solar heat gain and thermal insulation. ■ Kalwall Corp., Manchester, N.H.

circle 410 on inquiry card

**PARTICLEBOARD** / The *KorPINE* line of particleboard products for furniture and casework is shown in a color brochure. Featured is *Kor Tron/EB*, a new color product with an extremely smooth surface. It comes in 20 solid standard colors, or unlimited custom colors, available on one or both sides of the particleboard. ■ Willamette Industries, Bend, Ore.

circle 411 on inquiry card  
more literature on page 140

To help you specify materials that make the difference...

# FOUR NEW TECHNICAL BULLETINS FREE FROM GOLD BOND

Get all the facts on "what, where, why, and how" of four outstanding Gold Bond products/systems for new construction and remodeling projects. These comprehensive bulletins give up-to-the-minute technical and performance data. Installation instructions. Full-color illustrations. Detail drawings. Components and accessories. Architectural specifications.



Mail the coupon today for your free bulletin

- Please send the Technical Bulletins checked:
- Durasan
  - Acoustical Materials
  - Contempo-Wall
  - Tectum Roof Deck
  - Have a Gold Bond Representative call me.

Name	Title	
Company		
Address	Phone	
City	State	Zip

Mail to: Gold Bond Building Products  
Division of National Gypsum Company  
2580 Walden Avenue, Buffalo, N.Y. 14225



A National Gypsum Company  
For more data, circle 61 on inquiry card



At home anywhere

# Legacy<sup>®</sup>



Hotel



Condominium



Office

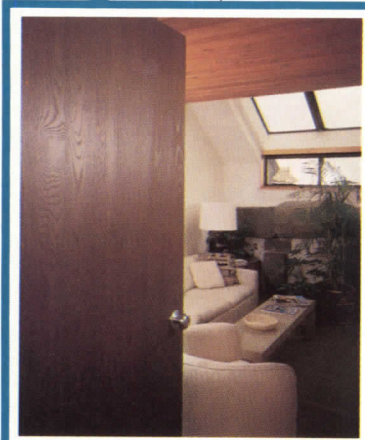

Apartment

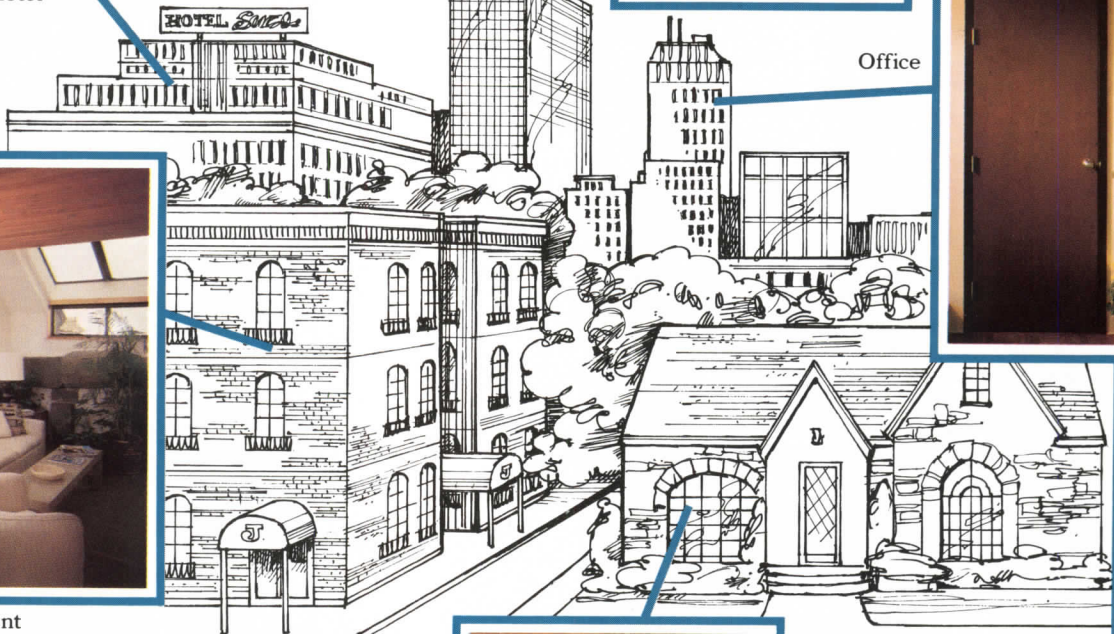

Home



Whether installed in a popular San Francisco hotel or a fashionable Boston apartment complex, Legacy faced doors are at home. Since Masonite Corporation introduced Legacy five years ago, the doors have been installed in thousands of homes, apartments, offices, schools, condominiums—in every type of building where a passageway exists. That kind of endorsement and acceptance has to be earned. And Legacy has done it. Proven its worth by standing up to abuse and wear while maintaining its deeply embossed, pre-finished good looks.

To benefit by this proven reliability, select and install Legacy doors in your building projects. They'll be right at home.

For the names of door manufacturers using Legacy door facings, write Masonite Corporation, 29 North Wacker Drive, Chicago, Illinois 60606.



Legacy and Masonite are registered trademarks of Masonite Corporation

For more data, circle 62 on inquiry card

**SURFACE-MOUNTED LIGHTING** / This indoor-outdoor lighting series includes five basic fixtures, two for incandescent lamping and three for H.I.D. The incandescent fixtures are UL-approved for installation in insulation ceilings; all units carry damp location labels. Sized in 13-, 15-, and 24-in. squares, lamp housings are of aluminum and steel construction; doors and reflectors are easily removed for maintenance. Tempered glass lenses are gasketed to minimize dirt infiltration. ■ ITT Art Metal Lighting, Vermilion, Ohio.

*circle 304 on inquiry card*

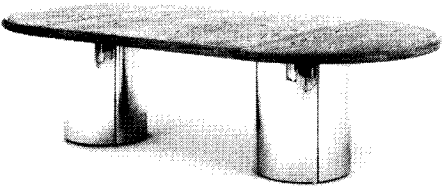

**CONFERENCE TABLE** / The "Racetrack 490" table features 2-in.-dia cylindrical bases which reflect the floor covering on which the table stands for a "floating" effect. Tops are walnut or oak, in 108-, 162-, and 216-in. lengths. Edge treatment is a 2 1/4-in. thick bullnose with a thin recessed outline. Two round tables with a single pedestal base are also available. ■ Mueller Furniture Corp., Grand Rapids, Mich.

*circle 305 on inquiry card*

**PRECAST PANELS** / Lightweight 350 lbs per 8-ft by 5-ft by 21-in. unit panels were used to form part of the curtain wall of this industrial building, one of many suggested applications of this composite building product. A combination of cement, sand, water and alkali-resistant glass fibers, *Cem-Lite* is sprayed into forms to a thickness of about 1/8-in.; it needs no steel reinforcing. Said to have the moldability of plastic and the strength and durability of concrete, it can be used in any shape which can be reasonably formed, including cladding panels, fascia and soffits, street furniture, etc. ■ Beer Precast Concrete Ltd., Scarborough, Ont.

*circle 306 on inquiry card*

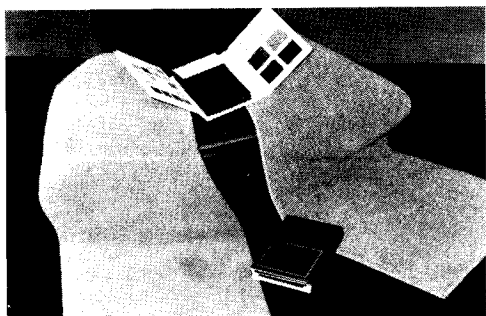

**COMMERCIAL CARPETING** / This color-coordinated line of all-wool carpets consists of three softly rounded arms and cushions; the solid base may be accentuated with burlwood, high-sheen brass, lacquer, fabric or suede. ■ Bel Vivere, Los Angeles, Calif.

*circle 307 on inquiry card*

*more products on page 139*

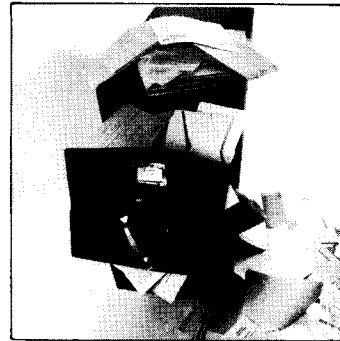

## Your best offense is a loud defense

Business crime in 1976 hit an all-time high of \$44 billion. For security-sensitive companies, that's cause for alarms.

Detex Exit Alarms, we suggest. Choose from surface or flush-mounted styles, battery or AC powered. Installed at doorways, windows, cabinets or cages, they shriek in protest against unauthorized use.

For doors that need to be locked from without, yet opened from inside for

emergencies, a Detex Exit Control Lock is the choice. If its warning legend doesn't scare off violators, the blast of its horns surely will.

These alarm devices can be wired to a Detex Remote Indicating Panel for multi-door monitoring from one location. All are part of a broad line of reliable, low-cost security hardware for entry and exit control, detailed in our omnibus brochure. We're holding your copy.

Detex Corporation • 4147 Ravenswood Ave. • Chicago, IL 60613

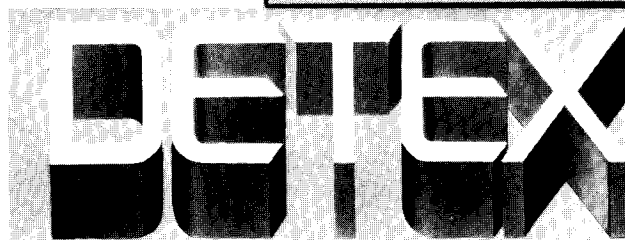
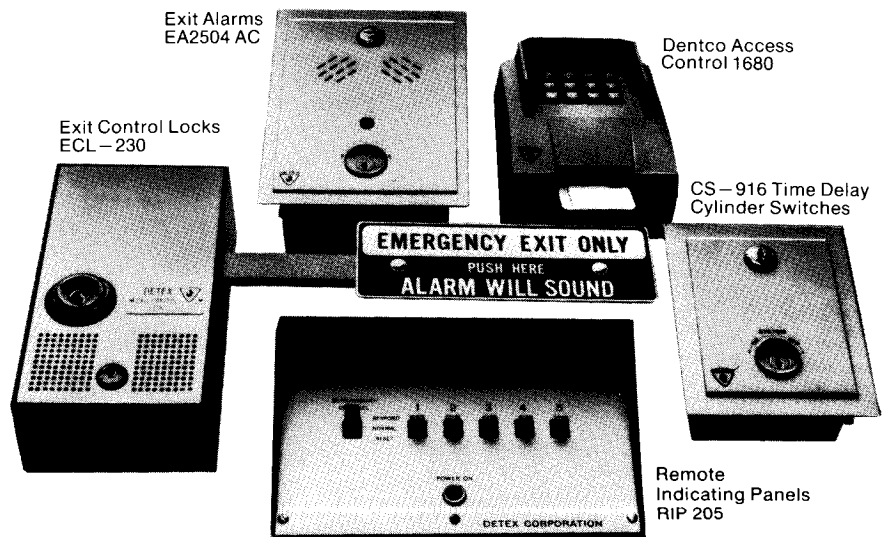

*For more data, circle 63 on inquiry card*



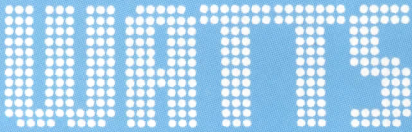

## ENERGY MANAGEMENT VIEWS FROM NECA - THE NATIONAL ELECTRICAL CONTRACTORS ASSOCIATION VOL. II NO. 2

### TASK LIGHTING REDISCOVERED

Because most existing buildings were designed without energy management in mind, their lighting systems may be energy inefficient. With critics claiming that recommended lighting levels were in excess of actual needs, one of the reactions was to reduce illumination levels by removing lamps, under the assumption that energy conservation would result. In a few situations, dramatic reductions in productivity were actually documented as a result of reduced lighting levels. Nor were actual energy savings assured since reduced productivity resulted in more manhours being expended and, with reduced heat of light, more heating energy being required. Consequently, it was seen that the major cause of lighting energy waste was not recommended illumination levels, but lack of efficiency in lighting systems.

To be fair to designers, it must be recognized that until the advent of today's technology, very little could be done to insure adequate lighting without making many assumptions about eventual space allocations and task assignments. So, the accepted practice was to design a uniform lighting system that met the worst case assumptions about the space and its occupants. Lack of information about work stations made non-uniform task lighting virtually impossible. And because interior space is frequently rearranged, a fixed non-uniform task lighting system would have been impractical. Although these adverse design conditions are still prevalent, major illumination breakthroughs have been made in the last few years due to responses from lighting and wiring suppliers.

One of the more startling developments involves energy efficient lamps. In many cases, existing luminaires can be refitted with new lamps that can save up to half the energy used while producing comparable or even more illumination than those they replace. Other major developments include luminaires and overhead modular wiring systems. Some of these new systems now make it practical to install a lighting system that can be relocated easily by qualified electrical contractors. These new systems provide several energy related benefits.

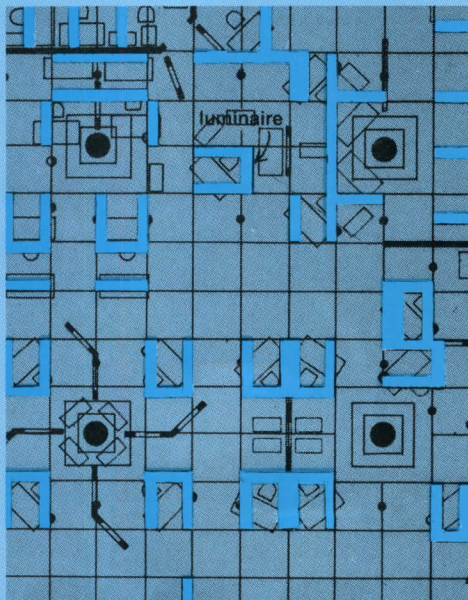

*First*, interior space utilization becomes more flexible, making it possible to rearrange an entire floor by rearranging partitions and desks while insuring that each task continues to receive the quality and quantity of illumination it requires. This means continuity of productivity with elimination or reduction of energy waste. *Second*, it now is possible to minimize design time by specifying a lighting system whose luminaires will be positioned only after the office

layout is established. As a result, lighting systems can be more finely tuned to minimize overall lighting energy consumption. Reductions of up to 50% in electrical watts per square foot of lighting space are possible. *Third*, because of relocatable features of the new flexible, modular, overhead wiring schemes, installation costs are minimized, and electrical contractors can more readily move luminaires from place to place when required. *Fourth*, these new systems make maintenance far easier. Luminaires are more accessible. Should there be a malfunction, repairs or replacements are simplified and the time saved is directly reflected in operating cost reductions.

Nor are new luminaires and wiring systems all that are involved. Significant new developments in lighting system design technology help designers and electrical contractors insure that both the quality and quantity of illumination are adequate for the tasks, and the people performing the tasks. For advice or consultation on practical applications, installation and maintenance factors, contact a qualified electrical contractor. For more information you may write on your letterhead for a free copy of the NECA publication titled, "Task Lighting Considerations." Send your request to the address below.

The National Electrical Contractors Association, Dept. G078, 7315 Wisconsin Ave., Washington, D.C. 20014.



WHEN YOU PLAN  
FOR ELECTRICITY, PLAN  
WITH A PROFESSIONAL.

**INTERMEDIATE LEVEL SPRINKLER** / Said to be an efficient and economic solution to multi-level fire protection, especially in rack storage applications, the "ILD" has a single shield plate protecting its fusible element from water emitted by sprinklers operating above it. Available in pendent and upright versions, the "ILD" has fusing temperatures of 165F, 212F, and 280F with orifice sizes of either 1/2 or 17/32-in. Sprinkler head is UL-listed and FM approved. ■ The Grunau Sprinkler Mfg. Div., South Milwaukee, Wis.

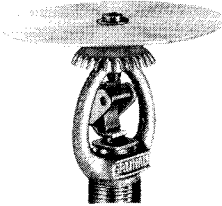

circle 308 on inquiry card

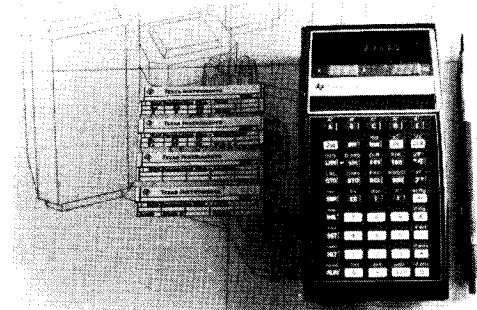

**PERSPECTIVE DRAWING** / Photographically accurate perspectives may be drawn of any object, from any viewpoint, using the "Perspective Plus" program in Texas Instruments' hand-held programmable calculator. The method does not require vanishing points, computers or model-building to achieve distortion-free three-point drawings. After entering information about the observer's line of sight, and the location of points on the object, the programmed calculator displays the X-Y position of each point in the perspective. "Perspective Plus" programs come with operating instructions, sample perspectives and examples, and are priced at \$29.95. ■ Mobius Design, Boulder, Colo.

circle 309 on inquiry card

**REFLECTOR LAMP** / With an elliptical shape designed to extend the light farther from the face of the bulb before the illumination fans out into its flood pattern, the 75-watt bulb shown on the right in photo produces as much usable light in recessed fixtures as the standard 150-watt flood lamp, with significant energy savings. The "ER30" bulb has an average rated life of 2000 hours; suggested list price is \$3.65. ■ Westinghouse Electric Corp., Bloomfield, N.J.

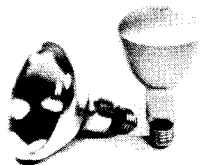

circle 310 on inquiry card

**REDUCED WATTAGE FLUORESCENT** / Producing 100 lumens per watt, the 60-watt, 8-ft slimline fluorescent lamp represents a substantial energy savings over standard cool white lamps. The "Watt Miser II Slimline" fluorescent is recommended for operation on single-lamp and two-lamp indoor lead circuit, high-power factor ballasts in ambient temperatures of 60 deg F or higher. ■ General Electric Co., Nela Park, Cleveland, Ohio.

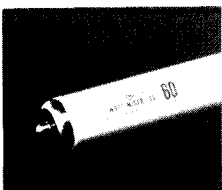

circle 311 on inquiry card

more products on page 143

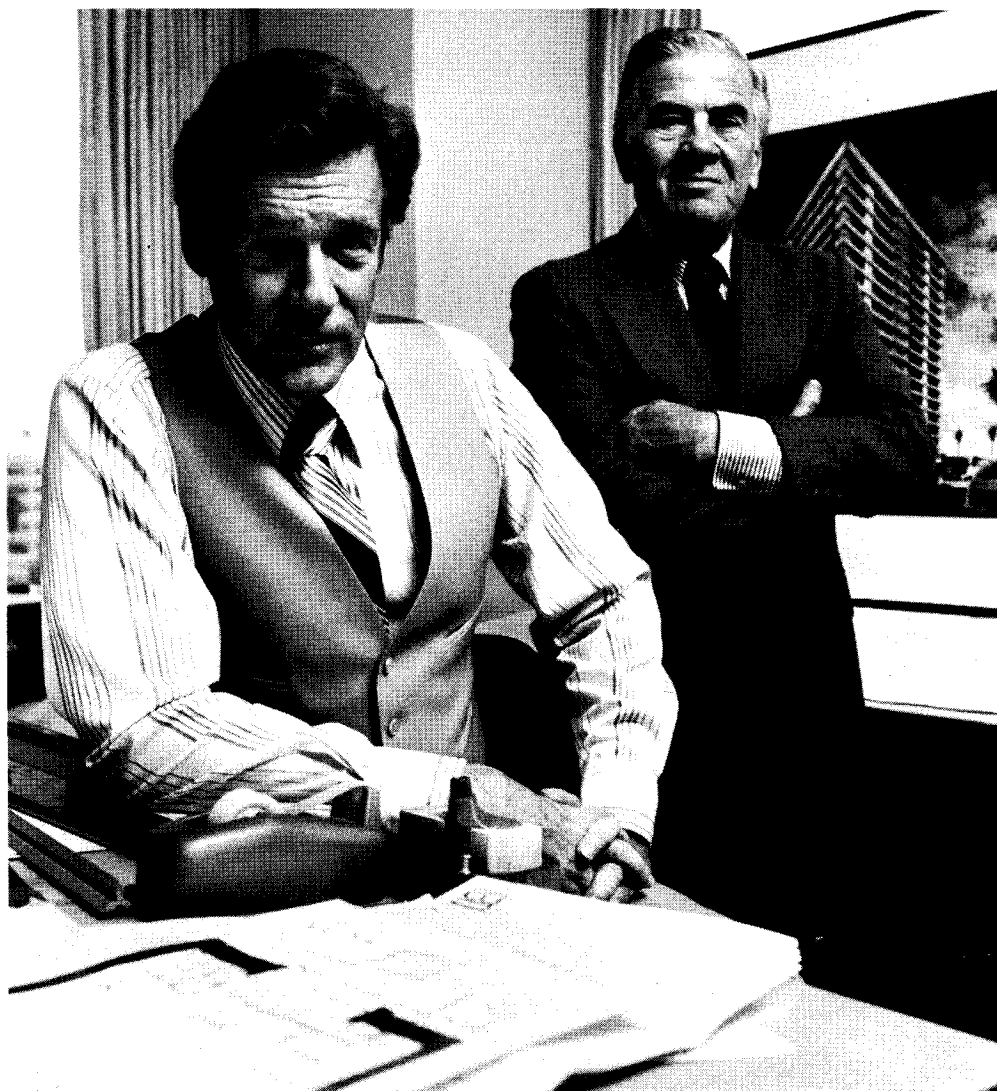

## "I went for design. He went for cost. We both went for powder dispensers."

As the designer of this building, I had two things to consider when I chose the soap dispensers for the washrooms. Cost and design. The building owner asked if there wasn't an alternative to liquid soap. He said the dispensers always clogged or leaked. He also mentioned there was more waste with liquid soap—and the dispensers always seemed to need refilling.

I suggested we try a fine-powdered soap. Specifically MD\*7. It's not gritty like an industrial powdered soap, so it is perfect for the washrooms in an office building. Still MD\*7 gets hands really clean, is gentle, and won't irritate normal skin. We decided to go with powdered soap. And with all the different styles in soap dispensers I found one that was perfect for the design of the washrooms.

I'll be installing powder dispensers and MD\*7 in all the buildings I design. And for good reasons. They please my eye, the tenant's hands, and my client's budget. Who says you can't please everyone?

For further information see Sweet's Catalog 10.16 Un.

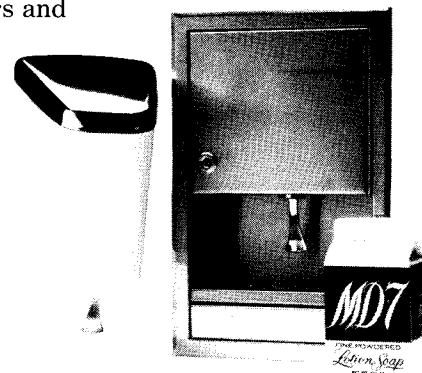

**US BORAX**  
A MEMBER OF THE RTZ GROUP  
3075 Wilshire Blvd., Los Angeles, CA 90010.

For more data, circle 64 on inquiry card

**SUN CONTROL DEVICES** / Said to offer an attractive solution to the problem of solar shading that is more effective than reflective glass, this sun control line includes octilinear grilles, fixed sunshades, demi-fins, airfoil sunshades, and sun curtains. A 12-page technical brochure gives installation details and photographs, and describes the variety of available finishes. ■ Construction Specialties, Inc., Cranford, N.J.

*circle 412 on inquiry card*

**AUTOMATIC ENTRANCES** / Electric-, pneumatic-, and hydraulically-operated automatic entrances are presented in a product literature packet. Among the safety features built into these swinging and sliding entrances is the "Multi-scan Optical-Electronic" sensor, which responds to presence as well as motion to reduce the possibility of a door striking someone who stops moving. Information sheets describe standard door types, electrical requirements, mat dimensions, guard rails, frame details, cart bumpers, and push-pull hardware. ■ Kawneer Architectural Products, Niles, Mich.

*circle 413 on inquiry card*

**STEEL DECKS** / Three technical sales catalog include revised product information and load tables for steel roof decks, composite floor decks, and *Tensiform/Tensilvent* floor decks. ■ Wheeling-Pittsburgh Steel Corp., Pittsburgh, Pa.

*circle 414 on inquiry card*

**WOOD PRODUCTS MANUAL** / Introductory copies of "TheWoodBook" are available free to qualified professionals involved in using wood products in residential and commercial construction. The 234-page casebound volume includes design and specification information on materials for floors, walls and roofs, plus information on treated wood, foundations, heavy timber construction, laminated beams, shingles, shakes, softwood paneling and siding. "TheWoodBook" has been published by Wood Products Publications based on information and research supplied by the major wood products associations and companies in the U.S. and Canada; data is arranged according to the UCI, and will be updated annually. ■ Wood Products Publications, Tacoma, Wash.

*circle 415 on inquiry card*

**LIFE-SAFETY SYSTEM** / The *Life-Alarm* system incorporates a series of modules which enable the user to combine a wide range of features in a single, field-programmable unit for commercial, industrial, institutional and multi-unit residential facilities. An illustrated brochure shows how the *Life-Alarm* solid-state system can be designed to perform any or all of these functions: sound an alarm; notify police, fire and/or other authorities; send elevators to the ground floor; turn on sprinklers in affected areas; control ventilation systems; close fire doors; shut down equipment; and provide voice and/or phone communication. ■ Simplex Time Recorder Co., Gardner, Mass.

*circle 416 on inquiry card*

**SPLIT-SYSTEM COOLING** / Product data sheets introduce a line of condensing units of from 17,500 to 35,500 Btu/hr said to provide economical split-system air conditioning for residential and small commercial buildings. The compressor is enclosed in a separate compartment for noise reduction and ease of service; units have a direct drive, non-overloading propeller-type fan with a prelubricated ball bearing motor. ■ Westinghouse Central Residential Air Conditioning Div., Norman, Okla.

*circle 417 on inquiry card*

**REINFORCED GYPSUM CEILINGS** / An illustrated brochure explains how the *Zerodec* molded gypsum ceiling system allows the designer to develop a ceiling to fit individual functional and decorative requirements. *Zerodec* panels are 1/8-in.-thick, even in large shapes and forms, and can accommodate sprinklers, public address systems, lighting and ventilation fixtures, etc. Physical property and test data are given. ■ Zerodec of New England, North Reading, Mass.

*circle 418 on inquiry card*

**MICROFILM READERS** / Product literature describes three portable easy-to-operate microfilm readers for school, library, hospital and office use. The lightest (1 lb 5 oz) unit is the "3529" microfiche reader, which can be operated from a battery or automobile cigarette lighter for versatile in-field use with good image brightness and resolution; the "3529" retails for \$99. ■ Océ-Industries Inc., Chicago, Ill.

*circle 419 on inquiry card*

**ELECTROSTATIC OFFSET** / A new line of electrostatic offset masters, said to offer sharper, clearer quality copies at reduced cost, is described in an illustrated brochure. The literature explains how a visual computerized system used in the manufacture of the coated master paper assures absolute uniformity of coating weight; roll stock for the line ranges from 9-in. by 500-ft to 12-in. by 500 ft. ■ A. B. Dick Co., Chicago, Ill.

*circle 420 on inquiry card*

**ROOF INSULATION** / "The Energy Efficient Roof" features color-coded maps of the U.S. which show an economic insulating value to use in each region of the country. These values—three for reroofing and two for new construction—have been computer-researched to give maximum return in energy savings, and are matched with the thickness of *Fiberglas* insulation required to achieve them. ■ Owens-Corning Fiberglas Corp., Toledo, Ohio.

*circle 421 on inquiry card*



IT'S YOUR BUSINESS,  
YOUR CLIENT,  
YOUR REPUTATION.



**SPECIFY  
ELKAY.**



Like Elkay Stainless Steel Sinks, Elkay Water Coolers are the finest money can buy. But then, that's what you'd expect

from a company with a 50 year reputation for dependability and superiority. Send for our latest catalog today

**Elkay versus the ordinary. There's no comparison.**

**ELKAY**

MANUFACTURING COMPANY  
2700 South Seventeenth Avenue  
Broadview, Illinois 60153 Department 32-20

**ALUMINUM COMPOSITE SHEET** / A little more than half the weight of aluminum sheet and easy to fabricate, *Alucobond* sheet is a sandwich of two .020-in. aluminum layers surrounding a polyethylene insulating core of variable thickness. A color booklet shows how *Alucobond* can be used on building exteriors, on interior ceilings and walls, and for signage and displays. Physical property information is given in the literature. ■ Consolidated Aluminum Corp., St. Louis, Mo.

circle 422 on inquiry card

**BUILDING SYSTEMS** / An energy conservation brochure illustrates ways this manufacturer's building system can save on long-range heating and cooling costs, as well as initial equipment investment. Graphs compare the thermal efficiency of various building materials, and demonstrate the savings possible in industrial, commercial and other building construction. ■ Atlantic Building Systems, Inc., Atlanta, Ga.

circle 423 on inquiry card

**TRANSLUCENT WALL SYSTEMS** / An illustrated catalog insert provides complete technical and test data on *Kalwall*, *Permakal* and *Sunwall* insulating light transmitting wall systems for interior and exterior use, window replacement, and active or passive solar collector installations. ■ Kalwall Corp., Manchester, N.H.

circle 424 on inquiry card

**PERSONAL-SIZE DESK** / Described by the manufacturer as combining economy of price with an attractive wood-grain or color finish, the *NorcoLine* personal-size desk for home or office is constructed of high-impact laminated plastic and stands on wobble-free side panels. Drawers are mounted on a ball-bearing suspension system; all corners are rounded for safety and protected with plastic T-edging. Overall size of the desk is 24- by 42- by 29½-in. high; it is shipped fully set up. ■ Norco Mfg. Corp., Missoula, Mont.

circle 425 on inquiry card

**CHAIN LINK FENCE** / "Galva-Fused" fence fabric has an outer vinyl layer permanently fused to a galvanized metal core for improved corrosion resistance. A four-page brochure includes illustrations of all colors, and gives technical specifications on available fabric sizes and gauges for industrial, commercial, recreational and government fence applications. ■ Allied Tube and Conduit Corp., Harvey, Ill.

circle 426 on inquiry card

**REPLACEMENT WINDOW** / Product data sheets describe a thermalized slider replacement window designed to insulate the metal sash frames without a conventional thermal break: frames recess completely into, and are totally covered by, the insulated master frame. The slider window is available in residential and commercial models, both with a positive-locking latch for security. ■ Season-all Industries, Inc., Indiana, Pa. 15701

circle 427 on inquiry card

**HOT WATER GENERATOR** / An accessory package for use on water source heat pumps and remote air cooled condensing units and heat pumps in the capacity range of 18,000 to 52,000 Btu/hr, the "DHW2G1" hot water generator provides free heating of domestic hot water during both heating and cooling cycles. A product brochure outlines the system, and explains how the *TwinEx* heat exchanger, which eliminates contamination of domestic water with refrigerant or oil, reclaims heat from the compression of the refrigerant. The hot water generator is designed for original or add-on use in residential, apartment and commercial applications; it interconnects with the storage type gas or electric hot water heater and can produce up to 100 per cent of the hot water requirements, depending on the amount of running time of the compressor. ■ Friedrich Air Conditioning & Refrigeration Co., San Antonio, Texas.

circle 428 on inquiry card

**LOAD MANAGEMENT SYSTEM** / The *Energy Programmer* provides the owners of all-electric homes with an automatic load management system which can substantially reduce electric power costs. The *Programmer* controls electrical demand patterns up to a present maximum demand level. When this is reached, the control will switch off the heating or cooling system in one or more areas of the home to compensate, and rotate this load cutoff throughout the home. This permits electric power use to be spread out throughout the day, qualifying the consumer for demand rate billing where applicable. ■ Phillips Control Corp., Englewood, Col.

circle 429 on inquiry card

**CONCRETE REINFORCING** / The 1978 Edition of the Concrete Reinforcing Steel Institute *Handbook* conforms to the new notations and format of the 1977 ACI Building Code. It also has been expanded by a 150-page chapter on beam design, which presents complete designs for the usual range of beam sizes and uniform load capacities for the applicable range of spans for each. Other new material includes tables for selection of maximum permissible bar size to satisfy all Code requirements for development with no calculations. Tables also are used to provide "automatic answers" to the maximum number of bars that can be fitted into a beam stem within Code cover and clearance requirements; minimum number that Code crack-control provisions require; and minimum spans for development of each size bar using various typical details for bar cut-offs. The CRSI *Handbook* is available at \$27.00 a copy from Concrete Reinforcing Steel Institute, 180 North LaSalle St., Chicago, Illinois. 60601.

circle 430 on inquiry card

## IF YOU'RE NOT USING ELKAY WATER COOLERS, LOOK AT WHAT YOU'RE MISSING:

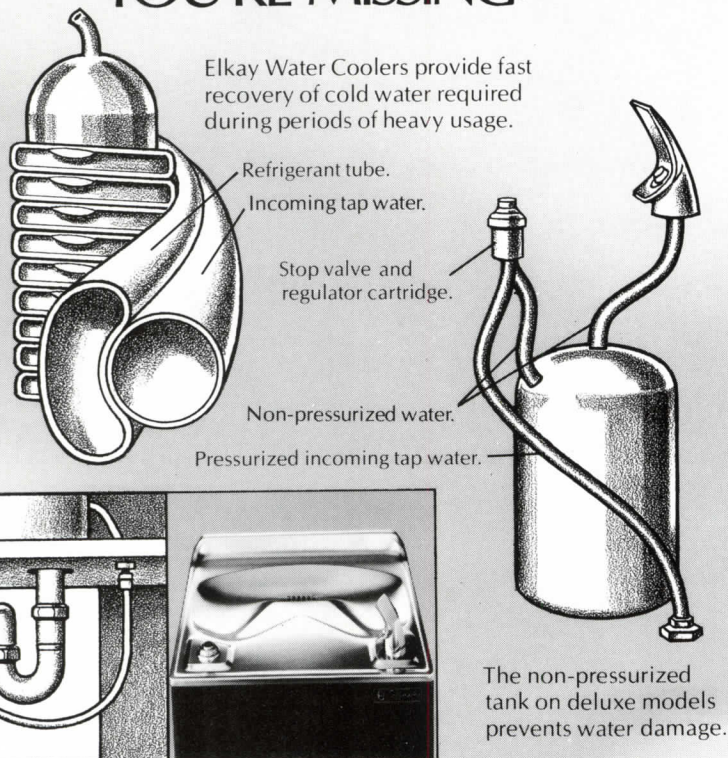

Elkay Water Coolers provide fast recovery of cold water required during periods of heavy usage.

Refrigerant tube.  
Incoming tap water.

Stop valve and regulator cartridge.

Non-pressurized water.

Pressurized incoming tap water.

The non-pressurized tank on deluxe models prevents water damage.

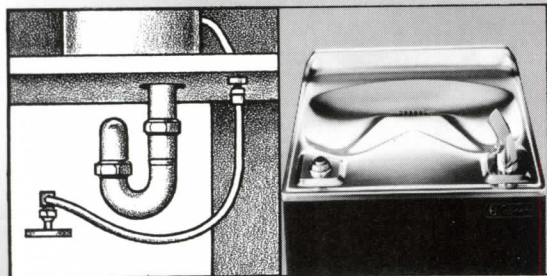

Unobstructed connections and center drain make installation and drain cleaning quick and easy.

The Elkay exclusive Cascade Basin prevents splashing. The strainer is built right into the basin so it can't be vandalized.

**Elkay versus the ordinary. There's no comparison.**

**ELKAY®**

MANUFACTURING COMPANY  
2700 South Seventeenth Avenue  
Broadview, Illinois 60153 Department 33-20

For more data, circle 65 on inquiry card

# Glass can put a building in great shape for the future.

Thanks to the energy crisis, you're probably giving a lot of today's building materials a second look.

The facts on glass may surprise you. In many buildings, large window areas are actually helping conserve energy. Through the proper use of daylighting and reduced artificial lighting, energy consumption can be cut.

Building owners are also finding that windows not only give office employees a better outlook on their world, but on their work. Studies have shown that worker performance levels and the amount of window area in the work environment often go hand in hand.

Want details? Send for "Predicting Daylight as Interior Illumination," a 43-page definitive study on building design to conserve energy and increase visual performance.

Libbey-Owens-Ford Company, 811 Madison Ave., Toledo, Ohio 43695. Or contact your LOF architectural representative for an Energy Savings Analysis.

*For more data, circle 66 on inquiry card*

General American Life National Headquarters, St. Louis, Mo.  
Architects: Johnson/Burgee, New York.

# LOF

**SOLAR HEAT EXCHANGER** / The *Sunerator* solar systemizer transfers heat from solar collectors to a storage tank; a large heat transfer surface is said to promote high efficiency levels in the unit. Collector loop flow is variable by means of a two-speed pump motor; the integral *Solarlogic* automatic temperature control has adjustable turn-on turn-off setpoints. Compatible components of heat exchanger and other hydronic specialties are completely assembled pre-piped and wired, ready for installation. ■ Solar Energy Systems, Inc., Cherry Hill, N.J.

*circle 312 on inquiry card*

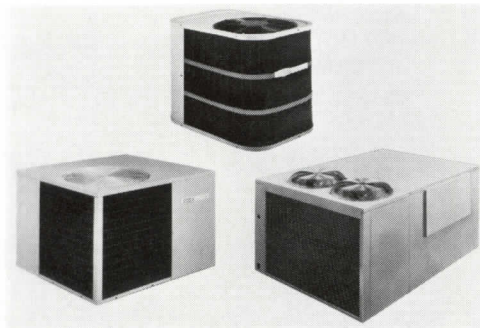

**HEAT PUMPS** / Packaged heat pumps for commercial and residential applications, as well as a residential split systems series, have been designed to exceed all current local and national energy efficient requirements for both cooling and heating operations. New features include a "Check-Flo-Rater" refrigerant meter, which eliminates the serviceability requirements of check valves and conventional expansion devices, and an optional wall thermostat with an emergency heat switch. Energy efficiency ratings range up to 8.5; all capacity units are said to operate quietly at a SRN of 19 or 20. ■ Bryant Air Conditioning, Indianapolis, Ind.

*circle 313 on inquiry card*

**STONE PANELING** / For interior use, even over old walls, these decorative panels give an appearance of natural stone to an accent wall. Made from 60 per cent crushed stone and reinforced with fiberglass, the panels are available in white, gray and buff tones. ■ Marlite Div., Masonite Corp., Dover, Ohio

*circle 314 on inquiry card*

**WASHER/EXTRACTOR** / Intended for economical operation in hotels, motels, nursing homes, etc., the compact "Model 130" washer/extractor/conditioner needs only limited floor space. A built-in vibration isolator eliminates the need for special foundation construction, and allows the unit to be installed on upper floors. An automated control system pre-programs all washing, extracting and conditioning cycles without an operator's attention; the 44-in.-dia stainless steel cylinder can handle process loads of 130 lbs per cycle. ■ G.A. Braun, Inc., Syracuse, N.Y.

*circle 315 on inquiry card*

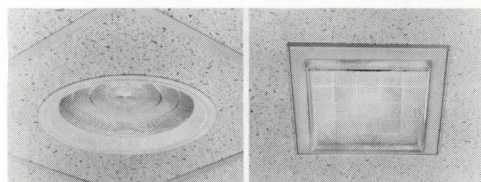

**RECESSED FIXTURES** / High-pressure sodium lamps can now be used in these PAL (positive automatic latching) luminaires, as well as the variety of wattages in metal halide, mercury, and incandescent lamps previously offered. Two basic luminaire shapes—round and square—are available with prismatic *Controlens* in several different contours. Pressing on the lens swings the hinged door down for easy maintenance. The fixtures can carry a UL Dump Location label, making them suitable for outdoor applications under canopies, etc. as well as for interior use. ■ Holophane Div., Johns-Manville Sales Corp., Denver, Colo.

*circle 316 on inquiry card*

**EMERGENCY GENERATOR** / Up to 30 KW of standby electric power for hospitals, industrial plants, etc., is supplied by a four-cycle six-cylinder inline engine, which can be operated on gasoline, propane, or natural gas. The brushless generator is designed for minimum reactance and low voltage wave form distortion; the set can operate in 110 F ambient conditions without overheating. The lightweight, unboxed frame permits the vibration-isolated control console to be mounted on the left, right, or generator end of the frame as shown for greater installation versatility. Optional side and roof panels convert the set to a weatherproof housed unit. ■ Onan Div., Onan Corp., Minneapolis, Minn.

*circle 317 on inquiry card*

*more products on page 145*

## Outstanding protection for quality merchandise. All-weather Crete insulates the Neiman-Marcus store in Houston.

Neiman-Marcus is truly a quality name in retail merchandising. Hellmuth, Obata & Kassabaum, Inc. have designed the new Houston store in keeping with this reputation. All-weather Crete insulation is used in the roof deck and offers not only the finest in thermal protection, but a real money-saving value in long range cost savings. All-weather Crete can be sloped to drains for positive water drainage. Its application by local licensed applicators assures experienced installation on every building. Dry application with no curing time speeds roofing and construction. These and many other unique features make All-weather Crete truly the quality name in insulation for roof decks, plazas and numerous other constructions. It's no wonder All-weather Crete was selected to protect an architectural achievement such as the Neiman-Marcus building. For complete information, contact Silbrico Corporation, 6300 River Road, Hodgkins, Illinois 60525, (312) 735-3322, or see Sweets for the address of your local applicator.



Neiman-Marcus Store, Houston • Hellmuth, Obata & Kassabaum, Inc., Architects • Photo, Ezra Stoller Associates, Inc.



*For more data, circle 67 on inquiry card*

This relatively simple but superbly designed bank is a striking example of the manner in which *Terne* roofing can become an integral part of a total architectural concept.

Aesthetics aside however, *Terne* also has certain outstanding functional characteristics. Among these are great tensile strength combined with light weight and a low coefficient of expansion; exceptional resistance to corrosive attack, and a durability measured in generations rather than years.

*Terne* roofs are also relatively inexpensive when judged by the standards of those to whom ultimate performance is no less significant than initial cost.

Citizens' Bank, N.A., Readington Township, New Jersey  
Finne · Lyman · Finne · Reese,  
Architects-Engineers, Elizabeth, New Jersey  
Roofers: J. Strober and Sons, Ringoes, New Jersey  
Photographs by Otto Baitz

# FOLLANSBEE

FOLLANSBEE STEEL CORPORATION • FOLLANSBEE, WEST VIRGINIA



# WHAT PRICE FORM, COLOR, FUNCTION?

**ELECTROPHOTOGRAPHIC COPIER** / This table-top unit makes hard copies of any image displayed on a cathode ray screen with the push of a button. High-resolution black and white copies are produced in six seconds, capturing all alphanumeric and graphic detail, and printing it in black on a white background. The copier may be used with any CRT terminal supplying a standard video signal, and a single copier may be used with a group of terminals. No software is required for operation; recording costs run less than 2 cents per copy. ■ Photophysics, Mountain View, Calif.

circle 318 on inquiry card

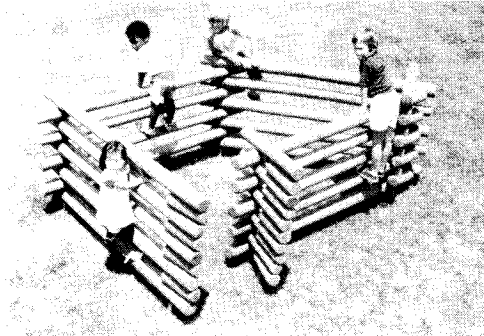

**PLAY ENVIRONMENT** / Climbing and make-believe play are encouraged by the "Log Corral," an open-walled structure built from 4-in.-dia logs. The wood is sanded and finished in weather-resistant natural oils; the play climber stands 4-ft high and occupies a 6-ft 4-in. by 6-ft area. ■ PlayLearn Products, Long Island City, N.Y.

circle 319 on inquiry card

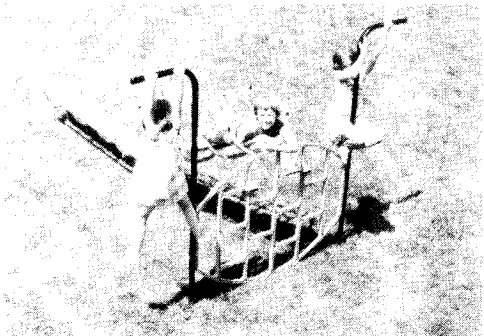

**ALUMINUM CLIMBER** / Extremely abuse-resistant and maintenance-free, the "Caterpillar" play structure can accommodate as many as eight children on its bilateral climbing grille and through its crawl-and-slide open tunnel. Climber is about six-ft long, and is finished in earth tone colors. ■ Playscape Products, Long Island City, N.Y.

circle 320 on inquiry card

**FURNACE FLUE DAMPER** / The "Sentinel" retrofit damper for gas-fired home furnaces provides automatic closure of the chimney when the heating plant is not operating, to prevent loss of heated air. Made of non-corrosive materials, with a full-power high torque drive for long use, the stack-mounted damper is UL-listed and meets ANSI Z21.66 requirements for gas equipment. Fuel savings of up to 30 per cent are claimed for the automatic damper. ■ Trionic Industries, Inc., Harrisburg, Pa.

circle 321 on inquiry card

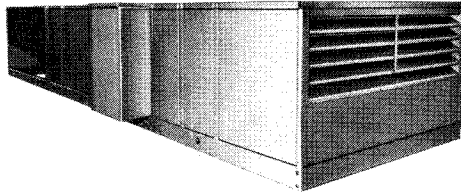
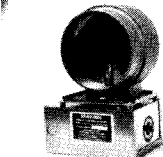

**SUPERMARKET HVAC** / Designed specifically for original or retrofit use in supermarkets, this hvac system is offered in a single energy efficient package said to provide operational economics and reduced first cost. The unit removes moisture from the required outside air before it enters the store, reducing frost buildup on freezer coils. The conditioned dry air is heated to the required comfort level, using heat from the refrigeration compressors; no auxiliary heaters are required. ■ McQuay-Perflex, Inc., Minneapolis, Minn.

circle 322 on inquiry card

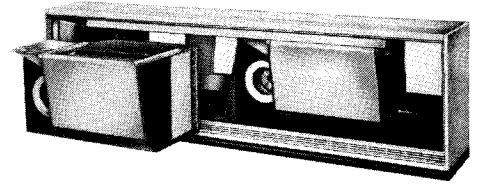

**MODULAR HVAC** / Designed for a number of perimeter or interior air-conditioning applications, particularly where central station fan coil-, induction-, or unit ventilators have been used in the past, the dual-compressor model shown is one of a new line of energy efficient, self-contained air-conditioning units and heat pumps. Only one compressor is activated with the initial demand for cooling or reverse cycle heating; the second compressor is brought on line only when conditions in the space demand it. Refrigeration and heat pump chassis slide out for quick maintenance. ■ ITT Nesbitt, Philadelphia, Pa.

circle 323 on inquiry card

# Granite.

## Not-so-pedestrian plazas for pedestrians.



Architect: Joe Karr & Associates, Chicago, IL  
Sturr Young, Associate Architect, Oak Park, IL



Architect: Murphy Levy Wurman, Philadelphia, PA  
Project Architect: Vincent Maiello, Philadelphia, PA

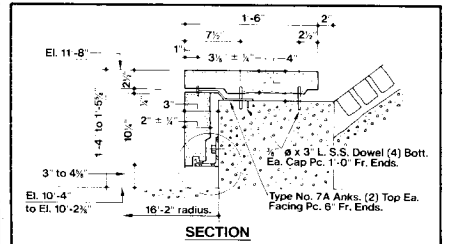
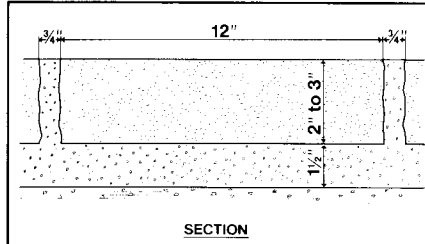

Granite is the elite paving material for plazas, walkways and mall areas where a combination of beauty, durability and ease of maintenance is required.

Granite is a natural building material and it naturally complements the landscaping portions of your architectural design. A wide selection of features including fountains and seating areas are available to enhance the overall appearance of your project. For more information, plus a packet of full color literature illustrating our products in use, call toll free **800-328-7038**. In Minnesota, call (612) 685-3621 or write to the address below.

**Cold Spring Granite Company**, Dept. AR-7 202 South 3rd Avenue, Cold Spring, MN 56320

For more data, circle 69 on inquiry card







# BFGoodrich vinyl wallcovering. The exclusive choice of Marina City.

When Marina City Corporation converted their Chicago landmark into condominiums, they wanted a wallcovering with exciting color and design, plus maximum durability.

BFGoodrich was their exclusive choice.

## High durability. Low maintenance.

BFG fabric-backed vinyl wallcovering offered Marina City the ideal solution for major renovation. Older walls were transformed into dramatic new environments, long-lasting and easy to maintain. Costly repainting was virtually eliminated.

## Wide choice of colors and designs and weights.

Marina City didn't need several sources, because BFG had everything they were looking for. The perfect combination of colors, designs, textures and weights for coordinating every floor of the 61 story complex.

## Koroseal® for heavy traffic.

Koroseal premium grade wallcoverings provide long-lasting protection for Marina City's corridors, elevators, lobbies, entrance ways. Even the central shopping plaza.

Over 32 patterns to choose from. Deeply drawn textures. Soft natural colors. And many patterns are available with Tedlar\* coating for added cleanability.

## Korolite™ for economy.

In the sales office, BFG's lighter weight Korolite was ideal. Over 23 deeply textured patterns and 222 beautiful colors. Tough protection for moderate traffic.

## Specify quality and service.

Specify BFGoodrich. The name that assures the highest in quality. Select from our many swatch books, or work with us on a custom design basis. Check Sweet's for your nearest BFG distributor, or write: The BFGoodrich Company, General Products Division, Decorative Products, 500 South Main Street, Akron, Ohio 44318.

\*DuPont registered TM



**BFGoodrich**  
Decorative Products

For more data, circle 70 on inquiry card

# AZTEC

45 Aztec low temperature electric radiant ceiling panels used for perimeter heat, combine with a variable air volume system to *save energy* and increase comfort in the Huffman District Office of Alabama Power Company in Birmingham.

Aztec heaters specified are 500 and 700 watt 2'x4' T-bar panels.

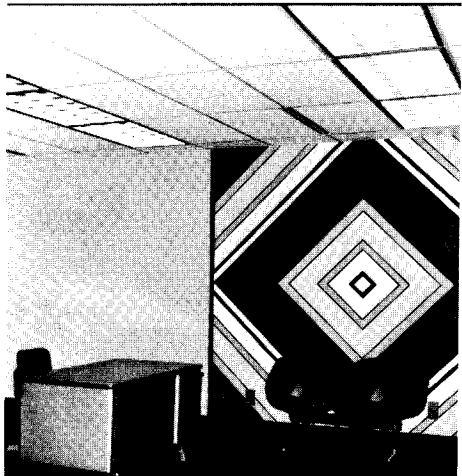
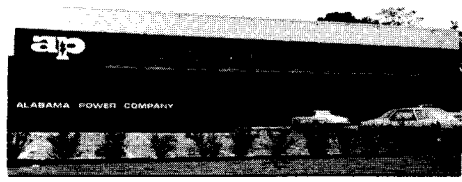

Davis, Speake & Associates, Inc.  
Architects  
Birmingham, Alabama

Miller & Weaver  
Consulting Engineers  
Birmingham, Alabama

The Pacer Company  
631 S. 31st. Street  
Birmingham, Alabama 35233  
Aztec Engineering Representative

Aztec panels have a patented crystalline surface. A superior graphite element assures uniform heat across the panel. No moving parts. No maintenance. 10 year limited warranty.

For more information on Aztec electric heating panels or for the Aztec engineering representative nearest you, call or write to:

**Aztech International Ltd.**  
3434 Girard N.E., Albuquerque, N.M. 87107  
505-345-5631  
TOLL FREE 800-545-8306

For more data, circle 71 on inquiry card

Frank G. Battipede has joined the firm of Jack L. Gordon, Architects, as an associate.

Haines Lundberg Waehler has formed the HLW Planning Partnership, and Stuart Pertz has joined the organization as partner-in-charge.

The Hastings Group has announced the addition of Norman J. Johnston as partner in the firm.

Howard Needles Tammen & Bergendoff recently appointed three new associates. They are: Ralph E. Robison, Harry D. Bertossa, and Lloyd H. Bakan.

W. Byron Ireland Inc. has appointed Kenneth J. Mlicki as vice president.

The principals of Johnson Hotvedt DiNisco & Associates, Inc. have separated. E. Verner Johnson will continue practice with George Adler and Joanne C. Horgan as principals under the firm name of E. Verner Johnson and Associates, Inc.

Donald A. Wahl and Dennis G. Ward have been appointed as principals with Locke Wright Foster Inc.

Anthony O'Keefe is the new president and chief executive officer of Neptune & Thomas Associates.

The firm of Richard J. Passantino, Architects, has named Volker Zinser as an associate.

Peter Cole has joined the Pearce Corporation.

Perkins & Will has named Frank Eliseo as vice president and partner, replacing David L. Ginsberg, who will be executive vice president of health planning. The firm has also named Emily Malino as vice president of interior design services for the firm's eastern offices.

Reid & Tarics Associates have announced that Jean Coria, Jim Fong, Mark Hornberger, and Douglas Way have been named associates.

Dale E. Selzer Associates, Inc. has changed its name to Selzer Associates, Inc./Selzer-Volk-Sayers-Borne. The firm has appointed Paul C. Sayers as vice president and Michael E. Borne as vice president and secretary.

Snell Environmental Group, Inc. has announced the promotions of two staff members. Philip Braswell has been named a project manager and Carl Kern III has been named manager of the firm's landscape architecture division.

Stanley Consultants, Inc., Southeastern Division has appointed Brian P. Richardson head of the process and utilities department. James A. Rumpfelt has also been appointed head of the graphics department with the firm.

The board of directors of Stone, Marraccini and Patterson has elected Dean L. Folker as president of the firm. Folker succeeds Norman W. Patterson, who becomes chairman of the board. The directors also confirmed the appointments of George A. Agron as executive vice president of corporate development, and Robert J. Bettencourt as executive vice president of operations.

## New addresses

Book, Forster & Associates, Ltd., has moved to new offices at 201-6151 Westminster Highway, Richmond, British Columbia, Canada.

Henry J. Campbell Associates announces that the firm's office is now located at 50 Clinton Street, Hempstead, New York.

Ireland/Associates has changed its name and address to W. Byron Ireland FAIA Incorporated, 3070 Riverside Drive, Columbus, Ohio.

The offices of William G. Wells & Associates have been moved to 3200 Brandon Avenue, Southwest, Roanoke, Virginia.

For more data, circle 72 on inquiry card

# We have a lot of ways to greet wet hands.

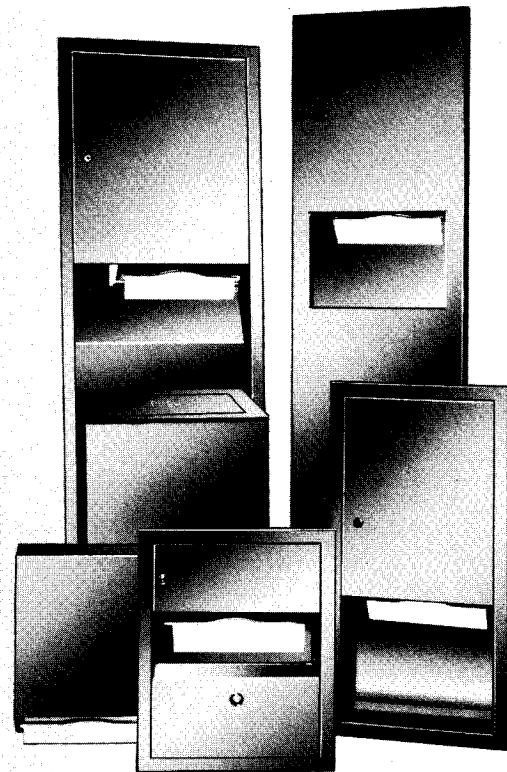

The Parker paper towel dispensers and dispenser-waste receptacle combinations shown vary in design, but all are durably constructed of the finest satin finish stainless steel. All will keep their attractive appearances with a minimum of care. Parker manufactures paper towel dispensers in a wide variety of sizes and styles. That means that there is one to fit any area where there are wet hands to be dried.

See our catalog in Sweets.



290 PRATT ST., MERIDEN, CT 06450  
TEL: 203-235-6365

Attention all candidates  
for the professional  
exam:

What better way can you  
prepare for December's  
Exam than to study the  
book created expressly to  
help you by NCARB author  
of the Exam itself?

## NOW AVAILABLE: THE 1978 NCARB ARCHITECTURAL REGISTRATION HANDBOOK

NCARB believes that Exam candidates are entitled to the greatest possible amount of factual assistance in preparing for the Exam. That's why this *Handbook*, compiled exclusively by NCARB, includes such vital information as:

- The official Mission Statement, which both identifies and describes in detail the subject of this year's Exam—a building complex incorporating a convention hall, conference center and hotel.
- The complete Test Information Packages (TIPs) for last year's Exam, including the 1977 Mission Statement.
- A generous sample of last year's Exam, together with the answers to sample questions and a "degree of difficulty" key.
- A brief bibliography of convention centers.

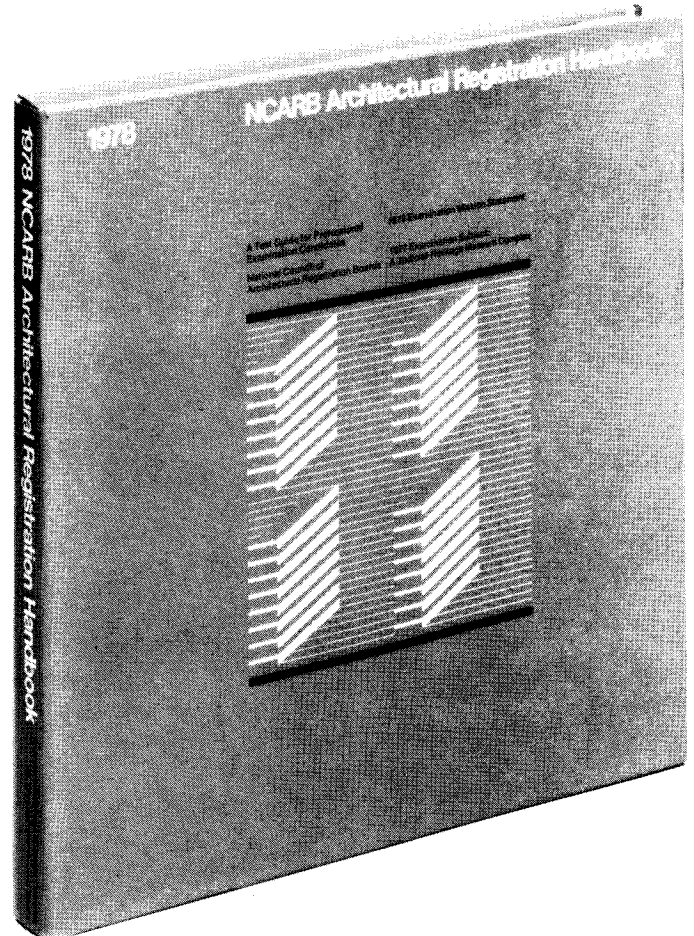

Published jointly by NCARB and Architectural Record Books, the *1978 NCARB Architectural Registration Handbook* is a must for candidates and practitioners alike. Order your copy now.

### for the educator and professional...

The *1978 Handbook* contains special NCARB-developed papers of essential value to all registered architects. These papers include:

- Facts about the Intern-Architect Development Program (IDP), a concise Q&A concerning architecture's most significant new development.
- NCARB Rules of Conduct, which are now being adopted by many state registration boards.
- How Architectural Registration Boards Work Together, with an illuminating discussion of the unique reliance by architects on reciprocal registration.
- A Distinguished Panel Report, which analyzes in depth the philosophy and substance of architectural registration exams.

AR-7-78

### Architectural Record Books

P.O. Box 682  
Hightstown, New Jersey 08520

Please send me \_\_\_\_\_ copy(ies) of the  
**1978 NCARB Architectural Registration Handbook** @ \$20.00  
each. Send to:

Name \_\_\_\_\_

Address \_\_\_\_\_

City \_\_\_\_\_ State \_\_\_\_\_ Zip \_\_\_\_\_

Add sales tax where applicable

Payment must accompany your order.

*For the  
physically  
disabled...*



*...or just  
thirsty people.*



# The Oasis<sup>®</sup> "Soft Touch" is incredibly easy to use.

It takes just 3 ounces of pressure on either of the "Soft Touch" levers to get a drink, and we invite you to compare it to any other brand on the market.

You can see for yourself how incredibly easy it is if you'll let us bring a model to your office. You'll also see other "Soft Touch" features like levers that are operable in either direction and can be mounted independently in four positions 90° apart. Plus the quality features designed into all Oasis water coolers.

Your Oasis sales representative is ready to demonstrate the "Soft Touch" to you the minute you say

the word. Just give him a call or contact him through your Oasis distributor (he's in the Yellow Pages) or through our Columbus, Ohio office.

Ebco Manufacturing Company  
265 North Hamilton Road,  
Columbus, Ohio 43213. Phone 614/861-1350.

## Oasis<sup>®</sup>



The water cooler that's built without shortcuts.

*For more data, circle 116 on inquiry card*

# You can't afford to waste water. Not at these prices:

## MONTHLY METERED COMMERCIAL RATES (Per 100,000 cubic feet or 748,000 gallons)\*

Boston	\$482
Chicago	283
Dallas	315
Denver	241
Hartford	446
Kansas City	250
Los Angeles	247
Minneapolis	350
New York	525
Pittsburgh	546
Portland, Ore.	270
San Francisco	285
Seattle	213
Tampa	360
Tucson	300
Washington, D.C.	300

\*From January 1976 survey conducted by *Business Statistics*.

## So you can't afford to install anything less than Sloan Flush Valves.

That's because a Sloan Flush Valve uses 12½% less water than a flush tank. And this difference increases with use because leaks in tanks go undetected to waste even more water. With today's water rates, it all adds up to a healthy saving on your water bill.

You also save on the energy needed to pump water within a building to upper floors and distant branches. The more water you save, the less energy you have to pay for.

Sloan Flush Valves save water another way, too. Because you can't hold a Sloan Flush Valve open, it meters out the same minimal amount of water needed to flush one fixture, then shuts off automatically.

Put an end to water waste that's costing you money. Find out how Sloan Flush Valves use 12½% less water. The facts are in a recent test report prepared by an independent laboratory. For your free copy, write us. We will send you the facts.

Sloan  
Flush Valves.  
Anything else  
is a waste  
of money.



**SLOAN VALVE COMPANY**

10500 SEYMOUR • FRANKLIN PARK, ILL. 60131