



THE PHYSICAL SCIENCES COMPLEX AT THE UNIVERSITY OF GUELPH, ONTARIO
A REPORT FROM AUSTRALIA: THE ENVIRONMENTAL CRISIS DOWN UNDER
MEMPHIS' NEW C&I BANK BY GASSNER-NATHAN-BROWNE
BUILDING TYPES STUDY: INDUSTRIAL BUILDINGS
FULL CONTENTS ON PAGES 4 AND 5

ARCHITECTURAL RECORD

MAY 1972

5

A MCGRAW-HILL PUBLICATION THREE DOLLARS PER COPY

What makes
these ceilings
right for this job?



The way they do so much so efficiently.

The new Ohio Medical Indemnity Building near Columbus, Ohio, is a showcase for Armstrong ceilings. A variety are used, because each has a special job to do in the different areas of this functionally designed building.

Main work areas, for instance, use vaulted five-foot-square Luminaire modules, which provide excellent lighting quality. Dual-duct heating, ventilating, and air conditioning work through Luminaire's hidden Supply-Air Linear Diffuser system. Demountable wall partitions also work perfectly with Luminaire.

Low light areas, such as the main lobby, have handsome Armstrong Sanserra Travertone™ ceilings. Textured tiles give excellent acoustics and match the beauty of the massive Ohio fieldhouse wall.

The kitchen and rest rooms use Luminaire modules with Armstrong Ceramaguard®. This durable ceramic ceiling is immune to steam, grease, and frequent cleaning.

All ceilings are engineered for easy installation and give two-hour-rated fire protection. For more information on how Armstrong can do the jobs for you, write Armstrong, 4205 Rock Street, Lancaster, Pa. 17604.

For more data, circle 1 on inquiry card

Armstrong / **CEILING
SYSTEMS
THAT WORK**

Ohio Medical Indemnity Building, Worthington, Ohio
ARCHITECT: Karlsberger and Associates, Architects, Inc., Columbus, Ohio
GENERAL CONTRACTOR: G. W. Atkinson & Son, Columbus, Ohio
MECHANICAL/ELECTRICAL ENGINEER: W. E. Monks & Company, Columbus, Ohio
CEILING SYSTEMS CONTRACTOR: Myron Cornish Company, Columbus, Ohio
LIGHTING/CEILING CONSULTANT: Stockwell Design Associates, Columbus, Ohio



DOBIE RESIDENCE HALL, UNIVERSITY OF TEXAS, Austin—Architects/Engineers: Daverman Associates, Grand Rapids, Mich. General Contractors: Guy F. Atkinson Company, South San Francisco, Calif. Three Dover gearless traction elevators, 500 FPM, Computamatic® control; two Dover Oilraulic® elevators, installed by Dover Elevator Co., Hunter-Hayes Division.

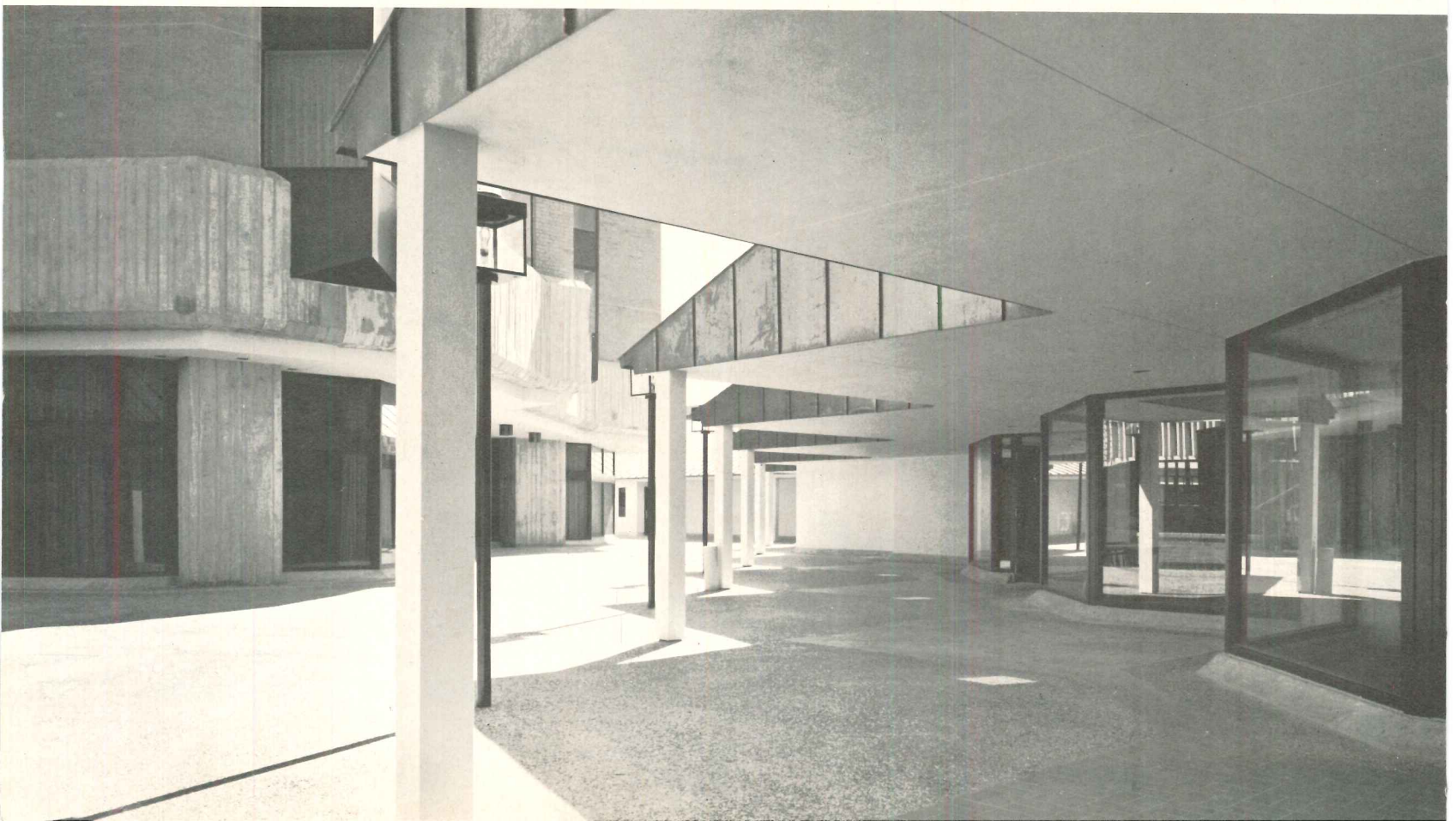
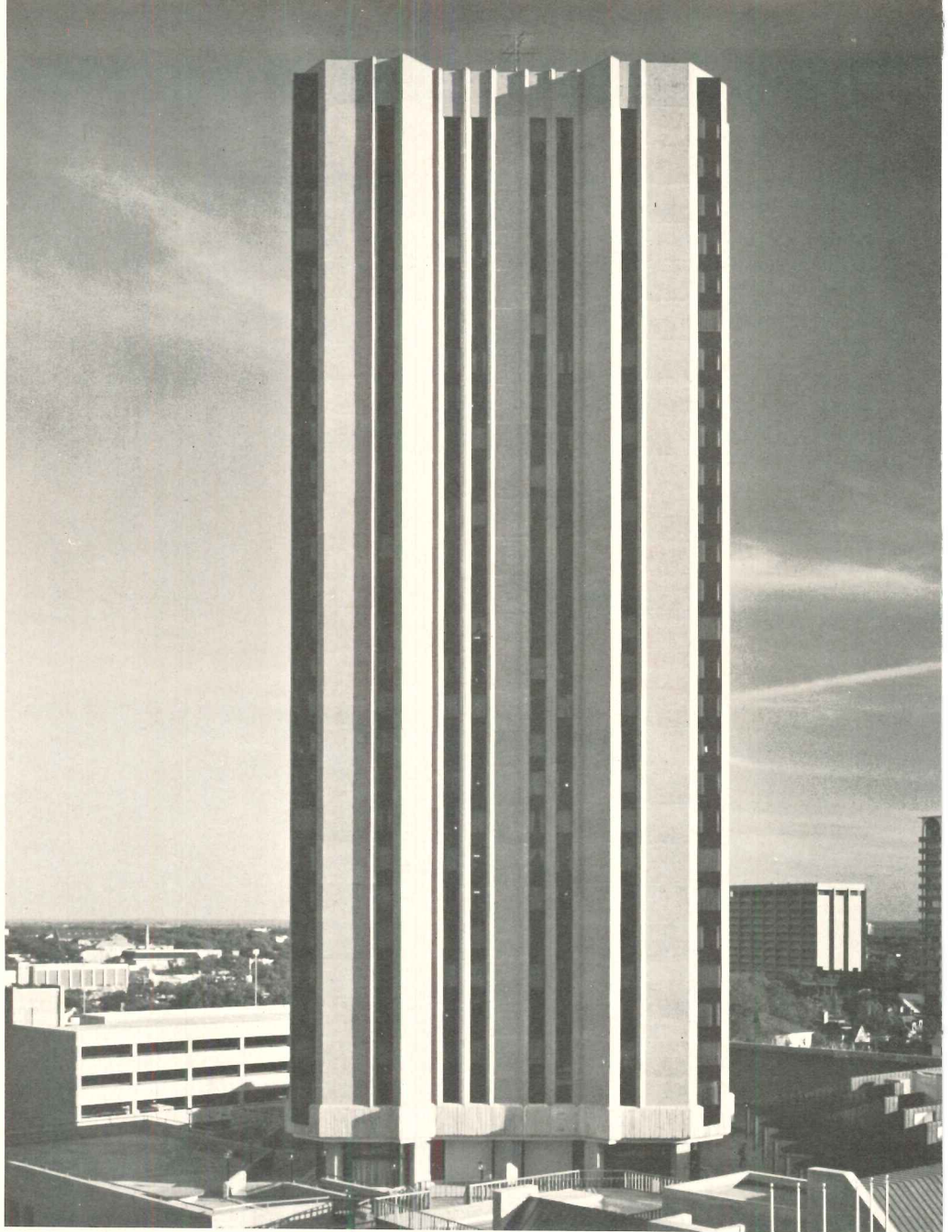

Dover Delivers elevators for systems-built buildings

Both the buildings shown here involve new construction technology—and both are served by Dover Elevators.

Luther Towers is the first completed project using the Mah-LeMessurier System that offers significant savings in construction time and costs. A combination panel and box system in concrete, it makes maximum use of structural efficiencies while retaining wide

latitude in esthetic options.

The 29-story Dobie Residence Hall at the University of Texas, is the tallest building to date using a new system of prefabricated brick curtainwall panels. The tower has 72,700 square feet of masonry, single-brick width, without metal reinforcing or backup. Panels were prefabricated in sheltered workshops at the job site, using a new high-bond mortar, and hoisted into

position. No scaffolding was required, there was no overhead bricklaying to interfere with work at lower levels, no cleanup of dropped mortar and no delay for adverse weather. Time and labor savings were also effected.

Much of the emphasis in these and other new building techniques is on telescoping construction time to achieve earlier occupancy. The elevator manufacturer must be able to meet these tighter construction schedules as well as offering the range of equipment appropriate to the building type.

Dover delivers both, with pre-engineered Oildraulic® and traction elevators that feature accelerated production schedules and installation crews that understand the need to get the job done fast—and right—in today's building market. Let us work with you at the planning stage. For literature, write Dover Corporation, Elevator Division, Dept. A-5, P.O. Box 2177, Memphis, Tenn. 38102. In Canada, Dover/Turnbull, Toronto, Ont.

DOVER

the elevator innovators

For more data, circle 2 on inquiry card

LUTHER TOWERS, Memphis, Tennessee. Architects: Walk Jones+Francis Mah, Inc., Memphis. Structural Engineers: LeMessurier Associates, Boston. General Contractor: ALODEX Corp., Memphis. Two Dover geared traction elevators, 200/250 FPM, duplex selective control, installed by Dover Elevator Co.

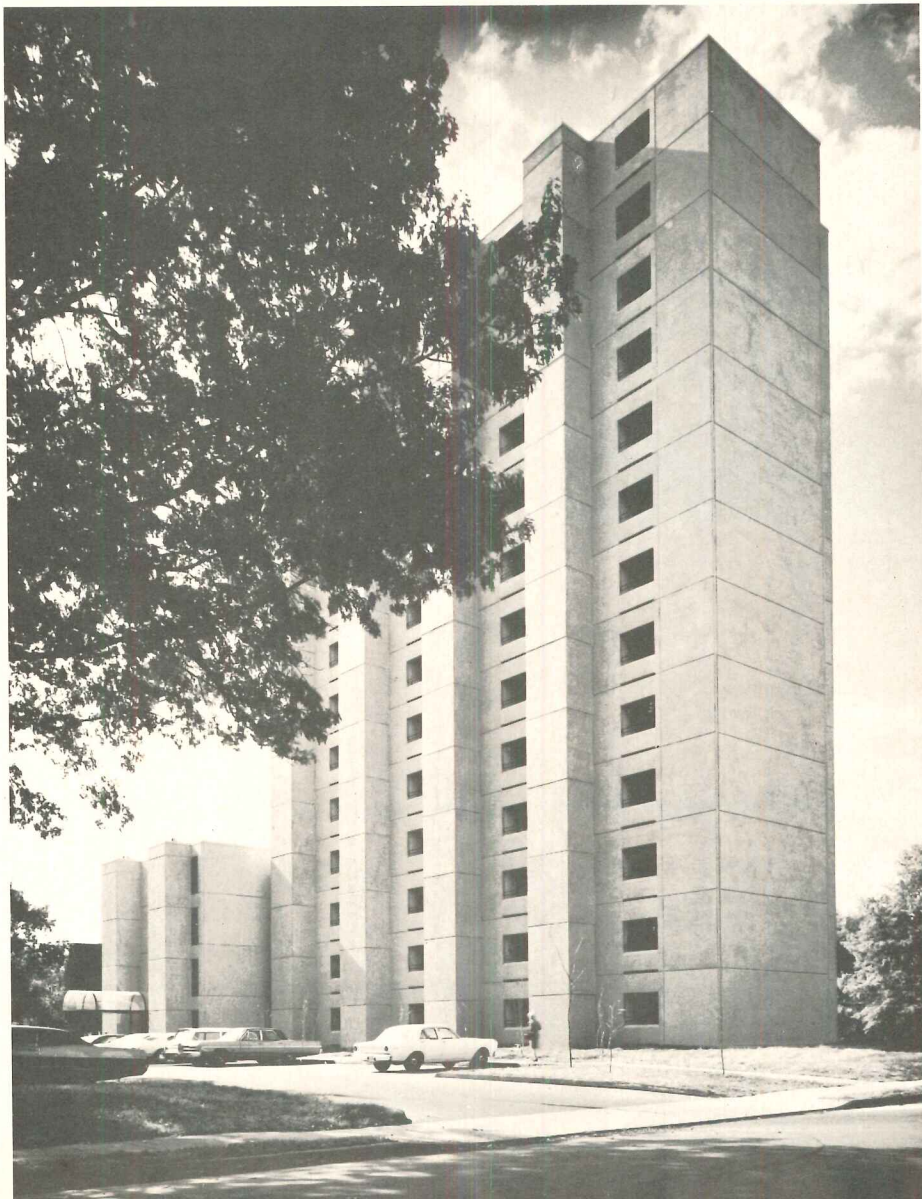



Cover: Physical Sciences Complex,
University of Guelph, Guelph, Ontario
Architects: Craig, Zeidler & Strong
Photographer: Michel Proulx

EDITOR

WALTER F. WAGNER, JR., AIA

MANAGING EDITOR

HERBERT L. SMITH, JR., AIA

SENIOR EDITORS

ROBERT E. FISCHER
WILLIAM B. FOXHALL
MILDRED F. SCHMERTZ, AIA
ELISABETH KENDALL THOMPSON, FAIA

WASHINGTON EDITOR

ERNEST MICKEL, Hon. AIA

ASSOCIATE EDITORS

BARCLAY F. GORDON
ROBERT JENSEN, AIA
JAMES D. MORGAN, AIA

ASSISTANT EDITOR

ANNETTE K. NETBURN

EDITORIAL ASSISTANTS

JANET BLOOM
DANISE PICONE

DESIGN

ALEX H. STILLANO, Director
ALBERTO BUCCHIANERI, Associate
ANNA-MARIA EGGER, Assistant
SIGMAN-WARD, Illustration
JAN WHITE, Consultant

EDITORIAL CONSULTANTS

EDWARD LARRABEE BARNES, FAIA
ROBERT F. HASTINGS, FAIA
PAUL RUDOLPH, FAIA

INDUSTRY CONSULTANTS

GEORGE A. CHRISTIE, JR., Economics
PERCIVAL PEREIRA, Building Costs

McGRAW-HILL WORLD NEWS

WALTER A. STANBURY, Director
20 domestic and
international news bureaus

PUBLISHER

BLAKE HUGHES

SALES MANAGER

LOUIS F. KUTSCHER

CIRCULATION MANAGER

HUGH S. DONLAN

THE RECORD REPORTS

9 Editorials

AIA and Justice: Do you know
you're almost slightly pregnant?

Some random thoughts on
energy and the environment

35 News in brief

Short items of major national
interest as well as award-winners
and announcements.

38 News reports

A new, privately financed urban
center for Lower Manhattan; Ralph
Nader's prediction about the
housing industry; "Lifestyle 2000"—
a glance into the future; the AIA's
new FAIA's.

42 Buildings in the news

London's new Parliamentary Building;
1972 Munich Olympics facilities;
American Institute of Steel
Construction Awards; 1972 AIA
Honor Awards and Bartlett Awards.



50 Office Notes

ARCHITECTURAL BUSINESS

59 Financial management of professional firms

Architectural and engineering firms
have special problems related to
the handling of money. Not only
must they determine their own
profit position on each job as it
flows through the office, but
they also have some responsibility
related to cash flow to contractors
and suppliers on the job. Bradford
Perkins' third article in this
series deals with these matters.

62 Construction outlook 1972: first update

The Dodge construction forecast
(RECORD, November, 1971) has
been a national institution for many
years. This month George Christie
takes a look at how it's all
turning out, and how it looks
for the rest of the year.
Some early optimism is being
well supported by events.

64 Indexes and indicators

Unit price guidelines on
demolition and alteration work.



ARCHITECTURAL RECORD (combined with AMERICAN ARCHITECT, ARCHITECTURE and WESTERN ARCHITECT AND ENGINEER) May 1972, Vol. 151, No. 5. Title (R) reg. in U.S. Patent Office (c) copyright 1972 by McGraw-Hill, Inc. All rights reserved. Copyright not claimed on front cover illustration and on four-color illustrations on pages 106, 107, 109, 115, 117 and on page 119.

Indexed in Reader's Guide to Periodical Literature, Art Index, Applied Science and Technology Index, Engineering Index, and The Architectural Index. Published monthly except May when semi-monthly, by McGraw-Hill, Inc.

Quotations on reprints of articles available. Every possible effort will be made to return material submitted for

possible publication.
EXECUTIVE, EDITORIAL, CIRCULATION AND ADVERTISING OFFICES: 330 West 42nd Street, New York, N.Y. 10036. Other Editorial Offices: 425 Battery Street, San Francisco, Cal. 94111; 1249 National Press Building, Washington, D.C. 20004. PUBLICATION OFFICE: 1500 Eckington Place, N.E., Washington, D.C. 20002; second-class postage paid at Washington, D.C.

OFFICERS OF McGRAW-HILL PUBLICATIONS COMPANY: John R. Emery, president; J. Elton Tuohig, senior vice-president—services; David J. McGrath, group vice president; vice presidents: Ralph Blackburn, circulation; John R. Callahan, editorial; John B. Hoglund, controller; David G. Jensen, manufacturing; Jerome D. Luntz, plan-

FEATURES

89 Designing for growth: the metamorphosis of a rural campus into a university town

Approximately eight years ago, the University of Guelph in Ontario began to transform itself from a campus of 2.5 thousand students to one with a projected growth of 15 thousand by 1980. The results, as planning and architecture, are noteworthy.

99 Worcester Center

This downtown version of the suburban shopping complex is revitalizing the blighted business district of Worcester, Massachusetts.



Ezra Stoller © ESTO

105 The environmental crisis down under

A report from Australia which discusses the future consequences of its rapid, but unplanned urbanization and technological growth. The report is based upon a conference sponsored by the Royal Australian Institute of Architects.

109 New C&I Bank in Memphis

Architects Gassner-Nathan-Browne have designed a striking new bank for downtown Memphis that treats depositors to unaccustomed amenities and thrusts a new shape into the city skyline.

BUILDING TYPES STUDY 434

113 Industrial buildings: toward higher standards for design

During the recent recession, industrial building dropped by nearly 25 per cent. Now, as economic indicators improve, industrial building is starting to rally. There are signs that, as the rally gains impetus, some new design standards may begin to emerge.

114 The Republic Newspaper Plant: Columbus, Indiana
Skidmore, Owings & Merrill, architects.

118 Parker Hannifin Complex: Irvine, California
A. C. Martin & Associates, architects.

120 Westinghouse Hermetic Motor Plant: Athens, Tennessee
Heery & Heery, architects.

122 P. J. Carroll & Company, Ltd.: Dundalk, Ireland
Michael Scott & Partners, architects.

124 Air Freight Building #1: Los Angeles, California
Parkin Architects Engineers Planners.

126 Adams Wastewater Treatment Plant: Adams, Massachusetts
Johnson-Hotvedt, architects in association with Camp, Dresser, McKee, Inc., engineers.



George Zimberg

ARCHITECTURAL ENGINEERING

129 Yes, curtain walls really can work, but they need expert attention

The know-how for the design and construction of curtain walls that work exists, but problems persist. This article suggests avenues for improvement: through better understanding of the curtain wall as a system; appreciation of influences of the market place, and recognition of practical field problems that affect both design and specifications.

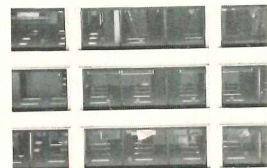

Robert Fischer

136 Product Reports

177 Update

188 Personal Business

191 Office Literature

194 Record Impressions

202 Advertising Index

204 Classified Advertising

205 Reader Service Inquiry Card

ning & development; Joseph C. Page, marketing; Robert M. Wilhelmy, finance.
CORPORATION OFFICERS: Shelton Fisher, president; Joseph H. Allen, president—publications and business services group; John J. Cooke, senior vice president and secretary; Ralph S. Webb, treasurer.
SUBSCRIPTIONS: Subscriptions solicited only from architects and engineers. Position, firm connection, and type of firm must be indicated on subscription orders; CHANGE OF ADDRESS or subscription service letters should be forwarded to Fulfillment Manager, ARCHITECTURAL RECORD, P.O. Box 430, Hightstown, N.J. 08520. Provide old and new addresses, zip code or postal zone number. If possible, attach issue address label. Annual

subscription prices: U.S., U.S. possessions and Canada: \$7.50 for architects, engineers and other individuals in the fields served, all others \$20.00. Other countries: \$22.00 to architects, engineers; others \$30.00. Single copies \$3.00. UNCONDITIONAL GUARANTEE: Publisher agrees to refund that part of subscription price applying to unfilled part of subscription if service is unsatisfactory.
ASSOCIATED SERVICES/McGraw-Hill Information Systems Co.: Sweet's Catalog Files (Architectural, Light Construction, Interior Design, Industrial Construction, Plant Engineering, Canadian Construction), Dodge Building Cost Services, Dodge Reports and Bulletins, Dodge/SCAN Microfilm Systems, Dodge Management Control Service, Dodge Construction Statistics, Dodge regional

construction newspapers (Chicago, Denver, Los Angeles, San Francisco). THIS ISSUE is published in national and separate editions. Additional pages of separate edition numbered or allowed for as follows: Western Section 32-1 through 32-4. POSTMASTER: Please send form 3579 to Fulfillment Manager, ARCHITECTURAL RECORD, P.O. Box 430, Hightstown, N.J. 08520



1



2

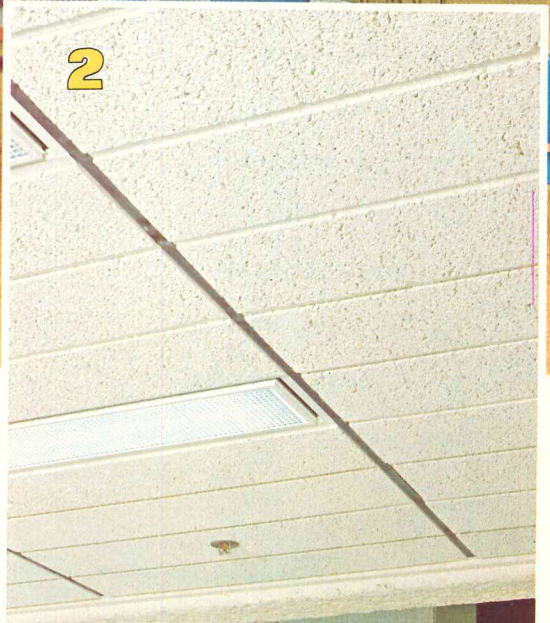

3

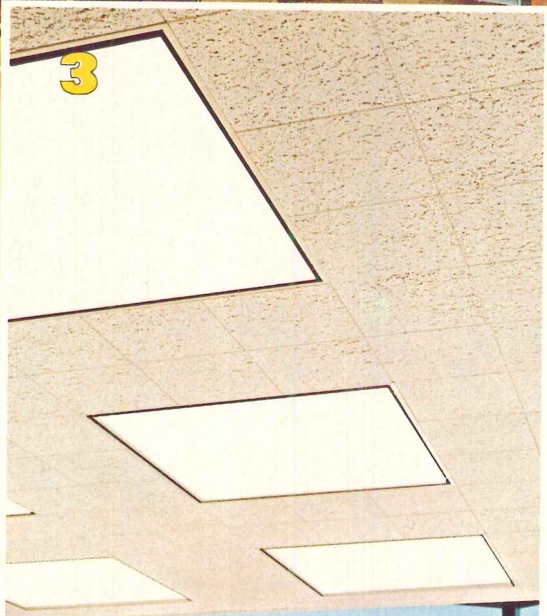

4

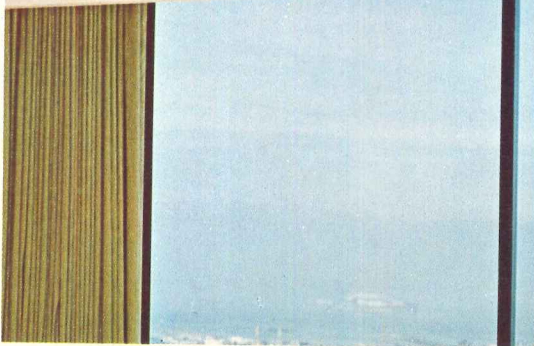

Only one line of acoustical ceiling systems so complete.

The Celotex selection of ceiling products and systems is an inspiration to imaginative designers. You choose from an almost endless variety of textures and patterns—including new nondirectional deep-textured mineral fiber tile that makes joint lines almost invisible . . . and new nondirectional fissured lay-in panels. To meet the widest range of technical performance

requirements, we offer NCR's to .90 and designs for UL time-rated assemblies of 1, 2 and 3 hours. And new Vari-Tec* luminaire systems that provide lighting, acoustical control and air handling.

Your Celotex acoustical contractor/distributor will welcome your call for specifications, samples and estimates.

Only one company brings you this range of building products.

Celotex. The company that pioneered the concept and development of acoustical ceilings. The company that today manufactures and markets the broadest line of quality building products ever—for inside,

outside, on top, including: BARRETT® roofing products, "everything from the deck up" . . . gypsum drywall systems . . . hardboard paneling and siding . . . insulation products . . . and others.

*Trademark

Only Celotex.

CELOTEX ACOUSTICAL CEILING SYSTEMS SHOWN:

1. Vari-Tec 830 luminaire system.
2. Texture-Tone® mineral fiber reveal-edge lay-in panels. Custom 1'x4' size.
3. Natural-fissured Celotone® mineral fiber 12"x12" tile on concealed suspension system.
4. Mat-faced Acoustiform® medium density mineral fiber 2'x4' lay-in panels.

Celotex*
BUILDING PRODUCTS

THE CELOTEX CORPORATION
Tampa, Florida 33622
Subsidiary of Jim Walter Corporation



CONTRIBUTING TO
THE PROGRESS OF
MAN THE BUILDER

*Trademark

Recommend the Carrier 16JB gas absorption machine. Your client will thank you for years.

The Carrier 16JB is so trouble-free that your clients can put it in and just about forget it.

This unique chiller automatically adjusts to fluctuating steam pressure and varying condensing water temperatures.

It needs only a bare minimum of maintenance. Your clients can even get a planned maintenance contract from the factory.

You can put the machine just about anywhere. There's no vibration and very, very little noise.

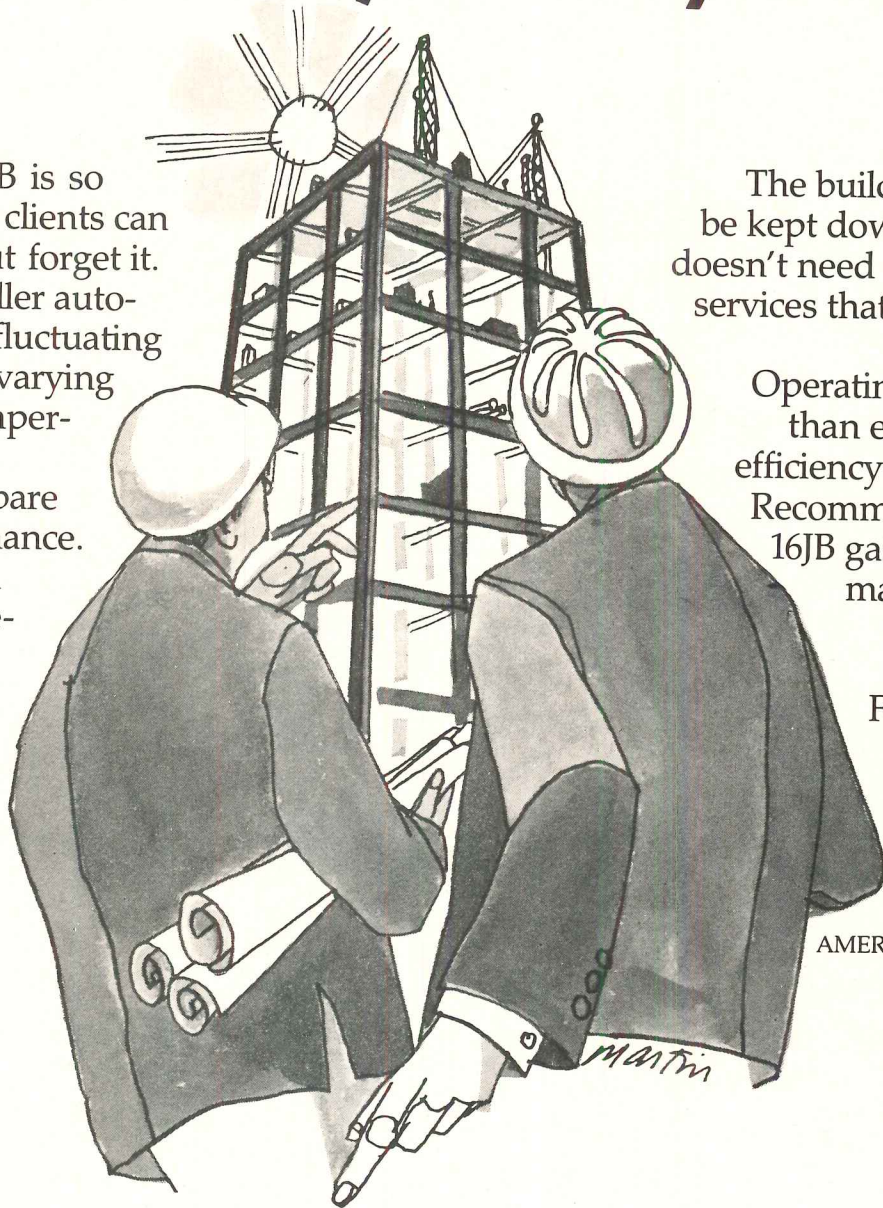

The building's first costs can be kept down because the 16JB doesn't need the heavy electrical services that mechanical equipment needs.

Operating costs are lower than ever, too. The 16JB's efficiency actually saves gas.

Recommending the Carrier 16JB gas absorption chiller makes for a satisfied client. And that's good business.

For the details, contact Carrier Air Conditioning Co., Carrier Parkway, Syracuse, N.Y.

13201. 

AMERICAN GAS ASSOCIATION

Conserve natural gas.
It's pure energy.

Carrier[®]

For more data, circle 4 on inquiry card

The AIA and the Justice Dept: Do you know you're almost slightly pregnant?

Rumor has it (and it has to be a rumor because the AIA staff won't discuss the matter with "the press") that the AIA Board has voted overwhelmingly to accept a consent decree altering drastically the code of ethics of the American Institute of Architects and thus, in my view at least, altering the whole concept of professionalism.

The consent decree, rumor has it, would require an addition to the code of ethics permitting (and of course, at least on government work, that means encouraging) architects to submit fee quotations for architectural service at the time they offer their services.

What's so bad about this? Don't a lot of architects already talk fee pretty early in the game? Any architect has always been free to make any deal he wants to—even (and I guess that has happened) to taking a loss to do a building he really wants to do or to minimize losses during a slow period in the office. Further. . . .

Everyone knows that for a long time the various chapters' recommended minimum fee schedules have routinely been shaved by even the most professional firms (indeed, have often been exceeded for what the client agrees are good and sufficient reasons). It has never been unethical for a firm to offer to do a job for less than those suggested fees—as long as price

alone was not the basis for selection and as long as an architect didn't sidle up after a commission was signed with a competitor and offer to do it wholesale.

What's so bad about this, it seems to me, is that agreeing to the consent decree reduces the concept of professionalism to the level of a commodity. Sure, there's nothing that says the client has to take "the lowest bid" on architectural services—but how'd you like to be the government employee (or school board member) (or corporate vice-president) who has to argue not to take the lowest fee?

All this emphasis on prices at the very first stage of an architectural project would, it seems to me, assume that from the very first stage the scope of the work will not change, there will be no changes in the conditions or laws during the job, and that the architect can 1) make no contribution to programming or 2) needs no time to think. The whole idea of early emphasis on price, it seems to me, takes on the aspects of competitive bidding by architects with very different skills, staffs, and experience—in the absence of identical documents for an identical end product, which is what contractors bid on the basis of. (Or will, soon, architects be asked to bid on a complete and detailed program established ahead of time by someone else—and how

do you like that idea?)

Then there's the principle of the thing. As I understand consent decrees, signing one is the last thing short of admitting that you've been involved in hanky-panky (restraint-of-trade dept.) all along—which if I were the AIA board I'd be mightily reluctant to do.

Well, at last this whole matter will be discussed publicly at the convention. The choice, it seems to me, is a simple one. Either:

1) Refuse to sign the consent decree and continue to fight for the professional concept that fees may be discussed early but should be finally negotiated only after an architect has been selected for his professional qualifications.

2) Agree to sign the consent decree on the basis that it's not too bad a consent decree and that architects can live with it. And that, it seems to me, equates professional architectural services with buying a used car—*caveat emptor* and all that. I can't believe the client will be served by the proposed new process—and if serving the client is not the name of the game then let's toss in the whole thing.

I certainly don't insist that you agree with the point of view outlined here (especially since I don't pretend to have all the facts and a lot of thoughtful men who do have all the facts voted to accept the decree). But I sure hope you'll try to think out the implications for the profession and let the board know your opinions.

Myself, I'd let the courts decide.

—Walter F. Wagner Jr.

Some random thoughts on open space, environment—and energy

I got back recently from a week in California. The trip was made possible by an invitation from the Southern California Edison Company to talk to its Architects and Engineers Forum (an annual event which this year drew nearly 600 professionals) on the subject of energy conservation. I'd like to talk about that a bit, since I return convinced more than ever that if architects and engineers don't do something about conserving fuel and power by better design (and by convincing clients that the slightly higher first costs of

an energy-conserving building must be paid) we're really going to be in the black-out soup before long. But first. . . .

I got to spend two days poking around Los Angeles, two days poking around San Francisco, and two spectacular (if sometimes hair-raising) days driving between the two—happily in the northbound direction where there is at least another lane of road between you and a practically vertical drop to the shores of the blue Pacific. On the basis of such a barely subsonic trip, I certainly am not going to attempt any de-

tailed analysis of the relative merits of any-thing (much less the two cities). But I find I do have some purely personal impressions about environmental things in general, herewith presented in no particular order:

■ It's easy to find things to knock about Los Angeles, but it's also easy to find things that you wish there were more of in your home town: broad streets with broad dividers planted in flowers and flowering shrubs (even the infamous freeways are banked with ivy and flowers, which does a lot for them). There are fountains everywhere—not big famous controversial ones like San Francisco has; just unassuming ones in front of a lot of buildings. I was impressed (notably along Century City's



"No, we aren't an Historical Landmark—we just don't play our cards right."

main drag and in the garden behind the Century Plaza) that there are a number of pools that you cross on bridges without railings. I found this assumption that I could a) walk across without falling and b) if I did fall in would not instantly sue the owner, refreshing. Similarly, the fountains were squirting away merrily, which seems to be impossible at least in New York because matrons apparently sue over having their dresses spotted.

■ Everywhere I went, the streets were clean.

■ Route 1 to San Francisco is—as I guess everyone but me knows by now—perfectly beautiful. I was particularly moved by the number of public parks and beaches along the way—all in beautiful spots, beautifully maintained, and open to everyone at a nominal fee. There was, incredibly, no litter anywhere (nor did there seem to be litter baskets except in the picnic groves).

■ The most beautiful park we saw was at Point Lobos, just south of Carmel. There's no sense trying to describe that beauty—but something else impressed me. The park—with sheer rock cliffs dropping down to a lot of Pacific Ocean—has some dangerous places; and it is also full of fragile parts of nature—ancient cypress trees, tiny wildflowers and brittle shrubs. For the protection of people and plantlife alike, the paths through the parks have slender wire railings on both sides, with simple signs requesting that park visitors stay between them. Though we were there on a day that saw many visitors (including three bus loads of school children) I saw no one outside those slender and step-overable barriers; no candy wrappers, no cigarette packages. The one Coca-Cola can lodged between two rocks, in that setting, seemed a particular outrage. Again, whether the level of care given that park, despite heavy use, is a credit to the visitors or the result of a different kind of maintenance than in other parks I really couldn't say. . . .

■ The most dramatic example of the Californian's good sense about saving open space is visible from the top of Mount Diablo, which is the tallest (3,800 feet) mountain near San Francisco. We had the good luck to drive up just before dusk and get (before dark) a panoramic view of the Bay and the city and (after dark) a clear understanding—because they show as dark spaces amidst the lights of city, towns and roads—of the enormous amount of land in the city, across the Golden Gate Bridge, on the ridge behind Berkeley and Oakland, and in the valley that is still green because it is in state, regional, or city parks.

And even just outside both cities—and for the hundreds of miles between—there are California's golden hills (currently green) stretching down to the sea and off into the distance, now populated almost entirely by cattle.

So. . . .

Within a very short space of time you get two very conflicting impressions.

One, of a part of the country with a natural environment of extraordinary and fragile beauty, with climate that is the envy of at least 45 other states, and with a body of citizens that appear to appreciate what they have and to care for it with a rare intensity.

The other impression—this gathered at the Architects and Engineers Forum (as noted, sponsored by one of California's major utilities)—is the conflict between the environment and the need for more power. Like more and more parts of the country (see RECORD, December 1971), California is staring at power shortages, and the majority of the utility's efforts to provide new capacity are being blocked or delayed by environmental opposition.

So maybe we can—from those conflicting points of view of environment and energy—see in California a microcosm of what is going to occur across the United

States—a tough, and terribly important, conflict between the conflicting needs of energy generation and conservation of the environment. Because of California's great need for power (on one hand) and its active and very personal involvement in conservation (on the other hand) we see clearly there the conflicts between desires and need, ideals and responsibilities, reality and romanticism, fad and fact, and—very simply—capacity and usage.

In a thoughtful booklet just published, Edison put it this way: "[Our company] is acutely conscious of its conflicting responsibilities. As a concerned corporate citizen, we are determined to intensify our efforts to preserve the environment. But we must also build 11 million kilowatts of new electric capacity in the next ten years."

They, of course, have a point. So, of course, have the activists who want the California environment—its hills, its coastline, its water, and its air—unimpaired.

As I said to the audience of architects and engineers (and utility executives) at the Los Angeles Forum, I'm certainly no expert arbiter of conflicting claims over energy generation and environmental conservation. I do know one thing: those ideas cannot be mutually exclusive. Along one part of that coast I raved about earlier in this editorial there is a perfect example of what is no longer acceptable: In Morro Bay—which has in its harbor one of nature's grand landmarks—576-foot-high Morro Rock—there is a generating plant (not built by SoCalEdison) of similar scale. It dwarfs the town—which is *all right* for a rock but not *all right* for a power plant.

Surely we can—with the concern on both sides of the question—find ways to generate the power that we undoubtedly need without disrupting the environment that we all must live with and live in. There are few problems that deserve more attention.

—Walter F. Wagner Jr.

ARCHITECTURAL AWARDS OF EXCELLENCE-1971



American Institute of Steel Construction

SEARS, ROEBUCK AND CO.

PACIFIC COAST ADMINISTRATIVE OFFICES, Alhambra, California

"Simplicity, clean form, and excellent siting give this handsome structure an unusual appeal."

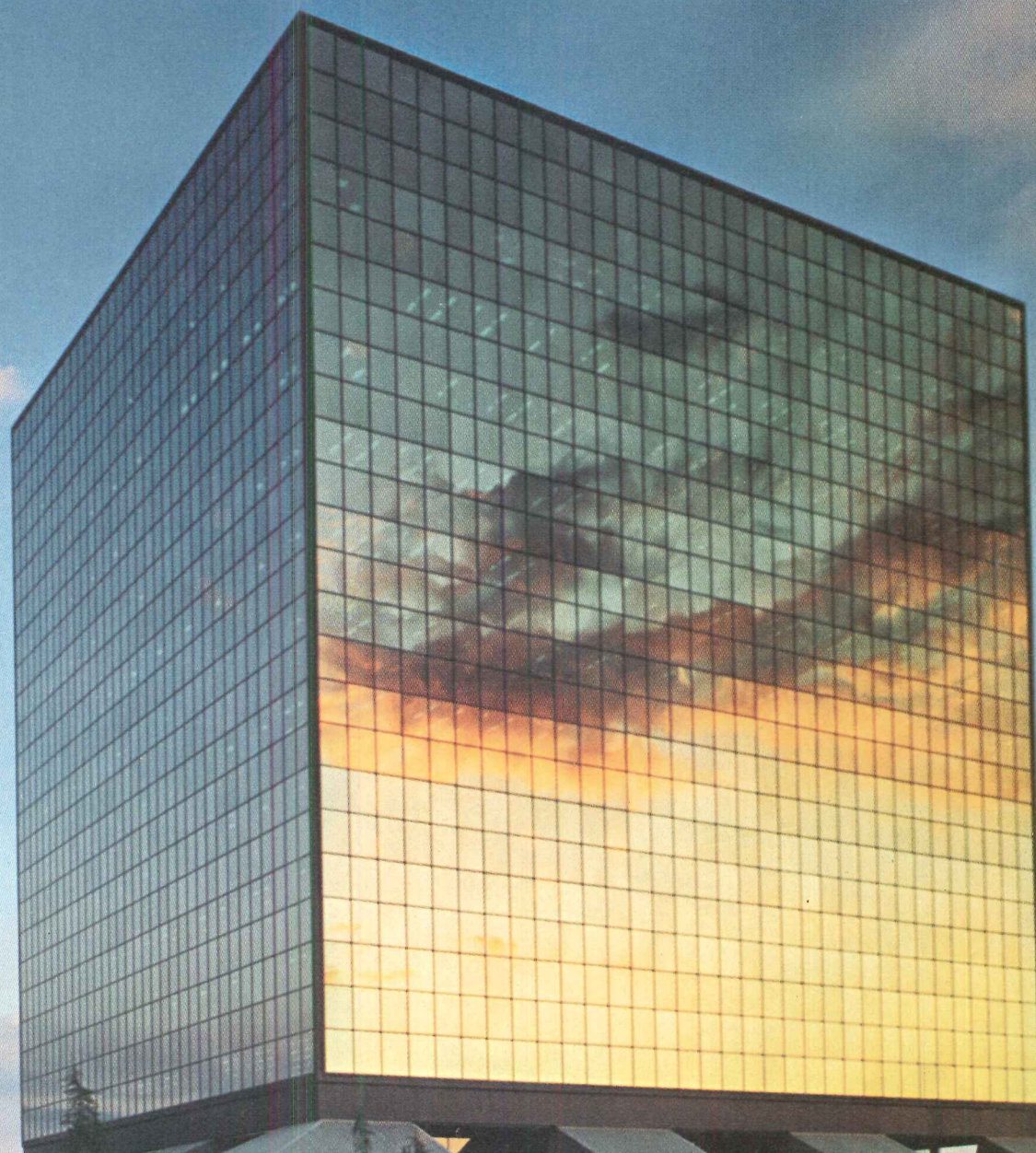



RICHMOND COLISEUM, Richmond, Virginia

"This highly unusual circular structure with its simple geometric shape is a very interesting and fine solution. The natural structural expression is not forced in any way. It is a strong, handsome design."



National Jury of Awards

John P. Eberhard, AIA
 Dean, School of Architecture and
 Environmental Design
 State University of New York at Buffalo
 Buffalo, New York

James H. Finch, FAIA
 Finch Alexander Barnes Rothschild &
 Paschal
 Atlanta, Georgia

Dahlen K. Ritchey, FAIA
 Deeter Ritchey Sippel Architects
 Pittsburgh, Pennsylvania

Edward J. Teal, M.ASCE
 Albert C. Martin and Associates
 Los Angeles, California

Max O. Urbahn, FAIA
 President-elect AIA
 Max O. Urbahn Associates, Inc.
 New York, New York

**SUPERBAY HANGAR
 MAINTENANCE
 FACILITIES,**

**San Francisco International Airport
 and Los Angeles International Airport,
 California**

"This is a simple, straightforward,
 and very exciting building. The im-
 aginative design of the roof trusses
 makes maximum use of the strength
 of steel. It is an excellent solution
 both structurally and architectur-
 ally."

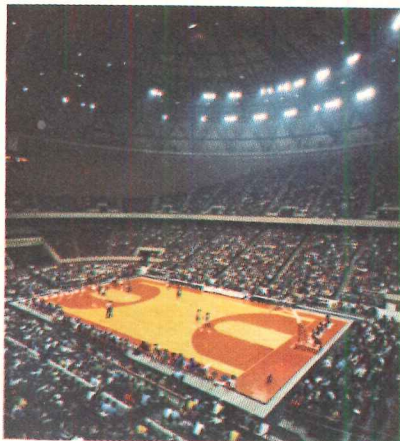

RAPID TRANSIT STATIONS ON DAN RYAN AND KENNEDY EXPRESSWAYS,

Chicago, Illinois

"These modest structures are excellent examples of careful, straightforward design and well-executed details. The use of graphics to aid pedestrian traffic is handled beautifully."



Structural steel for these award winning buildings was supplied by Bethlehem Steel Corporation

BETHLEHEM STEEL



PIERCE STREET APARTMENTS, Gilroy, California

"A fine example of the pleasing and socially rewarding results that can be achieved with prefabricated components for low income housing. The innovative combination of exposed steel framing with wood fill-in walls is most attractive."



CREDITS:

Pierce Street Apartments

Owner: Pierce Street Apartments, A Limited Partnership

Architect: Dukor Associates, AIA

Structural Engineer: Dimitry Vergun, AIA, S.E.

Steel Fabricator: Dukor Modular Systems, Inc.

General Contractor: Dukor Modular Systems, Inc.

Rapid Transit Stations on Dan Ryan and Kennedy Expressways

Owner: City of Chicago

Architect: Skidmore, Owings & Merrill

Structural Engineer: Skidmore, Owings & Merrill

Steel Fabricators: Inland-Ryerson Construction

Products Company and

Pittsburgh-Des Moines Steel Company

General Contractors: J. M. Corbett, Paschen

Construction Inc. and W. E. O'Neil

Construction Co.

Richmond Coliseum

Owner: City of Richmond

Architects: Ben R. Johns, Jr. and Vincent G. Kling & Partners

Structural Engineer: Fraioli, Blum & Yesselman

Steel Fabricator: Bristol Steel & Iron Works, Inc.

General Contractor: J. A. Jones Construction Company

Sears, Roebuck and Co.

Pacific Coast Administrative Offices

Owner: Sears, Roebuck and Co.

Architect: Albert C. Martin and Associates

Structural Engineer: Albert C. Martin and

Associates

Steel Fabricator: Bethlehem Steel Corporation

General Contractor: Dinwiddie Construction Co.

Superbay Hangar Maintenance Facilities

San Francisco International Airport, San Francisco, Calif.

Los Angeles International Airport, Los Angeles, Calif.

Owner: American Airlines

Designers: A Joint Venture of Lev Zetlin

Associates, Inc., Consulting Engineers and

Conklin and Rossant, Architects

Steel Fabricators: San Jose Steel Company, Inc.;

The Herrick Corporation; Fleming Steel

Company (Doors)

General Contractors: Swinerton & Walberg Co.;

Haas and Haynie Corporation

BETHLEHEM STEEL

Bethlehem Steel Corporation, Bethlehem, PA 18016



The MONARCH, a high intensity area light mounted less than 4' above grade. Yet it can illuminate a 1200 sq. ft. area with a horizontal footcandle brightness ratio of 10 to 1. And it's brought to you in an architecturally appealing package. ■ Spaulding's MONARCH was created for areas where poles aren't desired. Areas such as plazas, town squares, campuses, drives and entrances/exits. For people's sake, the MONARCH has a safe operating surface temperature. ■ Glare? Nothing to speak of . . . it's virtually eliminated by a system of reflected, redirected light through a prismatic refractor. ■ Durable? You bet . . . as durable as practicality will allow. Its high

Spaulding brings Area Lighting down to earth

strength, impact resistant polycarbonate refractor is permanently sealed in the MONARCH's all aluminum housing. The housing is mounted to an extruded aluminum post.

Together they'll support up to 785 pounds without permanent deflection. The entire assembly has a factory finish that's guaranteed for five years.

■ One catalog number gets you a complete MONARCH assembly . . . luminaire, post and base cover, all with a matching factory finish plus a pre-set anchoring system.

Spaulding

3731 Durr St., Cincinnati, Ohio 45223

Division of LCA Corporation

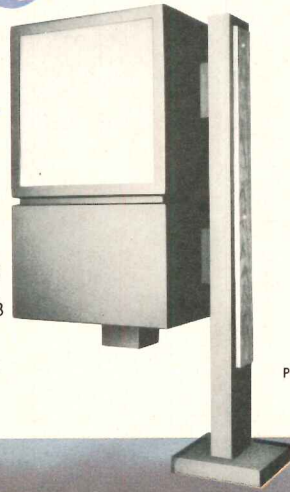

PAT. PENDING



For more data, circle 5 on inquiry card

"Carpet of Antron® stays
not easy in our busy

—Spring High School, Spring, Texas

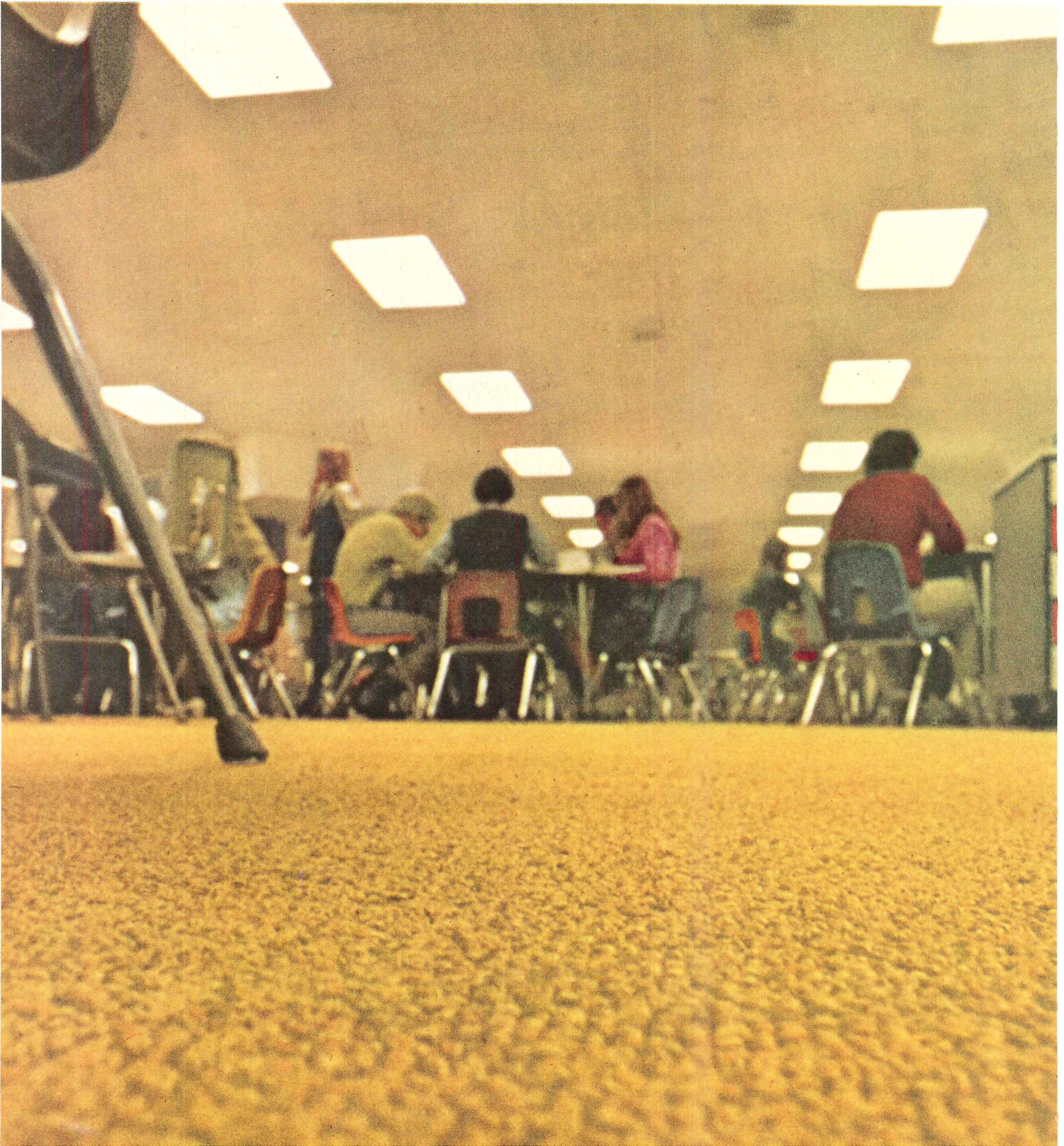

clean-looking. That's classrooms!"

The Spring Independent School District credits Antron* nylon for long-lasting, attractive appearance of classroom carpet. James Damm, Business Manager, says: "We believe the outstanding ability of 'Antron' to hide soil helps hold maintenance costs to a minimum."

The magnified cross-section (right) shows how four precisely placed hollow chambers traverse the length of each "Antron" filament. This unique fiber structure refracts and scatters light to minimize the appearance of soil without significant sacrifice of color clarity or luster.

This--together with the fiber's abrasion and matting resistance--means carpet with pile of "Antron" retains its original fresh appearance longer than carpet of other fibers. Concentrations of spots and soil tend to even out and

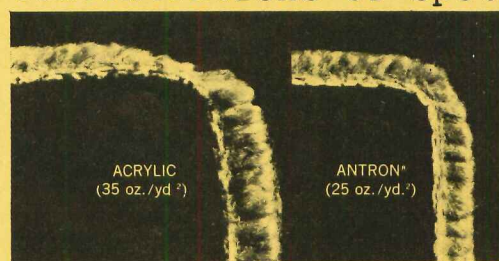

Simulated stair-edge abrasion test showing carpet pile fiber wear in level-loop carpets.

blend into the overall color and texture of the carpet. Maintenance costs are minimized by the need for fewer wet cleanings than with carpet of other fibers. And even after repeated shampoos the carpet returns remarkably close to its original appearance.

What's more, "Antron" is tough because it's nylon: the abrasion-resistant, long-wearing carpet fiber. So the carpet will have a long life. Compare the performance of carpets in this stair-edge test (above).

Specify "Antron" for high-traffic commercial carpet. It has no equivalent in long-term appearance retention.

For more facts and a mill resource list, write to Du Pont, Contract Specialist, Room 5638/103, Eden Park, Wilmington, Del. 19898.

*Du Pont registered trademark. Du Pont makes fibers, not carpets.

For more data, circle 6 on inquiry card

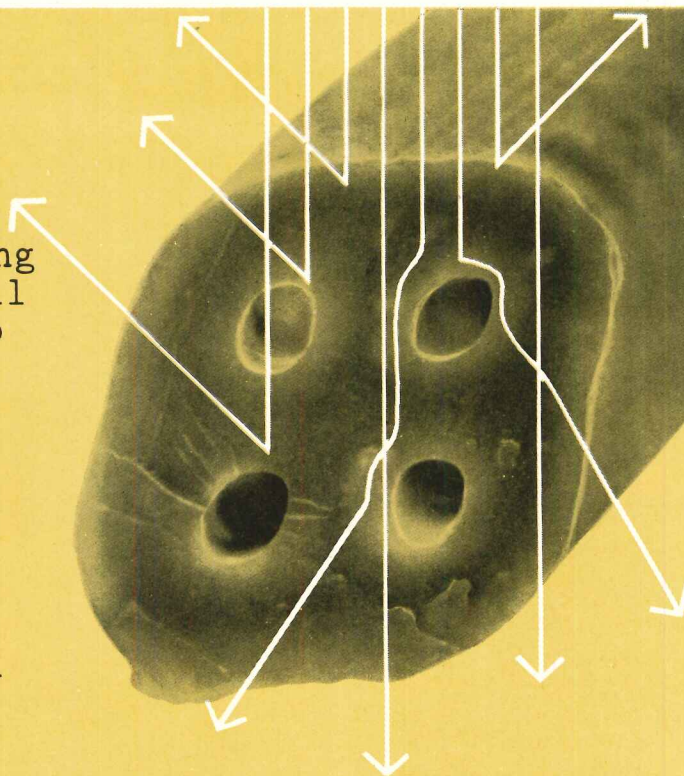

A single filament of "Antron" at 1200x magnification. Illustrates scattering of light to minimize appearance of soil.





Western Electric

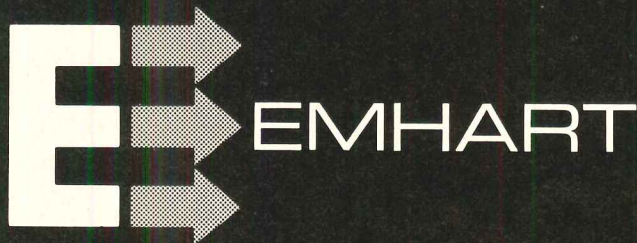

GENERAL MOTORS
CORPORATION



Corbin presents the Fortune 100.

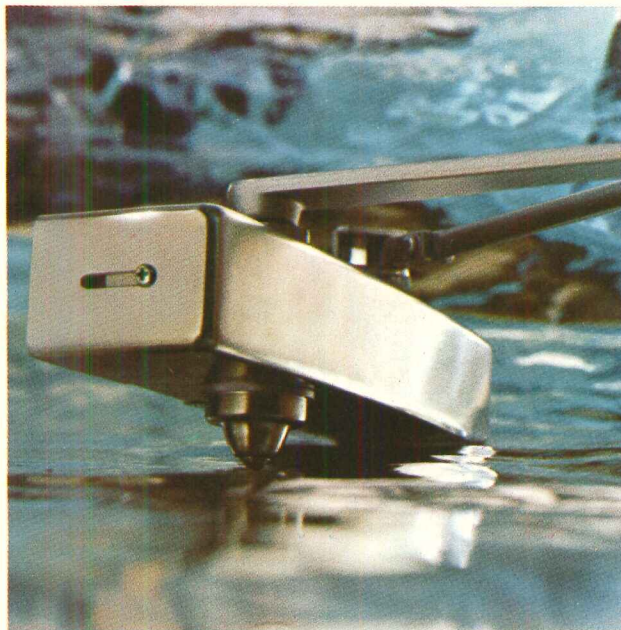

Top corporations top their doors with Corbin closers. Because Corbin's 100/110 Series matches the corporate image in style and strength. Think of it as a piece of metal sculpture beyond its basic closing function. Executive finishes in bronze, brass, aluminum and chrome. Solid rack and pinion construction absorbing busy door-to-door traffic. In short, good looks, long life. Get them into your plans and specs by reaching a Corbin distributor. Or write us direct. Fortune's looking after you.



The Security Analysts.

For information write P & F Corbin, Division of Emhart Corporation, Berlin, Conn. 06037. In Canada, Corbin Lock Division.

For more data, circle 7 on inquiry card

Our built-up roofing experience is priceless.

How can we put a price on the wealth of knowledge about built-up roofing we've assembled in well over 100 years in the business?

The answer is: We don't.

Therefore, we're offering it to you free. No charge. No obligation. No strings attached.

Which means that when you need help designing a roof, you can ask for and get—without cost—the knowledge and resources of one of the world's largest producers of built-up roofing materials. A company that has solved roofing problems for over a century.

All you do is contact J-M. One phone call or one letter will do. We'll send a qualified J-M roofing specialist to look at your plans—or inspect an existing roof if it's giving you problems. He's trained in all aspects of built-up roofing. He knows his job.

Should he be baffled, as sometimes happens, he'll consult one of J-M's



11 district engineers, who together have over 250 years of intensely practical roofing experience to draw upon.

So when you get their detailed recommendations for a built-up roof, you can count on their advice being exactly right for the job. Candidly, honestly given.

One other point. We hope you'll accept our recommendations. If you do, we can put you in touch with approved J-M contractors who will use quality J-M roofing materials to install, or repair, your roof. If you use someone else—well, we can't win them all.

But do keep this in mind. We at J-M stand behind our materials and our contractors 100%. Back them with roof bonds, if you choose, for as long as 20 years. And, if something should go wrong with your bonded roof, J-M will be around to make good.

When you have a new roof to design, call your J-M district sales office. Or write Johns-Manville, Post Office Box 5108, Denver, Colorado 80217.

We think you'll agree our advice is really priceless.

Johns-Manville 

So is our advice.

For more data, circle 8 on inquiry card

Both of these structural columns do the same job. Which one would you specify?

WIDE FLANGE BEAM

\$303
▲ per foot

WELDED SQUARE TUBE

\$257
▲ per foot

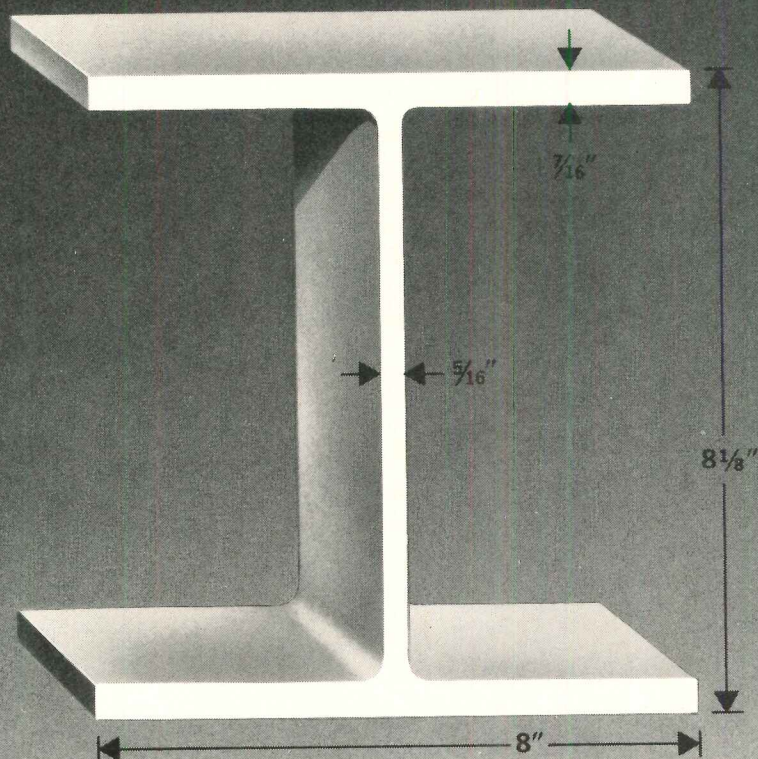

35 lb/ft

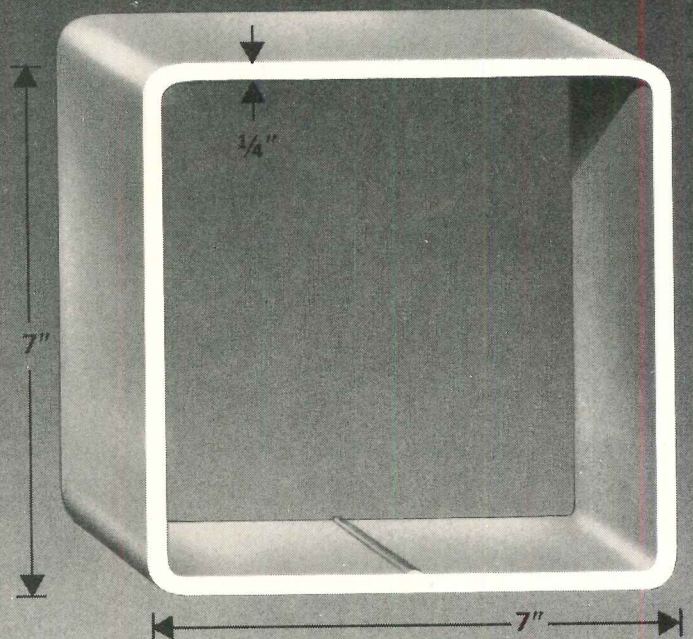

22 lb/ft

compare these advantages of square tubing over wide flange sections!

- 34% GREATER RADIUS OF GYRATION
(greater resistance to twist)
- 13% GREATER MOMENT OF INERTIA
(less bending and buckling)
- 28% GREATER YIELD STRENGTH
(higher ultimate load)

- 37% LESS WEIGHT
(cost savings)
- 37% LESS SECTION AREA
(25% less infringement on floor space)
- SUPERIOR APPEARANCE

AND NET COST SAVINGS OF 15.2% PER FOOT!



WELDED TUBE COMPANY OF AMERICA

SHUNK & VANDALIA STREETS
PHILADELPHIA, PENNA. 19148 • (215) 336-2000 • TWX: 710-670-0488
1855 EAST 122nd STREET
CHICAGO, ILLINOIS 60633 • (312) 646-4500 • TWX: 910-221-1347



the widest selection of
sizes and gauges in the
industry

ask for our
new brochure

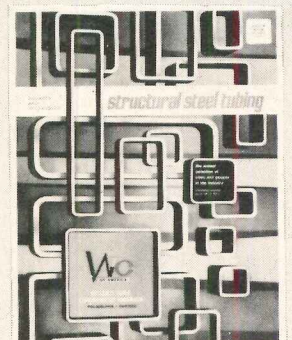

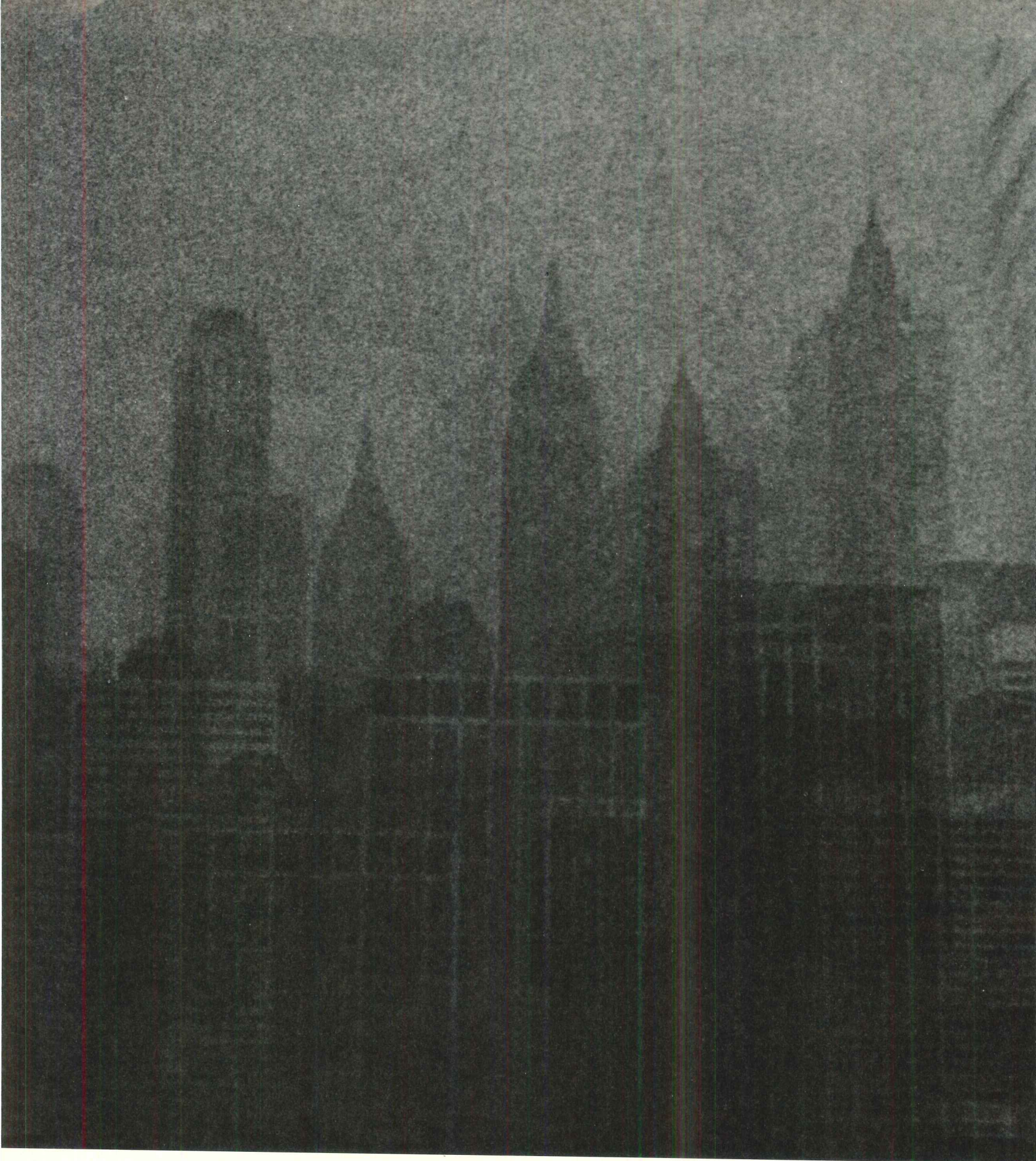

OUT OF DARKNESS...

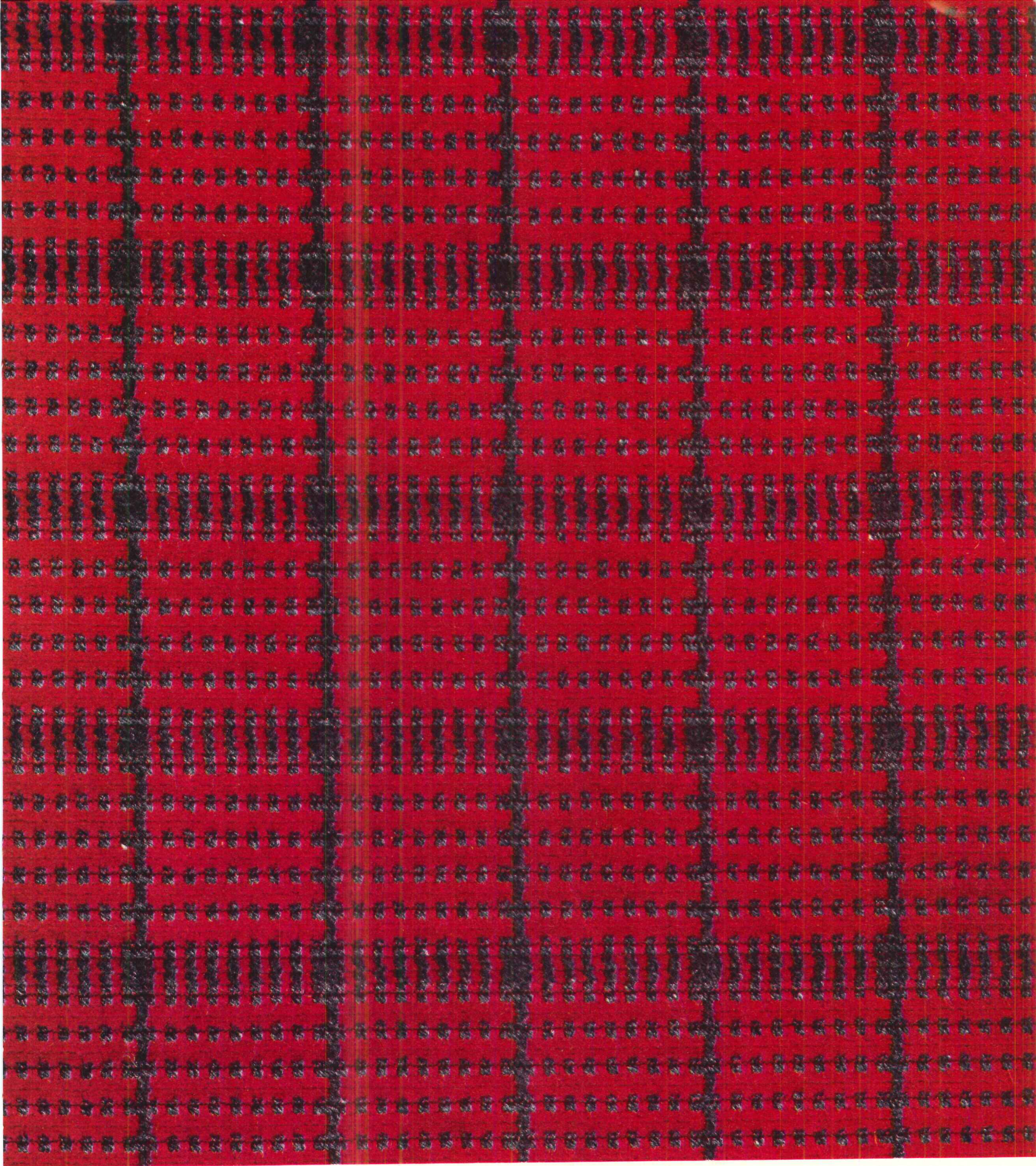

COMES THE LIGHT

How creative would you be if you had to work in darkness from 9 to 5? Then why impose it on others? Magee says stop darkness before it starts with their new carpet Alternates. 100% quality wool mark carpet. If you'd like to see the light: write The Magee Carpet Company, 919 Third Avenue, New York, N.Y. 10022...before it gets dark. A CARPET COMPANY THAT GIVES YOU ALL THE CREDIT FOR BEING CREATIVE.

CARPET BY
Magee

For more data, circle 10 on inquiry card



PURE WOOL PILE
The wool mark is your assurance
of quality-textured carpets made
of pure wool pile.

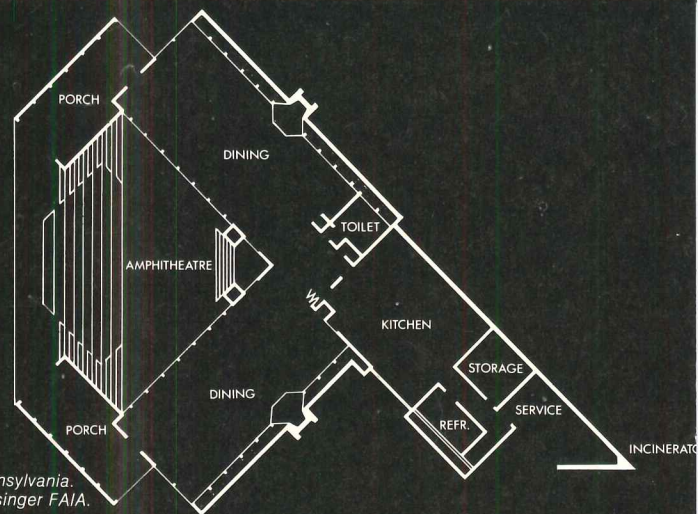

Girl Scout dining hall, Quakertown, Pennsylvania.
 Certigrade shingles No. 1 Grade, 18" Perfections. Architect: Frank Schlesinger FAIA.

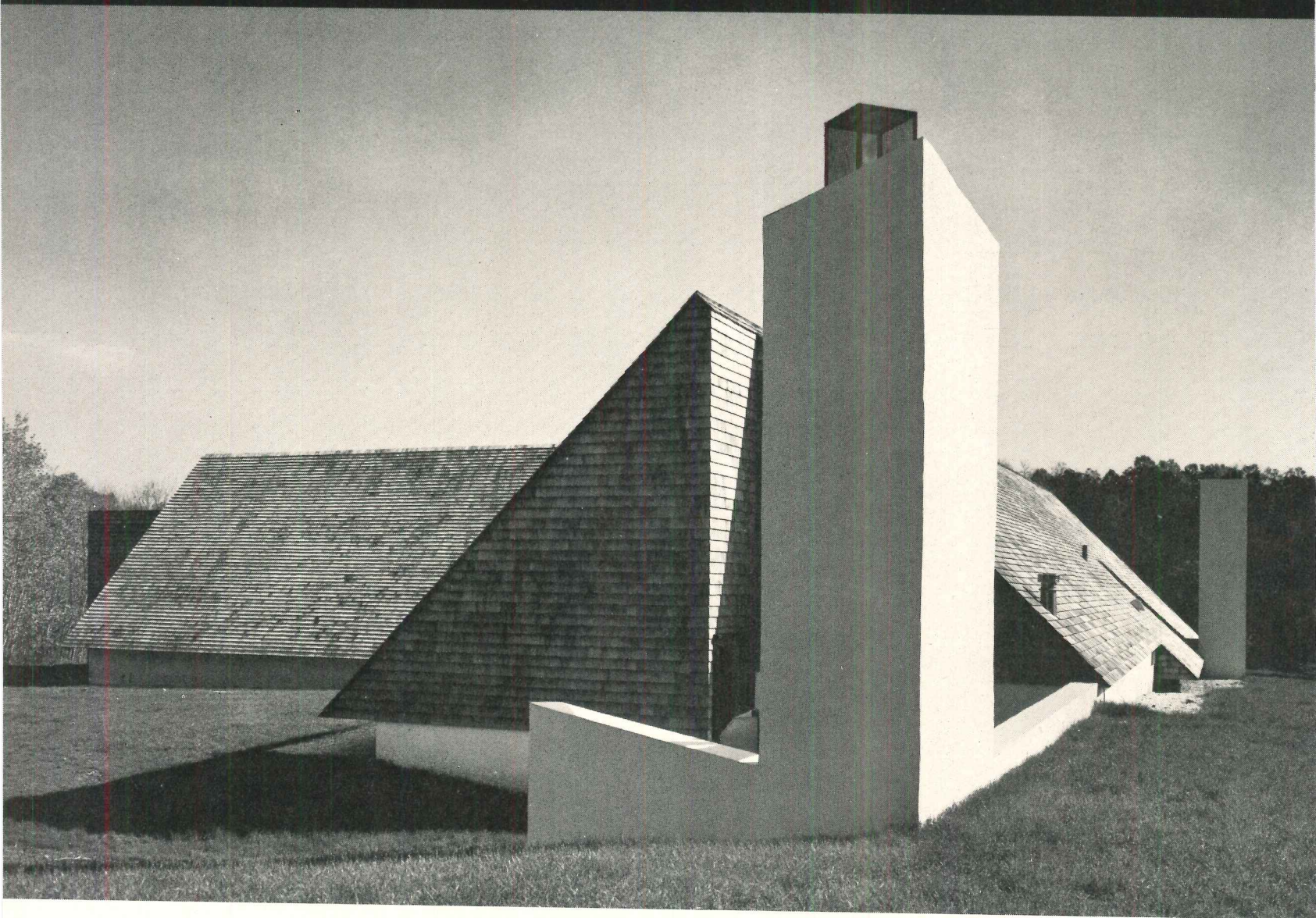

Red cedar shingles make a dining hall a feast for the eyes.

Few buildings have the architectural vitality of this dining hall at a Girl Scout camp in Pennsylvania.

The building is entirely covered by red cedar shingles. They implement the two key design requirements: low maintenance and a non-institutional look. The shingles will remain maintenance-free

for decades. And their rich-looking, natural texture is always inviting, never sterile.

The value of cedar goes further. While expressing the excitement of the design, these shingles also help the hall blend effortlessly with other rustic buildings at the camp site.

For your next design, insist on the real thing: red cedar Certigrade shingles or Certi-Split handsplit shakes. They're worth it. For details and money-saving application tips, write: 5510 White Bldg., Seattle, Wa. 98101. (In Canada: 1055 West Hastings St., Vancouver 1, B.C.)



Red Cedar Shingle & Handsplit Shake Bureau

One of a series presented by members of the American Wood Council.

For more data, circle 11 on inquiry card

a system of coherent equipment for hospitals

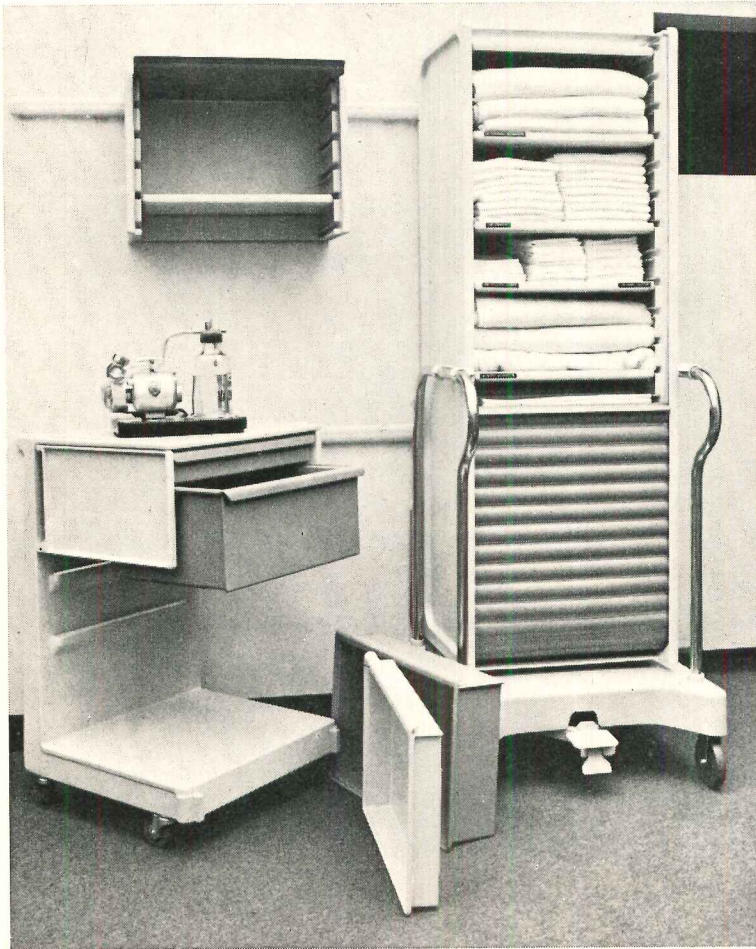

a flexible component system

In 1960, Herman Miller Inc. began researching the hospital to understand, develop and test a new equipment system. Equipment with interchangeable components usable in *all* hospital departments. One that eliminates separate material, supply and transportation subsystems operating in wasteful conflict with each other.

The result . . . co/struc. The product of eleven years of study and design testing.

An equipment system that:

- grows and changes with the hospital
- becomes mobile furniture usable in many areas in many ways
- is adequate in new or renovated facilities
- simplifies architectural requirements
- is a systematic way of thinking of the hospital as a whole

Available is a report that documents co/struc's development to its current stage of full production. Actual test installation photographs illustrate co/struc applications in such areas as patient rooms, central supply, nursing stations, laboratory and material handling use.

For a free copy of *co/struc*—a research report and more complete information about co/struc write or call:
Mrs. Nancy Jacobs
Health Care Group
Herman Miller Inc.
Zeeland, Michigan 49464
616 772 2161

Co/Struc is a development of the Herman Miller Research Corporation, and Herman Miller, Inc.

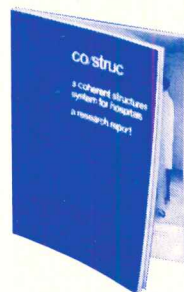

co/struc

 herman miller

health care group

For more data, circle 12 on inquiry card

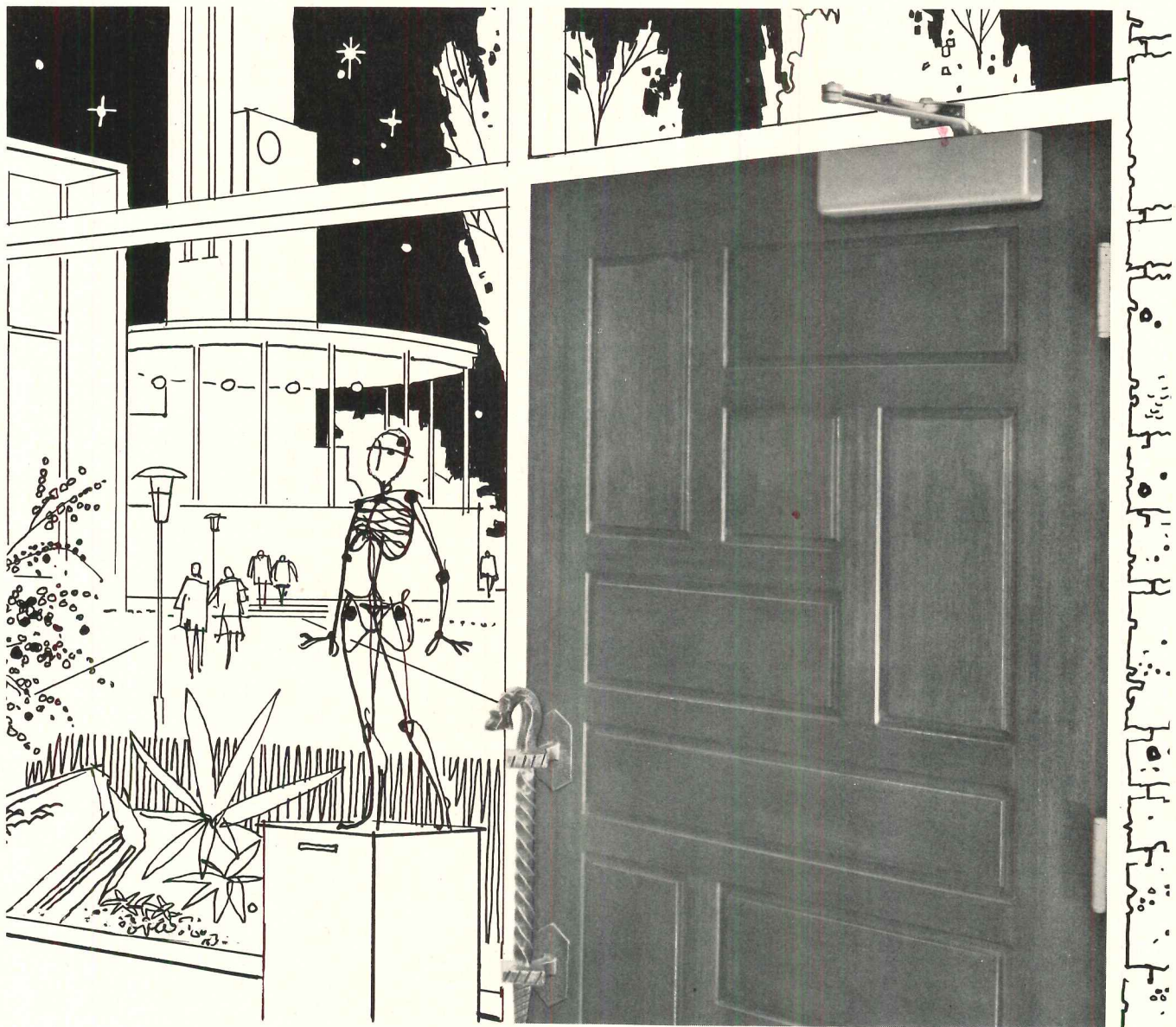

It's probably the most versatile door closer you can specify

It fits anywhere...

Is there anything that says it can't be attractive too?

the **Norton**[®] Apollo closer

1197

It's about as versatile as it can be. Plus or minus 25% spring power adjustment. A newly designed rack-and-pinion, plus adjustable back-check protection.

And it fits anywhere. It only has a 2" projection. With non-handed installation. And you can specify regular arm, parallel arm or top-jamb mounting.

Attractive? You bet... contemporary narrow-projection styling. Covers of anodized bronze, brass or clear aluminum; or 67 imported or native wood grains. Plus all popular finishes.

For complete details, contact your Norton Representative or Eaton Corporation, Lock and Hardware Division, Norton Marketing Department, 372 Meyer Road, Bensenville, Illinois 60106.

EATON Security Products & Systems

For more data, circle 13 on inquiry card

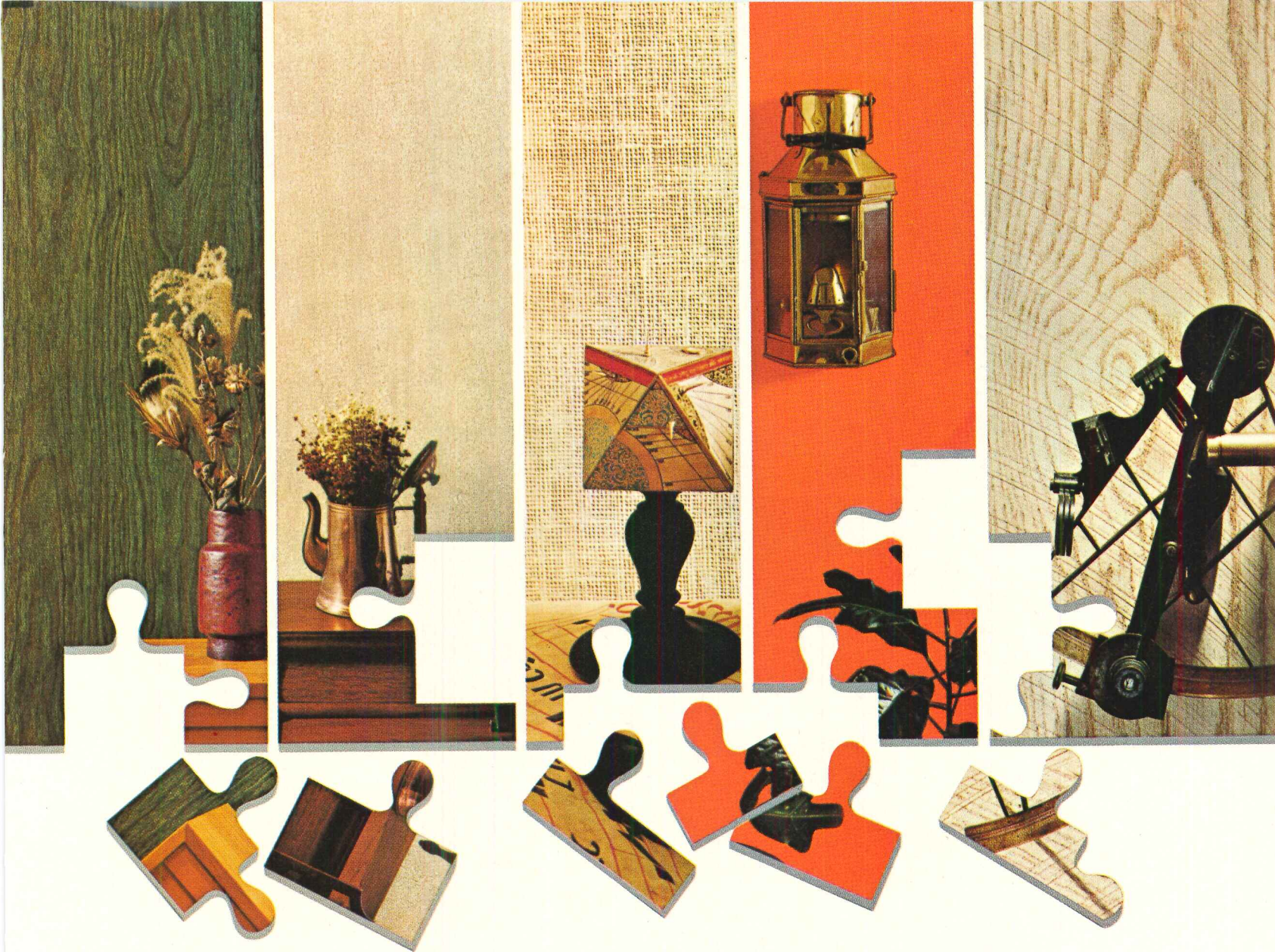

How to make hard-wear walls handsome.

TEXTONE* Gypsum Panels in new textures and colors put it all together for you. Touch tells the story of deep, deep textures that feel as real as they look. Twenty-seven colors and textures give you the latitude you need to create the unusual in decorator walls for stores, display salons, offices—any commercial application where walls must take a beating. **TEXTONE Gypsum Panels** are made of tough, washable vinyl, prelamated to **SHEETROCK*** gypsum wallboard. Matching moldings are available. And panels work perfectly with **U.S.G.** wall systems, including **USG® Demountable Partitions**. New colorful descriptive literature amplifies the exciting **TEXTONE** story. For your copy, contact your **U.S.G. Representative**; or write to us on your letterhead for sample swatches. 101 S. Wacker Dr., Chicago, Illinois 60606, Dept. AR-52

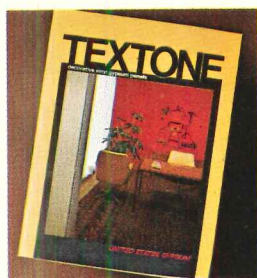

*Reg. U. S. Pat. Off.

UNITED STATES GYPSUM 
BUILDING AMERICA

For more data, circle 14 on inquiry card

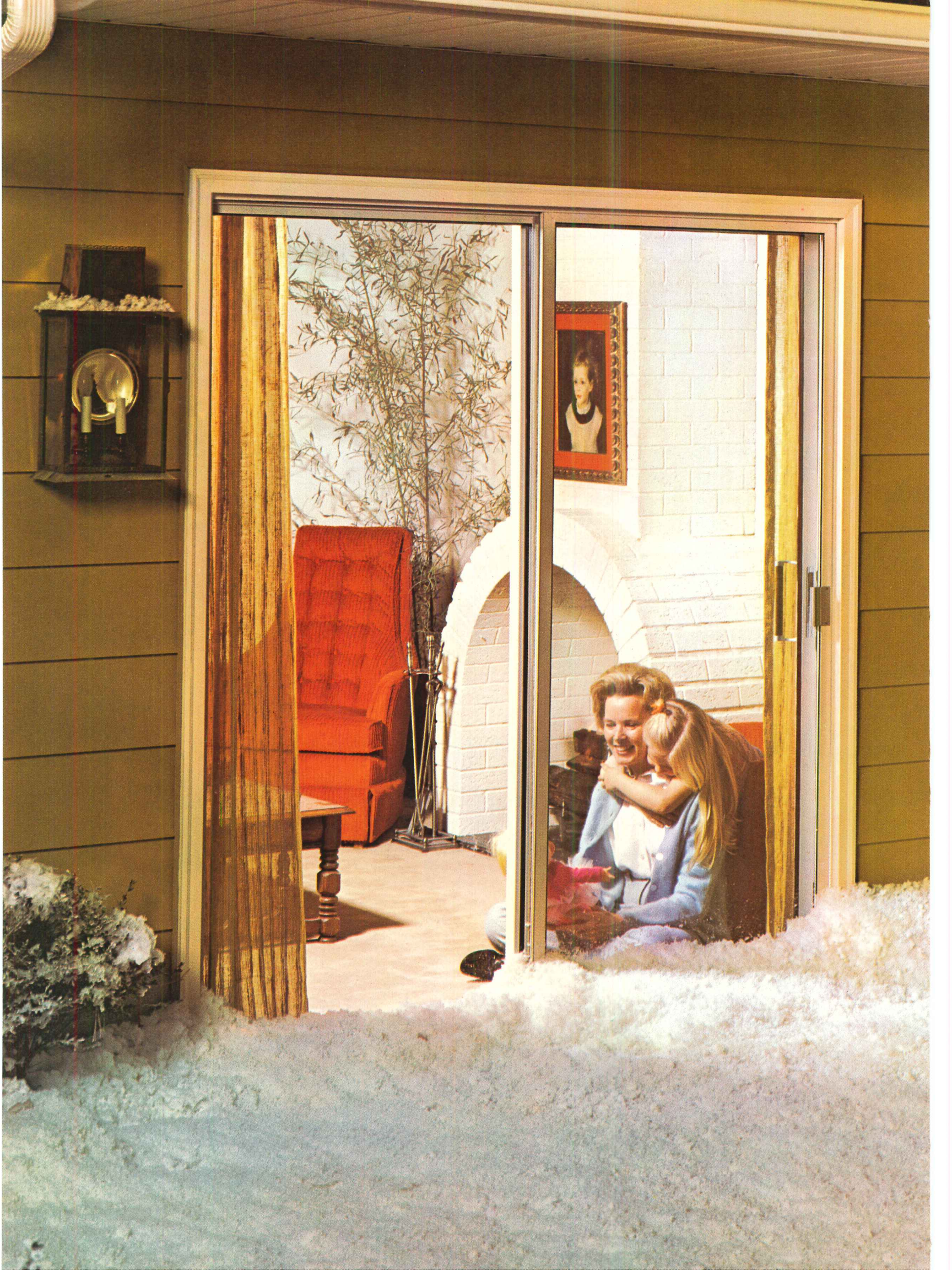

Announcing: Climate Guard[®] by Reynolds Aluminum

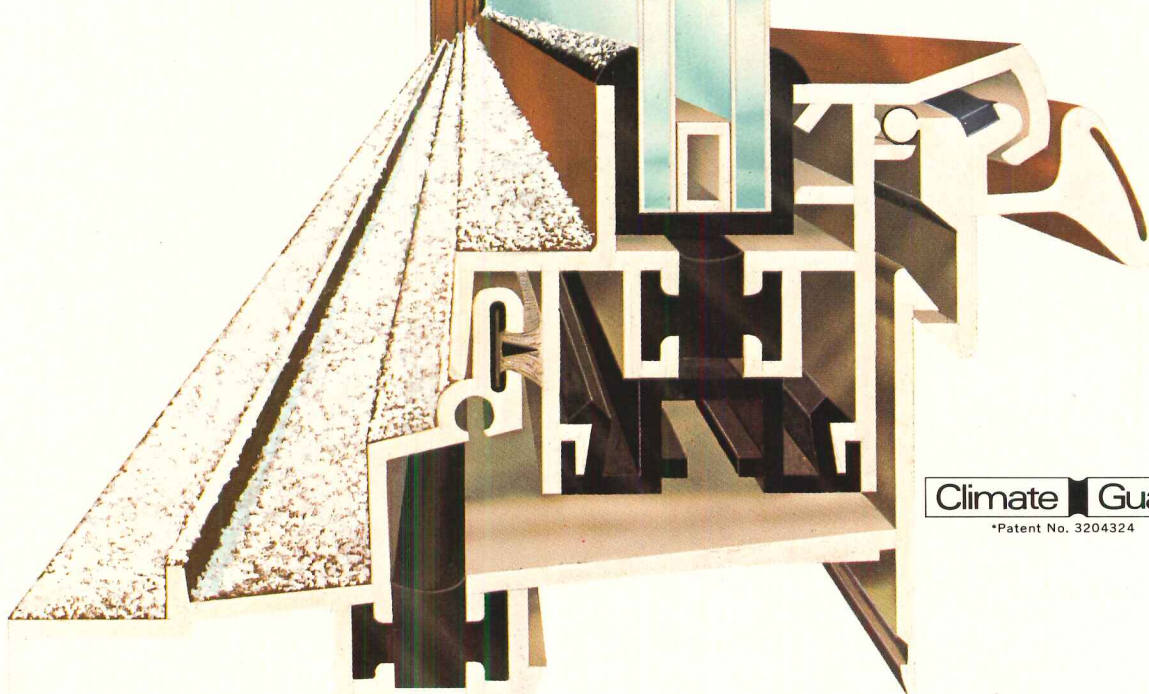

Climate Guard[®]
*Patent No. 3204324

The first major advancement in aluminum doors and windows since the development of insulating glass

Until now, aluminum windows and doors permitted thru-metal conduction in framing members. In cold weather, the result was condensation and frost build-up on the frame. Not anymore.

Now, there's Reynolds Aluminum Climate Guard windows and doors with an exclusive patented polymer thermal barrier. A specially designed thermal break that minimizes condensation by keeping inside surfaces warmer. This combination of the Reynolds Aluminum extrusion with Climate Guard forms a solid thermal barrier between interior and exterior sections. A barrier that effectively keeps cold out in winter, heat out in summer. Climate Guard doors and windows do the best work in temperature extremes. When it's 5 degrees outside and inside temperature is 70 degrees at 35% relative humidity . . . properly adjusted Climate Guard doors and windows show no condensation or frost build-up on

the aluminum frame members. No more damage to drapes, carpets, walls or sills. And there are other benefits.

They've been engineered to be strong and tough enough to stand hard usage. They're practical, easy to install and economically priced. They're available in silver mist, bronze and white Colorweld[®] finishes. Shouldn't you choose the finest doors and windows? Aluminum Climate Guard doors and windows with Reynolds reputation for quality behind them. We'll send you a free extrusion sample and all the details on this exciting new advancement. Just write to: Reynolds Metals Company, P.O. Box 25670, Richmond, Virginia 23260.



REYNOLDS
for better building products in
ALUMINUM

Katzenbach and Warren wall coverings include everything from roller-printed wallpaper to exquisite woven textures from the Orient. It is the only authorized maker of Williamsburg® Wallpaper Reproductions—each representing in color and design a faithful reproduction of original antique documents in the Williamsburg Collection. **Contact** Bernard Salembier, New York (212) 759-5410

Raymor/Richards, Morgenthau brings together for your selection the largest collection of decorative accessories available anywhere: specialty furniture, all types of contemporary accessories, lamps, wall decoration, sculpture, clocks, art; and craft-related products of wood, metal, ceramics and crystal. **Contact** Everett Winters, Ridgefield, N. J. (201) 941-0220

Moreddi offers imported and domestic avant-garde furniture. Particularly noteworthy is the exciting Artemide collection of Italian fiberglass chairs, tables and lamps—a line that can add distinctive contemporary elegance wherever it's used. **Contact** Ed Frank, Ridgefield, N. J. (201) 941-0220

Bloomcraft markets an extensive line of beautifully styled fabrics, bedspreads, decorative pillows, draperies, case-ments and imported sheers of fine quality at surprisingly modest prices. An excellent source for those special touches that can set your overall scheme apart. **Contact** Lewis Bloom, New York (212) 683-8900

Selig is a major manufacturer of classic contemporary upholstered furniture and a leading importer of contemporary metal and glass furniture. Newly added are important lines of chrome and glass Italian imports, including chairs, tables, étagères and SleepAway convertible sofas. **Contact** Bob Wexler, Leominster, Mass. (617) 537-9111



Living Room Division features sofas and chairs which emphasize simplicity of design and excellence of workmanship, in the highest standards of traditional and transitional styling. Many with exclusive Beautyrest Comfortorc construction. **Contact** Todd Colvin, LaGrange, Illinois (312) 352-9110

IT'S ALL AT

Here's one source for everything you need to furnish with extraordinary flair and authority. An enormous range of products and stylings.

All within easy reach.

Financing may be arranged through American Acceptance Corporation, a Simmons partner com-

pany. Our International Division can help coordinate selection and delivery for installation anywhere. Go Simmons all the way.



Simmons Contract is a world leader in furnishings for the health care, innkeeping and educational fields. In addition to its own lines of institutional furnishings—beds, bedding, chairs, Hide-A-Bed sofas, office furniture, case goods and carpeting—Simmons Contract offers the products of all other Simmons partner companies for a fully coordinated design and furnishings capability. **Contact** Bob Costello, Chicago (312) 644-4060

Hausted offers the health care field a full line of specialized patient handling and transporting equipment, including the Tractionaid unit and Inval-Aid chair, and continues to lead the world in the development of coronary and intensive care units. **Contact** Art Murphey, Medina, Ohio (216) 722-1515

Thonet occupies a unique position in wood and metal furniture for public use. Its chairs, tables and sofas are featured in schools, colleges, health care institutions, offices and restaurants. From its traditional bentwood to classic and contemporary metal, wood and upholstered seating, to case goods, to the custom designing of built-ins, Thonet offers a superb balance of beautiful styling and durable design. **Contact** Joe Quarles, New York (212) 725-1100

Greeff offers prestige lines with fashion authority. A leading supplier of imported and domestic fabrics—in both traditional and contemporary designs—for draperies and upholstery. Other important lines include coordinated wall coverings, carpeting, area rugs and exclusive Beautyrest Masterpiece bedding. The E.C. Carter Division distributes an exquisite collection of curtains, sheers and casements. **Contact** Ted Greeff, Port Chester, N.Y. (914) 939-6200.

SIMMONS.

SIMMONS COMPANY Domestic Divisions and Affiliates: Living Room • Contract • Juvenile Products • Hausted • Thonet • Greeff • Bloomcraft • Katzenbach & Warren • Raymor/Richards, Morgenthau • Moreddi • Selig • American Acceptance • York-Hoover • Elgin Metal Casket □ International Operations: Simmons Limited, Canada • Simmons de Argentina, S.A.I.C. • Simmons Bedding Co., Pty. Ltd. and V. S. Wright & Sons, Pty. Ltd., Australia • Sleepzee Limited and Warner & Sons Limited, England • Cie. Continentale Simmons, S.A., France • Cia. Italiana Simmons • Simmons Japan Limited • Compania Simmons, S.A. de C.V., Mexico • Simmons, Inc., Puerto Rico • Simmons de Venezuela C.A., Venezuela.

For more data, circle 15 on inquiry card

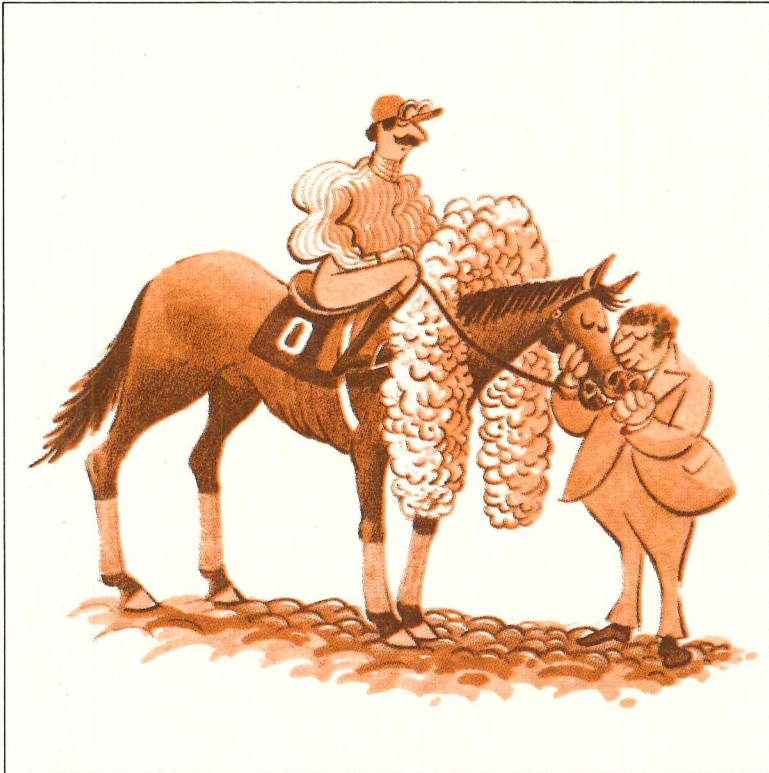

Anything can happen

at the track. The racehorse, Dragon Blood, ridden by Lester Piggott in the Premio Naviglio in Milan, Italy, on June 1, 1967, went off at 10,000 to 1 odds, the longest in racing history. He won.

From the GUINNESS BOOK OF WORLD RECORDS, ©1971 by Sterling Publishing Co., Inc., New York

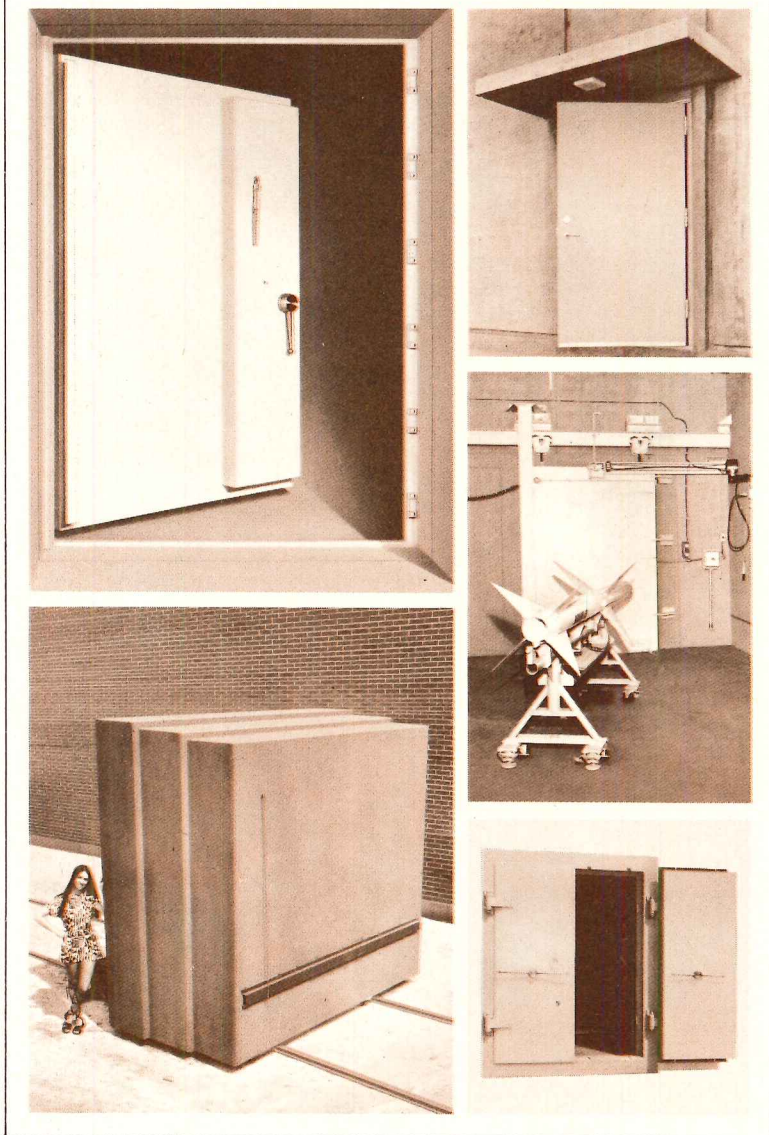

And anything can happen at Overly

Like doors that plug nuclear reactor cores.

We build doors that can resist or shield you from almost anything: atomic radiation or particle bombardment, bombs, fires, rocket tests, a lunar takeoff, gunfire or a noisy nearby tuba player.

You may need a door to resist lower pressures, or one that can take up to 300 psi peak incident pressure. No matter what kind of acoustical, shielding, fire or blast door you need, our computer will simulate all factors. Then we'll take all its information and custom-make the doors and frames to meet your specific need.

Anywhere protection is a problem, there's an Overly door to solve it. At Overly, anything can happen . . . and it happens for the good. We have plants in Greensburg, Pa., and Los Angeles, Calif. For more information, contact Overly Manufacturing Co., Dept. 19, West Otterman St., Greensburg, Pa. 15601.

overly
MANUFACTURING CO.

For more data, circle 16 on inquiry card



Anyone You Know Here?



It's quite possible. The 140 TRUS JOIST marketing men . . . technical representatives who call on architects, developers and builders throughout the United States and Western Canada, are on the move.

■ When it comes to roof and floor structural systems this is the most highly trained and knowledgeable marketing team in the nation. And they're backed by an engineering staff which includes eight professional and five graduate engineers plus more than fifty engineering technicians.

■ Their product is TRUS JOIST, the unique wood and steel roof and floor joist which will carry more load per pound of weight than any structural system known. Because of that light weight it's a system which erects faster and makes possible less costly footings, bearing walls and foundations.

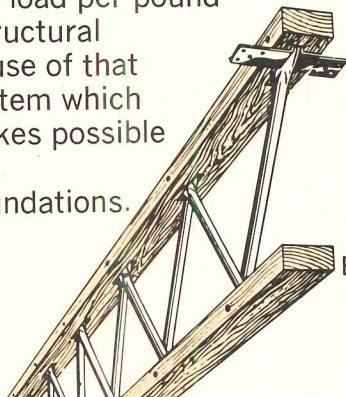

■ Wide nailable chords allow for fast attachment of low-cost roof decking and ceiling materials and open webs provide ample space for fast installation of plumbing, wiring and ductwork. Long spans too, up to 150 feet and they can be made in almost any profile you may want to design.

■ It all adds up to a quality system which goes in place quickly and provides real labor savings. That's why this group contains some very busy men, but not so busy that they can't find time to give you service . . . service which could include a complete design manual . . . information on specific types of buildings or a free and accurate cost estimate on your next project.

■ Just ask. We'll put you in touch.

trus Joist[®]

9777 CHINDEN BOULEVARD

BOISE, IDAHO 83702

Eleven strategically located plants serving the United States and Western Canada. Sales offices in principal cities.

For more data, circle 20 on inquiry card

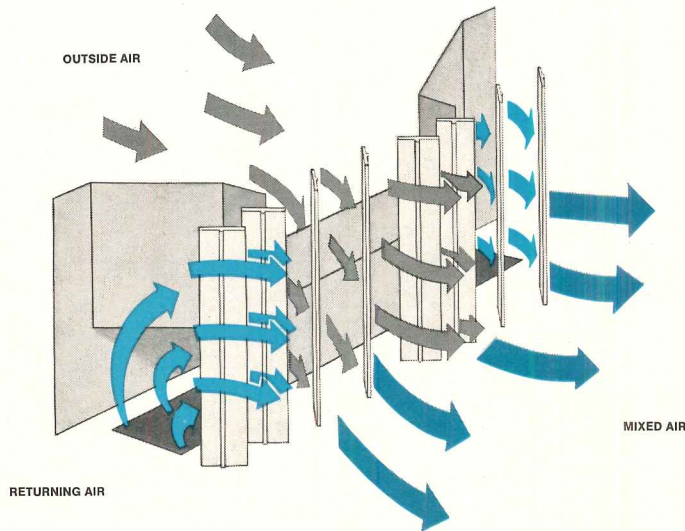

The "eyes" have it in single zone units.

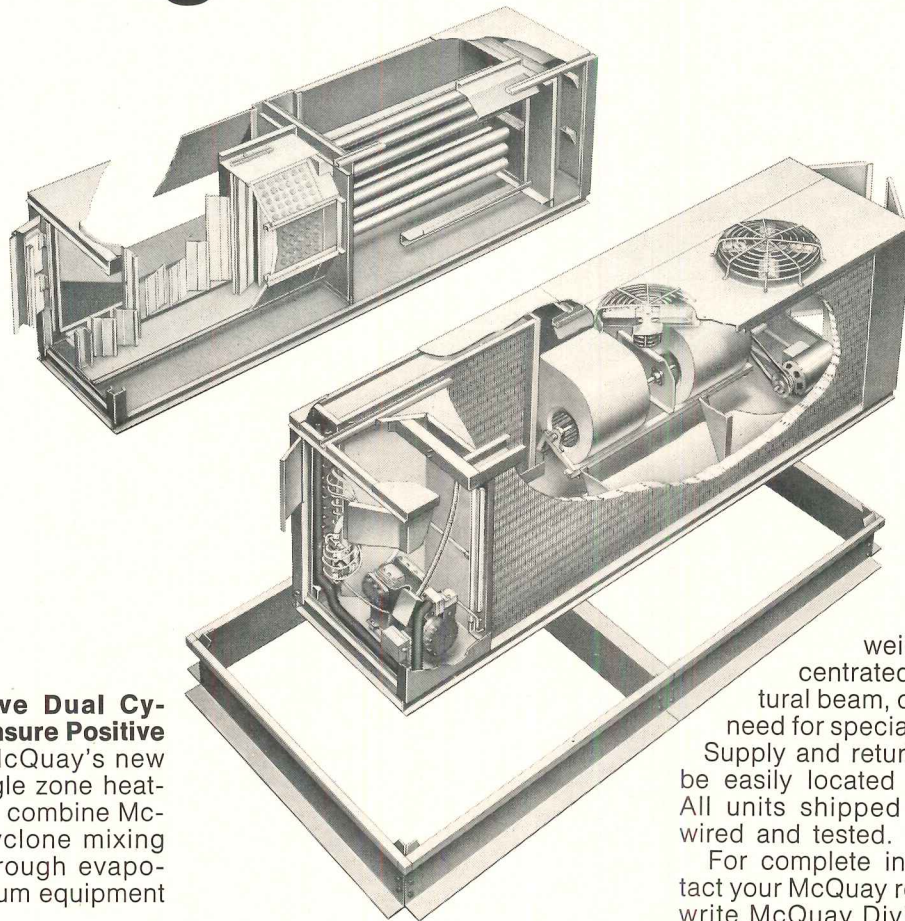

McQuay's Exclusive Dual Cyclone Mixing Eyes Insure Positive Comfort Control. McQuay's new line of Roofpak® single zone heating and cooling units combine McQuay's exclusive cyclone mixing action with draw through evaporator coils for maximum equipment efficiency and life.

Dampers are positioned to create two turbulent cyclone mixing eyes, giving a more efficient mix of outside and return air and virtually eliminating air stratification. Reduces the possibility of uneven temperatures across the evaporator coil, inefficient heat transfer and humidity control and possible

compressor damage from liquid slugging.

Cooling capacities from 15 to 35 tons, gas furnace heating from 285 to 760 MBH. Air delivery capacities are based on 400 CFM per ton and can be varied to provide 300 to 500 CFM per ton. Units designed to be roof or ground mounted. If roof

mounted, most weight can be concentrated on main structural beam, often eliminating need for special reinforcement. Supply and return openings can be easily located between joists. All units shipped factory piped, wired and tested.

For complete information, contact your McQuay representative or write McQuay Division, McQuay-Perflex, Inc.

Look to the systems leader...



McQUAY-PERFLEX INC.

Box 1551, 13600 Industrial Park Blvd., Minneapolis, Minnesota 55440.

For more data, circle 21 on inquiry card

News in brief

The volume of new construction work designed by architects declined slightly (2 per cent) in February. After adjustments for seasonal variations, the F. W. Dodge Index of architectural construction entering the contract stage stood at 151 (1967=100). The weak area in February statistics was apartment building where a 10 per cent seasonally-adjusted decline offset moderate gains made in the non-residential area. After hitting a record rate in December, apartment contracting fell sharply in both January and February. The seasonally-adjusted value for February was 25 per cent below December's peak. In the nonresidential area, industrial and commercial building showed gradual but continued improvement—public buildings and hospitals posted strong gains. One weak area in the expanding nonresidential building market is the educational category which declined 10 per cent during the month.

GSA has requested separate preliminary proposals without price for construction management on three California projects: Federal youth correctional facilities in Los Angeles (\$7 million) and San Diego (\$4 million), and Federal metropolitan correctional center in San Diego (\$12 million). Submissions were due April 17. GSA will request prices from selected proposers after evaluation.

Robert J. Nash, a Washington, D. C. architect, has been awarded the first Whitney M. Young Jr. Citation from The American Institute of Architects. The citation, established in 1971, is being presented to Nash for his significant contribution in initiating and directing the Institute's programs in the area of social concern. He will be presented the Citation in May during the 1972 convention of the 24,000-member organization in Houston.

The New York State Dormitory Authority has been awarded the AIA's 1972 Citation of an Organization. The Authority was created in 1944 and in the past quarter century has financed construction of \$1 billion worth of academic facilities involving more than 80 architectural firms. Many of the Authority's projects have won local design awards.

New York architect Richard Meier is the recipient of the 1972 Arnold W. Brunner Memorial Prize in Architecture. The \$1000 award is made annually by the American Academy of Arts and Letters and the National Institute of Arts and Letters.

The first Operation Breakthrough homes were occupied last month in Horizon Village, Kalamazoo, Michigan. In a related development, HUD officials announced 24 more new Breakthrough projects to be built in various parts of the nation. These will form part of Phase III which will begin with more than 5000 units already approved.

The National Academy of Design has awarded its highest architectural honor to the Philadelphia firm of Vincent Kling & Partners. For excellence in design of the Armstrong Cork Company's Design Center in Lancaster, Pennsylvania, Kling received the Academy's Samuel F. B. Morse Medal.

The Portland Cement Association announces the 1972 White Cement Architectural Awards. Any building that is designed by an architect registered in the United States and that makes significant use of white concrete can qualify provided that construction was completed between January 1 and December 31, 1971. For further information: Portland Cement Association Awards Program, Old Orchard Road, Skokie, Illinois, 60076.

Two international congresses of architects will be held this summer and fall in Brazil/Paraguay and Bulgaria. The 14th Congress of the Pan American Federation of Architects, the oldest international professional society, will convene June 10 in Sao Paulo, Brazil for five days and then shift in a reconvened session to Asuncion, Paraguay extending through June 18. The meeting of American architects will focus on urban deterioration, examining its root causes in order to be able to plan the measures necessary for effective development policies. Richard Sharpe, FAIA, of Norwich, Connecticut, second vice president of the Federation, will lead the United States delegation to the Congress which 3,000 architects are expected to attend. Registration fees are \$50 for architects; \$30 for personal guests.

Architecture and Recreation is the theme of the 11th World Congress of the International Union of Architects to be held September 25-30, 1972, in Varna, Bulgaria. Between 3,000 and 4,000 architects from all parts of the world are expected to attend this meeting at the Varna Sports Palace. Registration fees are \$70 for architects; \$50 for students, personal guests, and observers. These prices will increase 2 per cent after June 25.

For registration forms, hotel and tour reservations, or other information on both congresses, contact Maurice Payne, AIA Headquarters, 1785 Massachusetts Avenue, N. W., Washington, D. C. 20036.

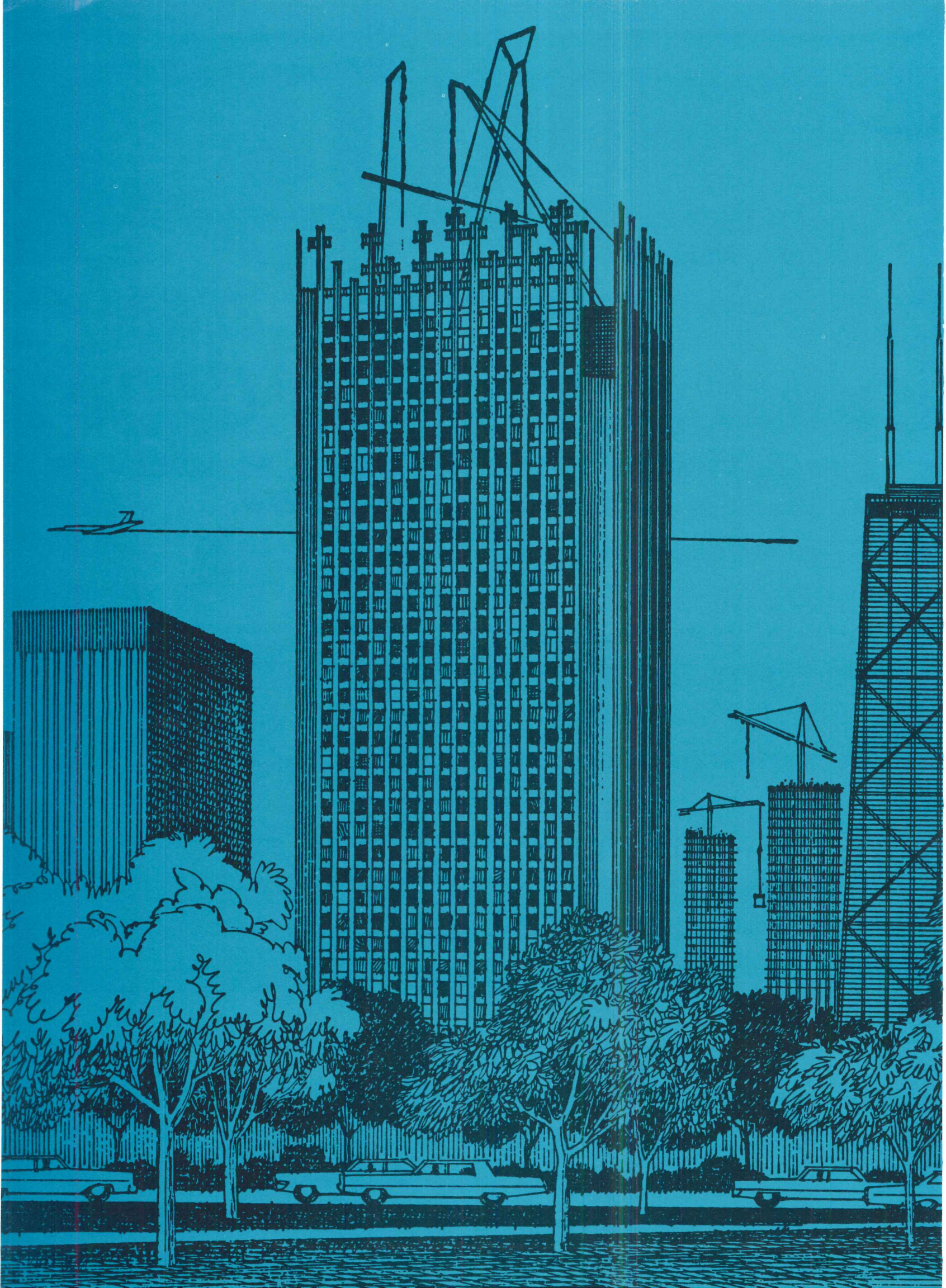

FIXED PARTITIONS:
Plaster and drywall assemblies; masonry, metal framed, wood framed, laminated types; all sound and fire-rated to meet job requirements.

MOVABLE PARTITIONS:
2 1/4", 3", 3 3/8", 3 1/2", 5 1/8", 6" widths; sound and fire-rated to meet job requirements.

SHAFT WALLS:
Plaster and drywall assemblies; cavity or solid construction; sound ratings up to 51 STC; 2 and 3-hour fire ratings to meet job requirements.

CURTAIN WALLS:
Masonry or stucco exterior; drywall or plaster interior; assemblies offer up to 4-hour fire resistance.

CEILINGS:
Plaster and drywall assemblies; mineral acoustical systems; air and heat distributing; 1 to 4-hour fire ratings; sound transmission ratings from 35 to 56 STC.

WALL FURRING:
Metal channels or wood strips with drywall or plaster assemblies.

STRUCTURAL FIREPROOFING:
Column and beam; plaster, drywall, gypsum tile; 2, 3 and 4-hour fire ratings.

192 basic systems... and that's just for starters!

From there your choice keeps growing with a seemingly endless variety of U.S.G. systems and finishes. It's our way of making sure you get the exact result you want. Every time. Predictable. Proven. Precise. That's because U.S.G. quality products and today's advanced systems techniques are made to work together for optimum performance. Call your U.S.G. Technical Service man. See our catalogs in Sweet's. Or write to us at 101 S. Wacker Dr., Chicago, Ill. 60606, Dept. AR-52.

UNITED STATES GYPSUM
BUILDING AMERICA

For more data, circle 22 on inquiry card

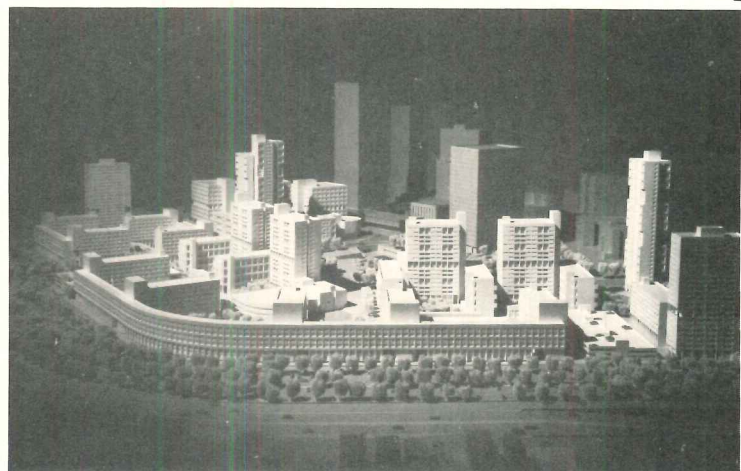

1

\$1.2 BILLION PRIVATELY FINANCED DEVELOPMENT FOR LOWER MANHATTAN. With the unveiling of Manhattan Landing, a mile-long housing, commercial, cultural and recreational development to be built on platforms between the bulkhead and pierhead lines extending from the Staten Island Ferry to the Manhattan Bridge, the efforts of a unique and heartening alliance seem about to come to fruition. As Mayor Lindsay said at the press conference, "Manhattan Landing is the result of an unprecedented partnership between government and the private sector."

The Downtown Lower Manhattan Association (DLMA), a group of businessmen, did the first Lower Manhattan plan (under former Mayor Robert Wagner) which goaded the city into doing its first comprehensive area plan. The Office of Lower Manhattan Development—an adjunct of the Mayor's office—was established to implement the City's plan. Directed by Richard Weinstein since 1969, this is the first of Lindsay's horizontal agencies—"a substantial and significant governmental invention," according to Weinstein—designed to coordinate activities of the vertical agencies. Weinstein has worked closely with the DLMA and its chairman, David Rockefeller, who, Lindsay says, "has been the spark plug and the adhesive tape that has pulled together so much of this plan." Most of the private sector involvement has been realized through the efforts of the DLMA, says Weinstein who emphasizes that the daily professional confrontations between his office and the DLMA solved many problems before they arose. He says the future of cities such as New York depends on cooperation at this scale between public and private sectors.

Manhattan Landing will consist of 88 acres of new land and 25 acres of restoration sprinkled with

new structures in the South Street Seaport area.

The participating mortgage formula developed for the first phase of housing—consisting of 3500 units, 1750 on either side of Jeannette Park—is designed to result in rents of \$115-120 per room per month in 1976. (Conventional financing would produce rents of \$180 per room per month which is not considered marketable.) Private lenders are to supply 75 per cent of the money at below par interest rates, as low as 7 per cent it is hoped. 20 per cent is to come from the Housing Development Corporation which will sell bonds that will be paid back so this is not really public subsidy. 5 per cent will come from developers' equity. The second phase of housing, also 3500 units beside Jeannette Park, may or may not be financed this way but there is an understanding now that this formula will continue to be used.

Another 2500 units are to be built above a municipal garage which will provide the platform for the housing. In this case, a tax abatement formula designed to spur construction on vacant land will also contribute to achieving the low rental range. It is hoped that the development of the South Street Seaport, which will include approximately 500 housing units, will provide the amenities that will reduce the critical turnover of employees in Lower Manhattan which is attributed to a lack of shops, restaurants, theaters, etc. The Seaport will be a self-sustaining cultural enterprise because the revenue from commercial enterprises, such as restaurants and spice shops, on land given to the Seaport by the City, will go back into the Seaport. This will enable them to continue rehabilitating ships and such programs as taking ex-narcotic addicts out in summer to teach them sailing.

This project is expected to house up to 50,000 people—mostly junior executives and middle management—and to bring in \$27 million in taxes (on land now earning \$500,000) which, it is thought, will contribute more to helping the low-income housing problem than incorporating low-income housing here, which can't be done as there is no subsidy money available.

The architects so far designated are: Davis, Brody & Associates for housing around Jeannette Park developed by DeMatteis and Uris; Horowitz and Chun for the garage and housing above it to be developed by Arlen and Tishman. Edward Larrabee Barnes is doing a feasibility study for the Trump Organization for an office-apartment-hotel-transportation building on the site of the Staten Island Ferry Terminal.

The Board of Estimate will debate the plan on May 17th; then each lease will come up for its approval. A public hearing before the City Planning Commission will take place in early May. Construction of the platforms could begin in 12 to 18 months. Over half of the space should be ready for use by 1976 and completion is expected between 1980 and 1985.

NADER ON HOUSING

Ralph Nader predicted recently that deficiencies in housing would be an issue in the 1970's comparable to the automobile issues of the 1960's. And he said his office would become more and more active in trying to help the aggrieved homeowner.

His speech came down hard on FHA standards and what he considers the lack of explicit warranties on housing. FHA was described as the "leaky, shaky umbrella now facing the greatest crisis in its history." There must be an intensive investigation of HUD that results in

a jolt felt clear up to the top, he told the industry representatives.

He urged Secretary Romney to: 1) Appoint a well-funded investigative task force to determine exactly how widespread are the FHA malpractices, where they occur, and to develop evidence to be turned over to the Justice Department. This Task Force should have all the legal and accountant expertise it needs.

2) Appoint HUD people to determine what can be done to satisfy the aggrieved parties.

It is apparent that Nader and his raiders will be investigating voluntary standards, and probably building codes too, in their quest for greater consumer input to standards drafting and promulgation.

2

MAJOR RENEWAL FOR ROCHESTER'S SOUTHEAST LOOP

Gruzen & Partners are the architects and planners for a mammoth urban renewal project to be carried out in Rochester, New York under the auspices of UDC-Greater Rochester, Inc., a subsidiary of the New York State Urban Development Corporation. The new town, downtown, will include 3100 units of housing, office space, commercial space, a new school, a theater, and numerous other cultural facilities. A new, 6-acre park, at the heart of the project, will be designed by Halprin and Associates. The developers hope to offer a variety of amenities that will attract people from all social, economic and racial backgrounds.

Construction of the first housing units—(photo above) is now underway. Completion of the entire project is scheduled for 1978.

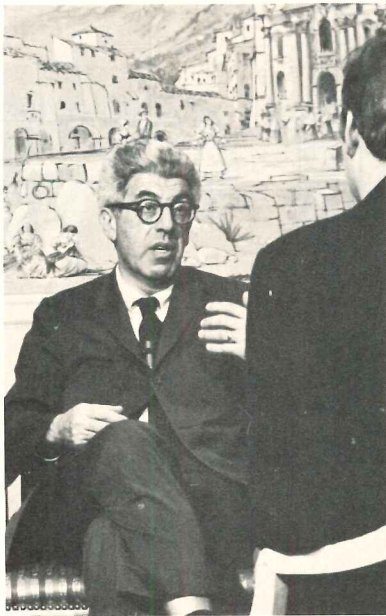

3



4



5

3

LIFESTYLE 2000

In Chicago last month, some 300 architects and product designers heard experts from six different fields discuss their views of what we can expect in life styles and environment by the year 2000. Sponsored by American Iron and Steel Institute, the seminar was called "Lifestyle 2000: Designing for the Third Millennium."

One of the six speakers, Barry Commoner, author of the best seller on ecology, *The Closing Circle*, analyzed causes of our present environmental crisis. He said that a series of adverse displacements have occurred: detergents for soap; synthetic fibers for natural fibers; plastics and aluminum for steel and wood; and chemical fertilizers and pesticides for natural acreage. In these changes, new technologies have greater impact on the environment than older ones. Resolution of the crisis requires massive re-design of present technology, said Commoner, director of the Center for the Biology of Natural Systems of Washington University, St. Louis, Missouri.

Thomas Martin Payette, president of the Boston architectural firm of Markus, Nocka, Payette and Associates, Inc., spoke on the subject of structures. He said that our society is living in a man-made environment established on the wrong priorities and goals. He is hopeful that the social goals of young architects will help evolve buildings which are more meaningful and more suited to human needs.

Richard E. Paret, assistant vice president of American Iron and Steel Institute, described new and more versatile steels which will continue to help shape the future of civilization. He explained that steel is not one, but a family of 30,000 related materials, half of which were developed in the last decade.

The seminar was presented with the endorsement of the Midwest Chapter of the Industrial Designers Society of America and the Chicago Chapter of the American Institute of Architects. Other speakers were Max Kaplan of the University of Florida, Arthur J. Poulos of Poulos Design Associates, Inc. and Jeffrey T. Hamilton of NASA.

4

NEW ENERGY CONSERVATION AWARD

The Owens-Corning Fiberglass Corporation announces a new award program to encourage an awareness of the need to conserve our natural energy reserves and to reduce environmental pollution. The competition is open to all registered architects and licensed engineers practicing in the United States. Completed building or buildings in construction or under design at the date of entry may qualify. Entries must be submitted by August 31, 1972 and a letter of intent to enter must be received by Owens-Corning not later than June 30, 1972. For further information: Energy Conservation Award Program, Owens-Corning Fiberglass Corporation, Fiberglass Tower, Toledo, Ohio, 43659.

KENNEDY SUPPORTS WEST FRONT

Senator Edward M. Kennedy (D., Mass.) strongly supported The American Institute of Architects' opposition to the extension of the West Central Front of the U.S. Capitol, the last remaining original facade of the building. Speaking to the Fifth Annual Public Affairs Conference, sponsored jointly by the AIA and the Consulting Engineers Council, Senator Kennedy proposed a full round of public hearings and debate on what he termed these "ominous new plans."

5

AT HOME IN THE 80s

To explore lifestyles in the decade to come, BASF Wyandotte Corporation, a large U.S. chemical company, commissioned two teams of designers, sociologists, physicians and economists to plan some domestic interiors for the 1980s. Maximizing the use of space, the teams abandoned conventional concepts of single-use spaces. They favored multi-purpose areas and multi-functional furniture. Food preparation and service units are shown above along with a multi-use work station.

The design teams were headed by Professor Herbert Hirsche, dean of the Institute of Art in Stuttgart and a leading industrial designer in Germany and Professor Arno Votterler who teaches design at the Institute of Art in Brunswick, Germany.

AIA's NEW FAIAS

The AIA has announced that 79 members have been elected to the College of Fellows, a lifetime honor bestowed for outstanding contribution to the profession. Formal investiture will be held in ceremonies on May 8, during the AIA Convention in Houston. The 1972 Fellows are: Bruce A. Abramson, St. Paul; Gregory Ain, Los Angeles; Richard M. Arnold, Phoenix; Edward F. Bartz, Jr., Belleville, Ill.; Thomas J. Bissett, Columbia, S.C.; Robert Lewis Bliss, Salt Lake City; Robert D. Bolling, Los Angeles; David Rice Braden, Dallas; Joseph Myron Brocato, Alexandria, La.; Harry Alexander Bruno, Oakland, Calif.; James I. Campbell, Baltimore; DeVon M. Carlson, Boulder; Henry Nichols Cobb, New York City; William J. Conklin, New York City; Herman G. Cox, Jr., Fort Worth, Tex.; Raymond David Crites, Cedar Rapids; (Miss) Betty Lou Custer, St. Louis; Leo A. Daly, Omaha; Homer Delawie, San Diego; Martin David Dubin, Chicago; David L. Eggers, New York City; William Lloyd Ensign, Washington, D. C.; John Fisher-Smith, San Francisco; John Frederick

Gane, Philadelphia; Abraham W. Geller, New York City; Raymond Girvigan, South Pasadena, Calif.; Myron Goldsmith, Chicago; E. Carleton Granbery, Jr., New Haven; Francis S. Haines, Honolulu; Ernest H. Hara, Honolulu; Julian Hoke Harris, Atlanta; Morton Hartman, Chicago; Frank L. Hope, Jr., San Diego; Fred E. Hummel, Sacramento; W. Byron Ireland, Columbus, Ohio; Joe J. Jordan, Philadelphia; Carl F. W. Kaelber, Jr., Rochester, N.Y.; William Louis Larson, Omaha; Richard R. Leitch, Newport Beach, Cal.; Eason Harris Leonard, New York City; Allen Yuen Lew, Fresno, Cal.; Robert J. J. Locatelli, Atlanta; Louis R. Lundgren, St. Paul; Leslie B. Mabrey, Corpus Christi, Tex.; William Marshall, Jr., Norfolk; Robert B. Martin, Lincoln City, Ore.; Carrell S. McNulty, Jr., Stamford; Robert C. Metcalf, Ann Arbor; Maynard W. Meyer, Milwaukee; Henry Forster Miller, Orange, Conn.; Hugo V. Neuhaus, Jr., Houston; Julius Victor Neuhaus III, Houston; Rai Yukio Okamoto, San Francisco; Raymond Charles Ovresat, Chicago; Patroklos John Papadopoulos, Chicago; H. Morse Payne, Jr., Cambridge; William Merriweather Peña, Houston; Mark A. Pfaller, Milwaukee; Darrel D. Rippeteau, Watertown, N.Y.; Edward John Romienick, College Station, Tex.; Frederick William Salogga, Decatur, Ill.; Carlos R. Sanz, Santurce, Puerto Rico; John H. Schruben, Chicago; Nils Mark Schweizer, Winter Park, Fla.; Wallie E. Scott, Jr., Houston; Hugh Shepley, Boston; Joseph Newton Smith III, Atlanta; Macon S. Smith, Raleigh; Robert Stanton, Carmel, Cal.; Douglas E. Steinman, Jr., Beaumont, Tex.; Walter Stromquist, Palo Alto, Cal.; Edward Sullam, Honolulu; Gene R. Summers, Chicago; Alan Yamato Taniguchi, Austin, Tex.; Anderson Todd, Houston, Tex.; Wilhelm Viggo von Moltke, Cambridge; John Louis Wilson, New York City; Clark D. Wold, St. Paul; Thomas W. D. Wright, Washington, D. C.

Advancement of the new Fellows brings the total membership of the College of Fellows to 975.

Hide your air One way.

Carrier's all-air Moduline® System works its way into your ceiling design. Inconspicuously.

In buildings with loads up to 2 cfm/sq. ft.

And it treats every person that comes into the room. Individually. Because its extra-sensitive thermostat knows when to add or cut back the

cooling (and that's comforting to your client's utility bill).

Flush-mounted, the diffuser sections are interconnectable. And all controls are built in the unit. No wall thermostats or wiring.

It's a one-duct system, too—which saves space and uses less equipment.

But this is just the half of it.



conditioning. Or the other.

Carrier's all-air Dual Moduline® System is just as sensitive to warm bodies. But it's even less obvious in a ceiling. With 3" wide diffusers, handling loads of 3 cfm/sq. ft. and up.

Narrow as it is, it's the only unit to straddle partitions to cool two rooms independently. Allows unusual interior-change flexibility. Cuts moving-in costs

up to 50¢/sq. ft. It also uses one duct. Built-in controls. Interconnectable plenums.

Discover the hidden talents of both Moduline Systems. Working together. Or separately. Call our nearest office. Or write Carrier Air Conditioning Company, Syracuse, N.Y. 13201.

Carrier

air conditioning



New Parliamentary Building, London, first prize winner of a British Commonwealth competition, designed by Robin Spence and Robin Webster, will be opposite Big Ben and connected by a traveling sidewalk to Parliament. The bronze and glass clad block, topped by a structural steel grid, will house offices and amenities for 450 members of the House of Commons. Expected completion is 1978.

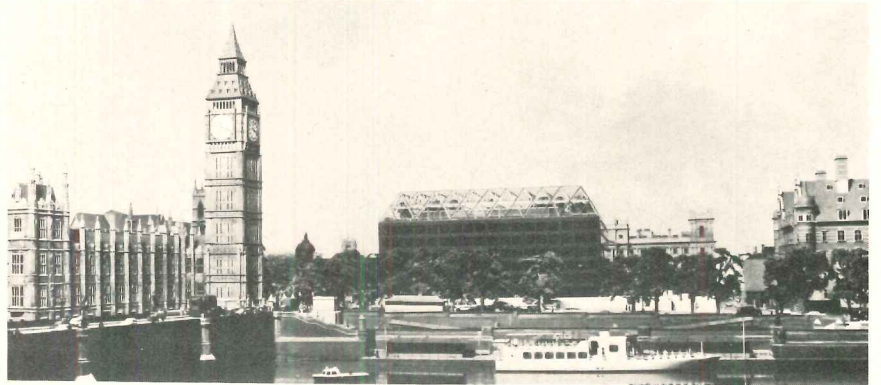
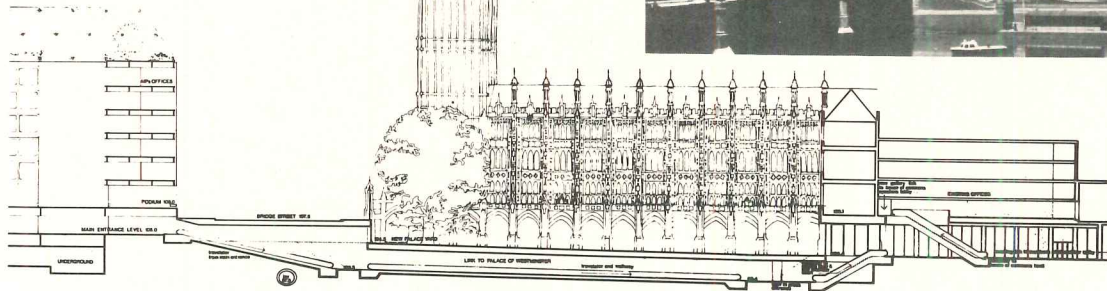

Architecture as Landscaping at 1972 Summer Olympics in Munich

Behnisch and Partner of Stuttgart, first prize winners of a nationwide competition in 1967 for the design of the 1972 Olympics facilities, conceived of the project as creating a landscape. The 740-acre-site, four kilometers from central Munich, consisted of a former airfield and exhibition ground and a dump for World War II debris and earth from subway excavations. Here it was possible—as not in Mexico or Tokyo—to concentrate almost all necessary facilities in one area. By landfill and excavation a 60-meter-high mountain (10 on site plan opposite) and an artificial lake (9) were created. On the north embankment is an open-air theater (8) at the edge of the 20-meter-high central plateau which is surrounded by the major structures: the stadium (5), sports arena (6) and swimming arena (7) conceived of as valleys supplemented by grandstands. The plateau enabled these stadia to be built according to the ancient model of earth stadia. Several other features—extending the plateau pavement into the foyer and using landscape colors in the seats, but above all the roof (by Behnisch & Partner with Frei Otto and Ewald Bubner, Leonhardt + Andrä)—integrate these structures with the landscape. It is meant to flow under the roof; and

walls and ceilings are as light and transparent as possible to permit this flow.

In addition to instigating four kilometers of new subway construction, 34 kilometers of road building or improvement and 32 bridges, the Olympic development will provide Munich with permanent sports, entertainment and recreation facilities, the largest college of physical education in Europe, and 4800 condominium and lease apartments designed by Heinle, Wischer & Partner and Eckert & Wirsing.

The size of the stadium—47,000 seats and 33,000 standing places with a maximum of 195 meters between spectator and athlete—was determined primarily by post-Olympics needs. The sports arena will house boxing and congresses later. The swimming arena has five pools and the school will have twelve gyms.



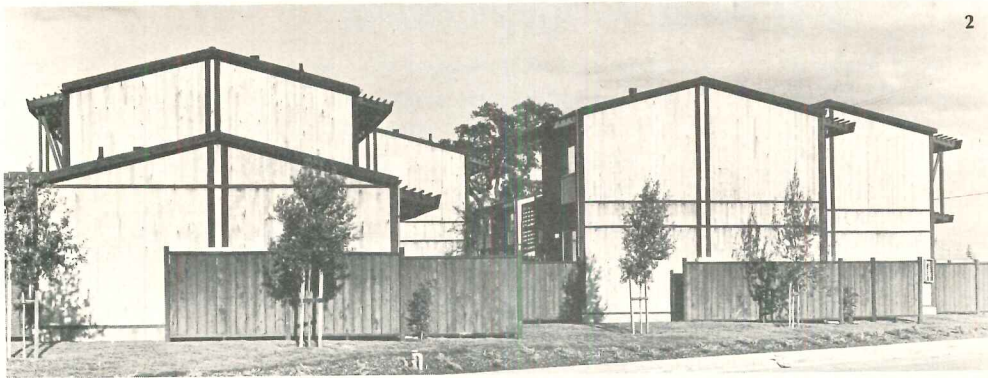

2

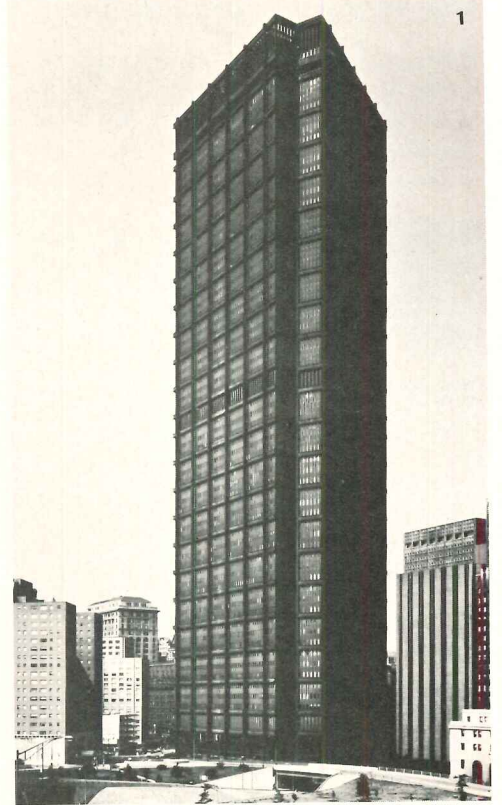

1

American Institute of Steel Construction Awards: (1) U.S. Steel Building, Pittsburgh, Harrison & Abramovitz, & Abbe; (2) Pierce Apartments, Gilroy, Cal., Dukor Assocs.; (3) Superbay Maintenance Facilities, San Francisco and Los Angeles, joint venture of Lev Zetlin Assocs. and Conklin & Rossant. Not shown: Tempe Municipal Building, Ariz., Michael & Kemper Goodwin Ltd.; Richmond Coliseum, Va., Ben R. Johns, Jr.; Northway 10 Executive Park, Elnora, N.Y., Robert F. Lavery; Alza Corp. lab and offices, Palo Alto, McCue Boone Tomsick (RECORD, June 1971, pages 128-129); Parker Hannifin Headquarters, Irvine, Cal., Albert C. Martin and Assocs. (RECORD, May 1972, pages 120-121); Sears Roebuck offices, Alhambra, Cal., Albert C. Martin and Assocs.;



3

Malcolm X College, Chicago, C.F. Murphy Assocs. (RECORD, May 1971, pp. 98-99); Burlington Corporate Headquarters, Greensboro, N.C., Odell Assocs. Inc. (RECORD, Feb. 1972, pages 118-121); Service Group, SUNY, Old Westbury, N.Y.,

James Stewart Polshek and Assocs. (RECORD, Feb. 1972, pages 97-100); Rapid Transit Stations (RECORD, Nov. 1971, pages 129-132) and John Hancock Center (RECORD, Jan. 1967, pages 137-144), Chicago, Skidmore, Owings & Mer-

rill; Paradise Steam Electric Generating Station Unit 3,, Drakesboro, Ken., Tennessee Valley Authority. The jury; John P. Eberhard, AIA; James H. Finch, FAIA, Dahlen K. Ritchey, FAIA; Edward J. Teal, M. ASCE; Max O. Urbahn, FAIA.

- 1 Equestrian stadium
- 2 Olympic Construction Company
- 3 Cycle stadium
- 4 Car Park
- 5 Stadium
- 6 Sports arena
- 7 Swimming arena
- 8 Open-air theater
- 9 Artificial lake
- 10 Panoramic view

- 11 Television tower
- 12 Small sports hall
- 13 Underground railway station
- 14 Olympic village
- 15 Radio and television center
- 16 Volleyball court
- 17 Metropolitan railway station
- 18 Training and warming-up facilities
- 19 Press city
- 20 Hockey fields

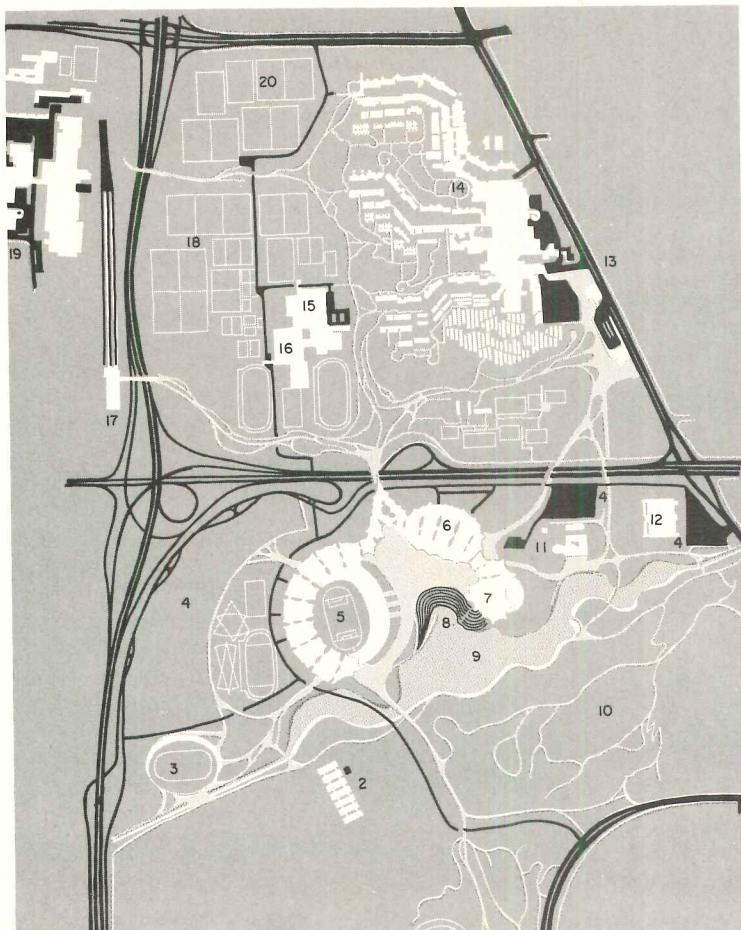

The 1972 American Institute of Architects Honor Awards and Bartlett Awards

Jurors for the 1972 Honor Awards program were: Henry N. Cobb, AIA, chairman, New York City; Antonin Aeck, AIA Association of Student Chapters, Atlanta; Gerald L. Allison, FAIA, Honolulu; John G. Dinkeloo, AIA, Hamden, Connecticut; Harry M. Weese, FAIA, Chicago; Harry C. Wolf, AIA, Charlotte, North

Carolina; Milton L. Grigg, FAIA, adviser, Charlottesville, Virginia. The premiated designs were selected from 470 entries. The jury for the Bartlett Awards consisted of members of the Potomac Valley Chapter of the AIA: William Baltzer Fox, James F. Hilleary and Edward H. Noakes.

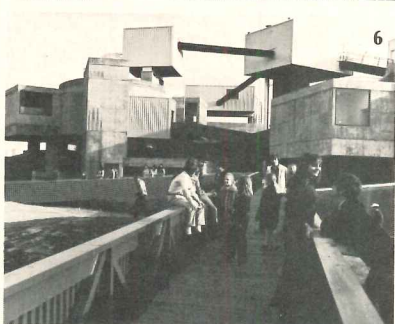
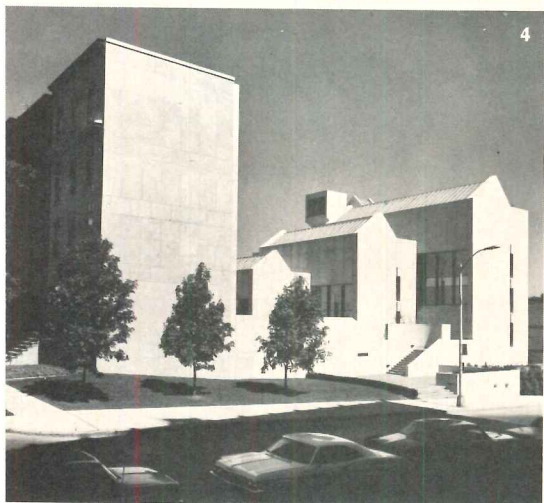
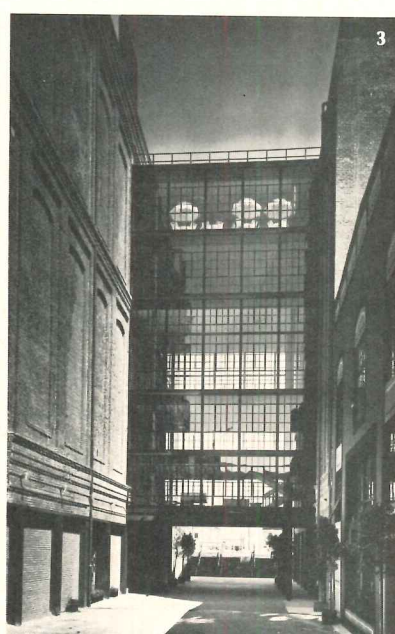
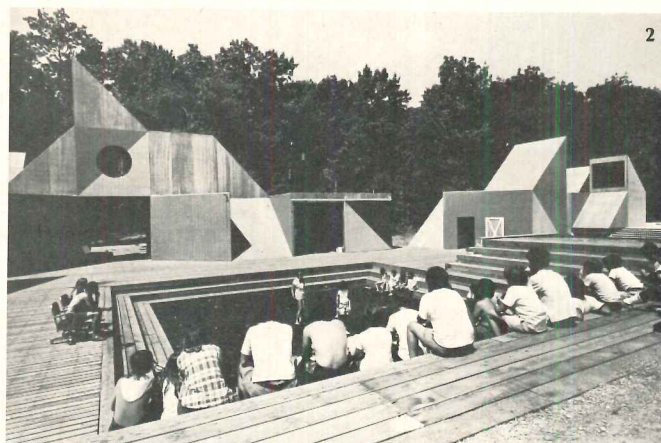
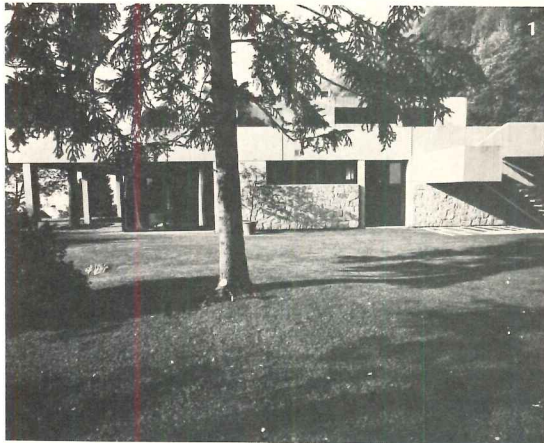

(1) Koerfer House, Lago Maggiore, Switzerland, Marcel Breuer and Herbert Beckhard (RECORD, November 1966, pages 132-133); (2) YM-YWHA Day Camp, Mount Olive, New Jersey, Claude Samton & Associates;

(3) Ice Houses I & II, San Francisco, Wurster, Bernardi and Emmons, Inc.; (4) New York State Bar Center, Albany, James Stewart Polshek & Associates (RECORD, December 1971, pages 94-99); (5) Walker Art Center, Minneapolis, Edward Larrabee Barnes

(RECORD, July 1971, page 34); (6) Mummers Theater, Oklahoma City, John M. Johansen; (7) Weyerhaeuser Headquarters, Tacoma, Washington, Skidmore, Owings & Merrill; (8) McCormick Place On-the-Lake, Chicago, C. F. Murphy As-

sociates (RECORD, May 1971, pages 102-105); (9) Alley Theatre, Houston, Texas, Ulrich Franzen & Associates. Numbers 7, 8 and 9 received the Bartlett Awards "in recognition of their accessibility to the physically handicapped."

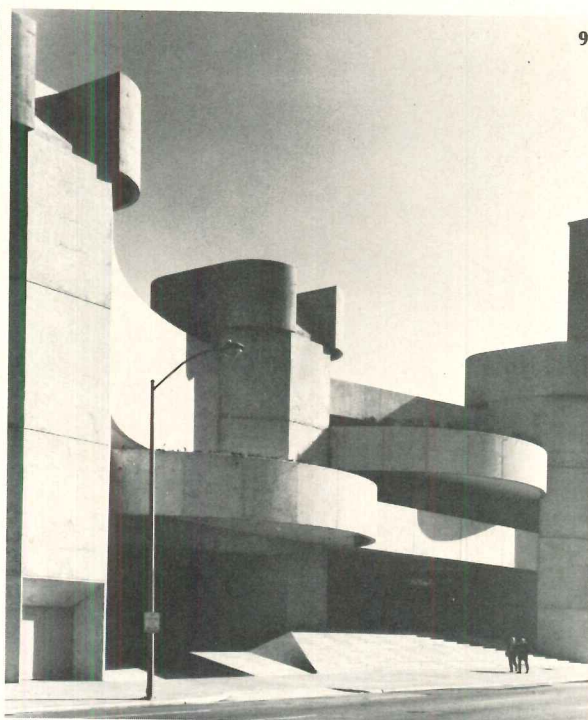
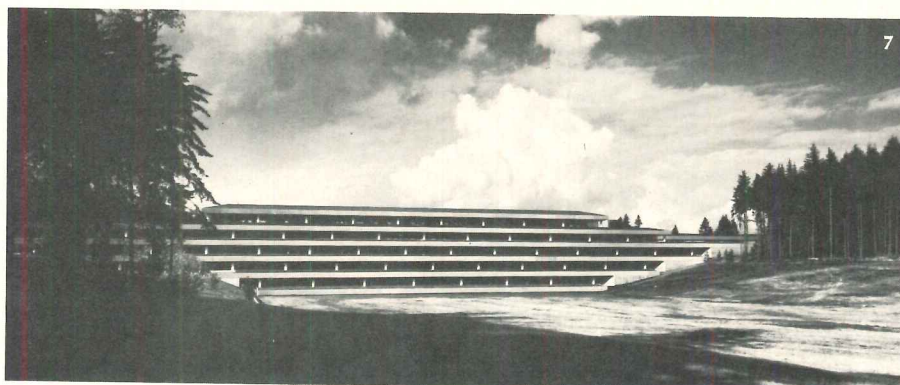

refreshingly beautiful...

Eaton/Cordley Water Coolers

For that refreshing break . . . where taste and beauty meet . . . at the Eaton/Cordley Water Cooler. Here design flows into function. Available in wide range of colors, types and

styles including wall-hung, recessed, floor, explosion-proof and compartment models.

Extensive line of remote chillers and drinking fountains also available.

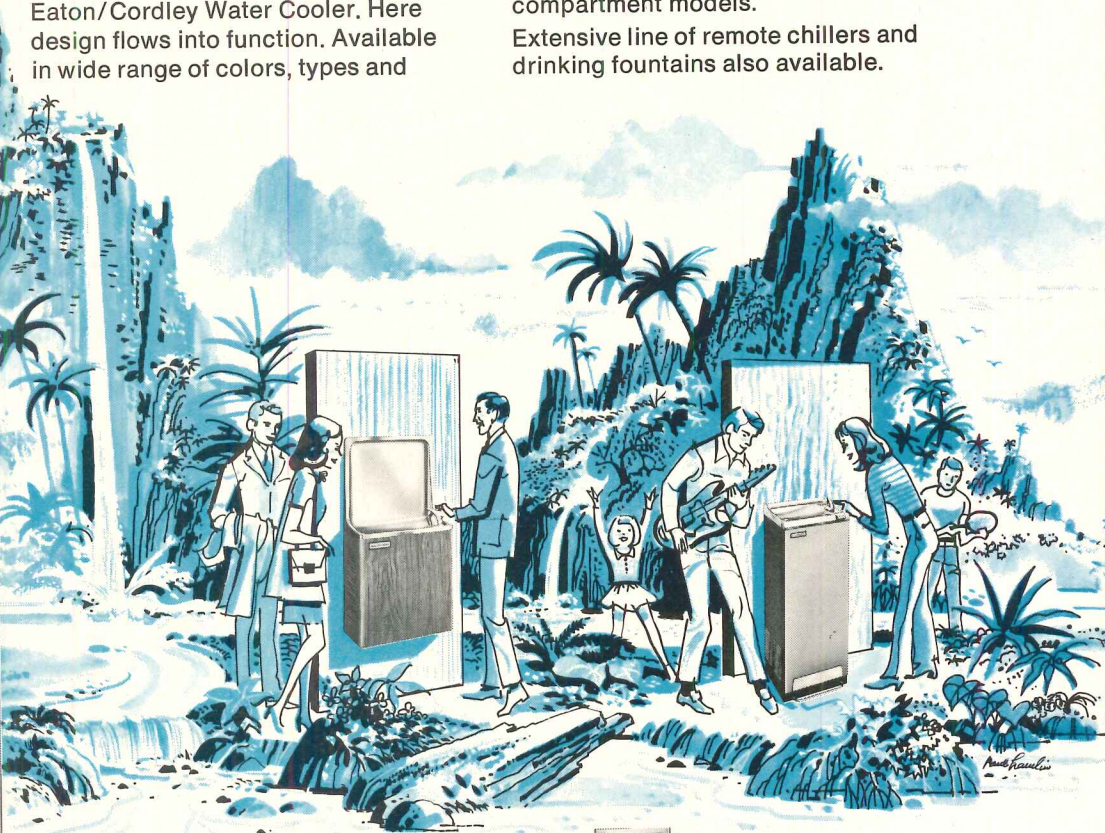

New Simulated-Recessed Model

For new construction or replacement! Mounts flush, without recessing. Extends only 9½". Exceptional styling and appearance. Gives illusion of semi-recessed unit; provides economies of wall-hung type. Stainless steel top; lower cabinet in enamels or vinyls, including walnut woodgrain. Capacities: 6 and 13 g.p.h.

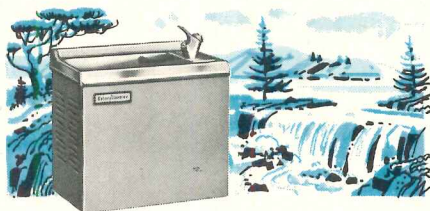

Compact Wall-Hung

Compact Wall-Hung . . . ideal where space is at a premium. Capacities: 2 and 4 g.p.h. Other wall-hung units in capacities from 6 to 17 g.p.h. plus "hot & cold" models.

Fully Recessed . . . in lustrous stainless steel for styling and minimum maintenance. Features deep, anti-splash basin with ample



Fully-Recessed

headroom; bubbler with constant stream control. Capacities: 6 and 11 g.p.h.

For detailed information write Eaton Corporation, Dispenser Division, 3727 Mt. Prospect Road, Franklin Park, Illinois 60131. International Operations: Telex 72-8310.

EAT•N Controls
Products

For more data, circle 23 on inquiry card

People-proof panelboards.

Protect lighting panels with tamper-proof Mono-Flat® trims — standard on all Square D lighting panelboards. When the Mono-Flat front is properly installed and locked, it's practically impossible to get at the inside without the key. The lock is flush with the surface of the door so there is very little room for someone to insert a screwdriver under the lock and pry the door open. And the trim screws are inaccessible behind the locked front. Mono-Flat fronts come with one of either of two key changes so standard and emergency

lighting can be keyed differently.

On a more aesthetic note, the Mono-Flat front has a smooth appearance that can easily be papered, painted, or otherwise covered to blend in with the surrounding decor.

Mono-Flat enclosures are easy to install. They hold themselves in place while the trim screws are locked. And the front of the panel can be adjusted in or out if the box is set improperly in the wall.

Mono-Flat trims are now standard on all Square D lighting panelboards

as well as on several smaller power panelboards. Anytime you have a panelboard application, select a people-proof Square D panel with a Mono-Flat front to make it look its best.

For specific engineering data on Mono-Flat panelboard fronts, contact your Square D distributor. Or write, Square D Company, Dept. SA, Lexington, Kentucky 40505.



For more data, circle 24 on inquiry card



*They
love us
in...*



Notre Dame, Ind.

University of Notre Dame Athletic and Convocation Center
20'x10' Combination Cooler/Freezer
Architect: Ellerbe Architects, St. Paul, Minn.
Dealer: Aslesen, Minneapolis, Minn.

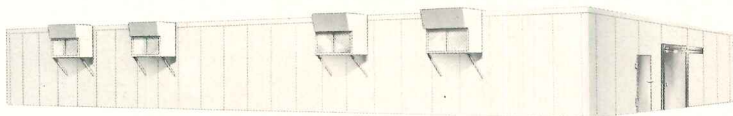

Washington, D.C.

Andrews Air Force Base
96'x36'x10' Refrigerated Warehouse
Architect: Vollrath Refrigeration Inc., River Falls, Wis.
Dealer: Alto Inc., Alexandria, Va.

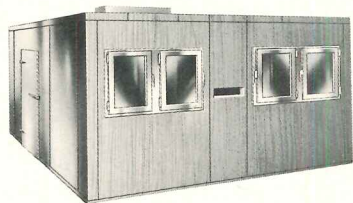

Los Angeles, Calif.

Straw Hat Pizza Palaces
12'x14'x8'4" Reach-In Cooler
Architect: Design Services Inc., Menlo Park, Calif.
Dealer: Design Services Inc., Menlo Park, Calif.

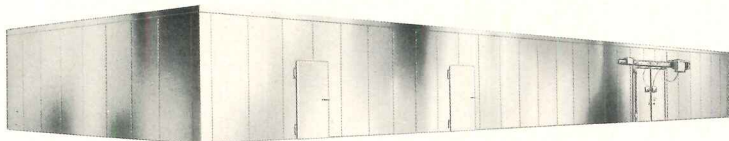

Clearwater, Fla.

Pinellas County School Board
24'x98'x10'7" Commodity Storage Cooler
Architect: R. D. Bateman Co., Tampa, Fla.
Dealer: R. D. Bateman Co., Tampa, Fla.

VOLLRATH WALK-IN COOLER / FREEZERS

Nationwide, Vollrath modular walk-ins have proven their quality and versatility. Pre-engineered, factory-built panels assemble to specified size on site, and may be easily disassembled to enlarge, relocate or to convert cooler to freezer. Panels are full 2 and 4 foot increments — not nominal measurements — to simplify layout and maximize cubic storage capacity. Fire retardant, 4" thick foamed-in-place urethane provides superior insulating properties. With a choice of 5 interior and exterior finishes, plus the most complete selection of options and accessories, there's a Vollrath walk-in adaptable to your varied requirements. Specify Vollrath!

All Vollrath Walk-ins N.S.F. approved.

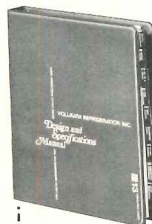

Send for your personal copy of Vollrath's complete Walk-in Design and Specifications Manual — limited number available.

Mail to: ADVERTISING DEPT., THE VOLLRATH CO., SHEBOYGAN, WISCONSIN 53081

Name _____

Title _____

Firm _____

Address _____

City _____ State _____ Zip _____

Goodyear shortens runway and

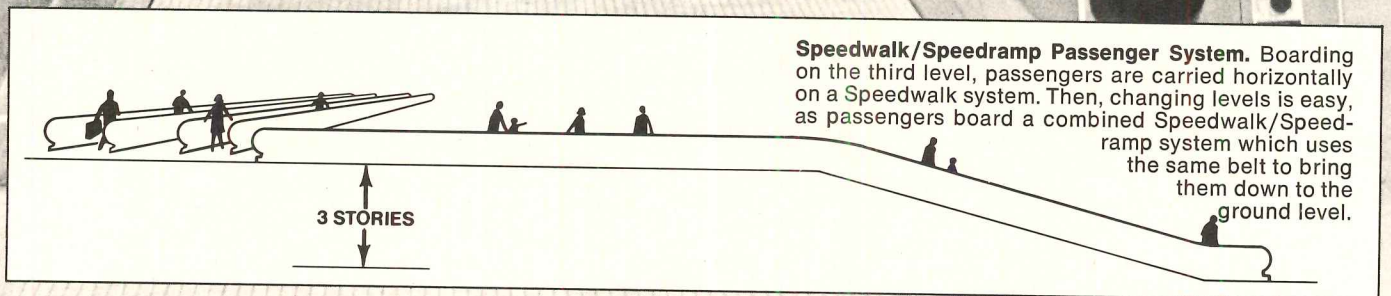

the walk between freeway

New Speedwalk and Speedramp systems save Cleveland air passengers a 900 ft. walk. Round trip.

Cleveland Hopkins had a problem—how to shorten the walk from the new garage to the main terminal building.

Goodyear had the solution—a unique design that draws on Goodyear experience with Speedwalk and Speedramp passenger conveyor systems at airports around the world. One section of the two-part Cleveland installation is the first system ever to combine horizontal and inclined transportation on a single belt.

Here and at other airports, Speedwalk systems move people and their baggage comfortably and effortlessly. Passengers travel in separate lanes at

speeds up to 180 feet per minute. The Speedramp (incline belt passenger conveyor), unlike conventional escalators, has no steps to make problems for wheelchairs, baggage carts and strollers.

Goodyear transport systems are also at work in shopping centers, large factories, stadiums and office complexes. Goodyear has them on line now, ready for delivery—whenever you want to keep ahead of the crowd. For an informative brochure, write: The Goodyear Tire & Rubber Company, Box 52, Transport Systems, Akron, Ohio 44309.



GOODYEAR
TRANSPORT SYSTEMS

For more data, circle 26 on inquiry card

This Decorative Wall

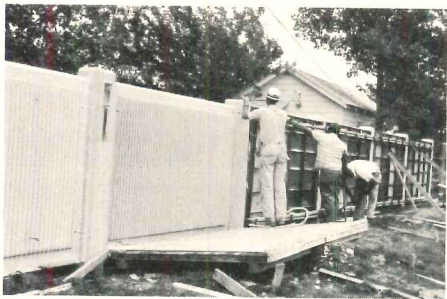

and this 11 Story Library

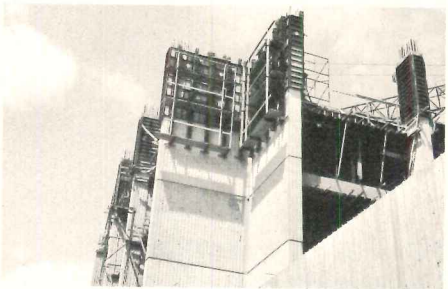

Used Standard And Custom Form Liners

Cast a prefinished wall with Symons Form Liners. Standard liners available are . . . striated, bold striated, 1½"–¾"–½" trapezoidal rib, rough sawn cedar, rustic brick, aged board, and 1½" bush hammered deep rib. For that special effect, we will work with you to produce a custom liner. Form liners offer a pleasing departure from the monotony of flat surfaces.

Our form liner brochures will be sent to you immediately upon request.

*Labor Saving Equipment & Services
For Concrete Construction*



**SYMONS
CORPORATION**
122 EAST TOUHY AVENUE
DES PLAINES, ILLINOIS 60018

For more data, circle 27 on inquiry card

OFFICE NOTES

NEW FIRMS, FIRM CHANGES

Albert C. Martin and Associates, planners, architects and engineers announce the appointment of Robert Welty Braunschweiger as project director.

Robert L. Barnett, AIA, Architect & Associates of Beverly Hills, California announces that Ian Kenneth Carter has joined the firm as an associate architect.

Beyer-Blinder-Belle, Architects & Planners are pleased to announce that Robert E. Meadows and Yogesh Sethi have been made associates of the firm.

Hall and Goodhue, architectural and city planning firm, with offices in San Francisco and Monterey, announces the promotion of three associates to principals and directors of the corporation. The three licensed architects are Gerald E. Ervin of the San Francisco office and Donald E. Evenson and Russell D. Haisley of the Monterey office.

Neuhaus & Taylor, Architects and Planning Consultants, nationally-recognized architectural firm with offices in Houston, Dallas and New York have named Colonel William H. Lillie, Jr., USAF-Ret. as their Washington, D.C. representative.

Charles Luckman Associates, national planning, architecture and engineering firm announces that David Margolf, AIA has joined their firm as director of project management.

Eliot Noyes and Associates announces that Alan Eliot Goldberg has been appointed senior associate in the architectural department.

Harold Roth and Edward Saad are pleased to have William F. Moore join them as a partner. The firm will now be known as **Roth Saad Moore Architects**.

Shepley Bulfinch Richardson and Abbott have announced that Gerrit Zwart became an associate of the firm effective January 1, 1972.

Skidmore, Owings & Merrill, Architects/Engineers with offices in San Francisco, New York, Chicago and Portland, recently announced the election of John Fisher-Smith, AIA, and Richard H. Ciceri as associate partners of the firm.

J. Karl Justin, AIA, has been appointed vice president for administration of the New York architectural **Office of John Carl Warnecke FAIA**.

Morton B. Braun, AIP, Alan McClennen Jr. and Chia-Ming Sze, AIA announce the formation of **Braun McClennen & Sze Inc.**, architects and planners. Their offices are located at 18 Eliot Street, Cambridge, Massachusetts.

Walter Burde, AIA and Eugene W. Bayol, Jr. AIA are pleased to announce the formation of a firm to practice architecture and planning under the name **Architects Burde, Bayol & Associates**.

H.E.L.P.

Security Pack

Battery-powered emergency
fluorescent lighting.



Invisible...



until it's needed.

Here's an emergency lighting system that's *really* out of sight.

You can place a SECURITY PACK luminaire anywhere in your recessed fluorescent lighting system. It looks and operates just like the other luminaires. You'll never notice it.

Unless there's a power failure.

Then the SECURITY PACK lamp stays on without reduction in light output. For up to 90 minutes.

The SECURITY PACK consists of a Power Module...it's part of the fluorescent fixture. And an 8" x 16½" x 2½" Control Module...you can install anywhere in ceiling or wall.

H.E.L.P. SECURITY PACK is battery-powered. Works instantly. Solid-state circuitry assures reliability and long life.

The unit is virtually maintenance-free. And the sealed batteries last up to 8 years. U.L. listed, and designed to meet local Codes.

What's more, you can choose from a wide range of lens styles, fixture types and sizes.

Write for details. Dept. AR-5, Woodbro Corp., Subsidiary of Holophane Company, Inc., 13500 Saticoy St., Van Nuys, California 91402.

Holophane®

Holophane Emergency
Lighting Products (H.E.L.P.)

For more data, circle 28 on inquiry card

New **Kodak** Colorado Division requires optimized control of thermal environment for its optimum rated film/paper/plates

Kodak has gone West to Windsor, Colorado with a new 3000 acre production and distribution complex for film, finishing, paper and printing plates.

Low tolerance control of setpoint temperature/humidity is critical for maintaining *uniform*, quality production in the currently completed 1½ million sq. ft. facility. High-efficiency air-conditioning/heating

systems have integral heat transfer coils for such *balanced* environmental requirements. Aerofin Heat Exchanger Coils share in this responsibility. Reliable performance, plus remarkably high exchange coefficients have earned Aerofin industry leadership. Call our specialists on any new or renovation job with demanding coil controlled environment specs.



PROFESSIONALS AT WORK

Architects: Giffels Associates and Eastman Kodak Company

Mechanical Engineers: Giffels and Rosetti and Eastman Kodak Company

Mechanical Contractors: U. S. Engineering Co., and L. E. Meyer Inc.

General Contractor: Phelps Construction Company, Greeley, Colorado

ARI certified rated Type C chilled water cooling coil with stainless steel casing.

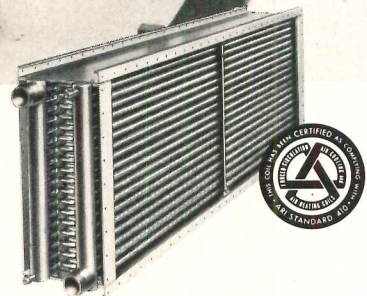

AEROFIN CORPORATION

LYNCHBURG, VIRGINIA 24505

Aerofin is sold only by manufacturers of fan system apparatus. List on request.

AEROFIN OFFICES: Atlanta • Boston • Chicago • Cleveland • Dallas • Los Angeles • New York • Philadelphia • San Francisco • Toronto • Montreal
AEROFIN CORPORATION (CANADA) LTD., Gananoque, Ontario

REINFORCED CONCRETE: COMPELLING IT IS.



American National Bank Building, Amarillo, Texas
Architects: Kelly/Marshall & Associates, Inc., Tulsa
Structural Engineers: The Engineers Collaborative Ltd., Chicago
Contractor: WRG Construction, Tulsa

COSTLY IT ISN'T.

Amarillo reaches for the sky.

Striking design soars for 31 stories in the American National Bank Building. The tallest structure in Amarillo. And the architect's choice for this highly effective, yet highly practical, treatment was reinforced concrete joist floors: lightweight aggregate plus Grade 60 reinforcing steel.

Design freedom. And a tight rein on costs.

The lack of high soil bearing capacity for the substructure didn't limit expressive use of space and shape in this structure. Piers drilled into the site's silt and clay use friction forces and end bearing. The choice of lightweight concrete joist floors resulted in the lowest possible weight for the span lengths and meets the fire rating requirements without relying on fire resistive ceilings. Concrete columns of 4,250 psi and 6,000 psi strength were used. The joist floors were all structural lightweight concrete of 4,250 psi strength. All together, more than 2,000 tons of reinforcing steel (7.2 psf) went into the job. And when the final structural costs were tallied up, \$11 per square foot was the very respectable figure for the building's 557,000 square feet, complete except for partitions, floor coverings and ceilings in tenant spaces.

Standing up to a Texas-style wind.

An unusually high wind load requirement of 40 pounds per square foot faced the designers. Another good reason for their choice of reinforced concrete. They combined both functional strength and eye-appealing contour in the shear wall and frame seen on the building's narrow dimensions. The second through sixth floors were designed for garage parking for bank customers and tenants. Here again, the versatility of reinforced concrete permitted supporting the shear-wall loads on a seven-story-high rigid frame. Result: a garage with six sloping ramp floors for unencumbered parking space.

Beating the clock is an economy move.

Time and again, the speed of construction with cast-in-place reinforced concrete and the immediate availability of rebars show how to stretch the building dollar. The American National Bank Building is no exception. No particular construction problems cropped up. The 21-month construction schedule was met easily. Helping all the way were Grade 60 rebars, used in straight, cut lengths. Standard steel pan forms for joists, with wide band beams of the same depth, gave a flat soffit unobstructed by beams. No truss bars were used. And all rebars were bundled and shipped as needed for easy placement.

Grade 60 makes the difference.

Grade 60 reinforcing steel is the strong point for Strength Design. With its 50% greater yield strength, it makes for slimmer columns, more usable floor space, lower construction costs.

Reinforced concrete: compelling, not costly.

Get away from the stereotypes and get into the building system that has it all: design freedom, fast construction and early starts, less maintenance, availability, proven economy. Cast-in-place reinforced concrete. It lets your imagination and your pocketbook stay friends.



Large, open parking ramps. Lightweight concrete in long-span floor joists gave lowest possible weight for required fire rating without ceilings.

For complete design information on this project, circle Reader Service number below.



CONCRETE REINFORCING STEEL INSTITUTE

228 North LaSalle Street • Chicago, Illinois 60601

For more data, circle 131 on inquiry card

Professional critics have been virtually unanimous in regarding Harry Weese's Arena Stage as a major landmark in American architecture. Wholly original in concept, superbly functional, and elegant in detailing, it has "an ambiance which suggests that magic is made, after all, in a working place," as one commentator remarked. Among other significant developments which were foreshadowed in this exciting structure was the utilization of roof perimeters as an important element in contemporary design, particularly when executed in metal.

Our initial gratification when Mr. Weese and his associates selected Follansbee Terne for these roof areas has thus merely been enhanced with the passage of time. And we were therefore doubly gratified, nearly a decade later, when Terne was again specified on the adjacent Kreeger Theater, a building of comparable distinction.



FOLLANSBEE
FOLLANSBEE STEEL CORPORATION
FOLLANSBEE, WEST VIRGINIA

NORMAN R. McGRATH photo

KREEGER THEATER, WASHINGTON, D.C. WITH ARENA STAGE IN BACKGROUND.
ARCHITECT: HARRY WEESE AND ASSOCIATES, CHICAGO, ILLINOIS, WASHINGTON, D.C.
ROOFER: MATHY COMPANY, FAIRFAX, VIRGINIA.

For more data, circle 29 on inquiry card

introducing Sculptura II



New **Sculptura II** is the shape of the future for all institutional seating needs. Because its contour-molded design surpasses the comfort, durability and versatility of all other seating! It's just that simple.

This beautiful breakthrough adapts to offices, auditoriums, classrooms, conference rooms, lecture halls, cafeterias, etc. With dozens of alternative seat-basing adaptations. Meets need for seating unupholstered, with two piece padded seat and back, or fully upholstered. With textured, stain-resistant nylon or expanded vinyl. All in a rainbow of decorator colors for you to choose from.

Sculptura II is made of extrastrength fiber glass for long life and easy maintenance. For complete information about adaptations, specifications and options, mail the coupon today!



Dept. AR-5

Clarín Corporation
P.O. Box 236
Chicago, Illinois 60635

Please send me your free brochure on new Sculptura II Institutional Seating.

Name _____ Title _____
 Organization _____ Phone _____
 Address _____ City _____ State _____
 Zip _____

For more data, circle 30 on inquiry card



CLARIN CORPORATION

Creators and producers of better seating innovations.

To avoid glazing problems caused by faulty shimming, avoid three of these shims.

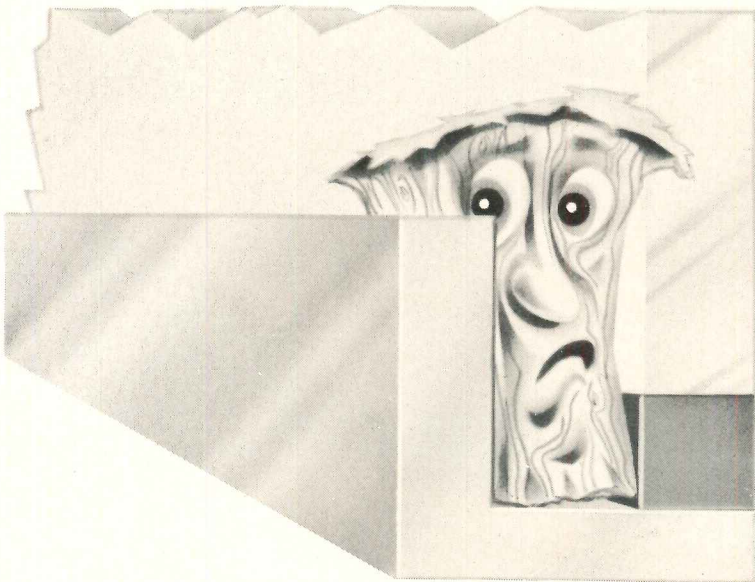

The makeshift shim. It might do the job for a while.

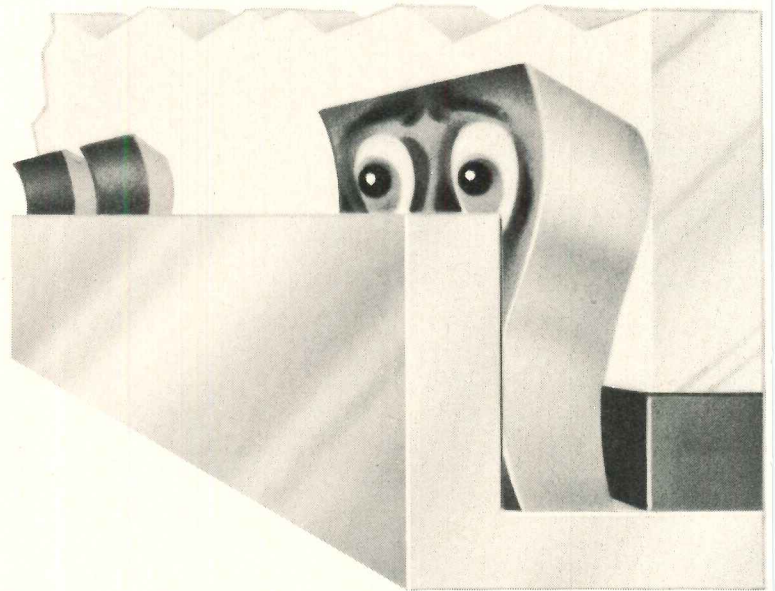

The misplaced shim. It can't do the right job when it is in the wrong place.

All but the Pre-shimmed Tremco 440 Tape can cause problems that might crack or break glass, or cause sealant pump-out or failure.

If a shim is unevenly spaced it creates pressure points which could cause glass breakage. A makeshift shim, like a splinter of wood or piece of floor tile, could cause sealant adhesive failure resulting from improper wind load transfer from glass to seal. And if there is no shim at all, the pumping action of the glass will soon squeeze out the sealant.

That's why you should specify Pre-shimmed Tremco 440 Tape. It's a highly adhesive, preformed, shrinkproof sealant with a built-in shim running through the center.

This shim — a continuous elastomeric rod reinforced by a fiberglass core — distributes loading stress uniformly around the perimeter of the frame.

So you don't get pressure points. Or sealant squeeze-out. Or adhesive or cohesive failure.

And with the trend to larger, heavier, more

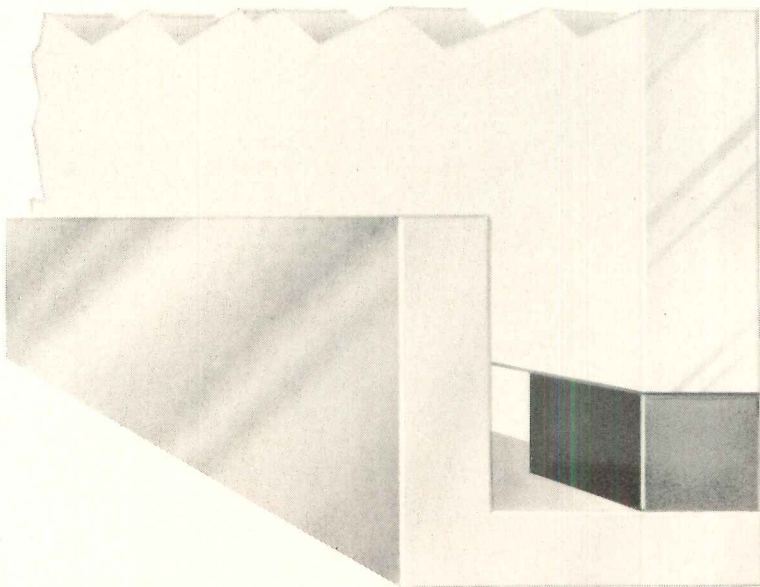

The forgotten shim. Whoops. Someone forgot to put it in.

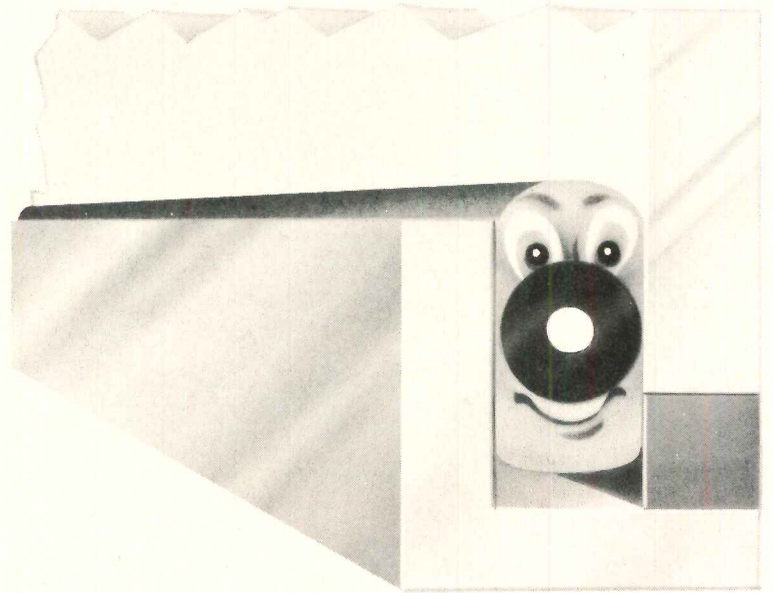

The Pre-shimmed Tremco Tape. It puts a continuous spacer-cushion all the way around the perimeter.

versatile glass, Tremco's ability to provide a leakproof glazing system from a variety of compatible components is more critical than ever.

For all the details on Pre-shimmed Tremco 440 Tape, see your Tremco man. In fact, your Tremco man has the answer to any sealant problem. Because for over 40 years now, solving sealant problems has been our primary business. In addition to our exclusive glazing systems, we have over 15 basic sealant formulations for

construction joints . . . including such familiar names as MONO (our job-proven acrylic terpolymer), DYmeric (the Tremco-developed polymer), and Lasto-Meric (our polysulfide).

Contact your local Tremco representative, or write: The Tremco Manufacturing Company, Cleveland, Ohio 44104, Toronto 17, Ontario.

TREMCO
The water stoppers

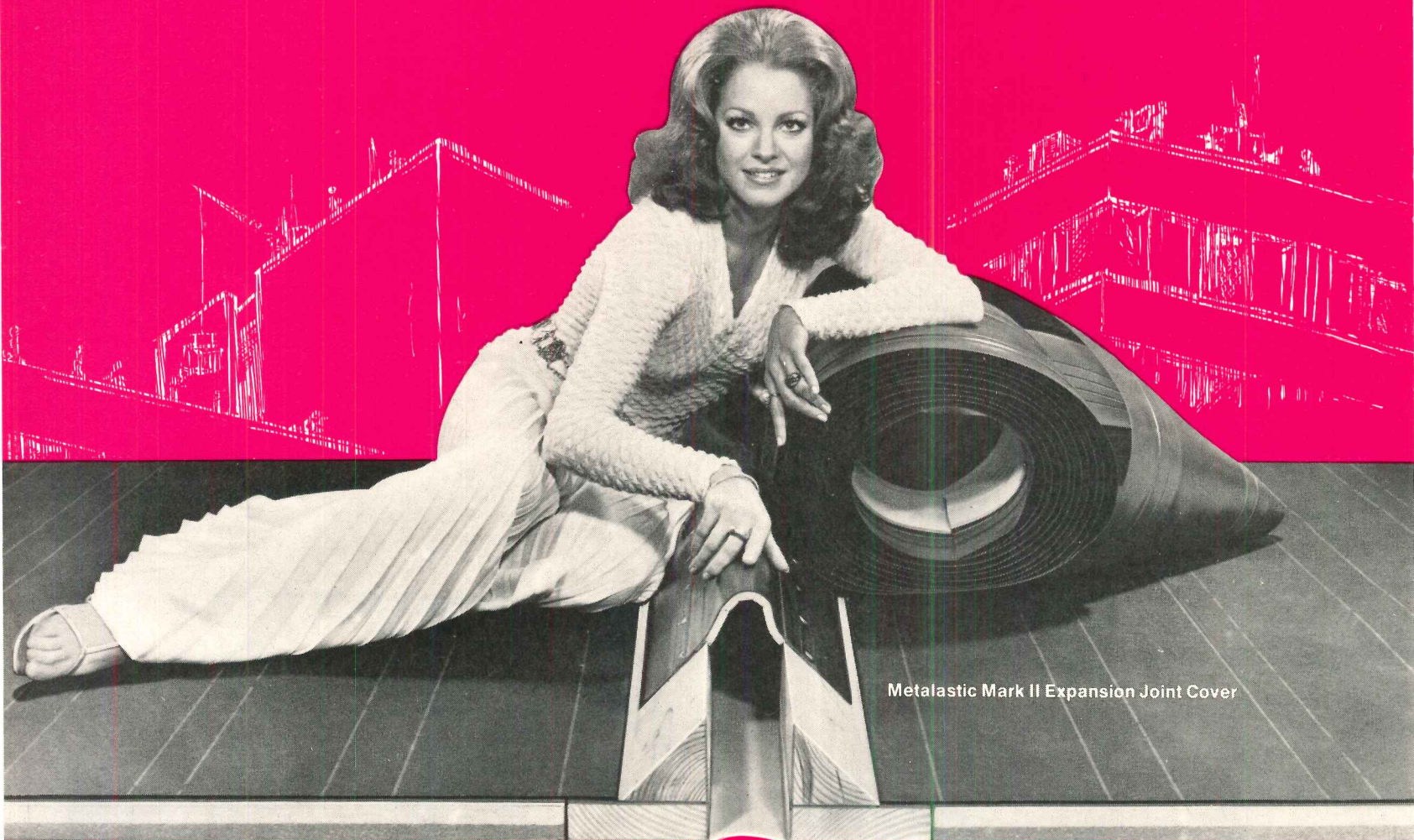

Metalastic Mark II Expansion Joint Cover

ULTIMATE ENGINEERING

METALASTIC MARK II EXPANSION JOINT COVER

An exceptionally durable vinyl extrusion, with $\frac{3}{8}$ " PVC foam insulated bellows section,* that provides absolute bonding and unequaled ease of installation:

- *Exclusive splicing system defies error.*
- *Open cut insulation channels assure tension-free application.*
- *Imbedded steel fastening strips, indented nail points and self-adhering flange strips facilitate installation.*
- *Fastens to curb, cant or nailable deck edges.*

Flexible at temperatures as low as -50°F. , available for joint openings of 1" to 4" in 50 and 100-ft. rolls (flexible at temperatures to -50°F.) and 10-ft. curb-shape sections, with thermoformed transitions.



BUILDING PRODUCTS DIVISION

Get the facts:

Grefco, Inc.

BUILDING PRODUCTS DIVISION
2111 ENCO DRIVE
OAK BROOK, ILLINOIS
60521

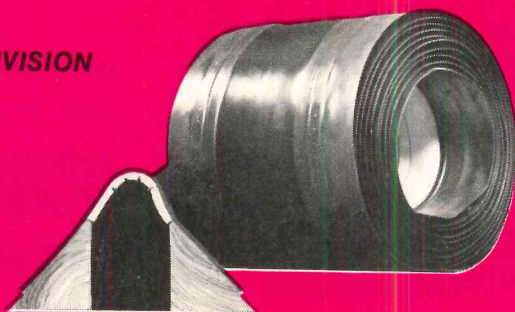

*"K" factor
of .30

For more data, circle 32 on inquiry card

Financial management of the professional firm

By Bradford Perkins

Vice president, D'Orsey Hurst and Co., Inc., a division of McKee-Berger-Mansueto, Inc.

"Profit has no place in the practice of architecture!" That was the laudable sentiment repeatedly expressed in response to a recent national survey. But sentiment, unhappily, does not provide the cash required for extra research and design effort, nor the working capital required for growth and for large projects, nor for the salaries currently demanded by both principals and employees. The question should not be *whether* to make a profit but rather *how* to make a profit sufficient to those needs.

Since the various aspects of financial management—profit planning, fees, accounting, management controls, taxes, and cash management—have been covered in detail in a number of full-length books, this article will concentrate on providing a brief overview and setting the general guidelines for answering the "how?" of financial planning and control.

The key steps to profit planning

The first steps, as noted in the first two articles of this series, are 1) a statement of goals and 2) a plan for their achievement. The process of profit planning is discussed in the AIA publication *Profit Planning in Architectural Practice*, but the essential elements are: a clear definition of the firm's and its principal's financial goals, a budget for every area of the firm's operation and an understanding of the cost-volume-profit interrelationship.

There are no correct or incorrect goals, but typically design firms try to allocate 20 per cent of their accrued fees as pre-tax profit over and above the principals' base salaries. As several AIA studies have shown, however, most firms are actually able to achieve only eight to ten per cent allocation. But according to the published profit achievements of some firms, there is no reason why 20 per cent should not be an achievable goal for most offices.

The percentage objective will, of course, vary somewhat with the second financial goal—the salary target for the principals and staff. Outside of the large firms in the major cities, most respondents feel \$20,000 to \$30,000 salary plus profit sharing is reasonable compensation for principals. Staff salary targets are, of course, considerably lower even for key personnel. Considering the education, effort, skill,

liability, responsibility and investment required of a principal, prevailing small-office targets are too low, and the salaries paid to employees are often absurd even from the selfish management viewpoint of morale and turnover control. More reasonable objectives will, of course, not change this situation overnight, but as a guideline for change, they are an important first step.

Other factors which also have a significant impact on the appropriate profit target are growth plans, client types, and related factors. For example, a firm with ambitious growth plans should achieve a high level of profits to support its increasing working capital requirements, but it also has to spend more in business development, research and other areas to stimulate the growth.

A firm that does most of its design work on large commercial or industrial structures should be able to set a higher profit target than one specializing in single-family homes. Inherent profitability varies significantly from one building type to another, with degree of complexity.

With these variables in mind, look back through last year's expenses and, based on this record and expected changes during the coming year, develop a realistic twelve-month projection for each area of expense. This analysis should distinguish between direct (project related) costs and indirect (overhead) expenses.

The analysis must then be tied to a budgeted fee volume, for the essential concept in a profit plan is the interrelationship of cost, volume and profit. In the most basic terms this concept can be summarized as follows: a firm makes a profit when the sum of the gross margin (the amount left after all direct project costs) of all earned fees (the amount of the fees earned on all projects whether billed or not) exceeds the firm's indirect costs. In other words, a firm with a constant overhead can make a profit by either having a low volume with a high gross margin, a high volume with a lower gross margin, or, of course, a high volume and high margin.

A firm's profit plan should be a flexible guide for determining at various points during the year which of three basic actions should be employed to keep the firm on target: 1) cutting direct costs to increase the margin, 2) cutting indirect costs to

lower the overhead, and/or 3) drumming up new commissions, even at lower margin as in residential projects, to provide the necessary volume. This may seem very basic, but most firms still think that to win the battle of profitability on every project is the only way to win the war of profitability for the firm as a whole. It is one way, of course, but widely fluctuating volume is as great a threat to profitability as is narrow margin.

Fee structures are part of business development

Having developed a set of goals and a plan, the next step is obtaining the required workload. Although the basic guidelines for business development were outlined in the previous article of this series, one essential aspect, not always considered as a part of business development, needs further discussion: establishing an appropriate method and level of compensation.

More than 80 per cent of design professionals' fees are set on the basis of a percentage of construction cost. Among the many shortcomings of this method is the fact that it is so arbitrary that it often does not represent an equitable (to either the owner or the architect) compensation for the services provided. As a rule of thumb, many good clients pay too much and most bad ones pay far too little.

Architects are finding now that an increasing number of clients are receptive to many of the other methods discussed in another AIA publication, *Methods of Compensation for Architectural Services*. Of the dozen ways outlined in that book, we strongly recommend the professional-fee-plus-expenses approach developed in accordance with a careful analysis of how much work and associated cost will be required by the project. If the client insists, a guaranteed maximum should be established at least ten per cent above any acceptable lump sum or percentage fee. The argument here, of course, is that the fee-plus-expenses method provides the client with an opportunity to save on the architect's fee if he helps the job run smoothly; but the price of this opportunity is a protective cushion for the architect if the client and project prove unusually difficult.

The current economic slowdown has also re-emphasized one more argument for

a method other than the percentage of actual construction cost. Projects are once again coming in under the budget and design firms are finding their expected income seriously cut.

Even when the project cost runs over budget, many clients will refuse to pay the increase. Further, if the architect's consultants are also on a percentage, overruns on their part of the project may also seriously reduce the architect's expected gross margin. Even if the client is not sophisticated enough to analyze the full consequences of a proposed method of compensation, the design professional should be able to explain them.

Accounting and management controls can make the difference

Assuming that the firm has work, and has established equitable fees, the major problem remains how to control the firm's own operating costs. Good accounting and controls do not make money for a firm, but they can be just as important as a successful business development effort in preventing losses.

There are two basic aspects of this area of financial management controls; one is procedural and the other is a matter of firm policy. The procedural aspect is covered in sufficient detail in still another AIA publication, *Financial Management for Architectural Firms—A Manual of Accounting Procedures*. Although every firm has some unique requirements that will lead to deviation from this recommended format, the AIA book's basic accounting procedures will be adequate.

What the AIA book does not cover are some less technical aspects of accounting such as who should do it, how much should it cost, and when should it be automated. The answers to each depend, of course, on the firm's long-term objectives, the complexity of its operations, and, most of all, the quality of personnel involved.

Some rules of thumb are: 1) A small firm (less than ten) probably should use an outside accountant coordinating with a combination secretary/bookkeeper within the firm. 2) If a firm plans to grow much beyond ten, it should plan on hiring an experienced full-time bookkeeper who can draw support during peak periods from a secretary/bookkeeper and advice from a local CPA. 3) If the firm intends to grow beyond 25, it should consider a business manager of at least associate status supported by a full-time bookkeeper and an automated accounting system.

The financial management in large firms should be directed by a full partner with extensive management education, experience, and interest. Again, a very rough guideline for cost would be that the total cost of the financial management area of the firm would run between four and eight per cent of the firm's gross volume. This guideline does not vary much with the size

of the firm, for there are few efficiencies of scale. The larger the firm, the more formal is the reporting required.

As a firm's size increases, an increasing amount of the accounting burden should be transferred to a computer. The exact timing will depend on the quality of the firm's staff—the better the staff, the later automation is appropriate. But a growing firm should seriously consider automation when it sees that it will eventually have more than twenty-five employees. The basic reason for this change is that the principals begin to lose their once-intimate feel for all aspects of the firm's operations at about this point, and, therefore, must rely on reports in addition to personal observation in order to continue effective management.

Management controls needed as firm size increases

Most of the new reports that will become necessary at the twenty-five man level are management controls rather than basic accounting records. The two AIA publications on Profit Planning and Financial Management also cover this subject—as does one of the American Management Association's better books, *Management Controls for Professional Firms*. While all of these publications have slightly different formats or emphases which reflect the management style and requirements of different firms, there are a number of basic elements common to all control programs. The most important of these can be summarized in brief as follows:

1. A monthly, accrual basis, profit and loss statement

Most firms do not get such a statement or if they do it is on a cash basis. Cash-basis accounting is adequate for very small firms, taxes, and cash flow purposes; but it is a dangerously misleading basis for management reporting. For example, on the cash basis the firm usually loses money while it is growing, makes abnormally high profits when it first levels off or whenever a big check comes in, and appears profitable during the first months of decline—all because cash income is out of phase with cash expenses. Therefore, if a firm maintains cash-basis books for tax purposes, it should make the appropriate accrual adjustments when it develops its monthly statements.

2. The balance sheet

Most firms do get this report on a regular basis but it is rarely useful as a management tool.

3. Income projections

All firms should maintain at least a twelve-month projection of their current backlog of signed contracts to help in manpower and business development planning. One of the most common management short-

comings among professional firms is a failure to foresee and take corrective measures for impending peaks and valleys in the workload.

4. Project Cost Controls

The most commonly discussed but least understood tools are the project cost controls. As was pointed out earlier, job profit—except on a gross margin or "contribution"—basis can be a misleading factor. Therefore, the important thing to control is direct project costs—payroll, consultant fees, travel, reproduction, etc.

The first step in direct cost control is the establishment of a budget for each project phase. Just as with the project fee, the budget should reflect a realistic evaluation of the time and expense involved. The calculation should not be some arbitrary allocation in accordance with some formula. Many firms, for example, use the AIA phase-payment breakdown, but this tends to front load the income for most firms and, thus, makes the later phases look even worse than they normally would.

If someone, such as a project manager, is to be held responsible for the budget, he should be involved in its preparation. If he is not, he will claim that any overruns were due to the fact that he had to live with an unrealistic budget which he did not set.

Once the project is underway, the control system should provide a monthly summary of the phase costs for the most recent month, costs to date, a calculation of the cost to date divided by the budget, and an estimate of the per cent complete. If the cost-to-date/budget calculation exceeds the per cent complete, the project may be in trouble and should be watched.

5. Indirect Cost Controls

By themselves, direct cost controls are not fully effective if they are not accompanied by indirect or overhead cost controls. Each area of indirect expense should be budgeted for a twelve-month period and monitored on a monthly and year-to-date basis. Any overruns or variances from the budget should be noted and followed up.

The important monitoring consideration be that the reports should highlight the variable expense items—telephone, employee downtime, travel and entertainment, etc.—for most indirect expenses are fixed and as such do not require much monitoring.

Profit and management decisions can be affected by tax laws

Assuming that the firm sets the right goals, maintains the project volume and controls costs, it will make a profit. Because of the existing tax rates, however, as much as half of that profit can be spent on taxes. Therefore, it is extremely worthwhile to have a thorough understanding of the current tax

continued on page 204

FRONTIERS IN SPACE CONTROL

Hager introduces new concept in concealed hinging!

RACONTEUR #550

The rack and pinion pivot that gives a door hairline fit

Raconteur #550 moves the door laterally, edging the axis away from the jamb as the door opens, so no rounding of door edge is ever needed. This built-in clearance feature creates new wide range of opening applications. Doors can now be fitted flush with only a hairline between door and jamb. The better appearance is dramatic.

Raconteur has only one moving part in each pivot. No intermediate pivot is used. The bottom pivot has extended flange for extra support and the fully-protected gear can even be set in cement.

Raconteur #550 maintains sag-free anchor and smooth gliding action for doors up to 150 lbs. It is applicable to doors 1 $\frac{3}{8}$ " and over thickness. The gear compartment of heavy-weight brass is 3 $\frac{1}{4}$ " long, 1 $\frac{1}{4}$ " wide and 1" deep.

For detailed specifications and easy-mounting description for Raconteur #550 see your hardware distributor or write

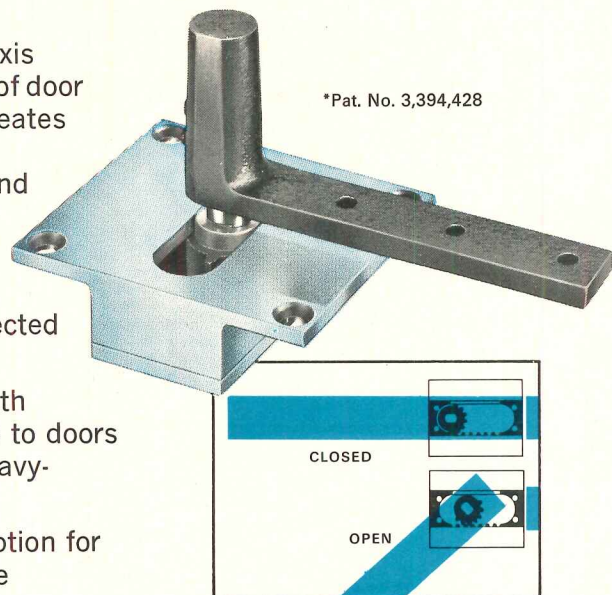

HAGER HINGE COMPANY

139 Victor St., St. Louis, Mo. 63104
In Canada: HAGER HINGE CANADA, LTD.

"Everything Hinges on Hager!"

For more data, circle 33 on inquiry card

Construction outlook 1972: first update

The new directions that were taken in national economic policy last August 15th have begun to show some results. In the opening quarter of 1972, measureable progress was being made against several of the broad goals of the New Economic Program: **Faster growth**—the previously sluggish recovery of industrial production accelerated in January and February.

Unemployment—the jobless rate edged down from December's 6.0 per cent to 5.7 per cent by February.

Inflation—Prices were still showing the expected "post-freeze bulge," but Phase II was nevertheless providing an important degree of control over inflation. Even the blistering pace of construction costs had slowed significantly.

With the office of the chief executive up for grabs in November, it's a fairly safe bet that we won't be seeing any major shift in economic policy as long as the NEP appears to be moving us toward the ideal election platform of full employment and stable prices.

The common thread of most forecasts for the 1972 economy (ours included) is that the tax cuts and public spending measures adopted last fall will help to accelerate the tenuous recovery that has been limping along for more than a year now. As momentum builds, we should come close to realizing the potential gain of \$100 billion, or 9½ per cent, in total output this year. And with prices under the restraint of Phase II controls, real growth this year will be a healthy 6 per cent, while inflation is held to something like 3-3½ per cent.

This is still a moderately bullish forecast, but it has been gaining credibility over the six months that have passed since it first made its appearance. It anticipates a much better performance than we've seen for the past couple of years, but no more than should be expected at the stage of the business cycle we've now reached.

So how will 1972's economic environment affect construction markets? It will set in motion the reversal of some of 1971's extreme trends.

This year's economic conditions should encourage a fairly strong rise in nonresidential construction contracting—last year's soft spot. Public works are being stepped up to help accelerate recovery; and as recovery accelerates, we'll get more indus-

trial and commercial building. Housing has peaked, and will be diminishing in each successive quarter, even though this year's total starts will be almost identical with 1971's record volume. This sequence isn't much different from the way we saw 1972 shaping up last October, and it means that for the time being the *Dodge Construction Outlook* needs only a few interim adjustments.

Contracting for industrial buildings now looks even a bit stronger than it did only a few months ago. The latest McGraw-Hill survey of manufacturers' capital spending plans shows they've upped their sights by more than a billion dollars just since last fall, despite low operating rates.

Commercial building is also gaining, even though there's not much life in the overbuilt office category right now. Store and warehouse construction is where all the action is, and it can be reported that a dependable, old relationship is alive and well (and may be going on at your local shopping center). It's the one where a spurt of homebuilding normally leads to the need for more retailing facilities after a short interval. In early 1972, we're getting most of the impact on store building of last year's housing boom. With another big residential year in progress, this recent rise in store contracting isn't about to fade.

Institutional building—with hospital/

health facilities rising sharply and educational construction declining—is behaving about as expected. (Note that in educational building it's not that this year is turning unduly weak. Rather, it was last year's gain that was out of line with the trend of this essentially no-growth market. Things are now returning to normal after a 1970/71 aberration that had more to do with financial conditions than with the basic need for educational facilities.

In total, the 1972 outlook for nonresidential buildings remains much as before—a gain of 8 per cent in contract value, paced by the recovering industrial and commercial sectors.

Residential building, however, is doing a bit better than our earlier expectation, and the October forecast could now use some upward revision. In recognition of this year's hot first quarter, we've raised our 1972 housing forecast by 150,000 units to a total just about equal to 1971's record 2.1 million units. But we still can't go along with those who are looking for a volume in the 2.2 to 2.3 million range. Our outlook is for a gradually diminishing rate of starts through the year, reaching about 1.8 million by the fourth quarter. The value of 1972's residential building will be up 4 per cent, due partly to higher costs, and partly to a slight shift of the mix toward one-family units.

NATIONAL ESTIMATES

construction contract value (millions of dollars)		1971	1972 forecast	per cent change
nonresidential buildings	office buildings	\$ 4,748	\$ 4,750	—%
	stores & other commercial	4,910	5,875	+20
	manufacturing	2,611	3,400	+30
	educational	5,661	5,400	- 5
	hospital & health	3,206	3,675	+15
	other nonresidential buildings	4,532	4,550	—
	TOTAL	\$25,668	\$27,650	+ 8%
residential buildings	1 & 2 family homes	\$21,890	\$23,700	+ 8%
	apartments	11,419	11,000	- 4
	nonhousekeeping	1,540	1,600	+ 4
	TOTAL	\$34,849	\$36,300	+ 4%
	TOTAL BUILDINGS	\$60,517	\$63,950	+ 6%
nonbuilding construction	streets, highways & bridges	\$ 7,358	\$ 8,500	+15%
	utilities	5,034	5,000	—%
	sewer & water supply	3,462	3,800	+10
	other nonbuilding construction	3,273	3,750	+15
	TOTAL	\$19,127	\$21,050	+10%
TOTAL CONSTRUCTION		\$79,644	\$85,000	+ 7%
DODGE INDEX (1967=100)		144	154	

The only real news in multizones this year

AAF Mark 13

Here's what it is,
how it works.

The Mark 13 multizone eliminates that "big box" effect on the roof. Through the use of decorative fascia on a support system, units can now be blended into the overall effect of the building's architecture.

Roof integrity is completely protected because the facade system is supported by the Mark 13 unit itself. Sixteen vertical supports are welded onto AAF's exclusive pentapost framing. Arm supports are sized for a mansard effect or a straight vertical facade. Mounting channels are bolted to the arm supports.

AAF can supply a standard aluminum alloy fascia in ten contemporary colors — sandstone, brick red, gold, green, blue, black, tan, light bronze, medium bronze and dark bronze. The support system can also be paneled in an endless number of other facade materials—plastic, steel, laminates,

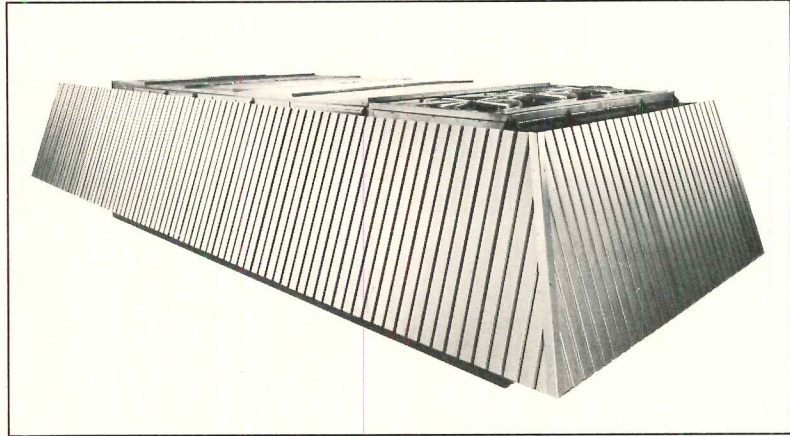

fiberglass, reinforced vinyl, ornamental screening or decorative treillage. The building design itself generally determines the material.

It's the end of the big box era in roof mounted multizones.

That's not all the news. The Mark 13 unit itself is new. For example: solid state controls for reliability and ease of programming. There's a new refrigerant/reheat capability to supply "free" heat to some zones without activating the heating section in marginal and summer weather. A new

high efficiency gas furnace, with a fool-proof forced draft system which eliminates problem-causing vent fans, is among four choices of heat.

All in all, the Mark 13 is unsurpassed in engineering advances and dependability.

For more information write for Bulletin MZRM 103, Manager, Air Handling Products and Systems, AAF, Box 1100, Louisville, Kentucky 40201. In Canada: 400 Stinson Blvd., Montreal 9.

Better Air is our Business.



Facade frames are fastened directly to the rigid steel framework of the multizone unit so that no additional supporting structure is required. The frames project far enough to permit access by service personnel for all normal service functions without removal of fascia panels.

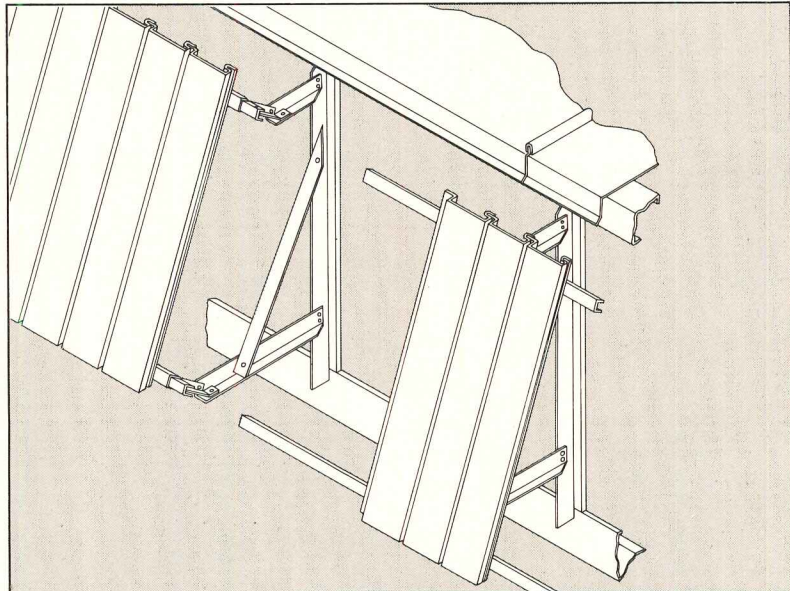

The architectural facade system consists of the facade frame and the fascia. The frame consists of vertical supports, arm supports and mounting channels.

AAF American Air Filter
AIR HANDLING PRODUCTS AND SYSTEMS

UNIT COSTS FOR ALTERATION AND REMOVAL

The following unit prices are representative of work in the New York metropolitan area and can be adjusted for local estimates by application of the Cost Differential column in the table at right (Atlanta = .78 times listed price, etc.).

Demolition of minor buildings

wood	0.12/cu ft
masonry	0.18/cu ft
concrete block	0.15/cu ft

Remove concrete

6-in. slab on ground with mesh	0.38/sq ft
with bars	0.66/sq ft
suspended slabs & beams	2.50/cu ft
columns	2.80/cu ft

Remove walls

masonry, 12-in. exterior brick	2.00/cu ft
concrete block, 8-in.	0.78/sq ft

Patch holes through concrete

walls 12-in. thick	3.20/sq ft
slab, ground, 4-in.	1.20/sq ft
slab, suspended	3.20/cu ft

Remove

plaster ceiling (labor only)	0.15/sq ft
ceiling suspension system (labor only)	0.23/sq ft
ceramic wall tile (labor only)	0.22/sq ft
ceramic floor	0.20/sq ft
terrazzo floor	0.31/sq ft

Point & rake

exterior face brick	0.72/sq ft
---------------------	------------

Sand blast exterior

brickwork (no scaffold)	0.28/sq ft
stone (no scaffold)	0.40/sq ft

1941 average for each city = 100.00						
Metropolitan area	Cost differential	Current Indexes			% change last 12 months	
		non-res.	residential	masonry steel		
MAY 1972						
U.S. Average	8.3	376.4	353.4	368.6	359.3	+ 7.74
Atlanta	7.8	479.0	451.6	466.1	455.9	+ 6.39
Baltimore	7.9	395.5	371.8	384.5	374.3	+ 7.92
Birmingham	7.3	345.6	321.4	333.4	328.7	+ 8.50
Boston	9.0	383.0	361.8	379.4	368.3	+11.61
Buffalo	9.1	419.8	394.2	414.7	400.9	+ 9.80
Chicago	8.4	429.5	408.4	415.3	408.2	+ 8.37
Cincinnati	8.7	405.9	381.9	394.9	385.1	+ 7.66
Cleveland	9.3	421.8	396.9	412.1	402.3	+ 6.40
Columbus, Ohio	8.3	401.1	376.6	389.2	381.9	+ 6.49
Dallas	7.6	368.9	357.3	361.8	354.9	+ 7.13
Denver	8.1	403.5	379.6	398.8	385.0	+ 5.87
Detroit	9.5	422.3	402.3	421.8	406.0	+ 8.64
Houston	7.6	359.2	337.3	350.8	344.0	+ 5.39
Indianapolis	8.0	354.8	333.2	346.0	338.3	+ 7.44
Kansas City	8.1	354.0	334.5	344.3	337.1	+ 6.08
Los Angeles	8.2	417.6	381.7	405.9	397.7	+ 9.23
Louisville	7.7	374.6	351.8	367.0	358.5	+ 8.69
Memphis	7.7	358.8	336.9	346.9	341.0	+ 7.25
Miami	8.0	397.0	378.2	387.4	378.9	+ 6.99
Milwaukee	8.5	429.4	403.2	424.1	410.5	+ 6.36
Minneapolis	8.9	406.9	382.8	400.7	388.8	+10.01
Newark	8.9	374.9	352.1	369.6	360.5	+ 7.23
New Orleans	7.3	356.2	336.2	350.6	342.8	+ 7.27
New York	10.0	416.7	387.4	403.8	393.7	+ 7.53
Philadelphia	8.7	399.3	380.4	392.3	383.1	+10.87
Phoenix	7.9	214.6	201.5	207.1	203.7	+10.22
Pittsburgh	8.8	369.3	347.4	362.5	352.0	+ 8.09
St. Louis	8.7	391.3	369.3	386.3	374.3	+ 7.34
San Antonio	7.6	145.1	136.3	141.7	138.4	+ 2.22
San Diego	8.0	149.9	140.8	146.9	143.5	+ 7.73
San Francisco	9.3	548.0	500.9	544.2	526.3	+11.58
Seattle	8.6	373.2	334.0	369.7	355.6	+ 4.93
Washington, D.C.	7.8	355.3	333.7	344.7	337.2	+ 8.06

Cost differentials compare current local costs, not indexes. All the indexes on this page are based on wage rates for nine skilled trades, together with common labor, and prices of five basic building materials are included in the index for each listed city.

HISTORICAL BUILDING COST INDEXES—AVERAGE OF ALL NON-RESIDENTIAL BUILDING TYPES, 21 CITIES

1941 average for each city = 100.00

Metropolitan area	1962	1963	1964	1965	1966	1967	1968	1969	1970	1971 (Quarterly)				1972 (Quarterly)			
										1st	2nd	3rd	4th	1st	2nd	3rd	4th
Atlanta	298.2	305.7	313.7	321.5	329.8	335.7	353.1	384.0	422.4	424.0	445.1	447.2	459.2	472.5			
Baltimore	271.8	275.5	280.6	285.7	280.9	295.8	308.7	322.8	348.8	350.3	360.5	362.5	381.7	388.1			
Birmingham	250.0	256.3	260.9	265.6	270.7	274.7	284.3	303.4	309.3	310.6	314.6	316.4	331.6	340.4			
Boston	239.8	244.1	252.1	257.8	262.0	265.7	277.1	295.0	328.6	330.0	338.9	341.0	362.0	377.3			
Chicago	292.0	301.0	306.6	311.7	320.4	328.4	339.5	356.1	386.1	387.7	391.0	393.2	418.8	422.8			
Cincinnati	258.8	263.9	269.5	274.0	278.3	288.2	302.6	325.8	348.5	350.0	372.3	374.3	386.1	399.9			
Cleveland	268.5	275.8	283.0	292.3	300.7	303.7	331.5	358.3	380.1	381.6	391.1	393.5	415.6	415.2			
Dallas	246.9	253.0	256.4	260.8	266.9	270.4	281.7	308.6	327.1	328.6	341.4	343.4	357.9	364.9			
Denver	274.9	282.5	287.3	294.0	297.5	305.1	312.5	339.0	368.1	369.7	377.1	379.1	392.9	398.3			
Detroit	265.9	272.2	277.7	284.7	296.9	301.2	316.4	352.9	377.4	379.0	384.6	386.8	409.7	416.9			
Kansas City	240.1	247.8	250.5	256.4	261.0	264.3	278.0	295.5	315.3	316.6	329.5	331.5	344.7	348.7			
Los Angeles	276.3	282.5	288.2	297.1	302.7	310.1	320.1	344.1	361.9	363.4	374.2	376.4	400.9	407.8			
Miami	260.3	269.3	274.4	277.5	284.0	286.1	305.3	392.3	353.2	354.7	366.8	368.9	384.7	391.5			
Minneapolis	269.0	275.3	282.4	285.0	289.4	300.2	309.4	331.2	361.1	362.7	366.0	368.0	417.1	401.7			
New Orleans	245.1	284.3	240.9	256.3	259.8	267.6	274.2	297.5	318.9	320.4	327.9	329.8	341.8	350.9			
New York	276.0	282.3	289.4	297.1	304.0	313.6	321.4	344.5	366.0	367.7	378.9	381.0	395.6	406.5			
Philadelphia	265.2	271.2	275.2	280.8	286.6	293.7	301.7	321.0	346.5	348.0	356.4	358.4	374.9	394.2			
Pittsburgh	251.8	258.2	263.8	267.0	271.1	275.0	293.8	311.0	327.2	328.7	338.1	340.1	362.1	364.5			
St. Louis	255.4	263.4	272.1	280.9	288.3	293.2	304.4	324.7	344.4	345.9	360.0	361.9	375.5	385.5			
San Francisco	343.3	352.4	365.4	368.6	386.0	390.8	402.9	441.1	465.1	466.8	480.7	482.6	512.3	535.3			
Seattle	252.5	260.6	266.6	268.9	275.0	283.5	292.2	317.8	341.8	343.3	347.1	349.0	358.4	363.0			

Costs in a given city for a certain period may be compared with costs in another period by dividing one index into the other; if the index for a city for one period (200.0) divided by the index for a second period (150.0) equals 133%, the costs in the one period are 33% higher than the costs in the other. Also, second period costs are 75% of those in the first period (150.0 ÷ 200.0 = 75%) or they are 25% lower in the second period.

This pioneering lighting/ceiling installation in Tacoma is an 11-month wonder.

Barely 11 months from the day Keene's Sechrist Lighting division received preliminary drawings from Skidmore, Owings & Merrill, this remarkable concept in fluorescent downlighting was a reality.

Sechrist had manufactured and delivered the last of 1,889 custom lighting fixtures. Each is a 22-inch cube with an acrylic lens deeply recessed in the housing, and every other one is equipped with a tulamp ballast. All were installed in perfect alignment, their white "U" lamps diffusing a warm glow within a geometric pattern of dark reveals.

How did Sechrist meet a tight deadline with a large order of fixtures no one had ever seen before? By smoothly meshing engineering and production know-how. Sechrist lighting experts worked long and hard with the architectural engineers and electrical contractors to design and fabricate the special fixtures.

In the words of the architect's project manager, "The project required fast action, and Keene was responsive to our needs."

If you create unusual lighting designs, let us show you a brief slide

presentation documenting this project. You'll see why you can count on Sechrist's special projects team to execute your ideas successfully—on time and on budget. Call us at (303) 534-0141, or write Keene Corporation, Sechrist Lighting, 4990 Acoma St., Denver, Colo. 80216.

KEENE
CORPORATION

SECHRIST LIGHTING

We've just begun to grow.

For more data, circle 36 on inquiry card

PHOTOGRAPH: TOM UPPER



*Main banking floor of the Bank of Washington Plaza, Tacoma, Washington.
Design concept developed by Skidmore, Owings & Merrill,
Architects, Engineers, Portland, Oregon.
General Contractor: Donald N. Drake Co., Portland, Oregon.
Electrical Contractor: Carl T. Madsen, Inc., Tacoma, Washington.*

CPR urethane provides more insulation, seals any shape, fights fire, resists chemicals, adds strength, absorbs sound.

Great stuff. But if I specify, who will apply it?

There's a network of applicators and fabricators across the nation, trained and equipped by CPR. They have the skilled personnel and the right equipment to pour, spray-in-place, or supply board stock.

They make use of the wide range of dimensionally stable CPR materials, such as the UL-classified isocyanurates: KODE 25™ and CPR 421 spray, both having low smoke-emission properties and high temperature tolerance.

So specify urethane insulation wherever you feel it's right for the job. There's a qualified CPR applicator or fabricator in your area, ready to help.

The Upjohn-owned Admiral Equipment Company, manufacturer of urethane application equipment, makes CPR the first and only urethane systems supplier offering a complete urethane capability through equipment, materials, and technology.

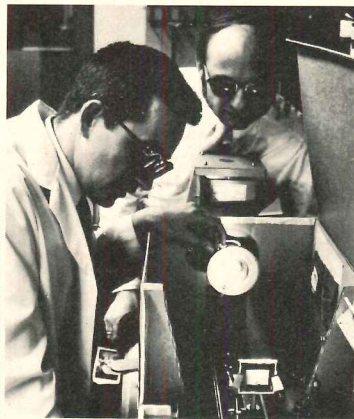
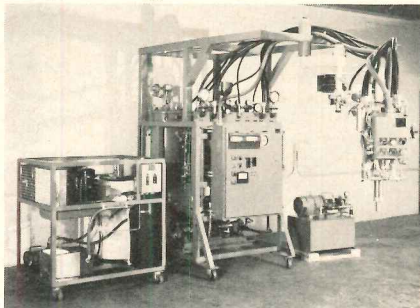

Upjohn's Donald S. Gilmore Laboratory provides CPR customers with the support of one of the world's most extensive facilities devoted to urethane product development and new applications technology.

KODE 25 is a new, urethane-type rigid isocyanurate foam insulation material, classified by Underwriters' Laboratories, Inc., with a Fire Hazard Classification Flame Spread Rating of 25, according to UL 723 and ASTM E-84 test method (UL Tunnel Test). This means higher fire retardance and a temperature tolerance to 300°F. It passes most building codes.

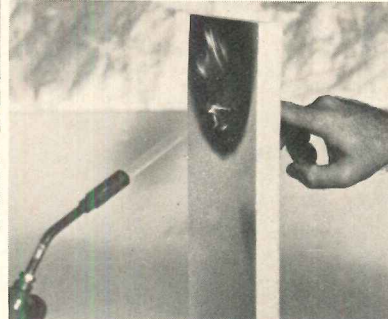

CPR is your single source for the most up-to-date data and information on urethane applications. Ask us what you want to know.

CPR DIVISION THE UPJOHN COMPANY, Dept. A
555 Alaska Avenue, Torrance, Calif. 90503

- Please send me more information on CPR insulation.
- Please send the name of your representative in my area.
- I would like a CPR sales engineer to call.



Name _____ Position _____

Company _____

Address _____

City _____ State _____ Zip _____

For more data, circle 37 on inquiry card

Furniture that's built the way people are built. Soft, smooth, no sharp edges.

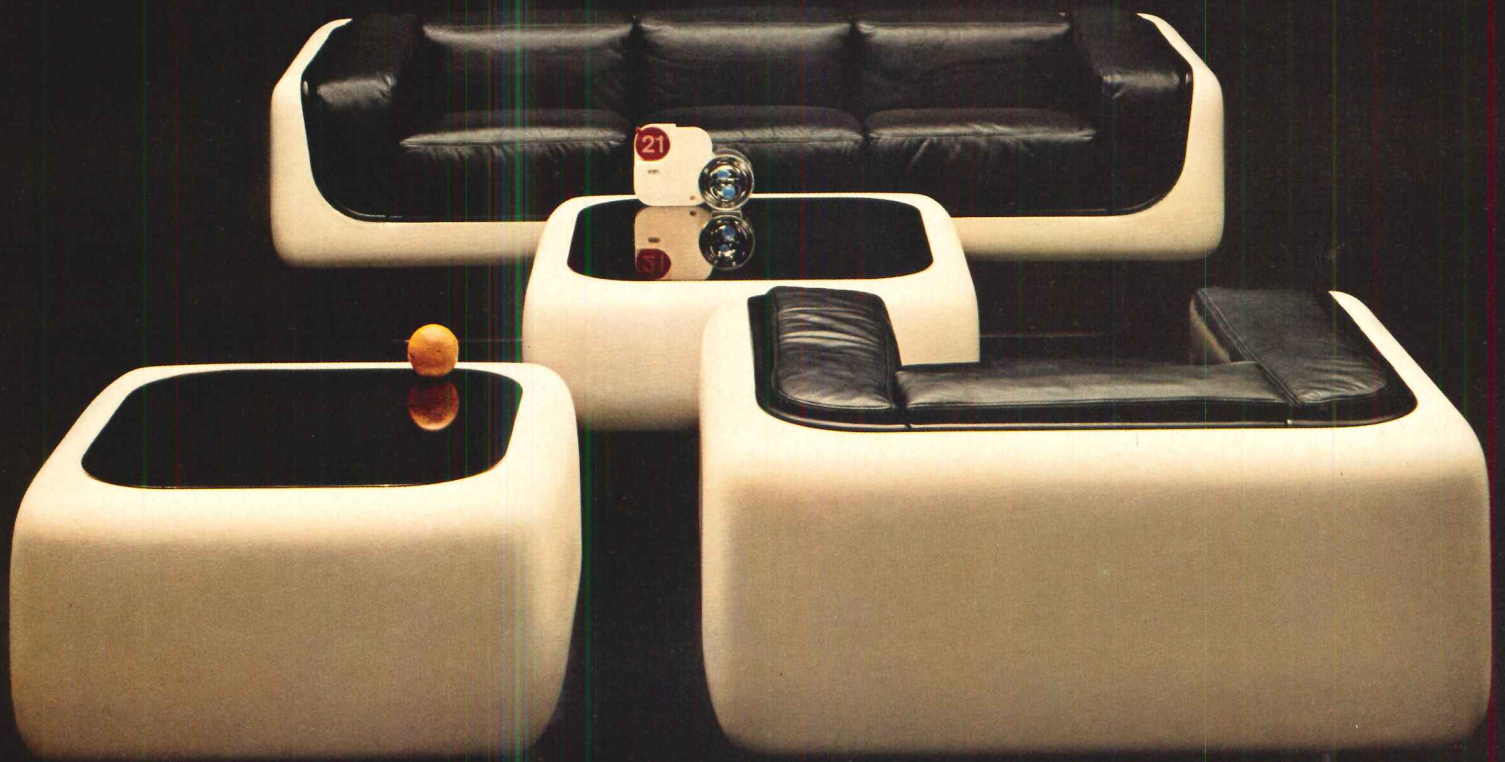
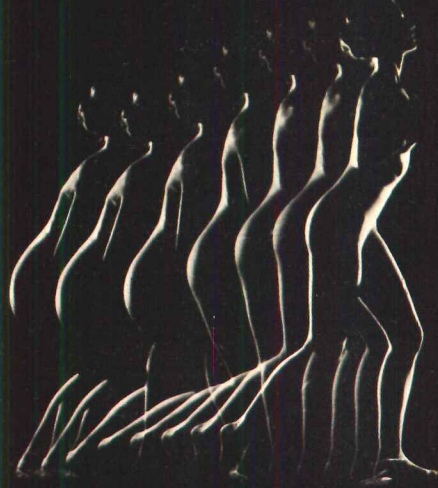

Steelcase Soft Seating.

Furniture without edges for a sometimes sharp, hard-edged world. Sculptured Fiberglas shells cradle deep, double-thick cushions and rest on gently contoured, almost unseen, acrylic bases.

Sofa and club chair cushions feature Steelcase Continental Soft Leathers or urethane. Complementary tables are crowned with thick mirrored bronze solar glass.

Steelcase Soft Seating. Designed for comfort. In offices, reception areas and homes. For people who appreciate

a world without sharp edges.

See Soft Seating in our showrooms in fifteen major cities. Or write for folder. Steelcase Inc., Grand Rapids, Michigan; Steelcase Canada Ltd., Toronto.

Steelcase

In contract, specify **the**
Wilson-Art
look...

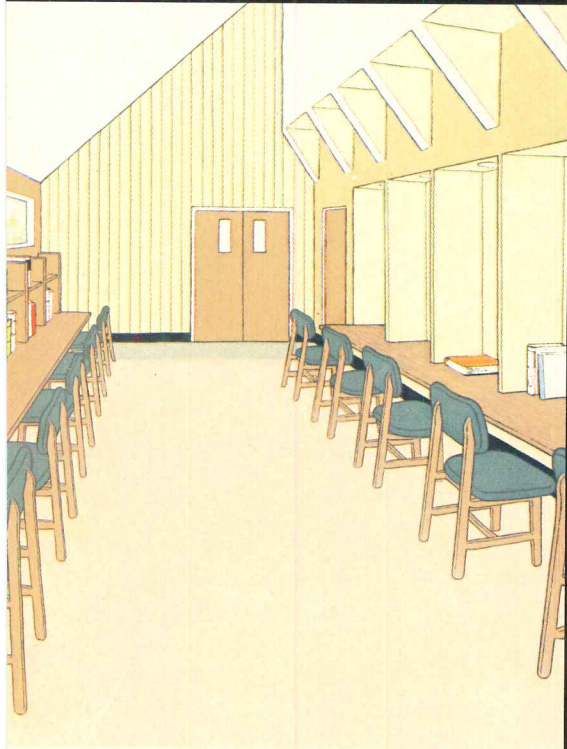

SCHOOLS:

Durable Wilson-Art laminated plastics help create an environment for study that is durable enough to take the hard knocks of school life. Write for Brochure #101



HOSPITALS:

Hospitals, nursing homes, and clinics are kept cleaner, easier, with low-maintenance Wilson-Art laminated plastic surfaces. A sanitary environment is much easier and more economical to maintain with Wilson-Art. Write for Brochure #102

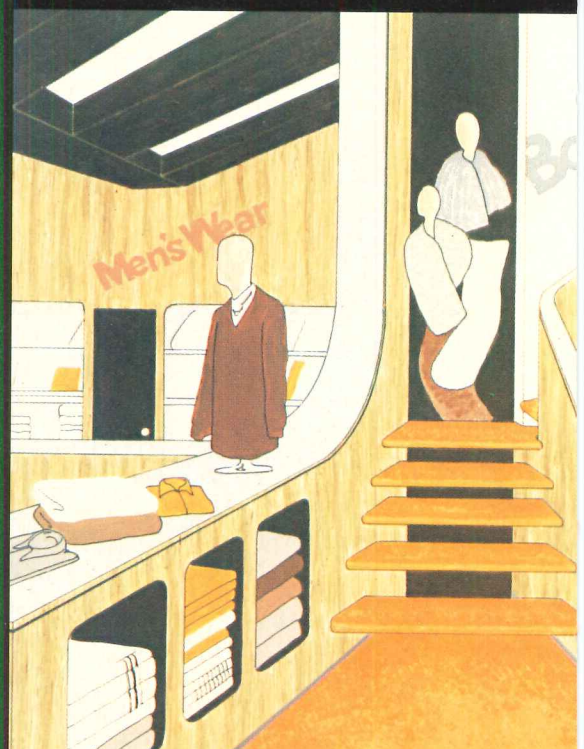

RETAIL STORES:

Imaginations can run free with design ideas—all carried out with beauty and with functional benefits. That's what the Wilson-Art Look in laminated plastics is all about! Write for Brochure #103

When the chips are down,
you can depend on Wilson-Art.



RALPH WILSON PLASTICS COMPANY TEMPLE, TEXAS
ARCHITECTURAL PRODUCTS DIVISION **DART**
INDUSTRIES, INC.

When surface material requirements range from beauty and esthetics to durability and function (and you want to be sure of complete coordination), it's time to specify the Wilson-Art Look. You, and your client will be pleased—for a long time to come!

Specification of Wilson-Art laminated plastics for contract applications allows design freedom, perfect color coordination, and one-supplier simplicity.

And because Wilson-Art specializes in contract we can offer you—the specifier—a total "hard-surface" decorative package. Wilson-Art DOR-

there's more than meets the eye!



RESTAURANTS:

In serving areas, Wilson-Art helps create an appetizing mood. In food preparation areas, Wilson-Art laminated plastic offers a sanitary, functional surface approved by the National Sanitation Foundation. Write for Brochure #104



HOTELS/MOTELS:

A simple change in specifications —you've got two (or two hundred) uniquely distinctive rooms, all from the same basic design . . . all specified from more than 140 Wilson-Art laminated plastic wood-grains, solids and patterns! Write for Brochure #105

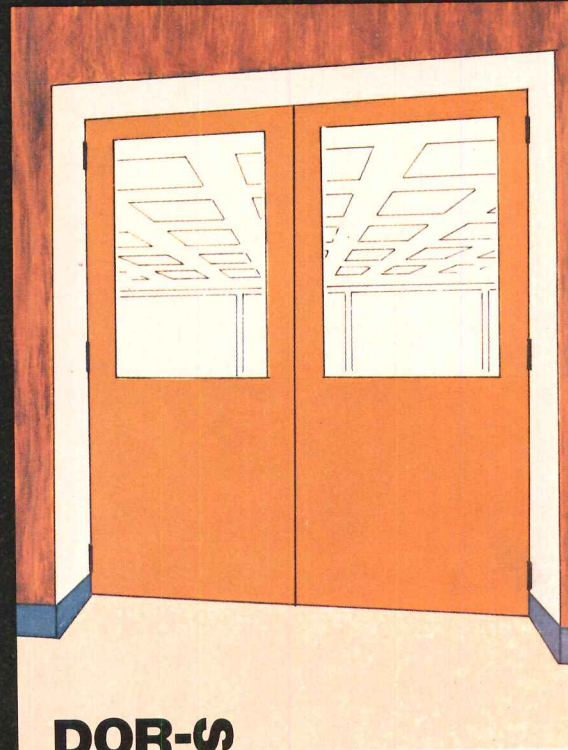

—a tough new face, from Wilson-Art! Doors surfaced with 1/8" thick Wilson-Art laminated plastic DOR-SURF are exceptionally tough, impact and abrasion resistant, and cost about the same as conventionally finished doors. (Matching Wilson-Art for fire doors also available.) Write for Brochure #106

SURF for impact and abrasion resistant doors; three types of Wilson Wall Panel Systems; a variety of finishes, including deep, heavily textured Cuero finish; over 140 solid colors, woodgrains and patterns; plus immediate service anywhere in the United States.

See how much better it is to specify Wilson-Art. Call the Architectural Design Representative nearest you.

- | | | | | |
|--------------------------|-------------------------------|-----------------------------|-------------------------------|----------------------------|
| Atlanta
404 373-2223 | Chicago
312 437-1500 | Los Angeles
213 941-1219 | Miami
305 822-5140 | New Jersey
215 923-5542 |
| New York
914 268-6892 | San Francisco
415 782-6055 | Seattle
206 228-1300 | Temple, Texas
817 778-2711 | |

For more data, circle 39 on inquiry card

When the chips are down,
you can depend on Wilson-Art.



RALPH WILSON PLASTICS COMPANY ARCHITECTURAL PRODUCTS DIVISION TEMPLE, TEXAS DART INDUSTRIES, INC.

We gave the most beautiful building in Chicago the air.



The architects of Chicago's award-winning Lake Point Tower apartments needed a heating and air conditioning system that would allow them to keep the smooth, flowing design of their building.

General Electric custom designed our Zoneline™ heating-cooling unit to meet their needs.

They had their luxurious-looking building and solved some other problems, too. Like the problem of the sunny side of the building being too hot while the shady side was too cool. Our Zoneline units just cooled one side of the building while heating the other.

And with hundreds of different people living in the apartments, there were lots of different temperature demands. Everyone isn't happy with a 75-degree norm. Our Zoneline units allow each tenant to set his own temperature. Whether he faces the sun and wants the temperature cooler or doesn't and wants it warmer.

At GE we have many types of Zoneline terminal package air conditioners. One of them solved a problem in Chicago. But all of them are flexible enough to solve heating or air conditioning problems in any structure, anywhere.

Look up your GE Air Conditioner distributor in the Yellow Pages, and give him a call. He'll be glad to give you the air.

GENERAL  ELECTRIC

Lake Point Tower, Chicago
Developers: Hartnett-Shaw & Associates
Architects: Schipporeit-Heinrich, Inc.
Structural Engineer: William Schmidt & Associates
General Contractor: Crane Construction Company, Inc.
Mechanical Engineer: William Goodman

For more data, circle 40 on inquiry card

Be sure you specify architectural finishes based on Dow Corning® brand silicones. More than nine years of actual in-place field performance demonstrate that finishes made with Dow Corning silicones can be specified for a 20-year life in any climate. You can select from a full spectrum of colors.

Silicone-based coatings give steel and aluminum siding, panels, roofing, fascia, and trim unmatched protection from sun, wind, and weather. They resist blistering, chalking, chipping, and peeling, and have excellent color retention. They are easily touched up in the field if marred.

Yet the cost of silicone-based finishes is almost identical with that of organic coatings, and 50 to 70% less than other kinds of high-performance coatings that have no demonstrably better performance.

A colorful new brochure on coil-coated panels using these finishes, and the names of paint manufacturers who supply them, is in the current Sweet's Architectural and Industrial Construction Files. Or write Dow Corning Corporation, Dept. A-2301, Midland, Michigan 48640.

Silicones for coatings from
DOW CORNING

DOW CORNING

For more data, circle 41 on inquiry card

**For "life-of-the-building" beauty
...and proved performance.**



you haven't seen the Venette[®] yet, here's your chance to see 16,400 of them.

The IDS Center's soaring expanse of glass represented a unique opportunity for Venette . . . not just because of the impressive number of blinds needed, but because Venette's ultra-slim one-inch louvers are so beautifully unobtrusive when viewed from across the street.

Or, across the room.

And because Venette virtually vanishes when open, tenants of the upper floors of the 51 story tower will enjoy magnificent, unobstructed views of Minneapolis, while easily maintaining fingertip control of solar heat, glare, and interior/external light balance.

Why not look at the blind that's earning consistently high scores with architects, space planners, building owners and tenants?

Like the IDS Center — a case where one look was worth 16,400.



Model IDS suite shows Venettes installed at pre-set angle.

Architect: Philip Johnson & John Burgee, New York City.

Owner: IDS Properties, Inc., a subsidiary of Investors Diversified Services, Minneapolis, Minn.

Gen. Contr.: Turner Construction, Chicago, Ill.

Venetian Blind Contr.: Julian Shade, Inc., Milwaukee, Wisc.

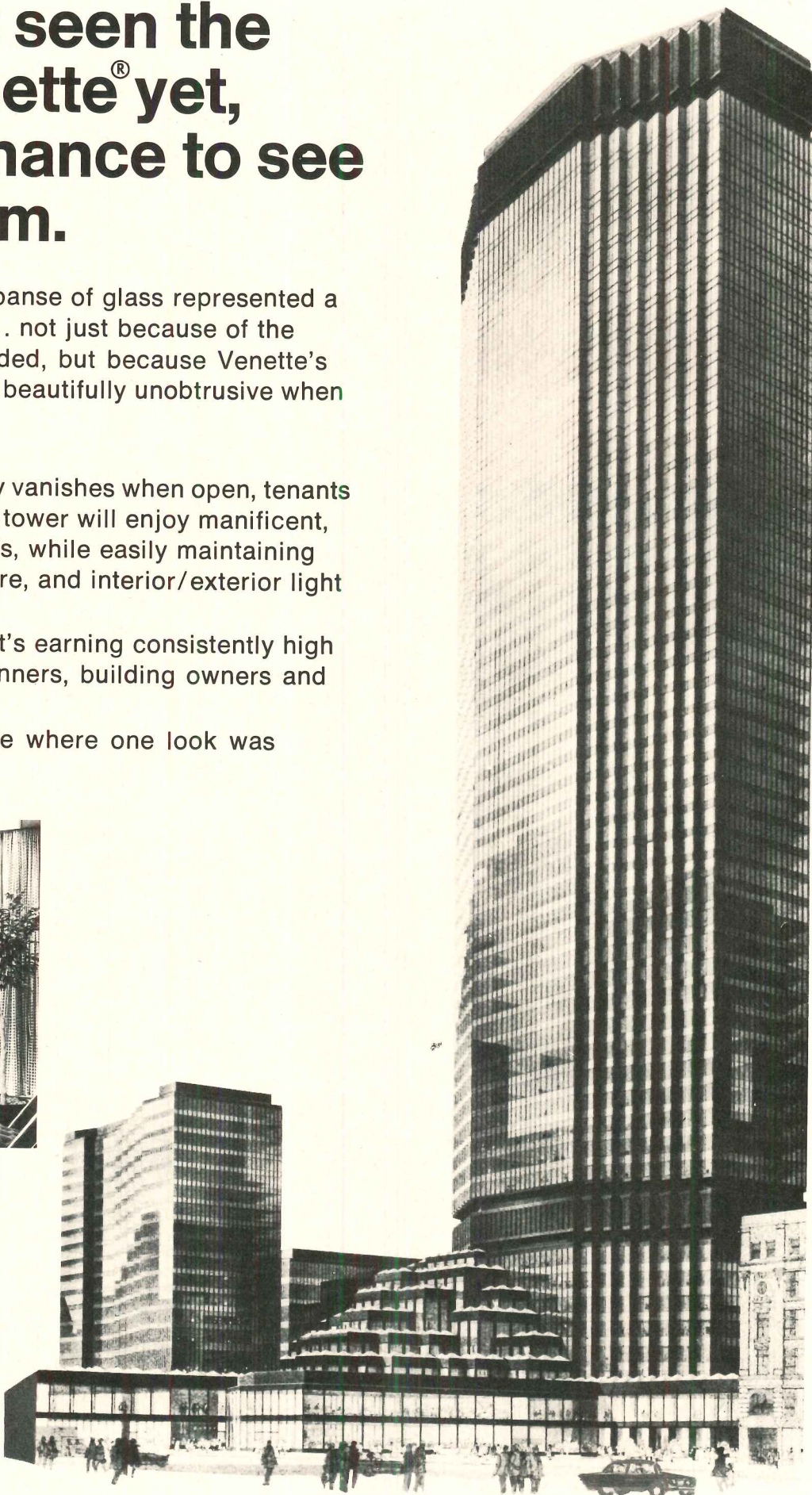

Listed in Sweets, Spec-Data, or write Alcan Aluminum Corporation, 100 Erieview Plaza, Cleveland, Ohio 44114

ALCAN ALUMINUM



For more data, circle 42 on inquiry card

Westinghouse outdoor lighting turns the night on with new shapes and colors.

Today's architecture is clean and simple. We've designed an outdoor light that works with it—the ALS (Architectural Lighting System).

The ALS is designed for streets, malls, parking lots—anywhere attractive, functional lighting is required. The important word is "attractive." With its straight line design, the ALS fits with today's architecture.

Available in four shapes, six wattages, three lamp types, and sixteen colors, the ALS is truly versatile.

Westinghouse can also supply square steel, aluminum, and wood poles to complement the ALS. And you can color match the poles to the fixture.

For flexibility, the ALS can be mounted one, two, three, or four to a pole.

Day or night, our ALS will turn people on.

If you'd like to learn more about the ALS, write Westinghouse Electric Corporation, Outdoor Lighting Division, P.O. Box 5817, Cleveland, Ohio 44101. G-1-72

For more data, circle 43 on inquiry card

You can be sure...if it's Westinghouse

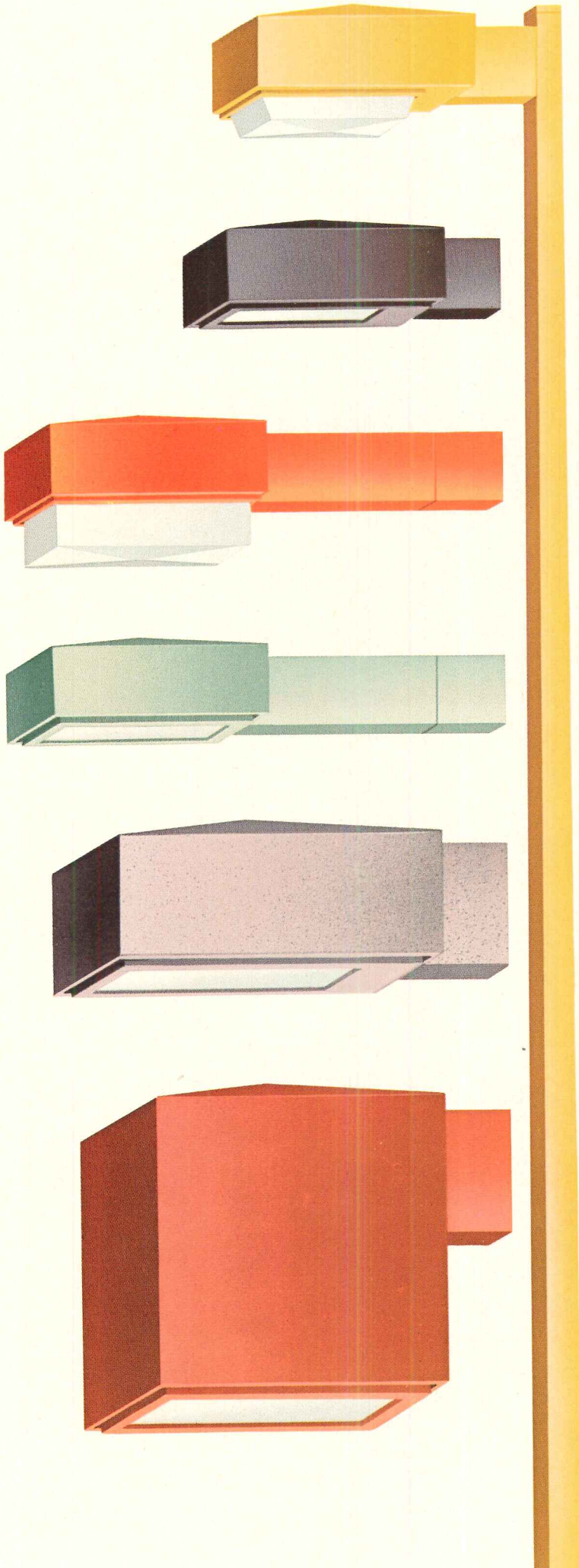

Holds the temperature steady.

RADA'S THERMOSTATIC HOT AND COLD WATER MIXERS.



Neither pressure drop nor temperature rise can upset the steadiness of Rada control. That's the kind of double-pronged safety you can count on with our thermostatic mixing valves.

Rada has a bimetallic brain which automatically adjusts for both temperature and pressure fluctuations in the hot and cold water lines. Scalding or freezing bursts are things of the past and Rada-safety becomes a built-in fact.

Specify Rada for your next job. It's the doubly safe mixing valve for showers in schools, hospitals, nursing homes, hotels and recreational shower rooms as well as industrial plants.

You'll find Rada valves are available in a variety of sizes, and flow rates. With connections sized from 1/2" to 2", they are designed to meet all specific requirements for shower, tub/shower, or gang-shower installations.

The Rada Thermostatic Hot and Cold Water Mixers. Ask for them and make safety part of the specifications.

Richard Fife Inc.

1140 Broadway, New York, N.Y. 10001
Phone: (212) 683-0745

For more data, circle 44 on inquiry card

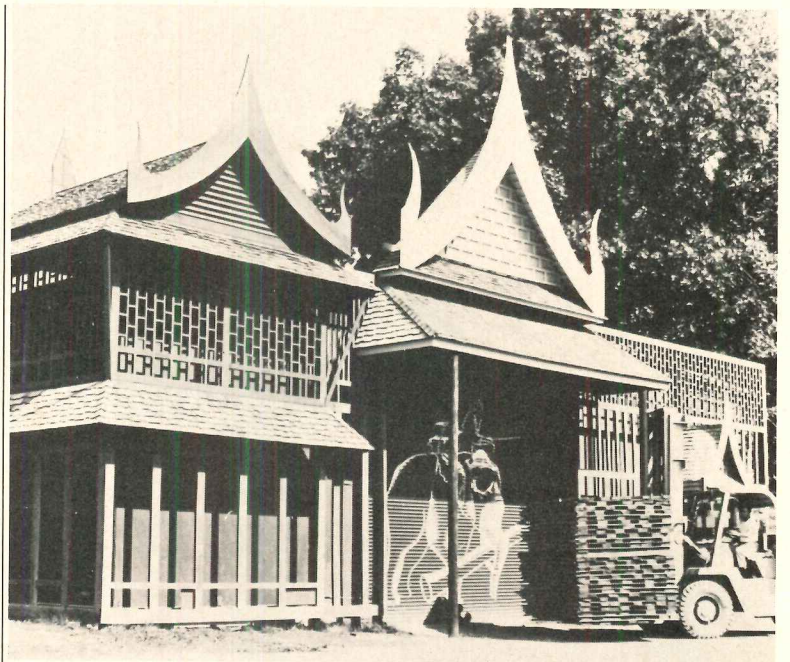

HOUSE OF TEAK

The most comprehensive inventory in America

From around the world, bold inventories of kiln dried hardwood lumber and veneer-ranging from domestic Ash to exotic Zebrawood.

CHESTER B. STEM, INCORPORATED
GRANT LINE ROAD, NEW ALBANY, INDIANA



For more data, circle 45 on inquiry card

There's something entirely new in reflective materials

... it's PLEXIGLAS™.

MIRROR

Plexiglas Mirror is an image reflecting acrylic plastic sheet that is lightweight, breakage resistant, installed easier and safer than glass mirrors and available colorless and in six transparent colors.

Plexiglas Mirror can be cut, routed, drilled and machined. It can be decorated by silk screening, spray painting or other techniques. Write for our free brochure on Plexiglas Mirror.

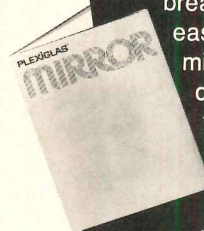

ROHM AND HAAS
PHILADELPHIA, PA. 19105

For more data, circle 46 on inquiry card

GAF MAKES FLOORINGS FOR ALL KINDS OF FEET.

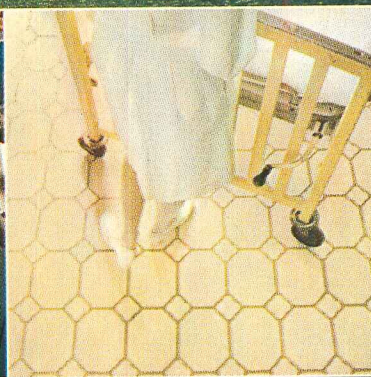

A floor covering should be chosen not only to withstand the number of feet that will go over it, but for the particular type of feet as well.

That's why, when it comes to resilient floorings, GAF makes over 300 types, patterns, and colors—to try to have exactly the one you'll need.

For instance, for a medium traffic area you might choose new Fashioncraft™ floor tile. This 3/32" grade comes in a striking assortment of high-fashion designs, making it a worthy candidate for residential areas, too. Or ask us about the GAF Thru-Chip® lines which offer no-wax maintenance in heavy traffic areas.

But perhaps you'll decide sheet goods can do the job better.

In that case, GAF offers sheet vinyl that comes up to 12' wide, is cushioned for softness and quiet, and needs no waxing or scrubbing.

Whether you're catering to high heels, office furniture legs, or shopping cart wheels, consider GAF. After all, we've got over 300 different ways to help.

All are fire-safe; and meet Federal specifications where applicable.

For more information, contact: GAF Architectural Flooring, Dept. L-5, 140 West 51 Street, New York, New York 10020.



For more data, circle 47 on inquiry card



Glass or gold panels? It's tenants' choice with Andersen Perma-Shield® Casements.

The ease with which the sash of Andersen Perma-Shield® casements can be removed and replaced *from inside* inspired an interesting architectural feature in this professional office building in Louisville, Kentucky.

One third of the openings are glazed with 1-inch Mirawall insulated panels in a yellow gold color. The other two thirds have Andersen's standard welded insulating glass. So each tenant can arrange the glass/panel combination to fit his needs for privacy, aesthetics, and so on.

The arrangement is easily changed to suit a new tenant's needs. It is therefore a random one, but could be ordered if desired.

Important to the architect was the fact that the installed price of the Andersen casements was about equal to that of aluminum alternatives which lacked many features offered by Perma-Shield.

And, as always, the minimum maintenance required by Perma-Shield was a leading factor in their selection.

Andersen features, plus an architect's imag-



Building: Newburg North Professional Park, Louisville, Kentucky.
 Architect: Robert F. Crump, Louisville, Kentucky.



ination, have once again resulted in a handsome, distinctive building with high tenant appeal.
 Further information on all Andersen Windows, and the design opportunities they offer, is available from your Andersen dealer or distributor, in your Sweet's File (Sections 8.16/An. and 8.6/An.) or by writing us direct.

Andersen Windowalls®
 ANDERSEN CORPORATION BAYPORT, MINNESOTA 55003



For more data, circle 48 on inquiry card

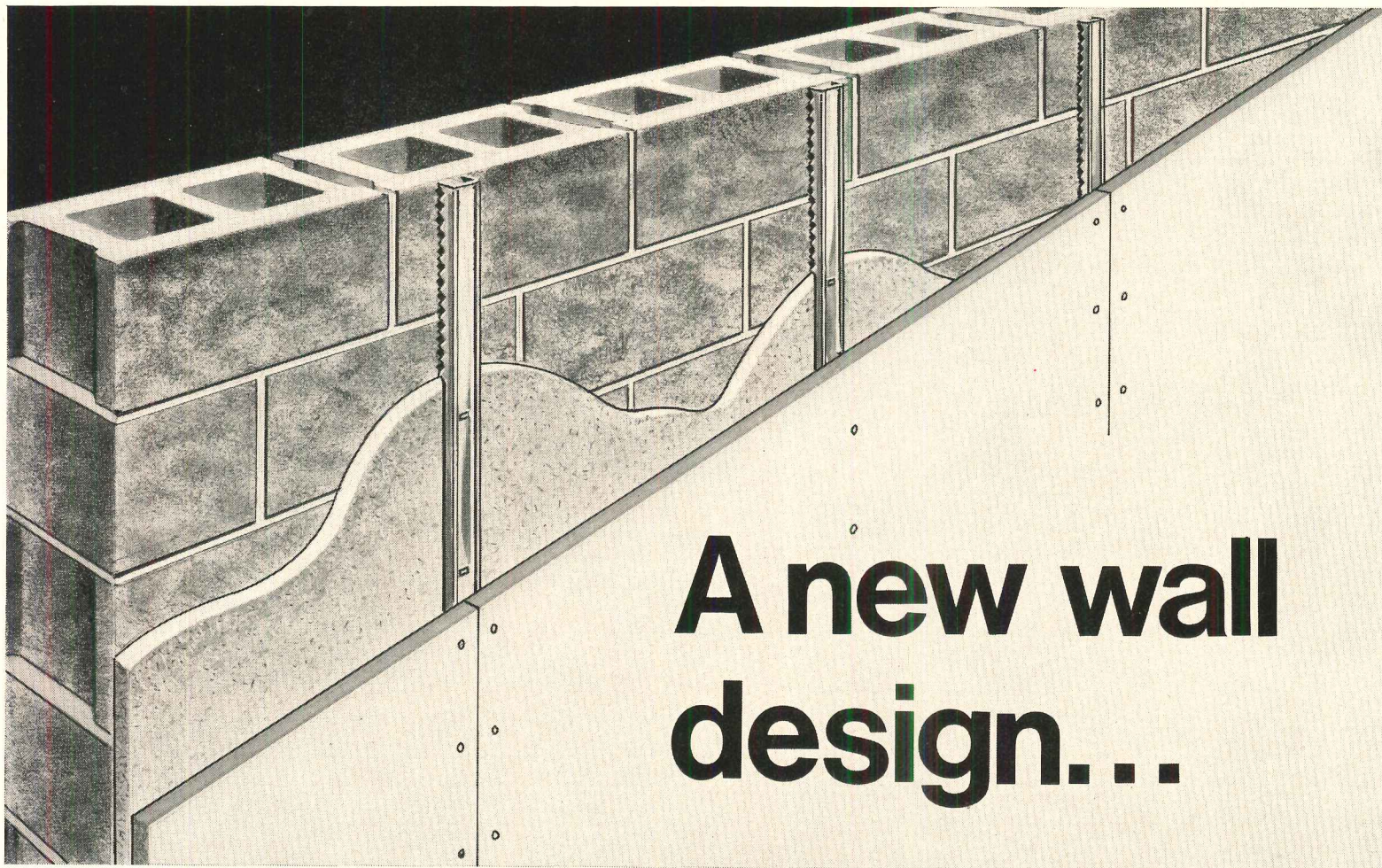

A new wall design...

THE ZONOLITE THERMO-STUD SYSTEM

When you insulate a masonry wall and finish with gypsum drywall, try the Zonolite Thermo-Stud System.

Positive, mechanical fastening eliminates tricky adhesives so there's no waiting for cure and no worry about bond failures.

Wood furring strips aren't necessary so there's no interruption in the insulation. That means no thermal shorts and no shadowing.

The secret: moisture resistant, lightweight Zonolite Polystyrene Foam with its excellent insulating values held in place with the Thermo-Stud serrated furring channel. The channel pierces the foam and is then secured to the wall with a hardened nail. This unbeatable combination of a rigid insulation board and a metal stud provides a smooth firm surface. Immediate application of the drywall is possible

using self-tapping screws to attach it to the Thermo-Stud channel.

All this plus an installed cost competitive with other insulation methods.

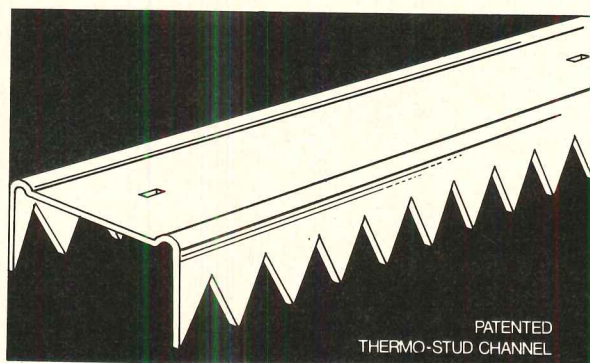

We'd like to tell you more. So, send the readers service card for complete data today. Or write directly to W. R. Grace & Co., Construction Products Division, 62 Whittemore Ave., Cambridge, Mass. 02140.

GRACE ZONOLITE

For more data, circle 49 on inquiry card

Bally belongs.

For mass feeding in the clouds
or here on earth

**Bally Prefabs set the standard
for Walk-In Refrigeration**



Bally Walk-In Coolers and Freezers belong everywhere mass feeding takes place. They can be assembled in any size for indoor or outdoor use from standard panels insulated with four inches of foamed-in-place urethane, UL 25 low flame spread rated. Choice of stainless steel, aluminum or galvanized. Easy to enlarge . . . easy to relocate. Refrigeration systems from 35°F. cooling to minus 40°F. freezing. Subject to fast depreciation and investment tax credit. (Ask your accountant.) Write for 28-page book and urethane sample. **Bally Case and Cooler, Inc., Bally, Pennsylvania 19503.**



© 1972, ALL RIGHTS RESERVED.
ADDRESS ALL CORRESPONDENCE TO DEPT. AR-5

For more data, circle 50 on inquiry card

Clark announces...

The first major improvement in Fire Doors since 1952!

Our new Class "A" rated fire door is the first important advance in fire door construction since the introduction of the composite door in 1952. It opens and closes fast enough to be used wherever you'd use a conventional door . . . so you need only **one** wherever you previously needed both a fire door and an industrial door. Because we supply the vertical casings, door, and hardware as one "package" — ready to install — on-site construction is drastically reduced.

Vertical casings — simplify installation . . . transfer most of weight from wall to floor . . . a Clark exclusive.

Door stop — saves wall by transferring impact of closing doors from wall to special shock-absorbing binder.

Slotted brackets — on door header . . . permit easier adjustments to conform to local fire laws . . . another Clark exclusive.

Heavy-duty track — 10-gauge track designed for "1000 operations a day" for many years without sag or undue wear.

Fast operating — reduces drafts, vehicle collisions, etc.

Lightweight — yet protects at least as well as **any** industrial type fire door of **any** weight.

Write or call for literature and specifications.

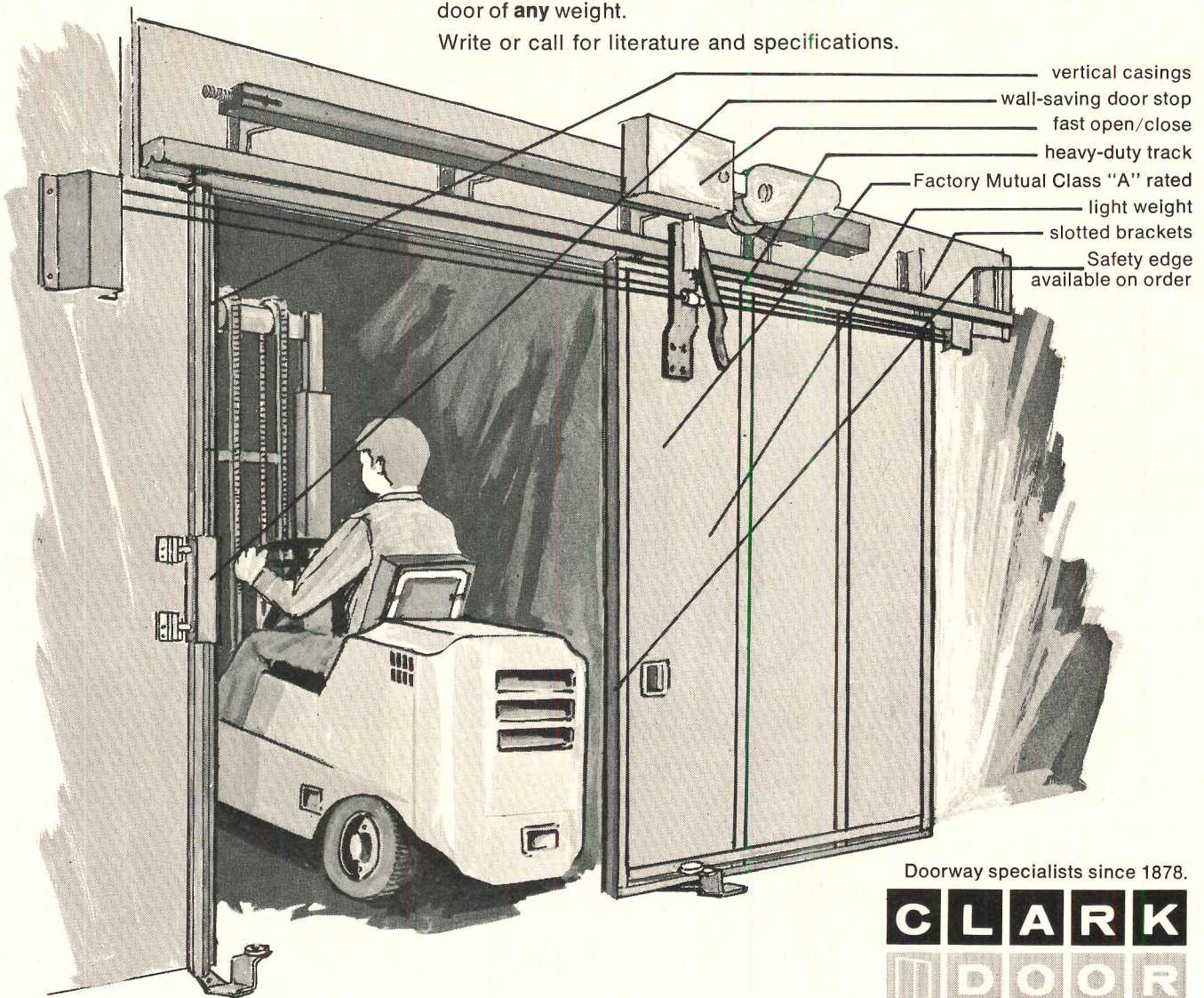

Doorway specialists since 1878.

CLARK
DOOR

69 Myrtle Street, Cranford, N. J. 07016 (201) 272-5100, Telex 13-8268

For more data, circle 51 on inquiry card

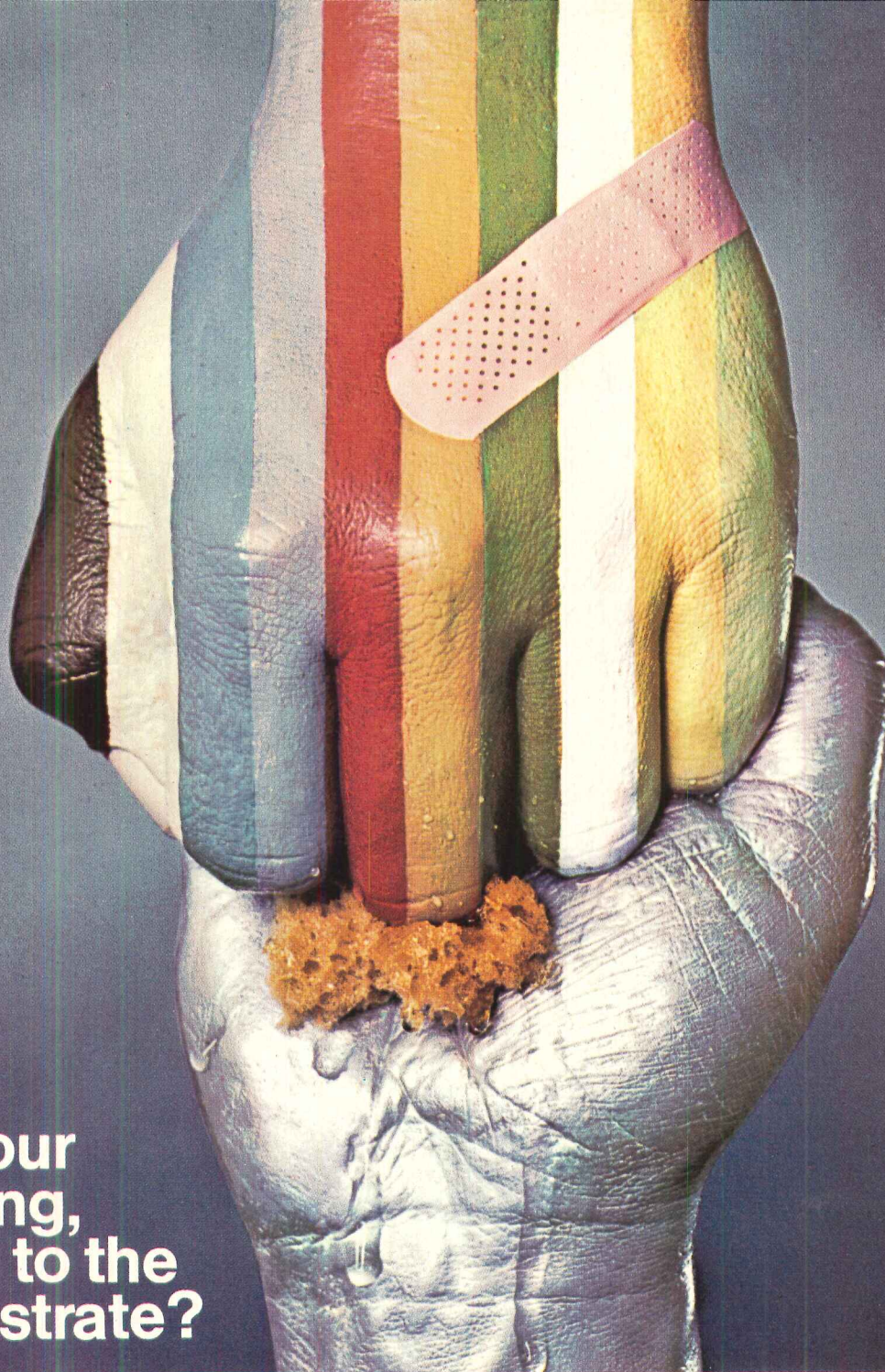

If you scratch our new PVF coating, what happens to the aluminum substrate?

Nothing.

A protective layer of aluminum oxide forms on the substrate surface. This natural protection resists corrosion and discourages flaking or adhesion loss.

Obviously, any organic coating will deteriorate in time. When it does, it becomes spongelike in texture. Retains considerable moisture. Wet cycles last longer. The hydrophilic cells trap such contaminants

as sulfur dioxide. At this point, the corrosive effects of electrolytic action usually become apparent with most substrates. You get chemical attack at the interface; underfilm problems causing flaking or loss of adhesion; staining or streaking. But if the substrate is aluminum, the effects of electrolytic action do not become apparent. An aluminum substrate *protects* rather than destroys an organic coating.

Specify our new PVF coating on the side-walls of your next building. We call it Alcoa® Super Alunalure® finish. Available in 10 superb, trend-setting colors, Alcoa Super Alunalure finish offers the advantages of a super-tough fluorocarbon coating, at a price you can live with. For details, write Aluminum Company of America, 1055-E Alcoa Building, Pittsburgh, Pa. 15219.

For more data, circle 52 on inquiry card

Change for the better with
Alcoa Aluminum

 **ALCOA**

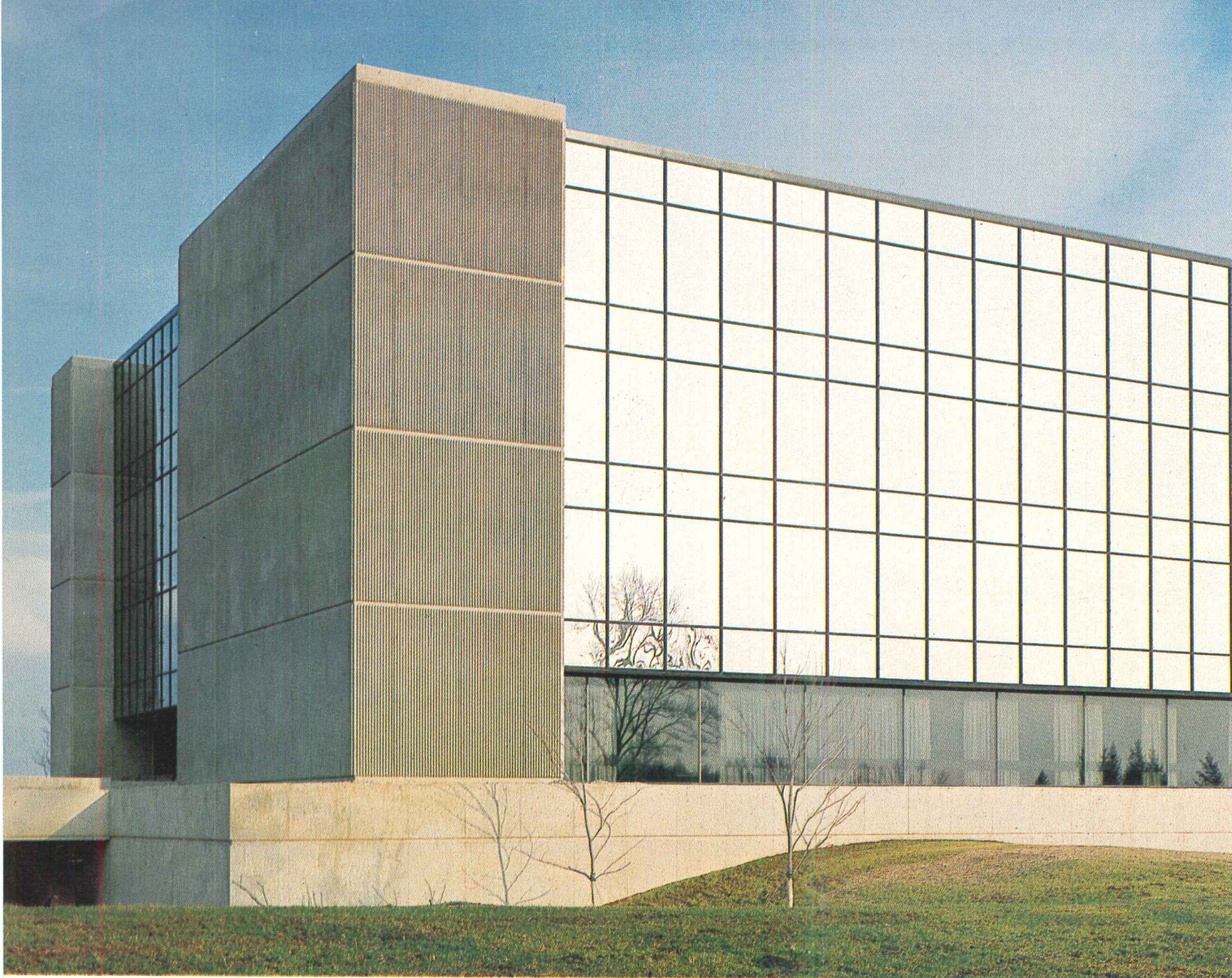

With our help, the Ashland Chemical minute, second and

One of the beauties of our Vari-Tran[®] reflective glass is what it reflects: scudding shreds of cloud; the four seasons of a tree; the color of the sky at dawn, midday and dusk. And as they change, so changes the image in the glass.

Architects Kellam & Foley took full advantage of Vari-Tran's reflective qualities when they designed the Ashland Chemical Co. Headquarters Building. Located on a spacious open tract at Dublin, Ohio, the building presents an ever-changing facade to passers-by.

Of course, they also knew that because Thermopane[®] insulating units made with Vari-Tran reflect the sun's heat and light, they reduce the size of air conditioning equipment needed. To say nothing of cutting operating costs.

Which is to show that in architectural glass as well as everything else—handsome is as handsome does.

We'll be glad to tell you the rest of the story (including the fact that Vari-Tran now comes in gold, silver, grey, blue and bronze tones). Drop a note to Libbey-Owens-Ford, Toledo, Ohio 43695.

For more data, circle 53 on inquiry card



Building changes by the day, hour, the batting of an eye.

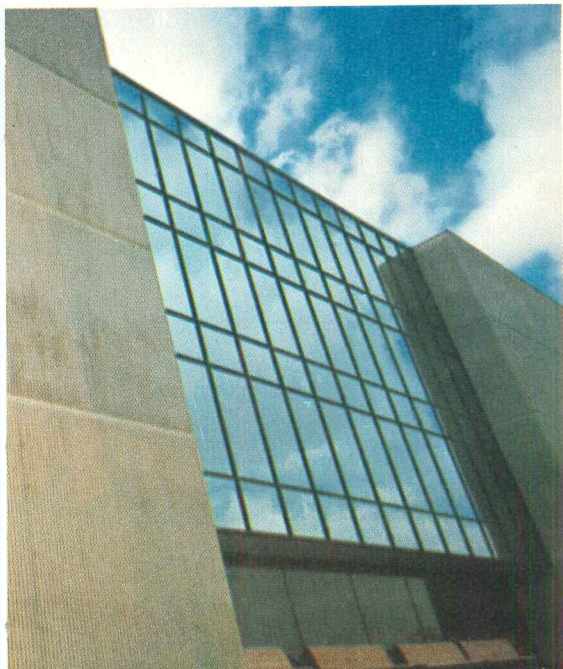

Owner: Ashland Oil, Inc. Architects: Kellam & Foley, Columbus, Ohio.
General Contractor: Martin & Nettrour, Pittsburgh, Pa.
Glazing Contractor: Ohio Plate Glass Co., Columbus, Ohio.



**L-O-F making progress...
in architecture.**

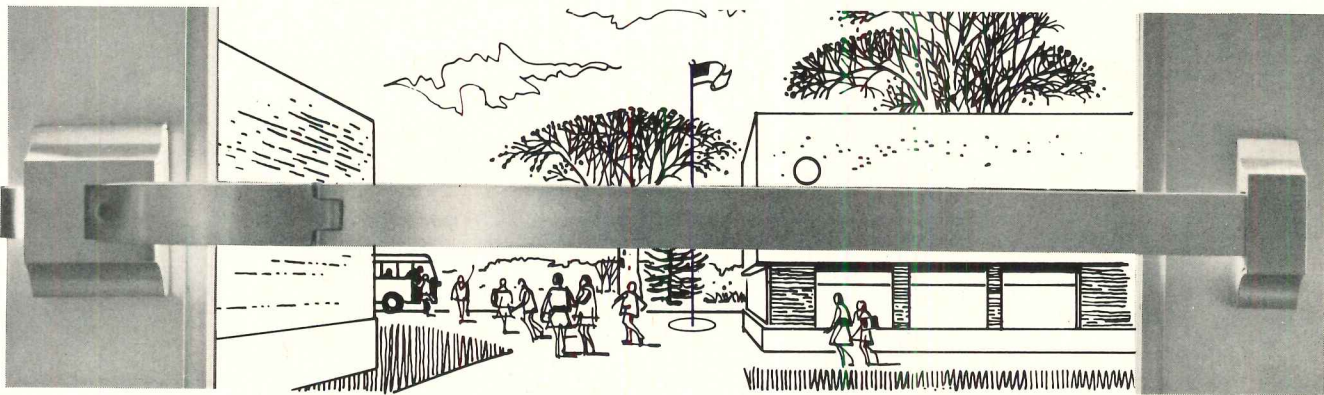

It's non-handed.
It can take abuse.
And it's attractive.

How's that for a
versatile device?

the **Eaton** door device
(formerly Reed device)

With straight-thru operation—not down—it's non-handed.

With simplified design—cross arm operates bolt directly—it can take heavy wear.

As you can see, it adds just a simple straight accent line to the door.

For more details see your Eaton Representative or contact Eaton Corporation, Lock and Hardware Division, Eaton Door Devices, Box 58, Wood Dale, Illinois 60191.

2023

For more data, circle 54 on inquiry card

EATON Security Products & Systems

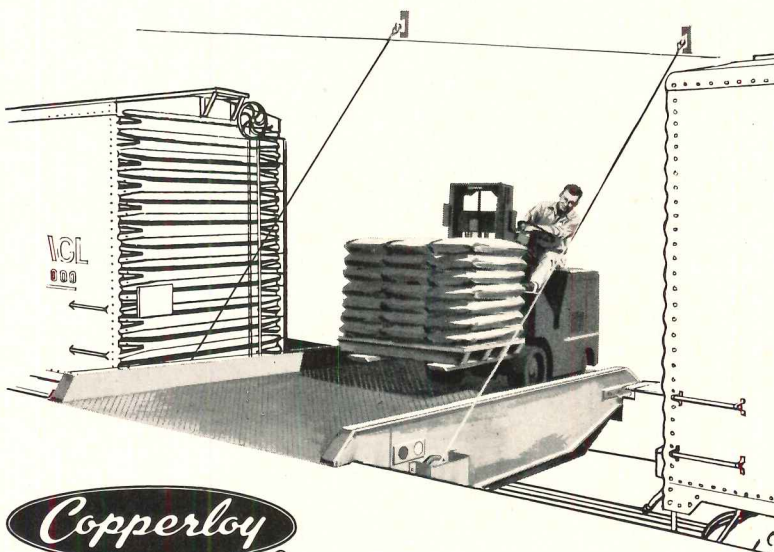

Copperloy
INTERNATIONAL®

self-powered draw bridge
ends the runaround of track well crossing.

You can bridge the rail split in materials flow at the push of a button. The Copperloy self-powered hydraulic or electric bridge comes with everything furnished for drop-in installation, including pit casement, electrical controls, automatic safety latch, hinges, and wire lead connections. Because it's completely pre-engineered, bridge can be operational within hours of delivery. Aluminum alloy throughout with all-welded unit construction. Deck can be steel grating or aluminum safety tread plate. Meets OSHA standards with magnetic brake and high gear ratio; 5" high curbs; optional hand rails. Portable models also available. Write for details.

COPPERLOY CORPORATION

8901 East Pleasant Valley Road
Cleveland, Ohio 44131 • Phone 216-524-7520

For more data, circle 55 on inquiry card

Automatic, vertical, multi-story MAIL CONVEYORS



- CONTINUOUS OPERATION
- AUTOMATIC DISPATCHING
- SERVES ALL FLOORS
- DELIVERS AND COLLECTS TRAYS
- HANDLES A TON IN 8 MINUTES

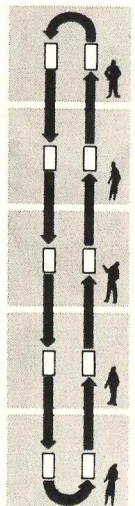

FREE BULLETIN describes Standard Conveyor Recordlift—ideal for multi-story buildings requiring inter-floor delivery of mail, documents, books, anything weighing up to 32 lbs. per load. Widely used in high-rise office buildings, insurance companies, banks, libraries, hospitals, etc. *Send today.*



**Standard
Conveyor
COMPANY**

312-E Second St., North St. Paul, Minn. 55109

For more data, circle 56 on inquiry card

OUR CARPET STANDARDIZATION PROGRAM SAVES YOU MONEY.

We're CCC, the largest manufacturer of commercial and institutional carpet systems with millions of square yards of references on the floors of major corporations, hospitals, schools and stores.

When you standardize on CCC for corporate carpet, we become your single source of responsibility for product performance, delivery, installation and maintenance.

Our program will reduce your administrative costs, assure you of consistent quality and price and give you centralized control of carpet purchases.

One call to a CCC corporate specialist will take care of your carpet needs from coast to coast. He's one of 70 experts we have around the country and he's backed by a nationwide network

of certified installers and regional standards operations managers.

To make sure you get maximum wear-life from your carpet at minimum life cycle cost, our man can help you set up a comprehensive maintenance program that's based on a building survey by a CCC maintenance consultant. The survey enables us to recommend a detailed plan for floor care procedures, frequency and equipment... including a CCC-formulated and endorsed line of maintenance chemicals.

Your CCC corporate specialist knows all about trench headerducts and other subfloor access systems and the best way to integrate carpet with them. He's well versed in leasing and can document how our Showplace

program will give you a completely carpeted building without using capital funds.

The CCC system features heavy duty Densylon carpet, constructed of Anso nylon and bonded to fire-retardant  sponge rubber cushioning. It has outstanding appearance retention, is easy to clean and keep clean, and contains a static control system. Densylon and our other heavy duty brands are available in a wide range of styles and colors so your standardization program can have all the design flexibility you want.

A carpet standardization program will effect a significant reduction in your operating costs if your supplier has the experience and expertise to make it work. CCC has both. Fill in the coupon and we'll share them with you.



 **Commercial Carpet Corp.**
 10 West 33rd Street
 New York, N. Y. 10001
 DEPT. AR-5

Attention: Mr. Walter Brooks

Please have a corporate specialist call on me.

Please send more information about your program.

Name: _____

Title: _____ Phone: _____

Organization: _____

Address: _____

City: _____

State: _____ Zip: _____

For more data, circle 57 on inquiry card

Positive thermal break

1600 Curtain Wall

a standard system with custom flexibility

A simple modification by Kawneer's design engineering department easily adapted the standard 1600 Curtain Wall System to an application where floors are anchored in place from the top down...with the bottom story 30 feet off the ground. □ Result for Vancouver's new Westcoast Transmission Building:

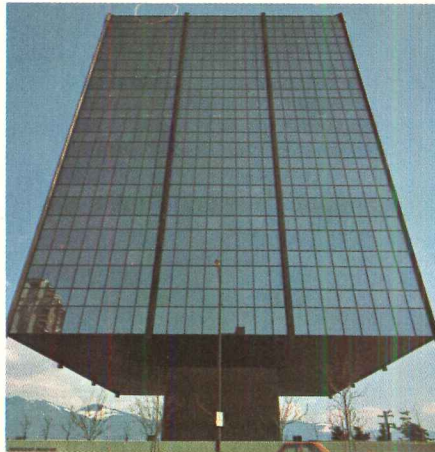

a "custom" application within standard budget requirements. □ That's how easy it is to specify 1600 Curtain Wall... in "ordinary" or "extraordinary" situations. □ And there are important dividends: 1600's positive thermal break eliminates contact between inside and outside surfaces. As a

result, heating and air conditioning costs are lowered and heat transfer (which contributes to interior condensation) is minimized. □ From the design standpoint, 1600's snap-on cover selection allows the architect to create strong verticals, shadow box effects or flush facings. All in optional Per-

manodic™ Finishes: No. 28 medium bronze, No. 40 dark bronze, or No. 29 black. □ In 1600 Curtain Wall—as in our complete line—you can depend on Kawneer to design out problems from the start... and meet the individual ones a particular project can bring. Attention to detail, that's the Kawneer concept.

Architects: Rhone & Iredale, Vancouver, British Columbia

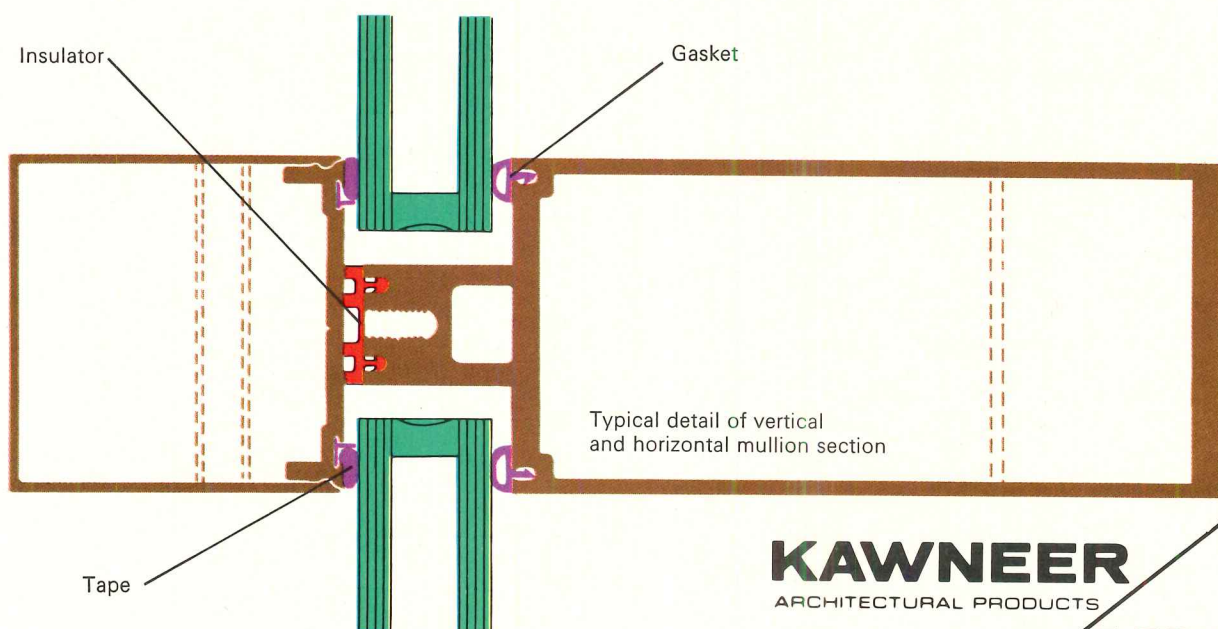

KAWNEER
ARCHITECTURAL PRODUCTS

AMAX
ALUMINUM

For full information, see your Kawneer representative or contact
Kawneer Product Information, 1105 N. Front St., Niles, Michigan 49120.

For more data, circle 58 on inquiry card



Why would anyone specify this sound control system.

When this gypsum sound control system does the same thing for **\$36** per thousand sq. ft. less.

You could specify a wood fiber sound control system and get a one-hour fire rating (Test T-3006) and an STC of 46. But it doesn't make sense when Georgia-Pacific's gypsum sound control system has a one-hour fire rating (U.L. Design #30), an STC of 45 and the total wall costs \$36 per thousand sq. ft. less.

G-P's gypsum sound control system saves installation costs, too. The 1/4" incombustible gypsum sound deadening board is applied over a wood framing system (2" x 4" studs, 16" O.C.). Then 1/2" G-P Firestop® gypsumboard or Firestop® Eterna-wall™ vinyl surfaced gypsumboard is applied to the sound deadening board. And that's it. Wall thickness is reduced by 3/4". And you've specified a system that costs \$36 per thousand sq. ft. less than a wood-fiber sound control system. So call your G-P representative today!

Georgia-Pacific

Gypsum Division
Portland, Oregon 97204



For more data, circle 59 on inquiry card

1/2" wood fiber sound deadening board

3/8" Firestop® gypsumboard

1/4" incombustible gypsum sound deadening board

1/2" Firestop® gypsumboard

DESIGNING FOR GROWTH: THE METAMORPHOSIS OF A RURAL CAMPUS INTO A UNIVERSITY TOWN

The University of Guelph in Ontario is about sixty miles west of Toronto. Founded as a university in 1964, it comprises three earlier institutions: Ontario Agricultural College, Ontario Veterinary College and the Macdonald Institute. The curricula of these schools has been augmented by academic programs in arts and sciences. The expanded teaching program called for a greatly expanded enrollment, and the school will have increased from approximately 2.5 thousand students in 1964 to 15 thousand by 1980.

In early 1964, the Guelph administration hired Project Planning Associates Limited to prepare the master development plan for its 800-acre site. Sert, Jackson and Associates and Richard Dober served as consultants on campus planning. The basic concept agreed upon by the planners was that the new university be designed as a town. There were six reasons for this: economy in land use and servicing costs; reduction of circulation time for students, faculty and staff; the desire to integrate the existing valuable buildings with their disparate scales, colors, textures and uses into a satisfying unity with the new development; the belief that in all places and at all times an urban environment has been a fruitful milieu for social and intellectual stimulus; the recognition that the charm of towns depends on the integration of diverse but thoughtful design; and the fact that 25 thousand people working in a confined area form a town, whether this is recognized and planned for or not.

The over-all circulation plan of the university reduces the need for automobile circulation by resident students and staff, and by commuting students once they have driven to school. The academic center is located along a main north-south pedestrian spine established by the master plan. A secondary pedestrian axis extends to the east and west. As the master plan (left) indicates, existing campus open spaces are reinforced and new open spaces created.

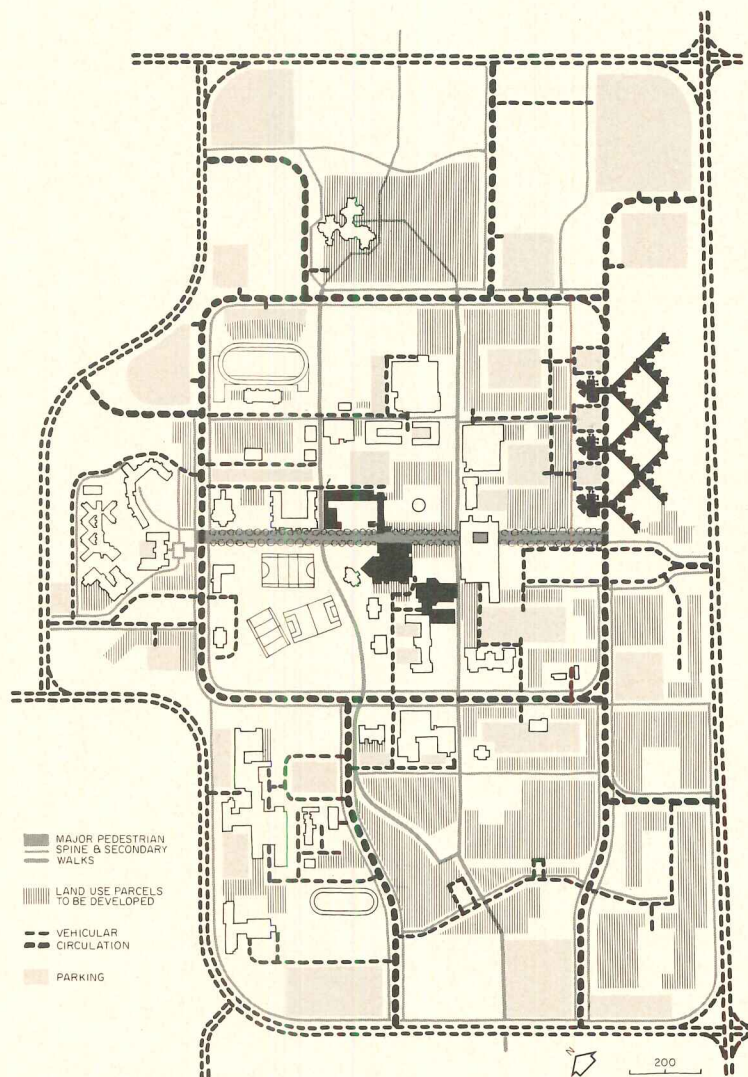

Ken Barton





The Arts Building (this page and opposite) and the Library (overleaf) are the first buildings to be completed in the new academic core of the campus. This reinforced concrete structure combining brick with pre-cast cladding has 59 classrooms, 17 special purpose rooms including studios and lecture halls and 276 faculty offices. As the photo (left) indicates, the Arts Building has been related to the older Tudor-style administration building in such a manner that it forms a well-scaled street. The photos (right and below) show the relationship of the building to the brick-surfaced north-south pedestrian spine. Wherever possible, fine old trees and existing campus green have been emphasized and preserved as can be seen in the photo at bottom left on the opposite page.

The tower shown at right is the office portion of the Arts Building. The two remaining wings of the U-shaped structure combine two- and three-story elements as can be seen in the photo (left). The newly designed buildings embrace a certain range of heights, determined by their uses and related to the scales of the existing campus buildings. In general, the new class and laboratory buildings will have a height of three stories since they are conceived as walk-up, rather than elevator buildings.

The Arts Building incorporates an internal pedestrian way for use in bad weather. For the purpose of unifying the central campus, this internal way will be developed in as many buildings as possible to facilitate circulation in both north-south and east-west directions.

ARTS BUILDING, GUELPH UNIVERSITY, Guelph, Ontario. Architects: *Hancock, Little and Calvert Associates*; design consultants: *Sert, Jackson and Associates Inc.*; landscape architects: *Project Planning Associates, Ltd.*; structural engineers: *M. S. Yolles Associates, Ltd.*; mechanical and electrical engineers: *R. E. Crossey and Associates, Ltd.*; furniture consultants: *Dudas, Kuypers, Adamson, Ltd.*; acoustical engineer: *V. L. Henderson*; soil mechanics: *William Trow Associates, Ltd.*; general contractor: *Pigott Construction Company, Ltd.*

Ken Barton

The first floor level of the Arts Building contains nine large classrooms, meeting rooms and student club rooms. Total cost of the building workshop, several seminar rooms and a drama stage. The tower wing at this level contains reading rooms, meeting rooms and student club rooms. Total cost of the building without furnishings was \$21 per sq ft.

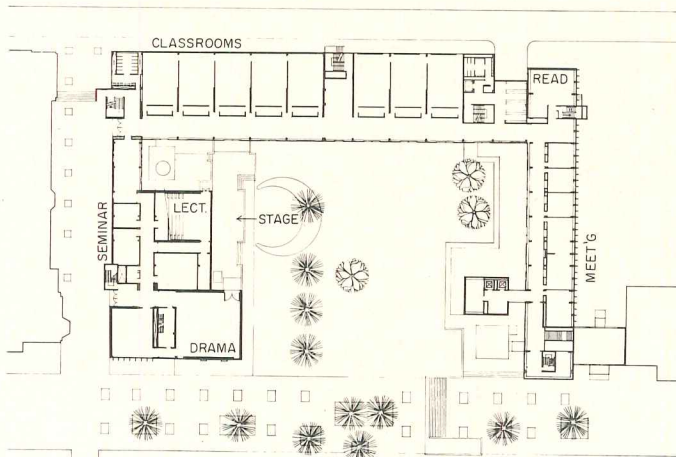

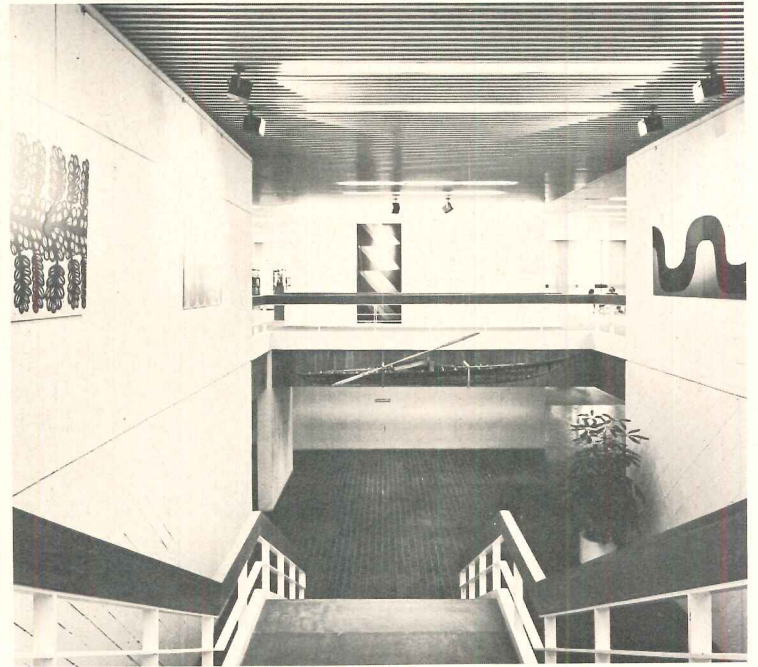
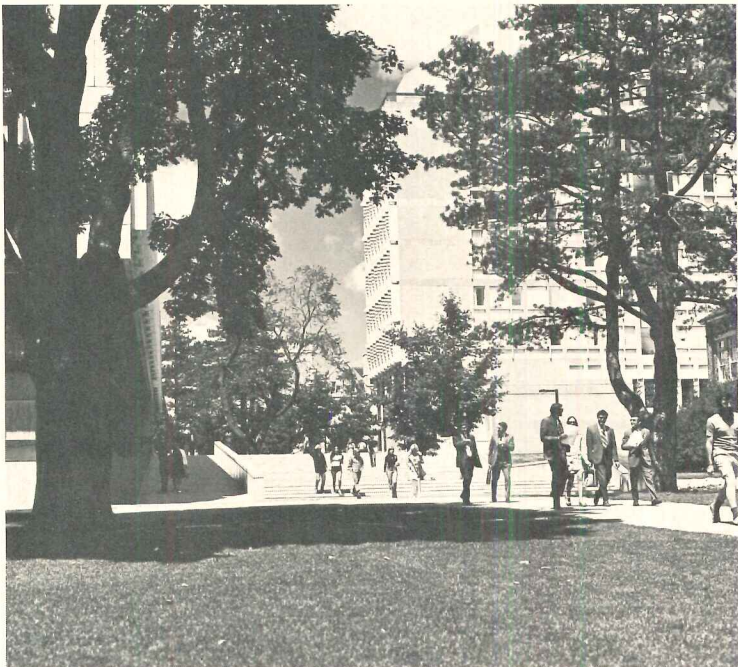
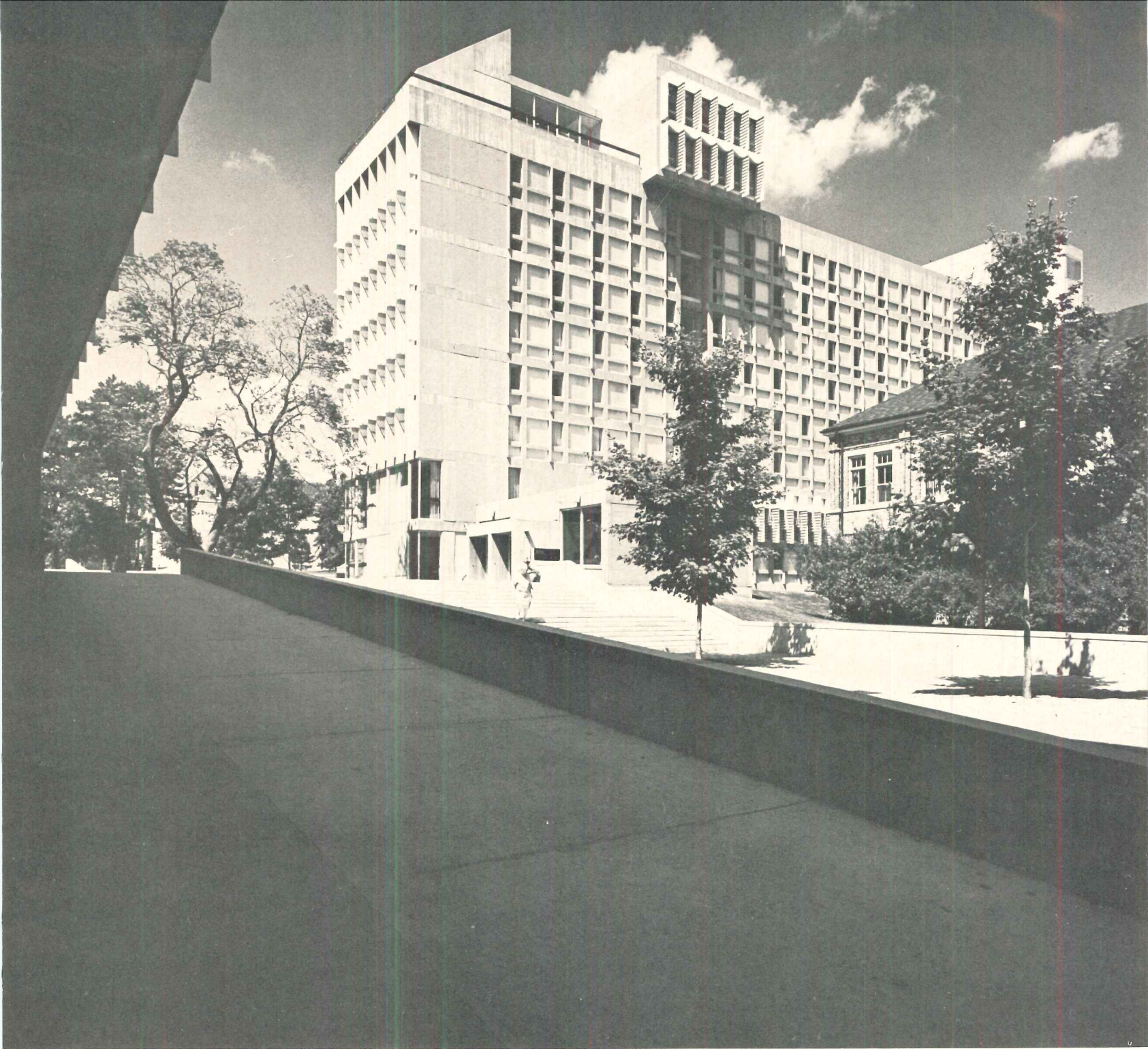

All photos by Michel Proulx except as noted



The McLaughlin Library is shaped by its position in the master plan. The court which it defines in conjunction with the Arts Building is controlled by the diagonal placement of Massey Hall, an older building which has been preserved. The angular projection in the Library plan (below) corresponds to this diagonal (see master plan, page 89).

The Library shares a common language of forms with the Arts Building. Both buildings have a scale and character which expresses the activities accommodated. The vocabulary of materials for both buildings is in a color range which harmonizes with the older stone buildings.

The Library has been constructed of poured-in-place reinforced concrete with precast cladding. It has been designed for 650 thousand volumes and accommodates well over three thousand readers. It is a subject oriented, open access library with reader space provided among the book stacks. Reference and other information facilities are located on each subject floor. Unlike most libraries, it lacks a central service core. Four corner towers contain the essential services.

All library furniture was specially designed for this library (see photos opposite page, bottom). The interior lighting is of interest. The principal lighting fixtures are specially designed light box units at the top of the columns. Except in a few locations, no overhead lighting has been installed. Instead, an underfloor electrical power distribution system provides power for fluorescent lights located on individual book-stacks and carrels.

McLAUGHLIN LIBRARY, GUELPH UNIVERSITY, Guelph, Ontario. Architects: *Hancock, Little, Calvert Associates*—project architect: L. S. Langmead; design consultants: *Sert, Jackson and Associates, Inc.*; landscape architects: *Project Planning Associates, Ltd.*; structural engineers: *M. S. Yolles Associates, Ltd.*; mechanical and electrical engineers: *R. E. Crossey and Associates, Ltd.*; acoustical engineer: *V. L. Henderson*; furnishings: *Al Faux Associates, Ltd.*; general contractor: *Perini (Western)*.

The Library has six floors. The third and fourth floors are similar in plan (right) and provide stack and reading space for the humanities on the second floor and social sciences on the third, as well as temporary space for university administration. The main floor is devoted to technical processes, general reference space, a fine arts wing and a reading area. Physical, natural and applied sciences are on top floors.

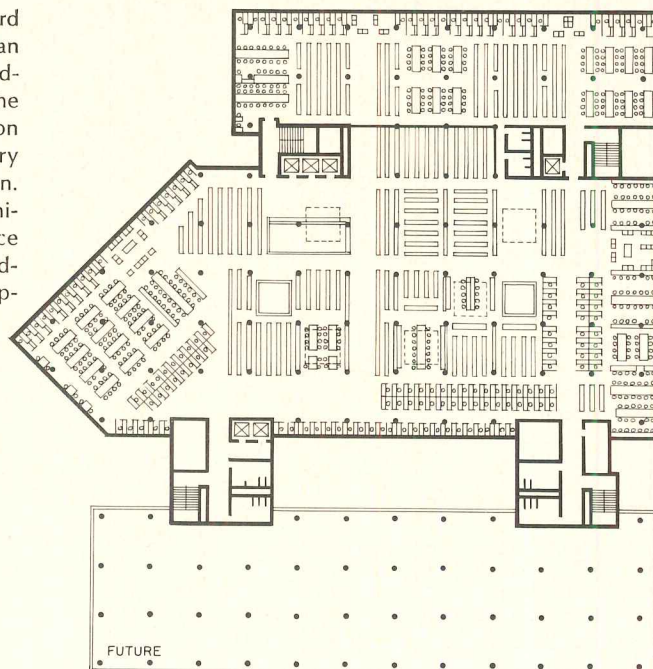

L. F. Webster



L. F. Webster

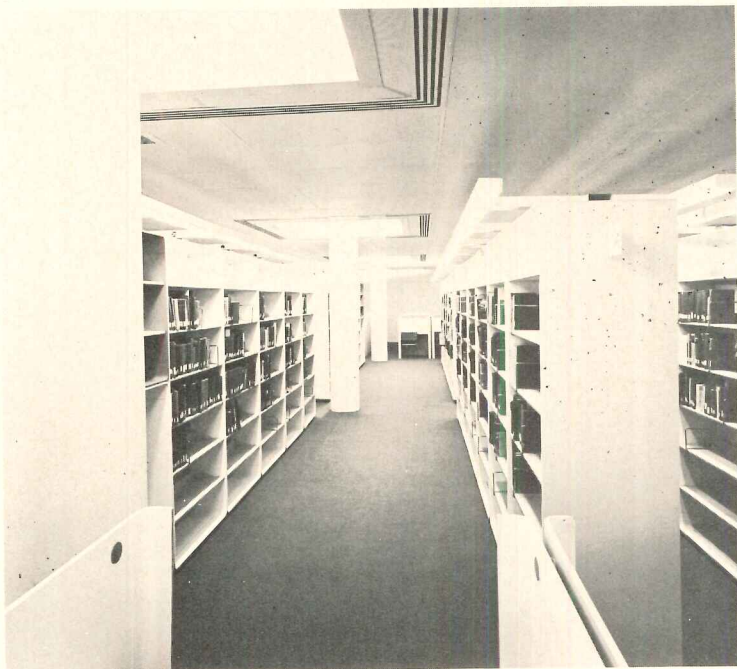

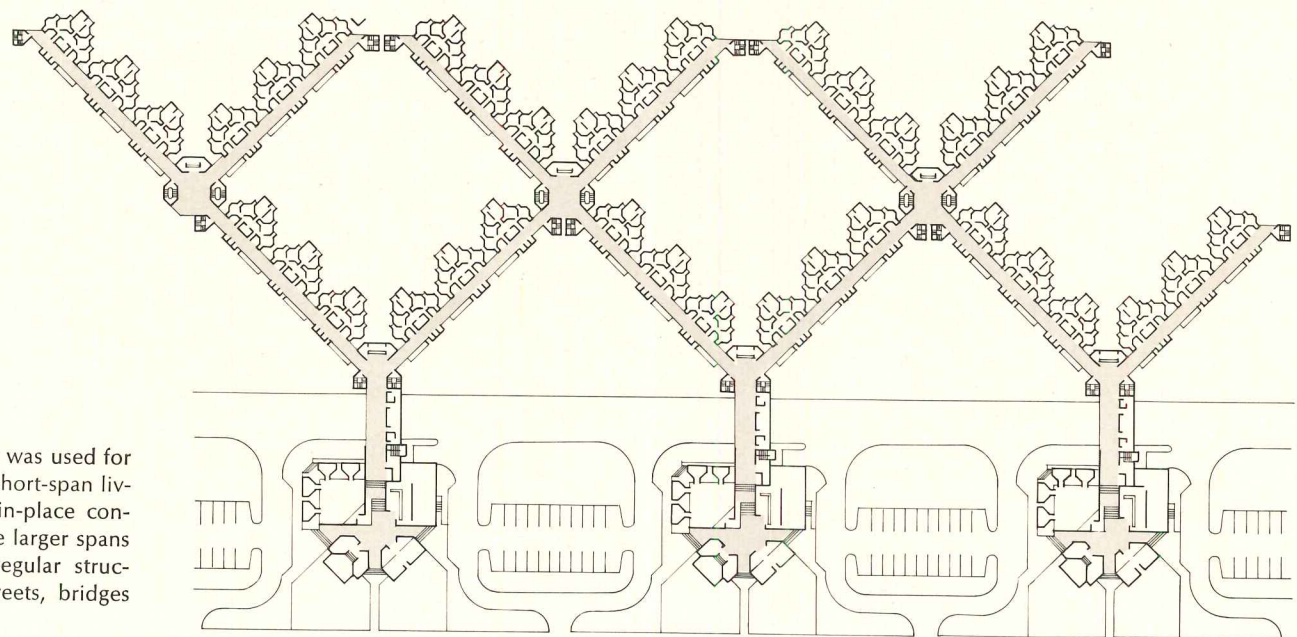

Load bearing masonry was used for the vertically aligned short-span living quarters. Poured-in-place concrete was used for the larger spans and the vertically irregular structures such as the streets, bridges and dining halls.

Housing Complex 'B' is located at the southern end of the north-south pedestrian spine. Another dormitory unit has been constructed at the northern end, and dormitory groups have been planned at the far ends of the east-west pedestrian spine. Instructional facilities and communal buildings are sited within the inner ring road which defines an area which can be traversed in ten minutes walking time. The four dormitory groups at the compass points lie just beyond the inner ring road.

Housing Complex 'B' lies just to the east of the major campus entrance. In plan it is in the form of six V's, forming a uniform grid system. Each residence is entered from a dining hall and common room complex joined to the residence by an enclosed bridge which spans the inner ring road of the campus. The bridges lead to an interior street which joins all the houses at the third floor level. From this street, the students have access by stairs to four bedroom floors above, and two below. As the plan indicates, basic social groups of six and 12 are combined into houses of approximately 46 students, under the supervision of a married faculty member or senior student. Density is 140 persons per acre with over 60 per cent in single rooms.

The great majority of the bedrooms each has its entrance, window and closet at one of the four corners, making four clear walls available for furniture. These rooms interlock in clusters of four. On the opposite side of the corridors are rectangular single and double bedrooms. On the fourth and fifth floors these bedrooms form deep overhangs creating a facade (left) which is different in its expression from the facade created by the clustered units.

HOUSING COMPLEX 'B' GUELPH UNIVERSITY, Guelph, Ontario. Architects: *John Andrews Architects*; structural engineers: *Seethaler & Bernard*; mechanical engineers: *R. E. Crossey & Associates, Ltd.*; electrical engineers: *Jack Chisvin & Associates*; landscape architects: *Project Planning Associates, Ltd.*; contractor: *Ellis-Don Ltd.*

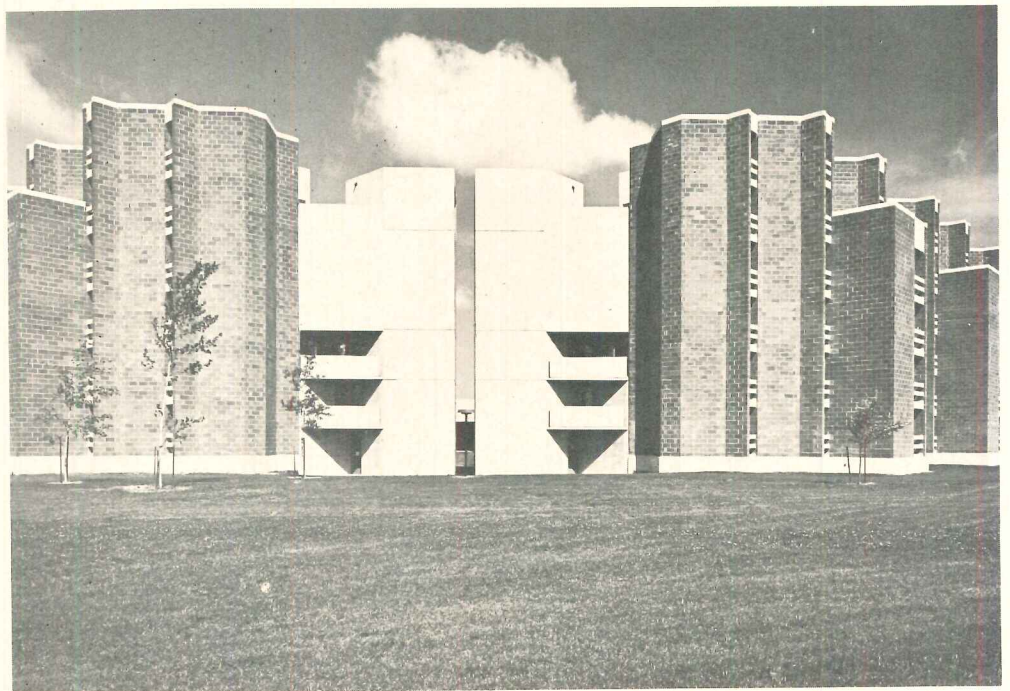

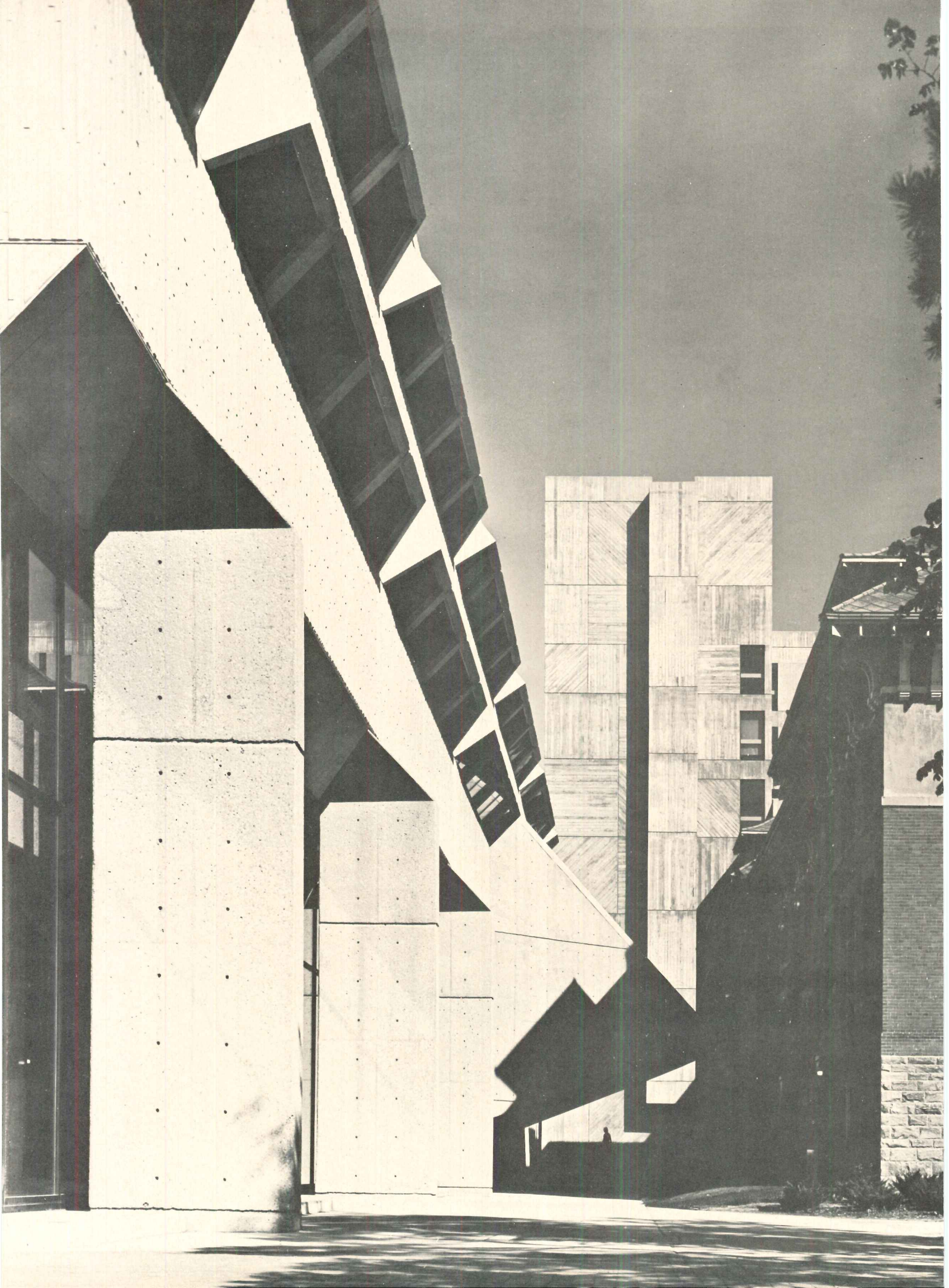

The Physical Sciences Complex is located on the west side of a quadrangle which will be, when completed, the heart of the campus. It is closely related to the Library to the north and to the proposed university center to the east and to the south. A compact structure, it increases the intensity of use and the urban character of the academic core, encouraging communication and contact, reducing walking distance in harsh weather and facilitating optimum scheduling of its own classrooms and laboratories as well as those of nearby buildings. The new complex is directly attached to the older chemistry and microbiology building, forming a continuum which ties the older structure more closely to the academic core. An objective of the master plan is to draw all of the campus buildings into a visual continuum so that they may cease to be a series of isolated facades.

The basic planning concept provides a central corridor on each floor lined by offices and laboratories with the mechanical services stacked in continuous vertical shafts serving each floor. The stepped-back section of the west face (photo at right middle) expresses the interior program requirements and permits light to penetrate to the courtyard below. The triangulated windows minimize the exposure to east and west sunlight but provide good visibility from within.

The facilities provided for in the chemistry wing include laboratories, offices, lecture rooms and ancillary areas, all contained in three levels. The physics wing houses lecture theaters, laboratories, seminar rooms, offices and administration areas on five levels. The university bookstore has been included in the Physical Sciences Complex on the ground floor to generate activity.

PHYSICAL SCIENCES COMPLEX, GUELPH UNIVERSITY, Guelph, Ontario. Architects: *Craig, Zeidler & Strong*—partner-in-charge: *William A. Strong*; structural engineers: *J. Maryon & Partners*; mechanical engineers: *G. Granek & Associates*; electrical engineers: *J. Shisvin & Associates*; precast contractor: *Beer Precast Concrete Ltd.*; general contractor: *Pigott Construction Ltd.*

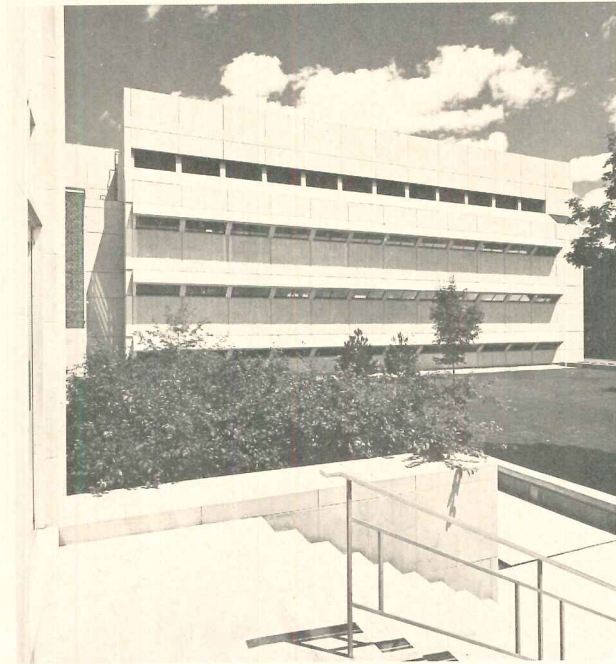
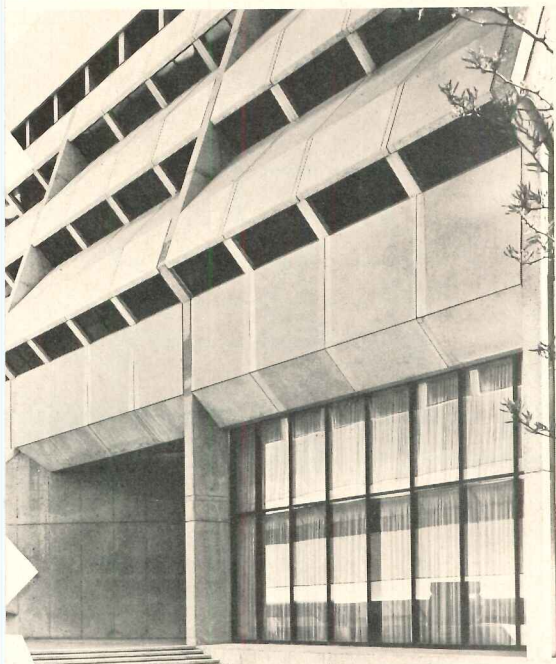
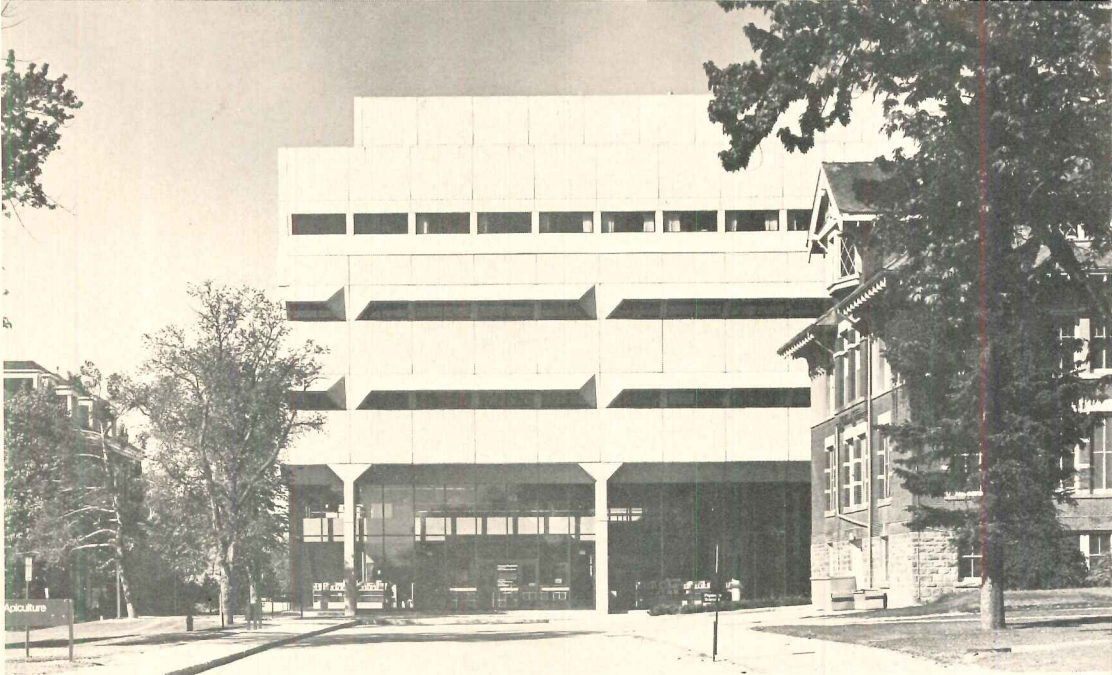

The view (opposite page) is taken toward the Library showing one of its service shafts. The cantilevered projection of a portion of the Physical Sciences Complex facade, which can be seen in this picture, is a lecture hall with a sloped floor. The main entrance of the building is adjacent. The Physical Sciences Building is constructed of poured-in-place concrete columns with a one-way ribbed slab floor. The columns are bush-hammered and the exterior is precast textured concrete, sand-blasted to impart warmth.

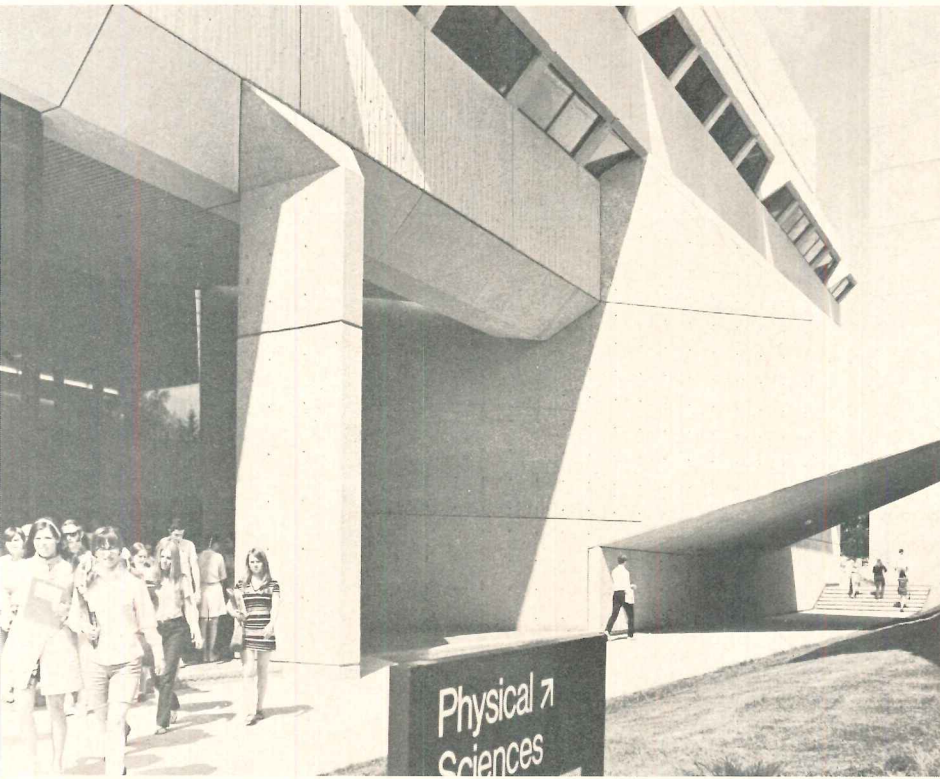

The entrance (left) leads to the two-story lobby (below left). Lecture facilities of the type shown (below right) can, taken together, accommodate a total of 750 students. On the interior the cast-in-place walls are sandblasted. Partitions are of painted concrete block. Ceilings are removable metal slats. Flooring is generally vinyl in corridors, vinyl asbestos in laboratories and quarry tile in the lobby. Carpeting is used in the offices and theaters.

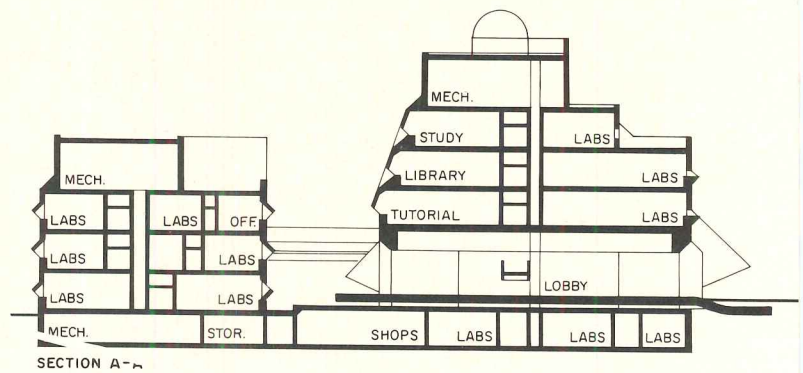
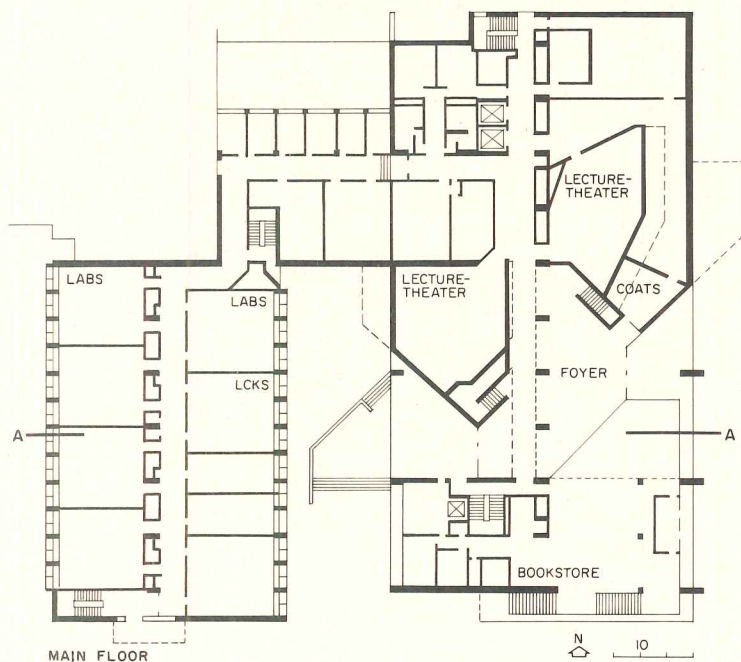
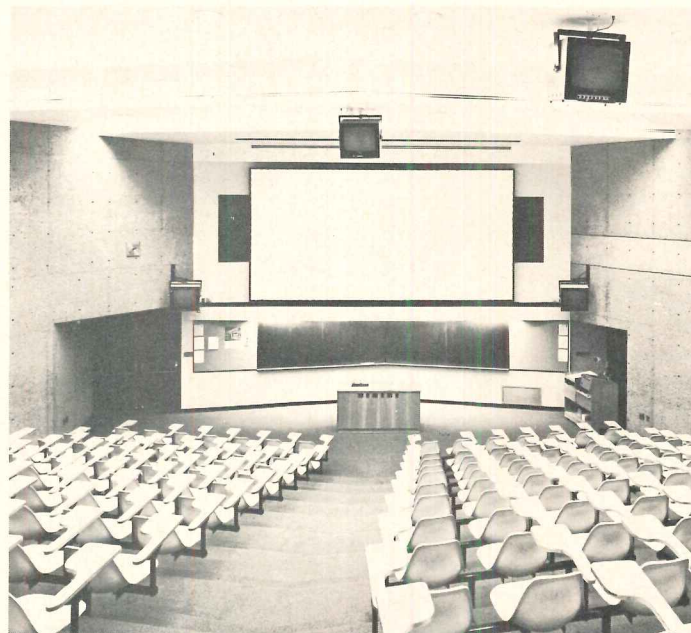

Downtown shopping with suburban amenity

Worcester Center, a handsome new commercial complex in an old Massachusetts town, is proving that "downtown" doesn't have to die. The Center designed by Weldon Becket and Associates, has all the facilities and conveniences of a suburban shopping center plus the strong potential for becoming an important community focus. It provides an unusual and exciting experience in urban shopping.

WORCESTER CENTER

This handsome new complex of buildings in the redevelopment area of Worcester, Massachusetts is more than the shopping center it looks to be, for it is the catalyst that is reversing the trend to the suburbs which has caused the decay and deterioration of the downtown business district of the city. Physically, too, it is more than a shopping center: by location and by design, it is intended to become the focus for community activities of various kinds. Its most extraordinary feat, however, is that it brings to downtown the facilities and amenities of a suburban shopping center. It has both the parking—4300 spaces under cover—and the direct access from an expressway that have made the suburban center successful. But by making the center a fine environment in which to be, the developers—The Berenson Corporation and Beacon Construction Company—have provided the community with a major source of pride and a facility which it can use in many ways. This first phase of the Center includes two office buildings, two major department stores, two five-story parking structures, four retail shop buildings and—centerpiece of the complex—a great two-story glass-roofed street, the Galleria.

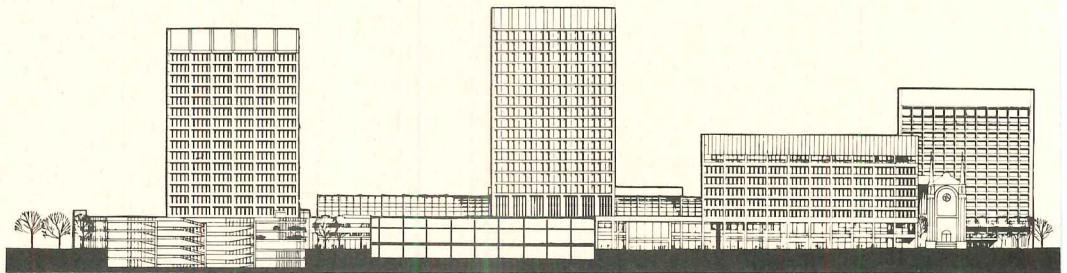
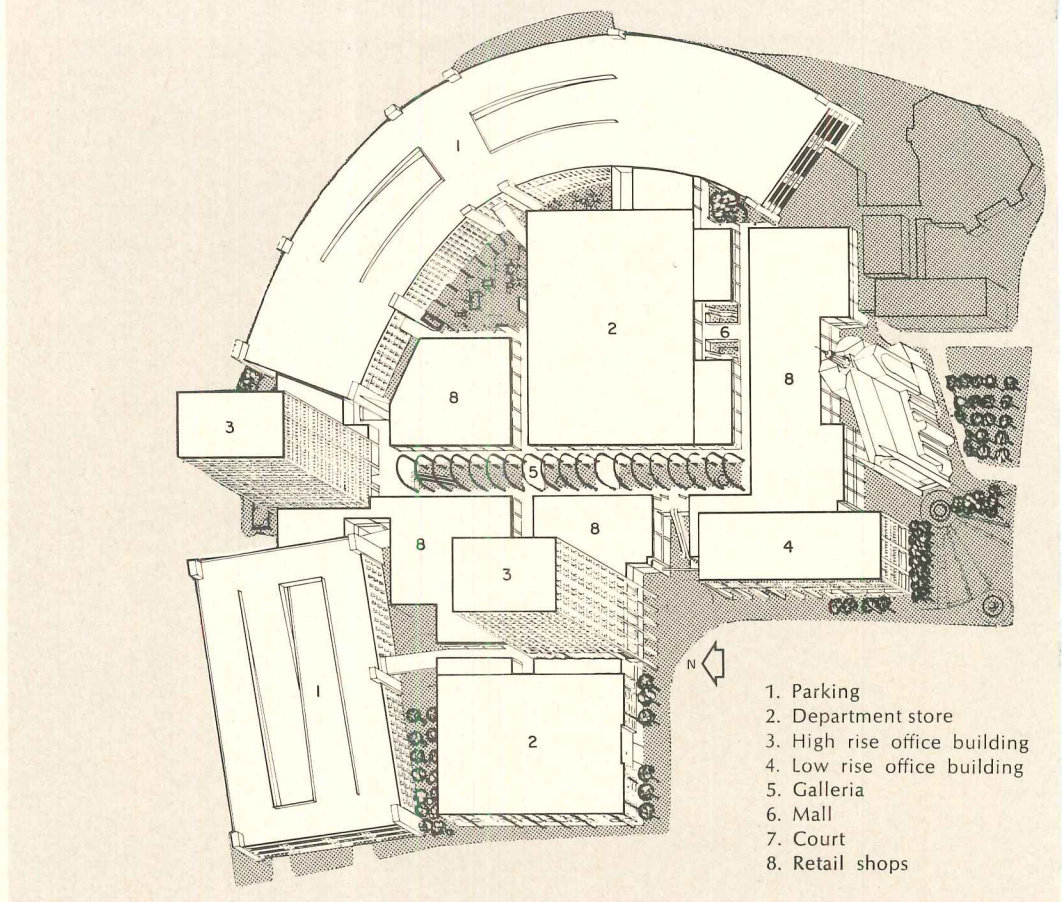



Daniel P. Duffy



Daniel P. Duffy

A new four-lane ring road encircles the Center, linking it with two downtown areas and Expressway I-290. Adjacent to the ring road are two five-story parking structures (right), strong elements in the overall design and important as buffers against traffic noise. The basic scheme was developed from a master plan by Sert, Jackson and Associates commissioned by the Worcester Redevelopment Authority.

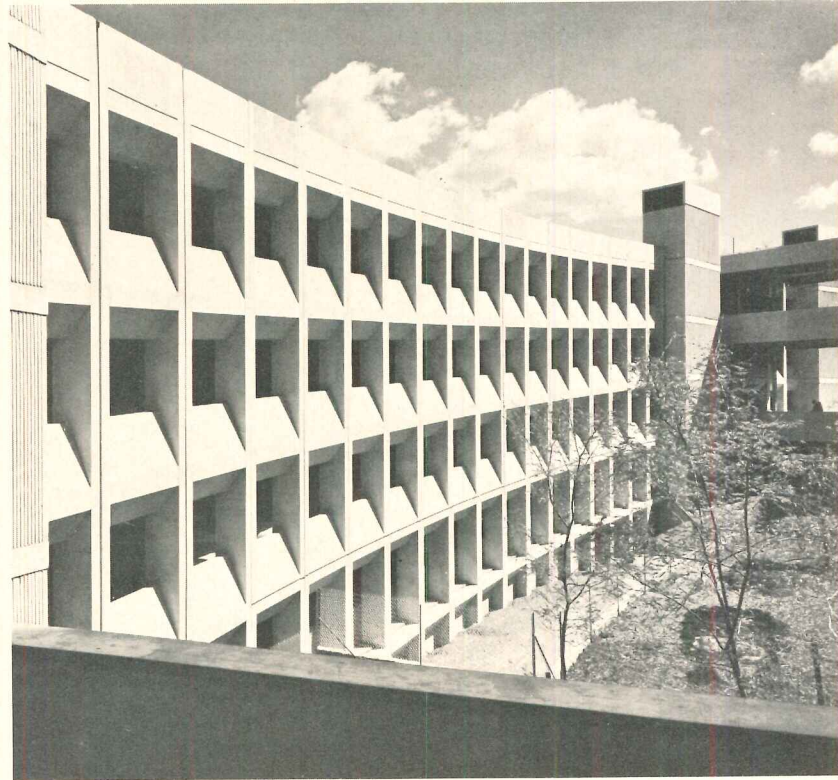
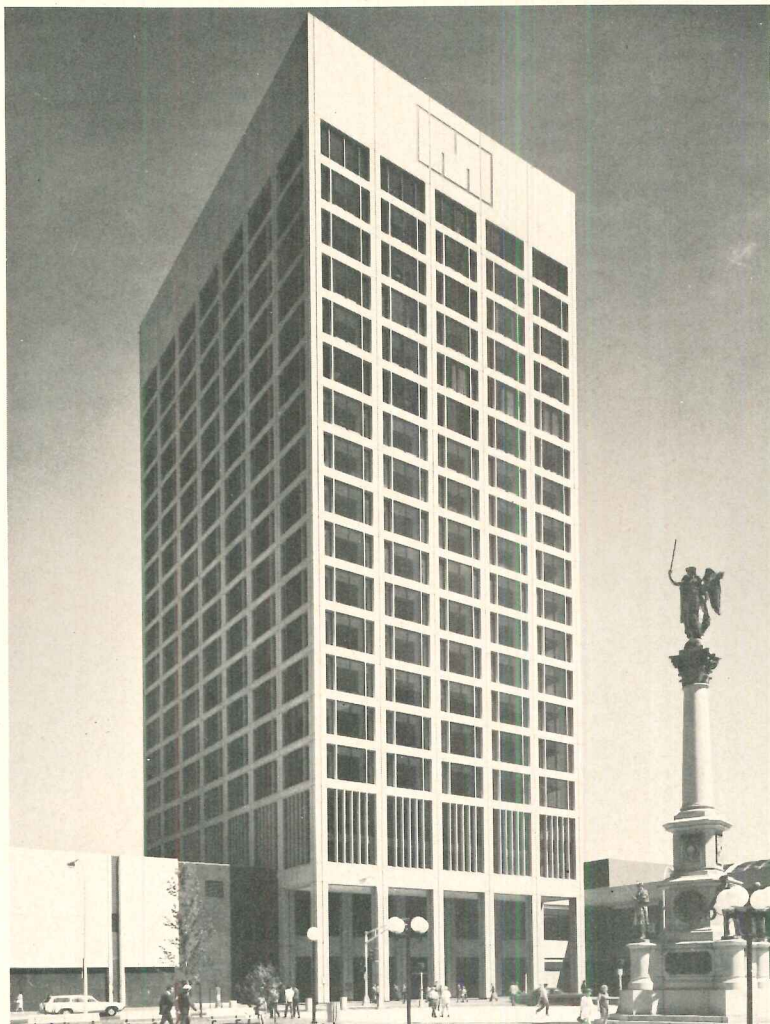
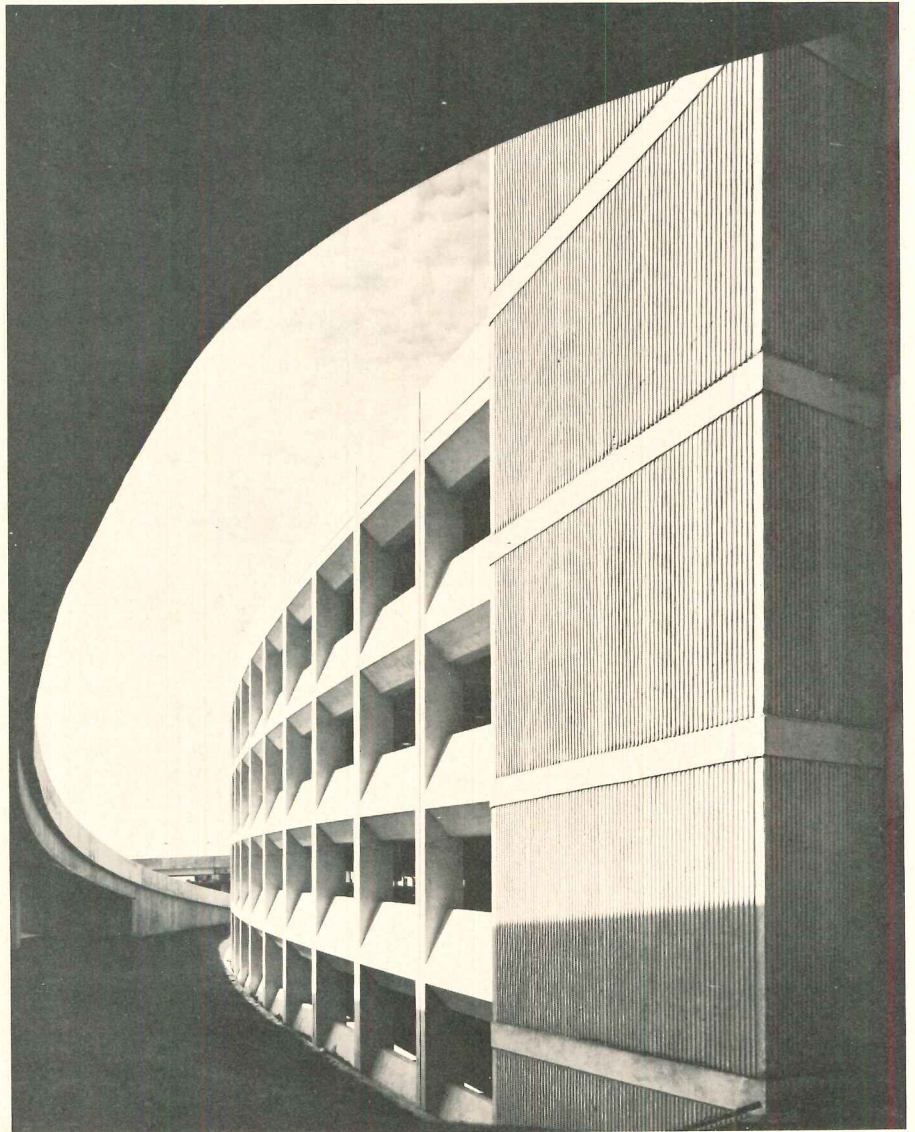

WORCESTER CENTER

The sparkling Galleria with its vaulted skylight of white precast concrete arches, steel ribs and bronze Plexiglas, 60 feet above the floor at its center, is the center's special delight. Along its 475-foot length are some of the \$800,000 worth of art works selected as integral parts of the architectural design by Annie Damaz: six fountains, benches, planters, moving light sculptures, and a mosaic-patterned brick floor by Paul Friedberg; stainless steel sculptures by Paul van Ringelheim, suspended from the center of the vault; nine ball-light fixtures (and the overall lighting which is as effective by night as the day-lighting is by day) by Seymour Evans & Associates; directional and informational pylons by Chermayeff and Geismar; and a sunburst over the escalator at the main entrance by Otto Piene.

WORCESTER CENTER, Worcester, Massachusetts. Architects: Welton Becket and Associates, Fred van Gaasbeek, project architect, Marvin Gosinsky, David Beer, project designers. Engineers: Wayman C. Wing, structural; Cosentini Associates, mechanical/electrical. Landscape architects: M. Paul Friedberg & Associates. Lighting: Seymour Evans & Associates. Art program: Annie Damaz. Graphics: Chermayeff and Geismar Associates. General contractor: Beacon Construction Company.



Gorchev and Gorchev



Gorchev and Gorchev





The Galleria, with its limited palette of colors and materials, its landscaping, fountains, light and art points up the sophisticated character appropriate to a downtown urban location. Lacking street frontage, Jordan Marsh makes entrance from garage (above) interesting.

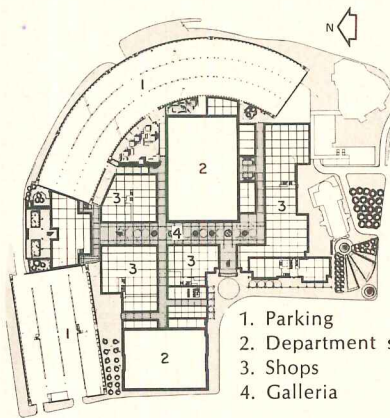

- 1. Parking
- 2. Department store
- 3. Shops
- 4. Galleria

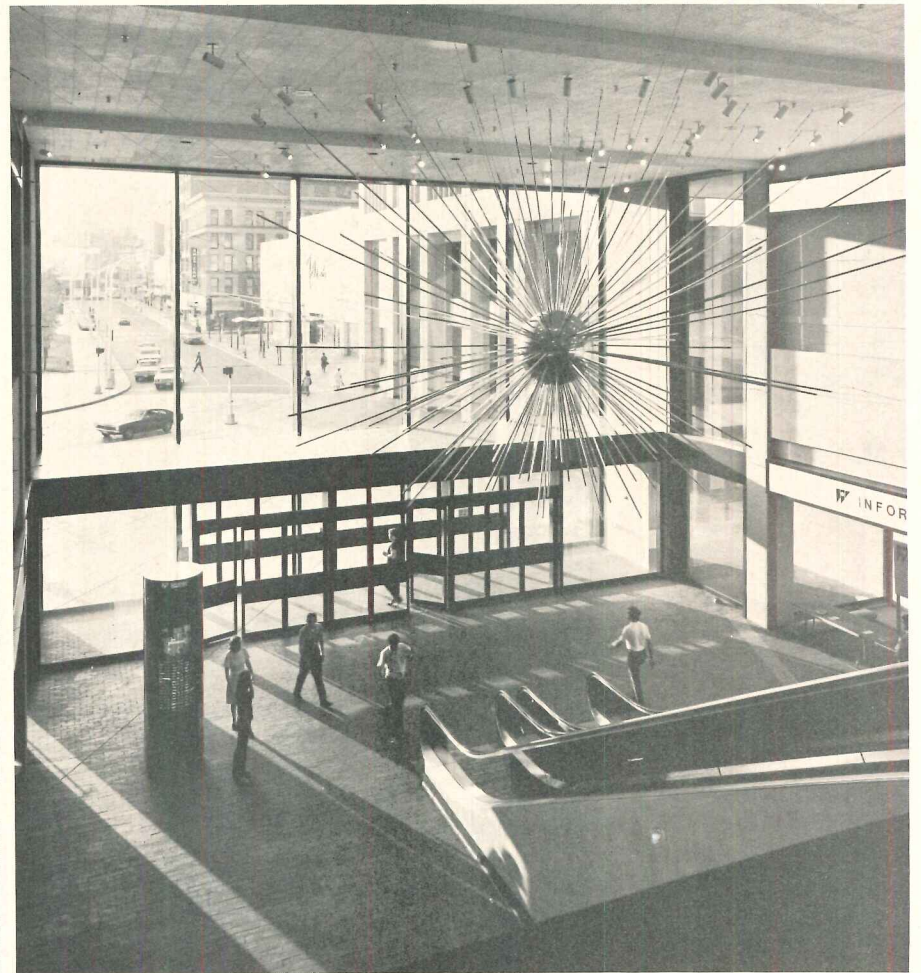



A basic decision of the architects and collaborating artists was to use the circle as a motif for design. Paul Friedberg's mosaic paving (above) of light brick, laid in concentric circles, reflects this as do the information and direction pylons (below) of Chermayeff and Geismar. Light fixtures, planters, fountain bases, also use the motif. As the Center develops further—a third office building is under way, a hotel is in planning—it is expected to expand its role in the community.



David Beer

A report from Australia:

THE ENVIRONMENTAL CRISIS DOWN UNDER

Australia is following the lead of the United States in the rapidity of its urbanization and technological development, and in the extent of its exploitation of natural resources. Although her total population of under 13 million is only slightly larger than that of New York City alone, Australia shares many of its major environmental problems with the United States and other more densely populated advanced nations in the rest of the world. At a conference held in Sydney last May, which was sponsored by the Royal Australian Institute of Architects, leading Australian, United States, British and Japanese professionals discussed the future consequences of today's unplanned growth, and proposed strategies to circumvent its negative effects. Since Australia's problems are essentially global in nature the ideas and solutions presented at the conference should be of interest to architects and planners everywhere.

Text and photographs by Mildred F. Schmertz

Australia's problems are those of the planet

Australia is a sparsely populated island of three million square miles with fewer than thirteen million inhabitants, 88 per cent of whom are urban dwellers—a higher percentage than in any country in the world. Australia's major cities—Sydney, Melbourne, Brisbane, Canberra, Hobart, Adelaide, Perth and Darwin—have an aggregate population which exceeds that of New York City alone by only a few million. It is a white man's country, Western in its institutions, with few racial or cultural disharmonies. The Australian government carefully monitors the ethnic composition of its immigration. Its native aborigines represent only one per cent of the population and although they are unspeakably treated and becoming restless, they are not yet organized to effectively confront white Australia and may never be.

Australia is experiencing rapid economic development and intense foreign investment in its rich mineral deposits, on the part of the U.S., Great Britain and Japan. Foreign economic ownership and control has brought post-war prosperity and a high level of employment. Unemployment has for years ranged between one and 1.5 per cent as compared to the current U.S. rate of 6.1 per cent and Canada's 6.6 per cent. Inflation has become noticeable only in the 1970's, the cost of living increasing by seven per cent in 1971.

Such bare statistics suggest that, except for the current inflation, Australia is a good place to live and work and is getting better all the time. Why then did the Royal Australian Institute of Architects on the occasion of its Centenary Convention last May, decide to hold an international conference ominously entitled "The Consequences Of Today"? Because many of Australia's leading architects recognize that the quality of life for the Australian population as a whole has not increased to a degree commensurate with economic growth, and that on the contrary, it has declined disastrously in ways which parallel the environmental deterioration of more highly industrialized countries. In planning the centenary conference the architects hoped that solutions proposed for Australia's new problems would be found applicable to countries in all stages of development.

Poverty

Four per cent of urban Australians struggle to survive below a severe standard of need, and eight per cent exist below a slightly higher income floor. At least an additional eight per cent can be classified as poor and thus 16 per cent of the white Australian population form an impoverished class.

As in the U.S., technologically or economically displaced rural workers are migrating to the cities. Rural Australia is in an unprecedented crisis. Great Britain on entering the European Common Market ceases to be a market for farm exports and

China has stopped buying wheat. Because of a decline in the wool market due to the development of synthetic fibers, the average wool-grower owes more money than his land is worth. Australia is totally unprepared for rural depopulation. No facilities exist for training the dispossessed farmer in the skills he will need to join the industrial work force. Abandoned rural housing stock is not being replaced in the cities, thus exacerbating the existing housing shortage.

The housing sprawl

It has been claimed that in Australia more people own their own single-family detached houses than in any other country in the world. Only a very small percentage live in flats. This is not as comfortable as it sounds. Well-to-do Australians lead unostentatious lives by U.S. or European standards in comparatively modest and pleasant suburban villas. But the lower middle class and blue collar workers live in economically segregated housing often at great distances from the husband's place of work. On the outskirts of Sydney new housing developments are being built without roads, shops, schools, clinics, day care centers, facilities for community life or any other amenities. The houses are occupied by one-car families. Mass transportation is inadequate. The husband takes the car to work leaving his wife and children stranded all day long in loneliness and mud.

Australians suffer from soaring land and construction costs, and inadequate roads and sewers. Only in Canberra, Australia's famous Commonwealth capital planned by the American architect Walter Burley Griffin, are new houses linked to an existing network of paths, roads, sewers, parks, schools, clinics and community centers.

Pollution of air, water and land

On some days the air in traffic-jammed downtown Sydney contains 40 parts per million of carbon monoxide—more than usually occurs in any city of the U.S.—even Los Angeles. Australia's limited water resources are being polluted by industrial and urban waste. Mining of her vast mineral riches has gotten out of hand.

The eastern coast of Australia possesses two regions of great ecological and scenic wealth which are also priceless recreational lands for coastal city dwellers. Both are threatened with total ruin by foreign-owned mining interests. The Blue Mountains, which can be reached by train from Sydney in a little more than an hour, are part of Australia's national park system. So far, however, only enraged citizen protest has prevented their being mined by U.S. companies for low-grade coal to be sold to Japan.

Two thousand miles of the east Australian coast with its surfing beaches and sand dunes are being mined for rutile (a source of titanium) causing the ruin of exotic plants, the extinction of wild life, the erosion of

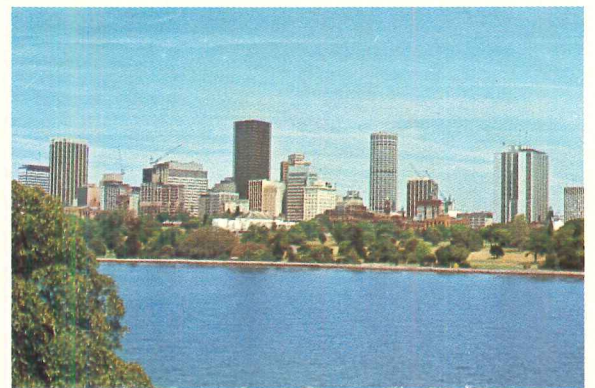
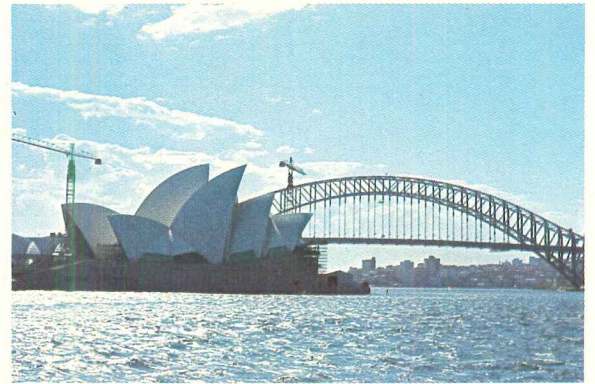

Sydney has a magnificent harbor, ideal for boating. Australians still consider it clean enough to swim in, behind shark nets. From across the water looking beyond Argyle Place toward North Sydney, it is a splendid sight as are the Sydney Opera House (now scheduled for completion in 1974) and the Harbor Bridge as seen from the deck of a ferry (middle). Even the downtown skyline with its ill-assorted collection of post-war office buildings becomes scenic when mitigated by water and distance (right).

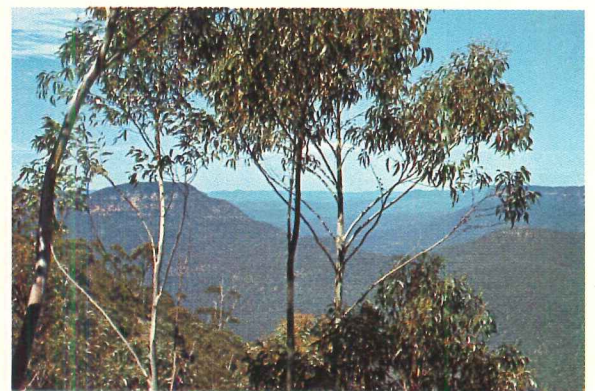

Unspoiled country like the Blue Mountains is not far away. They can be reached by train in a little over an hour. Weekend cottages are within walking distance of the small mountain stations along the way. These little vacation towns that have grown up along the railway are a 19th century legacy, still intact, which make it possible to own or rent a mountain cottage without also owning or using a car. These mountains are endangered by mining interests (see text) and will be protected only through citizen vigilance. The old church is only one of many beautiful or curious buildings to be found in the countryside a few hours drive from Sydney.



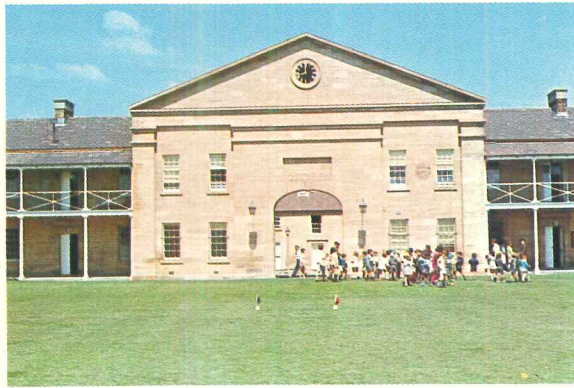
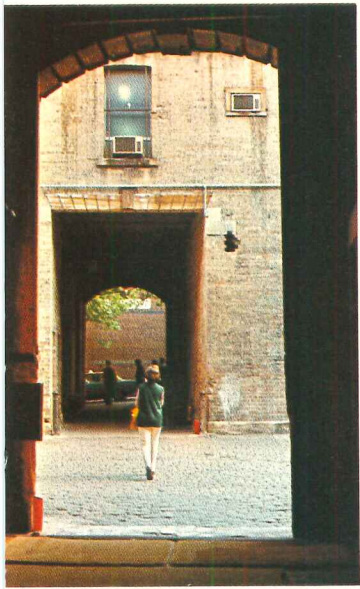

The city is beginning to respect its architectural heritage. Shown above is a portion of a 19th century area known as the Rocks which includes warehouses which have been remodeled into shops. The Victoria Barracks, a handsome late colonial structure (top middle) is open to the public. The house (top right) built in 1840 has been privately restored. Paddington (right) is a hillside neighborhood close to downtown Sydney which consists almost entirely of Victorian terrace houses. Once a slum, the area has been gradually restored, first by artists and intellectuals who scorned suburban life and wished to remain in town, and later by prosperous business and professional people. It has now become quite fashionable.



For many Australians, Sydney is still a good place to live...

Upper income town dwellers are well housed. The terraced apartments (right) overlook the harbor at Darling Point. Designed by the architectural firm of Ancher, Mortlock, Murray & Woolley they adapt to the hillside exceedingly well. Unfortunately most of the new high-income multi-story housing constructed on Sydney's harborside cliffs resembles the buildings across the bay (far right). Wrong for the site, they still provide a comfortable life style.

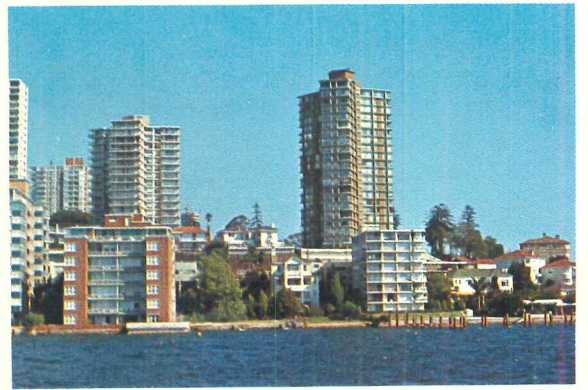

shoreline and loss of the beaches. Since Australia is composed largely of vast areas of arid "outback" hardly fit for human habitation, Australia's conservationists consider it shocking that their government collaborates with foreign investors in the mindless destruction of the eastern coast. Unfortunately for Australia's future, the balanced climate, varied topography and the richness of animal and plant life make this fragile and lovely mountain chain, coastal plain and shore one of the few regions of Australia which are truly hospitable to man. If it goes, there will be little left.

Inadequate government mechanisms

Australia's federal Commonwealth government does less for its cities than the federal governments of the U.S., Canada or West Germany, for example, although its proportionate share of revenue is very much greater than in the latter countries. The cities themselves have not developed systems of local government which are structured to handle urban problems. Of the major Australian cities, only Brisbane has what the U.S. would consider a consolidated structure of city government.

In Australia the city governments are subordinate to the states. Unlike American cities they are excluded from the management of their police force, housing, education and other functions usually handled at the local level. Except for local property taxes the states retain and have authority over all sources of revenue including monies obtained from the federal government.

All income taxes are collected at the federal level and the states are dependent upon Canberra for tax redistributions. The state governments, like those in the U.S. favor their rural constituents. Gasoline taxes flow back to the states for rural road construction. Many federal-state cost sharing projects are high-visibility endeavors conceived for prestige purposes and votes. So far, there has been no significant federal or state funding for urban planning and development or environmental regulation. The cities lack both the authority and money necessary for the development and implementation of plans. A new master plan, however, has been prepared for Canberra, and the Council of the City of Sydney has made public its Strategic Plan, prepared by a team which included McConnel, Smith and Johnson Architects.

Public apathy

Australian architects and planners ask themselves privately if the Australian public will get behind the efforts being made by Australian intellectuals to set urban and environmental priorities. Many observers have noted that the typical Australian is quick to give serious matters a mental brush-off: "She'll be right mate" he says and continues to vote his pocket book. Over fifty years ago D. H. Lawrence wrote in *Kangaroo* of "the profound Australian indifference which is

not really apathy. . . . The bulk of Australians don't care about Australia . . . because they care about nothing at all, neither in earth below or heaven above. . . . And they live in slovenly defiance of care of any sort, human or inhuman, good or bad. . . . It seems to me they think it manly, the only manliness, not to care, not to think, not to attend to life at all, but just to tramp blankly from moment to moment and over the edge of death without caring a straw—the final manliness."

Today Donald Horne in *The Lucky Country* sees no improvement in his countrymen: "Themselves calculating, materialistic and optimistic, Australians find it hard to accept that quixotry, pessimism, spirituality, desire for defeat, boredom, love of rhetoric or risk, of wielding power for its own sake—all ratbaggery these—may often impel action."

If these critics are right, the Australian mass public cannot in its present condition be expected to ponder, as citizens, so delicate and subtle an issue as the quality of life. But the speakers at the RAI A conference warned that they must.

Pragmatists and Cassandras

The RAI A conference speakers included architects and planners from the U.S.: Serge Chermayeff, Ian L. McHarg and the economist James H. Weaver; architect Fumihiko Maki from Japan; and architect and planner Sir Robert Matthew and sociologist Raymond Pahl from Great Britain. The other speakers were Australian and included two leading sociologists Fred Emery and Raymond G. Brown; the biologists Stephen V. Boyden and Sir Macfarlane Burnet; business leaders Gordon P. Barton, F. S. Buckley and Michael Baume; the historian Hugh Stretton and politicians E. G. Whitlam, Member of Parliament and Leader of the Opposition and the Honorable Ian Sinclair, Minister for Primary Industry.

Of those few speakers who commented upon problems specifically Australian, perhaps the most interesting proposals were offered by political opposition leader Whitlam: "It is my conviction that the great national issue for 1972 can and should be made the urban issue. The powers and policies required for effective urban development should for the first time take the center of the national stage. I invite you to participate in this great undertaking. . . . [further] the Commonwealth Government could take such an approach by establishing a Department Of Urban Affairs . . . [which] will encourage the states to strengthen their planning authorities . . . [Such a department's power to appraise applications for urban grants] will provide an incentive for planning authorities to coordinate their designs before making an approach."

Of the many speakers who chose to deal with environmental degradation at the scale of the universe, the economist James

H. Weaver, and the biologist Sir Macfarlane Burnet demanded the most drastic counter measures. Burnet urged that all over the world every possible incentive be used to reduce family size to no more than two children; to reduce production of all goods which are in excess of the primary human requirements; to eliminate all advertising in favor of simple information as to where consumers can find what they need; to ban all imports except knowledge and such raw materials as are not locally available, to export only what is required to balance the imports and, most revolutionary of all, to close down all marginal and pastoral land for conversion to national parks. Burnet is aware, of course, that the establishment of such a list runs counter to established human attitudes. As he pointed out: "to change the universal objective of every country from expansion of population, of national production, of armed forces, of import and export trade, and from a rising standard of living, to almost the opposite in every instance may be completely impossible . . . [nevertheless] science and technology, and the use of high level intelligence to manipulate our legal conventions have produced the vast organizations that are destroying the non-recurring resources of the earth and producing from them weapons, poisons, explosives, unnecessary vehicles and every other frightening manifestation of what human nature is and how it can be manipulated for someone's gain."

Economist Weaver began by expressing his amazement that architects who depend for their livelihood on an expanding economy and a high rate of technological development should be taking a look at its negative results. He then called for less technology, the elimination of automobiles from our central cities, the taxation of polluters thus raising the cost of pollution-creating goods and reducing the number produced and sold, comprehensive national land use planning, decentralization of government and industry, distribution of income on a basis other than jobs, and a restructured and reduced work week. He proposed that we construct pollution-free cities "for those who might prefer to do without air, water and noise pollution and are willing to do without cars, airplanes, motorcycles, gasoline powered lawn mowers, etc." He even suggested that we admit people to our parks and other beautiful natural areas by lottery allocating non-transferable tickets for people to visit Yosemite, Hawaii, Tahiti and the Riviera.

Finally, Weaver told his audience that we must share the earth's output fairly "since it is obviously impossible (from an ecological point of view) for today's poor countries to industrialize and pollute the environment like Americans, Europeans and Australians. If everyone in the world behaved like we do life on the planet would come to an end."



C & I BANK: A WEDGE FOR MEMPHIS

When a traditionally conservative bank decided to revitalize its corporate image, architects Gassner-Nathan-Browne were retained to design a new and decidedly non-square headquarters. Now, the bank's customers can linger, between deposits, in a lush, urban garden sheltered by a tilted and colorful space frame.

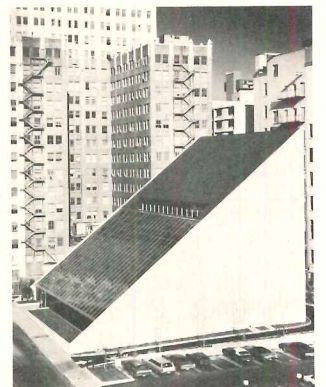

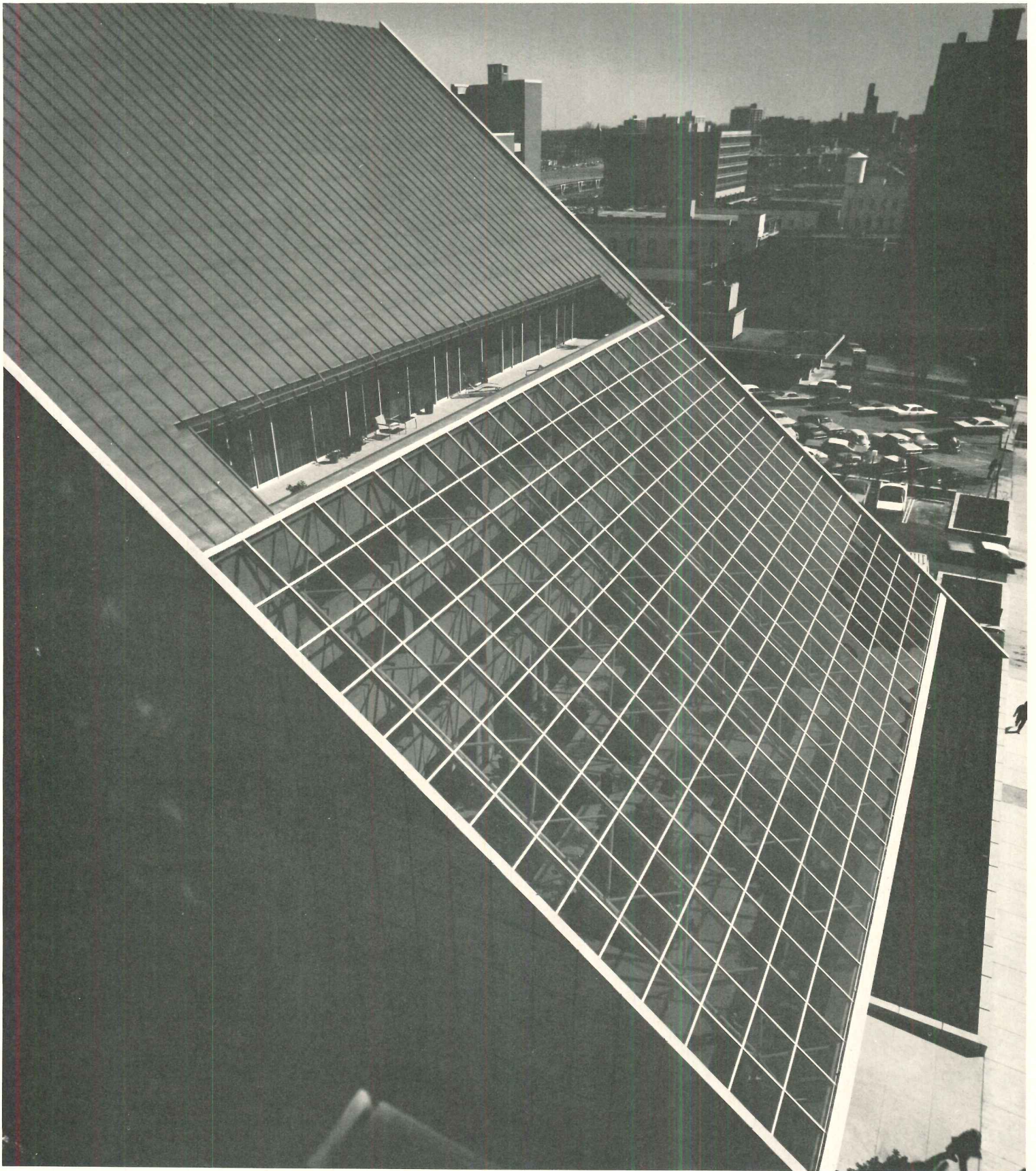

The new C&I Bank in downtown Memphis combines an owner's wish for greater visibility with an architect's desire to develop a highly individualized building form. The result is a striking, 44,000 square foot, triangular structure brightened by a large, richly planted entrance plaza on its south side. The plaza is covered in gray-

tinted solar glass supported by a system of sloping, steel pipe trusses. The volume enclosed is strongly sculptured, generously tufted with greenery and patterned with a shifting filagree of shadows cast by the overhead truss system. To keep the greenhouse atmosphere from becoming objectionable, the designers have installed a pe-

rimeter air supply system at floor level and a dew point exhaust fan that prevents excessive condensation on the sloping glass wall.

The main banking floor is adjacent to the garden. The tellers' area is located so that it can also serve drive-in customers at the rear. Floors are carpeted for comfort and acous-

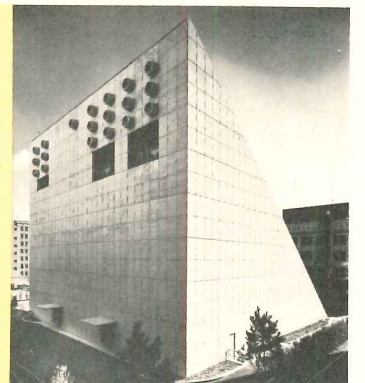

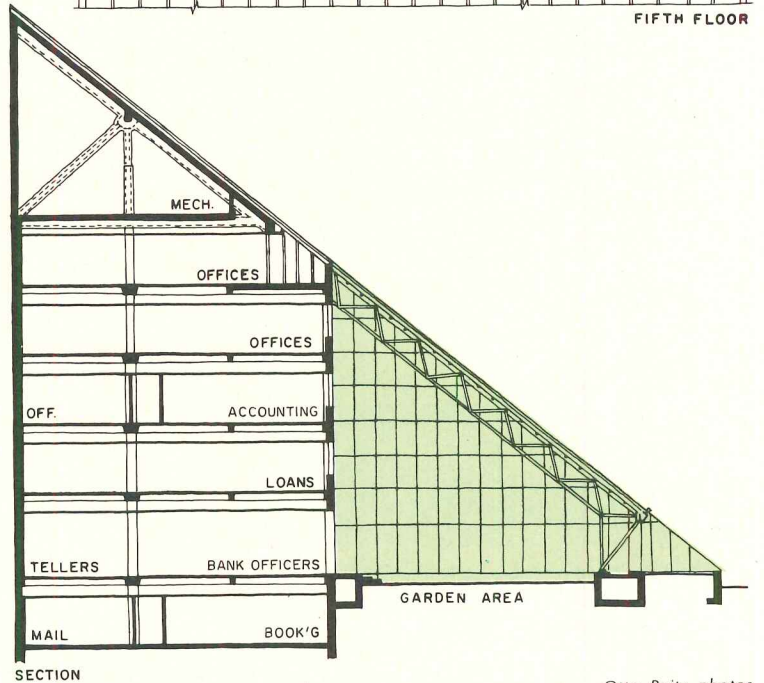
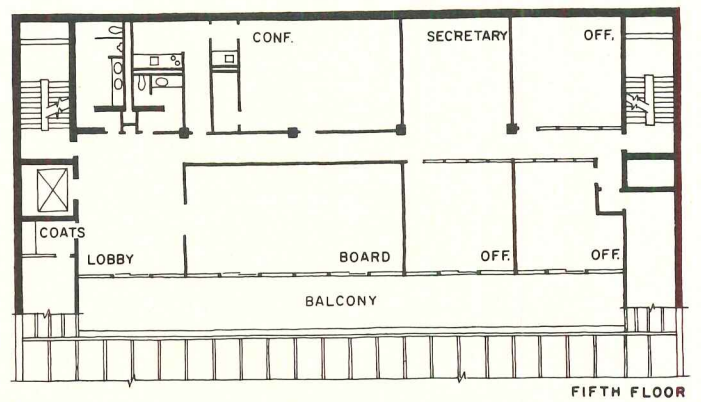
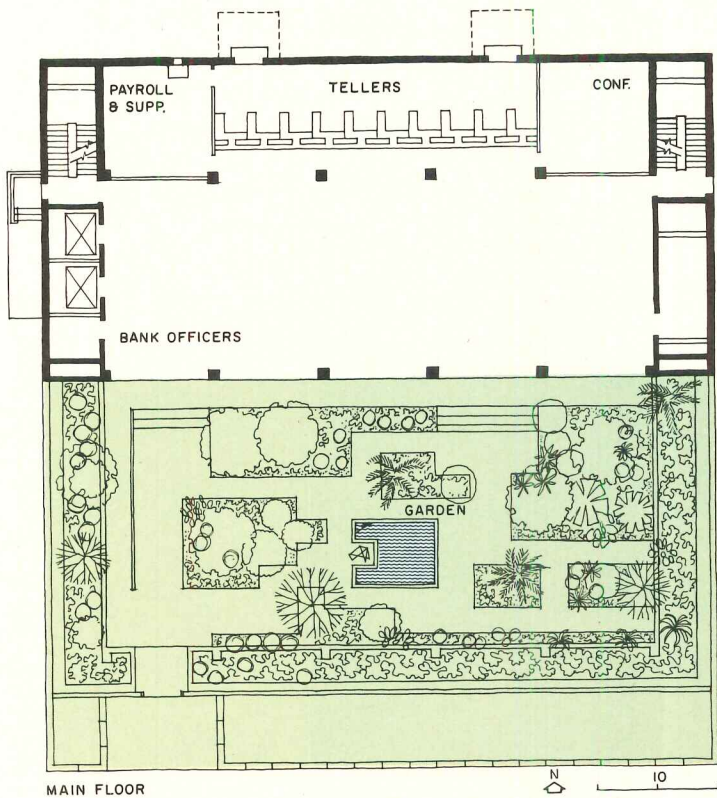

The detail at right reveals that special metal adapters, welded to the mullions, lift the glazing line several inches over the structure of tube sections. Plans above show a regularized structural bay 18 feet wide and 32 feet deep.

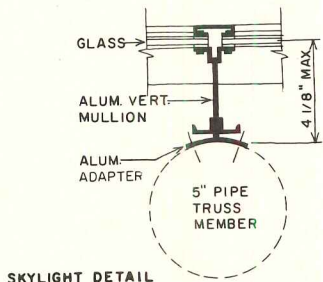

Otto Baitz photos

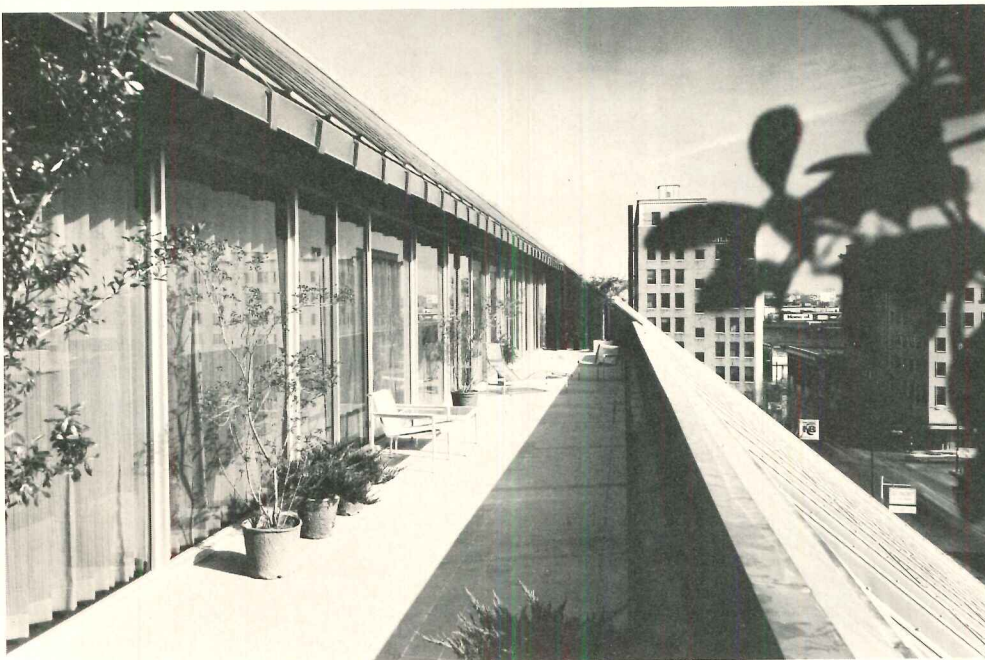

tic control and furniture is arranged in logical, but flexible groupings.

Above the banking floor (see section) are three levels of ancillary space that overlook the enclosed garden. The fifth floor is executive office space and provided with a long balcony facing south. The uppermost level, forming the apex of

the triangle, is mechanical space that vents to the north.

All exterior walls are poured-in-place architectural concrete, sandblasted and sealed with silicone. Above the fifth floor, the building has a metal, standing seam roof.

The building's strong but simple form, the assurance of its detailing and the amenities

it offers, make it a welcome addition to the city's inventory of new commercial space.

COMMERCIAL and INDUSTRIAL BANK, Memphis, Tennessee. Architects: Gassner-Nathan-Browne. Structural engineers: William J. LeMessurier, Associates; mechanical engineers: Office of Griffith C. Burr, Inc.; landscape architects: Robert C. Green & Associates; contractor: J. A. Lucchesi Construction Company, Inc.





The bank's interiors display a high level of comfort and craftsmanship. Colors are vivid red for chairs, white plastic laminate for desk tops and counters, muted blue-gray for carpeting. Natural daylight extends well into the main floor banking space. Recessed fixtures wash the walls behind the tellers.

Industrial buildings: toward higher standards for design

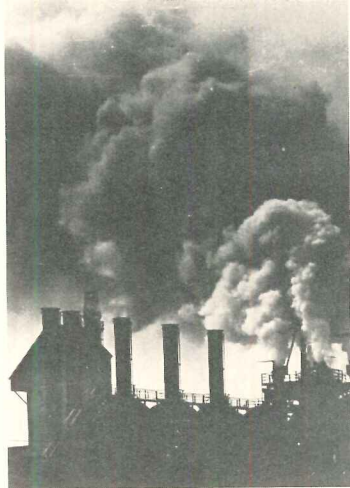
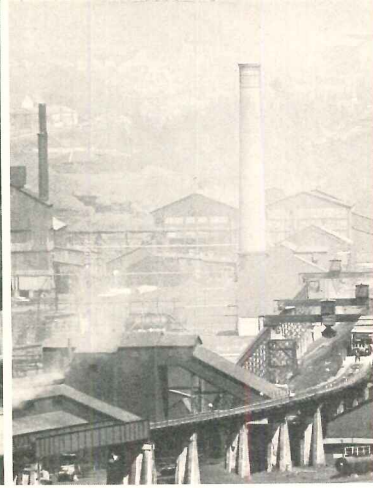

photo courtesy of EPA



Paul Conklin photos



Drive along any road toward a major airport and, chances are, plants and light manufacturing buildings will line the road left and right. Leave any city by train and, as you lurch through the city's margins, staggered rows of warehouses and factories will crowd your vision. Sail down any inland waterway and count the pulp mills, the petrochemical plants, the tank farms and the gravel quarries. Nearby, often on these same waterways, are sewage treatment facilities and municipal incinerators—the Rosencrantz and Guildensterns of industrial buildings playing out their thankless roles mostly in sullen anonymity.

But despite their variety and profusion, particularly along avenues of transport, and despite the fact that many millions of workers spend half their waking hours there, too many industrial buildings reflect little more than an owner's desire to keep rain off his machinery. Crude in massing, clumsy in detail, noisy, sometimes dangerous, fretted with large signs and bad graphics, these buildings provide us with a familiar brass knuckle esthetic—an esthetic we have accepted, until recently, with tolerance; an esthetic we can easily associate with time clocks, lunch pails and three-fingered jointer operators.

Whether this easy acceptance will continue now seems uncertain. There are many hopeful signs that as environmental concerns mount, as social values receive increasing emphasis, as a new work ethic begins to emerge, swelling numbers of us will look more closely at the places we work. Architects, as designers of these work spaces, will be among those looking and listening most critically.

Toward safer employment

Thousands of complaints, ranging from fumes, dust, dirt and noise to unsafe chemicals and radiation poisoning are received by the U.S. Department of Labor each year. Under pressure from the mounting number of such complaints, Congress passed the Occupational Safety and Health Act of 1970 (Public Law 91-596). Under this law, which covers 57 million workers, certain occupational hazards are being identified and removed. Many spokesmen for industry, however, argue that the law's provisions are too expensive to implement. Some of their arguments are persuasive. In any event, much systematic research on worker safety remains to be done and funds for such research have not been bountiful.

Toward more agreeable workplaces

The buildings in this study are offered as evidence that good design can emerge in ordinary industrial materials and throughout the broad range of industrial types. The structure for The Republic (page 114), Parker Hannifin (page 118) and P. J. Carroll (page 122) are corporate headquarters as well as manufacturing facilities. This flagship feature doubtless influenced their budgets, but each is economically constructed out of simple, rolled steel shapes. The Hermetic Motor Plant for Westinghouse (page 120), is clad in corrugated metal sheet and handsomely detailed inside and out. The Air Freight Building #1 and the Adams Wastewater Plant (page 126) are executed inexpensively and unpretentiously in concrete for municipal clients who cared about quality and looked to architects who would provide it. Each of the six establishes a level of design and amenity that points toward a new standard.

Architects and clients

The owners of several of these buildings were already knowledgeable about design and construction techniques. As manufacturers of components to the aerospace industry, Parker Hannifin executives understood flow diagrams and how planning requirements are translated into building programs. They understood industrial assembly, stresses, steel detailing, welding techniques and dynamic loading. They also understood that appearance counted. "The result," says Michael O'Sullivan, project architect for Albert C. Martin, "was that we understood and believed in each other from the beginning."

Newspaper publisher Robert N. Brown was also concerned about quality. His paper has a civic image and a reputation for integrity. He was also building on a prime, downtown site in Columbus, Indiana—a city conscious of its distinctive buildings.

The Adams Wastewater Plant presents the special case of independent architects retained for their design services by an engineering firm who maintained primary responsibility to the client. The results of this cooperation are seen on page 126.

Not all owners will be engineers. Not all sites are prime. But architects, designing with industrial components for clients who care about quality, can do much to raise the general level of design.

Industry depends for its continued good health on multiplying consumers and intensifying their de-

The Republic:
A century-old, Midwestern
newspaper builds with
elegance and civic pride
in a city noted for the
distinction of its buildings
and the architectural awareness
of its citizens.

Relatively few businesses of any kind live long enough or achieve sufficient eminence to justly be called "civic institutions." *The Republic*, a hundred-year-old Columbus, Indiana daily is a civic institution. When owner-publisher Robert N. Brown decided to move and build again, he settled on a prime, downtown site opposite the city courthouse. He commissioned Skidmore, Owings & Merrill (Myron Goldsmith, partner-in-charge) with whom he had worked before, because he is an owner who cares and because Columbus

is a city that cares. Delicately framed and detailed in light steel and sheathed in tempered glass, the finished building has a decidedly "non-industrial" look. The decision to use large and vulnerable expanses of glass was not taken without considerable thought. A newspaper office, after all, is frequently the target of people with grievances both real and imagined. But because of the owner's confidence in his community and his conviction that a newspaper press is an exceptionally handsome piece of industrial design, the building was

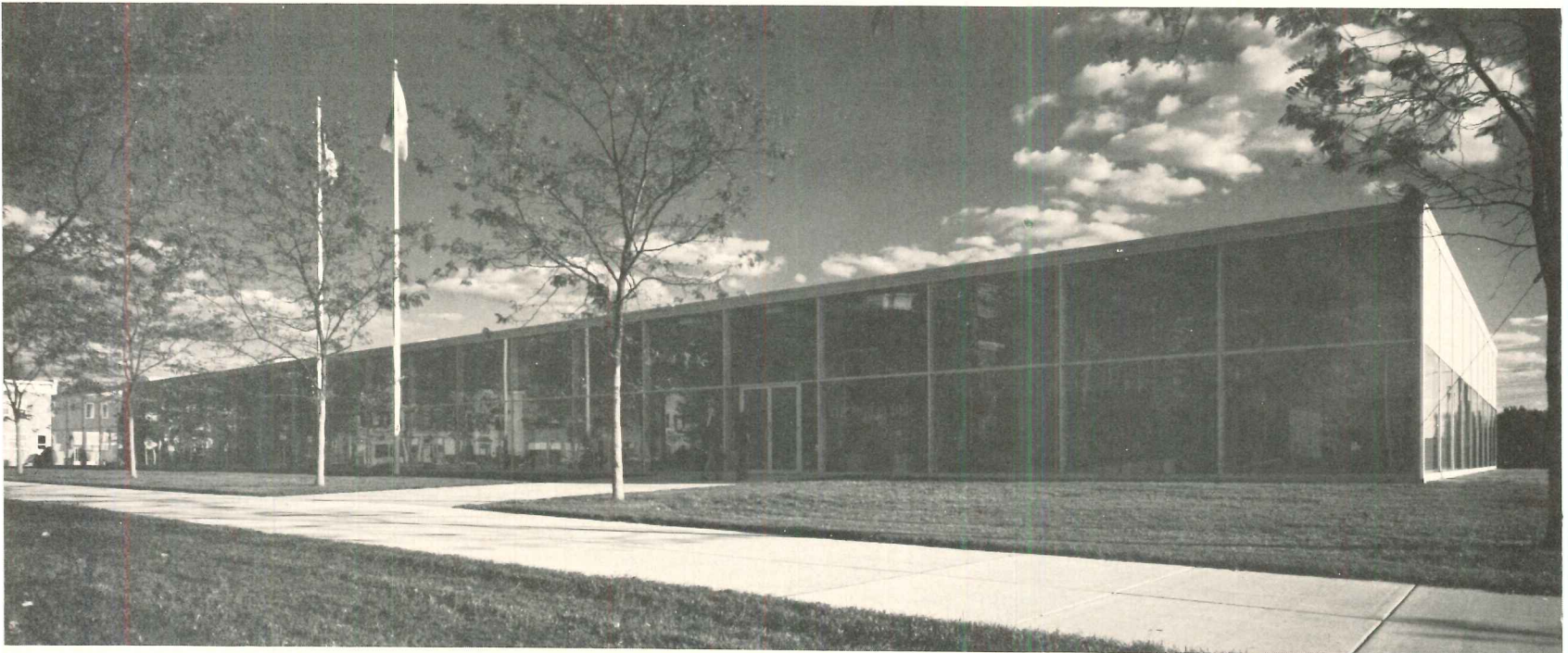

Ezra Stoller © ESTO photos

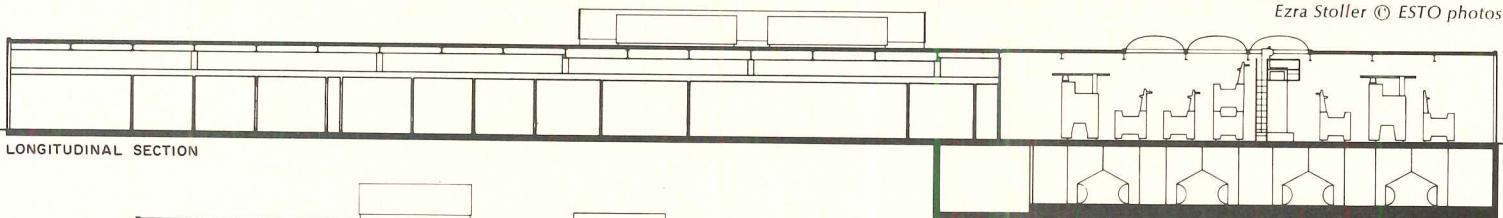

LONGITUDINAL SECTION

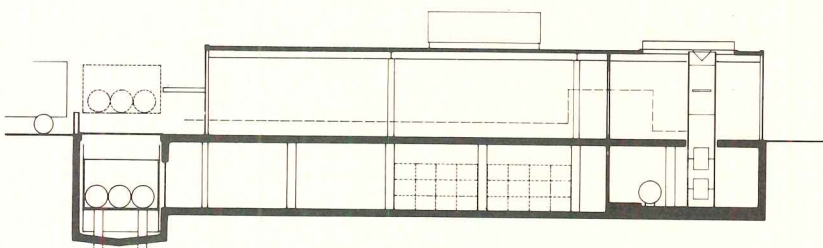

SECTION THROUGH PRESS ROOM

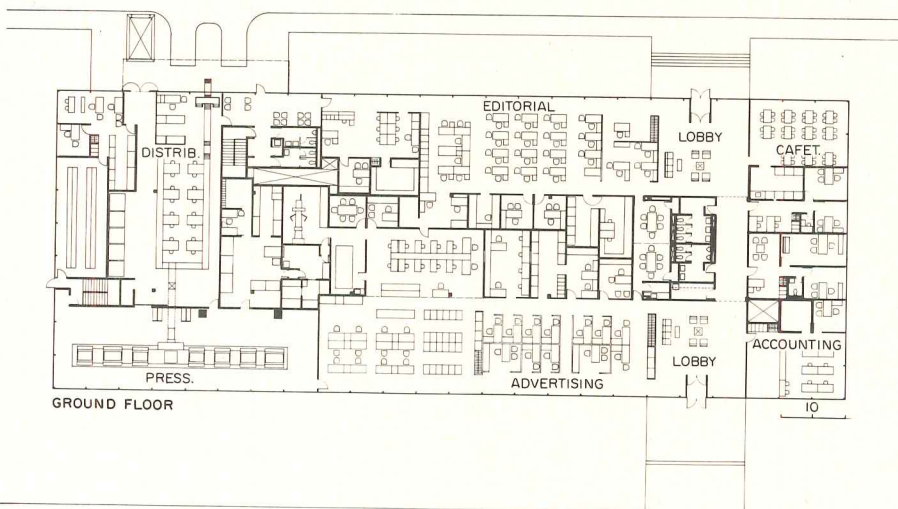

GROUND FLOOR

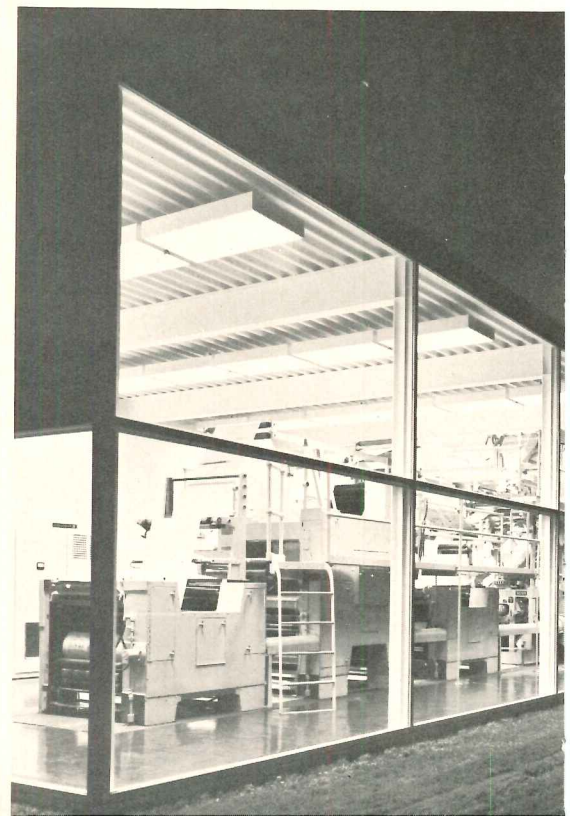

largely enclosed with glass. As a result, much of the journalistic process is continuously visible. "Few other industries," says Brown, "can do this with such impact."

The program, drafted jointly by owner and architect, called for general office and editorial space in addition to press and composing rooms. By floating the press on a special pad with footings independent of the main foundation, vibration through the building is minimal. By isolating the press acoustically behind a glass wall, the office spaces are quiet even during the daily press

run which lasts about an hour. Across the glass barrier, the sound drops from approximately 90 decibels to a faint, scarcely audible rumble.

Lithographic offset printing does not generate any significant contaminants so special pollution control devices are not required. Normal newspaper wastes—paper, ink, silicone treated wrappers—are hauled away under contract. There is no incineration on the site.

The building employs single, and multi-zone air conditioning units with ceiling dif-

fusers and floor grilles at the perimeter walls. Mechanical spaces are located in the partial basement. Cost for the structure, less land and fees, was just over \$30 per square foot.

The owner does not anticipate major expansion. The new building was oversized by the architects to accommodate some natural growth. If unanticipated expansion occurs in future, it will probably be in the form of a new press room to be located elsewhere on the site. For this reason, the architects planned and designed the build-

The new building for "The Republic" is an important part of the city's downtown renewal plan (also by Skidmore Owings & Merrill) that will soon include a two-block shopping mall. The architects kept the profile of the new plant as low as possible in deference to historic Bartholomew County Courthouse which stands just a block to the north—and is reflected gracefully in the new building's long glass wall.

THE REPUBLIC, Columbus, Indiana. Architects and engineers: *Skidmore, Owings & Merrill* (Myron Goldsmith, partner-in-charge; George Hays, project manager; Jin H. Kim, senior designer; George Larson, interior design; Philip Thrane, job captain). Contractor: *Dunlap Construction*.

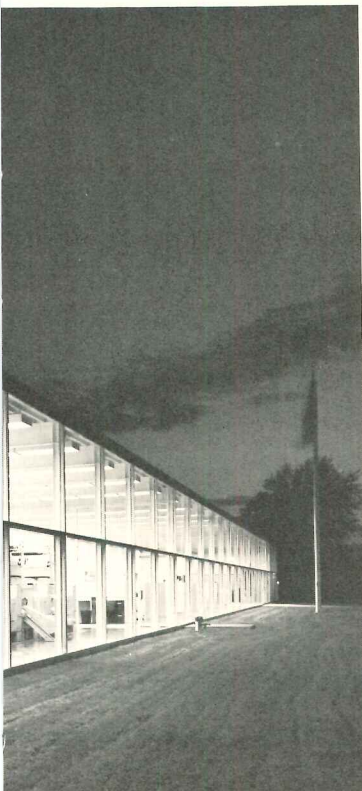

ing as a discrete entity.

The Republic plant is an exceptional industrial building in terms of its location, its public function, the level of its finishes and the way in which its excitement is generated. Static in form, elegant in detail, the building shell is crisp but withdraws visually to emphasize its contents—especially at night (see photo below). As the photographs indicate, every surface, every intersection and every detail betrays a high level of design concern. This concern extends to the selection and place-

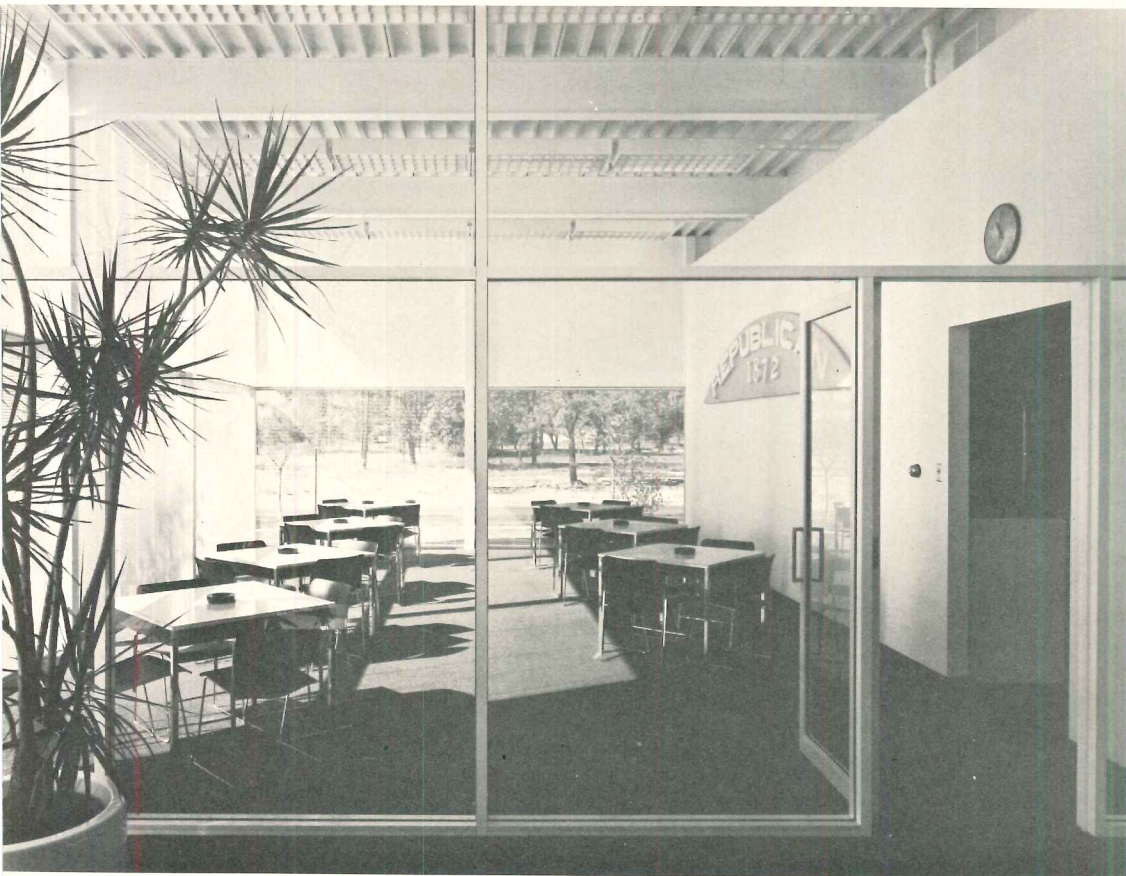
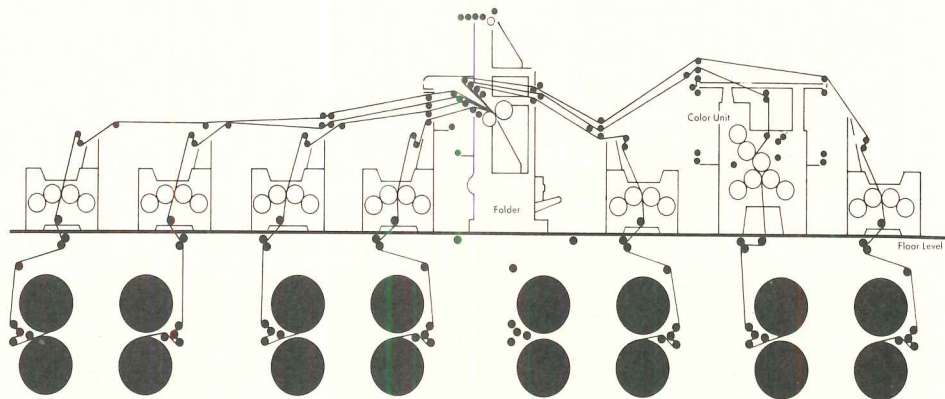

Rolls of newsprint 30 inches wide and 42 inches in diameter are located in the reel room under the press. The web feeds into each printing unit as shown. Printing is done simultaneously on each side as the web passes between two rubber covered cylinders. Printed webs are then collected in the center of the press where they are folded and cut to page size. At full capacity, this press can print 40,000, 28-page papers per hour.

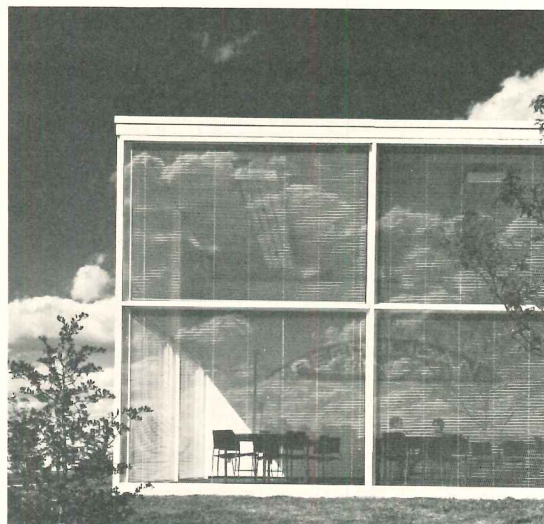
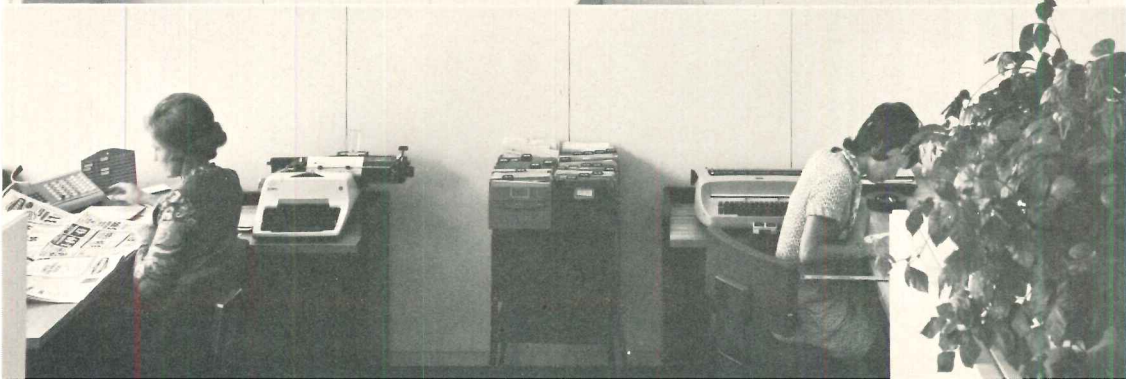
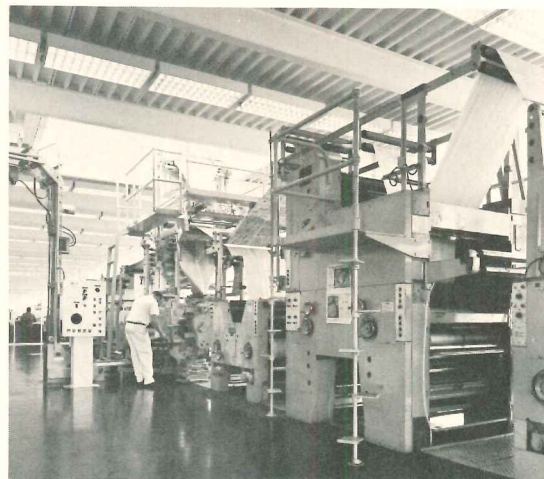

ment of furnishings, the forthright use of bright primary color accents against a neutral background and the variety and richness of a small but carefully selected art collection. Says Brown of this highly individualized collection: ". . . although the building is quite modern in design, an effort was made to tie it in with some of the earlier history of the newspaper and of the community." In the main reception area, for instance, artist Norman Ives has designed a mosaic in low relief by arranging old wood type blocks into jumbled, abstract patterns

(photo below). Seen through the glass wall of the employee's lounge (photo, opposite right) is the original sign rescued from the old building before it was razed. In the south lobby hangs a lithographic mural showing in aerial perspective what the city of Columbus is presumed to have looked like in 1886.

Stimulating, comfortable, dignified and intelligently planned, The Republic newspaper plant, by almost any measure, is very near the high end of the industrial building spectrum.



Parker Hannifin Corporation:
This manufacturer
of aerospace components
wanted a contemporary image
that would instill
confidence in his product
and credibility in his industry.
What he got does both.

On a 74-acre site outside Los Angeles, A. C. Martin and Associates have planned and designed a headquarters and manufacturing facility which designs and builds components for the aerospace industry. The 4-building facility encloses some 300,000 square feet and is planned for incremental expansion as production requirements change. To provide this flexibility, the architects designed a moment-resisting frame composed of open web steel trusses supported on 12-inch diameter pipe columns

laid out on a 60-foot-square grid. Infill panels are lightweight, tilt-up concrete with a sand-blasted finish. The panels are demountable in the event of expansion. The open webs of the trusses are glazed along the outside walls to admit daylight. Costs were within the budget—\$23 per square foot for the office and administrative areas, \$11.50 for the manufacturing spaces.

The client was aware from the beginning that what he needed was a factory. But he was convinced that within his budget, a pleasant level of employee comfort and

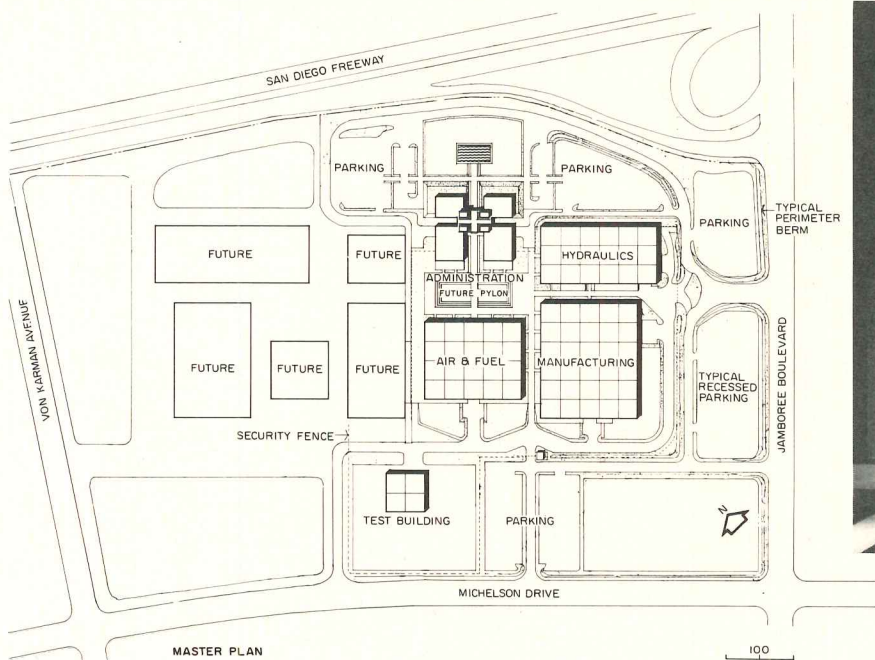
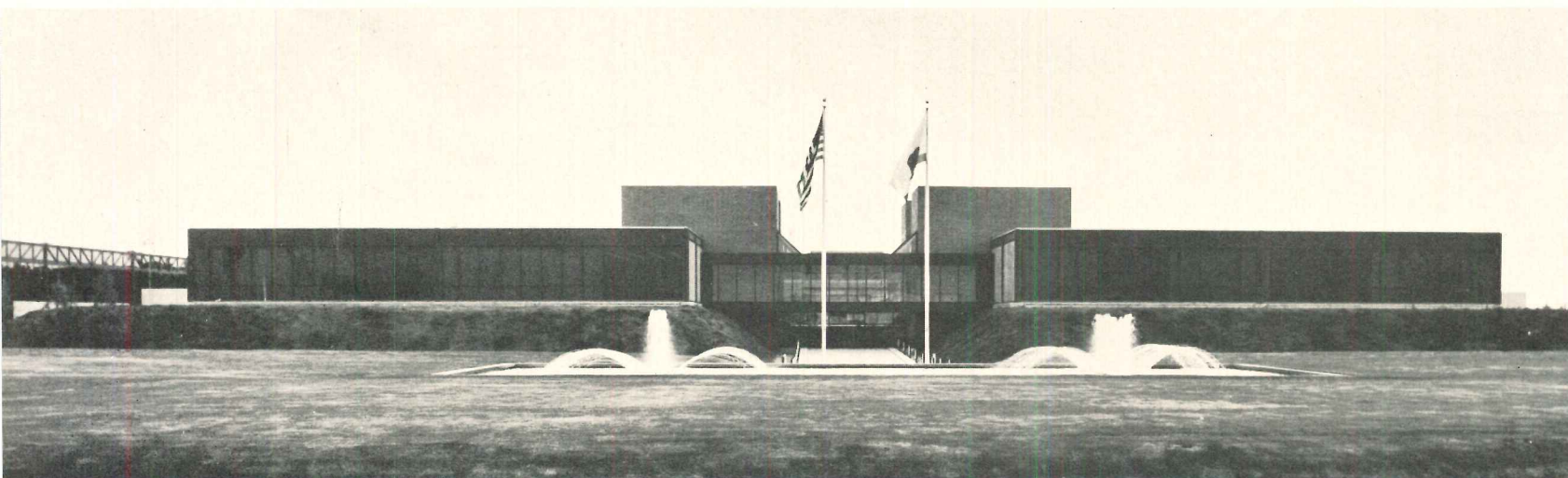

Wayne Thom photos

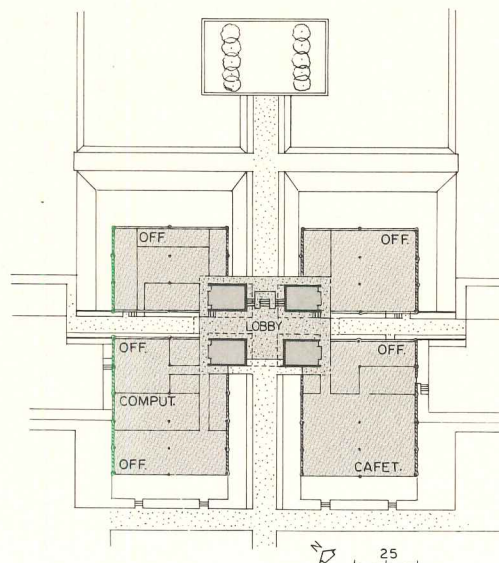
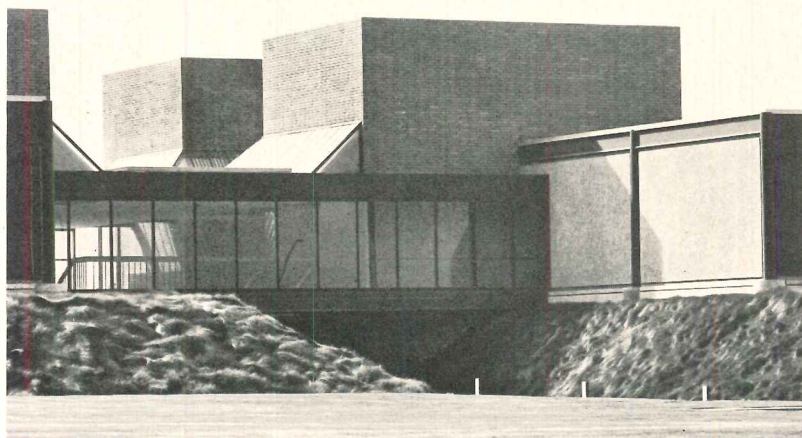

amenities could be achieved. He was right. At reasonable costs and within a fixed structural system, the architects have provided a surprising richness. The buildings are grouped in a campus-like arrangement around a landscaped court. Parking areas are screened with earth berms. The steel detailing is consistent and surehanded. Added richness is provided by the use of narrow bands of color accents—blue at the fascia, red to outline the infill panels (photos below). A handsome sequence of signs identifies each part of the complex and

marks the routes between buildings. Berms are also used by the architects to screen the parking areas and to soften the effect of the encircling fence required by government security regulations.

Because the firm is involved in research and testing, certain flammable chemicals and volatile fuels are in more or less frequent use. Operations that require the handling of such materials are largely confined to a deeply bermed chamber at the south end of the site. The industrial park in which this building is located placed deed restric-

tions in its leases that established upper limits for industrial noise. In order to comply with these restrictions, the architects located the noisiest test equipment in this same bunker. Inside, a network of filter traps protects against hazards created by accidental spillage of hydraulic oil or other troublesome liquids.

On the assumption that a building's quality affects the performance of those who use it, Parker Hannifin was willing to make a substantial, long-term investment in its people and its product.

A large reflecting pool graces the main approach and the twin fountains and flagpoles reaffirm the plan's axial symmetry. Major expansion will occur in the form of a new building cluster to the west of the existing complex (see master plan).

PARKER HANNIFIN CORPORATION, Irvine, California. Architects and engineers: Albert C. Martin & Associates (John Day, partner-in-charge; W. Jay Smith, project director; Michael O'Sullivan, project designer; Aram Tatikian, job captain. Bill Huddleston, structural engineer; Don Teske, electrical engineer; Tony Tang, civil engineer; John Swiatnicki, interiors; Robert Morgan, graphics; Vince Walsh, estimator); soils engineer: Moore & Tabert; landscape architect: Erikson, Peters & Thom; contractor: Robert E. McKee, Inc.

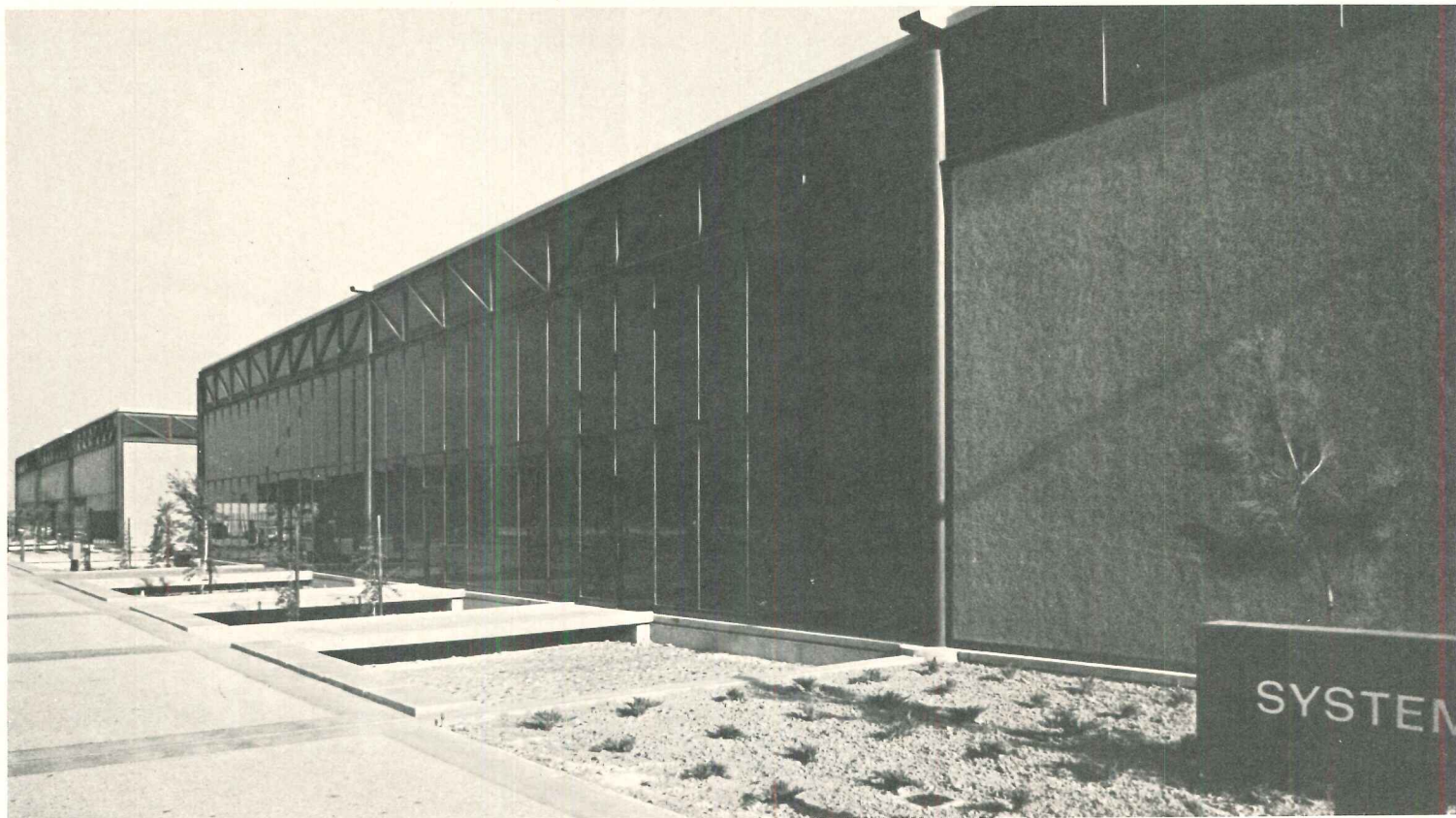
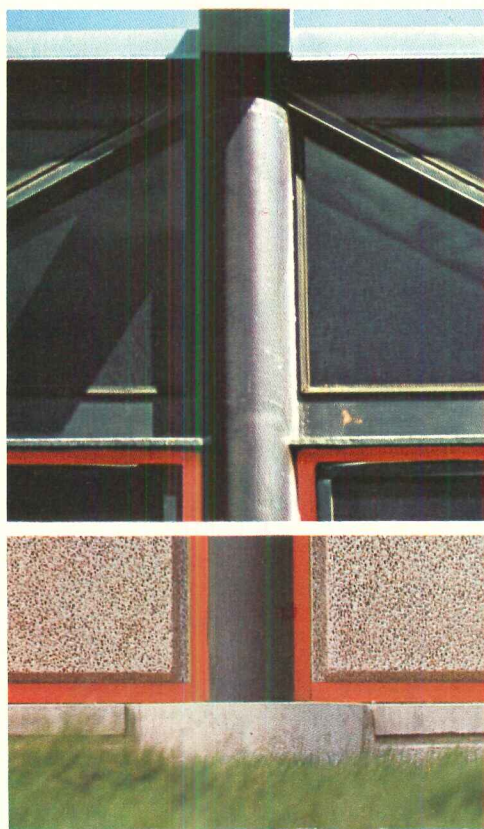

Westinghouse
Hermetic Motor Plant:
Corrugated metal cladding
and crisp steel details
in a Tennessee plant for
a large, national corporation
with a growing reputation
for architectural quality.

At this plant for Westinghouse in Athens, Tennessee, medium-sized (24 lb) motors are manufactured for subsequent use in refrigerators and air-conditioning units. After lengthy discussion with their client, architects Heery and Heery planned an integrated building instead of the more traditional bi-nuclear scheme that spaces out offices and manufacturing areas by inserting reception and service functions in between. This integrated solution mixes office and manufacturing areas together, thus reducing the inefficiencies of separation and reinforcing,

in each employee, a heightened sense of belonging to the same large Westinghouse family. While this egalitarian impulse complicated certain of the internal circulation problems, it also provided a design opportunity. Large and small bay functions can be combined to animate the exterior by breaking down its scale and stepping the wall planes in and out.

The building is framed in simple steel shapes and clad in corrugated metal sheet which, of course, textures the elevations consistently. The interiors, in the motor as-



Joseph W. Molitor photos

The site is pleasant parkland outside Athens, Tennessee. The level of the approach road is slightly depressed. The static, almost serene, quality of the exteriors contrasts sharply with the fluid, sweeping lines of motion in the high bay assembly areas (photos lower right). Light steel framing in columns, trusses and struts augments this kinetic character.

WESTINGHOUSE HERMETIC MOTOR PLANT, Athens, Tennessee. Architects and engineers: *Heery and Heery* (John Wurz, project director; Mack Scogin, project designer); contractor: Reittenbach Engineering Company.

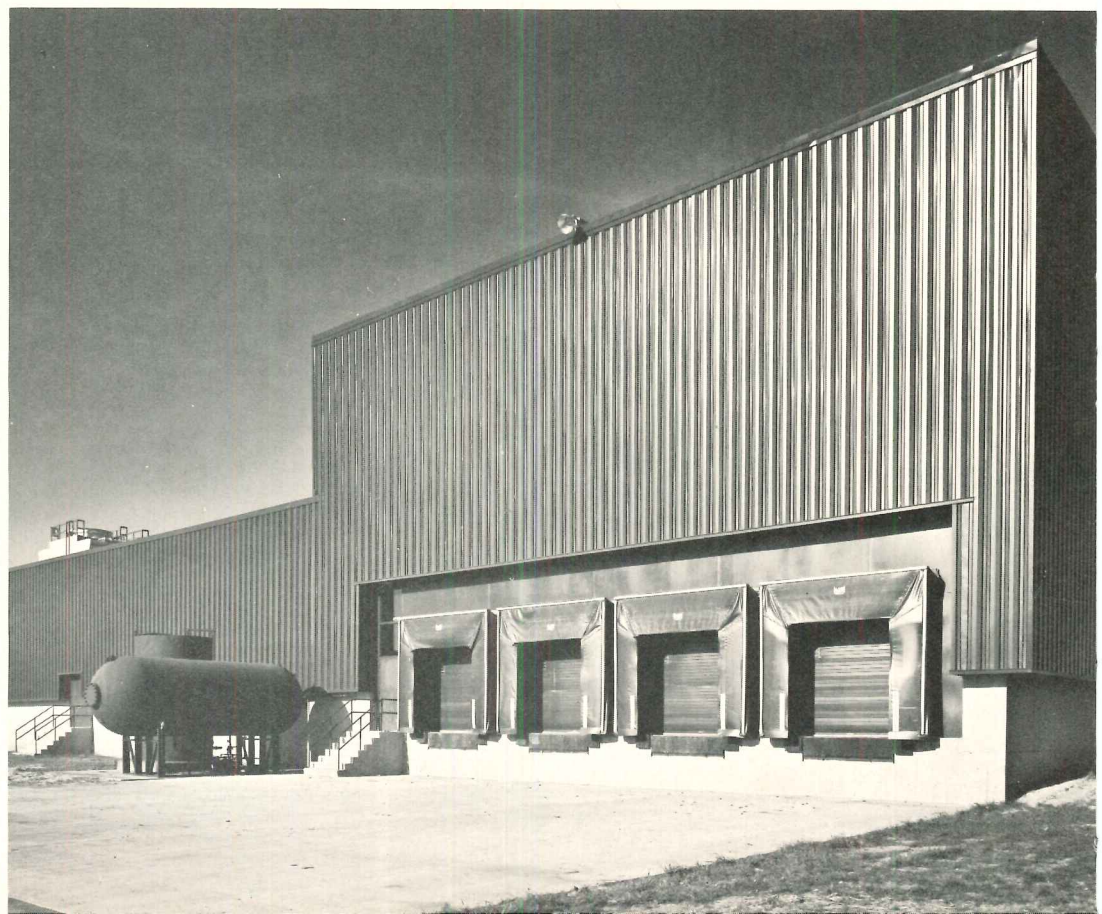
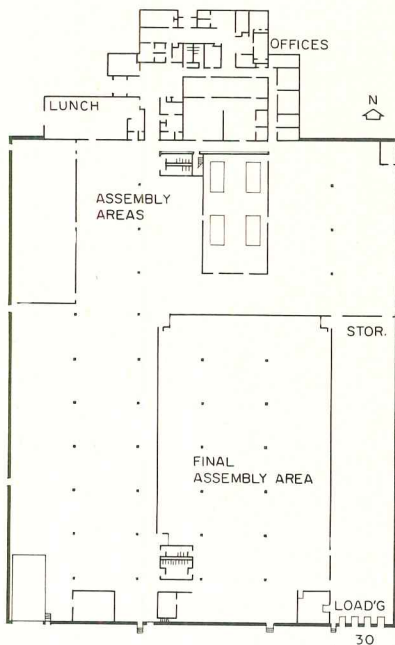

sembly areas, are mechanistic but dynamic—continually set in motion by long, sweeping lines of conveyors.

No unstable or especially hazardous materials are employed in this particular manufacturing process. Molten aluminum is the only potentially dangerous material in use and it is kept inside the injector where the threat it poses to personnel is minimal. The only process wastes are metal scraps which are collected in a hopper and returned for resmelting.

Heat and noise levels, however, are

sufficiently high to require special treatment. The architects isolated heat and noise generating equipment behind masonry walls and floated some equipment on special pads to reduce vibration. These spaces evacuate surplus heat directly to the outdoors.

The high level of design concern extends to the sitework and landscaping. Pedestrian approaches and entrances are carefully studied. Shrubs, paving and small trees soften the visual impact of hard edges and crimped metal. Outdoor lighting fixtures are selected and placed for safety, effici-

ency and appearance.

As in the other buildings in this study, the Westinghouse Hermetic Motor Plant reaches for a level of amenity and design quality not often enough encountered in industrial building. By limiting the design vocabulary to simple geometric forms and by combining those forms with skill, the architects have created a workplace that is efficient, comfortable and thoughtfully planned. Why should the owner, the architect, the employee or the public continue to settle for less?

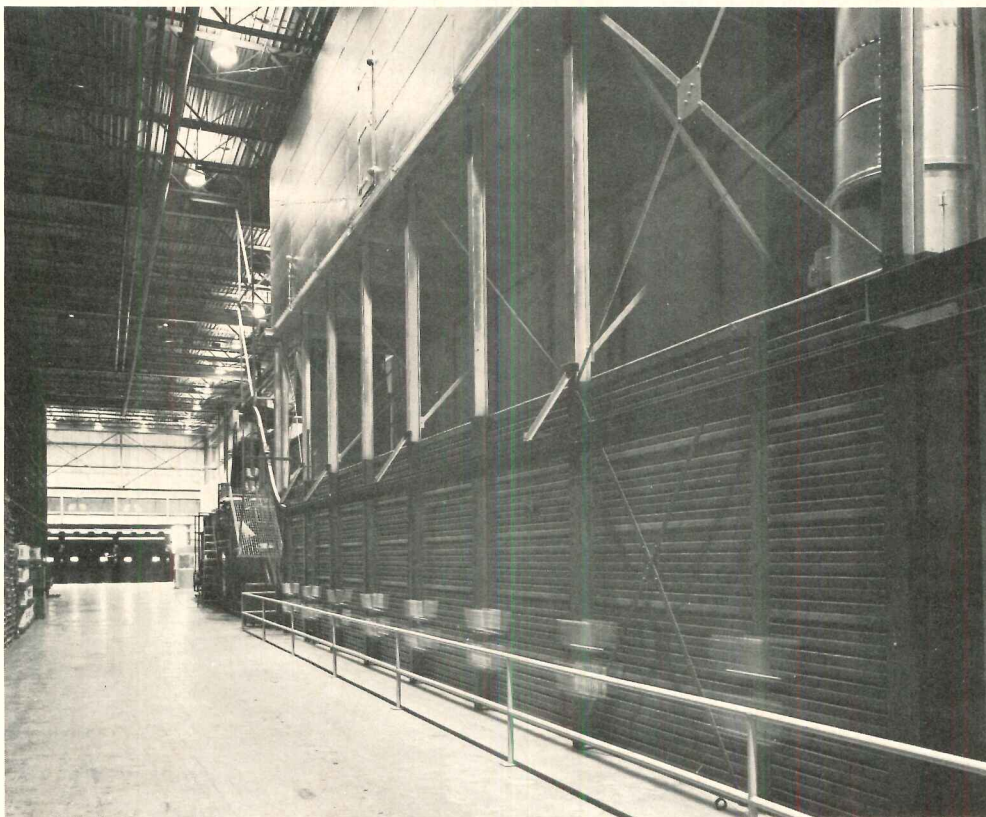

P. J. Carroll & Company, Ltd.:
A new home in Dundalk
for a tobacco processing firm
that has long been,
and continues to be,
a significant presence
in the industrial life
of Ireland.

Carroll's tobacco factory has been a familiar landmark in Dundalk since its founding in 1824. In 1967, after numerous modernizations; the company's directors reluctantly abandoned the old site and purchased thirty acres just outside the city. They commissioned Michael Scott & Partners (Ronald Tallon, partner-in-charge) to design a new facility—a facility that would provide the comfortable, hygienic surroundings necessary to contemporary, heavily automated tobacco processing. The architects, after visiting new tobacco factories in various

countries, prepared the drawings for the building shown in the photographs below.

Efficient operation and worker comfort were prime requisites. Because the business is competitive and the technology subject to periodic improvement, flexibility was also important. The Scott design addresses itself to all these needs. The entire four-acre structure is fashioned by the repetition of a single structural unit: a steel bay with a clear span of 67 feet 6 inches in both directions. The bay is framed out above with steel roof trusses 7 feet 6 inches deep—a depth suffi-

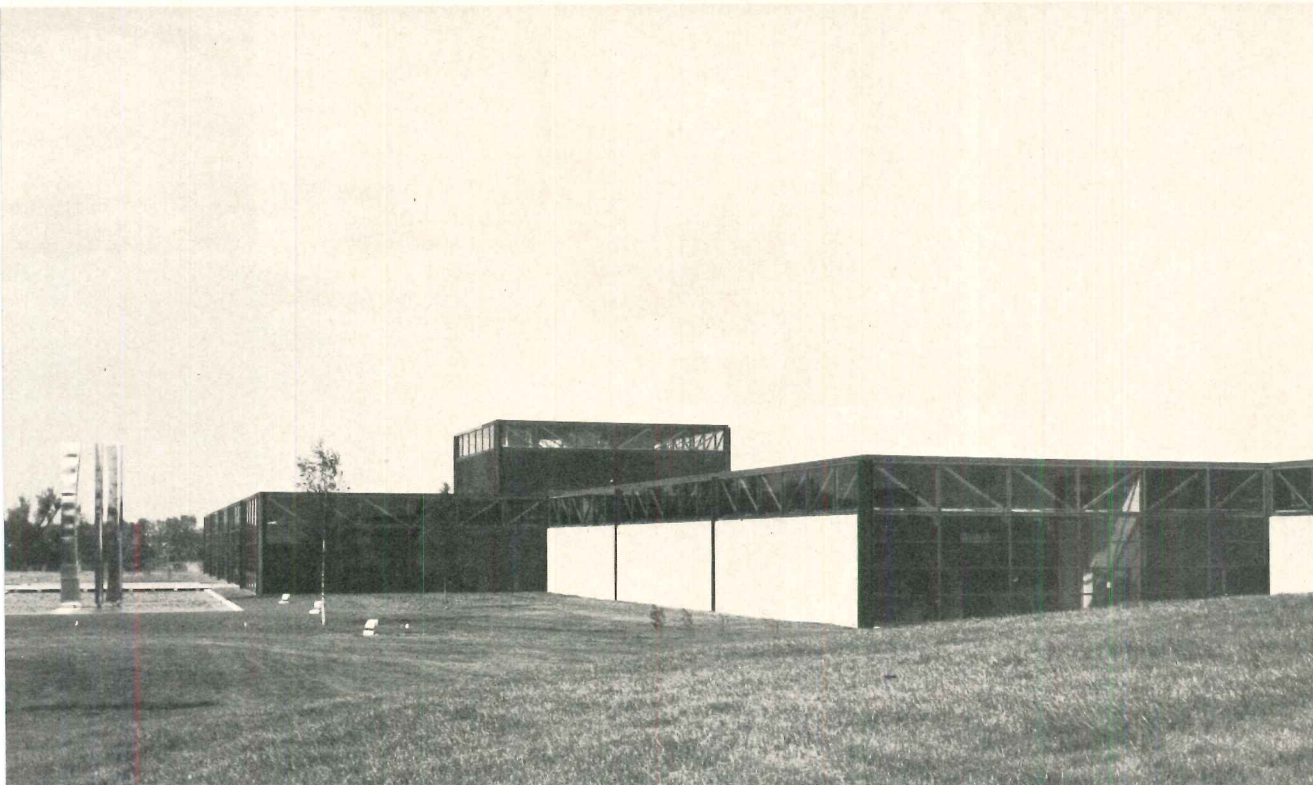

Though interior spaces vary widely in finish and function, the 67-by-67-foot structural bay is legible throughout. Parking for employees is at the site perimeter.

P. J. CARROLL & COMPANY, LTD., Dundalk, Ireland. Architects and engineers: *Michael Scott and Partners* (Ronald Tallon, partner-in-charge; Patrick Reeves, assistant architect; Charles Jenkins, mechanical engineer; Lawrence Kyne, electrical engineer). Structural consultants: *Ove Arup and Partners*; quantity surveyor: *Seamus Monahan*.

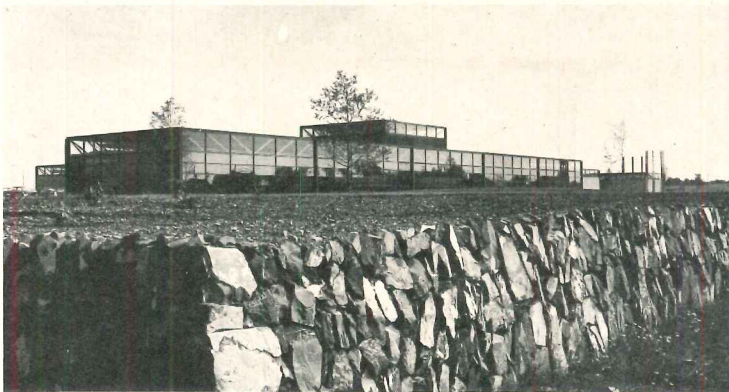

John Donat photos

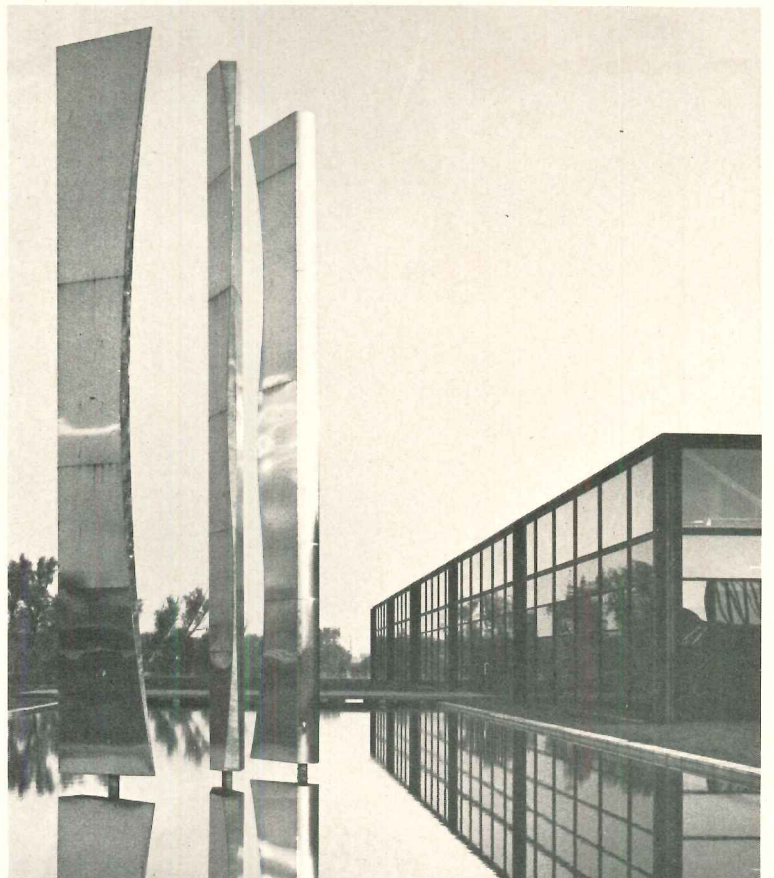
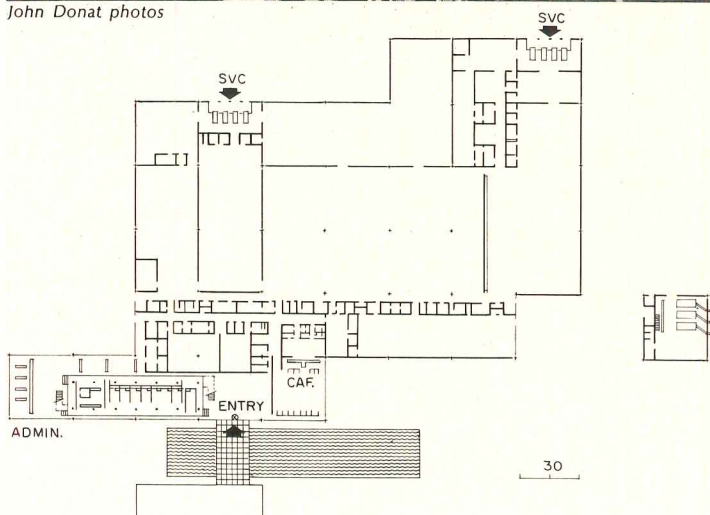

cient to house and distribute all the complex mechanical and electrical services the factory requires. The whole structure is fully sealed and air conditioned.

Expansion will be in 5000-square-foot increments to be located as functional requirements may dictate. This flexibility, inherent in the basic planning, strongly influences the building's appearance inside and out. The modular bays are clearly readable and do not lose their definition whether the infill panels are grey brick in the processing areas or bronze glass in the offices.

The structure meets the ground precisely, but around the building the land undulates gracefully to create a series of barely perceptible swales. Seeded with grass and lightly spotted with trees, these generous park areas are an amenity to be enjoyed by owners and employees alike.

Visitors to the Dundalk factory approach over a bridge that spans a generous reflecting pool. Rising up from this pool, like a welcoming sentinel, is a tall, three-shafted, stainless steel abstract. Elsewhere in the building, tapestries, canvasses and sculp-

tures by leading Irish artists express the company's desire to broadly identify the arts with industrial enterprise.

Rationally planned and efficiently assembled out of simple, preformed parts, the Dundalk plant uses the coherent, international language of industrial building and uses it well.

The architects express confidence that the new Carroll factory will be one of the most modern tobacco processing plants anywhere for many years to come. Total cost was approximately \$4.5 million.



Air Freight
Building #1:
More for parcels than
for people, this rugged,
multi-client cargo
building develops
its design strength
from basic user needs.

The concentrations of service buildings around airports are seldom fortunate enough to include a structure as strongly conceived or as handsomely constructed as Air Freight Building #1. Located at the Los Angeles International Airport, this structure by Parkin, Architects is used to process air cargo. Warehousing functions predominate. Like most such buildings, the general public seldom enters it but it gets constant, rugged use so durability counts.

The architects spent many hours interviewing representatives of the major airlines

who would be renting space in the completed structure. Out of these interviews, several needs emerged. The clients wanted automobiles parked off the ground so the decision was made to place a parking deck on the roof of the building. Perhaps more than any other, this decision affected the planning and influenced the building's final appearance. Not only was an automobile access ramp necessary, but external stairs would be required to reach the roof deck parking. In addition, the parking decision pointed to the suitability of concrete as the

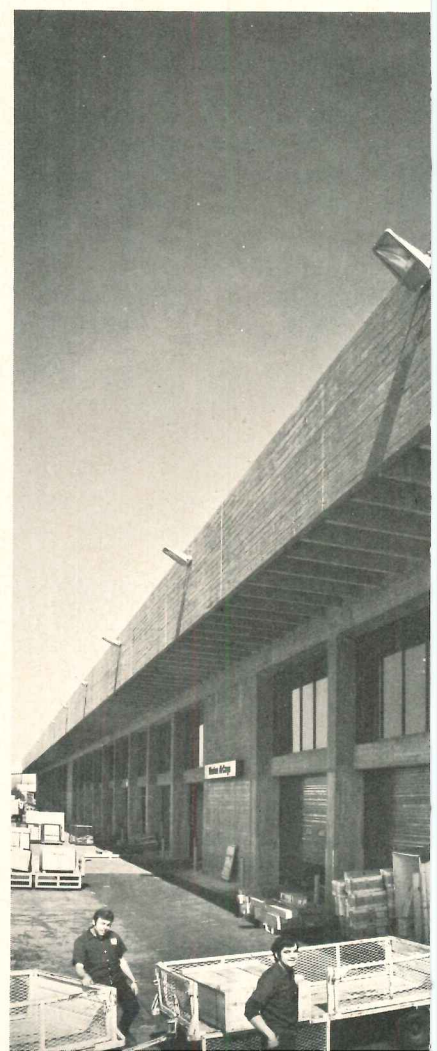
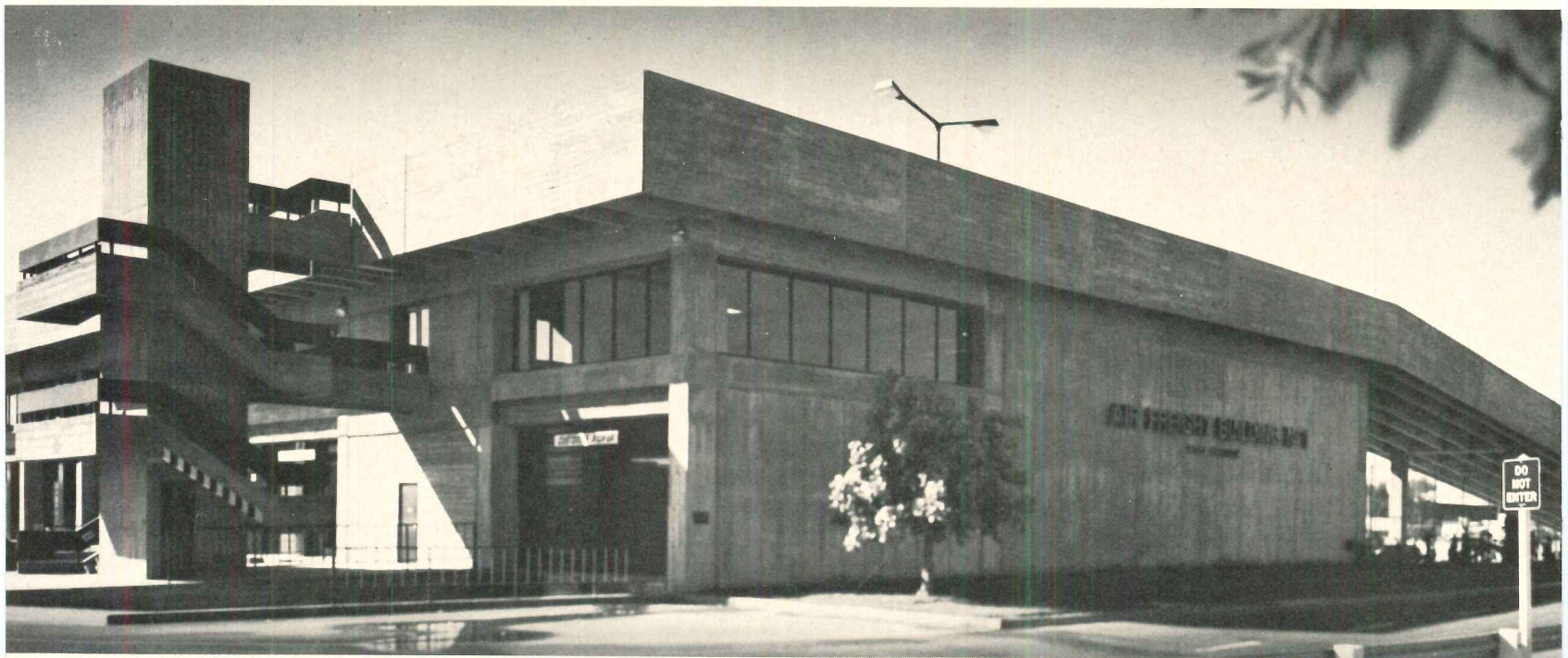

Julius Shulman photos

basic building material. Walls, slabs and columns are poured-in-place.

The plan has an almost diagrammatic clarity. Most of the ground floor is given over to warehousing. Above, on a partial mezzanine, is supervisory office space that is expressed on the elevation by a long strip of horizontal glazing. Roof deck parking is shielded from view by a deep parapet. The basic structural module is a concrete bay 24 feet wide. By combining these bays, an interior volume 24 feet high develops and extends for 600 feet. Planes and other air-

port vehicles can approach to a loading apron anywhere along this entire length (photo below).

The building's strength is its simplicity and its integrity. At no time have the architects invested their design with false pretention or monumentality. They have generated and combined simple forms in a direct and appealing way, making the most of all architectural exigencies. Details are kept as simple as possible. The architects attribute much of the success of their building to the freedom they were given during

programming and conceptual design—a freedom, we might add, that they had to earn.

Because this air freight building is not complex in function or elaborate in level of finish, the architects were able to maintain an especially firm control of costs from beginning to end. Final cost of the building, less fees, was \$1,427,000.

Though a limited budget building, largely poured-in-place and with almost no interior finishes, the architects have generated a surprising design richness.

Parapet, wall planes, columns and beams are all imprinted by the wood forms in which they were poured. This uniform texturing contributes to the feeling of durability and creates a series of pleasing, low-maintenance surfaces.

AIR FREIGHT BUILDING #1, Los Angeles, California. Architect: Parkin, Architects (Lloyd S. Laity, partner-in-charge; David Brody, designer); structural engineers: Johnson and Nielsen; mechanical engineers: Hugh Carter Engineering Company; soils engineers: Leroy Crandall & Associates; landscape architects: Lifescapes; contractor: Vinnell Corp.

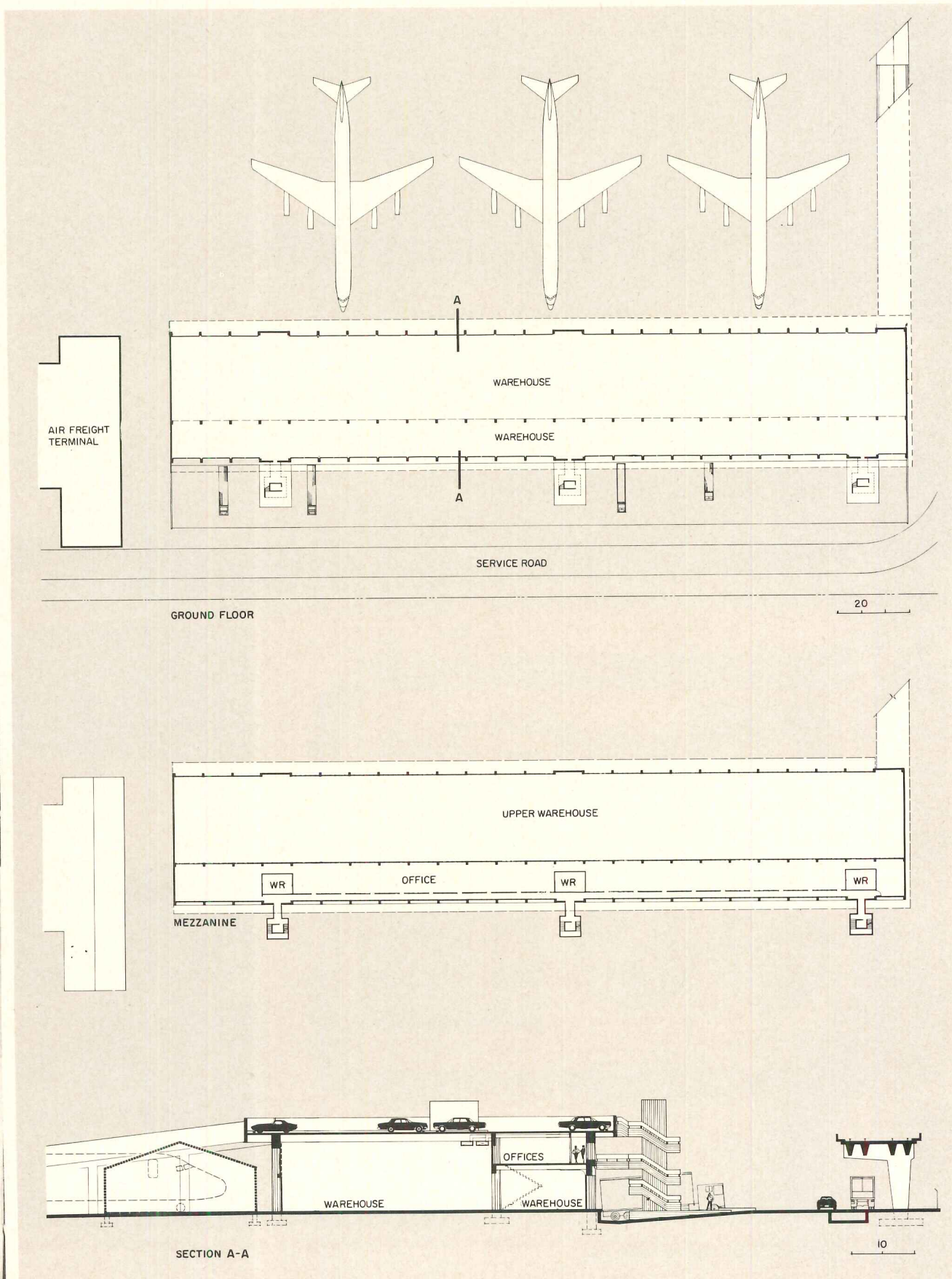
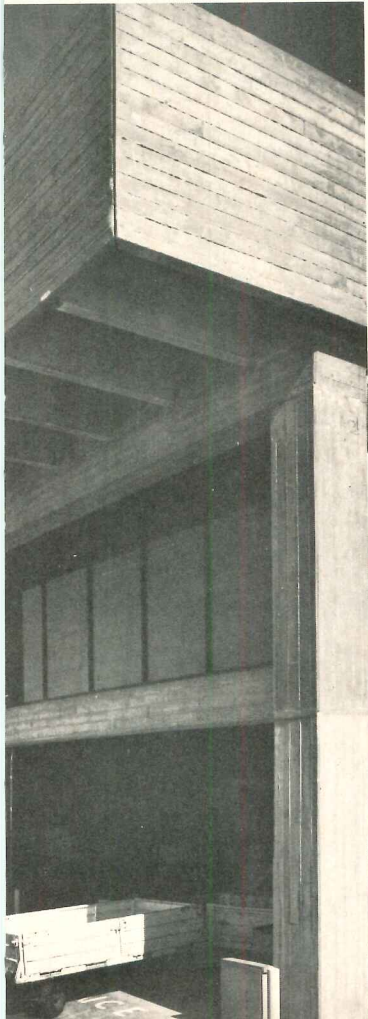

Adams Wastewater

Treatment Plant:

An exceptionally handsome industrial structure built on a modest, municipal budget by architects and engineers who are deeply committed to improving design quality.

Set against a background of great natural beauty in the foothills of the Berkshires, this municipal sewage treatment plant indicates what can be done with a building type that has had little genuine architectural attention—a building type that usually loses design integrity by default. Much of the success of the Adams plant is attributable to the close working relationship established between architects Johnson-Hotvedt & Associates and engineers Camp, Dresser & McKee who maintained overall responsibility for the project. Several excellent buildings have al-

ready come from this union. Among them is the Brockton Water Filtration Plant (RECORD, February, 1971). By pooling their expertise and by offering a combined service, the team has been able to construct buildings of high design quality that conform to the strictest technical requirements for sanitary engineering.

The architects have shunned the typical solution—a series of small outbuildings with apologetic, palely imitative neo-Georgian facades turned toward the road. Instead, they have concentrated this industrial proc-

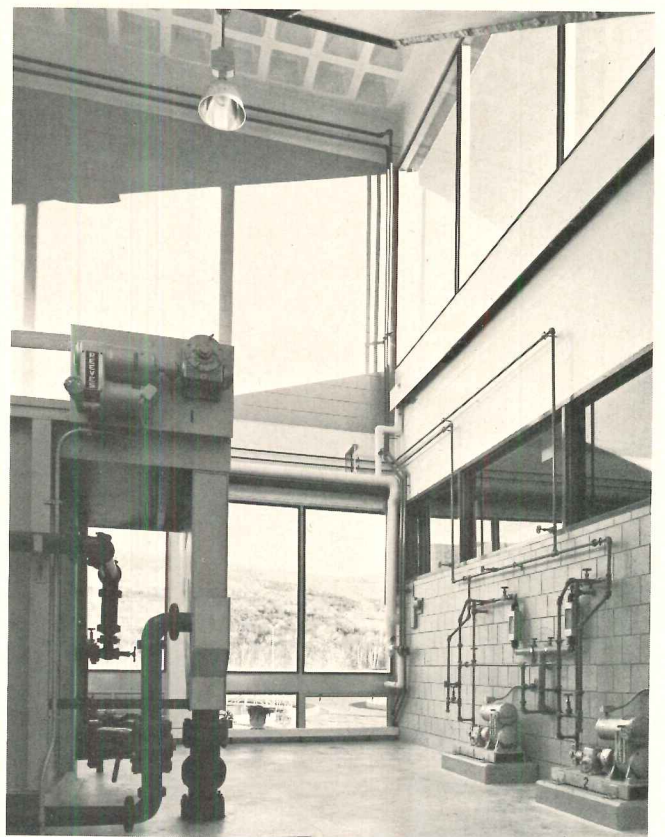
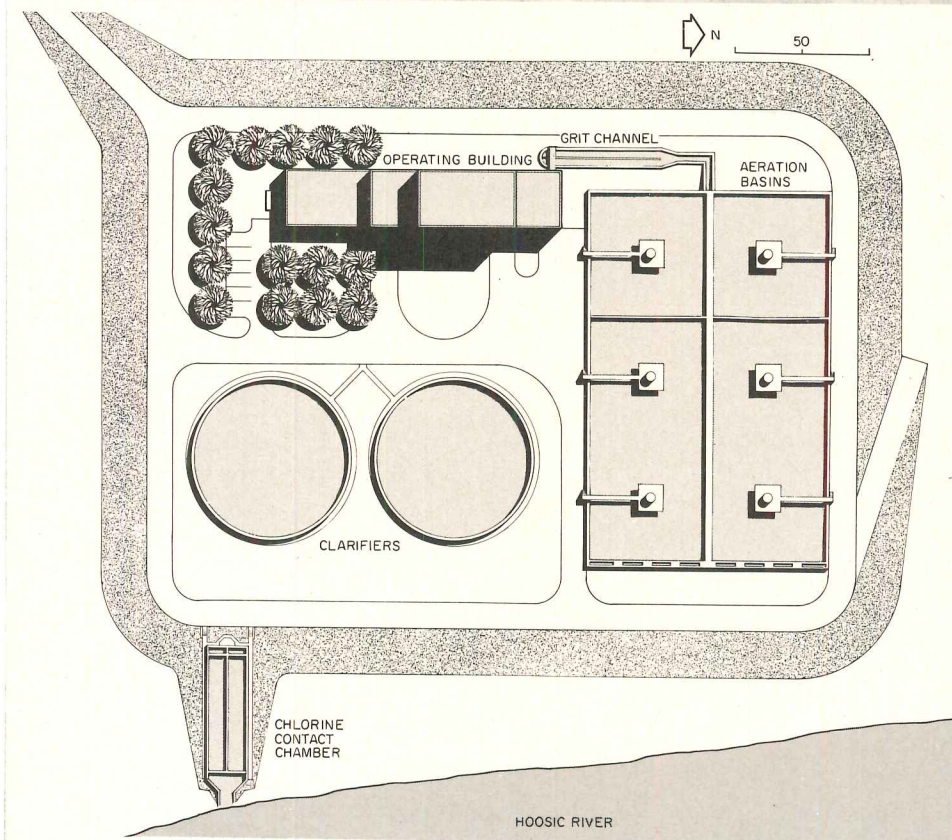
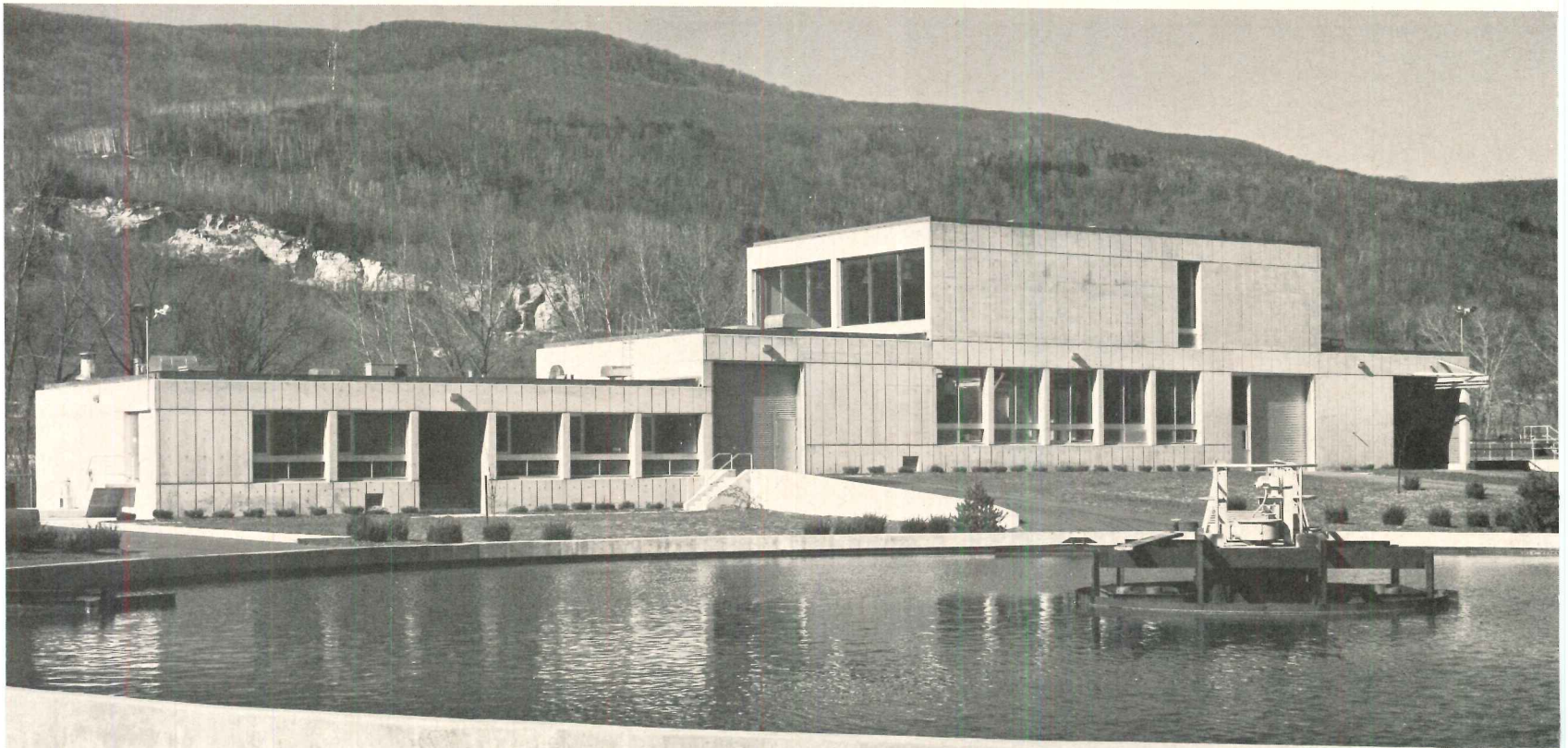

ess into a single, integrated structure and expressed the building's functions in vigorous, contemporary terms. The massing is direct, clearly and simply reflecting the functions and volumes contained within. Exterior surfaces are planar but carefully rusticated for scale and appearance. In spite of the concentration of its functions, this sewage treatment facility does not seem bulky or overmassed. And thanks to careful design attention, it never sacrifices its pleasant, human scale.

The Adams plant is simply constructed.

The structure is concrete, poured-in-place, using ordinary plywood forms. Floors are two-way waffle slabs, windows are aluminum sash and the roof is built-up. Engineering determinations were, of course, critical. Each end of the building had to be located at a precise elevation on the site. The section, below, clearly describes the sub-grade levels and volumes that had to connect the building's fixed end points.

The designers elected to open the interior spaces and flood them with as much daylight as possible. In addition, they vis-

ually organized the heavy mechanical requirements by careful placement of equipment and color coding. Color is also used, with restraint, on the large overhead doors at several locations on the building's exterior. Cost of the entire plant, including all tanks, apparatus and site work was approximately \$3 million.

When more architects are seriously committed to designing pollution control facilities, Adams Wastewater will still be a model. Until then, this excellent facility is very nearly unique.

In this industrial process, both the raw material and the finished product is waste. Raw sewage is received from the municipal sanitary system and is immediately screened to remove foreign materials. It is then transferred to aeration basins (see site plan) where oxygen is introduced to heighten the bacterial process of coagulation. Partially consolidated wastes are then transferred to clarifiers where solid and liquid wastes are separated by settlement. Liquid wastes are sanitized in a chlorine chamber before being released into the river. Solid wastes are conducted to sludge holding tanks where thickening agents are added. Final product is trucked.

ADAMS WASTEWATER TREATMENT PLANT, Adams, Massachusetts. Architects: Johnson-Hotvedt & Associates. Engineers: Camp Dresser McKee, Inc., soil engineer: Haley and Aldrich. Contractor: Thompson Construction Co.

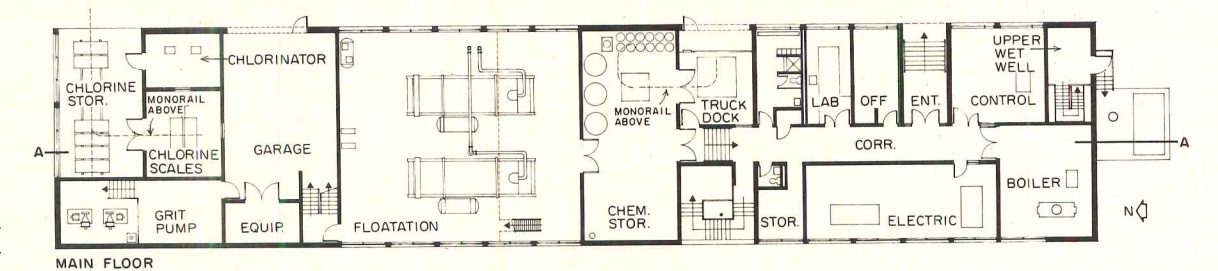
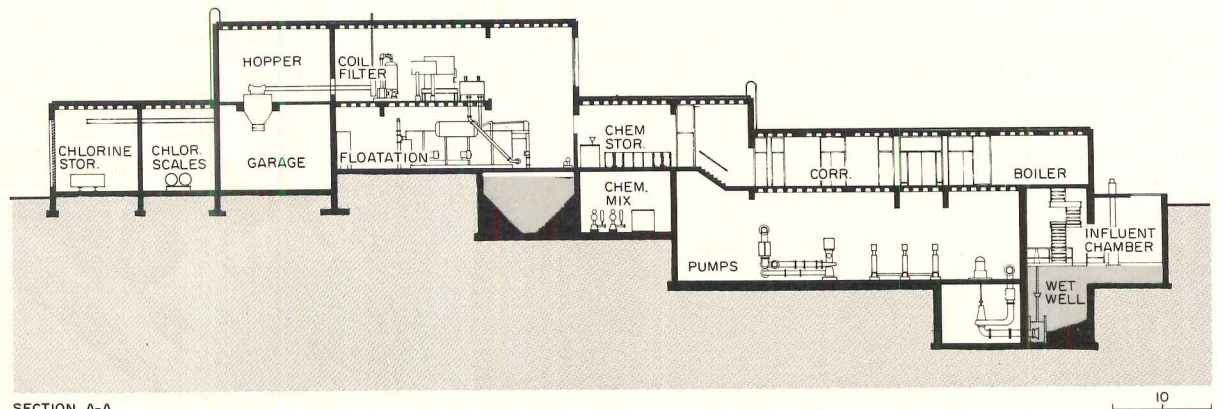

George Zimberg photos

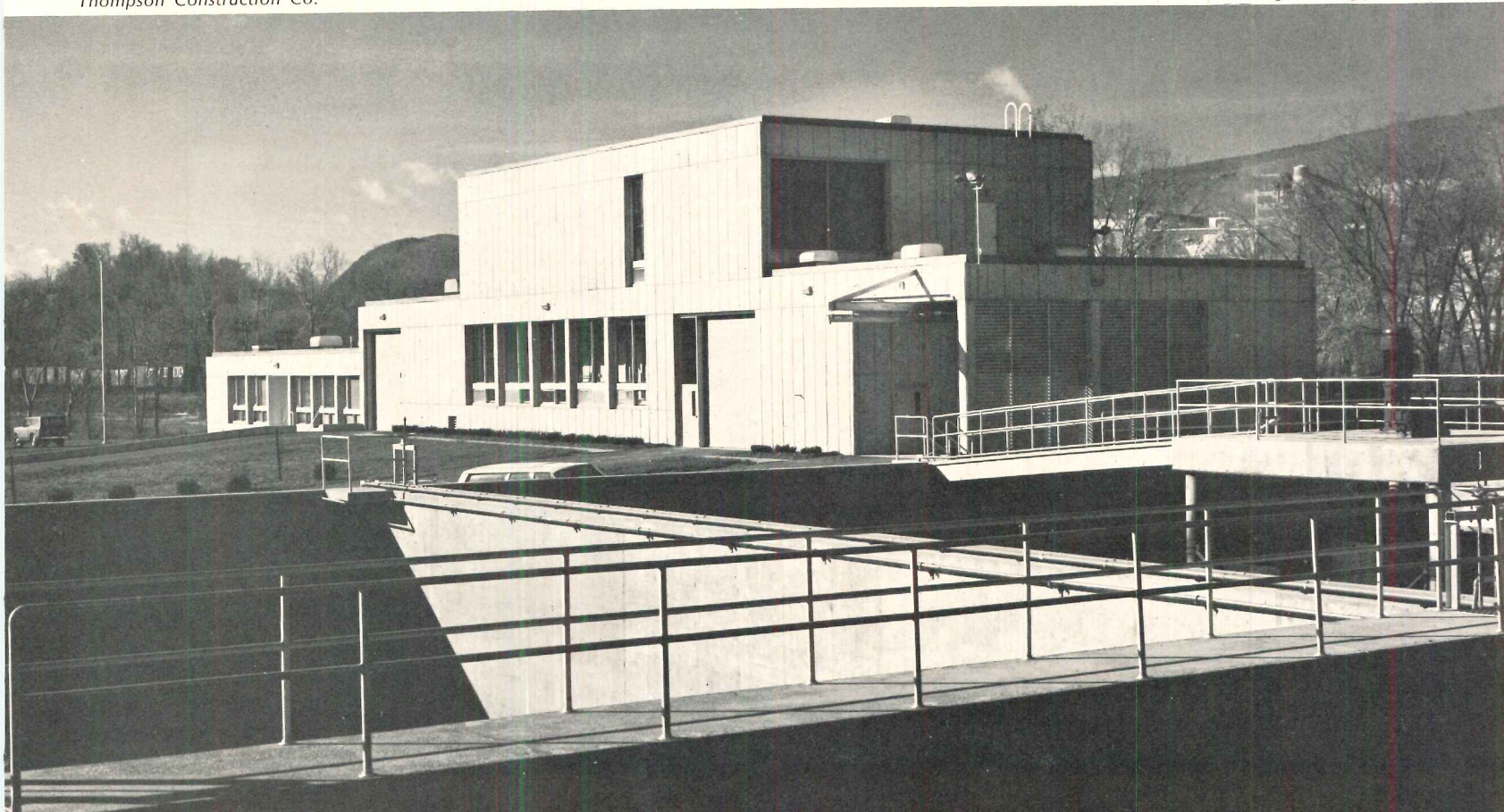

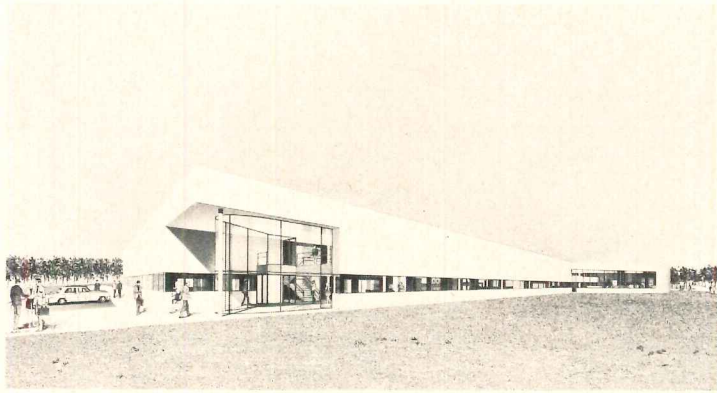

1

text continued from page 113

sire for goods. During the recent recession, when neither happened, industrial building dropped off by about 25 per cent. Now, if current projections hold up, industrial building is turning upward again. A new generation of plants and factories (photos right) is starting into construction.

They will almost certainly be safer buildings. Whether they will also be more agreeable workplaces, we cannot yet know. Powerful forces, economic and social, still mitigate against good design in industrial buildings. And many an owner is not really convinced that quality counts. He hires public relations firms and advertising agencies, and pays dearly for their services, but he sometimes forgets that, in the public eye, his building is an important clue to the character of his company and the quality of its products.

Industrial buildings need a great deal more attention from the design professions—especially in those areas that cannot be quantified in decibels or parts per million. Industry, after all, is a force that leaves a permanent imprint (and sometimes deep scars) on the landscape and the society in which it functions. Decisions made in industrial board rooms about new building programs profoundly influence town and city planning. They affect the employment patterns of millions of Americans. Through its products, industry alters our life styles and our ways of thinking about almost everything.

Unless the whole environmental movement is but a fad, borne aloft on a cross current of history, Americans are beginning to care, as they never have before, about the quality of their physical surroundings. The movement's main thrust, of course, has been toward pollution control, but the victories of the anti-billboard lobby and other champions of the visual environment cannot be scornfully dismissed. And a younger generation of workers, paralleling the experience of their college counterparts, is refusing to accept unwholesome factory conditions with the tired fatalism of the past. Have we arrived at a new standard? Not yet.

The design of industrial buildings also presents architects with a special opportunity. RECORD associate editor Robert Jensen, in an earlier piece on industrial buildings, observed that "economy, efficiency and clarity are the values on which (industrial buildings) should be based and these are just the values that modern architecture was invented to express." To these values we must now add environmental concern.

—Barclay Gordon

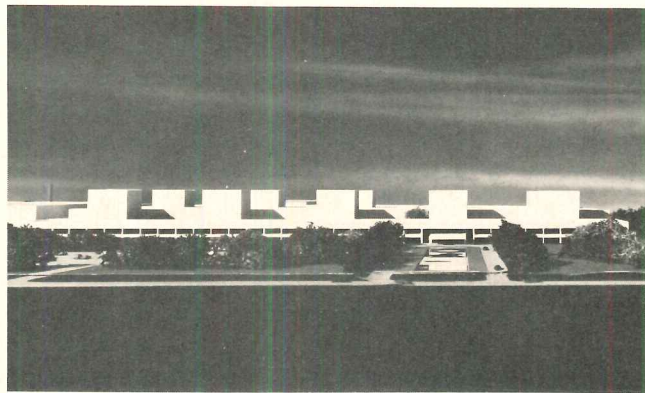

2

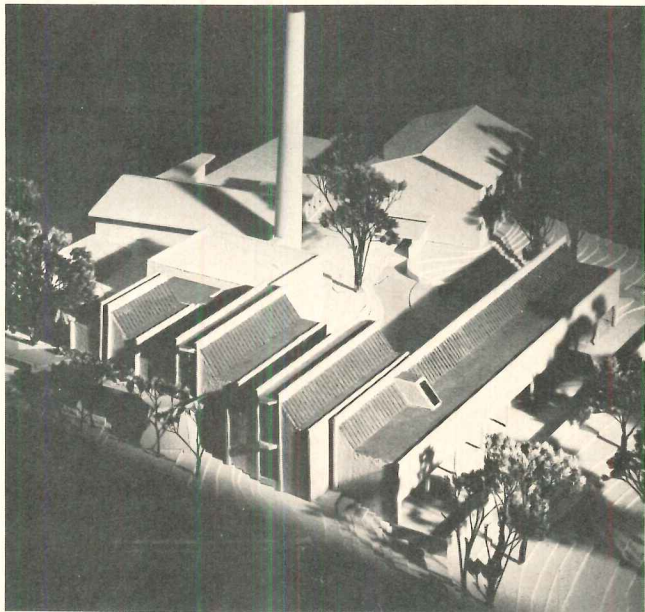

3

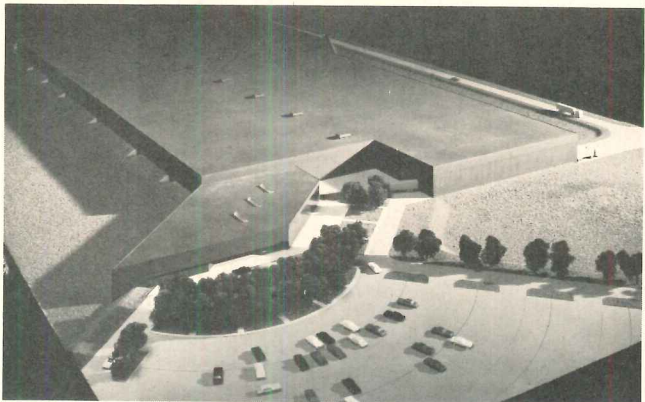

4

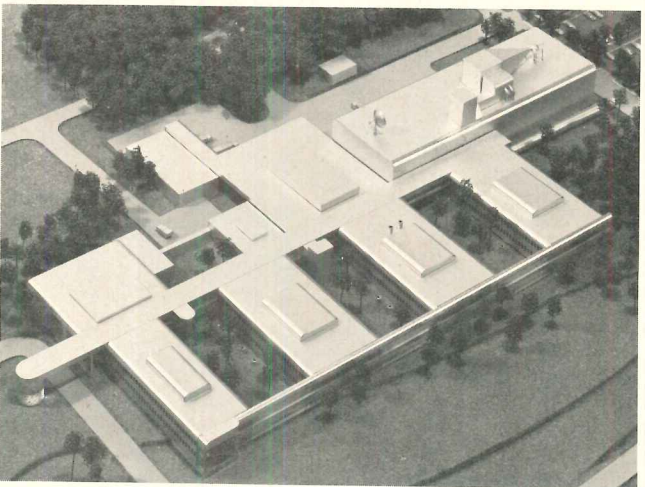

5

1. Charles Evans Industrial Building, *Richard Meier*, architect; 2. Philip Morris Plant, Richmond, Virginia, *Skidmore, Owings & Merrill*, architects; 3. Cathedral Greeting Card Plant, Washington, D. C., *Hugh Jacobsen*, architect; 4. Westinghouse Underground Transformer Plant, Jefferson City, Missouri, *Kivett & Myers*, architects; 5. Comsat Laboratories, Clarksburg, Maryland, *Daniel, Mann, Johnson & Mendenhall*, architects.

Technologically, the modern curtain wall has come a long way in 20 years. At the time the UN Secretariat and Lever House were built, a break was made from relatively simple window technology to curtain wall systems which have grown ever more sophisticated, and with which problems are significantly different. The behavior of curtain walls in warding off the effects of the weather is highly complex. They may look simple, but are far from it. Rather, they are involved assemblies of structure, metal and glass working, with much interrelationship and interdependence of elements. Further, there is much to know about finishes, and many subtle things to know about sealants. Yet, the know-how for the design and construction of curtain walls that will have a minimum of problems exists today.

Unfortunately, however, problems with curtain walls have not disappeared. Though some of the manifestations of problems—leakage, broken glass—remain the same as in the early days, the reasons for them are quite different. Twenty years ago little was known about the physical behavior of curtain walls; glazing gaskets were being used for the first time, and new high-performance sealants were introduced only after the putty type failed to work in new situations. Since that time vast knowledge has accumulated, and many new effective materials have been made available.

Curtain walls and the building process are more complex—so are the problems

So, why failures today? Mainly, the reasons are these:

1. The curtain wall has not been comprehended by designers as a system. For example, the deformation of a wall under wind loading may not be deleterious structurally, but on the other hand, this movement could open the glazing system to water penetration.

An architect might assume that any wall configuration should be possible. While this might be so strictly from a fabrication standpoint, it is not realistic with respect to resistance to water penetration. Some wall shapes literally invite the rain to come in. Thus there is a technical discipline—not just to be reckoned with, but perhaps even exploited in terms of design expression.

2. The realities of field tolerances and thermal expansion and contraction have not been taken fully into account. Columns

Solving today's curtain wall problems: comprehending them, and then providing expert attention

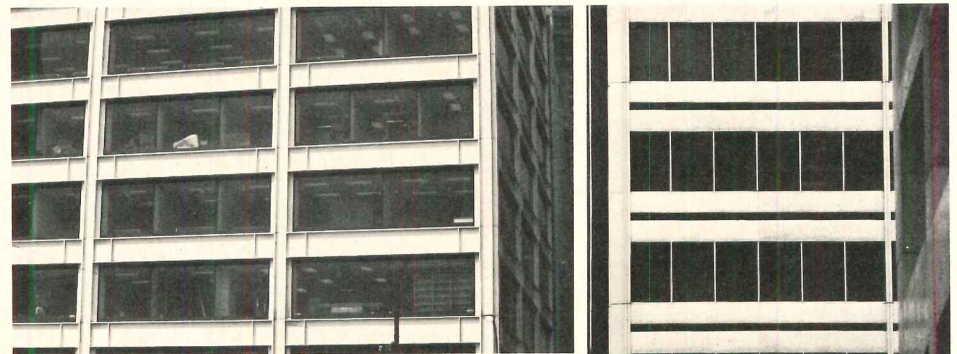

Practically every curtain wall is different. Even stock systems vary in some details from job to job. Custom designs are generally the rule in large, high-rise buildings, witness this random sampling of walls from office buildings on the tip of Manhattan.

Because curtain walls are complex assemblies of glass, metal, stone and concrete, steps need to be taken to minimize problems through: better understanding of the curtain wall as a system, appreciation of the influences of the market place, and recognition of field problems that affect design and specifications.

Not accounting for building tolerances can lead to trouble—for the wall, and for the glass.

If tolerances are not properly considered in the design of curtain wall anchorages, it may be difficult for the erectors to get glass openings plumb and square. When this happens, glaziers are tempted to trim the glass on site which reduces its strength, particularly with respect to thermal loading. Further, erectors may find it difficult to align the curtain wall components.

An example of a tolerance condition is this: it is accepted practice to permit steel columns to be off the building line as much as 2 in. out and 1 in. in with respect to the core; therefore, the column cover anchor must allow for this, and the floor slab insert and spandrel anchor must accommodate both spandrel beam deflection and column tolerances.

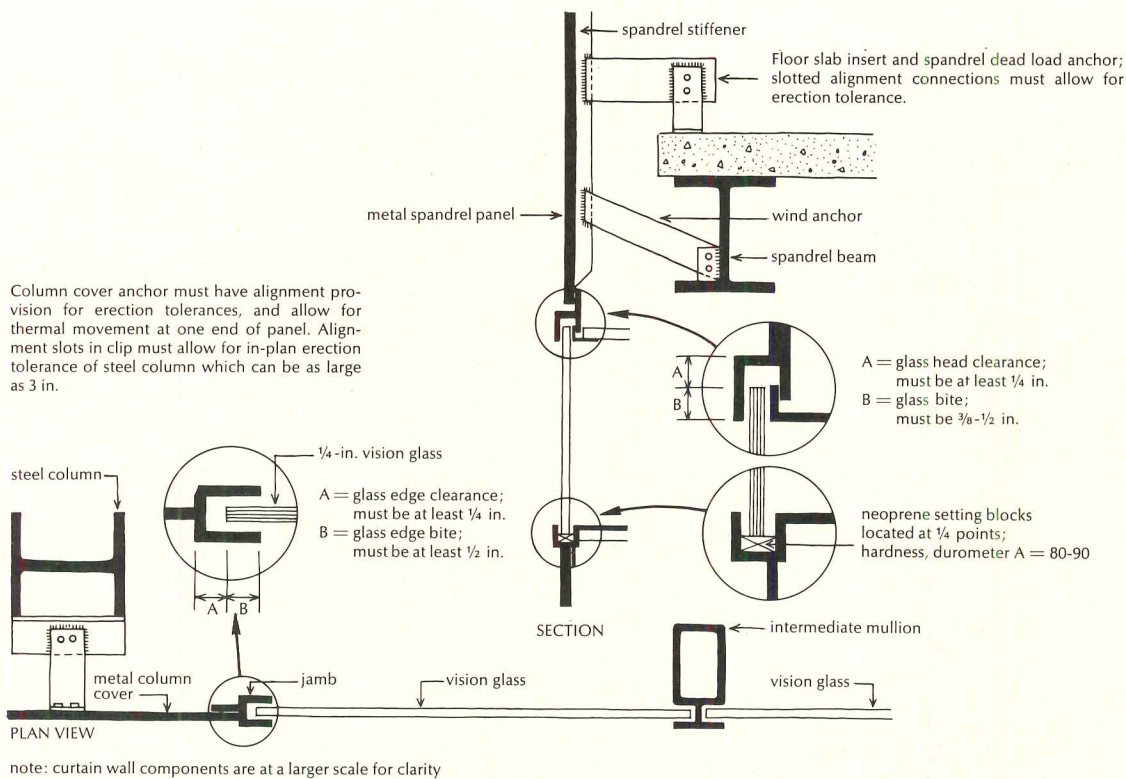

can be out of line by several inches; spandrel beams will have a certain deflection that may or may not be what was anticipated; glass, as cut, may vary slightly from the dimensioned size.

3. Structurally, curtain walls are being designed closer and closer to the loads they have to withstand in the field. In the early days, curtain walls were considerably oversized. Manufacturers, themselves, tended to be conservative because of inexperience in the engineering and fabrication of modern curtain walls. But by now they have a much broader experience. The main reason, however, for manufacturers designing and fabricating curtain walls closer and closer to minimum required strengths is that the market place has become much more competitive. Further, their factory and erection labor costs are much higher. So, walls are no longer conservatively designed; and there is less and less room for error in design load assumptions, for accommodating construction deficiencies, and for coping with unforeseen contingencies (such as the construction of a new building nearby that changes the wind load pattern).

4. The rush of owners to get buildings enclosed, occupied, and producing income may force subcontractors into poor construction practices. Because glazing openings may turn out to be neither plumb nor square, glaziers may resort to nipping corners and seaming edges in order to get the glass to fit, and in the process weakening the glass. The owner may accept, to his later chagrin, improperly erected sections of curtain wall rather than slow down construction.

As mentioned earlier, the two most

common failures associated with curtain walls are leakage and glass breakage, with the former being by far the more prevalent. Of course there can be other problems that have no potential physical harm to property or people, but may be disturbing psychologically — e.g., creaking and popping noises caused by movement of the curtain wall against the building frame; vibration of large panes of glass caused by wind; defects in the appearance of the curtain wall such as staining, lack of color match, oil-canning, show-through from the back of panel reinforcement, etc.

Glass failures can be dramatic, but are patently avoidable when care is taken

Aside from accidents, glass breakage occurs when it is overloaded by wind, or, in the case of tinted glass, when it is overstressed thermally; occasionally, the two effects can be combined. Apparently, most of the glass breakage caused by the wind occurs during the construction period, or at least after the first few wind storms. Glass strength is a statistical matter, and, when practical factors of safety are used, a small amount of breakage can be expected—say 8 lights in 1000. Thus, during the early life of a building, the lights termed “weak sisters” are broken and replaced. Thereafter a building in which the glazing has been properly designed should be relatively free of trouble.

As a safety precaution, owners of high-rise buildings being built in downtown areas of large cities may have streets blocked off on very windy days, to avoid passersby from being hurt.

But breakage during construction is probably more prevalent than it used to be. At least it is more noticeable. For one

thing, architects are calling for larger lights of glass and more of them. Further, it seems that the structure is hardly up when the curtain wall and its glass are installed, in part to enable other trades to work regardless of the weather. Thus it is easier for glass to be damaged by debris and through the carelessness of workmen.

(The strength of glass in resisting wind load is a function of its thickness and the polish of its surface; the glass is weakened by scratches and abrasions.)

Even undamaged glass can fail, however, if it is not properly supported. For example if the framing or gasketing that holds the glass can be excessively distorted, the glass may fail. If the gasket is too flexible because of shape, size, or insufficient hardness, a phenomenon called roll-off may occur, which may result in the entire light of glass being blown out of the gasket.

Glass breakage often is a direct result of proper erection practices not being followed, particularly with regard to handling and cutting of glass, and attentiveness in maintaining correct erection tolerances and plumbness and squareness of openings. It is often found in high-rise construction, particularly with stick-type curtain-wall systems, that tolerances for the building's structural system are greater than they should have been. Then, it turns out that glazing openings may not be plumb or square and that opening dimensions have not been maintained. The glazier's answer in order to get the glass to fit may be to trim the glass on the job which weakens it, particularly in its resistance to thermal load. And if a crack gets started in a light of glass because of thermal load, it can be more easily broken by wind.

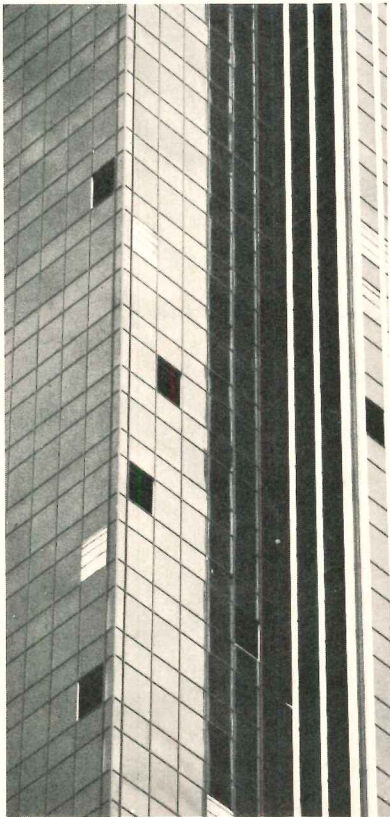

It's the unsuspected things that cause problems with glass breakage due to wind and to thermal load

Still not sufficiently recognized is the extent of negative wind loading at the corners of buildings—as much as 2.5 times the positive load on the windward side. This fact needs to be considered in the sizing of glass. If the glass lacks the recommended amount of bite, or is installed poorly, or gets damaged during installation, it obviously is much more susceptible to breakage at the corners.

The sketch at far right is a hypothetical example by Fazlur Kahn showing glass thicknesses based upon variation of wind load with building height and the wind load coefficients for both corner and interior areas of the facade. For practical reasons the glass thickness would be constant for a given floor.

Shading of tinted glass by building projections can result in high stresses. If the edges of glass are damaged, its strength to resist these stresses is lowered.

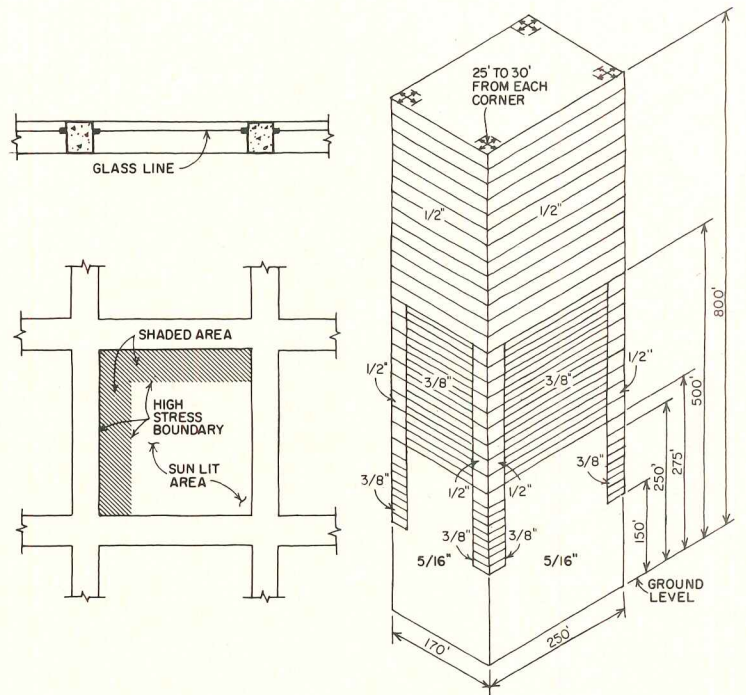

The result of proper tolerances not being maintained may be that some lights of glass do not have sufficient bite provided by the glazing pocket or gasket, perhaps only $\frac{1}{4}$ in. or so. Such lights are susceptible to wind damage.

Another common cause of breakage of glass during the construction period is that the glass lights may not be fully glazed in the beginning by the contractor. That is, the glazing system may be such that he can safely support the glass in the glazing opening, under normal conditions, without having fully installed all glazing materials—the sealant that goes in the rabbet, or the zipper that goes in the neoprene gasket. The glazing contractor might not finish the job for months. Because the glass is not tightly held, a high wind may blow out some of the glass.

When glazing openings are out-of-square, all sorts of makeshift arrangements may have to be resorted to—jacks to try to force the opening into square; torches to alter anchorages, specially cut glass to fit the openings, side-shimming of glass in an out-of-square opening to maintain proper bite on all edges.

Because of lack of control of opening dimensions, some buildings have suffered continuous glass loss for a year or more until all the glass that may have been nipped or cut on the job to make it fit was replaced.

Field problems are the most common, but occasionally the design is marginal

Obviously the proper installation of glass is a critical factor in obtaining designed-for strength. For example, glass-to-metal contact in the glazing rabbet can result in point

loading that causes glass to break. To avoid this situation a clearance of around $\frac{1}{8}$ in. should be maintained between the face of the glass and the face of the glazing stop. Face shimming is required in lights of glass over 100 united inches (i.e., total perimeter) in size. It is difficult to install intermittent shims properly so that they work, so a continuous face shim is frequently used, consisting of a relatively hard butyl tape that will not distort, or a softer tape that has a hard core.

There may be faults with the curtain wall components, themselves, that interfere with proper installation of glass. For example, it sometimes happens that welds are not ground down in glazing pockets. Occasionally a wrong component is supplied—such as a different clip than intended being used to hold a curtain wall panel to a mullion, causing glass to metal contact.

Field problems, however, are the more prevalent. A further example is that of welding spatter which can seriously damage glass if it is unprotected. The New York City building code calls for glass to be protected by a hardboard covering or its equivalent where glass may be close to welding operations or near material hoists (temporarily omitting the glass is another solution).

Sometimes field conditions combine to create difficult glazing conditions. Example: glazing opening too small; glass a little large; weather cold; glazing pocket minimal for esthetic reasons. Invariably, it seems, tolerances seem to accumulate against the installer. If glazing is done in cold weather with gaskets, and the glass is slightly large, the glazier is tempted to seam (file) the edges to avoid tearing the gasket.

Occasionally, particularly on "budget" jobs, everything can go wrong, resulting in extensive loss of glass. Design can be in error (with respect to tolerances and glazing techniques); fabrication can be faulty; installation can be poor. It is known that, under these circumstances, one owner had to replace 30 per cent or more of the glass that may have cost, after the fact, 50-60 per cent of the original cost of the wall.

Again, on "budget" jobs, the design may be so skinned down, that the wall itself is not strong enough to hold the glass. When the wind blows hard, the results may be catastrophic. A high-rise apartment building in the Midwest is known to have lost over 100 lights of glass during a winter wind storm, reportedly because the wall was not strong enough.

When sizing glass thickness, the designer must know the loads, consider the support

Once in awhile the glass that the designer selects is not thick enough for the most severe loading conditions to be encountered. Under optimum circumstance (i.e. proper bite, clearance, etc.), the glass might have been strong enough, but then, because of the way it was installed, the glass was not able to work to capacity.

On the other hand, the actual extent of the wind load on the glass in service is not always accurately predicted, particularly the negative loads created at corners of buildings which may be as high as 2.5 times the direct, positive load of the wind on the windward face of the building.

As is so with other aspects of building, occasionally there is the tendency to use values required by code (which are usually minimum) for design purposes. These

values may seem reasonable enough to a designer—who says to himself that a 30 lb per sq ft load is equivalent to a 100 mph wind, and, furthermore, he is aware of buildings in the vicinity that have used this value and weathered many a storm. But maybe the building he is working on has a number of re-entrant corners; maybe the building is in an unusual environmental situation (perhaps a canyon effect with wind); maybe adjacent buildings create an unusual loading condition. He may, therefore, be taking a much bigger risk than he realizes.

Though glass is not a ductile material such as steel, nonetheless like a steel plate it has its greatest capacity under load if it is supported along four edges. A number of recent buildings have used large lights of glass with butted edges and no intermediate mullions, the joint being sealed with silicone, to give the appearance of huge, unbroken expanses of glass. Obviously glass used in this way has less capacity than if it were uniformly supported along four edges, and, consequently the glass has to be quite a bit thicker.

The other cause of glass failure, mentioned earlier, is thermally-induced breakage that occurs with tinted, solar-heat-absorbing glasses when the edges have been damaged during installation, or in service, and particularly when there are uneven stresses caused by partial shading of the lights. This kind of failure is potentially less hazardous to passersby because the cracking can be noticed by building occupants or maintenance personnel, whereas glass failures caused by wind can come without warning.

Obviously, the more heat absorbent the glass, the higher the stress induced by the heat of the sun. Light-reflective glasses are loaded even more severely than the tinted heat-absorbing glasses because the reflective coating is on the air-space side of the inner light of a double-glazed unit. Thus, because more heat is trapped due to the "greenhouse effect," such glass can get hotter than ordinary tinted glass. Special consideration should be given to this problem with very large lights of glass.

The wind produces capricious effects on buildings, but they are predictable

Most glass and curtain-wall failures caused by wind have occurred in tall high-rise buildings. But engineers have the design tools to properly design glass; not perfectly, but satisfactorily—according to Leslie E. Robertson, partner in the consulting engineering firm of Skilling, Helle, Christiansen, Robertson, structural engineers for the World Trade Center and for the U.S. Steel Building. Analysis and design can be done for a building that can provide the same level of strength for all lights of glass, rather than having some strong and some excessively weak. Predictions of breakage rates will be reasonable. Technology does not preclude a reasonable design, says Robert-

son; validity is sufficiently high.

With buildings of unusual configuration, or buildings that are particularly large, Robertson feels that wind tunnel testing may be advisable. For a few thousand dollars, he says, a wind tunnel test can be performed from which wind loads can be predicted. The engineer can develop a good glass design with respect to strength that is rational and that seems to work. The cost of the wind tunnel testing and the resultant design of the glass may represent a cost savings or a cost increase from design by experience; in any case, according to Robertson, neither would be significant in terms of total building cost.

Obviously some discretion has to be exercised as to when wind-tunnel testing should be used. With many tall buildings that are not out of the ordinary, the range of pressures that can be expected are pretty well understood. An engineer can look at what has been done on other structures and have a reasonable understanding of what to expect, particularly when there are no remarkable differences between buildings. The designer must remember, however, that wind speeds in Florida are going to be higher than those in Los Angeles, and that wind load pressures are velocity-dependent to the second power. If you put the same glass design in both locations, you will have a problem.

An interesting phenomenon of wind with respect to glass breakage is that this is only partly associated with steady-state pressures. Actually, there are rapid fluctuations in pressure which are associated with the separation of flow of wind from the face of the building and reattachment of the wind to the face; the reattachment line fluctuates rapidly back and forth depending upon the angle of attack of the wind and the building configuration—corners, indentations in the facade, etc. Glass breakage seems to be associated more with fluctuating pressure than steady state pressure. Though glass behaves stronger the faster it is loaded, the fact that pressures are velocity-sensitive to the second power, means that a small increase in velocity produces a big increase in pressure.

Historically, the glass breakage problem has been recognized and considered in the design process. The same is true for leakage—there is a lot of expertise on how to keep out water, and many solutions are incredibly ingenious. What is not really known, however is how the large number of curtain walls erected in the last 10 years will behave under the catastrophic loading of the eastern seaboard's hurricane winds. For large, special buildings, mock-up walls are loaded in the laboratory to a presumed wind-load condition. On other buildings the calculation of strength could be described as more or less casual. Furthermore, there often are large differences between what is shown on the drawings and what is actually installed.

Owners generally buy curtain walls on

the basis of a performance specification along with certain profile information prepared by the architect. The specification probably says very little about "hardware," i.e. anchorages, etc., and sizes of supporting members. The fabricator then produces a technical design. He basically accepts the responsibility for the wall resisting the forces of nature. If something goes wrong and the manufacturer is a reputable one, presumably he will fix the deficiency.

Shouldn't responsibility for structural integrity be given more careful thought?

But if there were, say, a large number of failures during a catastrophic hurricane, what might the courts find? Perhaps they might find that because of so many failures, a norm had been established. On the other hand, how can non-professional organizations establish norms and standards? The norm is what the norm is, and maybe it was not good enough. Who in the end has to accept the financial responsibility?

Analysis of the basic structure of many types of curtain walls is simple applied mechanics.

Structural design of many types of curtain walls (stick systems, for example) is straightforward, easy to understand.

But very substantial safety factors should be used in the design of connections to allow for fatigue problems, corrosion, etc. With custom curtain walls, however, it is possible to overlook design problems by not clearly thinking through how they really work (particularly when there are conditions such as stone, glass, metal intersections; huge metal panels, etc.). These are areas where the structural engineer could get more deeply involved. Structural engineers with experience in tall buildings ought to be able to review the structural strengths of curtain wall components. The trouble, of course, is fees; current architectural fees do not want to bear this cost because now this cost is borne outside. Further, engineers would have to take on responsibility in terms of costs, contingent liabilities, etc. The courts feel that when architects or engineers "dabble" in design, they must take the responsibility for it.

How wise is it to continue to leave the responsibility for technical design and performance with the manufacturer? First of all, who else is there to do it? But is a better discipline needed within the industry? The industry is tremendously large, and there are many firms in it. What can be done to help ensure that all firms act responsibly? Trouble is it is easy for a firm to go into the business because not much capital is required, at least for the common types of curtain walls. There tends to be a big turnover of companies; and there are those who do not have a good over-all knowledge of the field. Further, even the better companies have difficulty in finding competent technical personnel today.

(to be concluded next month.)

The first really new library furniture

Introducing...
ES/II MEDIA CENTER
By American Seating



Multi-media storage.

System design
and what it means

"System" implies a group of components forming a whole, and that's exactly what Media Center is . . . a complete modular concept in library furnishings, now available for the first time!

Each component, without exception, relates to the others: Dimensionally, functionally, design-wise . . . *and* aesthetically. Components are all interchangeable and relocatable! Layouts can *change* as your needs change. Rearrange storage areas, traffic patterns, study, staff and lounge areas, not after the contractors are finished with their work . . . but as the need arises!

Shelving integrated with study carrels.



design in in 50 years!

Relocatable card catalog assembly.



Relocate, interchange, expand, contract . . . experiment, experiment again . . . because Media Center is designed and built to provide the maximum in flexibility.



Periodical reference grouping.

What it means for you
Cataloging and storage? Today's library must handle far more than just printed materials. New and varied A/V equipment calls for new and innovative approaches. With Media Center you've got the finest provision for management and storage available today! Uniquely designed newspaper racks, magazine display racks, display cases, storage for records, cassettes, film strips, microfilm, movie screen storage . . . all are incorporated in Media Center components.

And because of Media Center's system design, you can specify with complete confidence, *knowing* that today's needs will be satisfied as well as the needs of tomorrow and the years to come!

The means and the end

Media Center really *is* the first new design in library furniture in fifty years. It's the systems approach that does it, that gives you,

for the first time, the means with which you can provide the best in modern library service!

Moreover, all the Media Center units are completely interchangeable with other American Seating systems. And because Media Center is the *complete* system, you avoid the confusion (and look of confusion) of having

to piece a library together by having to buy furnishings from five or six different manufacturers.

American Seating has it all . . . with ES/II Media Center. And you, your school . . . should have it, too! *For descriptive brochure, write: American Seating Co., Dept. AR-749, Grand Rapids, Mich. 49504.*

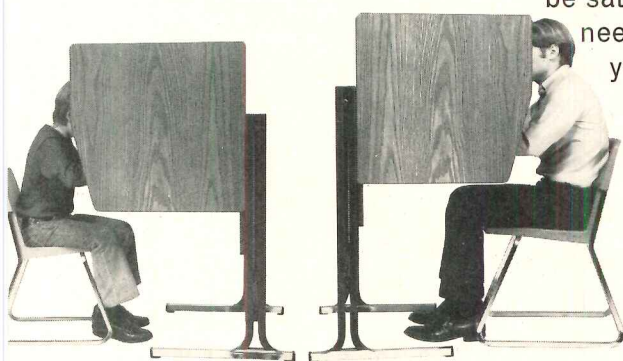

Study carrels meet both elementary or secondary school physical requirements.



Sloped-top reading table.

Charging desk assembly.

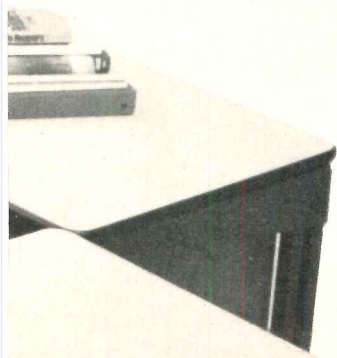

ES/II
EDUCATIONAL SYSTEMS
MEDIA CENTER

For more data, circle 61 on inquiry card

PRODUCT REPORTS

For more information circle item numbers on Readers Service Inquiry Card, pages 205-206



MODULAR FURNITURE GROUP / Squares and quadrants which can be grouped into a wide variety of configurations form the basis of this system. Floating back and arm sections lock securely in place with concealed steel connections, elimi-

nating dust-trap pockets between seat and back. Covers can be replaced in minutes and are available in a range of materials and colors. Furniture is made of steel reinforced "self-skinned" urethane foam clad in a coat of dacron. All materials

are virtually maintenance-free.

Table coordinates come in seven sizes and two heights to align with seats or backs. ■ Harvey Propper Inc., Fall River, Mass.

Circle 300 on inquiry card

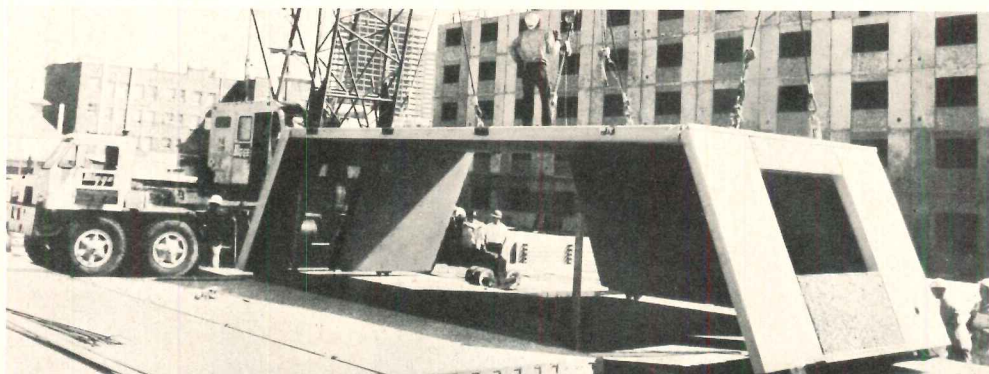

CONCRETE STRUCTURAL SYSTEM / Hinged concrete structural elements poured at the construction site are cured. As units are individually lifted, hinged components fold to desired posi-

tions, and entire unit is placed on the building. No costly forms are required. ■ Foldcrete International Inc., Columbus, Ohio.

Circle 301 on inquiry card

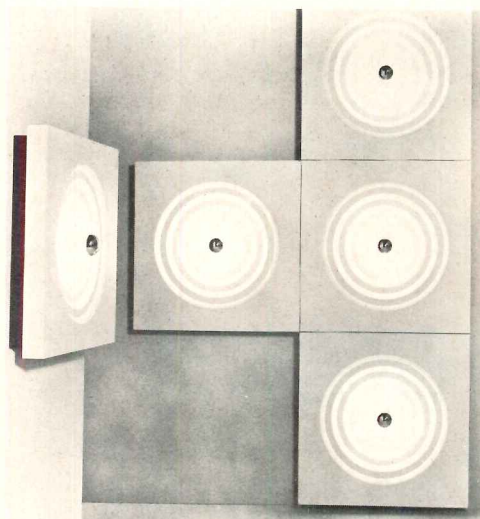

LIGHT SCULPTURE / Bull's-eye design can be mounted on ceiling or wall. ■ Lightolier, Jersey City, N.J.

Circle 302 on inquiry card

CONTOURED GLASS / Window panes reflect light without distorting objects seen from either side. Edges measure as specified at corners. Panes can be glazed into any type of window frame using standard procedures. Amount of light passing through panes is identical to that of flat window glass of the same type. ■ The Vexocave Co., Morrison, Colo.

Circle 303 on inquiry card
more products on page 147

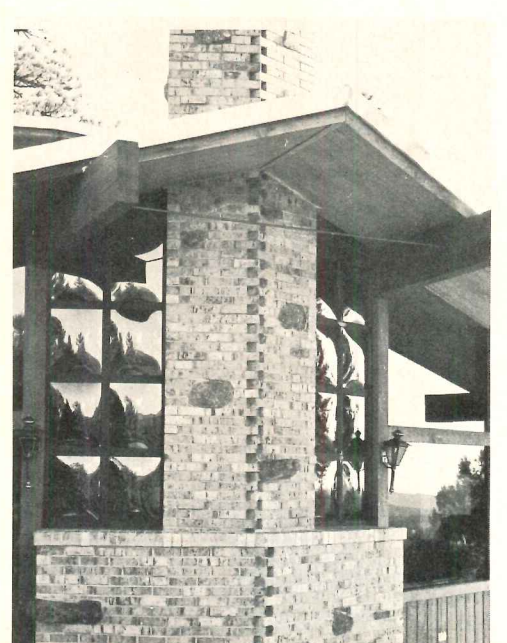

The Winners

1972 Plywood Design Awards

Jury comment: "There is no question that plywood is the building material of our time in the field of wood construction. Economical, light of weight, both structure and skin, bearing its own innate finish. A simple sheet of plywood fulfills the ultimate dictum of organic design. Form and function are one."



Commercial/Institutional Buildings Top Award \$1,000: Douglas Barker (Smith, Barker, Hanssen, San Francisco). Project: Corte Madera Regional Branch of the Marin County Public Library, Corte Madera, California.

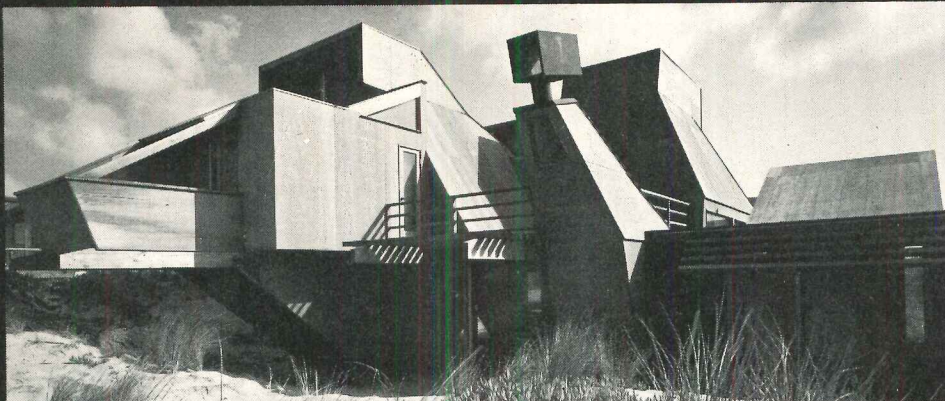

Residential/Single-Family Buildings Top Award \$1,000: William Logan, AIA, (Neil Nott, Mike Lee Associates, Palo Alto, Calif.). Project: House at Pajaro Dunes, Watsonville, Calif.

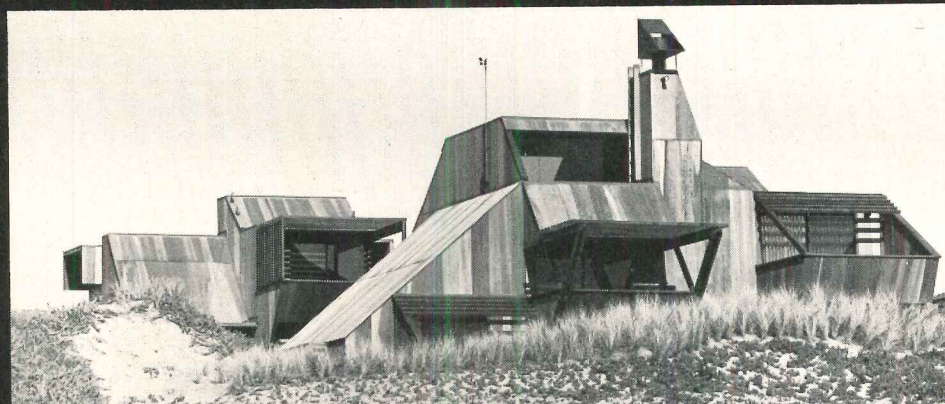

Vacation Homes Top Award \$1,000: William Logan, AIA, for another house at Pajaro Dunes.

"A remarkably well-detailed space frame. Its 'sawtooth' roof system frees the flexible interior spaces of internal supports and floods them with natural light."

"A superb example of plywood used as the basic material throughout the building — not just as a skin."

"Although the forms are many-faceted, there is an underlying unity that gives this structure a great sense of repose."

For information on the winners and citation awards, write 1972 Plywood Design Awards, American Plywood Association, Dept. AR-052, Tacoma, Washington 98401.

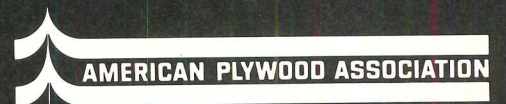

Plywood quality-tested by the Division For Product Approval.



For more data, circle 62 on inquiry card

PPG SOLARBAN[®] TWINDOW[®] INSULATING GLASS

PPG Performance Glass creates a beautiful, comfortable corporate home for Burlington Industries.

This new headquarters building nestles in a parklike setting—"a glass cube suspended in a steel cradle."

The architect selected PPG's *Solarban 575 (2) Twindow* Insulating Glass to complement and reflect the massive structural steel shapes. And in doing so, he was also able to ensure optimum performance values for the owners. From indoors, the glass reduces brightness of sun, sky and

clouds. So visual comfort is increased. In addition, the exceptional ability of *Solarban Twindow* Units to reduce solar heat gain and conducted heat loss results in substantial reductions in heating and air conditioning equipment costs.

See PPG about *Solarban Twindow* Glass—or the others in our family of Performance Glasses for your next building. Early in the design stages.

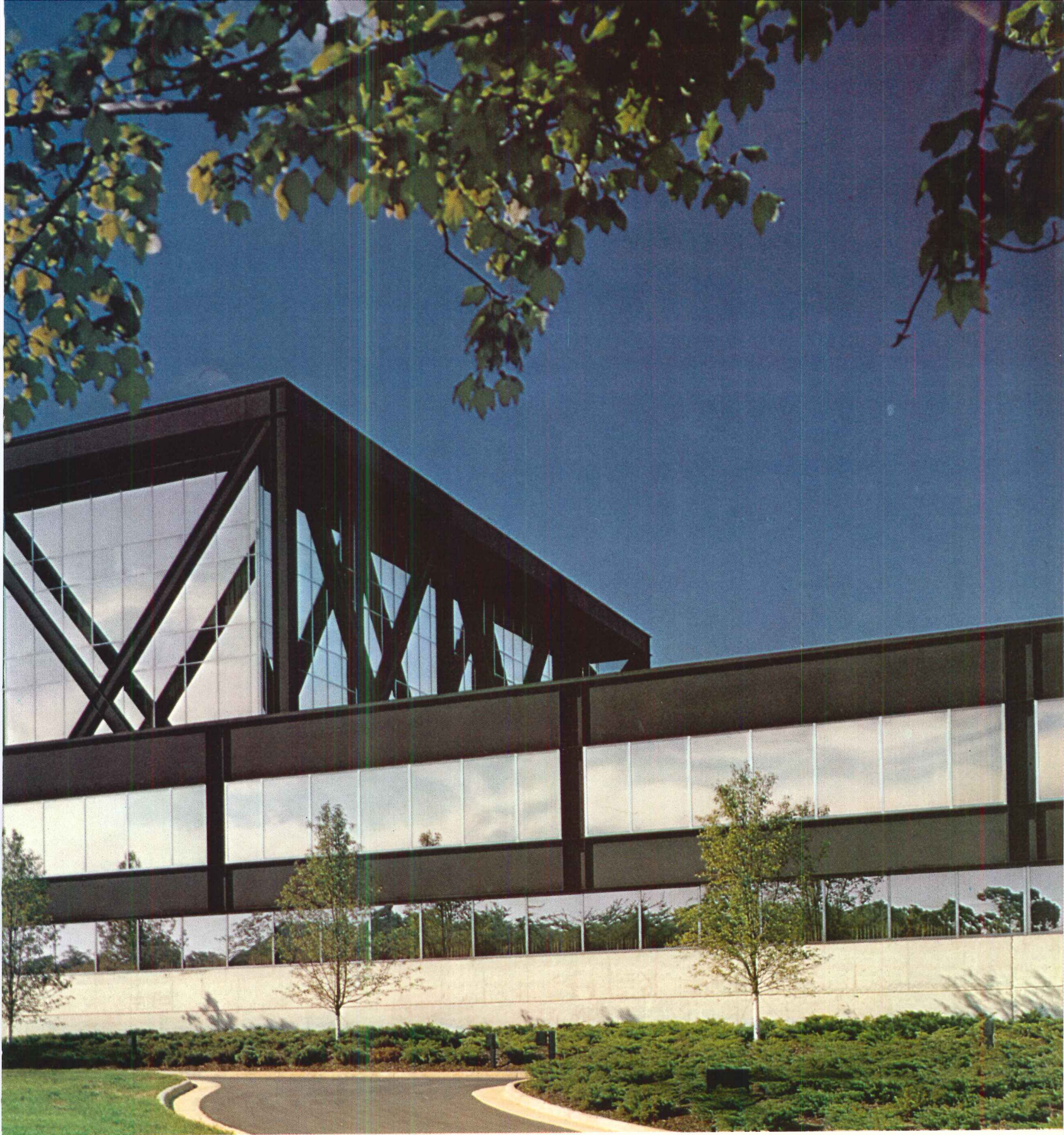

There's a PPG Glass that you can use as an active design medium to meet esthetic considerations, increase occupant comfort and contribute to a return on investment.

Write PPG Industries, Inc.,
One Gateway Center, Pittsburgh,
Pennsylvania 15222.

Owner: Burlington Industries, Inc., Greensboro, N.C.
Architect: Odell Associates Inc., Charlotte, N.C.

PPG: a Concern for the Future



For more data, circle 63 on inquiry card



MILSTAR Corporate Squares at The Chatterbox Restaurant in Jefferson Square office building and shopping center complex, Columbia, S. C.

Milliken revolutionizes restaurant carpeting with loose-laid **MILSTAR** Corporate Squares

MILSTAR is the totally new concept in commercial carpeting developed by Milliken Research. Now in 18" carpet tiles it supplies a combination of innovations never before available for restaurants:

Longer Wear. Pile is fuse-bonded into vinyl plastisol, providing resilience and wear equal to or better than the finest tufted and woven constructions. Tuft lock is superior to any other cut pile construction.

Less Maintenance. Impermeable soil barrier back traps dirt on surface, contains spills in pile, makes cleaning easier.

Quick-Change Efficiency. MILSTAR Corporate Squares are dense-pile, snug-fitting, loose-laid tiles that need no adhesive. When spillage occurs soiled tiles can be replaced immediately by clean tiles on reserve. Results: Spilled food isn't tracked over carpet; maintenance cost is reduced; floor stays clean and attractive. Soiled tiles, easily cleaned, return to reserve.

This quick-change artistry is practiced successfully at The Jefferson Square Chatterbox Restaurant, shown above. Additional benefits: The carpet is anti-static, fade-resistant, with pile of 70% solution-dyed Acrilan® acrylic fiber and 30% super lightfast nylon. In numerous solid and coordinated tweed colors, MILSTAR Corporate Squares offer limitless possibilities for dramatically patterned floors. For details, call or write Deering Milliken, Inc., Contract Carpet Manager, LaGrange, Georgia 30240. (404) 883-5511.

For more data, circle 64 on inquiry card



MILLIKEN

Floor Covering Business, LaGrange, Ga.

continued from page 136

FIBERGLASS PLANTER / One-piece unit will not leak. Colors offered are sandy white, gold, coral, brown and black. Planter is 18 in. in diameter and 19 1/8 in. high. Weight is 8 lbs. Square and hexagonal styles are also available. ■ Duk-It, Div. McDonald Products Corp., Buffalo.

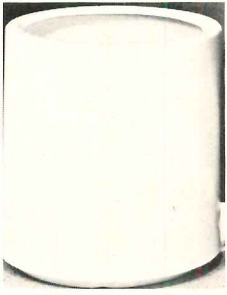

Circle 304 on inquiry card

CENTRIFUGAL FANS / Packaged, direct-drive units are available in 12 sizes and are suitable for supply and exhaust ventilation in commercial and industrial buildings. Advantages include high efficiency over a broad operating range, minimum maintenance, and sealed-seam construction providing airtight joints and exceptional rigidity. ■ ILG Industries Inc., Chicago.

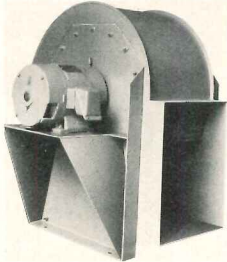

Circle 305 on inquiry card

ADHESIVE / A method of sealing joints in pre-cast panels uses a special adhesive plus an extruded plastic tape. When installed as shown, tapes comprise a "built-in" silicone slip joint. After joints are completed, panels are ready for concrete topping. No special equipment is needed. ■ Parr, Inc., Cleveland.

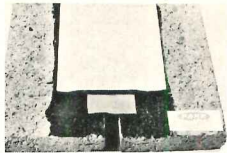

Circle 306 on inquiry card

GAS CHILLER-HEATER / Air-cooled unit produces cold water for cooling and hot water for heating and is designed for residential and small commercial installations. Changeover from heating to cooling can be accomplished in five minutes. Units are available in 3-, 4-, and 5-ton chillers with matching capacity water heaters. ■ Arkla Industries Inc., Shreveport, La.



Circle 307 on inquiry card

PORTABLE CHURCH FURNITURE / Pews are available in sizes ranging from 3 to 7 ft wide, and can be purchased factory assembled or knocked down for on-site assembly. Kneelers, bookracks, cup and card holders are available. ■

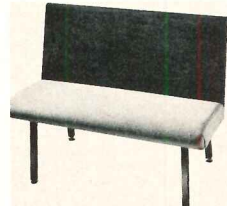

Endicott Church Furniture, Winona Lake, Ind.

Circle 308 on inquiry card

OUTDOOR LIGHTING / Luminaire features a pyramid-shaped reflector which directs a wide beam of light below eye level to illuminate walks, courts, and other open spaces. Aluminum cube with bronze finish protects fixture with thick acrylic windows. ■ Lightolier, Jersey City, N.J.



Circle 309 on inquiry card

more products on page 150

We're doing something about industrial waste.

Ever increasing amounts of industrial waste and more stringent refuse incineration regulations have forced many companies to seek alternative solutions for waste disposal.

Belgium Standard's large capacity, high volume refuse compaction system can provide the answer.

Refuse fed into the compactor by hand or through strategically located garbage chutes is compressed down to one-quarter of its original volume and packed into easy-to-remove twenty to forty cubic yard metal containers.

Belgium Standard Compaction Systems eliminate toxic emissions caused by incineration, are easy to install and operate virtually maintenance free.

We're doing something to alleviate the problems of industrial waste.

Now it's your turn.

Fill out the attached coupon and mail it today

Patent No. 849268, 1970

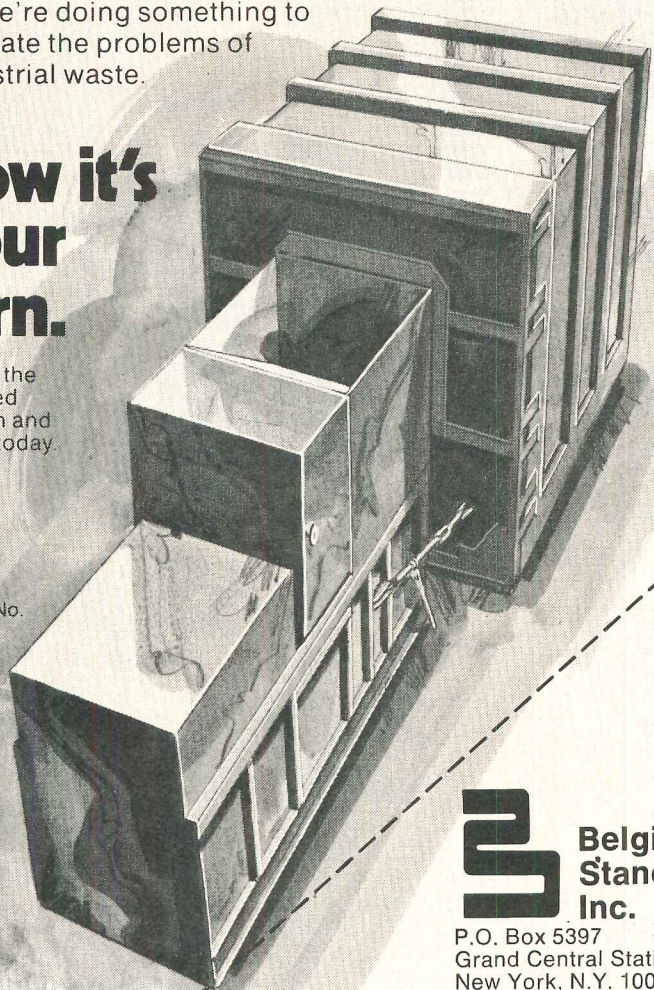

Belgium Standard Inc.

P.O. Box 5397
Grand Central Station
New York, N.Y. 10017

- Please send me further information about Belgium Standard Industrial Compaction Systems.
- Please have a systems specialist call me for an appointment.

NAME _____

ADDRESS _____

TELEPHONE _____

AR

For more data, circle 65 on inquiry card



BRUNING: A SINGLE GRAPHIC SOURCE

For convenience, we win by a "nose."



If it's at all going to live up to its name, a convenience engineering copier should be as easy on your nose as it is on your legs.

Our PD-80, like some other conventional copiers, is mobile enough to go just about anywhere in the office. So it saves a lot of steps.

Unlike all other conventional copiers, the PD-80 doesn't use ammonia. So it eliminates fumes and odors. And your nose never knows there's an engineering copier nearby.

It also eliminates warm-up time. "Instant On" insures that the copier is ready whenever you are.

Finally, our PD-80 convenience copier can be rented for under a dollar a day.

To convenience, add capacity. The PD-80 can handle prints up to 42" wide. Which makes it perfect for quick architectural prints, engineering satellite prints, even check prints.

For more information or a demonstration in your office, call your Bruning Representative. Or write to Bruning Division, Addressograph Multigraph Corporation, 1555 Times Drive, Des Plaines, Illinois 60018.

Whichever is most convenient.

continued from page 147

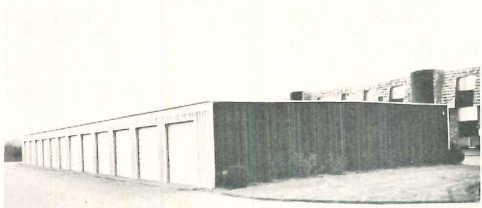

PRE-FABRICATED GARAGE STRUCTURE / Columns, framing and structural roofing and siding panels are cold-formed from high-tensile steel and heavily galvanized with zinc to provide a maintenance-free structure. Panels are furnished unpainted or with baked finish available in a choice of colors. Structures are designed for the apartment and townhouse market. ■ Childers Mfg. Co., Houston.

Circle 310 on inquiry card

CONTRACT CARPET / Dense, nylon cut-pile is especially designed for public areas subjected to heavy traffic. ■ Philadelphia Carpet Co., Cartersville, Ga.

Circle 311 on inquiry card



BRICK-MAKING PROCESS / Bricks shown here are the result of a patented manufacturing technique in which an aggregate of inorganic waste material is mixed with small quantities of Portland cement and common chemicals, then pressure-molded into finished bricks. No thermal processing is required. ■ Certain-Teed Products Corp., Valley Forge, Pa.



Circle 312 on inquiry card

CARVED WOOD PANELS / Applications include walls, doors and furniture. Created by architect Sherrill Broudy and sculptor Daniel Moran, subtle sculptured forms are carved in all-heart redwood. Module panels are 9 in. wide and 36 in. long, and have a tongue and groove detail for easy assembly. Other lengths and hardwoods are available. ■ Forms & Surfaces, Santa Barbara, Calif.

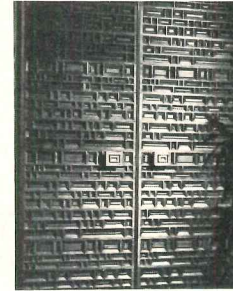

Circle 313 on inquiry card

MICROFICHE READER-PRINTER / Available with 18x and 24x standard lenses at \$695.00 (and 32x, 42x, and 48x optional lenses), this model gives a brilliant image on a high-contrast 12 by 12 screen with constant, uniform focusing. It delivers a dry electrostatic print in 10 seconds. Paper is easily loaded using cassette rolls. ■ Micro Information Systems, Inc., Atlanta.



Circle 314 on inquiry card

FIBERGLASS REINFORCED PLASTIC PANELS / A pre-fabricated framing system utilizing polyester panels reinforced with fiberglass from PPG Industries, and extruded aluminum support sections is available. The extrusions are fastened with metal pins and clips into a strong, unitized support network. Panels and trim, manufactured by Williams Bermuda Corp., Alhambra, Calif., are snapped into the metal framing. ■ PPG Industries, Inc., Pittsburgh.



Circle 315 on inquiry card

HEATING/COOLING ROOFTOP AIR CONDITIONER / For quick, low cost installation, the company offers a roof-curb which can be installed as an integral part of the roof structure, eliminating the need for further weatherproofing at the jobsite. All utility connections can be made within the confines of the curb. Factory-assembled units are ready for on-site operation. Four sizes ranging from 20 to 40 tons cooling capacity in five basic models are offered. ■ The Trane Co., La Crosse, Wis.

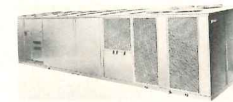

Circle 316 on inquiry card

more products on page 156

At last ... something really NEW for

SOUNDBLOX



SOUNDBLOX[®]
Patented
Sound-Absorbing Structural Masonry Units

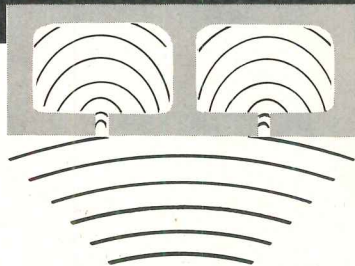

attractive, economical
for indoor/outdoor
construction

SOUNDBLOX units derive their excellent sound absorption from a slotted construction which allows the closed-top cavities to act as damped (Helmholtz) resonators—the same principle used in automobile mufflers. They have many advantages: exceptional low-frequency sound absorption, rugged durability indoors or out, superior sound transmission loss and moderate cost.

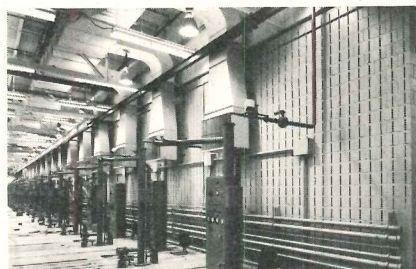

Engine Test Facilities, General Motors Corporation, Detroit Diesel Engine Division. Architect: Argonaut Division, G.M.C.



Gymnasium, William and Mary College, Williamsburg, Va. Architects: Wright, Jones & Wilkerson, Richmond, Va.

S For technical information see 1971 or 1972 Sweet's Architectural or Industrial Construction Files (9.1/Pr) or phone us collect at the number below.

The Proudfoot Company, Inc.
ACOUSTICAL PRODUCTS
P O Box 9, Greenwich, Connecticut A/C 203 869-9031

For more data, circle 67 on inquiry card

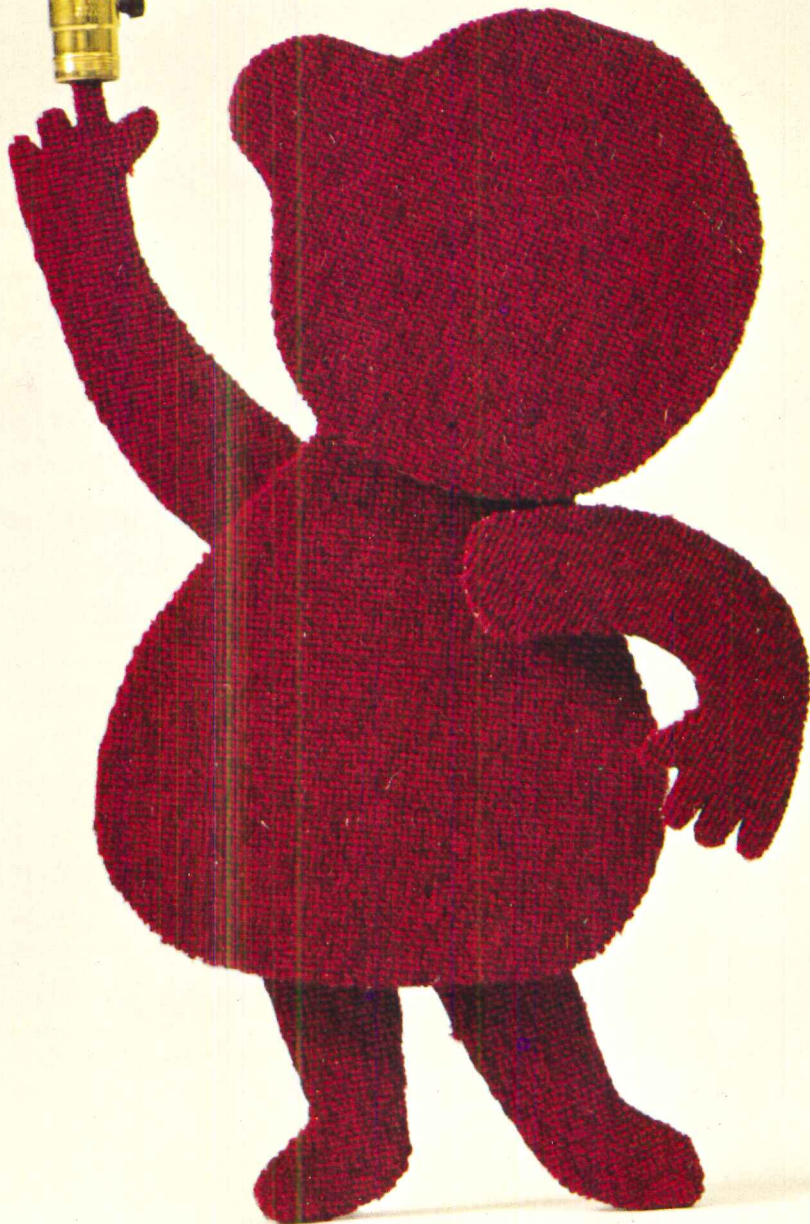

ACRILAN[®] 2000+
ACRYLIC
IS STATIC RESISTANT

Acrilan[®] 2000+ ACRYLIC **is static resistant, but it sure adds spark to this hospital.**

In the new "therapeutic corridor" at South County Hospital in Wakefield, Rhode Island, you can touch a door-knob or a switch without a flinch.

But there's more to static resistance than that.

Carpets that build up static charges attract dust particles, get dirty quicker and are harder to clean. What's more, they can interfere with delicate electronic instruments.

Acrilan[®] acrylic 2000+ is virtually static-free under normal conditions. In fact, no other carpet fiber claims lower static discharge than Acrilan 2000+.

Carpets of this rich, glowing fiber are uniquely suited to hospital use for another major reason: their resistance to stains. Acrilan 2000+ has been

tested with more than one hundred hospital stains *and* their solvents.

Because the color is locked in the fiber, not applied after it's made, carpets of Acrilan 2000+ came through in great shape.

As a result, South County Hospital was able to use this handsome carpet throughout the corridor, in patient rooms, and even up the walls in places.

Expensive? Not at all.

According to the Hospital's Administrator, there is a 50% savings in maintenance costs over tile.

For more information to help you specify carpeting of Acrilan 2000+ fibers, turn the page.

There's nothing there but facts.

For Acrilan 2000+, that's enough.

ACRILAN[®] 2000+

ACRYLIC



FACTS TO HELP YOU SPECIFY ACRILAN® PLUS AND ACRILAN® 2000+

ACRYLIC

ACRYLIC

DURABILITY

In the many tests that measure durability, including abrasion and stair wear, Acrilan Plus and Acrilan 2000+ outperform wool by at least 30%. But durability means more than abrasion resistance. It means the ability to keep a rich, new look despite a long period of hard traffic and difficult soiling and fading conditions. Acrilan was first introduced in carpeting fifteen years ago. Many of the original installations are still in place, still look young and beautiful. And that's the best proof of durability.

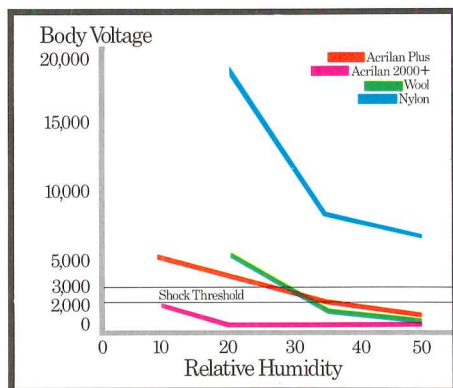

STATIC RESISTANCE

Acrilan Plus offers exceptionally low static build-up and discharge rate. But where this factor is of great importance, specify Acrilan 2000+. Under normal conditions, carpets of Acrilan 2000+ are virtually static-free. This eliminates discomfort from touching metal objects and cuts down on interference with delicate electronic equipment. It also makes for a carpet that stays cleaner, because there is no static build-up to attract air-borne dust and soil.

STYLING

Did you ever notice how similar in appearance continuous filament nylon contract grade carpets are? Carpets of Acrilan Plus and Acrilan 2000+ on the other hand have decorating versatility unsurpassed by any other fiber. Carpets made with Acrilan® acrylic fiber, in fact can be tufted, woven, knitted or fusion bonded in an endless variety of designs, textures and colors that make possible a kaleidoscope of stylings. All this with the added benefit of being non allergenic, moth proof and mildew proof that comes from being a clean synthetic fiber.

EASE OF MAINTENANCE

Acrilan Plus has a smooth, hard surface that gives dirt particles no place to cling to. It vacuums easily and beautifully. It is non-porous and hydrophobic (resists moisture absorption). Many spills wipe up without a trace. Acrilan 2000+ has the added advantage of color locked in the fiber. Because each fiber is colored all the way through, even the harshest detergents can be used without any bleaching effect.

FLAME RESISTANCE

Government standards for flame resistance are currently being re-evaluated. But for now, stringent requirements are still in effect. Hospitals that receive any kind of federal assistance must comply. Jet aircraft carpeting must meet stiff F.A.A. regulations. Many states and localities have their own requirements for schools, nursing homes and college dormitories. Acrilan Plus and Acrilan 2000+ now have built-in fire retarders that give carpet manufacturers the capability of meeting all government requirements.

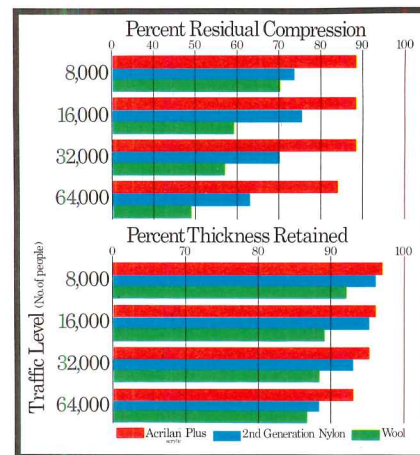

RESILIENCE

If a carpet fiber is not resilient, does not "bounce back" after compression, the carpet will tend to look worn long before real wear occurs. Acrilan Plus and Acrilan 2000+ have the ability to recover after long periods of compression under heavy furniture, as well as the ability to come back after side compression, such as that caused by heavy traffic.

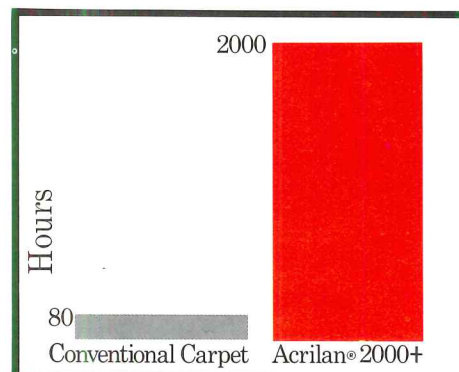

COLOR FASTNESS

Contract carpeting should have colors that stay bright, don't fade under tough conditions. Acrilan Plus performs well, even where food, drug or chemical spills are a problem. It has good resistance to both acids and alkalis, and can be safely cleaned with any ordinary cleaning agent. For tougher jobs, consider Acrilan 2000+. We tested it with nearly one hundred hospital stains and their solvents without affecting fiber tenacity or color. In sunny locations with large glass areas, there is nothing to beat this fiber. 2000+ is a Weatherometer rating, showing no fading after 2,000 hours of burning noon-day sun. For comparison, the industry standard for normal carpets is 40 hours. The plus in Acrilan 2000+ indicates that some of our colors rate up to 6,000 hours on this standard industry test. So you can see that we are being modest in naming this fiber.



MONSANTO, 1114 AVENUE OF THE AMERICAS, NEW YORK, N. Y. 10036

For additional information circle **No. 130** on Readers Service Card or write Monsanto.

See Castelli/Krueger seating in Sweets
Architectural File and Interior Design File.

Visit our showroom...
NEOCON
SPACE 1184



**OUR
CASTELLI 106
HAS A FIRM
UNDERSTANDING**



No. 106
Designed by
Giancarlo Piretti.
Produced by Anonima
Castelli of Italy.

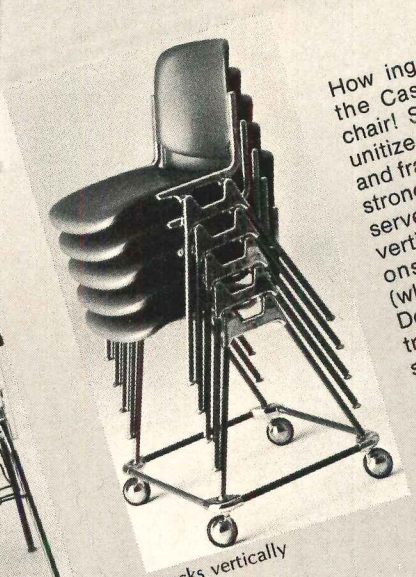

Stacks vertically

How ingeniously designed is the Castelli 106 stack/gang chair! Structural side plates unitize the legs, seat, backrest and frame support into a single strong and rigid unit. They also serve as the mounting base for vertical stacking and such additions as folding tablet arms (which also stack) and armrests. Detachable book rack and ashtrays also available. The handsome 106 is one of the most comfortable meeting room chairs you ever sat in—no matter how long the session.

Write for color brochure.

Krueger
GREEN BAY, WISCONSIN 54306

Assembled and solely distributed by

Showrooms: NEW YORK: 20 E. 46th Street
LOS ANGELES: 8899 Beverly Boulevard
CHICAGO: 1184 Merchandise Mart
Boston • Indianapolis
Denver • Dallas
Houston

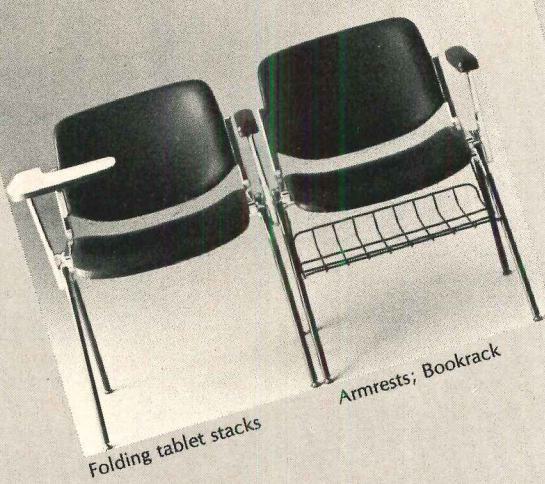

Folding tablet stacks

Armrests; Bookrack

For more data, circle 68 on inquiry card

Let us help you
meet the
exciting challenge
of designing
better pools.

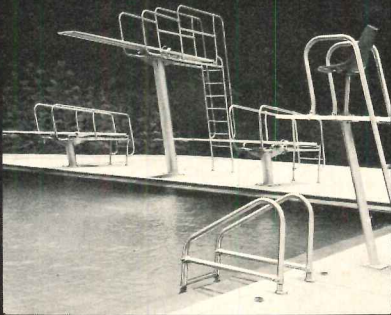

For nearly two decades KDI Paragon has shared its engineering expertise with Architects helping them exercise their ingenuity and achieve design goals while staying within budget. Paragon understands your language and the problems you face in building pools. Contact us. We'll give you straight answers and sound advice and usually an immediate solution to your problem.

KDI Paragon is one of the world's leading manufacturers of quality deck equipment, filtration systems, underwater lighting and observation windows. We make over 500 professionally-engineered products used in, on and around pools.

See our Catalog in Sweets or Write:



KDI Paragon Inc.

Mfrs. of Quality Deck &
Underwater Equipment
12 Paulding St., Pleasantville,
N.Y. 10570 • 914-769-6221

For more data, circle 69 on inquiry card

PRODUCT REPORTS

continued from page 150

FIRE DETECTOR / Device calls for an extinguishing agent when required, and automatically shuts sprinkler systems off when temperatures drop below the predetermined set point. The unit will withstand ambient temperatures up to 1500 F for short periods of time without damage. System is designed especially for "dry" sprinkler systems where water pipes remain empty when not in use. ■ Fenwal Inc., Ashland, Mass.

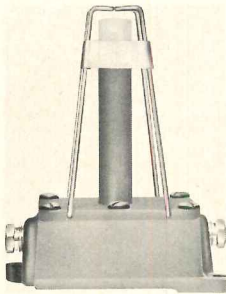

Circle 317 on inquiry card

ELECTRIC INSECT KILLERS / This unit, designed exclusively for interior use, is capable of positive fly control in areas occupying up to 30,000 cu ft. Panels emit a white light which lures flies to the wire grid where they are electrocuted. Dead flies fall into a sanitary collection tray. The unit has a one-year guarantee. ■ Rid-o-Ray, Milford, N.H.

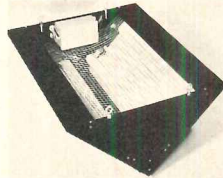

Circle 318 on inquiry card

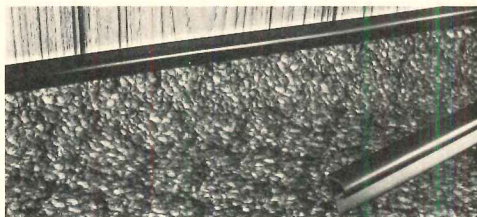

VINYL CARPET COVE CAP / Product is available in four colors and in 12 foot lengths. Flange of the cap is designed to grip carpet tightly and hold it in place. ■ Johnson Rubber Co., Middlefield, Ohio.

Circle 319 on inquiry card

WALL CONSTRUCTION SYSTEM / Aluminum wall forms are held in place without ties while the wall is being poured, allowing for placement of interior wall panels, styrofoam insulation, and disposable textured pressboard molds in the forms before the concrete is poured. Textured exteriors can be painted to resemble brick, wood and other materials. ■ Kaiser Aluminum & Chemical Corp., Oakland, Calif.

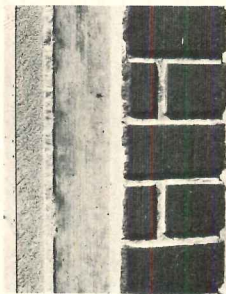

Circle 320 on inquiry card

ELECTRIC BASEBOARD HEATER / Features include junction boxes at both ends, a baffle strip that splits the rising air flow to keep the top of the unit cooler, cool-air slots below the thermostat to assure that the coolest air controls the stat, and new floating-suspension clips for quieter operation. Heaters are available in 42 models. ■ Hunter, Div. of Robbins & Myers, Inc., Memphis, Tenn.

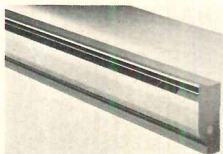

Circle 321 on inquiry card

more products on page 160

BRIGHTEN

UP

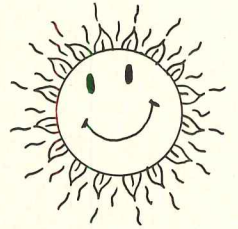

A

CLIENT'S

DAY....

...As a matter of fact most of his days.

Whether you are designing a home, a school or a place of business, Wasco Skydomes will brighten the interior and cut your client's electric bill.

Daylight is measurably the best source of light for human performance.

Skydomes provide more even light distribution with fewer windows.

Wasco provides Skydomes that are the standard for the industry.

For catalogs or technical assistance write or call:



WASCO PRODUCTS, INC.
LEADERS IN SKYDOMES & FLASHING

P.O. BOX 351 SANFORD, MAINE 04073
Tel: 207-324-8060

For more data, circle 70 on inquiry card

**Only Houghton
1092-IC
can ensure
the shortest
Passenger
Destination Time.**

**HAUGHTON ELEVATORS
AND ESCALATORS**

Toledo, Ohio 43601

DIVISION OF **RELIANCE** ELECTRIC COMPANY 

For more data, circle 71 on inquiry card

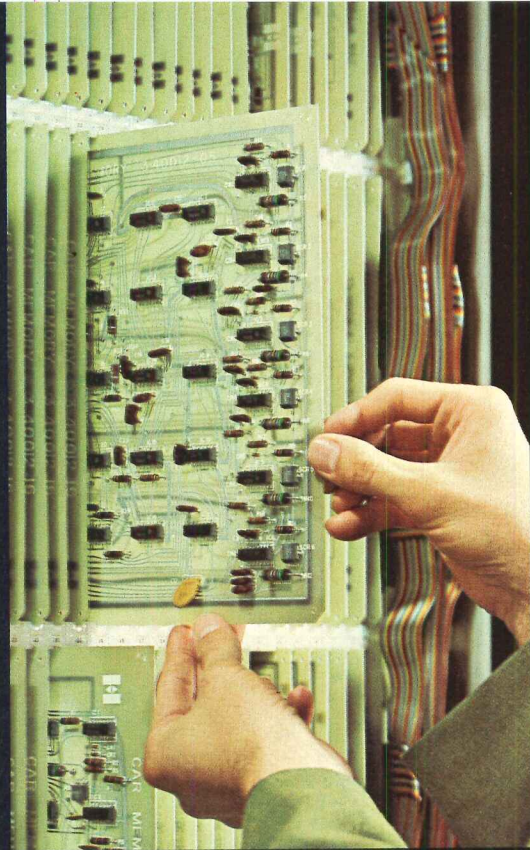

This is the most efficient and comprehensive system ever perfected for group elevator service. It's the only one that "thinks on its feet" — constantly recognizes and responds to everything affecting any car's ability to pick up and deliver passengers quickly. It's the only system able to provide the shortest Passenger Destination Time.

Faster than description — in milliseconds — 1092-IC locates every call as it's registered, computes distance between cars and calls, measures each car's load, counts every call, instantly and continuously allots and reallocates calls to cars best able to handle them.

And 1092-IC is not merely last year's relay system warmed over. It's exclusive — an entirely new concept of elevator control. Micro-miniature integrated circuits are employed to their full capability for the first time in elevator application.

A compact cabinet of integrated circuits replaces a roomful of old-type hardware. Yet 1092-IC speed and scope exceed any other elevator system — deliver the shortest Passenger Destination Time ever achieved.

Personal investigation will convince you that Houghton 1092-IC introduces a new generation of passenger elevator service. We're ready. Just tell us when you are.



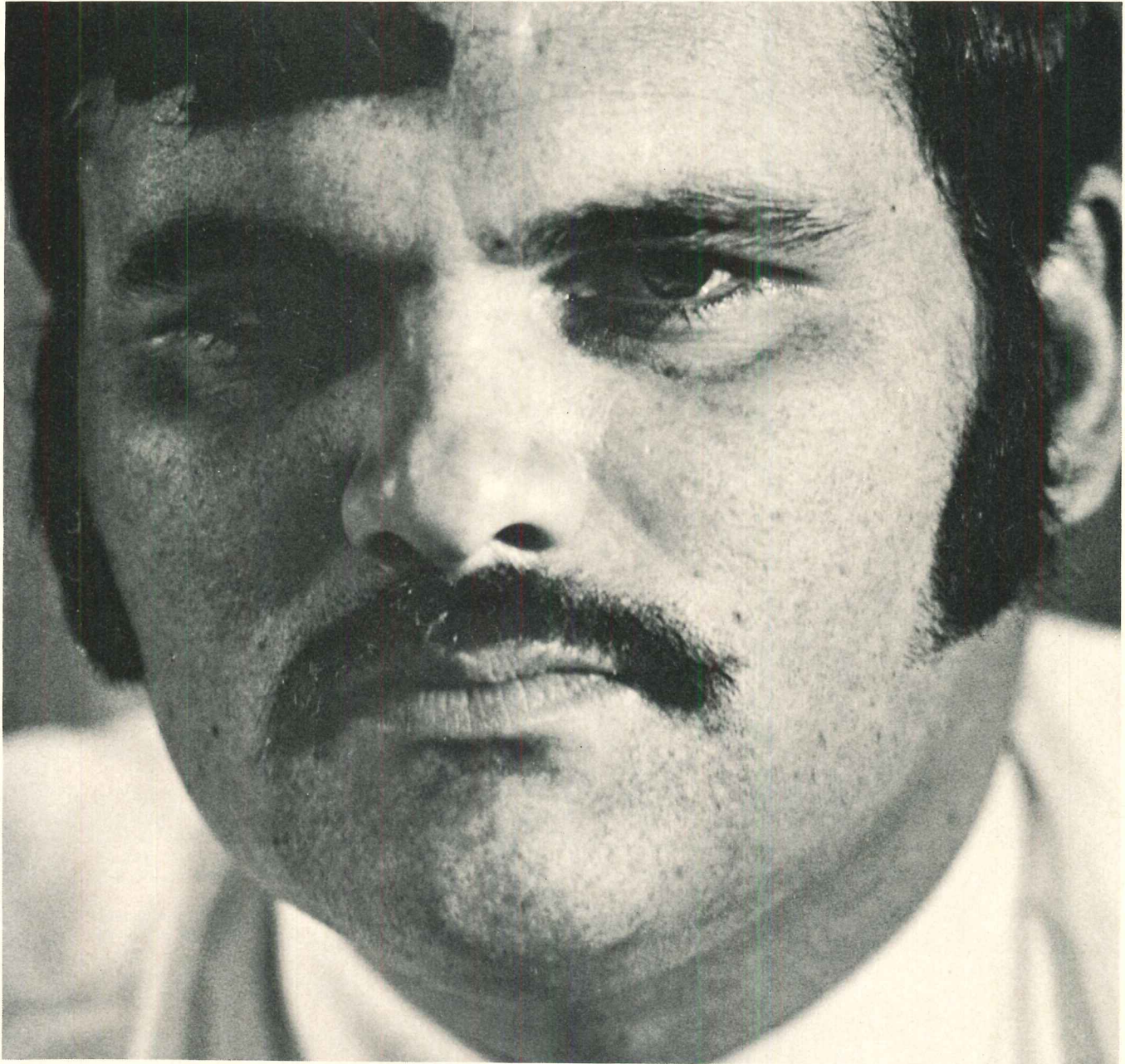

Ask general manager Stew Barber

**Our Pitt-Glaze® Coating System
sheds fats and fatty acids fast—
keeps maintenance costs down**

Ex-Buffalo Bills' offensive tackle Stew Barber knows how unneeded fat slows down an athlete. As general manager of Darling & Company's Buffalo, N. Y. rendering plant, he also knows how fat deposits can slow down cleaning and maintenance of machinery and plant surfaces, increasing maintenance costs.

But, when the company renovated its Buffalo plant, *Pittsburgh Paints* polyester-epoxy *Pitt-Glaze* Coating System made a whole new ball game out of the clean-up chore. Rendering bones, fats and meat

scraps, even in a closed system, throws atomized fats into the air and onto exposed surfaces, making housekeeping a major problem. Mr. Barber solved it with new higher-solids *Pitt-Glaze*—286 gallons of it in decorative, practical and durable colors, on all surfaces, machinery and equipment.

Says Stew Barber, "Cleaning up after a day's operation is easier and faster without detailed, time-consuming attention. We get an excellent job by washing down everything with hot water and steam. Fats and fatty acids come off *Pitt-Glaze* surfaces easily."

Tile-like *Pitt Glaze* gives any interior surface a durable, handsome uniform coating that stands up under hard use and deteriorating atmospheres like a champion. Most stains clean up in a flash. Ask for your free booklet now. PPG Industries, One Gateway Center, 3W, Pittsburgh, Pa. 15222.

PPG: a Concern for the Future

PITTSBURGH® PAINTS



For more data, circle 72 on inquiry card

Plan yourself a "Field Trip"



Where the differences in Permanent Dockboards really show up

Permanent Adjustable Dockboards look alike, and have similar sounding features. But put them in operation and the resemblance ends.

We feel Kelley Dockboards are superior in design, construction and operation. That's why we'd like you to see our dockboards in operation . . . insist on operating them yourself. Ask us to fully explain our exclusive twin safety system and automatic operation. In fact, before you buy or specify,

make us prove how much better and safer Kelley Dockboards really are.

Your clients will appreciate the extra effort. For complete details, fill in the reply card or write:



KELLEY COMPANY, INC.
6768 NORTH TEUTONIA AVE.
MILWAUKEE, WISCONSIN 53209
(414) 352-1000

For more data, circle 73 on inquiry card

Look for our book...

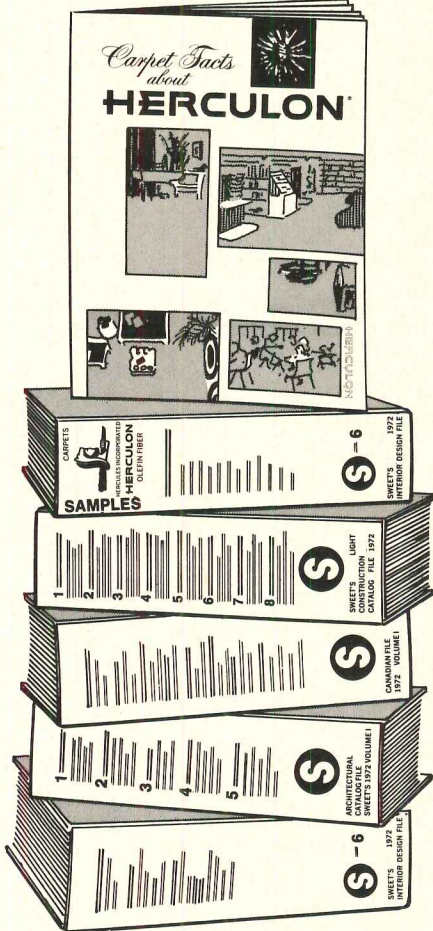

...in your books.

Our book is called Carpet Facts About HERCULON®. A colorful, 24-page booklet detailing the performance, construction, installation, maintenance and specifications of carpets made with pile of HERCULON* olefin fiber. You'll find it in four volumes of the 1972 Sweet's Catalog . . . Architectural, Interior Design, Light Construction and Canadian files.

A special swatched binder in Sweet's Interior Design file features a cross section of carpet constructions in HERCULON. It's a first for Sweet's . . . the first full volume of carpet samples ever assembled by a fiber producer.

We are doing all this for one very simple reason. The more you know about carpets of HERCULON, the more likely you are to specify them.



*Hercules registered tm—Hercules Incorporated

PRODUCT REPORTS

continued from page 156

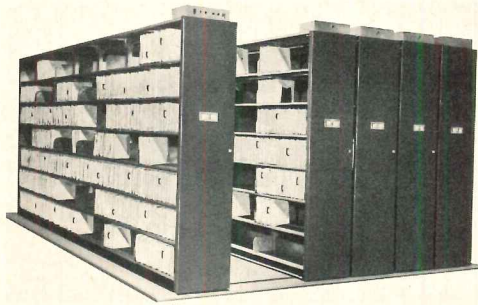

MOBILE STORAGE SYSTEM / Compact shelves glide laterally, providing one access aisle to the desired shelves. ■ Estey Corp., Red Bank, N.J.
Circle 322 on inquiry card

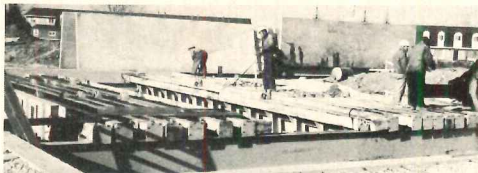

CONCRETE BATTERY MOLD / On-site casting of vertical load-bearing walls requires less construction time, according to the manufacturer, and costs less due to savings on shipping costs. ■ IE Industries, Minster, Ohio.
Circle 323 on inquiry card

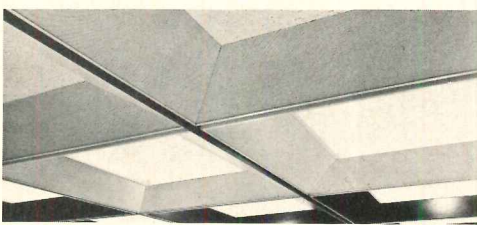

CEILING SYSTEM / Components include a contrasting pattern of 60 by 60 in. modules with acoustical panels and lighting, and an air bar providing ventilation through the grid. ■ Conwed Corp., St. Paul, Minn.
Circle 324 on inquiry card

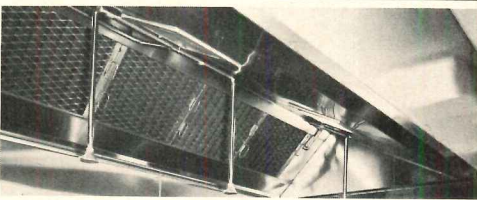

GREASE FILTERS / A self-draining baffle assembly removes grease from cooking fumes before they enter the ductwork, thereby reducing risk of fire and cleaning maintenance. ■ Flame Gard, Inc., Los Angeles.
Circle 325 on inquiry card

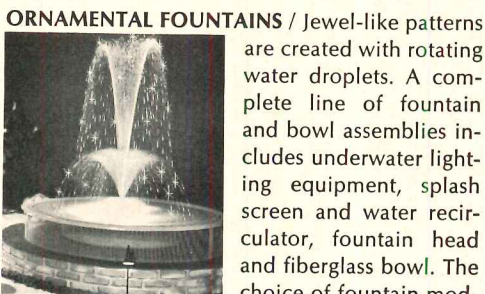

ORNAMENTAL FOUNTAINS / Jewel-like patterns are created with rotating water droplets. A complete line of fountain and bowl assemblies includes underwater lighting equipment, splash screen and water recirculator, fountain head and fiberglass bowl. The choice of fountain models is extensive. There are three types of fountain patterns. ■ Rain Jet Corp., Burbank, Calif.
Circle 326 on inquiry card

more products on page 164

(ADVERTISEMENT)

FOR THE RECORD

CHARLES A. LINDBERG comments on customized casework

Interior building space, particularly in health care institutions, is so costly today that its value should be measured by the inch.

One way an architect can utilize every inch of expensive hospital and nursing home space is to specify casework that is custom built to precise requirements. Space wasting "fillers" between cabinets to close up gaps in an installation are therefore eliminated.

Aside from the obvious economies of customized casework, there is another very important consideration for architects: design freedom. For example, numbers and placement of doors and drawers . . . cabinet depths . . . heights and dimensions . . . all are flexible and only contingent upon individualized specifications. Sophisticated items such as pass-through wall cabinets and special duty casework can be specified to conform to the overall decor of your entire installation.

Paradoxically, all these advantages cost no more. Custom metal casework of a superior quality is available at less cost than for inflexible stock items of comparable quality. Furthermore, such features as complete rabbeted frame construction . . . ball bearing drawer suspension . . . brass hinges with nylon bushing . . . and welded corners with no overlap or joints . . . are standard in this customized line, and not premiums which command a higher price.

The manufacturer to contact for complete information on these outstanding custom products for health care institutions is Jamestown Products Division, AVM Corporation, 178 Blackstone Avenue, Jamestown, N.Y. 14701.

Charles A. Lindberg

Vice President — Institutional Sales
AVM Corporation

For more data, circle 75 on inquiry card

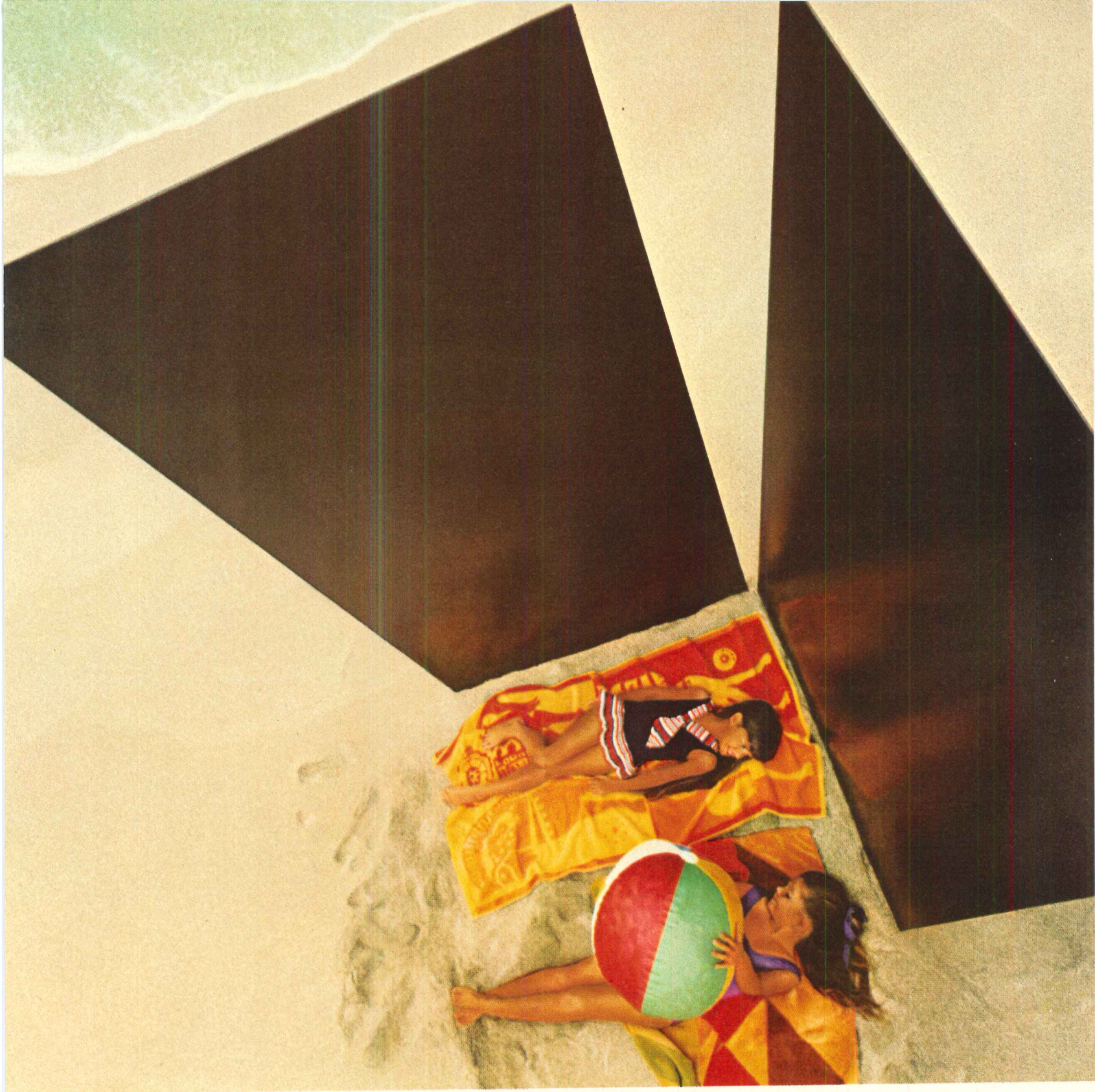

Basking bronzes.

Introducing sun-loving Kalcolor[®] in handy Mirawal[®] building panels.



Dark statuary bronze and medium amber hues of Kalcolor aluminum are now available in light, rigid, easy-to-use building panels from Kaiser Mirawal.

Mirawal Kalcolor Building Panels.

You can order them as veneer or insulated panels in the sizes you need.

Being Kalcolor aluminum they provide a unique extremely hard-anodic color coating, unsurpassed for long life against sun, weather and wear. And for beauty indoors or out.

For more data, circle 76 on inquiry card

For samples—and to see other ideas in today's widest range of building panel types, colors and facings—write Kaiser Mirawal, P.O. Box 38A, Port Carbon, PA. 17965.

We'll show you oceans of possibilities.

**KAISER
MIRAWAL**

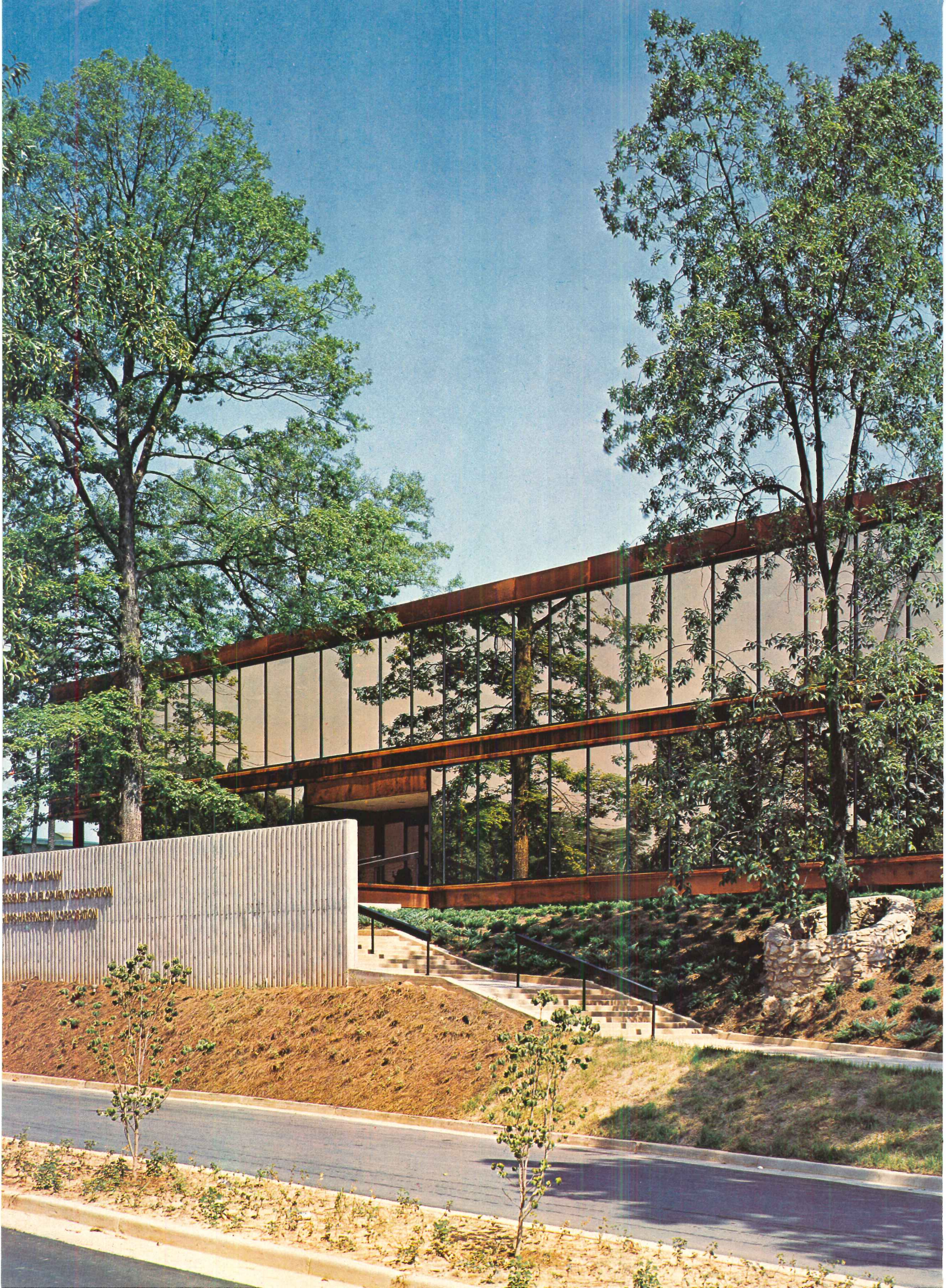

THE JUDICIAL
RESERVE ASSESSMENT CORPORATION
HARRINGTON CORPORATION

Fits Glazing Functions Eight Ways



Names to remember for specific performance . . . whatever the light, heat, glare, sound or safety control you want to build into structural walls:

POLARPANE® Insulating glass units with 20-year warranted moisture-free construction.

POLARPANE® Reflective insulating units with pure gold mirror-like coating. Choice of insulating and visible light values.

ARM-R-BRITE® Insulated spandrel panels fully tempered and tailored to your color specifications. Also available heat strengthened as Ceramalite®

ARM-R-CLAD® Tempered safety glass. Clear, tinted and textured. All standard thicknesses from 1/8".

SOUND CONTROL POLARPANE® Hermetically sealed units designed for maximum sound transmission loss.

SUN CONTROL POLARPANE® Hermetically sealed units with rotating venetian blind between glasses.

MISCO® Wired glass listed fire retardant by Underwriters' Laboratories, Inc. In seven popular patterns.

MISSISSIPPI® PATTERNED GLASS In wide variety of general purpose and decorative patterns.

See our Catalog in Sweet's 8.26/Ce when you want to refresh your memory and consider patterns, colors or specifications.

For additional catalogs or information contact your local C-E Glass representative or write C-E Glass, 825 Hylton Road, Pennsauken, N. J. 08110.



For more data, circle 77 on inquiry card

Owner: Phipps Land Co.
Architect: Toombs, Amisano & Wells
Stopray #2016 glazed by PPG, Atlanta

Thinking about a waste collection system?

Thinking about a pneumatic waste collection system?

Think about:

TRANS-VAC SYSTEMS

designers of

Pneumatic Transport & Waste Collection Systems for handling soiled linen or trash (or both).

fast • efficient • sanitary

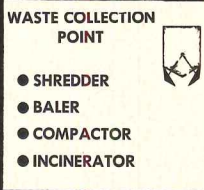

Simplified Illustration

used in:

● **hospitals**

Ideal for new hospital construction, major additions or renovations . . . or can also modify existing gravity chute systems for lateral transfer of material.

● **high-rise structures**

Ideal for high-rise structures such as hotels, motels, large office buildings, apartment complexes, dormitories and institutions.

● **large recreational developments**

Ideal for large recreational projects, amusement parks, sports complexes and stadiums.

Space saving TRANS-VAC Systems utilize idle wall and ceiling space for placement of chutes and conveyor pipes. Piping may also go above or below ground, over roof tops, along outside walls and into basement area. Separate collector hoppers located in laundry room and trash collection area automatically deposit loads of transported material on signal from central control panel.

TRANS-VAC Systems offer completely integrated systems for Pneumatic Transport, Shredding, and Waste Disposal — all fully automatic. Each system individually engineered and backed by 47 years experience in pneumatic conveying and waste disposal technology.

Write or phone Dept. AR for further information and/or design assistance. See our Catalog 10.28/TR in SWEET'S 1972 Architectural File.



Since 1925—Solving Difficult Problems for Industry

TRANS-VAC SYSTEMS

A Division of MONTGOMERY INDUSTRIES INTERNATIONAL
2017 THELMA ST. • P.O. BOX 3687 • JACKSONVILLE, FLORIDA 32206
TELEX 56292 PHONE 904-355-5671

PRODUCT REPORTS

continued from page 160

ROOF SYSTEM / Insulation, felt, roofing joint



tape and bitumen are supplied as a package for use on metal, wood or concrete decks. The system gives one-source responsibility for the entire roof and, when applied in accordance with company specifications, is guaranteed against failure for 10 years from date of installation. Standard roofing techniques are used to apply the materials. ■ Koppers Co. Inc., Pittsburgh.

Circle 327 on inquiry card

ICE MACHINE / Unit produces three-dimensional

mini-cubes with 11 sides which are said to chill beverages very quickly and permit longer lasting cooling action. Unit has a capacity to produce 300 lbs, or 17,000 cubes, over a 24-hour period. Features include

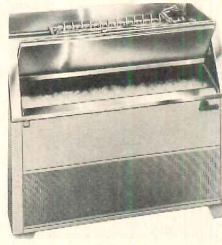

a water purification system and automatic operation. ■ Liquid Carbonic Corp., Chicago.

Circle 328 on inquiry card

FILING SYSTEM FOR DRAWINGS / One standard

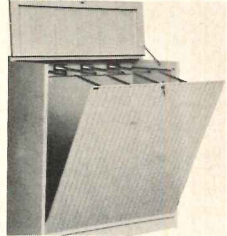

size file will accommodate drawings from A through E sizes. Other features include a coding system which eliminates misfiling of drawings, and time savings of up to 75 per cent in filing and retrieving. Files

are of all metal construction. ■ Valagraph Co., Buena Park, Cal.

Circle 329 on inquiry card

FLOOR TILE / This pattern, called "Medallions,"

is one of four new designs available in brown, white, olive and amber. Special textures are available for added resistance to wear in commercial areas with a heavier traffic pattern



and for slip resistance on inclined ramps and wet areas. ■ Interpace, Glendale, Calif.

Circle 330 on inquiry card

SLANT OFFICE / Unit was designed to provide

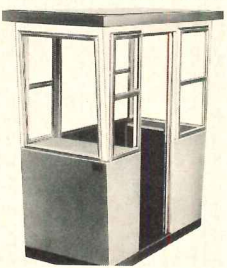

maximum convenience in a minimum amount of space and is particularly useful for parking lot and plant security applications. Steel booth arrives ready for on site installation, and comes complete with sliding doors, solid or sliding

windows, safety plate steel floor, canopy, fiberglass insulated walls, insulated roof and a color choice of enamel finish. ■ Par-Kut International, Inc., Mt. Clemens, Mich.

Circle 331 on inquiry card

more products on page 168

◆ For more data, circle 78 on inquiry card

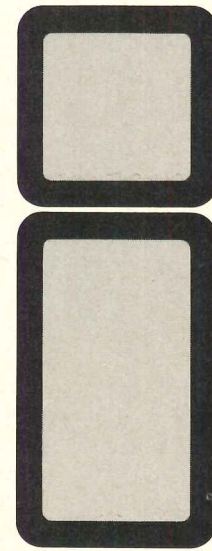

Specify Structural Steel Tubing

for **STRENGTH** plus **BEAUTY!**

Regal rectangular and square structural steel tubing offers many advantages for use as load bearing and curtain wall columns, railings, mullions and stair stringers. Provides great strength, attractiveness and safety. Requires little maintenance. As there are only four sides, other materials fasten to it easily. Often used as supports and downspouts as well. Available in many sizes up to 12" x 8" or 10" x 10" and wall thicknesses up to 1/2".

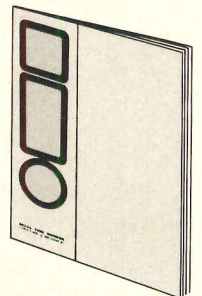

Write for brochure giving complete data.

REGAL TUBE COMPANY

A Subsidiary of **Copperweld Steel Company**



7401 South Linder Ave.
Chicago, Illinois 60638
312/458-4820

COPPERWELD
SPECIALTY MATERIALS

Rely On Regal

For more data, circle 79 on inquiry card

Today's Touch



*Berlin design Ten-Strike™ lockset.
Comfort-curved to the clasp.
Smoothly responsive to the gentlest turn.
Reassuringly solid. Enduring design
in the Russwin tradition. Russwin, Division
of Emhart Corporation, Berlin,
Connecticut 06037. In Canada — Russwin,
Division of International Hardware.*



The Collector's Series by Russwin

For more data, circle 80 on inquiry card

This Single Fitting Delivers Phone, Power and Signal Service

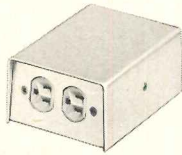

THE GRANCO CEL-WAY®/COFAR® SYSTEM



Only visible evidence of the system is the handsome floor fittings, each furnishing telephone, power and signal services wherever needed throughout the floor.

Concealed within the 5¼" floor slab is a network of electrical cells, factory-installed pre-set inserts and Granco's new Feed-Way high capacity header. Granco's Cofar floor deck (combined form and reinforcement) completes the system.

Pre-set inserts permit future installations of additional floor fittings without core drilling. Desks and partitions can be changed whenever desired.

Get the complete story on CEL-WAY/COFAR in-floor electrification. See Sweet's 5.5/Gr and 16.2/Gr, or write for new product design manuals. Granco Steel Products Company, 6506 N. Broadway, St. Louis, Mo. 63147.



 **Granco Steel Products Company**
A Unit of
National Steel Corporation

For more data, circle 81 on inquiry card

**DON'T OVERLOOK HIDDEN
PLUMBING PROFITS!**

use all-new



Above/Floor Plastic Fittings

For maximum profits, install modern above/floor plumbing with GSR® Above/Floor fittings. It means extra profits — extra convenience — for builders of conventional residences, high-rise apartments, and modular, prefabricated units. Available in ABS and PVC, these fittings accommodate floor-mounted, wall-discharge water closets and raised bottom tubs and showers. **Use them along with standard GSR fittings for the full economy of all-plastic DWV systems.**

- Eliminates costly plumbing below the slab.
- Pour slabs before plumbing is roughed in.
- Fewer floor penetrations are needed.
- No dropped ceilings in multi-story buildings.
- No need for expensive pipe hanger assemblies.
- Fewer fittings are required.
- Complete DWV plumbing cores easily preassembled.
- Fewer trips to the job site.

To make more profits from plumbing, go above/floor with GSR fittings. See your GSR fittings distributor or write for details.



Vented Vertical
Closet Bend With
Auxiliary Inlets



Vented Horizontal
Closet Bend With
Auxiliary Inlet



Vented Horizontal Wye



R & G SLOANE MANUFACTURING COMPANY, INC.
A SUBSIDIARY OF THE SUBGUEHANNA CORP.

7606 N. Clybourn Ave., Sun Valley, Calif. 91352 • (213) 875-0160

Plant, Warehouse and Sales Office:
6100 Hillcrest Dr., Cleveland, Ohio 44125 • (216) 524-8600

Warehouse and Sales Offices:
9851 Industrial Blvd., Lenexa, Kansas 66215 • (913) 888-8000
1669 Litton Dr., Stone Mountain, Ga. 30083 • (404) 939-6644
8041 S. 198th Street, Kent, Washington 98031 • (206) 854-2324

For more data, circle 82 on inquiry card

UPC APPROVED

when
it comes to
filling
an opening...
any opening

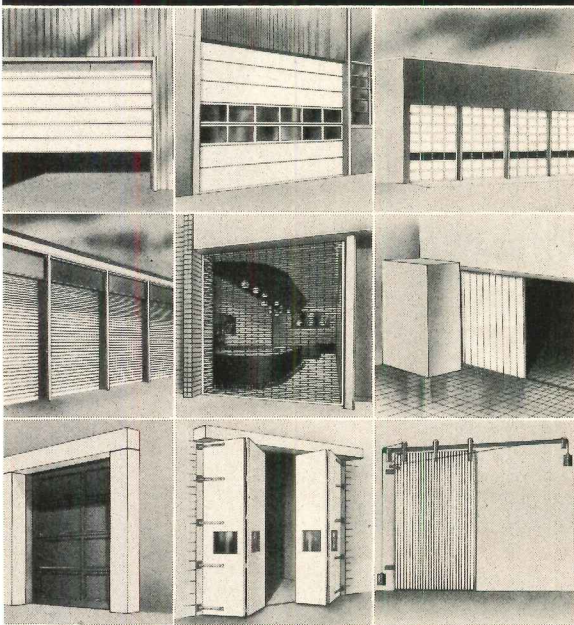

CRAWFORD has the DOOR

Industrial, Commercial
Institutional, Residential

- Sectional Doors: Steel, Fiberglass, Aluminum, Wood—Flush and Panel
- Security and Counterweighted Doors
- Rolling Doors: Steel, Stainless Steel, Aluminum
- Rolling Grilles: Steel, Stainless Steel, Aluminum, Bronze
- Rolling Counter Shutters: Wood, Steel, Stainless Steel, Aluminum
- Side Coiling Grilles and Doors: Wood, Steel, Stainless Steel, Aluminum, Bronze
- U. L. Labeled Rolling Doors, Counter Shutters, Metal Clad and Corrugated Sliding Fire Doors
- All Special Engineered Doors
- a Full Line of Accessories: Electric Operators and Controls, Pass Doors, Removable Mullions, Dor-Seal Dock Shelters.

FOR FULL DETAILS SEE YOUR SWEETS ARCHITECTURAL CATALOG FILE Section 8.9/Cra "Uprising Sectional Doors" and/or Section 8.7/Cr "Rolling Doors, Grilles, Shutters and Sliding Fire Doors."

Contact your local Crawford Distributor for specific data.



CRAWFORD

Crawford Door Company, 4270
High Street, Ecorse, Michigan

48229

Division of The Celotex Corp.

PRODUCT REPORTS

continued from page 164

WASH CENTER / Designed specifically to provide clearance for wheelchair users, unit is equipped with wristblade operated valves mounted on the horizontal surface of the bowl deck. Rectangular bowl has covered corners and underside is coated to absorb sound. UL-approved, factory-wired unit combines a light fixture and grounded electrical outlet, storage cabinet with glass-mirrored door, towel and cup dispenser. ■ Bradley Wash-fountain Co., Menomonee Falls, Wis.



Circle 332 on inquiry card

STEEL SIDING / Rough-sawn pattern is embossed in the galvanized steel during roll forming. Siding is a combination of vinyl and steel. Baked vinyl finish is bonded to the steel panels, forming a protective coating providing corrosion- and rust-resistance. Panels come in seven colors and are ideal for apartments and single-family homes. ■ Alside, Inc., Akron, Ohio.



Circle 333 on inquiry card

COMPACTOR / This model meets the needs of cafeteria situations where continuous compaction of food and service wastes must be automatically handled. Features include a buzzer and light signal which indicate a completely filled garbage container that needs replacement. ■ The Tony Team Inc., Minneapolis.



Circle 334 on inquiry card

DUAL-CODE LOCKING SYSTEM / Product provides effective access and parking fee controls for different groups using parking facilities in varying shifts. Shift control is managed by a simple changeover from day to nighttime coding at the locks. Lock codes can be reprogrammed in seconds. ■ Cardkey Systems, Chatsworth, Calif.

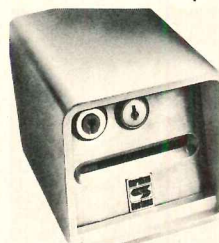

Circle 335 on inquiry card

PORTABLE OFFICE-LANDSCAPE PARTITION UNITS / Four standard sizes are available in three vinyl woodgrains, three hardboard woodgrains, or 10 vinyl color finishes. Units are self-standing and may be used singly or in groups of two or more interconnected units. When interconnected, panels pivot from 0-180 degrees on built-in levelers. Partitions are especially designed for offices. ■ Masonite Corp., Chicago.

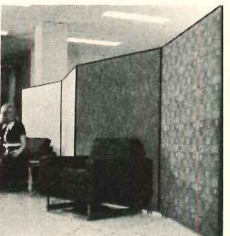

Circle 336 on inquiry card

more products on page 175

See FREE-TIE at A.I.A.
Convention, Houston, Tex.
May 7 - 11 Booth 316

NOW,

It's Cheaper To Be Beautiful!

FREE
BOOKLET
TELLS
HOW!

New concept in tie rods for Archi-
tectural Concrete . . . Cast walls.

- Decorative cone shapes can create new surface effects.
- FREE-TIE* is completely removed.
- Positively prevents grout seepage.
- Clean hole clear through.
- Can't make rust stains.
- No patch pop-out.

Write for brochure or
telephone (516) 997-5180



*U.S.PAT. NO.
3,437,309 and
PATS. PENDING

FREE-TIE Corporation
346 Westbury Ave., Carle Place, N. Y. 11514
Telephone (516) 997-5180

FREE-TIE

For more data, circle 84 on inquiry card



Westinghouse Electric Corporation Homewood Plant, Pittsburgh, Pa. Architect: Walter Roberts Associates, Pittsburgh, Pa. C-Panel System, 4" and 8" Ribbed Exterior Profile.

Smith Walls create an environment for...

industry

A plant doesn't have to look like a plant.

A really attractive industrial building is the starting point for a pleasant working environment. Smith Walls offer design possibilities limited only by the architect's imagination. An architect's idea, brought to life in the bright colors and interesting panel configurations of Smith metal walls, can make an industrial building a happier place to work. And Smith's Single Responsibility concept makes sure the walls *are* right. Single Responsibility is the Systems Approach to solving your metal wall problems. It's a complete system . . . from the earliest Architectural/Engineering contact through engineering, color coating, manufacturing to placement of the final product fastener on the job site. This Single Responsibility concept is the most important factor in Design Construction.

Specify Smith Walls, and Smith Single Responsibility, for your next building project. For full details and specifications, consult Sweets Architectural File or write.



The Dow Chemical Company, Newark Ohio Industrial Park, Newark, Ohio. Architect: Curtis N. Lindberg, Columbus, Ohio. C-Panel System, Shadowwall Exterior Profile.



ELWIN G. SMITH DIVISION

100 WALLS STREET, PITTSBURGH, PENNSYLVANIA 15202

For more data, circle 85 on inquiry card

EGS-103



International Paper Company, Lewisburg, Pa. Architect: Cassis Associates, Inc., St. Louis, Mo. B-Panel System, Contourwall and Hillinewall Exterior Profiles.

In 1958 they sealed the old Atlantic Richfield headquarters with LP[®] polysulfide polymer.



In 1971 they demanded that the new Atlantic Richfield headquarters be sealed with LP[®] polysulfide polymer.

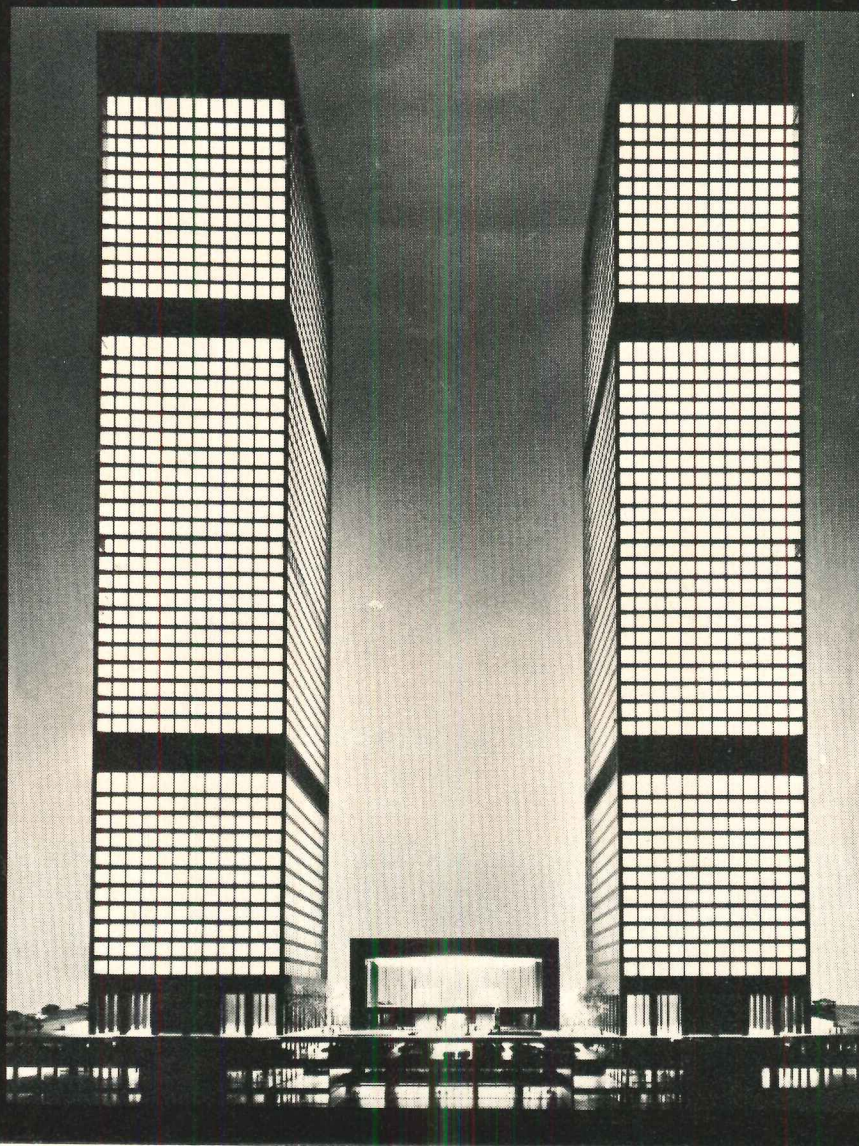

It always makes sense to ride a winner.

Case in point: the spanking new Atlantic Richfield Plaza whose designers and builders specified that it be waterproofed with a sealant based on Thiokol's LP[®] polysulfide polymer.

The reason for their decision? A polysulfide-based sealant has proven to be a winner. In fact, it has been doing just that for the past 14 years at Atlantic Richfield's former headquarters building nearby in downtown Los Angeles.

The choice, then, was both obvious and logical. Why not go with a sealant that had successfully withstood years of punishment in an environment that often contains more than its share of corrosive pollutants?

But, at Thiokol we don't rest on past accomplishments alone. Granted, sealants based



on our polymer have performed flawlessly for more than 20 years. Yet that doesn't stop us from continuing a Seal of Security Program which aims to see that they'll last even longer in the future.

So ride with a winner. Specify a sealant based on Thiokol's polysulfide polymer. It won't let you down over the long haul.

For more information, including detailed comparisons between sealants based on Thiokol's LP[®] polysulfide and eight other kinds of sealants, write: Dan Petrino, Thiokol Chemical Corporation, P.O. Box 1296, Trenton, N.J. 08607.

Thiokol

For more data, circle 86 on inquiry card

Owens-Corning announces a special reason to design buildings that conserve energy.

Show our Awards Jury a building that doesn't waste energy—and you could win one of the Energy Conservation Awards Owens-Corning will present this year.

The Awards Jury will be looking for three things: Creativity. Originality. And most important—*designs that save energy.*

We're launching this Award program because of the urgent need to conserve energy. Too many buildings waste fuel and contribute to environmental pollution.

By offering Energy Conservation Awards, we hope to stimulate new ways to conserve energy. It also lets us honor the architects and engineers who do the best job of designing buildings and mechanical systems that conserve energy.

Who can enter. All registered architects and professional engineers practicing in the U.S. are eligible. As individuals or in teams. But to qualify, your entry must be a commissioned building project—in the design process, under construction, or a completed structure.

Entry categories. A winner will be selected in each of these three categories:

Institutional—schools, hospitals, and government buildings, for example.

Commercial—office buildings, shopping

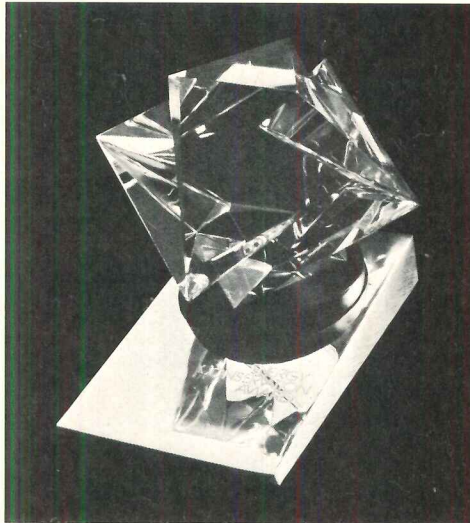

The Owens-Corning Energy Conservation Award. "Triangles," a Steuben crystal sculpture that captures and reflects light from multiple triangular planes.

centers, retail stores and similar structures.

Industrial—including manufacturing plants, research centers, warehouses.

Equal emphasis will be given to all entries regardless of project size.

The use of Fiberglas* products is not required.

The Awards. Winning architects and engineers will receive the Steuben crystal sculpture shown at left. Firms and building owners associated with winning entries will receive Steuben plaques.

The Awards Jury.

Winners will be selected by: MacDonal Becket A.I.A.—Welton Becket and Associates. Leander Economides—Economides and Goldberg. Harold S. Lewis—Jaros, Baum and Bolles. Professor Charles F. Sepsy—Dept. of Mechanical Engineering, Ohio State University. Herbert H. Swinburne F.A.I.A.—The Nolan and Swinburne Partnership.

Send for entry details now. Completed entries must be submitted by August 31, 1972. Winners will be notified in September. We'll make the Awards in October.

For a brochure giving complete details, contact your local Owens-Corning representative. Or write: Owens-Corning Fiberglas Corporation, Energy Conservation Award Program, Architectural Products Division, Fiberglas Tower, Toledo, Ohio 43659.

*T.M. Reg. O.-C.F.

Owens-Corning is Fiberglas

OWENS/CORNING
FIBERGLAS
TRADE MARK ®

For more data, circle 88 on inquiry card

**it's an
exposed
ceiling.**

**it's a
structural
floor.**

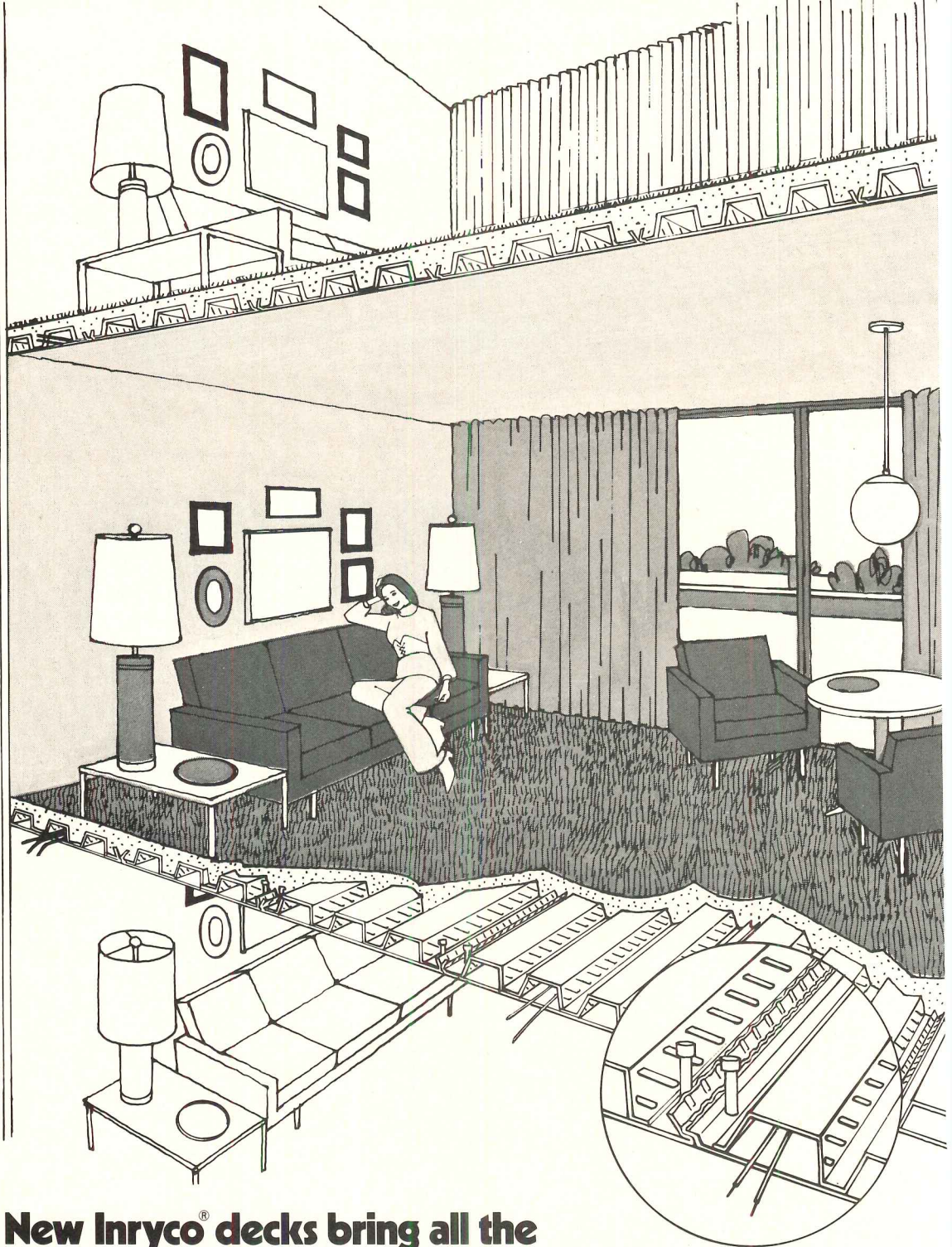

New Inryco® decks bring all the advantages of composite design to hotel and motel construction.

Inryco Types V, NFv and HFv Floor/Ceiling systems make possible long span composite slabs that create spacious uninterrupted areas.

The smooth underside of the deck is treated to accept a sprayed-on finish that looks like plaster, and eliminates the need for suspended ceilings and the extra building height they require. In addition, floor cells can carry electrification for rooms above and below. And recent UL Ratings often make it possible to eliminate costly fireproofing.

Exclusive V lock joints on each panel increase composite action with concrete. So you get long span slab strength at costs comparable to ordinary construction. Deck is lightweight. Goes up quickly, with on-site equipment. Becomes a safe work platform at once... no need to wait for concrete to cure. Eliminates costly forms.

Ask for the booklet "Inryco Floor/Ceiling Systems" and Catalog 21-1. Write Inland-Ryerson Construction Products Co., 4133 W. Burnham Street, Milwaukee, Wisconsin 53201. You'll also find us in Sweet's Architectural File, Section 5.

A2-21-2

For more data, circle 91 on inquiry card

**INLAND
RYERSON**

General Offices: Chicago, Illinois
A member of the **INLAND** steel family

continued from page 168

FREE-STANDING PARTITIONS / Steel panels are self-supporting, movable and interchangeable. Four different heights and 13 widths are available. Walls can be made entirely of steel or glass, or a combination of both. ■ Rockaway Metal Products Corp., Inwood, N.Y.

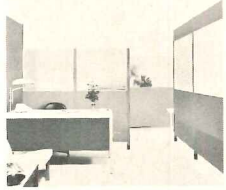

Circle 337 on inquiry card

FENCING SYSTEM / Extruded from a specially formulated polyvinyl chloride, fence is said to have excellent strength and weather-resistant properties and will not splinter or shatter at normal temperatures. Product is suited for commercial and residential applications. ■ Harvel Plastics, Inc., Easton, Pa.



Circle 338 on inquiry card

LIBRARY FURNITURE / Collection is crafted in all-hardwood solids and veneers. A method of leg attachment using concealed bars bolted together provides a metal-to-metal attachment that is said to add strength and stability.

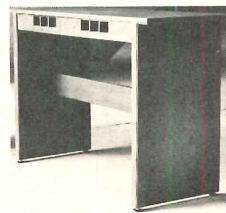

All pieces are accented by a carved quarter-round relief which appears under the edges of table tops, at the juncture of tops and cases, and along the exposed edges of legs. ■ Myrtle Desk Co., High Point, N.C.

Circle 339 on inquiry card

GLASS FURNITURE / All units are made of glass exclusively. Solid, transparent blocks are joined with clear cement to form pedestals for glass-topped tables, hollow containers, stands and slab-style cocktail tables. ■ Bahat Associates Inc., New York City.



Circle 340 on inquiry card

HEATING-COOLING UNITS / Six rooftop package models ranging in size from 15 through 20 tons cooling and 250 through 450 MBTU heating are available. Electric cooling and natural gas heating combination is a major feature, with several heating capacities for each cooling unit. ■ Hastings Industries, Inc., Omaha, Neb.

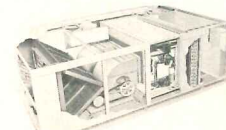

Circle 341 on inquiry card

PIPE INSULATION SYSTEM / Designed to meet the stringent fire code requirements for commercial, institutional and industrial indoor piping, especially where sanitation and appearances are important, system is said to combine all the outstanding physical properties of cellular glass with a UL-rated vinyl jacket. The system is moisture- and vapor-resistant, has high compressive strength and is said to maintain constant insulating efficiency. ■ Pittsburgh Corning Corp., Pittsburgh.

Circle 342 on inquiry card

more products on page 180

Halsey Taylor's 2-stream projector is prankster-proof. Placing fingers over outlets diverts water through slotted openings without squirting. In addition, Halsey Taylor offers these vandal-resistant features:

- Squirt-proof projector and drain strainer are locked into place to prevent twisting or unauthorized removal.
- Automatic stream regulator valve is located inside cabinet to prevent tampering.
- Heavy gage stainless steel top resists chipping and staining; cabinet is one piece, spot-welded steel construction.

Ask about our complete line of vandal-resistant water coolers, fountains and classroom sinks. HALSEY TAYLOR DIVISION, 1560 Thomas Road, Warren, Ohio 44481.

SQUIRT-PROOF



Halsey Taylor®

KING-SEELEY **KST** THERMOS CO.

For more data, circle 92 on inquiry card

SINGER announces a great new name in commercial air conditioning...



with a full line of products and
a full staff of people you already know as
“THE PROBLEM SOLVERS.”

Carteret. Our name may be new in commercial air conditioning. But our reputation is solidly established!

Our products aren't called “The Problem Solvers” for nothing. Every one is built to save you installation costs, operating costs and maintenance costs. And it's no accident that our people are called “Problem Solvers” too. Every designer, engineer and field representative really knows the business, knows the product and knows how to help you save a buck without sacrificing quality.

Now we're part of the Singer Company. An important part of their Climate Control Division. We've got a new name... Carteret. And some big new opportunities for the future.

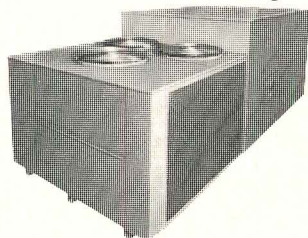

But what have we got for you today? Just one of the most complete product lines in the business, that's what. Carteret has products for all kinds of jobs. Big. Small. High rise. Low rise. New construction or modernization.

For instance, Carteret makes a total of 40 different models of Rooftop Air Conditioners alone. These include combination units, cooling-only units and split system units from 8 to 40 tons.

The Carteret line also includes air cooled Self Contained Packaged Units in 8, 10 and 16 ton sizes. Plus water cooled

units from 3 to 30 tons. And Packaged Chillers that range from 20 to 60 tons, water cooled, and from 20 to 50 tons air cooled.

Also available under the Carteret name is a complete line of Thru-The-Wall year 'round units in a variety of sizes and types. There are combination models with electric heat and cooling... or models that tie-in with exist-

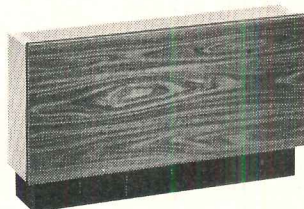
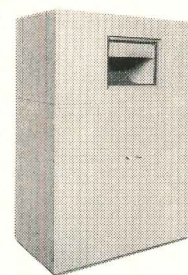

ing steam or hot water systems. Take your choice. Carteret also manufactures highly advanced Electro-Hydronic total environment systems for jobs where you need low cost operation and multi-zone control, too.

For more information on Carteret “Problem Solver” commercial air conditioning products, write us. Our address is still 1300 Federal Blvd., Carteret, New Jersey 07008.



For more data, circle 93 on inquiry card

AE / UPDATE

A classified advertising section devoted to helping architects and engineers keep up to date on building product manufacturers.

HARSHAW CHROMONYX BLACK CHROMIUM opens a new world of decorative design in plated finishes. Already being used on appliances, furniture, builder's hardware, lighting and plumbing fixtures, and architectural trim, ChromOnyx offers exciting possibilities for products requiring a decorative and corrosion resistant finish. A chromium deposit with molecular structure altered to give a rich, warm black with a deep, soft reflectivity. Electroplated by traditional methods. Durable, permanent and corrosion resistant. Six-page folder on request. The Harshaw Chemical Co., 1945 97th St., Cleveland, Ohio 44106



For more data, circle 94 on inquiry card

A NEW EDUCATIONAL ENVIRONMENT is created with these units which may be placed in a conventional classroom or in open-space schools. Units are truncated octahedrons which may be attached in a number of configurations to form a three-dimensional stack of individual learning spaces. Design satisfies students' privacy needs while providing visual access for the teacher.

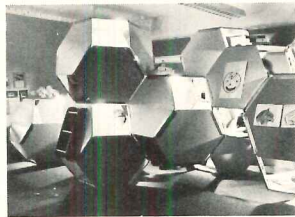

Each learning space has individual lighting controlled by the student. Write St. Charles Manufacturing Co., School Division, St. Charles, Illinois 60174.

For more data, circle 96 on inquiry card

1972 MARKS LARSEN'S 20th YEAR of manufacturing Weld-Crete® and Plaster-Weld®, the performance-proved and patented chemical bonding agents for concrete and plaster. Easy application and non-critical open time make both ideal for any bonding application. Not epoxies, Weld-Crete® and Plaster-Weld® are safe, especially for confined areas—non-toxic, non-flammable and non-volatile. Complete specifications, test data and descriptions for use in new work, renovation and repair are contained in catalogs available from Larsen Products Corp. 5420-C Randolph Rd., Rockville, Md. 20852.

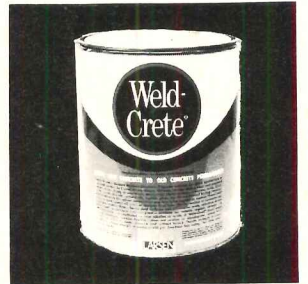

For more data, circle 95 on inquiry card

"Fiberglass bathroom fixtures will be standard in ten years . . .," according to a national trade magazine. Universal-Rundle—the pioneer in introducing fiberglass fixtures to home builders—is now the leading manufacturer of fiberglass tub/shower units. Consult SWEET's Architectural and Light Construction Files for U/R's complete catalog of bathroom fixtures. For a full-color brochure on U/R fiberglass fixtures, write Universal-Rundle Corporation, 217 North Mill Street, New Castle, Pa. 16103.

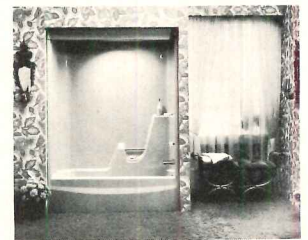

For more data, circle 97 on inquiry card

the leakproof plaza . . . and roof deck

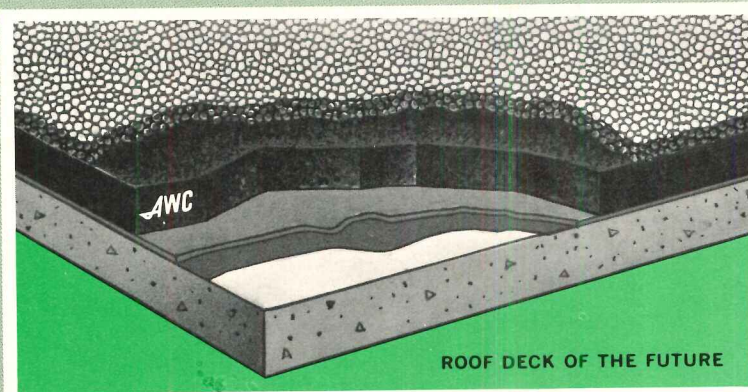
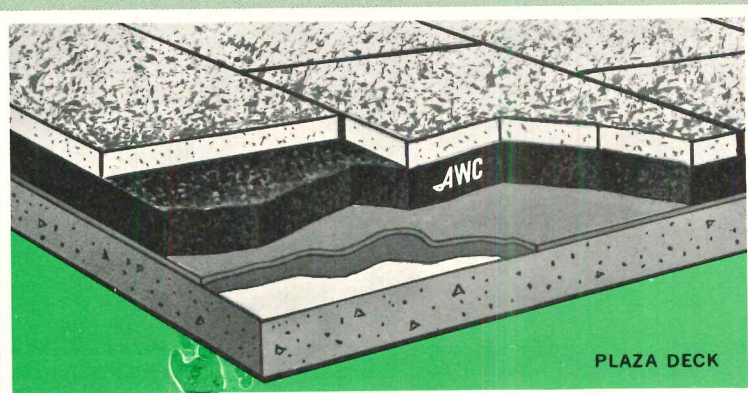

PLAZA DECK: To achieve a truly "leakproof" construction, the waterproof membrane should be protected from the cycling of wide temperature ranges, ultra violet rays and puncture by construction workers. All-weather Crete monolithic insulation provides this protection keeping the waterproof membrane ductile and active for the life of the system. There are eight widely used All-weather Crete plaza designs.

ROOF DECK OF THE FUTURE: Over a decade of designing, testing and practical application have produced this new Silbrico system. All-weather Crete is placed over the waterproofing membrane protecting it from severe thermal change and climatic elements which are major causes of roof failure. All-weather Crete insulation has the properties of being unaffected by these severe conditions.

For complete information, specifications and detail diagrams regarding these and many other successful All-weather Crete systems, write Silbrico Corporation, 6300 River Road, Hodgkins, Illinois 60525. References: Sweets catalog and Spec Data.



For more data, circle 98 on inquiry card

Happy marriage.

Republic stainless steel and Plexiglas joined in construction of space-age ski lodge.

Republic's DUROFLASH® stainless steel roofing was chosen as the ideal material for this most unusual weekend retreat... built in the foothills of Vermont's Green Mountains by architect Aaron Cohen, A.I.A., of New York City, for investment counselor Henry Schneider. The dodecahedron roof features DUROFLASH stainless steel in 24 planes, married to 12 trapezoidal Plexiglas* windows.

Though DUROFLASH is stronger and tougher than copper and aluminum, it can easily be joined by soldering or welding. Rated as "dead soft," DUROFLASH shows little or no springback when bent for forming. It offers important advantages, too, in stability—both in appearance and price. DUROFLASH will not change color and never needs cleaning or maintenance. Nor is its cost affected by fluctuating availability. In fact, dollar for dollar, DUROFLASH covers more roof for less money.

More than 1200 pounds of DUROFLASH in three-foot by eight-foot sheets were used on the job. The stainless portion of the roof was formed by nailing the DUROFLASH to two-inch by six-inch sheathing. The sheets were precut to size and joined by standing seams.

The area under each large window was flashed with four trapezoidal pieces of DUROFLASH, interlocked with standing seams. Flashing over each beam has longitudinal bends, both for rigidity and to form a gutter.

DUROFLASH is a "creative" material—easily adaptable to enhance your best ideas and readily available from your Steel Service Center. We'll be glad to

send useful reference literature describing this application and perhaps suggesting some for you. Write Republic Steel Corporation, Cleveland OH 44101.

*Plexiglas is a trademark of Rohm and Haas Company.

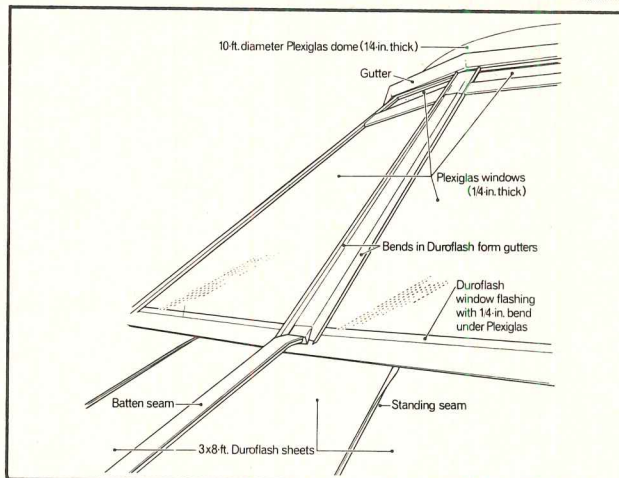
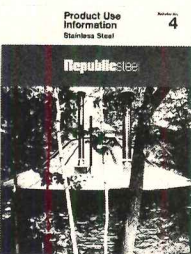

Republicsteel

 Member Steel Service Center Institute

For more data, circle 99 on inquiry card

Efficient building idea: A new built-up roofing system with a completely inorganic reinforcement.



New Perma Ply*-R felts are reinforced with *inorganic* Fiberglas*:

This means they won't rot or char.

Won't wick volatile oils from the asphalt and cause brittleness.

And won't absorb moisture. (The asphalt is embedded into the porous felts to form a monolithic system. This helps prevent wrinkles, buckles, curling, blisters and fishmouths.)

Perma Ply-R felts can be installed and left exposed without

the final surface treatment for up to 6 months (while other trades are completing construction).

Since 1963, Perma Ply-R test roofs and roof sections have been applied in all climate zones in the United States.

Results: not one known failure due to Fiberglas Perma Ply-R.

These Fiberglas felts are now available in all states east of the Rockies.

For more information, write to Mr. A. E. Meeks, Architectural Products Division, Owens-Corning

Fiberglas Corp., Fiberglas Tower, Toledo, Ohio 43659.

Energy Conservation Award

Owens-Corning is offering awards to stimulate new designs and ideas for conserving energy.

Special Steuben sculptures will go to the three architects or engineers who—according to a panel of independent judges—do the best job of designing buildings that don't waste fuel.

See our announcement in this magazine for details.

*T.M. Reg. O.-C.F.

Owens-Corning is Fiberglas



For more data, circle 100 on inquiry card

FACELIFT

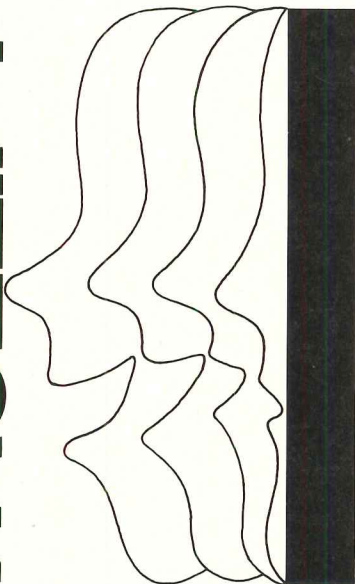

If you have—or are considering—a remodeling commission, we suggest you look into the use of metal lath systems. For a number of very good reasons.

First, they will save you money. Based on actual contractor experience, installed costs for metal lath and plaster exterior wall systems are approximately 50 percent less than comparable masonry or concrete installations.

These walls are easy to estimate . . . Go up fast . . . Are exceptionally durable . . . And weigh only about 20 pounds per square foot.

By utilizing conventional materials, methods and equipment metal lath systems reduce the number of trades on a job, thus simplifying job coordination. And new lathing techniques—including partial prefabrication—have made installation simpler and more economical than ever. Glass or metal panel inserts are readily accommodated, and building irregularities masked.

The unique flexibility of metal lath and plaster systems eliminates many of the design constraints typically associated with remodeling work. Complex curves, angles, projections—whatever the design calls for can be easily rendered. In a variety of finishes that runs the gamut from warm and textured to sleek, natural or colored.

For exterior or interior applications, in the development of overall forms or in variety of intricate detailing, metal lath assemblies can be formed to suit your design—rather than the other way around.

Write us for more information on creative economics with metal lath. We'll be pleased to supply detailed information on material selection and installation of assemblies for both exterior and interior uses.



Metal Lath Association

221 North LaSalle Street
Chicago, Illinois 60601

For more data, circle 102 on inquiry card

PRODUCT REPORTS

continued from page 175

FORCED AIR WALL HEATERS / Units are designed for warming large areas and also for part-time occupancy areas where fast warmth recovery is desired. Features include automatic temperature control, long-life heating element, and easy installation.

■ Ward Leonard Electric Co., Mount Vernon, N.Y.

Circle 343 on inquiry card

EXPANSION JOINT SEAL / Polyurethane elastomer, factory-bonded and mechanically-secured to pre-treated continuous aluminum retainers, is said to provide a monolithic sealed joint that moves in all directions without loss of effectiveness, and is waterproof and dustproof. Seals are supplied with elastomer in three standard integral colors.

■ Construction Specialties, Inc., Cranford, N.J.

Circle 344 on inquiry card

COMPUTER-BASED CONTROLLED ACCESS SYSTEM / Twenty-four hour protection of people, property and documents in buildings is offered by this system, which connects new card readers located at entrance doors to a computer which limits entry according to individual ID card number, door location, or time of day. Any or all controls can be changed or new cards validated by keying new instructions into the computer.

■ IBM, White Plains, N.Y.

Circle 345 on inquiry card



GLASS LIGHTING PANELS / Lamp-hiding characteristics of this heat-resistant, prismatic panel are the result of an arrangement of small, square-based, raised conical prisms.

■ Corning Glass Works, Corning, N.Y.

Circle 346 on inquiry card

FLOOR RESURFACER / Designed for cooler room floors that must be repaired or replaced, epoxy-based product cures at 38 to 50 degrees and hardens in 36 hours, and is said to provide outstanding resistance to abrasion and excellent impact resistance.

■ Stonhard Co., Maple Shade, N.J.

Circle 347 on inquiry card



ALUMINUM PANEL CEILING / Panels are individually snapped into metal stringers. Length and width are unlimited, though the increment standard is four inches. Panels are available in a choice of enamel finishes.

■ Alcan Aluminum Corp., Warren, Ohio.

Circle 348 on inquiry card

more products on page 184

RECORD IMPRESSIONS

A special service offering reprints, reports and back issues.

AIR CONDITIONING

A NEW INTERPRETATION

Updated Special Reports from 1967, 1969 and 1970 by

editor Robert E. Fischer and consultant F. J. Walsh with six new pages of cross referencing and guides to uses of materials

COMMENTS AND REACTIONS

" . . . an article that everyone in the industry—architects, engineers, contractors, manufacturers and even construction consultants should read to better understand the problems each of us faces."

" . . . an excellent treatment of a very difficult subject, and, to be honest, one that I thought would be virtually impossible to cover."

" . . . clearly written . . . technically correct . . . the illustrations are excellent . . ."

64 pages, 2-color, softbound
\$4.95 per copy
bulk prices on request

Record Impressions
ARCHITECTURAL RECORD
330 West 42nd Street
New York, New York 10036
Att: Joseph R. Wunk

No. of copies _____

Please send me: _____

AIR CONDITIONING—
@ \$4.95 per copy

Enclosed is my check

Money order

for \$ _____

NAME _____

FIRM _____

ADDRESS _____

CITY/STATE _____

ZIP _____

"When you turn on 6000 faucets, you can't afford maintenance problems."

When you're one of the most luxurious living complexes in Miami Beach, everything's got to be just right. And that includes the faucet fixtures.

That's why Seacoast Towers installed Delta faucets—6000 of them. For one thing, Delta's sleek simplicity blended beautifully with the decorator touches that abound in Seacoast Towers.

More important, they found that Delta faucets are virtually maintenance-free. Thanks to a patented rotating valve that eliminates the washer. And the maintenance and replacement costs that go with washers.

As Mr. Muss put it: "We're very happy with our Delta faucets. We put them in the apartments, cabanas, maids' rooms and laundries. And they've been practically trouble-free for eight years."

What Delta faucets have done for Seacoast Towers, they can do for you. Write Delta Faucet Company, a Division of Masco Corporation, Greensburg, Indiana 47240.



Model 522

President of Alexander Muss & Sons, Inc.
Builders of Seacoast Towers.

Delta Faucets. They're washerless.



For more data, circle 101 on inquiry card

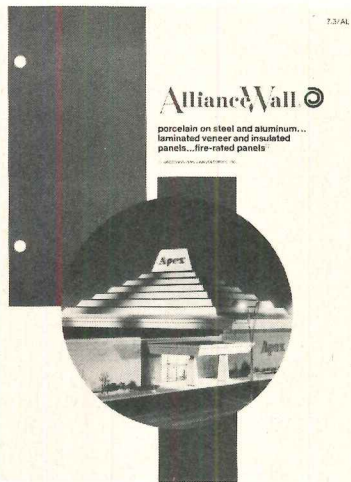

IDEAS FOR ARCHITECTS

SEND FOR YOUR FREE COPY TODAY. 16 idea-packed pages of detailed specifications and technical drawings. Applications of Insulated Porcelain - On - Steel Panels with Polyurethane, Polystyrene, Perlite and Fiberglass Cores. Complete installation information in easy-to-read diagram form.

1½ HOUR FIRE RATING. Complete information about the only Underwriters Laboratory, Inc. listed porcelain-on-steel panel with fire rating of 1½ hours . . . the AllianceWall Series 1500.

VENEER PORCELAIN PANELS. Special section describes interesting applications for interior and exterior use in schools, hospitals, food processing plants, store and building fronts, apartments, motels, cleanrooms and industrial structures.

AllianceWall Corporation, P.O. Box 247, Alliance, Ohio 44601
 European Plant:
 Alliance Europe N.V., P.O. Box 19, 3600 Genk, Belgium

For more data, circle 104 on inquiry card



See us for a moving demonstration.

Come ride the Bendix Dashaveyor people-mover. It's your chance to see Bendix Transportation Systems in action. Our systems can solve a wide range of personal rapid transit problems for places like commercial centers, airports, new communities, campuses and central business districts. We also build control subsystems for mass transit networks.

See us at exhibit area OD-9 and Booth 3520 in Exhibit Hall C, Transpo 72, United States International Transportation Exhibition, Dulles International Airport, May 27-June 4, 1972.

For more information, write or call The Bendix Corporation, Transportation Systems Marketing, 3300 Plymouth Road, Ann Arbor, Mich. 48107. Phone 313/665-9711. TWX 810-223-6041.



For more data, circle 105 on inquiry card

KINNEAR ROLLING SLAT GRILLE

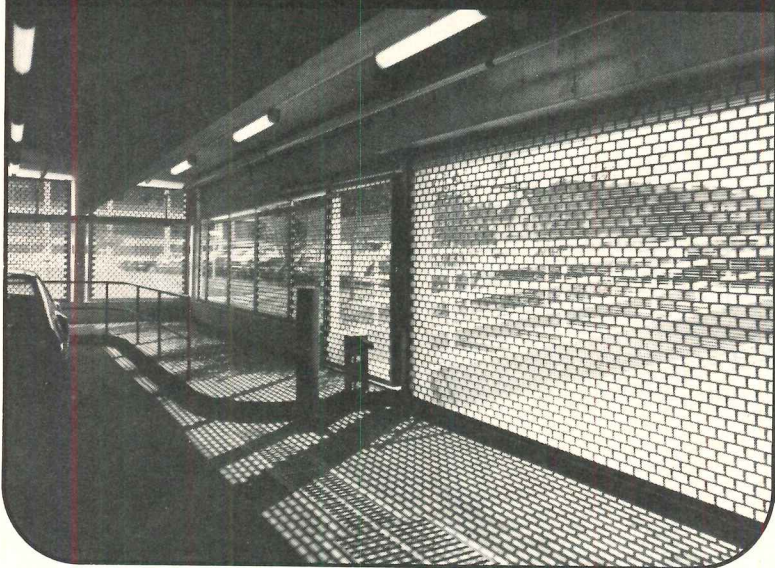

A New Aluminum Design That Adds A Touch Of Beauty To Security

write today for catalog

KINNEAR CORPORATION
and Subsidiaries

1860 FIELDS AVENUE, COLUMBUS, OHIO 43216
OFFICES & REPRESENTATIVES IN ALL PRINCIPAL CITIES
LISTED IN YELLOW PAGES UNDER "DOORS." ALSO SEE SWEET'S!



For more data, circle 106 on inquiry card

Autographed Copies

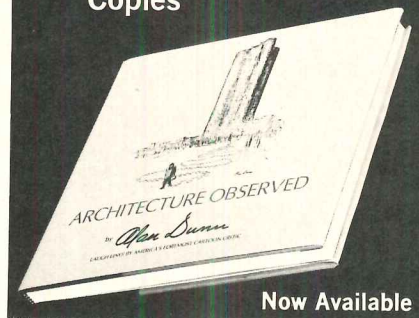

Alan Dunn's ARCHITECTURE OBSERVED

Now Available

Earlier this year, Architectural Record published—in hardcover book form—a collection of 139 of Alan Dunn's best cartoons which appeared in the RECORD over the years. The warm reception of this book by architects and others has prompted us to plan a second printing.

In the meantime, Alan Dunn has graciously consented to autograph a limited number of available copies which are being offered at this time on a first-come, first-served basis. The price of these personally autographed copies is \$10 each.

In addition to the autographed copies, unsigned copies are also available at \$6.95 each. These also make excellent gifts for your business associates and friends—particularly as Christmas gifts. **To order your copies, use the coupon below.**

Architectural Record Books, 330 West 42nd Street, New York, New York 10036
Please send:

— autographed copies of Architecture Observed @ \$10.00 each \$ _____
 — unsigned copies of Architecture Observed @ \$6.95 each \$ _____
 Total \$ _____

Name _____

Address _____

Zip _____

Please enclose payment or your purchase order.

Look who's setting the pace in laminate casework now.

You might have guessed it. St. Charles, the leader in custom steel case-work for more than a quarter of a century, has become the pacesetter in plastic laminates, too! You can see the unmistakable signs of St. Charles know-how, design expertise and craftsmanship in the clean,

crisp lines of every cabinet. In the functional strength of every shelf. And you can specify St. Charles custom laminate casework with confidence that your order will be filled with traditional St. Charles promptness and dependability!



St. Charles® Plastic Laminate Casework

St. Charles Manufacturing Company, St. Charles, Illinois 60174 • Write for our Plastic Laminate Catalog, Dept. AR-9

For more data, circle 108 on inquiry card



continued from page 180

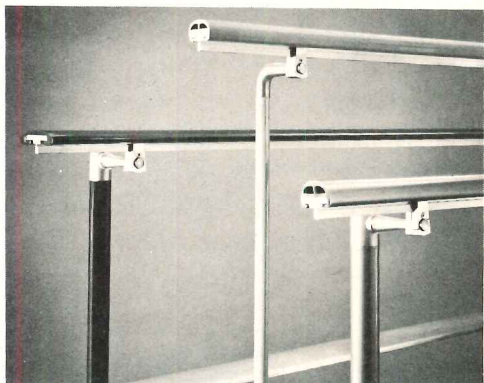

VINYL PLASTIC HANDRAILS / Several handrail shapes and plastic-clad aluminum posts are available. ■ Julius Blum & Co., Inc., Carlstadt, N.J.
Circle 349 on inquiry card

ARTIFICIAL CACTI / Polyurethane plants are 65 in. tall with a 24-in. perimeter. ■ Stendig Inc., New York City.

Circle 350 on inquiry card

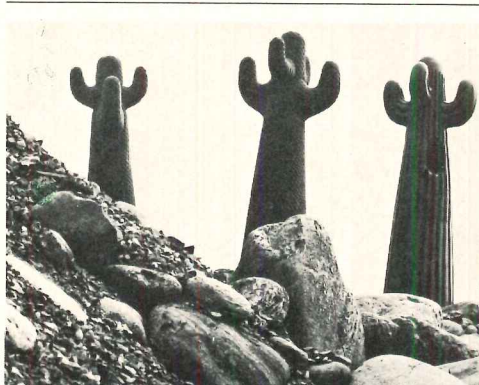

HANGING LAMPS / All are designed for commercial interiors. One employs a satin gold louver encased in a clear glass sphere. Another employs swirling louvers around a central light source. The third luminaire consists of various sized polished chrome rings stacked one upon the other, surrounding a white acrylic diffuser. ■ Lightolier, Jersey City, N.J.

Circle 351 on inquiry card

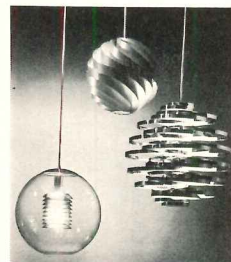

STEEL THERMAL STUDS / Substantially reduced heat flow through exterior load-bearing walls at stud locations is achieved with this product, the manufacturer reports, thereby improving thermal performance, allowing inside and outside wall surfaces to stay free of "ghost-marking," which results from the tendency of dust particles to migrate to cool surfaces more readily than to warm surfaces. Open channel, steel runner track is available to accommodate the studs. ■ United States Steel, Pittsburgh.

Circle 352 on inquiry card



WATER COOLING SYSTEM / The cooling capacity of the manufacturer's water coolers more than doubles through the use of a pre-cooler which uses the chill factor of water waste to lower the temperature of incoming water. At least 50 per cent of the cooling has taken place before the incoming water even reaches the cooling system. Incoming and outgoing water are separated by tubing. ■ Ebco Mfg. Co., Columbus, Ohio.

Circle 353 on inquiry card

THERMAL BREAK SYSTEM / Sliding glass thermal doors, sliding glass windows, and a steel entranceway comprise this aluminum door and window system, which reportedly ends frost and condensation on metal and prevents minus 110 degrees cold of dry ice from jumping the thermal barrier. System is said to protect an entire building against cold, moisture, drafts and noise. ■ Acorn Products Co., Detroit.

Circle 354 on inquiry card

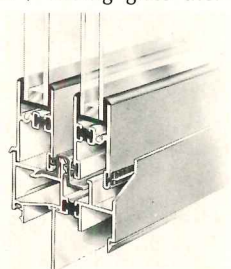

LOAD-BEARING MASONRY STRUCTURAL BLOCKS / Units are said to combine structural strength with high sound-absorption and decorative beauty. They are of a filled or unfilled cavity-slot construction with slotted faces and closed tops that comprise damped resonators. Blocks are for interior and exterior use. ■ The Proudfoot Co., Inc., Greenwich, Conn.

Circle 355 on inquiry card

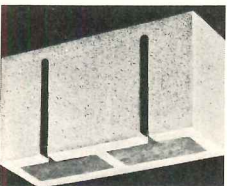

more products on page 189

ACMASEAL[®] keeps expansion joints free of water ...and maintenance

With ACMASEAL preformed joint seals, expansion joints are permanently sealed from water, corrosive elements, and incompressible solids. Accommodating movement and maintaining seal over wide temperature changes, ACMASEAL reduces joint maintenance... lengthens total structure life. Standard architectural size seals and sealing systems available for 3/32" to 3" movement in parking ramps, sidewalks and roof, traffic bearing and control joints, as well as joints for perimeter, vertical, horizontal interior and exterior walls.

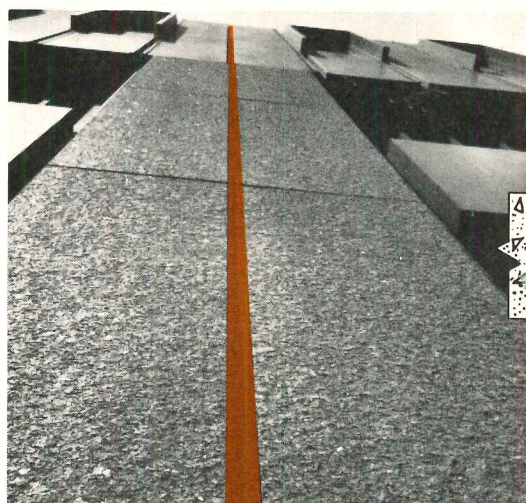

Elastomeric ACMASEAL compresses and expands as ambient temperatures open and close the joint. Constant pressure is exerted against joint sides to maintain seal. At no time does the elastomeric extrusion extend beyond the joint surface.



Virtually maintenance-free ACMASEAL is the economical answer to many expansion joint sealing problems. Acme engineers will help specify to your particular requirements. For full technical data and specifications, write...

acme

HIGHWAY PRODUCTS CORPORATION
33 CHANDLER ST., BUFFALO, N.Y. 14207 ■ (716) 876-0123

Products illustrated are covered by U. S. and Canadian patents.

For more data, circle 109 on inquiry card

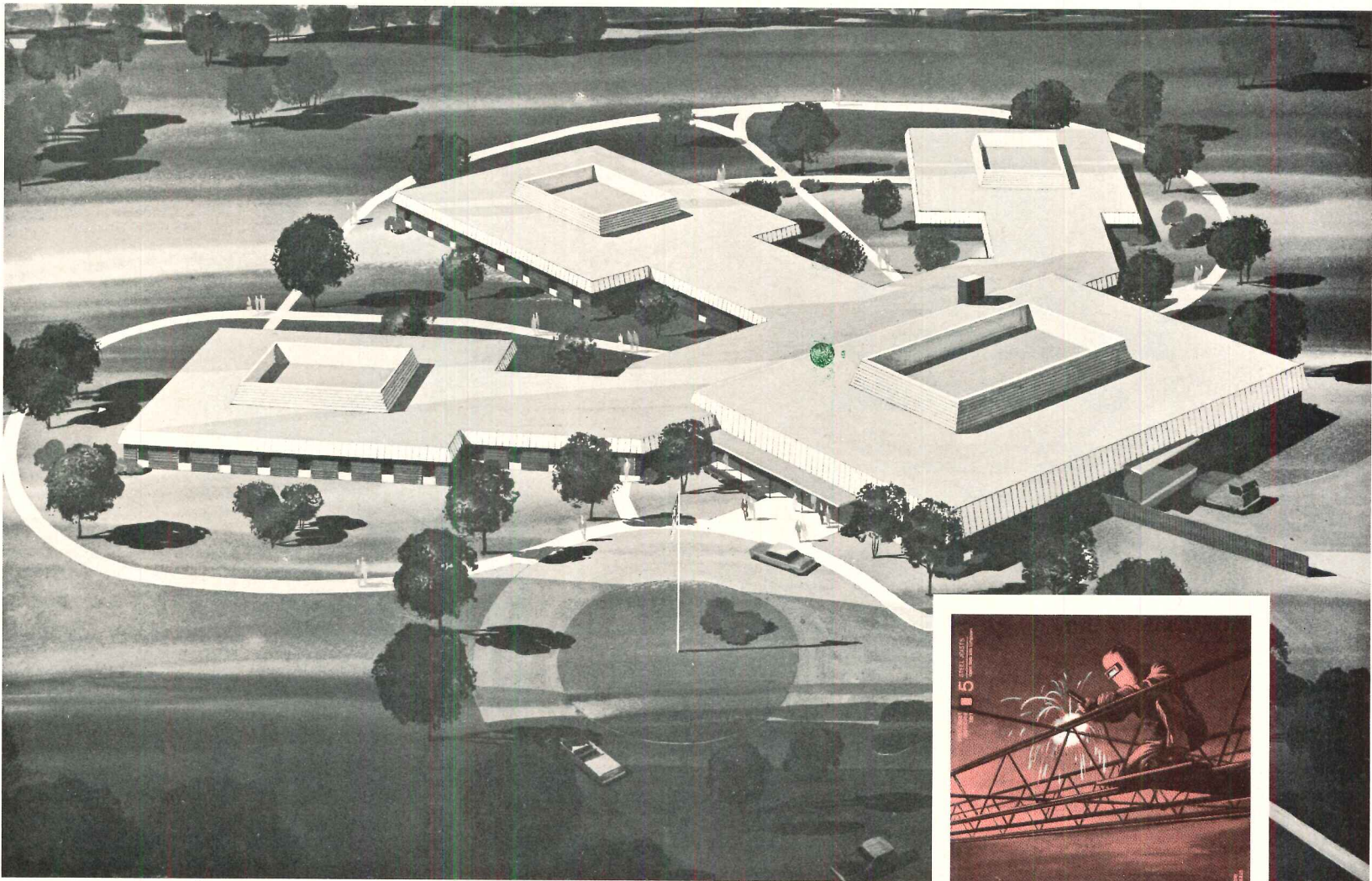

Why steel joists were the right answer to this building need

MONTGOMERY COUNTY INFIRMARY: A MODERN HEALTH FACILITY AT ECONOMICAL COST

Montgomery County Infirmary in Amsterdam, New York, offers the finest facilities and professional staff for general nursing care. The design includes three 40-bed wings connected with a center hub housing adjunct facilities to service each wing, and basement area for general storage, mechanical equipment, laundry, additional service and storage areas. Total area is approximately 60,000 square feet main floor.

The type of construction and reason for selection? Architect William E. Cooper explains: "The building is constructed primarily of steel frame on concrete foundation with steel joists between structural steel beams. Over the steel joists, a steel deck, two inches of rigid insulation and built-up gravel surface roof. This type of construction has been proven the most economical of any we have encountered. Even when we eliminate the steel frame and use bearing wall construction, steel joists are our first choice, because it is relatively easy to meet the fire-rating requirements by virtue of the suspended ceilings."

Yes, for this and many other types of construction,

open web steel joists offer the greatest efficiency and economy. Get the complete story. Send coupon for your free copy of the Specifications and Load Tables for Open Web Steel Joists and Longspan Steel Joists.



STEEL JOIST INSTITUTE

7th Floor, 2001 Jefferson Davis Hwy.
Arlington, Va. 22202

For more data, circle 110 on inquiry card

STEEL JOIST INSTITUTE

7th Floor, 2001 Jefferson Davis Hwy.
Arlington, Va. 22202

Please send me a copy of your Specifications and Load Tables.

NAME _____

TITLE _____

FIRM _____

ADDRESS _____

CITY _____ STATE _____ ZIP CODE _____

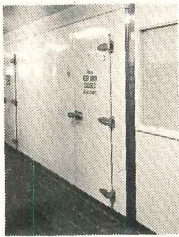

*Kold-Draft keeps things cold at the Frontier.

13 Kold-Draft walk-in cooler/freezers provide 11,831 cubic feet of cooling and freezing space at the Frontier House in Las Vegas. With Kold-Draft's add-on capability, there's room to grow.

Sweets Catalog 11.24/UN (in Canada Sweets $\frac{11fs}{UNI}$)

KOLD-DRAFT 

Division of Uniflow Manufacturing Company, Erie, Penna. 16512

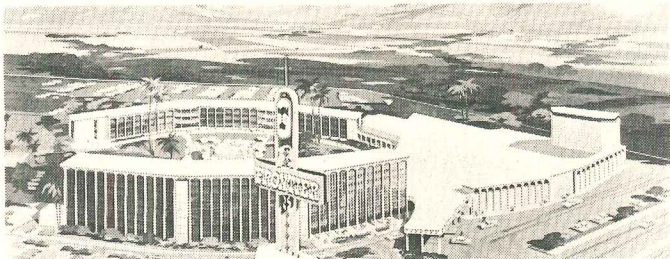

*Trademark Reg. U.S. Pat. Off. Copyright 1972 Uniflow Mfg. Co., Erie, Penna.

For more data, circle 112 on inquiry card

Armco, a quality supplier to the Architectural Market, now offers Duranar 200[®], a long-life coating based on Kynar*, for the entire Armco Building System. Write Armco Building Systems, P.O. Box 800, Middletown, Ohio 45042 for complete information.

*Kynar is a registered trademark of the Pennwalt Corporation



For more data, circle 111 on inquiry card

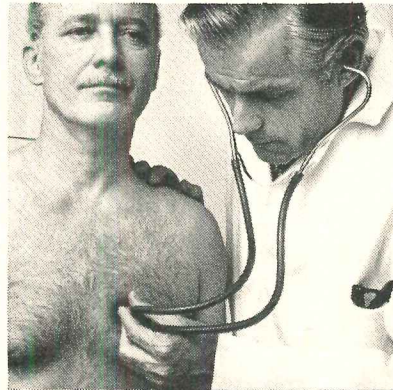

The annual checkup. It may save your life.

There's only one way to be sure you're in perfect health. Have an annual checkup. It gives your doctor a good chance to catch any minor ailment before it becomes a major illness. Or a fatal one.

**We want to wipe out cancer
in your lifetime. Give to the
American Cancer Society.**



This space contributed by the publisher.

Bright idea



Washfountains in the corridor are spoilsports. They take all the fun out of washing up. Like squirting other kids. Plugging the plumbing. The other things kids do when they're not watched. With vandal-proof Bradley Washfountains in the corridor, students get in and out of toilet rooms quickly, wash where they can be supervised. Semi-circular Bradglas® Washfountains made of reinforced polyester are ideal for the job. The 54" size projects only 35¼" from the wall... serves four students at once from one set of plumbing connections. Smart new styling... 11 bright colors. Durable, non-porous, fire-safe. Won't chip, crack or peel... swell, shrink or warp. Comparable to steel on a strength-to-weight basis. See your architect or consulting engineer. And write for latest literature. Bradley Washfountain Co., Fountain Blvd., Menomonee Falls, Wis. 53051.

from Bradley!

Leader in Washroom Fixtures and Accessories



For more data, circle 114 on inquiry card

We can make glass to match your imagination.

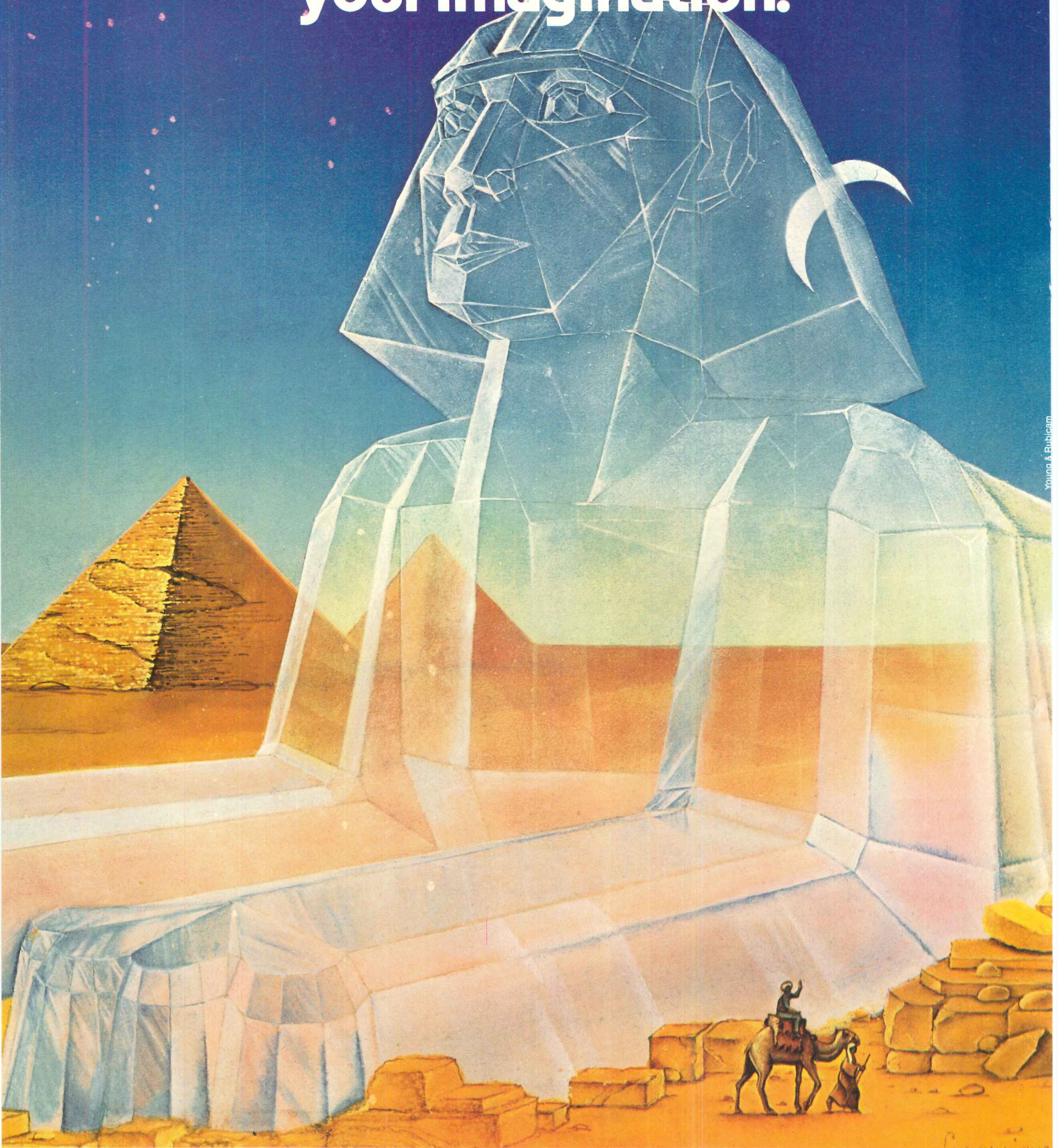

BSN likes glass, architecture and architects who have imagination.

This is why we have been making glass for centuries at our factory the "Hall à Pots", all kinds of glass. Just ask us, and we can make a glass as

thick as you want, the exact colour you need, the ideal form you have in mind.

It doesn't make a difference where you are either: for example we came to Sydney with our technicians and engineers to help realize the enormous

project of the famous Sydney Opera House. BSN can match the wildest architectural dream. Tell us yours.

BSN Export, 17 bis, bd Hausmann, 75-Paris 9^e.
Phone: 770-93-79.

BSN 

For more data, circle 115 on inquiry card

continued from page 184

PERFORATED AIR DIFFUSERS / Adjustable damper and pattern control is built in. A pair of overlapping damper discs within the diffuser are easily adjusted to deliver a variety of distribution patterns. Perforated face plate swings open on either of two sides and is removable for access to the damper, pattern control discs or duct. ■ Connor Engineering Corp., Danbury, Conn.

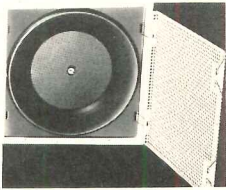

Circle 356 on inquiry card

RADIOISOTOPE WORK STATIONS / Six different modules are available for safe, convenient storage and handling of radioisotopes in laboratories. Lead-shielded stainless steel storage walls with shielded covers can be supplied in the work tops. ■ Kewaunee Scientific Engineering, Adrian, Mich.



Circle 357 on inquiry card

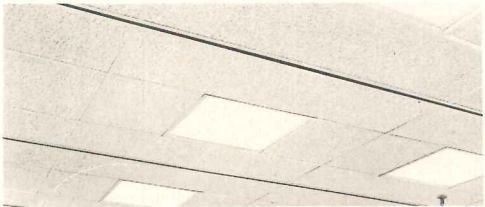

FLEXIBLE CEILING SYSTEM / Component flexibility in schools is simplified through use of grid suspension members from which movable partitions can be easily detached and relocated. Air distribution pattern can be controlled from below the ceiling. ■ Conwed Corp., St. Paul, Minn.

Circle 358 on inquiry card

PORTABLE TELEPHONE / Unit is said to offer automatic dial capabilities without operator assistance. User can dial any call directly if he is within range of the telephone company's terminal equipment. The telephone is fully compatible with the mobile services offered by the telephone companies. Features include an enclosed speaker, built-in antenna, and a case lock. ■ Integrated Systems Technology, Inc., Garland, Tex.



Circle 359 on inquiry card

SLIDING GLASS DOOR / Unit can be used as a slab-to-slab sliding glass wall system for high-rise commercial or residential applications. Test unit withstood an air pressure difference greater than 6.24 lbs per sq ft without leakage as a heavy water spray was directed simultaneously at the outside glass. This test is equivalent to 8 in. of rainfall per hour with a 50 mph wind. ■ Kawneer Co., Niles, Mich.



Circle 360 on inquiry card

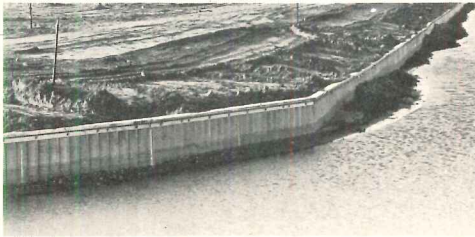

MARINE WALL SYSTEM / Patented retaining wall's basic element is a corrugated aluminum bulkhead sheet capped by an aluminum extrusion. Deadman anchors on 10-ft centers are connected to pre-drilled holes in the bulkhead sheet. The wall features a joint through which even "sugar sand" cannot pass. ■ Kaiser Aluminum & Chemical Corp., Oakland, Calif.

Circle 361 on inquiry card

COMPUTER-CONTROLLED BUILDING AUTOMATION SYSTEM / An integral mini-computer designed to building market criteria is featured. Standardizing the mini-computer and all associated hardware and software modules has substantially lowered costs, making genuine, real-time computerized automation realistic for even the smaller building budget, the company reports. System is available in both simple and expanded configurations. Simplest is the stand-alone system shown here, consisting of a single loop system. ■ Johnson Service Co., Milwaukee.



Circle 362 on inquiry card

Discover Cramer

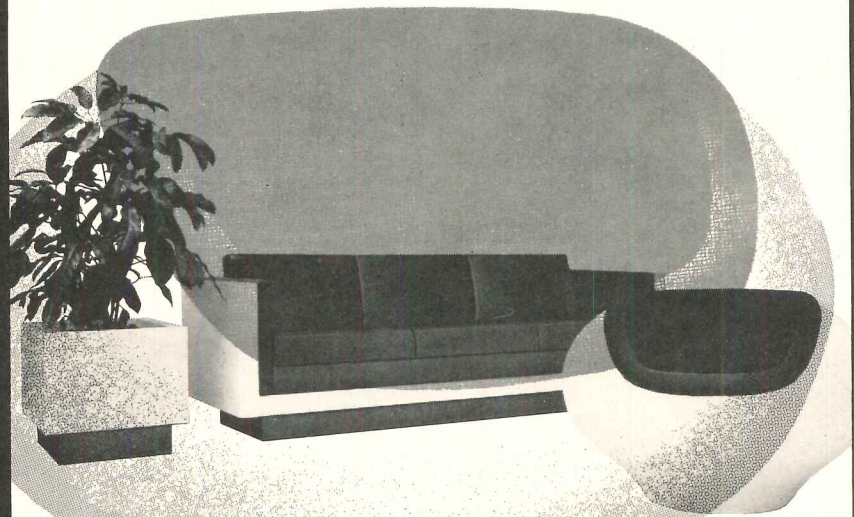

and you discover imagination in fiberglass

Your choice of 10 designer colors in sofas, club chairs, round chairs, benches, end tables, cocktail tables, planters.

For literature call (913) 621-6700 or write



625 Adams Street, Kansas City, Kansas 66105
A Subsidiary of OLIX INDUSTRIES INC.

Chicago Merchandise Mart Showroom 1197
Sweets Interior Design File—Section F3a

For more data, circle 116 on inquiry card

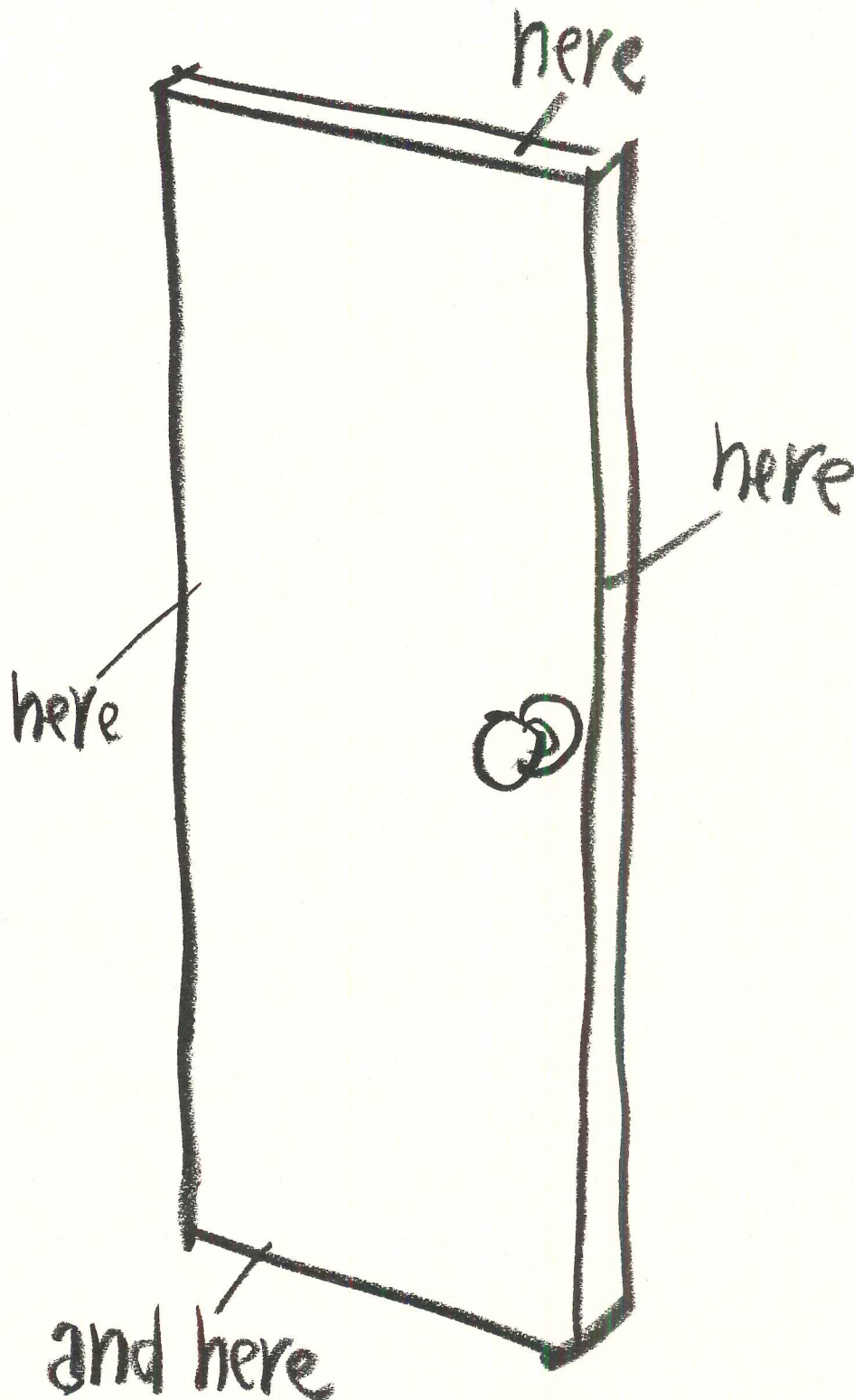

Announcing several small changes in our 3/4-hour fire door.

You can now match the wood on the top, the bottom and the side edges of this door with the wood on the face.

There used to be two choices for the edges, Birch or Maple. (Have you ever tried to make Birch look like Oak?) Now you have seven choices for edges and face veneer: Cherry, Teak, Birch,

Oak, Walnut, Lauan and Elm.

Another small but important change. This door doesn't have (or need) fire retardant treatment, which eliminates the possibility of unsightly stains bleeding through the finish. (The mineral core, not the fire retardant treatment, is what makes this door an

effective fire barrier.)

Of course, you can still depend on these unchanging features: a UL rating for Class C openings, sizes to 4x10 feet, lifetime interior guarantee and incombustible mineral core.

For complete details, write Weyerhaeuser, Box B-9133, Tacoma, Washington 98401.



For more data, circle 117 on inquiry card

OFFICE LITERATURE

For more information circle selected item numbers on Reader Service Inquiry card, pages 205-206.

METAL DOORS / A recently published catalog presents comprehensive information on a line of rolling metal doors and fire doors, rolling grilles, and sliding grilles. Doors are available in galvanized steel, aluminum and stainless steel. ■ Cornell Iron Works, Inc., Wilkes-Barre, Pa.*
Circle 400 on inquiry card

PRE-FABRICATED INSULATED MODULAR PANEL BUILDING SYSTEM / Panels are designed for erection of refrigerated plants, cold storage warehouses, freezers, coolers, and other low temperature structures. Stressed skin feature is said to provide a structural as well as insulated panel with a higher strength-to-weight ratio. Aluminum, aggregate stone, and other exterior facings are available in various colors and finishes. ■ Modular Panel Co., New Bedford, Mass.
Circle 401 on inquiry card

EMERGENCY LIGHTING / UL-approved system provides emergency lighting guaranteed unconditionally for five years. Lighting is an integral part of the building's normal fluorescent system. A 10-minute movie and applications manual are available. ■ Lithonia Lighting, Conyers, Ga.
Circle 402 on inquiry card

INDOOR/OUTDOOR SEATING / Fiberglass contour seats come in a wide range of colors. All units have aluminum legs. Seating units are also available for commercial use. Installation photos are included in a 4-page brochure. ■ Wise Seating, Inc., Muncie, Ind.
Circle 403 on inquiry card

GLASS FOR CONSTRUCTION / Technical catalog includes information on the company's reflective glass, transparent mirrors and clear, heat-absorbing, insulating, safety, protective, decorative and spandrel glass. ■ Libbey-Owens-Ford Co., Toledo, Ohio.*
Circle 404 on inquiry card

WALL INSULATION SYSTEM / Rigid foam insulation and metal furring channels comprise the system. No adhesives are used. Physical properties, installation data and specifications are included in an 8-page brochure. ■ W. R. Grace & Co., Cambridge, Mass.*
Circle 405 on inquiry card

HEAT RESISTING FLAT GLASS / Pyrex brand products for science and industry are described in a 24-page catalog, including infrared-reflecting glass, furnace glasses, and heat shields. ■ Kaufman Glass Co., Wilmington, Del.
Circle 406 on inquiry card

COMMUNICATIONS SYSTEMS / A 4-page catalog describes a line of audio-visual and television systems in current use. ■ TeleVisual Systems, Inc., Fairfield, N.J.
Circle 407 on inquiry card

STRUCTURAL CLAY TILE STANDARDS / The latest standards for facing tile, both ceramic glazed and natural finish, reflect ASTM changes. Copies of the 17-page guide are now available. ■ Facing Tile Institute, Chicago.*
Circle 408 on inquiry card

SOAP SPRAY SYSTEM / This addition to the company's complete line of institutional shower systems and components is designed to reduce time, maintenance and possible hazard in the shower room by instantly delivering lather directly on the bather. One unit can service several rooms and many shower stalls. ■ Metcliff Mfg. Co., Inc., Burlingame, Calif.
Circle 409 on inquiry card

BUILDING SYSTEMS / A 42-page catalog describes and illustrates the company's standard building lines in addition to insulated wall systems for controlled environment structures. ■ Stran-Steel Corp., Houston.*
Circle 410 on inquiry card

ROOF DECK SYSTEMS / A 12-page brochure describes lightweight insulating concrete over galvanized metal centering, structural concrete, polystyrene-vermiculite systems, and thermal-setting perlite-asphalt roof insulation. ■ W. R. Grace & Co., Cambridge, Mass.*
Circle 411 on inquiry card

*Additional product information in Sweet's Architectural File

more literature on page 197

Discover Cramer

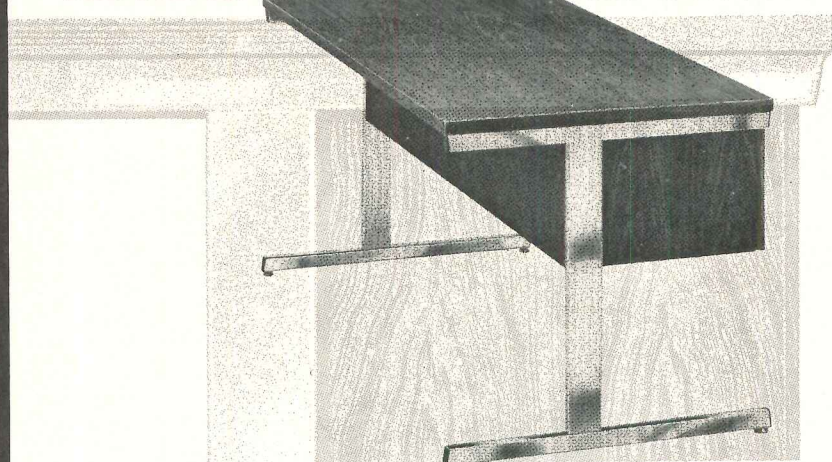

and you discover Motiva — with unequalled variety in work stations.

For reception area all the way to senior executive offices, Motiva offers a collection of sixty-three different desks and twenty-three different credenzas — each designed to save floor space. And each with coordinated filing systems. Motiva is ideal for office landscaping or open office. For literature call (913) 621-6700 or write



625 Adams Street, Kansas City, Kansas 66105
A Subsidiary of OLIX INDUSTRIES INC.

Chicago Merchandise Mart Showroom 1197
Sweets Interior Design File — Section F3a

For more data, circle 118 on inquiry card

NO PLACE TO HIDE!

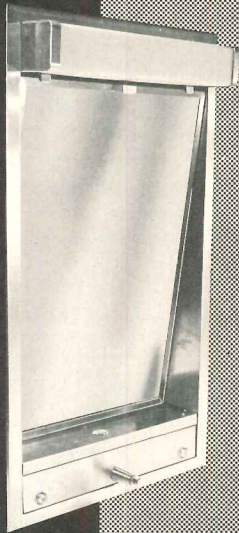

Parker Type 302 Stainless Steel Washroom Units provide NO PLACE FOR DIRT TO HIDE. One piece frame has no open miters, easy to clean. Specify Parker... There's a functional unit to fit every job. See our complete line in Sweet's Architectural file (10.17/Pa) or WRITE FOR 44 PAGE CATALOG!

charles
parker



290 PRATT STREET
MERIDEN, CONN. 06450
TEL: 203-235-6365

For more data, circle 119 on inquiry card

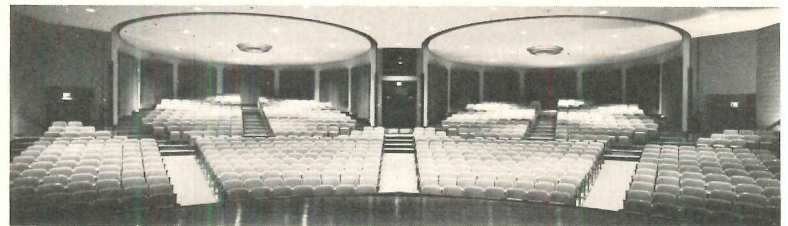

Macton turntables turn idle auditorium space...



into useful classrooms.



SEE?

Yet at the touch of a button you can have the full school auditorium back again... in seconds. Making space many times more useful is the reason for the TDA - Turntable Divisible Auditorium. Our new 24-page booklet shows plans of several recent schools that use the TDA concept. It also describes design details and costs. Write to: The Macton Corp. On-the-airport, Danbury, Conn. 06810. Tel.: (203) 744-6070.

MACTON TURNTABLES

For more data, circle 120 on inquiry card

Everything you
always wanted to
know about
sprinklers*

*BUT WERE AFRAID TO ASK

Our new, 32-page SPRINKLER SYSTEM GUIDE lays it all out. Building codes... insurance considerations... fire protection costs... and much more we can't tell here. Dozens of explicit illustrations. It's free. Send for it... before you get burned!



I've got to have your new
Sprinkler System Guide.
Send it quick!

Name _____

Company _____

Address _____

City _____

State _____ Zip _____



THE VIKING CORPORATION
210 N. INDUSTRIAL PARK ROAD
HASTINGS, MICH. U.S.A. 49058

1,344 STANDARD SIZE WALK-INS

When you need a walk-in cooler, we'll go to great lengths to meet your needs. Anything from 5 by 5 by 6½ ft. up to 20 by 18 by 10 ft., with 1,342 sizes in between. Nor-Lake walk-ins are fast to erect and enlarge. Simple to relocate. Underwriters' Laboratories approved.

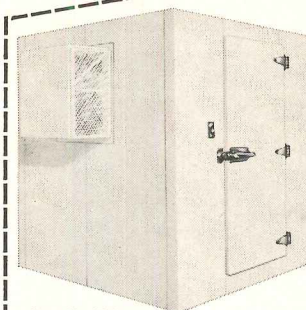

PLEASE SEND ME MORE
INFORMATION ON NOR-LAKE
WALK-IN COOLERS.

My temperature requirements
are: _____

Name _____

Address _____

City _____

State _____

ZIP _____

MAIL TO:



NOR-LAKE INC.

Second and Elm, Hudson, Wisconsin 54016 Dept. 3173



For more data, circle 122 on inquiry card

For more data, circle 121 on inquiry card



American Airlines Concourse, Washington National Airport, Washington, D.C. • Giuliani Associates/Aviation Architects and Planners, Washington, D.C.

LCN Door Closers

For smooth, efficient control of most all doors, interior or exterior . . . in heavy or light traffic areas. The one in the picture is an LCN Smoothee®, stop-face mounted 4110 Series. It features an arm that folds parallel to the door, adjustable hydraulic back-check and adjustable spring power. For full particulars, talk to your Hardware Consultant or write LCN. Listed in Sweets, Section 8.

LCN Closers, Princeton, Illinois 61356.

For more data, circle 123 on inquiry card

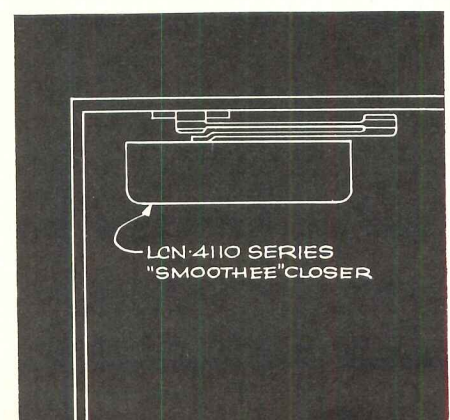

RECORD IMPRESSIONS

A new service offering reprints, reports and back issues.

- ③ RECORD INTERIORS of 1971 20 pgs. 4-color .50 per copy
- ④ MUSEUMS 16 pgs. 4-color .50 per copy
- ⑤ CREATING CONSOLIDATED CLINICAL TECHNIQUES SPACES FOR AN EXPANDING ROLE IN HEALTH CARE 8 pgs. 4-color .50 per copy
- ⑥ DESIGN FOR MERCHANDISING 16 pgs. 1.00 per copy
- ⑧ AIRPORTS 16 pgs. B&W 1.00 per copy
- ⑨ AIR CONDITIONING: A NEW INTERPRETATION
Updated reports from 1967, 1969, 1970
64 pgs. 2-color softbound 4.95 per copy
- ⑩ RECORD HOUSES 1968—2.00 per copy
- ⑪ CORRECTIONAL ARCHITECTURE 16 pgs. 2-color .50 per copy
- ⑫ RECORD HOUSES 1970—2.00 per copy
- ⑬ CAMPUS DESIGN FOR SUCF—AN ANALYSIS OF EXCELLENCE
24 pgs. 2-color 1.00 per copy
- ⑭ SEALING JOINTS: 1968 SPECIAL REPORT
8 pgs. 2-color .50 per copy
- ⑮ BUILDING FOR A BROAD SPECTRUM OF HEALTH CARE
16 pgs. B&W 1.00 per copy
- ⑯ URBAN HOUSING: 30 pgs. 2-color 1.00 per copy
- ⑰ ARCHITECTURE IN THE 1970's 49 pgs. 2-color 1.00 per copy
- ⑱ RECORD HOUSES 1971—3.25 per copy
- ⑲ PLANNING DISCIPLINES FOR AUDIO-VISUAL FACILITIES
16 pgs. 4-color 1.00 per copy
- ⑳ LOW-INCOME HOUSING 16 pgs. 4-color 1.00 per copy
- ㉑ SIX INTERIORS—AUGUST 1971 12 pgs. 4-color .50 per copy
- ㉒ HOSPITALS 16 pgs. 4-color 1.00 per copy
- ㉔ 5 CONTEMPORARY SCHOOLS 14 pgs. b&w .50 per copy
- ㉕ RECORD INTERIORS of 1972 16 pgs. 4-color .50 per copy
- ㉖ DESIGN FOR A VARIETY OF CAMPUS LIFE STYLES
18 pgs. 4-color .50 per copy
- ㉗ SHOPPING MALLS IN SUBURBIA 16 pgs. 4-color 1.00 per copy
- ㉘ SUBURBAN OFFICE BUILDINGS 16 pgs. 4-color 1.00 per copy
- ㉙ "SPECIAL"—75th ANNIVERSARY ISSUE—LIMITED QUANTITY
"NEW AGE OF ARCHITECTURE: NEW ROLE OF THE ARCHITECT."
July 1966 2.00 per copy

PREPAID ORDERS ONLY

Record Impressions
ARCHITECTURAL RECORD
330 West 42nd Street
New York, New York 10036
Att. Joseph R. Wunk

No. of copies

- | | | | |
|---------|---------|---------|---------|
| ③ _____ | ⑥ _____ | ⑩ _____ | ⑲ _____ |
| ④ _____ | ⑦ _____ | ⑪ _____ | ⑳ _____ |
| ⑤ _____ | ⑧ _____ | ⑫ _____ | ㉑ _____ |
| | ⑨ _____ | ⑬ _____ | ㉒ _____ |
| | | ⑭ _____ | ㉓ _____ |
| | | ⑮ _____ | ㉔ _____ |
| | | ⑯ _____ | ㉕ _____ |
| | | ⑰ _____ | ㉖ _____ |
| | | ⑱ _____ | ㉗ _____ |
| | | | ㉘ _____ |
| | | | ㉙ _____ |

Enclosed is my check Money order for \$ _____

NAME _____

FIRM _____

ADDRESS _____

CITY/STATE _____ ZIP _____

valid through 7/31/72

4-72

MUSSON "500" Treads-Decorative

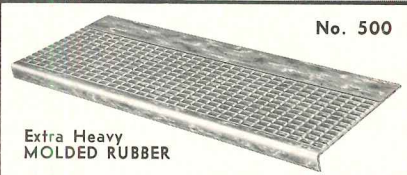
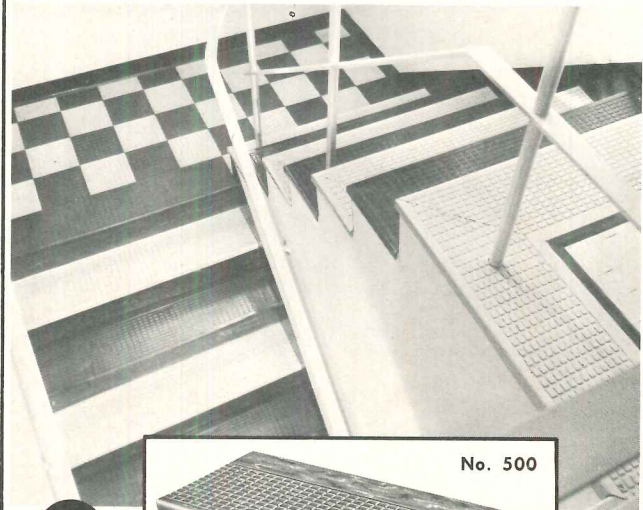

Also
500-P
Rubber
Tile

BEST FOR THE BIG JOBS—SMARTER, SAFER

Selection of colors to enhance any styling. Includes Black or Marbelized Red, Green, Gray, Mahogany, Beige, Walnut, Birch, Putty Gray, Oatmeal and Black. Heaviest rubber treads sold. Safety designed. $\frac{5}{16}$ " thick. $12\frac{1}{2}$ " deep. Lengths from 24" to 72".

Write For Catalog, Samples, Prices

THE R. C. MUSSON RUBBER CO.

1320 Archwood Ave.

Akron, Ohio 44306

For more data, circle 124 on inquiry card

We need young professionals to work in the Southeastern United States directly for the manager of the architectural Department of one of the world's largest design-build constructors.

ARCHITECT

Young architectural graduate of 3-5 years varied experience with emphasis in commercial and industrial projects to assist in department management and development of standards and production methods. Should have broad interests and be desirous of eventual management position. Registration desirable, but not necessary.

CIVIL ENGINEER

Young engineering graduate with 5 plus years experience in primarily topographic and drainage design to work in developing all site, topographic, and drainage plans and calculations for the company's design projects, and in developing site work and site drainage specifications and design standards. Must be capable of working directly with owner and with state and federal agencies in developing proper site designs. License is desirable, but not necessary.

SPECIFICATION WRITER

Candidate of 5 plus years experience in writing specifications for a variety of project types with emphasis in industrial and commercial construction, to work in writing job specifications, primarily architectural, civil, and structural, and correlate the engineering specifications written by others. Also to write and maintain master specification with aim of developing computer system of job specifications production on company's computer. Must be dedicated to the art of specification writing and an active member of the construction specifications institute.

Excellent starting salary with relocation and comprehensive company benefits included. Please submit your resume in confidence to: Mr. Clyde Rector

DANIEL CONSTRUCTION CO.

A Division of Daniel Internation Corporation

Daniel Building
Greenville, South Carolina 29602
An Equal Opportunity Employer

 The guide spec that opened
 countless doors to carpet

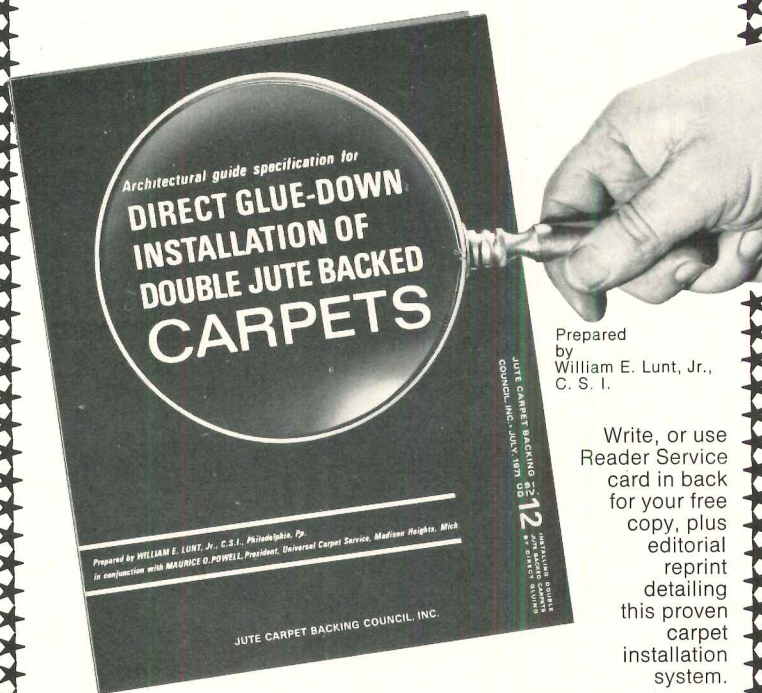

Prepared
 by
 William E. Lunt, Jr.,
 C. S. I.

Write, or use
 Reader Service
 card in back
 for your free
 copy, plus
 editorial
 reprint
 detailing
 this proven
 carpet
 installation
 system.

JUTE CARPET BACKING COUNCIL, INC.
 25 Broadway • New York, NY 10004

 For more data, circle 89 on inquiry card

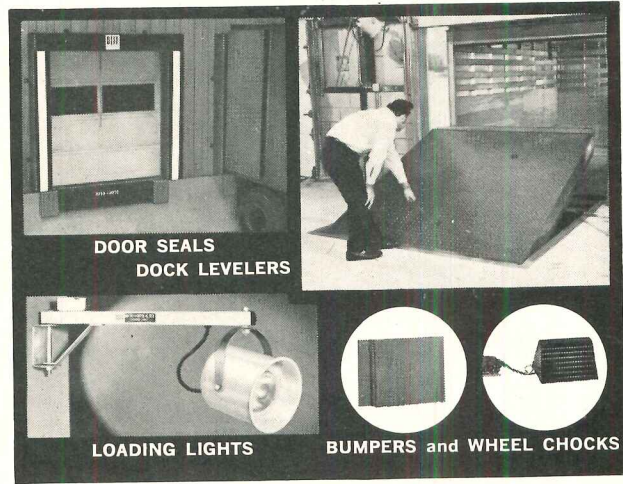

RITE-HITE LOADING DOCK EQUIPMENT

Solve all your loading dock design problems with one quality source. Rite-Hite pioneered efficient mechanical dock leveling equipment over 25 years ago and now offers dozens of models to meet your exact requirements. Also choose from Rite-Hite Door Seals, Rite-Hite Loading Lites, Rite-Hite Dock Bumpers and Wheel Chocks for total dock safety. Sold and serviced coast-to-coast.

FREE Send today for your
 Modern Dock Design Kit

RITE-HITE CORPORATION
 6005 S. Pennsylvania Ave., Cudahy, Wisconsin 53110
 IN CANADA: Matthew Moody Ltd.
 251 St. Louis Street, Terre Bonne, P.Q., Canada

For more data, circle 90 on inquiry card

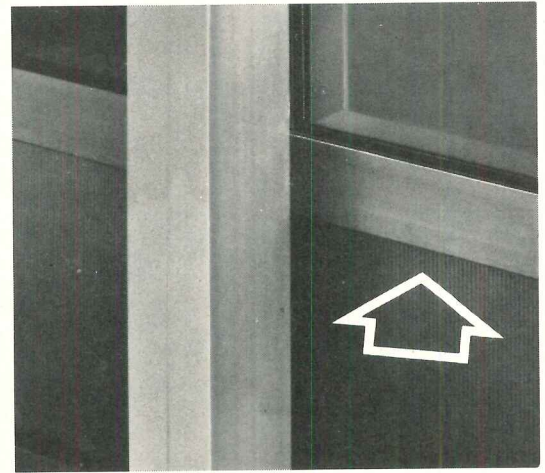

the secret

of a modular stack system for high rise or low rise is an exclusive separate drainage at each horizontal, individually sealed and weeped!

Here's a modular system so versatile you can use it to design a filtration plant, factory or even a spectacular high rise. Other modular systems are limited to 1 or 2 stories because they drain through the verticals only. The MUL-480 has concealed weeps and a pressure equalization opening to prevent a reverse flow of water.

Shipped in pre-assembled modules which can be rotated into place. Simplified construction saves erection cost at the job site. This Amarlite aluminum system provides for both vertical and horizontal expansion. Available for 1/4" to 1 7/8" glazing.

MUL-480 can be specified in clear, anodized or Amanodic colored hardcoat finishes. Write for specifications file Section 8, or Sweets File 8.1 An.



4785 Fulton Industrial Boulevard, S.W.
 Atlanta, Georgia 30305 • Telephone: (404) 691-5750

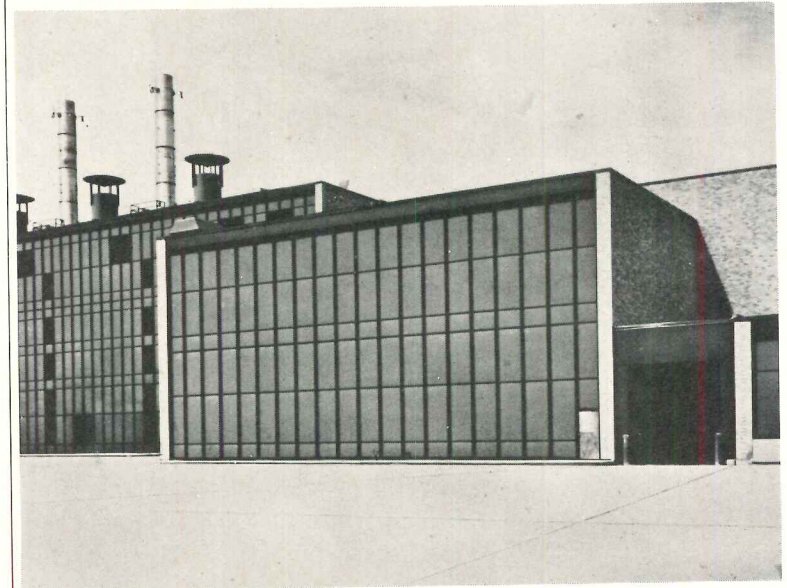

For more data, circle 125 on inquiry card

When You Specify Terrazzo, Specify Hillyard Onex-Seal II®

More than half a million square feet of this lustrous terrazzo was sealed and finished with Onex-Seal II in accordance with specifications in the Hillyard Uniform Numbered File—Division 9.

Onex-Seal II is a buffing seal—finish of the type recommended by the National Terrazzo

Mosaic Association for Portland and Oxychloride Terrazzo in all colors (even white).

It insures that Portland and thin set terrazzo floors are properly sealed for protection and finished for beauty. Sealing guards against penetration of dirt and stains while enhancing the natural beauty of all colors, even white. It prevents efflorescence, produces a hard non-flaking, slip resistant mirror finish.

To insure that any floor will continue to live up to the standards you specify, call on a trained Hillyard Architectural Consultant to recommend correct finish and maintenance programs.

See our specifications manual in Sweet's and write for Uniform Numbered Files for every type of floor.

HILLYARD
FLOOR TREATMENTS

ST. JOSEPH, MISSOURI U.S.A.
Totowa, N.J. San Jose, Calif.
Minneapolis, Minn. Dallas, Tex.
Boston, Mass.

IN CANADA: Calgary, Alberta
London, Ontario



The most widely recommended and approved treatments for every surface

Houston International Airport Houston, Texas

*Architects: Golemon & Rolfe, Houston;
Pierce & Pierce, Houston*

To Gates 6 7 8 9 10

For more data, circle 127 on inquiry card



Three floors
are just as easy
with the
KALWALL®
system

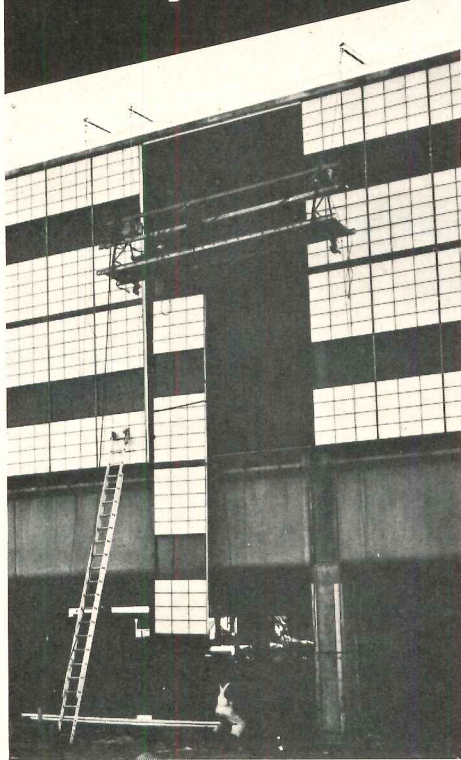

Plus, Kalwall is lower in cost than most other wall systems, even block and brick!

Low in cost to buy, low in cost to erect because of its light weight (1½ lbs/sq. ft.) and the structure can be designed lighter, saving even more.

Extremely high insulation values — .40 to .15(U), controlled, diffused, natural light (so no ugly drapes or blinds), even further savings.

Design potential is unlimited too — it has already been used in over 40,000 buildings, many award winners!

Write or phone for information. Or, why not let us make a full presentation? The time spent will be worthwhile.

KALWALL

CORPORATION
88 Pine Street
Manchester, N.H. 03103
Phone 603-627-3861

Complete translucent wall and skyroof systems.

For more data, circle 126 on inquiry card

OFFICE LITERATURE

continued from page 191

GABIONS / A 58-page booklet describes the manufacturer's line of compartmentalized rectangular containers made of galvanized steel hexagonal wire mesh filled with stone. Applications include revetments, line embankments and channels, and retaining walls. ■ Terra Aqua Conservation, Reno, Nev.

Circle 412 on inquiry card

SURFACE BONDING CEMENT / A material which bonds concrete block without mortar is described in literature. Concrete block is stacked, material is applied to both sides of the block, and surface cures in the manner of conventional cement mixes. Advantages include less labor output and block construction which is reportedly two to three times stronger than construction using conventional mortar. ■ W.R. Bonsal Co., Lilesville, N.C.

Circle 413 on inquiry card

NOISE ISOLATION SYSTEMS / A 12-page design guide on the control of impact and airborne noise in buildings is available. Applications include gymnasiums, bowling alleys and mechanical-equipment areas. The company's line of composite kinetic systems is featured. ■ Consolidated Kinetics Corp., Columbus, Ohio.*

Circle 414 on inquiry card

ALL-WEATHER CONSTRUCTION / Two technical publications, "Recommended Practices for Cold Weather Masonry Construction," and "Guide Specifications," describe proven techniques which allow construction to continue in bad weather. Price is \$.50, including postage. ■ International Masonry Industry All-Weather Council, 208 So. LaSalle Street, Suite 480, Chicago, Ill., 60604.

BATTEN ROOF SYSTEM / Five types of spires and steeples are described in an 8-page brochure. Applications of mansard and batten roofing for a variety of structures in a range of metals are illustrated. Specifications are included. ■ Overly Mfg. Co., Greensburg, Pa.*

Circle 415 on inquiry card

CONCRETE SLABS AS ELECTRICAL RACEWAYS / A variety of wiring methods through smooth, hollow cells in the manufacturer's precast concrete slab is discussed in a 16-page booklet. The use of concrete slabs with suitable electrical fittings is approved by the National Electrical Code. Wiring methods are illustrated. ■ The Flexicore Co., Inc., Dayton, Ohio.*

Circle 416 on inquiry card

ADHESIVES/COATINGS/SEALANTS / A complete line is identified in a 16-page selection guide. Product description, performance, properties and applications are included. ■ 3M Co., St. Paul, Minn.*

Circle 417 on inquiry card

* Additional product information in Sweet's Architectural File.

Rinkmaster®
is a
pipe dream...

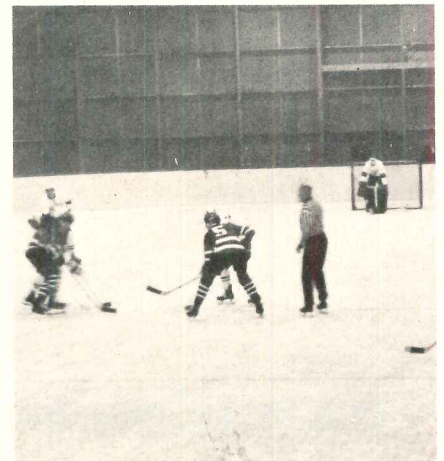

come true!

NEW, PATENTED REFRIGERATION SYSTEM COSTS LESS TO BUILD, OPERATE, MAINTAIN — MAKES BETTER ICE! Dozens of new "Rinkmaster" systems all over the U. S. are proving it. The cold, hard facts: unlike the traditional brine system, the Rinkmaster direct system sends the refrigerant, Freon or ammonia, straight to the floor. It circulates constantly and responds instantly to any change in surface temperature, guaranteeing a better sheet of ice always. Major savings: smaller pipe, less equipment, less horsepower (saving up to 30% in operating cost.)

Whatever size rink you plan to build — small studio, full-size, or multi-purpose arena — Holmsten has the know-how you need from planning through completion. May we help with your pipe dream?

WRITE FOR FREE BROCHURE

14 PAGES ON RINKS, TRENDS, COSTS & HINTS
(PLEASE PRINT)

NAME _____

TITLE _____

FIRM _____

ADDRESS _____

CITY _____

STATE _____ ZIP _____

TO: **HOLMSTEN
ICE RINKS**

Div. of Drake Construction Co.
Dept. B 6311 Wayzata Blvd.
Minneapolis, Minnesota 55416

For more data, circle 103 on inquiry card

To Building Product Manufacturers Who Are Looking for
A Maximum Return on Their Advertising Investment

far more architects and engineers in building shouldn't you do an optimum advertising job

The magazine is Architectural Record. Each month it delivers more than 42,000 paid architect and engineer subscribers. Almost 30 per cent more than the second magazine. Architects and engineers who are actively designing and specifying in architectural offices, consulting engineering firms, corporate and governmental building departments.

And significantly, these subscribers to the Record pay the highest subscription price in the field . . . by far. And they renew at the highest renewal rate . . . by far.

Architects and engineers pay more and renew more because they get more. More qualified editors turning out more editorial that is more useful. Every page accurately reflects the working interests of architects and engineers. Editorial content is continuously timed and balanced with the aid of Dodge Reports and Statistics to be of maximum value in terms of the work on their boards. Every issue caters to their constant need to learn about new design ideas, new technical devel-

opments, new techniques of practice, new materials, new products, new thinking. It's the reason, too, why over 95 per cent of Record subscribers save the magazine for future reference.

Architects and engineers demonstrate their strong preference for Architectural Record in yet another way. By voting the Record number one in 235 out of 254 studies sponsored by building product manufacturers and their agencies over three decades—in 26 out of 27 such studies in the last three years!

Building product manufacturers are moved by this preference. Year after year, they place more advertising pages in Architectural Record than in any other magazine—45 per cent more in 1971!

When one magazine is dominantly preferred by the readers you have to reach—and the advertisers you have to compete with—doesn't your primary advertising effort belong in *that one magazine?*

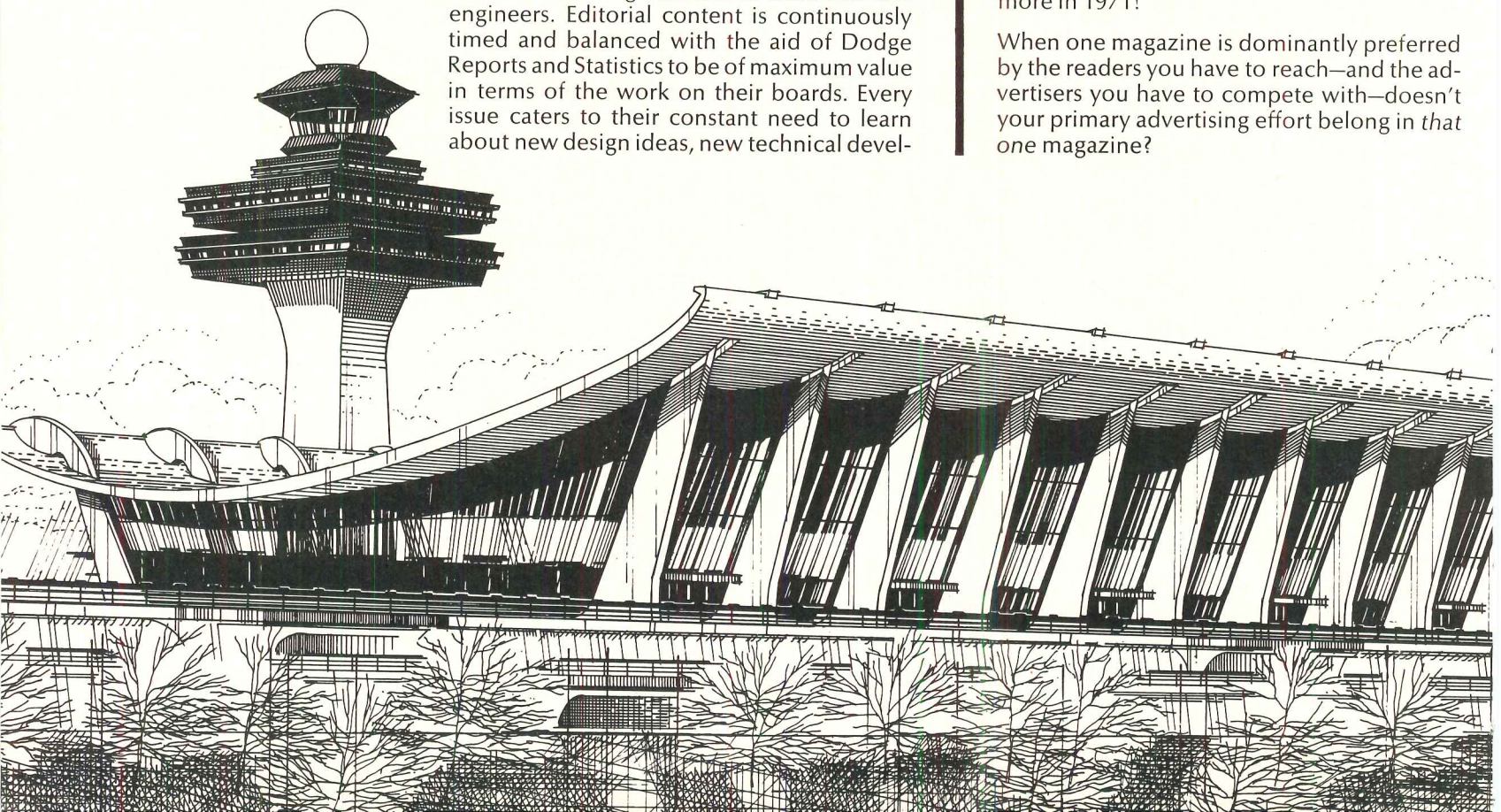

subscribe to ONE magazine than any other. in THAT ONE?

WHAT IS AN OPTIMUM ADVERTISING JOB IN THE LEADING MAGAZINE?

That depends.

On marketing objectives, the balanced use of marketing tools, competition, product, budget and a host of other considerations.

However, advertising professionals generally agree that four basic laws are operative.

1. Continuity increases impact.
2. Larger space tends to command greater attention.
3. Functional 4-color lends dominance and aids understanding.
4. Continuity, larger space size and functional color together help get attention, create interest, build reputation, impress the reader.

Architectural Record would welcome the opportunity to place its knowledge of the market and marketing at your disposal—to help you determine how you can get maximum value out of your advertising program.

What Advertisers Want in an Architectural Magazine (and find in Architectural Record).

- 1 Editorial superiority. Top quality editorial. More of it. 67 awards for editorial excellence. Largest, most professional editorial staff. Backed by McGraw-Hill Information Services—Dodge Reports, Dodge Statistics, Sweet's. Balanced coverage of all types of architect-engineer planned building—nonresidential and residential, large and small.
- 2 Outstanding reader preference. Year after year architects and engineers in building vote Architectural Record preferred in independently sponsored studies.
- 3 Circulation leadership. More architect and engineer subscribers. Highest subscription price. Highest renewal percentage.
- 4 Top market coverage. Over 90 per cent of the total dollar volume of all architect-engineer planned building is in the hands of Architectural Record's paid subscribers—a fact documented by Dodge Reports.
- 5 Advertising leadership. Most advertisers. Most advertising dollars. Most exclusive advertisers. Year after year for 25 years!

ARCHITECTURAL RECORD

330 WEST 42ND STREET
NEW YORK, N.Y. 10036

A MCGRAW-HILL MARKET-DIRECTED® PUBLICATION

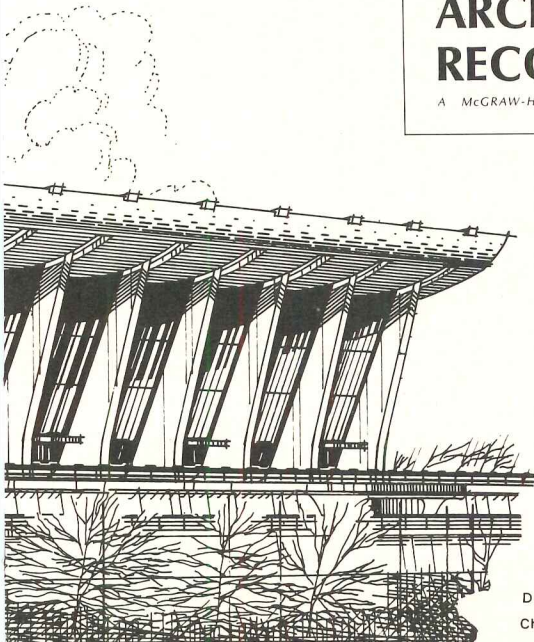

Dulles International Airport Terminal Building,
Chantilly, Va. Architects: Eero Saarinen & Associates

Promises to keep

**“But I have promises to keep,
And miles to go before I sleep.”—Robert Frost**

In 1976, a few short years from now, America will celebrate the 200th anniversary of a unique promise. The promise, and the enduring dream, of “Life, liberty and the pursuit of happiness.”

It is good to pause and look back. To reflect on and renew that historic promise.

But it is also necessary to look ahead.

Because America has new promises to keep. And a long, long way to go.

We have promised not merely to maintain, but to enhance the American way of life. To improve the standard of living *and* to improve the quality of life in tomorrow's America.

We have promised to produce the things—the goods and services—that make life possible and pleasant. And we have also promised to pay more heed to the intangibles that make life meaningful.

We have promised to conserve and protect our natural resources. To restore the vitality and preserve the beauty of our environment. To clean up our air and cleanse and refreshen our rivers, lakes and streams. To rebuild and reshape our cities, and to rationalize and reorder the chaos of a transportation system gone awry.

We have promised to care for the sick and safeguard the public health. To give new dignity and new hope to the poor, and to assist the disadvantaged. To do a better job of educating the young, and a much better job of cherishing and enriching the lives of the old.

All of these things, and more, we have promised to ourselves. And there is little argument about our promises. Most Americans agree that these are, and should be, our national goals.

But how do we deliver on our pledges? How do we match promise with per-



McGRAW-HILL MAGAZINES
Business/Professional/Technical

formance? How do we reach our goals? These are the hard, practical questions that perplex and divide us.

There are no simple answers to complex questions. But as we stand hesitant at a crossroads, debating which path to take, a few things do seem obvious. And perhaps it is time for a little plain talk.

Time to say flatly that there is no easy, primrose path that will take us where we want to go. The easy paths lead backward, or nowhere. The road that leads ahead is a hard road.

Because there is no way to produce less and have more.

No way to do less and accomplish more.

No way to give less and get more.

No way to sit on our aspirations and expect things to take care of themselves. Somebody, somehow, has got to *do* the conserving, protecting, restoring, preserving, cleaning, rebuilding, reshaping, rationalizing, reordering, caring for, safeguarding, helping, educating and cherishing.

And the only way to do a better job in all of these areas is to work at the job. Work harder or smarter, or both.

And, most importantly, work together. The job is too big for any of us working alone. And too big for all of us, working at cross purposes.

There is no easy way, and there is no one, patented, exclusive way.

No Liberal way and no Conservative way. No Democrat way and no Republican way. No business way and no labor way. No strictly government or wholly private way.

There is only a productive way or a nonproductive way.

And the productive way calls for all of us to join together. Not in perfect harmony. Not in ultimate brotherhood. And not in some high-flown crusade.

But in the simple recognition that we

all—business, labor, government and private citizens—have a job to do.

That we all have contributions to make.

And that each is vital, necessary, indispensable. Not to be done without.

The original promise of America was set forth in the Declaration of Independence.

The new promises of America call for a new Declaration of *Interdependence*.

For a new awareness and acknowledgment of our mutual dependence. Each upon each. All upon all.

This awareness, this new Spirit of '76, will not spring full-blown from this, or any other, proclamation. It cannot be legislated. It cannot be imposed. It cannot be synthetically drummed up.

It will begin, if at all, when the American people begin to tire of the politics, the policy, the endless futility of "confrontation." It will begin when they look at our goals on the one hand, and our petty squabbles on the other, and conclude quite simply, "You can't hardly get there from here." And that's a fact.

There are, at this crossroads in time, many paths to take. But there is only one useful way to go. Forward. Together.

It is time to face facts.

For we have promises to keep, and miles to go before we sleep.

We at McGraw-Hill believe in the interdependence of American society. We believe that, particularly among the major groups—business, labor and government—there is too little recognition of our mutual dependence, and of our respective contributions. And we believe that it is the responsibility of the media to improve this recognition.

This is the first of a series of editorial messages on a variety of significant subjects that we hope will contribute to a broader understanding.

Permission is freely granted to individuals and organizations to reprint or republish these messages.

John R. Emery
John R. Emery, President
McGraw-Hill Publications Co.

ADVERTISING INDEX

Pre-filed catalogs of the manufacturers listed below are available in the 1972 Sweet's Catalog File as follows.

- A Architectural File (green)
- I Industrial Construction File (blue)
- L Light Construction File (yellow)
- D Interior Design File (black)

A

- A Acme Highway Products Corp. ... 184
- Aerofin Corp. 51
- A Alcan Aluminum Corp. 72
- A-I Alliance Wall Corporation 182
- A-I-D Aluminum Co. of America 81
- Amarlite Products Div. 195
- American Air Filter Co. 63
- American Gas Association 8
- American Motors Corp.PB 5
- A-I-L American Plywood Association ... 143
- A-D American Seating Co.134-135
- A-L Anderson Corp.76-77
- Architectural Record198-199
- A-I-L-D Armstrong Cork Co.2nd Cover-1
- AVM Corporation Jamestown Products Division 160

B

- A Bally Case & Cooler, Inc. 79
- Belgium Standard Industries Ltd. ... 147
- Bendix Corp., The 182
- Bethlehem Steel Corp.11 to 14
- Boussois Souchon Neuvesel 188, IAS2-3
- A-I Bradley Washfountain Co. 187
- British Leyland Motors, Inc.PB 11
- Bruning Co., Charles148-149
- A-D Burke Rubber 32-3

C

- A-I Carey Company, Philip 133
- A-I-L Carrier Air Conditioning Co. ... 8, 40-41
- Carteret Air Conditioning Div. Singer Co. 176
- A-I Celotex Corp. 6-7
- Champion Spark Plug Co.PB 17
- A Clarin Mfg. Corp. 55
- A-I Clark Door Co., Inc. 80
- A Combustion Engineering—C-E Glass Division162-163, PB 9
- Commercial Carpet Corporation .. 85
- Concrete Reinforcing Steel Institute52-53
- Copperloy 84
- Corbin, P&F, Div. Emhart Corp. ...18-19
- A-I CPR Division The Upjohn Company 66
- D Cramer Industries, Inc.189, 191
- A-I Crawford Door Company 168

D

- Deering Milliken, Inc. 146
- A-I-L-D Delta Faucet Company 181
- A Dover Corp., Elevator Div. 2-3
- A-I Dow Corning Corp. 71
- Dupont De Nemours & Co., Inc. E.I.16-17

E

- A Easton Corp.—Lock and Hardware Div. 45
- Emhart Corp. 165

F

- Fife, Inc., Richard 74
- A Follansbee Steel Corp. 54
- Free-Tie Corp. 168

G

- A-I-L-D GAF Corp., Floor Products Division 75
- A-I-L-D General Electric Co. 70
- Georgia Dept. of Industry and TradePB 12
- A-I-L-D Georgia-Pacific Corporation 88
- Goodyear Tire & Rubber Co. ...48-49
- A Granco Steel Products Co. 166
- A-I Grefco, Inc., Building Products Div. 58

H

- Hager Hinge Company 61
- Harshaw Chemical Co., The 177
- A Haughton Elevator Company 157
- A-I-L-D Hercules Incorporated 160
- A-I Hillyard Chemical Co. 196
- Holmsten Ice Rinks Div. of Drake Construction 197
- Holophane Co., Inc. 50
- A Howmet Corporation, Southern Extrusions Div. 32-4

I

- A Inland-Ryerson Construction Products Co. 174

J

- Jamestown Products Division AVM Corporation 160
- Johns-Manville—Architectural Div. 20
- Jute Carpet Backing Council, Inc. . 195

K

- A-I-L-D Kaiser Aluminum & Chemical Corp. 161
- A Kalwall Corp. 197
- Kawneer Co.86-87
- A KDI Paragon 156
- A Keene Corp.137 to 142
- A-I Keene Corp., Sechrist-Lighting Div. 65
- A-I Kelley Co., Inc. 159
- A-I Kinnear Corp. 182
- Kold-Draft, Div. of Uniflow Mfg. Co. 186
- A-D Krueger Metals Products Co. 155

L

- A Larsen Products Corp. 177
- A LCN Closers, Inc. 193
- A-I-L Libbey-Owens-Ford Co.82-83

M

- A Macton Corp., The 192
- Magee Carpet22-23
- A McQuay Division—Perfex, Inc. ... 34
- Metal Lath Association 180
- Herman Miller Inc. 25
- A-I-D Monsanto Company, Textiles Div.151 to 154
- A-I-D Musson Rubber Co., R.C. 194

N

- New England Mutual Life Ins. Co.PB 3
- A Nor-Lake, Inc. 192
- L Norris Industries 32-1
- A Norton Door Closer Div.26, 84

O

- A Overly Mfg. 32
- A-I-D Owens-Corning Fiberglas Corp.173, 179
- Ozite CorporationPB 15

P

- A Parker Co., Charles 192
- Pella Rolscreen Co.171-172
- Pennsylvania Grade Crude Oil Assn.PB 18
- Pennwalt Chemicals Corp. 186
- A-I-D PPG Industries Inc.—Coatings & Resins 158
- A-I-D PPG Industries, Inc., Commercial Glass144-145
- A-I Proudfoot Co., Inc. 150

R

- Ralph Wilson Plastics68-69
- RCA Corp.—CES Div.PB 19
- A-I Red Cedar Shingle & Handsplit Shake Bureau 24
- Regal Tube Co. 164
- A-I Republic Steel Corp. 178
- A-I Reynolds Metals Co.28-29
- Rite Hite Corporation 195
- A-L Rohm and Haas Company 74
- Ruberoid—GAF Corp. 75
- Russwin, Div. Emhart Corp. 165

S

- St. Charles Mfg. Co.177, 183
- Scotsman—Queen Products Div. PB 16
- A Silbrico Corp. 177
- A-D Simmons Co.30-31
- Sloane Mfg. Div., R & G, The Susquehanna Corp. 167
- A-I Sloan Valve Company4th Cover
- A Smith & Co., Inc., Elwin G. 169
- Southern California Gas Co.32-3
- Spaulding, J. H. 15
- Square D Company 46
- A Standard Conveyor Co. 84
- State Mutual Life Assurance Co. of AmericaPB 7
- Steelcase, Inc. 67
- Steel Joist Institute 185
- Stem, Inc., Chester B. 74
- Superscope Inc.PB 13
- Sweet's Catalog Service 203
- A-I-L Symons Mfg. Co. 50

T

- A-I-D Taylor Co., The Halsey W. 175
- Teledyne PostPB 16
- A-I Thiokol Chemical Corp. 170
- Thonet American Chair Company3rd Cover
- A Trans-Vac Systems Div. 164
- A Tremco Mfg. Co.56-57
- Tron-Tech Inc.PB 14
- Trus Joist Corp. 33

U

- A Uniflow Mfg. Co. 186
- A-D United States Gypsum Co. ...27, 36-37
- A-L Universal-Rundle Corp. 177

V

- Viking Corporation 192
- Vollrath Co. 47

W

- Wang Laboratories Inc.PB 20
- A Wasco Products, Inc. 156
- W. A. Sheaffer Pen Co.PB-18
- A Welded Tube Company of America 21
- Westinghouse Electric Corp.—Outdoor Lighting Div. 73
- A-I-L Weyerhaeuser Company 190

Z

- A-L Zonolite Division 78

ARCHITECTURAL RECORD

McGraw-Hill, Inc., 330 West 42nd Street, New York, New York 10036
Advertising Sales Mgr.: Louis F. Kutscher (212) 971-2838
Eastern Sales Mgr.: Donald T. Lock (212) 971-3583
Central Sales Mgr.: Robert G. Kliesch (215) 568-6161
Advertising Services Mgr.: Joseph R. Wunk (212) 971-2793
Marketing Services Mgr.: Elizabeth Hayman (212) 971-2858
Research Mgr.: Camille Padula (212) 971-2814
Classified Advertising: (212) 971-2557

District Offices:

Atlanta 30309

Edward G. Graves, 100 Colony Square, 1175 Peachtree St., N.E.
(404) 892-2868

Boston 02116

607 Boylston St., (617) 262-1160

Chicago 60611

Robert T. Franden, Edward R. Novak, 645 N. Michigan Ave.
(312) 751-3764-5

Cleveland 44113

Willis W. Ingersoll, 55 Public Square, (216) 781-7000

Dallas 75201

Dick Grater, 1340 Republic National Bank Building
(214) 747-9721

Denver 80202

Harry B. Doyle, 1700 Broadway, (303) 266-3863

Detroit 48226

Richard D. Thielmann, 2600 Penobscot Bldg., (313) 962-1793

Los Angeles 90017

Richard R. Butera, 1125 W. Sixth St., (213) 482-5450

New York 10036

Donald T. Lock, Ted Rzempoluch, Michael M. Wood, 330 W. 42nd St.
(212) 971-3583

Philadelphia 19103

Robert G. Kliesch, George T. Broskey, 6 Penn Center Plaza
(215) 568-6161

Pittsburgh 15222

Edward C. Weil, 4 Gateway Center, (412) 391-1314

St. Louis 63011

Richard Grater, Manchester Rd., (314) 227-1600

San Francisco 94111

Richard R. Butera, 425 Battery Street (415) 362-4600

Overseas Offices:

Brussels

Galerie Porte de Namur, 22-26, Chaussee de Wavre
1050 Brussels, Belgium

Frankfurt/Main

Elsa-Brandstroen Str. 2, Frankfurt/Main, Germany

London

34 Dover Street, London W.1, England

Milan

Via Baracchini No. 1, Milan, Italy

Paris

17, rue Georges Bizet, 75 Paris 16°, France

Tokyo

2-5, 3-chome, Kasumigaseki, Chiyoda-ku, Tokyo, Japan

The Supermarket for plumbing fixtures and fittings¹

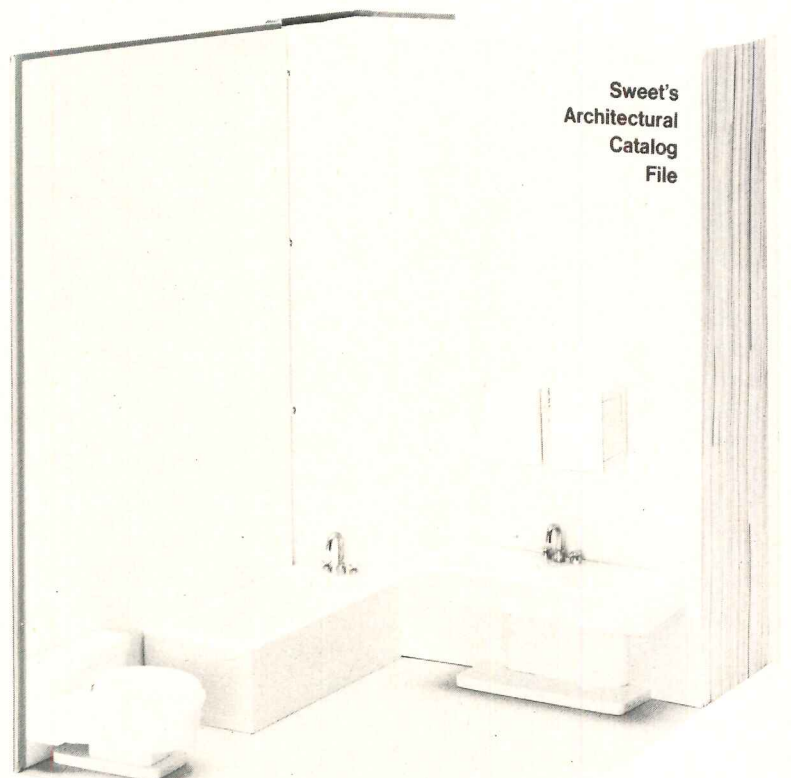

Sweet's Architectural Catalog File, The Supermarket of the General Building Market.

The outlet for leading manufacturers of plumbing fixtures and fittings which is shopped in 285,000 times a year² by architects looking for everything from seats to nuts.

Visit our expanded fixtures department—soon.

¹Volume 12,
Section 15:20
²1971 Audit

Sweet's Division,

McGraw-Hill Information Systems Company,
330 West 42nd Street, New York, N.Y. 10036



continued from page 60

implications of both the firm's operating profits and major decisions such as acquiring another firm, adding a partner, establishing a pension, buying out a principal, or incorporating.

A complete discussion of these matters is far beyond the scope of this article, and should be done with an experienced tax attorney or accountant. Tax law is so complicated that seemingly logical or innocent decisions can have severe tax consequences. Even the old rule of thumb that incorporation will save taxes is not necessarily true anymore because of recent changes in the laws. Expert counsel should be able to provide an ethical plan to guide this and all other actions with potential tax implications.

The basic elements of cash management

Ultimately, the goal of all of the planning, control, tax analyses and related effort is to end up with enough cash to operate the firm, pay good salaries, etc. To achieve the desired level of solvency requires still one more planning and control effort. The basic elements of this effort are the following:

1. *Cash flow projection*

AIA publications provide guidelines for this and the other controls noted below. This particular projection is most important when there is any question about the adequacy of the firm's cash resources over the next six- to twelve-month period. It also is a good basis for making application for a back-up line of credit, long-term loan, or a short-term investment plan for excess cash. This last point is important for many firms have short-term cash peaks, but do not realize that their banks can arrange for a no-risk thirty day investment so that the money does not sit idle in a checking account.

2. *Accounts receivable and accounts payable; aging schedules*

Each month the financial manager of the firm should have a list of accounts receivable and accounts payable spread by age to use as a basis for follow-up calls and short-term cash planning.

More important than any of the above mundane benefits of profitability, positive cash flow, tight control, etc. is that it is a great deal more fun to run a profitable firm. Morale is better, it is easier to concentrate on the important aspects of the firm's practice, the client's design problems, and everyone eats better. Profits have a very definite place in the practice of architecture today.

CLASSIFIED SECTION

PROFESSIONAL SERVICE

ALTMAN & WEIL, INC.
Management Consulting Services

For professional firms. Problems of organization, economics, personnel, profit distribution, mergers, office systems. We work Coast to Coast. Contact us without obligation. Altman & Weil, Inc., Box 472, Ardmore, Pa. 19003 - or J. P. Weil & Co., 111 Sutter St., San Francisco, Ca 94104.

POSITIONS VACANT

Architectural Designers: Permanent opportunity for talented graduate architects with strong ability and interest in design in major midwest architectural and engineering firm. Excellent growth potential for creative, responsible persons in a firm interested in new approaches to the planning and construction process. Excellent fringe benefits including 4-day work week. Send resume and salary requirements to: Mr. C. D. Patton, Louis C. Kingscott & Assoc., Inc., 511 Monroe St., P.O. Box 671, Kalamazoo, Mich. 49005. An Equal Opportunity Employer.

POSITION WANTED

Architect, NCARB certificate, seeks responsible design position with larger firm, would consider position that offered combined teaching opportunity. Portfolio reflecting 14 years of experience with established design firms. PW-7859, Architectural Record.

Professional Engineer, 38, proficient in heating, ventilating, air conditioning, plumbing and drainage systems. Will affiliate or represent contractor, engineer or architect. Geographical area no barrier. PW-5865, Architectural Record.

Architect: California registration, AIA. Age 38. Sixteen years experience. Exceptional record of achievement in planning and design of major, high quality projects. I am seeking discussions with principals of a progressive architectural firm, leading to the position of partner or associate in charge of design activities. Accustomed to taking the initiative and assuming maximum responsibility in managing and directing group effort. Experienced in effective promotional and design presentations to top echelon executives of national firms. Excellent personal design commendations. Extensive background in prestige, high rise office buildings. Commercial, educational, industrial, residential and recreational experience. Travel acceptable. PW-7753, Architectural Record.

SELLING OPPORTUNITY AVAILABLE

Sculptor seeks sales representation calling on architects, landscape architects, builders, owners of new office buildings and corporate headquarters to solicit sculptural commissions. I work in large geometric structured sculpture: Materials are primarily stainless, Corten, painted steel or fiberglass. Generous commission. Reply RW-7793, Architectural Record.

REPLYING TO BOX NUMBER ADS

ADDRESS BOX NO. REPLIES TO: Box No.
Classified Adv. Dept. of Architectural Record
NEW YORK, N.Y. 10036 P.O. Box 12

SELLING OPPORTUNITY AVAILABLE

Manufacturers Reps wanted by long established aluminum metal pan acoustical ceiling tile manufacturer with new and proven items to merchandise. Looking for agents who call on architects for our "Spec" items; and general contractors, acoustical contractors, lumber yards, building supply houses, etc., for our "Direct Sale Items". Many territories open. Commission basis. Flexible agency policy. No stock to carry. Write to Simplex Ceiling Corp., 663 Fifth Avenue, New York, N.Y. 10022.

Representatives wanted with high quality luxury experience to sell large and unique collection of scenic (mural) panels with broad acceptance by architects, specifiers, designers for government, hotels, banks, restorations, executive offices, restaurants and institutions. Liberal commission with protected exclusive territories: Baltimore, Boston, Buffalo, Cincinnati, Cleveland, Dallas, Detroit, Houston, Kansas City, Milwaukee, Minneapolis, Philadelphia, Pittsburgh, St. Louis, Washington, D.C. RW-7682, Architectural Record.

Sales Representatives: — Established manufacturer of library furniture looking for aggressive, knowledgeable sales representatives to handle several open territories throughout U.S. Must have experience in calling on architects, interior designers, librarians and school officials. Most territories have a volume or potential volume in excess of \$1 Million. In reply, please state background and experience in area in which you are interested. All replies treated confidentially. RW-7987, Architectural Record.

Classified Section
Non-Display Order Form

To place a non-display advertisement, fill out this form, including your name, street address, city & state with ZIP code, attach it to a separate sheet containing your advertising copy, and mail it to:

ARCHITECTURAL RECORD / P.O. BOX
12
NEW YORK, N.Y./10036

Rates: \$3.80 per line, minimum insertion ten lines, six words to a line, box number counts as one additional line. Display rates on request.

Payment Enclosed \$ Bill me

Use Name & Address Use Box No.

Advertisement to appear time(s)

.....
Signature

Pick up a few of our molded plywood arm chairs. They're convenient, colorful and most comfortable. Oak veneer backs and seats in six colorful translucent finishes or the upholstery of your choice. The Stack Pack, like all Thonet

furniture, built to endure. See it now at the Thonet Center of Design. New York. Chicago. Los Angeles. San Francisco. Dallas. Miami. Or write to Thonet Industries, Inc., One Park Avenue, New York, New York 10016. Phone (212) 725-1100.

THE STACK PACK



THONET 
CENTER OF DESIGN

For more data, circle 128 on inquiry card

The new beauty
of Sloan Flush Valves

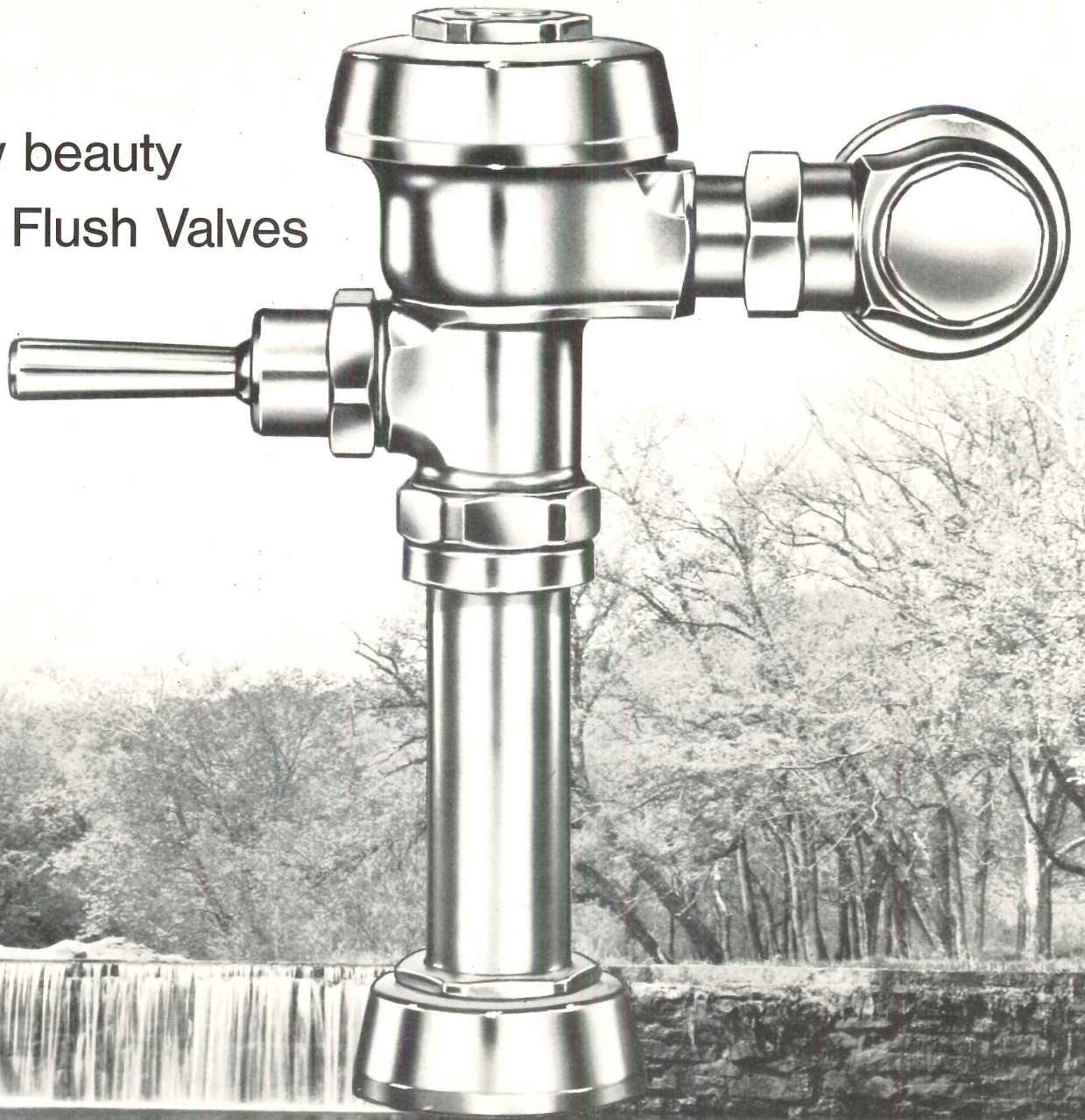

Sloan Flush Valves are now dramatically restyled. Totally new contours shape their beauty in the elegant simplicity of classic design.

And this new regal appearance complements the traditional quality that has sustained Sloan Flush Valve leadership for more than sixty years.

To make sure your new building has the best in quality with beauty unsurpassed, specify Sloan Flush Valves—as most people do.



SLOAN VALVE COMPANY
10500 Seymour Avenue,
Franklin Park, Illinois 60131

For more data, circle 129 on inquiry card