

ARCHITECTURAL RECORD

A photograph of a modern building's interior courtyard. The walls are made of light-colored brick. A large, vertical wooden door is on the left. To the right, there is an arched doorway leading to another room. A large, green palm plant is in the foreground on the right. The ceiling features a series of parallel metal beams. The floor is a light, neutral color.

NOVEMBER 1956

BUILDING TYPES STUDY

MENTAL
HOSPITALS

240

Lower photo shows 500-ton concrete roof for main auditorium (upper center) of Temple Isaiah, Los Angeles, Calif. Archt.—Kenneth N. Lind, A.I.A.; Struc. Engr.—Brandow & Johnston; Contr.—Zimmer Construction Co.; Sub. Contr.—Vagtborg Construction Co.; Pozzolith Ready-Mixed Concrete supplied by Consolidated Rock Products Co.—all of Los Angeles, Calif.

Lift-slab concrete improved with **POZZOLITH**

In a letter about this job—the first inverted beam lift-slab structure—the contractor said: "With Pozzolith in the concrete we were able to...pour both slab and beams together with 3½" slump, yet were able to maintain the necessary workability so necessary in this type of pour without excessive vibrating.

"Further, with the use of Pozzolith we obtained a seven-day test of 3,200 pounds and a twenty-eight day test of 4,600 pounds, allowing us to raise these slabs in seven days instead of the usual fourteen day delay."

These results were obtained with Pozzolith because it is key to (1) lowest possible unit water content for a given workability (2) control of entrained air and (3) control of rate of hardening.

Any one of our more than 85 skilled field men will be glad to demonstrate the full advantages of Pozzolith for your project.

THE MASTER BUILDERS CO.



CLEVELAND 3, OHIO • TORONTO, ONT.

Division of American-Marietta Company

Cable Address, Mastmethod, New York

November 1956 Vol. 120 No. 5

Copyright 1956 by F. W. Dodge Corporation, with all rights reserved. Copyright not claimed by F. W. Dodge Corporation on color illustration on front cover. ARCHITECTURAL RECORD (combined with AMERICAN ARCHITECT and ARCHITECTURE) is published monthly, except May 1956 when semimonthly, by F. W. Dodge Corporation, 10 Ferry Street, Concord, New Hampshire. Editorial and executive offices: 119 West 40th Street, New York 18, New York. Western editorial office, 2877 Shasta Road, Berkeley 8, California.

STAFF OF ARCHITECTURAL RECORD



H. Judd Payne, *Publishing Director*; **Robert F. Marshall**, *General Manager*; **John Knox Shear**, A.I.A., *Editor-in-Chief*; **Marshall T. Ginn**, *Circulation Manager*; **Emerson Goble**, *Managing Editor*; **Frank G. Lopez**, A.I.A., *Senior Editor*; **James S. Hornbeck**, A.I.A., *Senior Associate Editor*; **Elisabeth Kendall Thompson**, *Senior Associate Editor and Western Section Editor (Berkeley, California, Office)*; **Robert E. Fischer**, *Associate Editor (Engineering)*. **Florence A. van Wyck**, *Associate Editor*; **Jeanne M. Davern**, *Associate Editor (News)*; **Daniel M. Kelley**, *Associate Editor (Engineering Assistant)*; **Herbert L. Smith, Jr.**, A.I.A., *Associate Editor*; **Ernest Mickel**, **Dan Street** (*Washington*), **John Caulfield Smith**, M.R.A.I.C. (*Canada*), *Contributing Editors*; **Grace M. Anderson**, *Assistant Editor*; **Helen E. Cook**, *Editorial Assistant (Production)*; **Dianne Thomas**, *Editorial Assistant*; **Eugene H. Hawley**, *Design Director*; **Thomas L. McArthur**, **Mary Ann Godfrey**, *Design*; **Sigman-Ward**, *Drafting Consultant*; **Thomas S. Holden**, *Industry Relations Consultant*; **Clyde Shute**, *Statistical Consultant*; **George Cline Smith**, *Economics Consultant*; **Clifford Dannels, Jr.**, *Field Research Consultant*; **Daniel J. Howe, Jr.**, *Public Relations Consultant*.

TABLE OF CONTENTS

The Record Reports

Perspectives	9
Buildings in the News	10
Architect with Big Job, Small Staff, Relies on Modular Measure	16
Housing the Aged in Surrey: A British Competition	16B
Meetings and Miscellany	21
A Washington Special Report. FHA, Victim of Engineer Shortage, Sees its Studies Progress Slowly	32
News from Canada. <i>By John Caulfield Smith</i>	36
Washington Topics. <i>By Ernest Mickel</i>	48
Construction Cost Indexes	54
Required Reading	58
Calendar and Office Notes	354
Current Trends in Construction	394

Architectural Form for Houses

Five architects (or firms), all with earned reputations for ability to invent and refine architectural forms, show in these five houses a wide variety of architectural expressiveness. Introduction	161
House for Mr. and Mrs. S. Brooks Barron, Detroit, Mich.; Yamasaki, Leinweber & Assoc., Architects	162
House for Mr. and Mrs. Sterling W. Fisher, Irvington, N. Y.; Philip Johnson, Architect	167
Director's Cottage, Perkins School for Blind, Watertown, Mass.; Carl Koch & Assoc., Architects	172
House for Mr. and Mrs. Davidson, Bradenton, Fla.; Paul Rudolph, Architect	177
House for Mr. and Mrs. Herman Grossman, No. Muskegon, Ill.; George Fred Keck, William Keck, Architects	182

Scale in Church Design

Three Japanese churches by an architect who for long years has demonstrated a mastery of problems of scale. The three churches, with roughly the same program, are all of different sizes. The architect and his wife also show their ability to execute as well as design fabrics and sculptures.	
St. Anselm's Priory for the Benedictine Fathers, Tokyo, Japan	187, 192
St. Alban's Episcopal Church, Tokyo, Japan	188
St. Patrick's Church for the Colombian Fathers, Tokyo, Japan	190
Antonin Raymond & L. L. Rado, Architects	

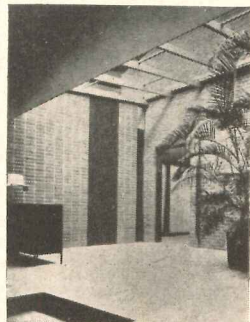

Cover: House for Mr. and Mrs. S. Brooks Barron, Detroit, Mich.: Yamasaki, Leinweber & Assoc., Architects Hedrich-Blessing photo

One Hundred Years of Significant Building

Number six in this series, Public Assembly, is an interesting comparison of two great structure-motivated buildings, both inventive in their own ways but leading in opposite directions.

6. Public Assembly	197
--------------------	-----

Building Types Study Number 240 — Mental Hospitals

Three articles dealing with new methods of psychiatric treatment as these translate into architectural programs. And seven building projects in the mental field showing at least in part the great range of buildings required.

Environment for Mental Therapy: An article by <i>John W. Cronin, M.D.</i> , and <i>Wilber R. Taylor, Architect</i>	201
New Horizons in Psychiatry: An article by <i>Lucy D. Ozarin, M.D.</i>	202
Psychiatric Facilities of the Future: An article by <i>Daniel Blain, M.D.</i>	205
Preliminary Scheme for Psychiatric Hospital, Ponce Medical Center, Ponce, Puerto Rico; <i>Alston G. Guttersen, Architect</i>	206
Lafayette Clinic, Detroit, Mich.; Wayne University College of Medicine; <i>Eberle M. Smith Associates, Inc., Architects and Engineers</i>	212
Camarillo State Hospital, Camarillo, Calif.; <i>Anson Boyd, State Architect</i> , <i>P. T. Poage, Asst. State Architect</i> ; <i>Arthur Dudman, Principal Architect</i>	216
Porterville State Hospital, Porterville, Calif.; <i>Anson Boyd, State Architect</i> ; <i>P. T. Poage, Asst. State Architect</i> ; <i>Arthur Dudman, Principal Architect</i>	220
Jacob L. Reiss Mental Health Pavilion, St. Vincent's Hospital, New York City; <i>Eggers and Higgins, Architects</i>	226
Receiving Building for Southeast Louisiana Hospital, Mandeville, La.; <i>Richard Koch, Architect</i>	228
Receiving Building, Rochester State Hospital, Rochester, Minn.; <i>Ellerbe and Company, Architects and Engineers</i>	230

Architectural Engineering

Daylight Research House for Robert A. Boyd; <i>Harris Armstrong, Architect</i>	233
Light as a Design Material	238
Technical Roundup	242
Product Reports	243
Literature	244
Time-Saver Standards: Useful Curves and Curved Surfaces, 13, 14, 15	247

Index to Advertising

396

OFFICERS OF THE F. W. DODGE CORPORATION

James McV. Breed, Chairman of the Board; *Paul Abbott and Thomas S. Holden, Vice Chairmen of the Board*; *Howard Barringer, President*; *Irving W. Hadsell, Chauncey L. Williams, Executive Vice Presidents*; *Howard M. Thompson, Vice President and Treasurer*; *Julius T. Little, Robert F. Marshall, T. Oliver Morgan, O. O. Paulsell, H. Judd Payne, George Cline Smith, Vice Presidents*; *Carl S. Bennett, Clinton C. Bennett, Ralph M. Hairston, Roy J. Hard, Richard H. Ray, John M. Williams, Regional Vice Presidents*; *Edw. H. Freed, Assistant Vice President and Comptroller*; *Walter F. DeSaix, Clifford G. Dunnells, Jr., Clyde Shute, Marc Wayne, Assistant Vice Presidents*; *Sanford D. Stockton, Jr., Secretary*; *William C. Breed, Jr., George W. Morgan, Jr., Assistant Secretaries*; *Irving B. Satin, Assistant Treasurer.*

OTHER F. W. DODGE SERVICES

Dodge Reports — Dodge Statistical Research Services — Sweet's Catalog Services — Dodge Books — Dodge Mailing Service — Chicago Construction News — Daily Pacific Builder — Denver Daily Journal — Real Estate Record & Builders Guide.

Members of Audit Bureau of Circulations and Associated Business Publications. ARCHITECTURAL RECORD is indexed in Art Index, Industrial Arts Index and Engineering Index.

Every effort will be made to return material submitted for possible publication (if accompanied by stamped, addressed envelope), but the editors and the corporation will not be responsible for loss or damage.

Subscription prices: Published monthly except May 1956 when semi-monthly. U. S., U. S. Possessions and Canada: \$5.50 per year; other Western Hemisphere countries, Philippines and Spain, to those who by title are architects and engineers, \$9.00 per year. Single copy price except Mid-May 1956 issue \$2.00; Mid-May 1956 issue \$2.95. Beyond Western Hemisphere, excluding Philippines and Spain, to those who by title are architects and engineers, \$9.00 per year for 12 monthly issues not including Mid-May 1956 issue. Subscriptions from all others outside U. S., U. S. Possessions and Canada for 12 monthly issues, not including Mid-May issue, \$24.00 per year. Changes of address: subscribers are requested to furnish both old and new addresses, sending if possible stencil impression from magazine wrapper; allow four weeks for change.



THE RECORD REPORTS

P E R S P E C T I V E S

MILESTONE: the Atomic Age begins to show proof of its promise — the nuclear reactor has made its first public appearance. On October 17, Queen Elizabeth II threw a switch at Calder Hall in Cumberland and released atomic-generated electricity into Britain's national power system. Calder Hall is not only the first large-scale nuclear power plant to be put in operation; it must very likely be one of the first power plants, either conventional or unconventional, to be "attractively designed," in the words of the *New York Times* correspondent, "so that it would not become an eyesore in this lovely countryside. . . ." It was not, sadly, reported who were the architects, if any, to get nuclear design off to such a felicitous start.

ONE EFFECT of the now maturing Atomic Age, hopes "M.S.W." in *Urban Land*, may be a step backward — to the "self-contained house." Time was, he recollects, when the householder's sources of light, heat and water were all on the premises. Now a man's home is his castle only as long as his pipes and cables hold out. But there is talk of our having, sometime in the future, an atomic unit "about the size of a breadbox" which could provide heat and air conditioning for a single home at a cost of something under \$100 a year; from there the step to individual atomic generators for home power seems small, though large enough to bring us back to self-sufficiency. So optimistic is the Urban Land Institute that it has alerted planners to watch developments and to ponder their possible effects on land usage. As for digging up those pipes and cables — well, the time is not yet.

MEN AND MACHINES: that our technology can be tyrannical as well as beneficent was a point sharply made, not for the first time, by Lewis Mumford, speaking at a recent three-day convocation sponsored by the Cooper Union to explore our resources for

"engineers and leaders." Mr. Mumford drew a picture of the machine — and, *ipso facto*, man — run wild. "Consider," he suggested, "the bright idea engineers are seriously playing with: the notion of taking the control of the private motor car out of the hands of the driver, so that he will become a mere passenger in a remote-controlled vehicle. If you take technical process as an end in itself, and believe that 'going is the goal,' this seems a natural, and indeed inevitable next step in automation. But look at the human consequences. The driving of a car has been one of the last refuges of personal responsibility, of the do-it-yourself principle, in our machine-oriented economy. At the wheel of his car the most downtrodden conformist has a sense of release: he may capriciously choose his destination, alter his speed, explore a side road, or loiter in a woody glen for a picnic lunch. One by one, in the interest of safety or speed, these freedoms are being taken away." All may not be lost however. If, as Mr. Mumford says, the machine has transformed man into a conformist and only partly human being, the next transformation will free him. "As with every previous transformation of man the next one will widen the field of human intercourse and association, encourage new areas of creativity, utilize functions and aptitudes that earlier stages had disregarded; and above all, it will overcome the enclosures and frustrations experienced by our machine-conditioned culture and our machine-conditioned selves."

THE MAN NEEDED to lead us into this transformation might be the engineer who has brought us into this one, if, says John Ely Burchard, we can decide what it is we want from him. Speaking at the Cooper convocation, Mr. Burchard queried, "Do you want [our engineers] to have a consciousness of the consequences of

their acts? Shall they prevent the building of economic dams which destroy the natural beauties of a Snake Canyon; shall they decline to provide super highways which lead from chaos to chaos; shall they be among those who rebel against the ugliness of the city they have made possible and join the forces of those who know that beauty is one of the things that are essential for the good life; shall they attempt not only to make fine television tubes but have more to say about the quality of what the tube presents; in other words, shall they have a full-fledged conscience?"

ZECKENDORFITIS: many ailments have been named for doctors, but none, as far as we know, for realtors. None, that is, until George Alpert, president of the New York, New Haven and Hartford Railroad, thought he detected symptoms of "Zeckendorfitis" in Alfred E. Perlman, president of the New York Central. Exactly what the symptoms are Mr. Alpert did not say, but as the diagnosis was made in the heat of battle — over some Park Avenue buildings which do or do not belong jointly to the railroads — it can be presumed he thought the complaint a serious one. Mr. Zeckendorf, of course, may know the cure. He might even, if he were asked, assure us that the affliction is benign.

ANTARCTIC INTELLIGENCE: the *Operation Deepfreeze Newsletter*, one of the most unaffectedly thrilling periodicals ever to brighten the life of an asphalt-bound adventurer, reports that the U. S. Navy will shortly begin work on the construction of the first base in history to be built at the South Pole. One feels sure that our polar forces will approach this venture as they have approached their entire assignment, with a slight awe that anyone can be building anything at the South Pole, and a simple confidence that the Navy can accomplish what must be accomplished.

THE RECORD REPORTS
BUILDINGS IN THE NEWS

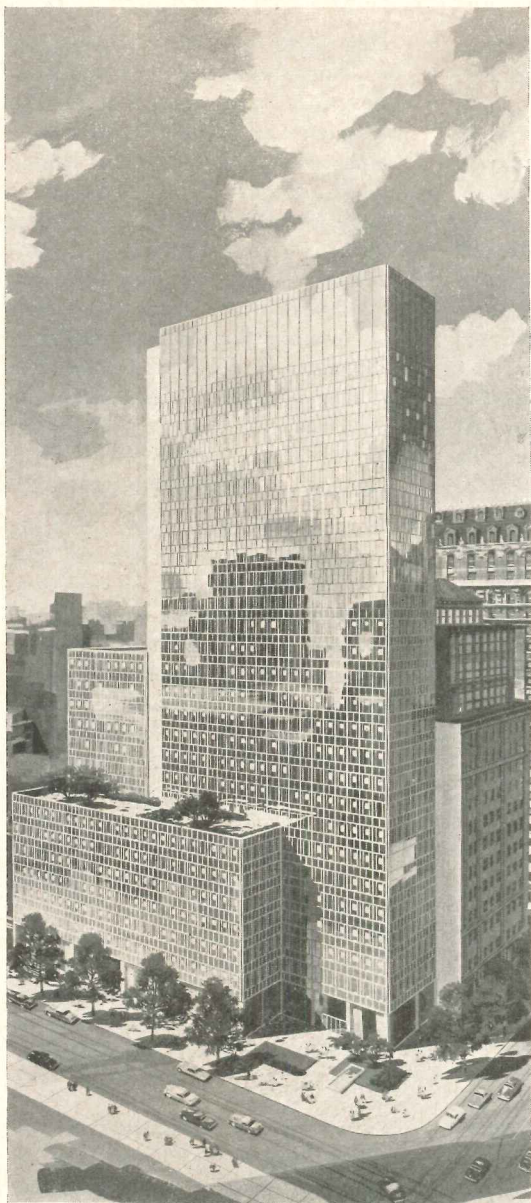

1.

OFFICE BUILDINGS HERE AND THERE: 1. At 718 Fifth Avenue, New York, Corning Glass Works plan a 28-story building with, of course, glass curtain-walls. It will be the first project, outside of Rockefeller Center, to have its own landscaped plaza on the avenue. The architects are Harrison & Abramovitz; builders, the George Fuller Company.

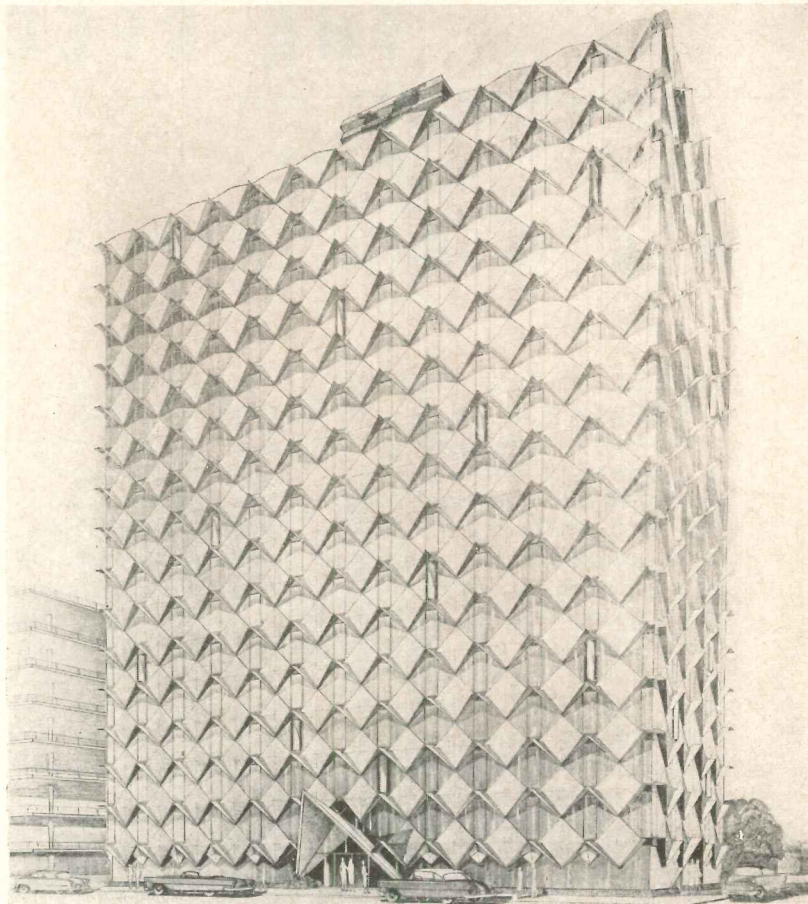

2.

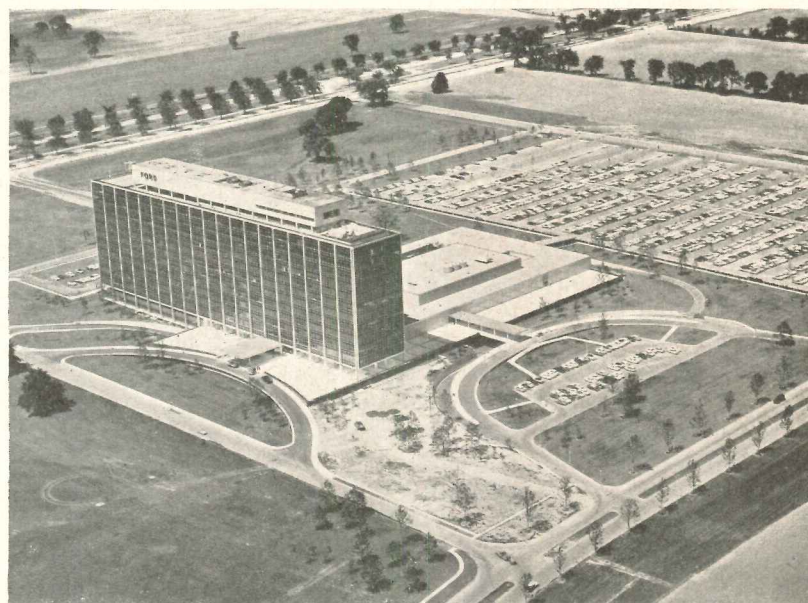

3.

2. Now under construction in Odessa, Texas, is this aluminum and glass office building. The triangular sun shields and the shallow (four in. at deepest point) pyramids will be stamped aluminum, and were deliberately laid out on the diagonal, say architects Darrow, Hodgens and Harp, for "relief from the horizontal and vertical feeling" of multi-story buildings. The glass spandrels under the sunshades will have pivoted windows. Pyramids will be

fastened to reinforced concrete cantilevered flat slabs. 3. Now completed on a 90-acre site at Dearborn, Mich., Ford Motor Company's central offices are housed in a 12-story glass and porcelain enamel building. The three-story employe service annex contains a garage, cafeteria, and kitchen, auditorium, lounge, sandwich shop, barber shop, photography studios and "housekeeping" facilities. The archi-



4.

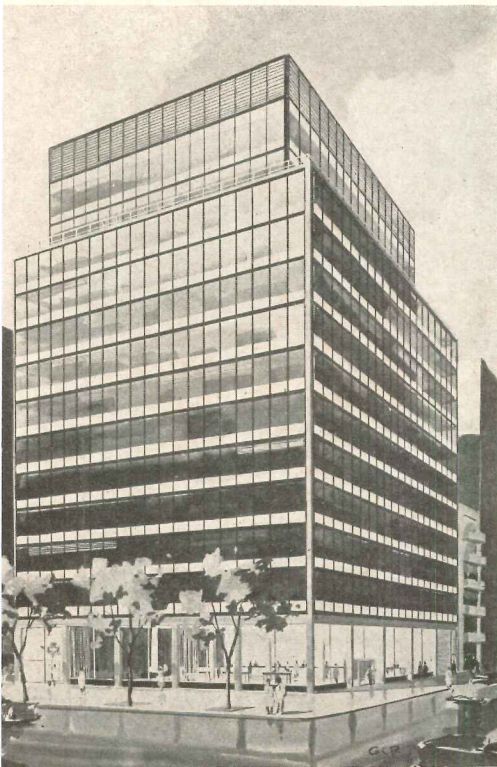

5.

itects were Skidmore, Owings & Merrill. 4. The Veterans of Foreign Wars will build their National Memorial Building in Washington, D. C. Holabird & Root & Burgee are the architects. 5. In New York, the Girl Scouts of the United States of America plan an 11-story headquarters. The walls of the building, which is now under construction, will be Girl Scout-green glass. Architect, William T. Meyer; Skidmore, Owings & Merrill, consultants

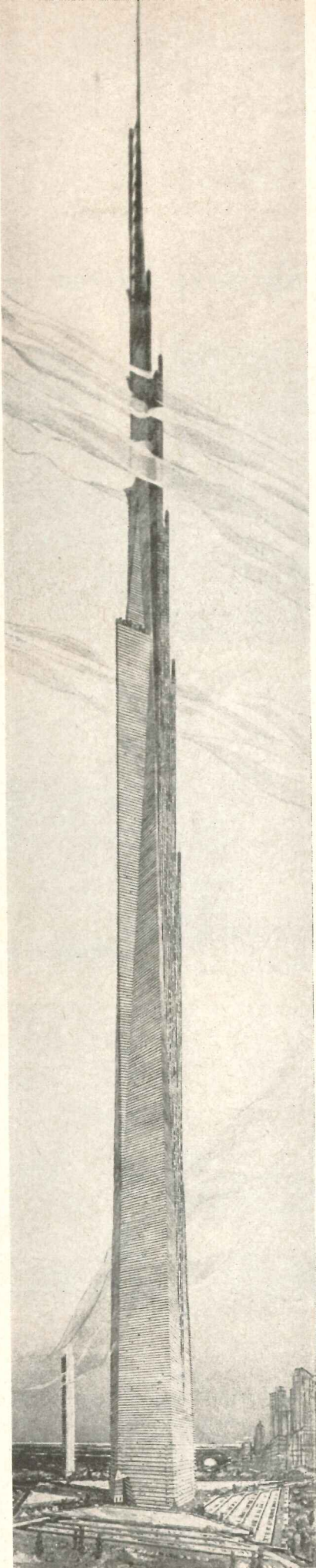

THE ILLINOIS: Frank Lloyd Wright's promise of a skyscraper (the word seems inadequate — Mr. Wright himself prefers "sky-city") for Chicago to be one-mile high was kept when the design was unveiled in that city last month. Planned as a tripod structure, the construction of the building would be similar to that already used by Mr. Wright in the Johnson Heliolaboratory and in the Price Tower — a "lap-roof" foundation, with the main core of the building extending down to bedrock. The concrete floors would be cantilevered from the steel central core, and would be hollow to accommodate air conditioning and lighting systems. The structural members, says Mr. Wright, would be in such balance as to eliminate entirely any sway at the peak of the building. For the exterior, Mr. Wright would use gold-colored metal, recessing the windows to avoid glare, to emphasize the building's metallic appearance, and "to afford a sense of human protection" at that height. To transport the 130,000 occupants which the 528-story building could hold, moving stairways would be provided for the first five floors, and elevators, 56 of them, from the fifth floor up. The elevators, traveling at "say, a mile per minute," would rise straight out of the tripod form to appear as sort of secondary spires. Sidelight: the elevators would, ideally, be operated with atomic power. Also included on the site would be covered parking space for 15,000 automobiles, and two heliports, each capable of handling 50 helicopters. Four-lane drives would approach the Illinois at each of its four corners. "All this well done, the building will be centuries more permanent than the Pyramids." As yet, no investor has displayed the same daring that Mr. Wright has. The scheme was revealed in connection with "Frank Lloyd Wright Day in Chicago," celebrated on October 17 by proclamation of Mayor Richard J. Daley. The festivities included a dinner to kick off the \$4 million fund drive for the endowment of Taliesin in Wisconsin

(Continued on page 12)

THE RECORD REPORTS

BUILDINGS IN THE NEWS

(Continued from page 11)

LEASE-PURCHASE PROGRAM SPURS POST OFFICE AND COURT HOUSE DESIGN ACROSS THE COUNTRY



1.

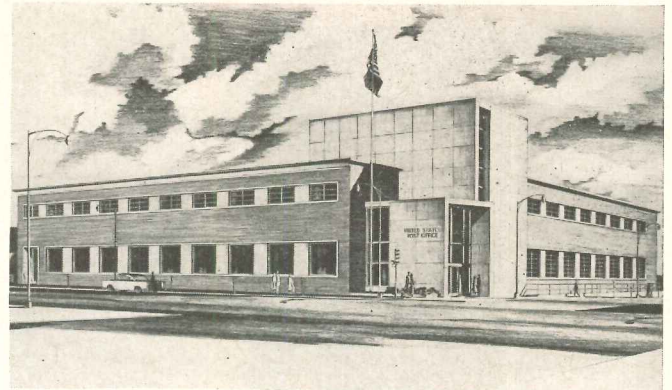

2.



3.

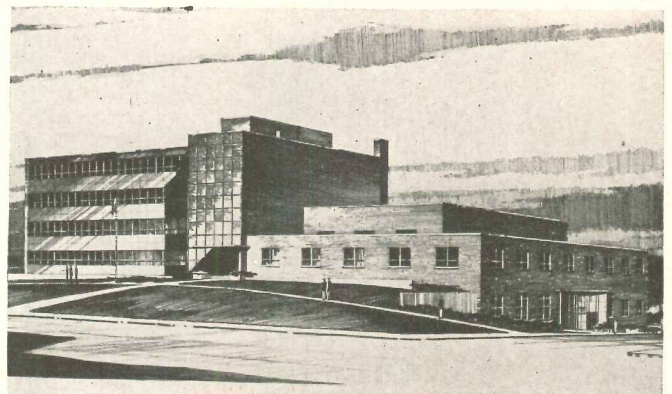

4.

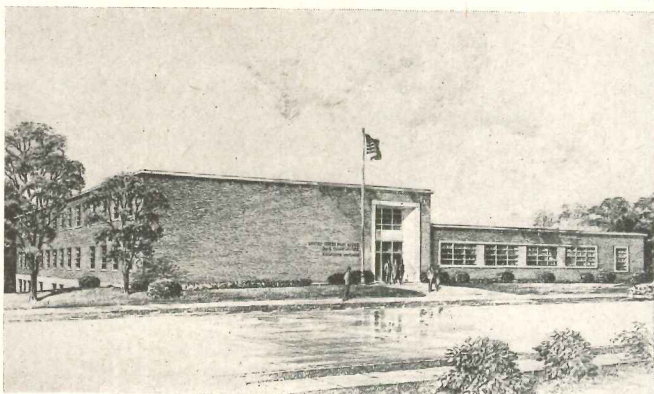

5.

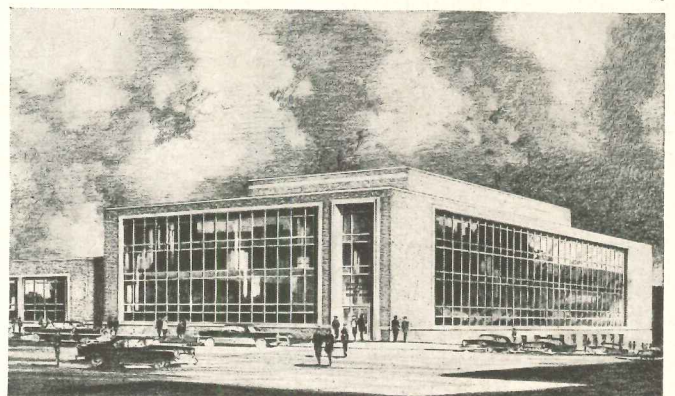

6.

Recent projects designed to be built under the government's so-called lease-purchase program, under which the buildings are constructed with private funds, leased and eventually bought by the government, include: 1. Post Office and Court House building, Omaha, Neb.; architects Steele, Sandham & Steele, with Henningson, Durham and Richardson and Kirkham,

Michael and Associates. Cost: \$9,579, 823. 2. Post Office building, Burlington, Iowa; Dane D. Morgan and Associates, architects. Cost: \$1,328,000. 3. Federal Office Building, Albuquerque, N. Mex.; Ferguson, Stevens and Associates and Flatow and Moore, architects. Cost: \$6,227,000. 4. Post Office and Court House Building, Kansas City, Kan.; Joseph W. Radotin-

sky, architect. Cost: \$2,400,000. 5. Post Office and Court House building, Abingdon, Va.; Eubank & Caldwell, Inc., architects. Cost: \$550,000. 6. Post Office and Court House building, Jamestown, N. Y.; Beck & Tinkham and Duane Lyman & Asso., architects. Cost: \$1,840,000. The program is administered by the Public Building Service, General Services Administration.



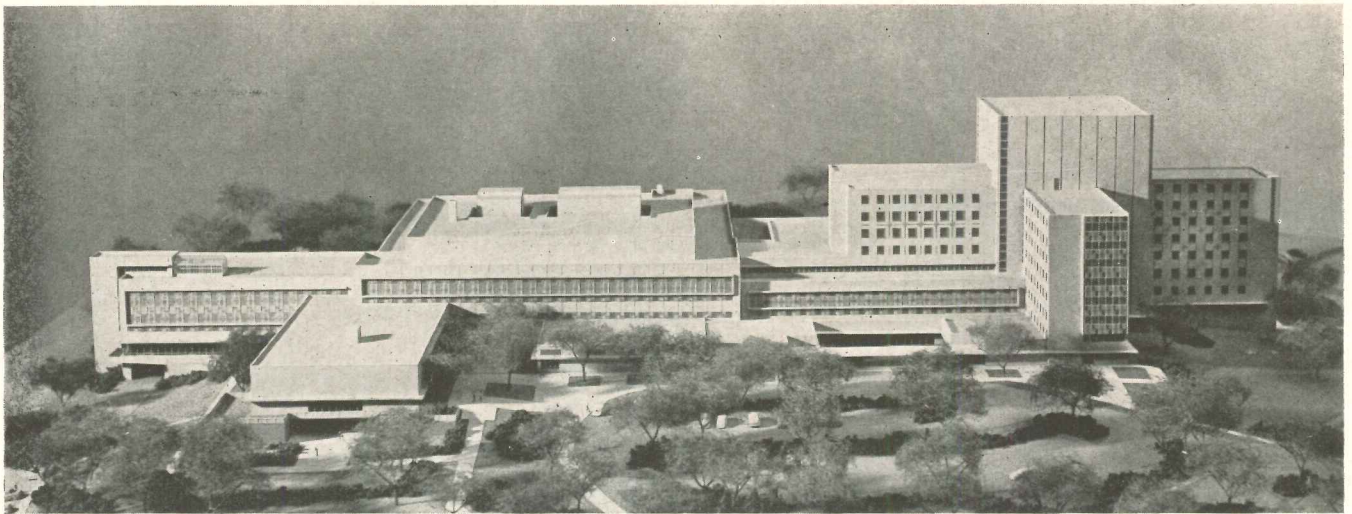

ARCHITECT WITH BIG JOB, SMALL STAFF, RELIES ON MODULAR MEASURE

Working drawings for the \$15 million hospital at West Virginia University's Medical Center were developed, says architect C. E. Silling, on three active drawing boards, a feat which he attributes to the firm's use of the modular method. Besides the hospital, the medical center will include a basic sciences building, now nearing completion, which was also designed with the modular measure.

In plan, the center will be composed of three parts, all in one building to facilitate the interaction of academic and practical operations. The basic sciences building (at left in the model above) will house 1100 students of medicine, dentistry, pharmacy, nursing, X-ray, occupational and physical therapy, medical social service and dietetics. The central core will comprise the lecture halls and large laboratories; its plan, says the architect, was tested against the school's class schedules for its efficiency of circulation. The five wings will provide daylight for offices and research and service rooms.

The cruciform hospital, soon to be ready for bids, will also be built around a central core (at right in model). The beds will be placed in each of the four wings, while the 14-story square will contain service and control facilities on 11 floors, mechanical equipment on the top three. Altogether the hospital will provide 520 beds — 328 for acute cases, 143 for chronic cases, 49 for rehabilitation cases.

Still a third "core" will be the outpatients' clinics, situated between the hospital and the sciences buildings. It is

expected that 450,000 patients will be treated annually in the clinics.

The architect credits the core-system with its consequent short perimeter walls, with saving enough on construction cost to pay for the air cooling equipment.

The exterior of the building, which will be West Virginia's largest public building when it is completed, will be gray brick and stone. Parts of the building will be faced with gray and blue wired glass, to have a "matte finish of limpid quality" lending depth to the color. The glass will be mounted in aluminum frames.

The interior finishes will be strictly utilitarian — glazed and unglazed tile

walls, plastic and asphalt floors — except in the auditorium, library, clinics and hospital lobbies, chapel and cafeteria, which will get special treatment.

The medical center is being financed by proceeds from West Virginia's penny "pop tax," a one-cent tax on each bottle of soft drinks levied solely for the construction and operation of the medical school. Total cost will be \$30 million, with something better than \$25 million going into the construction of the hospital and the science building, the remainder to buy equipment.

The architects of the Center are C. E. Silling and Associates of Charleston, with Schmidt, Garden & Erikson of Chicago as associate architects.



(More news on page 16B)

PORCELAIN ENAMEL

helps create a new era in architectural design

Making full use of the color, durability and economy of porcelain enamel on Armco Enameling Iron, architects are creating distinctive new designs in functional curtain wall buildings.

RIGHT:
Michigan State University
Library, Lansing
Architect: Ralph R. Calder
Porcelain Enamel: Wolverine
Porcelain Enameling Co., Detroit
Base Metal: Armco Enameling Iron



These colorful structures illustrate the "new look" being created by ingenious architectural design with porcelain enamel curtain walls. In addition to providing color and form, porcelain enamel on Armco Enameling Iron helps architects design lifetime economy into their buildings.

Durable and strong

Known for its durability and strength, Armco Enameling Iron has been proved by more than a quarter-century of use in architecture. Porcelain enamel fused to this special metal combines lasting resistance to corrosion with high strength.

Design flexibility

Armco Enameling Iron enables you to use all the advantages of lightweight

curtain walls and gives you added design freedom. Because it is so easy to fabricate, you can specify adaptations of standard panels or custom-designed fluted, ribbed or texture-patterned panels. With porcelain enamel on Armco Enameling Iron, form and texture as well as color become variable design elements.

Variety of colors

There is no limit to color in porcelain enamel. You can select brilliant hues for striking contrasts, or soft tones for harmonious blending. And each color

is permanent, unaffected by the weather. Additional color variation is made possible by the different finishes you can specify for porcelain enamel. They range from full gloss to non-reflective matte.

When you design large or small buildings, give them a permanent new look and insure maximum durability and economy for your clients by specifying curtain walls of porcelain enamel on Armco Enameling Iron. For more information on colorful porcelain enamel in curtain wall construction, write us at the address below.

Armco Steel Corporation

2416 Curtis Street, Middletown, Ohio

SHEFFIELD STEEL DIVISION • ARMCO DRAINAGE & METAL PRODUCTS, INC. • THE ARMCO INTERNATIONAL CORPORATION



PRINTED
IN
U.S.A.

INTERNATIONAL COMPETITION OKAYED FOR HALL DESIGN

Toronto city council has approved the holding of an international competition for the design of a new city hall and civic square.

Conditions of the competition, which will be developed with the help of the Royal Architectural Institute of Canada, are expected to be ready by the end of 1956. A six month period will be allowed for the preparation and submission of designs. First prize in the competition is expected to be around \$25,000. Jury is not yet named.

NO CUT SEEN IN DEFENSE SPENDING FOR 1957-1958

No cut in spending on Canadian defense construction is expected within the next two years, according to statistics released by *The Financial Post*.

Spending in 1957 will total about \$130 million — the recent average — according to *Post* calculations. The total is less than during the post-Korean war period when concentration on air power shot

spending up to about \$250 million for the 1952-53 fiscal year.

The prediction is based largely on present commitments rather than plans for the future.

Forecast for 1958 spending is much the same as that for 1957, again based on commitments. The present backlog is about \$254 million, most of it to be spent in projects taking two years (large buildings, runways, etc.)

By services it breaks down this way: **Navy.** This is the most inexpensive service, construction-wise. It has plans to spend \$4 million, with a carryover of \$22 million. The carryover will be divided with about \$10 million in 1957 and \$12 million in 1958. Expenditure in 1959 should be down to perhaps \$7 million. **Army.** Target for expenditure is \$25 million, with a \$152 million backlog of commitments. About \$75 million will be spent in each of 1957 and 1958. The other \$27 million will be spent in 1959. Spending in 1959 will probably taper off to about \$50 million.

Air Force. Plans call for \$25 million in new spending, and there is an \$80 million

backlog which will also be spent over the next two years.

The Air Force is the service that could upset the expected tapering-off of construction spending in 1959. Already Defense Minister Ralph Campney has spoken of building three more airfields — each to cost about \$8 million.

WINTERTIME CONSTRUCTION IS FEASIBLE, SAYS R.A.I.C.

Wintertime construction in Canada is feasible provided proper precautions are taken, according to the standing committee on building research of the Royal Architectural Institute of Canada.

This advice was part of several recommendations offered by the R.A.I.C. to Canada's Joint Committee on Wintertime Construction.

"It is recommended that before any decisions are made the proposals should be discussed with the architects of the buildings in the light of all circumstances such as climate, type of construction, site conditions, materials, costs, etc.," said the R.A.I.C.

(Continued on page 40)

MODERN WORKMAN'S REHABILITATION CENTER UNDER CONSTRUCTION IN ONTARIO

A modern 500-bed rehabilitation center for treating injured workmen is under construction near Toronto.

The 14-building center, designed by associated architects Page & Steele and Thomas R. Wiley, is being built at a cost of some \$5,530,000 on a 65-acre site on highway 400 in north metropolitan Toronto. Contractors are Anglin-Norcross, Ontario.

Completion of the center is expected by fall of 1957, according to E. E. Sparrow, chairman of the Ontario Workmen's Compensation Board.

The buildings will accommodate 500 patients, in clinic dormitories of 325 beds and a hospital section of 175 beds. Over-all floor space will be 318,000 sq ft and will cover 15 acres, including roads and parking lots. Dining rooms, kitchens, nurses' residence, garages, and maintenance shops will be provided. All patients will live in at the center, which will be a self-contained unit including an auditorium, library and recreation rooms.

"Our aim in this new center," said Mr. Sparrow, "will be to return On-

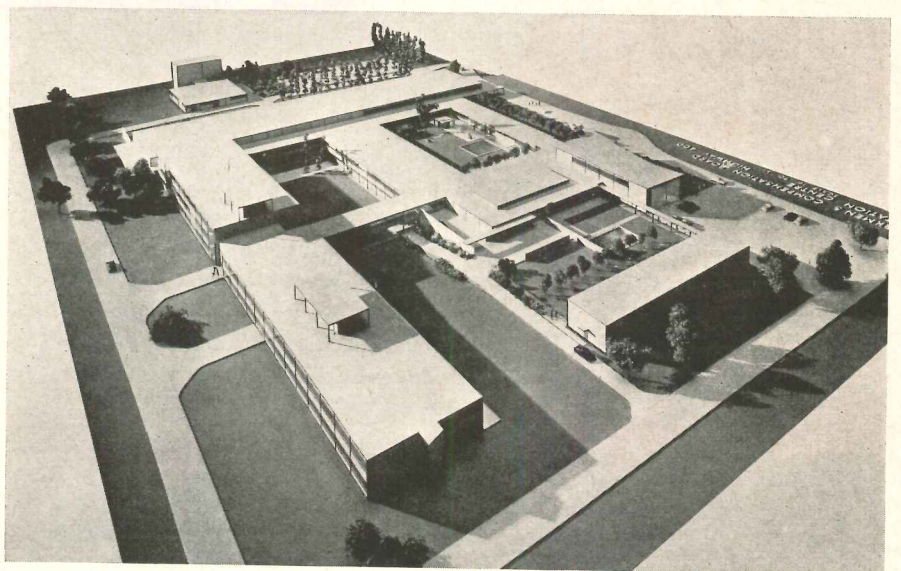

tario's more seriously-injured workmen to gainful employment at the lowest cost.

"This combined hospital-rehabilitation center will increase our efficiency in reducing permanent disabilities."

The new structure replaces the Compensation Board's rehabilitation center

which is located in temporary wartime buildings at Malton, near Toronto. In 1955, over 3400 injured workers were treated there. The Toronto center will have facilities for carrying out the latest physical medicine treatment and rehabilitation techniques evolved by the doctors and staff at Malton.

SAVING

electrical conductors!

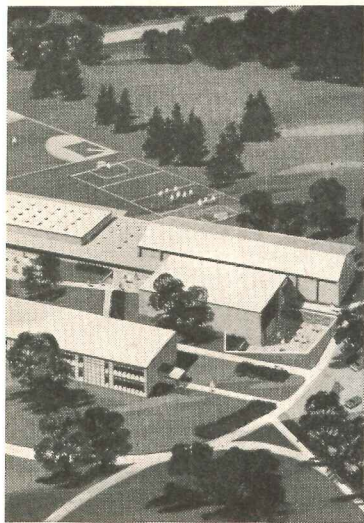

Here is a comparison taken from the cost studies for the two new high schools now nearing completion in Cedar Rapids, Iowa:

COMPARATIVE COST STUDY:

Copper Conductor	\$70,000.00
Aluminum Conductor	45,000.00
Gross Savings Using Aluminum	\$25,000.00
Less additional costs incurred in using aluminum:		
Conduit	\$ 6,500.00
Connectors	850.00
*Tools	1,500.00
*Training	1,000.00
Switchboard equipment modification	2,000.00
Reserve for contingencies	2,950.00
Total additional costs	\$14,800.00
NET SAVINGS	\$10,200

*First job costs only.

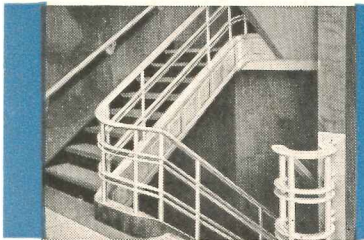
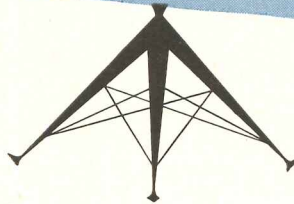

Railings made of aluminum stand up under the hardest kind of treatment.

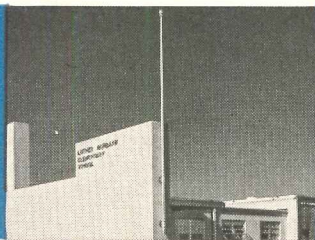

Flagpoles made of aluminum stay bright and will never need painting.

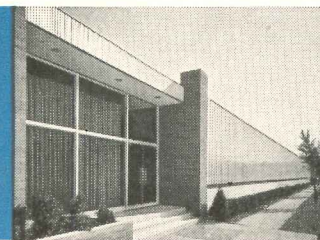

Curtain walls made of aluminum eliminate maintenance costs due to constant exposure.

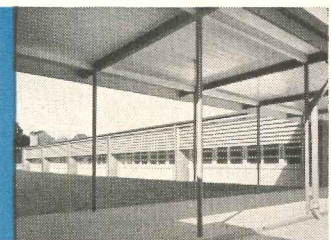

Sun Shades made of aluminum add exterior beauty, assure interior comfort.

For example, the six items shown above—manufactured of Kaiser Aluminum—are recommended for school construction.

Kaiser Aluminum architectural representatives are ready to give you counsel and assistance on the proper applications of aluminum.

Contact the Kaiser Aluminum sales office listed in your telephone directory, or write Kaiser Aluminum & Chemical Sales, Inc., *General Sales Office*, Palmolive Bldg., Chicago 11, Illinois; *Executive Office*, Kaiser Bldg., Oakland 12, California.

See "THE KAISER ALUMINUM HOUR." Alternate Tuesdays, NBC Network. Consult your local TV listing.

Kaiser Aluminum

Please have your Architectural Representative call.

Please send me more information about building applications of Kaiser Aluminum electrical conductor.

KAISER ALUMINUM ARCHITECTS' SERVICE
919 N. Michigan Avenue
Chicago, Illinois

NAME _____

ORGANIZATION _____

ADDRESS _____

CITY & STATE _____

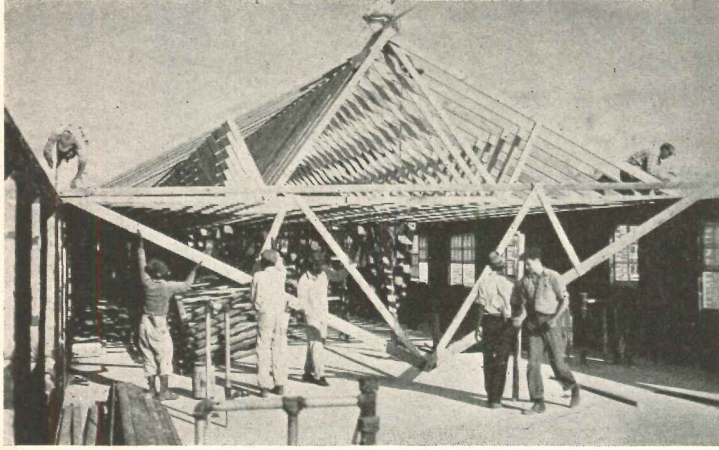

"Timber Design and Construction Handbook" illustrates (above) design procedures and details of timber assemblies and structures based on experience

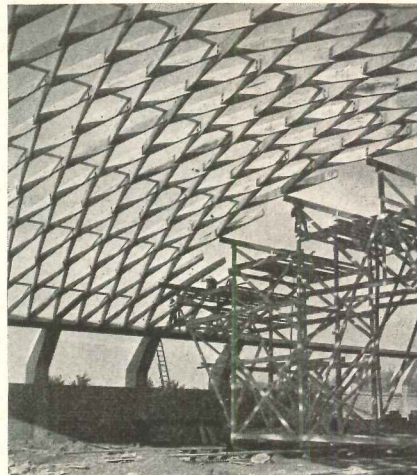
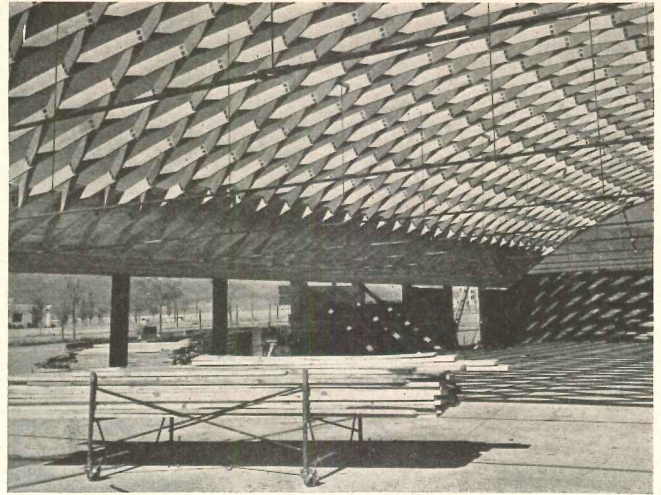

TIMBER FINDS PLACE IN STRUCTURE

By WILLIAM A. HOFFBERG
Architect and Engineer

Timber Design and Construction Handbook. By Timber Engineering Company. F. W. Dodge Corp. New York. 1956. 640 pp., illus. \$12.75

AS THIS country cuts down and digs into its reserves of materials, it cannot indefinitely afford the "tragedy of waste." The increasingly larger scale of the average building project creates the opportunity for more careful design and use of structural materials. Ignorance can remain blissful only when undetected; economic cost pressures tend to expose waste. In this situation, the careful designer must receive the help of experienced experts. Skilled manufacturers of materials and materials associations have such experts.

The healthy competition between materials has led to the growth of associations, such as we find in timber, steel, masonry and concrete. Each of these groups attempts to provide expert assistance. In this volume, the Timber Engineering Company, which is the re-

search and engineering affiliate of the National Lumber Manufacturers Association, has enlisted the efforts of more than 25 technical lumber specialists, in the preparation of a design and reference manual which will join the company of authoritative standards so often cited in performance-type building codes. Not limited to design tables and specifications, this book describes the structure and characteristics of wood and illustrates design procedures and details of timber assemblies and structures which are based on actual experience.

Reference data, safe-load tables, specifications, design standards and a glossary of terms constitute almost one-half of the book. After summarizing the properties of wood, the authors, who were coordinated by Ralph H. Gloss and an editorial committee, develop practical design methods for a very wide variety of structural elements. In addition to beams, rafters, columns and built-up sections, there are excellent

(Continued on page 62)

mounting ring

- Saves up to 80% on ceiling diffuser flush mounting costs.
- Prevents diffuser from ever sagging away from ceiling.
- Especially designed for mounting all Titus' new circular ceiling diffusers.

Here's a combination mounting ring and plaster ground that eliminates hours of extra time and work—makes flush mounting of ceiling diffusers simple, fast, low cost.

Installs in 2 quick, easy steps: (1) Slip neck of PMR over duct (2) Secure PMR to lathing channels (or construction used) with 2 screws. And that's it!

After plastering simply mount diffuser to PMR with 3 screws. There are no holes to cut in the

plaster—no trimming or patching. The Titus Plaster Mounting Ring automatically provides correct size and position of ceiling opening and centers diffuser to it.

Diffusers can never sag away from ceiling because weight of diffuser is supported by sturdy ceiling framework instead of just the duct as in most ordinary installations.

For flush mounting on all types of ceilings. Rigid steel construction. For use with Titus diffusers only.

designed by **TITUS**

MAIL COUPON TODAY FOR FREE LITERATURE

TITUS MANUFACTURING CORP., WATERLOO, IOWA

Gentlemen: Send me full details, prices on the new Titus Plaster Mounting Rings that cut flush mounting costs up to 80%.

Also send literature on the new Titus Ceiling Diffusers and Accessories.

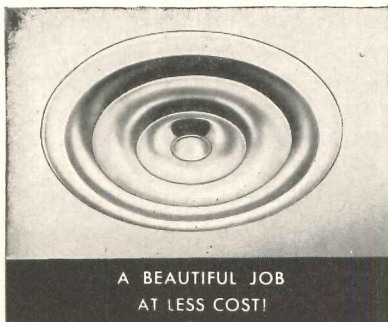

Name _____

Company _____

Address _____

City _____ State _____

Executone gives you **4-way service** for sound and intercom systems!

We provide not only wiring plans, shop drawings, specifications and costs, but with our nation-wide organization of exclusive distributors we also give your clients on-premise maintenance of equipment and instruct their personnel in its proper use. If you have a job on your boards that should utilize intercom or sound, you should be familiar with these four important Executone services:

Not only this...

- 1 Consultation Service**
Executone's Field Engineers will assist you in determining your clients' communication needs... recommend the system designed for the job... provide you with a professional consultation service.
- 

But also this!

- 2 Installation and Supervision**
Each local Executone distributor is prepared to take full responsibility for the final and satisfactory operation of the system, whether installed by the contractor, or his own factory-trained crew.
- 3 On-Premise Maintenance**
Each local distributor is staffed with skilled, factory-trained technicians. They also have complete stocks of standard replacement parts. Continuous, uninterrupted performance of every Executone system is assured.
- 
- 4 Personnel Instruction**
Local Executone representatives instruct your clients' personnel in the proper use of Executone Systems. This planned program assures maximum benefits through proper operation and utilization of their systems.

Architects and engineers are invited to send for Executone's 325 page Reference Manual "P-10." No charge or obligation. Please use your letterhead.

Executone

INTERCOM AND SOUND SYSTEMS FOR
HOSPITALS, SCHOOLS, HOMES, PLANTS, OFFICES

415 Lexington Ave., New York 17, N.Y. • In Canada... 331 Bartlett Ave., Toronto



REQUIRED READING

(Continued from page 58)

chapters on trusses and arches, including the lamella roof. Although a knowledge of structural theory and analysis is assumed and is not within the scope of this handbook, arches are skillfully presented and represent the practices of the companies which, in about 20 years, have almost created an industry based on the process of glued lamination in the form of timber beams and arches, including long-span arches, which are shop-fabricated, planed, finished with sealers or varnish and protected for shipment.

Timber fastening devices and connection details are brought up-to-date and are extensively illustrated. The increased use of metal timber connectors and anchors is an important development which is discussed by experienced specialists who present the know-how. Shop fabrication and pre-assembly methods are described and a knowledge of these is required for economical joint detailing.

When there are many authors, some repetition is to be expected and a degree of inconsistency develops in assumptions regarding deflection. The inclusion of timber bridges, composite timber and concrete decks, piers, trestles and towers, even ships, indicates the wide range of topics. Plywood, which is now a major material of construction and finish, has much less space devoted to it than the subject of trusses; and the great possibilities inherent in stressed skin panels, as developed by the Forest Products Laboratory, are insufficiently amplified.

Wood, which is one of the last of the "natural" materials, was used in log or sawed rectangular shapes, until wood technology improved grading methods, developed timber connectors and developed shop fabrication equipment and processes. From the chemical industry came the preservatives which can retard the decay and increase the fire resistance of lumber, the glues which connect the sheet laminations of plywood and the horizontal laminations of glued laminated members, the plastics to protect the wood finish and to offer many new future combination possibilities. As stated in the foreword of this volume, wood has become a truly engineering material and this manual is an authoritative reference of current data and practice.

(Continued on page 390)

FIVE HOUSES

YAMASAKI
JOHNSON
KOCH
RUDOLPH
KECK

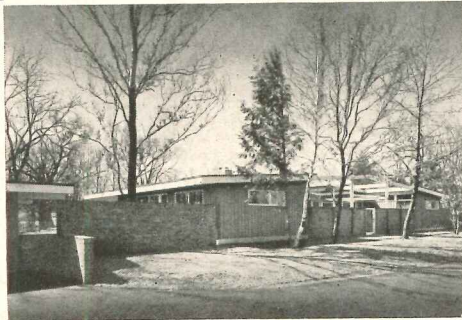
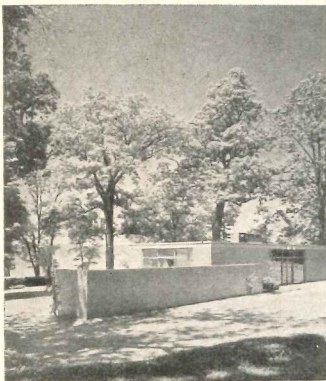
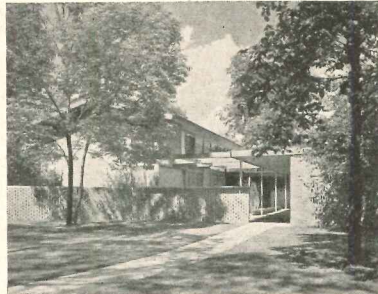

NOVEMBER 1956 ARCHITECTURAL RECORD

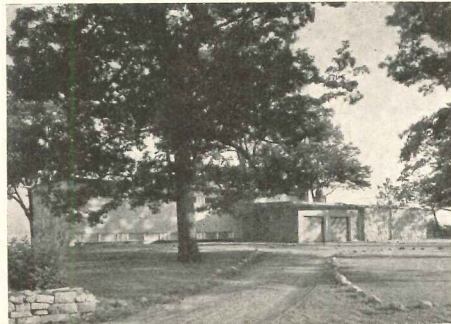
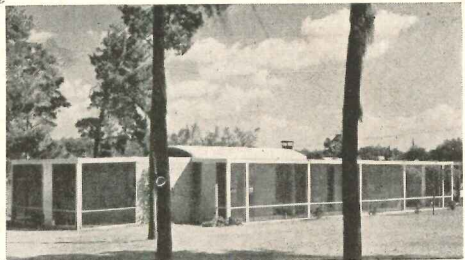

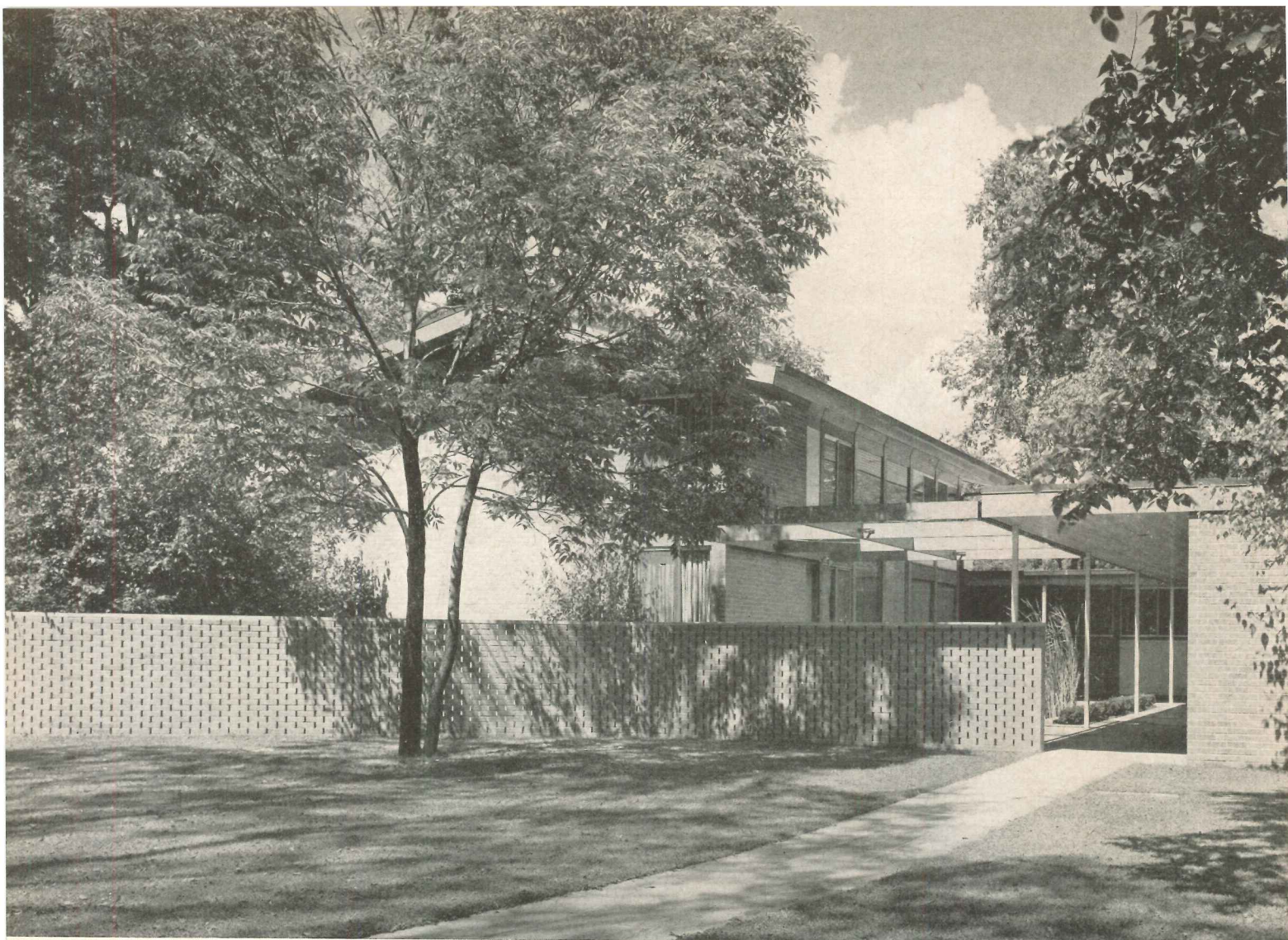

MANDATORY: TWO STORIES, PITCHED ROOF

Residence of Mr. and Mrs. S. Brooks Barron
Argyle Crescent, Detroit, Michigan
Yamasaki, Leinweber & Associates, Architects

On an urban site with a full freight of restrictions a most gracious two-story house has been achieved in a day when these are relatively rare specimens. With a group of rich materials the architects have organized a rewarding sequence of movements through space.

ZONING LAWS in this well established section of Detroit made two stories and a pitched roof mandatory, but both archi-

tects and owners favored a one-story house. The solution was a two-story bedroom wing at the front of the lot, important enough to comply with the restrictions, and a one-story living, dining and service wing at the rear.

Other major design goals were "to achieve an introverted aspect" and to build up "a sequence of surprises deliberately planned to make walking through the house more enjoyable." The latter

FIVE
HOUSES

1. YAMASAKI

From street (left) house complies fully with zone restrictions demanding two stories and a pitched roof. At rear of lot, however, house is only one story in height and flat-roofed. Outwardly conservative entrance leads to court and pool of thoroughly contemporary design. Construction is wood frame on masonry block foundation; exterior walls are brick; roof is built-up

Hedrich-Blessing

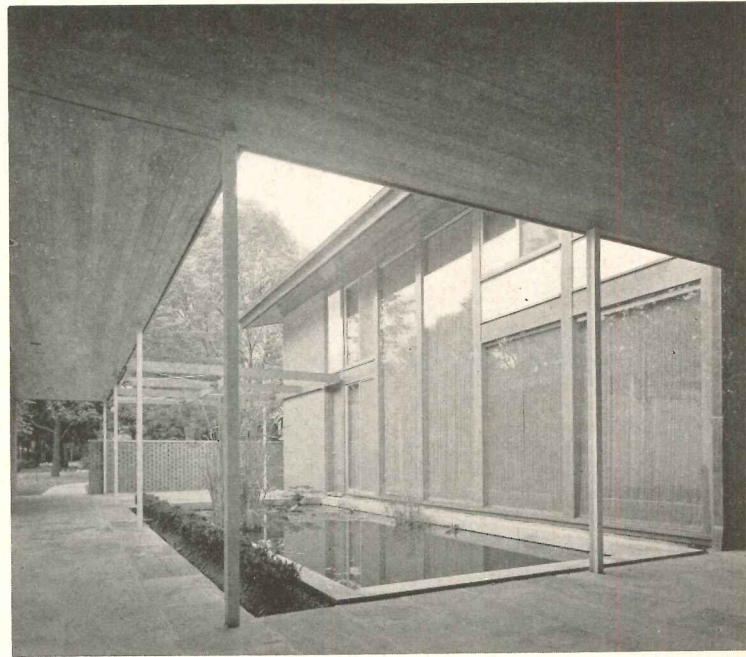



Hedrich-Blessing

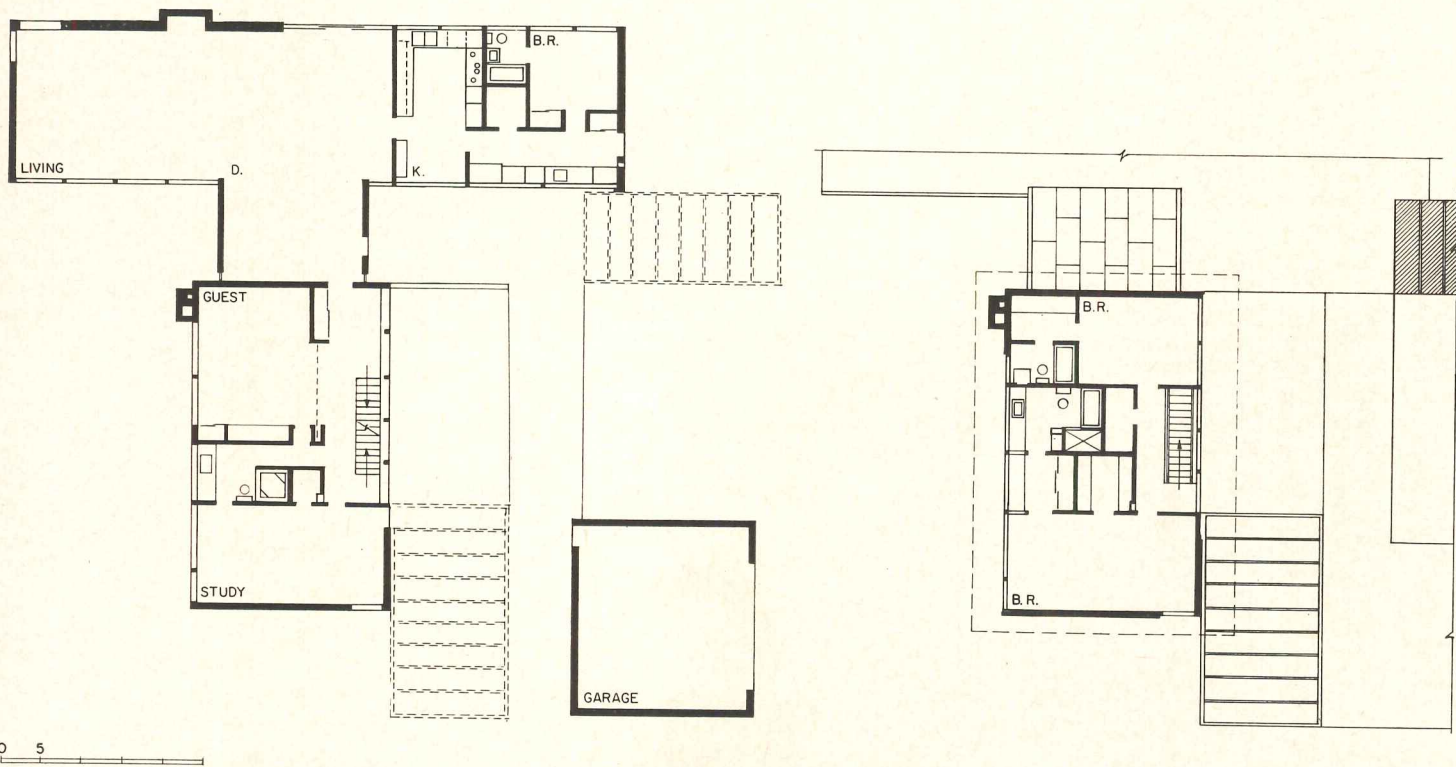

FIVE HOUSES

1. YAMASAKI

Living and dining areas are separated only by a slight change in floor level; openness is accentuated by sky view from adjoining entrance hall. Idea of living room pit was to define seating area and increase seating space without "loading the place with furniture." T-shaped plan gives direct access from entrance hall to every room except for the service wing. Landscape architect was Edward A. Eichstedt; interiors are by Florence Barron, wife of the owner

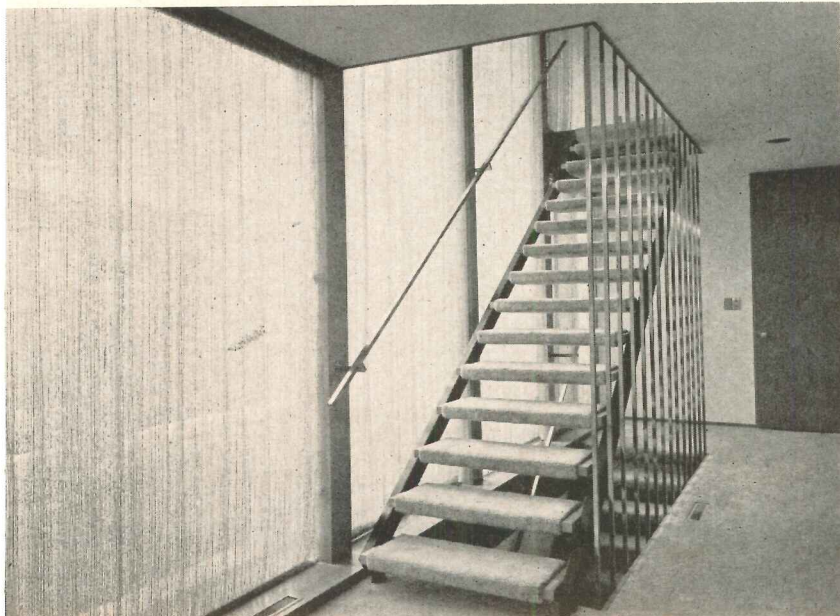
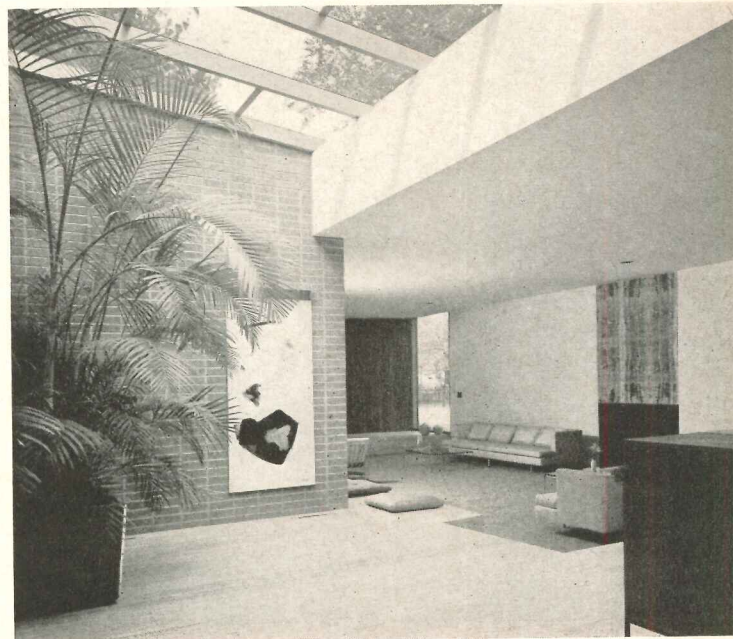

FIVE HOUSES

1. YAMASAKI

included: (1) the shadows and openness of the covered walk and pool area as approached from the street; (2) the sky view from one end of the living room; (3) the garden view from the living room pit. "Though the idea of surprises may sound dramatic," the architects comment, "our emphasis was to try for an elegant house rather than a dramatic one . . . thus the relatively low ceilings for a house of this size."

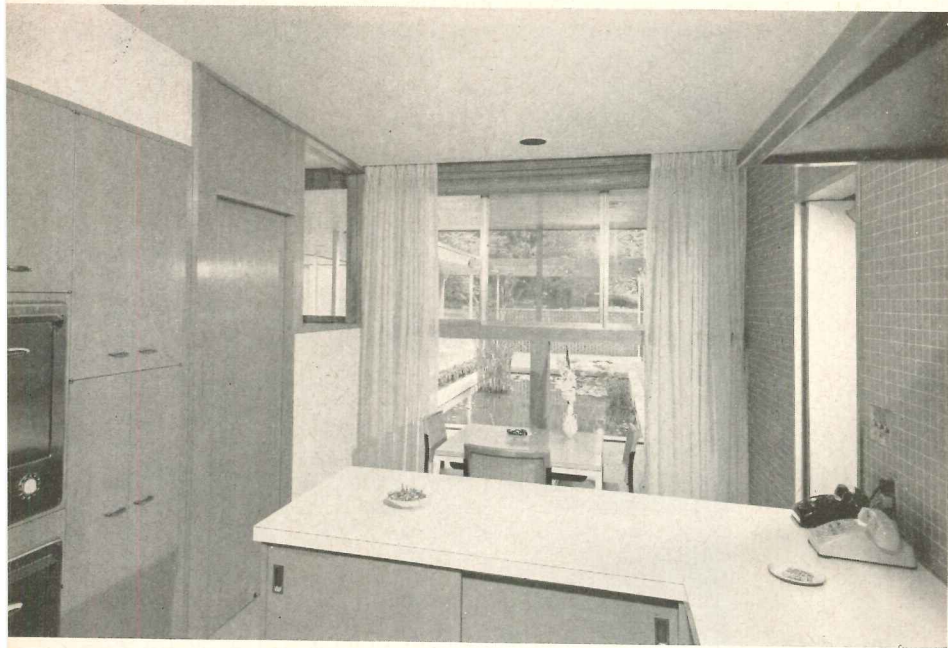

Hedrich-Blessing

Kitchen has as pleasant an outlook as any room in the house — entrance court at one end, side of lot at other. Walls here and in bathrooms are ceramic tile

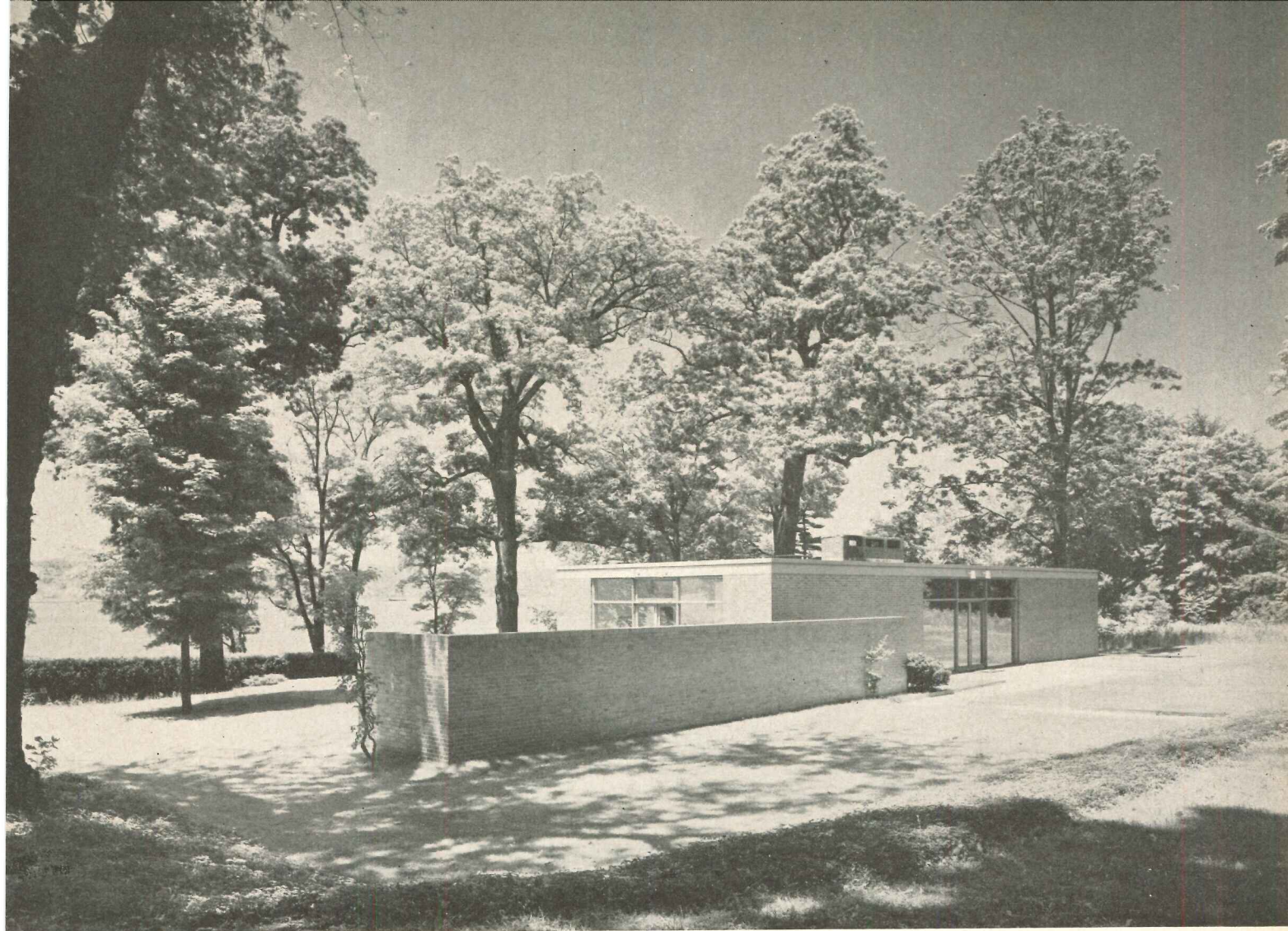

© Ezra Stoller

BEAUTIFUL SITE, NO SPECIAL REQUIREMENTS

*Residence for Mr. and Mrs. Sterling Fisher
Irvington-on-Hudson, New York
Philip Johnson, Architect*

This small house must certainly stand as a most instructive example to all who seek the dignifying rewards of formal order. It is simply conceived, finely wrought. Fitted skillfully to its site with transitional terraces and garden walls, it is disposed with an air of great ease along the coordinates which organize its four grouped openings. Dimensionally it produces that effect of being larger than reality which is the essence of good scale in small buildings.

THE LONG REACHES of the Hudson are reiterated in the long, low lines of this house overlooking one of the broadest and loveliest parts of the river. House and site are completely integrated, each complementing the other.

The site, wooded and gently rolling, presented no problems, and neither did the owners, who had no special requirements. Given such virtual *carte blanche*, the architect chose perfect symmetry as

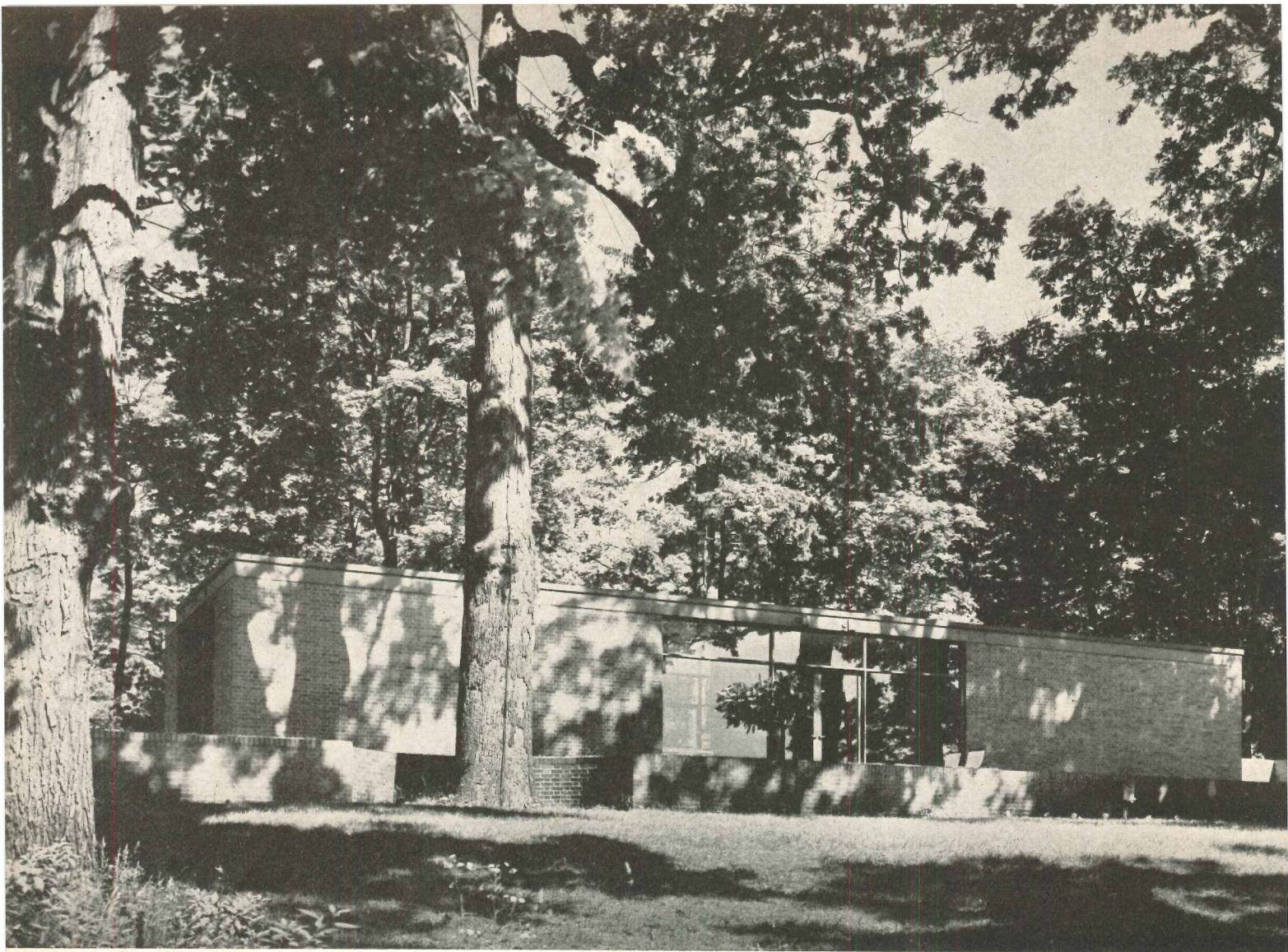

© Ezra Stoller

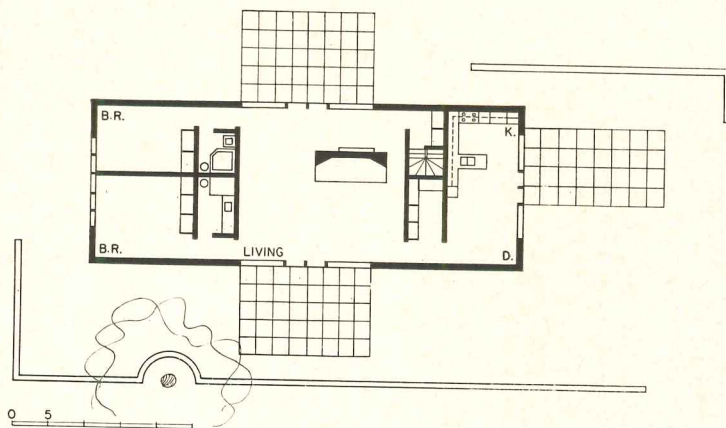

FIVE
HOUSES

2. JOHNSON

Rear of house (opposite page) faces a fine view up and down the Hudson River; here a broad raised terrace permits enjoyment of the view with the house itself providing privacy from the street. Smaller dining terrace (below) is shielded by high brick wall. Main entrance (bottom of page) and doors to both terraces are treated exactly alike; each has twin spotlights almost at the roof line which serve to bring the outdoors into the living area at night

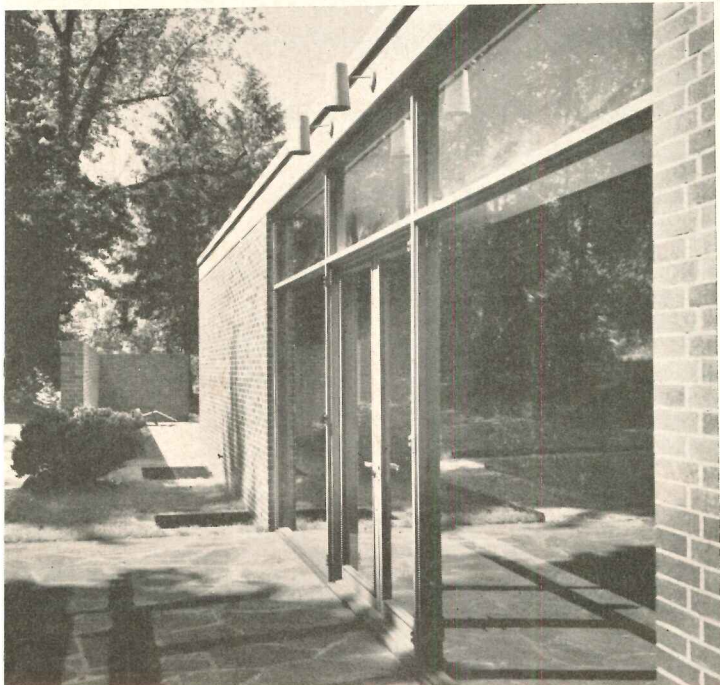
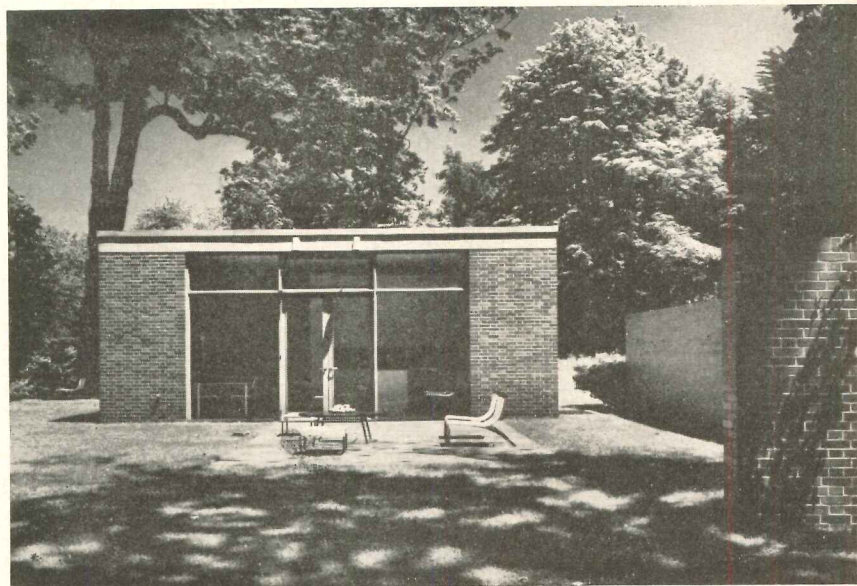
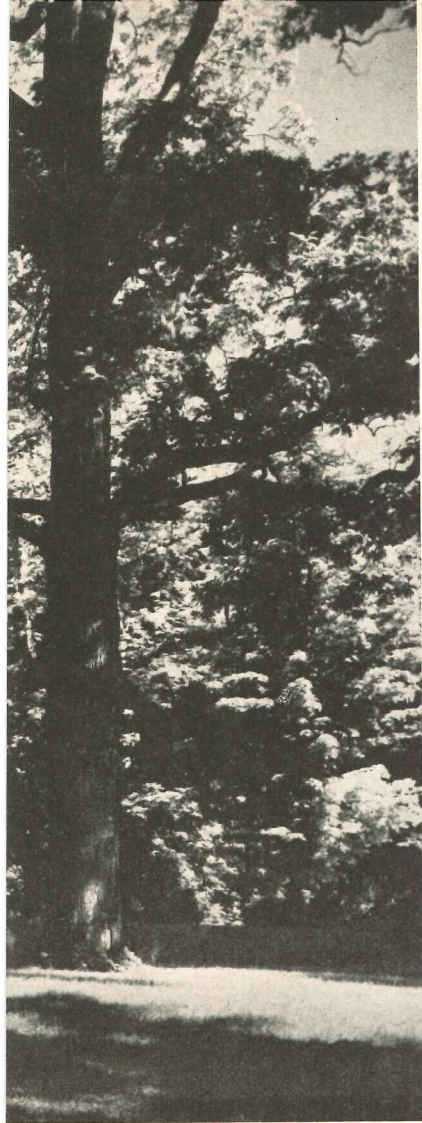

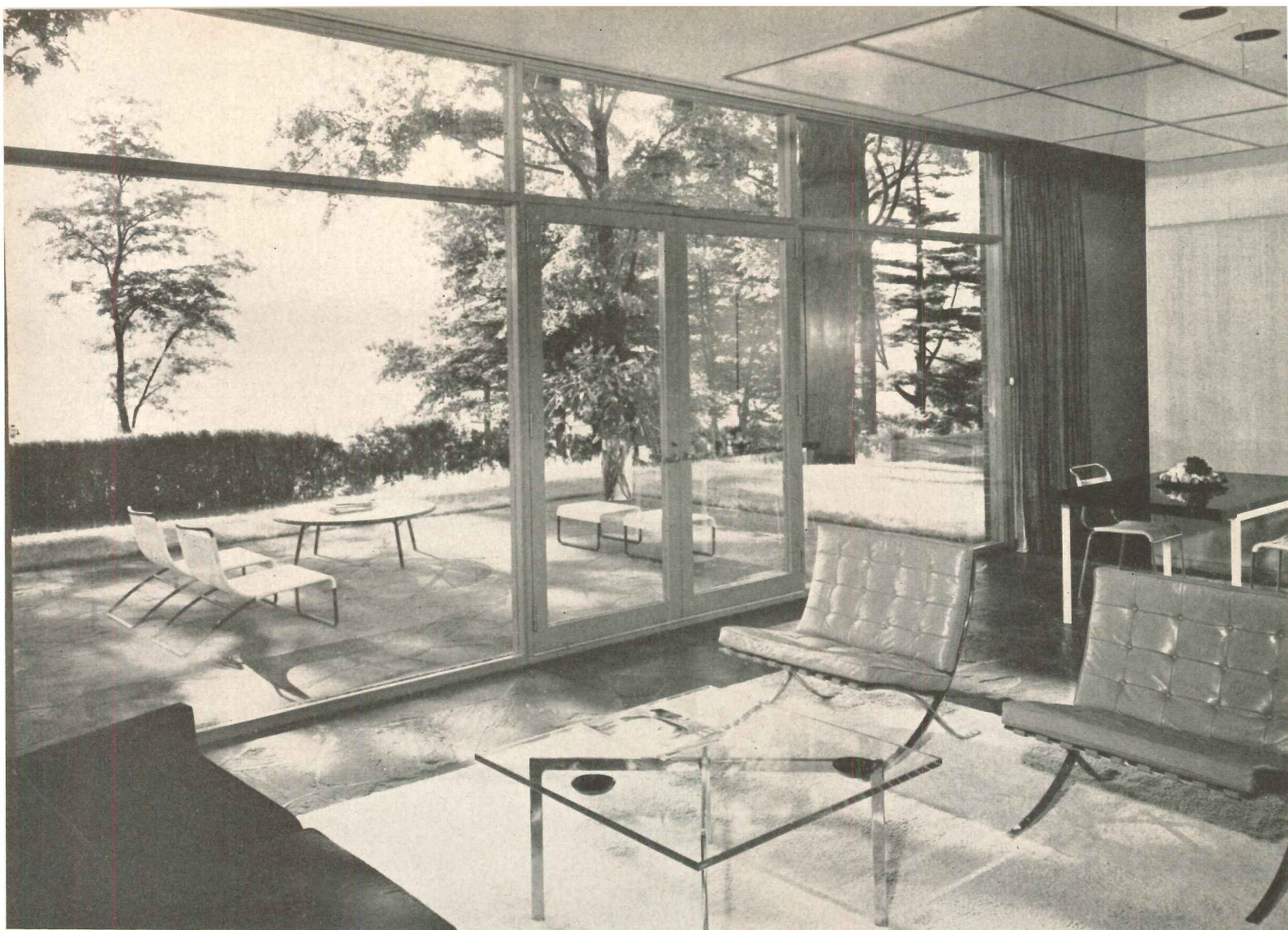

© Ezra Stoller

the theme of his design. Glass and brick are played against each other in four repetitive façades, the glass limited to one large area in the center of each wall. This treatment gives the house height on the exterior and precludes a “boxy” feeling; it also combines a sense of enclosure with one of openness both on the exterior and within.

The emphasis on symmetry extends also to the plan (see preceding page). The living room is in the center of the rectangle, spanning the house; the bedrooms are at one end, the kitchen is at the other.

A free-standing fireplace — interestingly off-center — creates an entrance hall without disrupting the openness of the central living area.

A large terrace to the rear overlooks the river view and greatly augments entertainment space. The smaller terrace adjoining the kitchen provides a pleasant place for outdoor dining, sheltered from the street by a high brick wall.

Considerable attention to detailing is obvious in the photos on these pages. So is the high quality of construction materials and the excellent cabinet work.

FIVE
HOUSES

2. JOHNSON

Living room has floor-to-ceiling glass on both sides for almost its full length; downlights and a large ceiling baffle add interest at night. Kitchen is open on two sides, has unusual amount of storage space, unfortunately not visible in photo below. Main entrance (bottom of page) leads from front terrace to a small hall formed by living room fireplace. Long corridors to bedrooms at one end, kitchen-dining area at other emphasize length of house and openness of plan

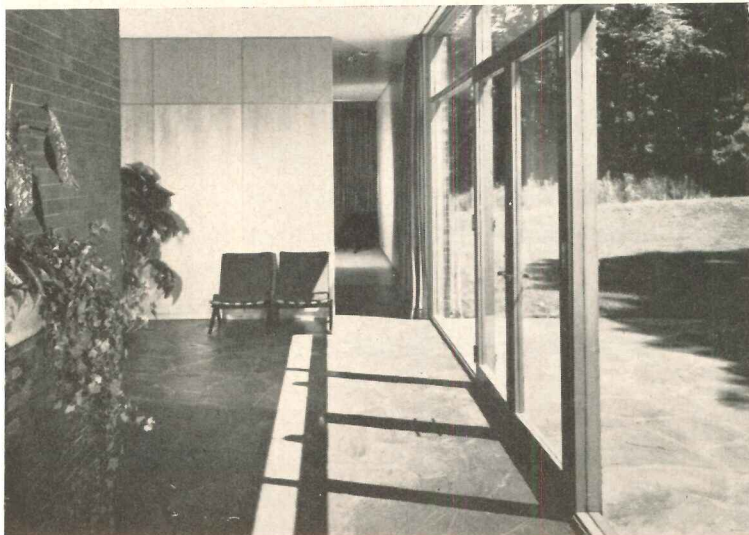

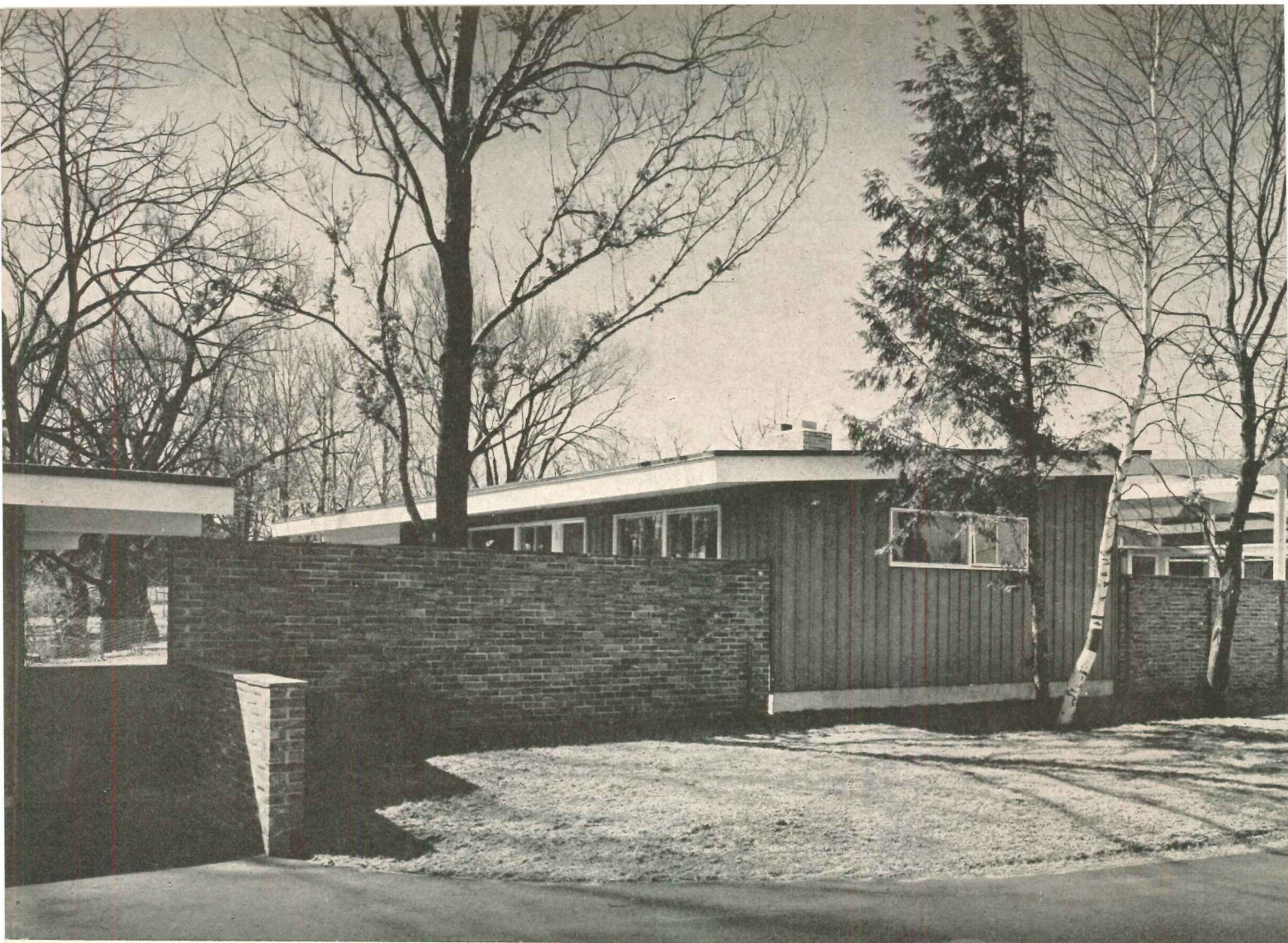

PRIVACY ON INSTITUTIONAL GROUNDS

**Director's Residence, Perkins School for the Blind
Watertown, Massachusetts**

Carl Koch & Associates, Architects; Margaret M. Ross, Associate

An unusual and difficult program has here stimulated an exceptionally useful and attractive house. Chief among its virtues are its carefully considered plan relationships and its rich variety in textural composition.

THE BIG PROBLEM in the design of this house was to tie it in with the existing buildings of the institution of which it is a part, and at the same time to give

it a residential character of its own. Since all the other buildings are brick, the obvious tie-in was the repetition of that material on the exterior. The wife of the present director, however, dislikes the texture of brick (she is blind), so brick was used only for the long wall which shuts the house off from the school grounds. Only the maid's room and one bedroom directly overlook the campus,

FIVE HOUSES

3. KOCH

Long brick wall at front of house is deliberate link to brick façades of other buildings on Perkins campus. It also provides a sheltered entrance patio and a pleasant service court. House itself is wood frame on poured concrete foundation; exterior walls are redwood board and batten. Thermal insulation is glass fiber, heating is radiant in floor and ceiling



Lionel Freedman





Lionel Freedman

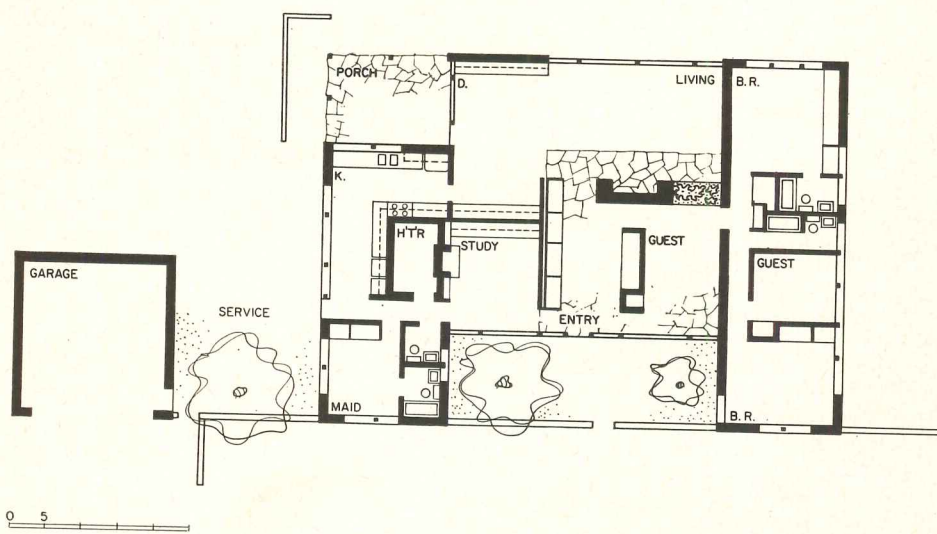

FIVE HOUSES

5. KOCH

House was planned around the sensitive touch of the blind, with considerable emphasis placed on texture. Living-dining area (left) and entrance hall are separated by rough stone fireplace and change in flooring; sliding glass doors enclose dining space when desired. Study (bottom of page) has built-in shelves, desk and storage unit. Room dividers, planting boxes and doorways are well located to keep blind visitors from getting lost as they walk from room to room

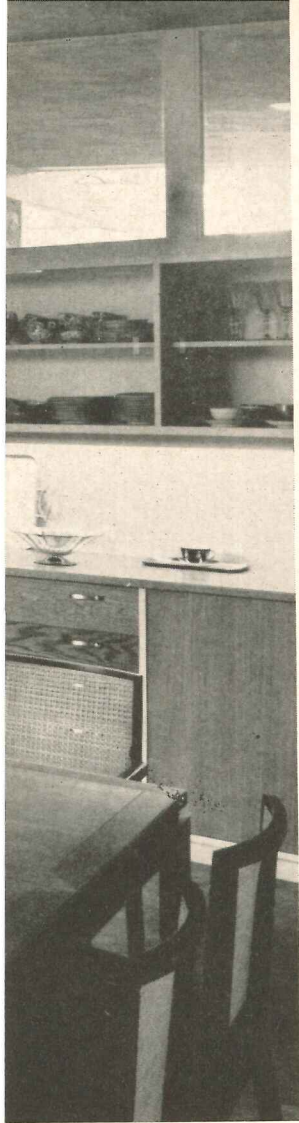

FIVE HOUSES

3. KOCH

and even these also face walled-in gardens.

Texture, of course, played an important part in the selection of construction materials: flagstone entrance hall, asbestos tile flooring elsewhere; rough stone fireplace wall; smooth plaster; cool glass. Much of the furniture is built in and the entire house is planned in straightforward fashion with no unusual features which could confuse a blind person — an important point when students at the school are entertained.

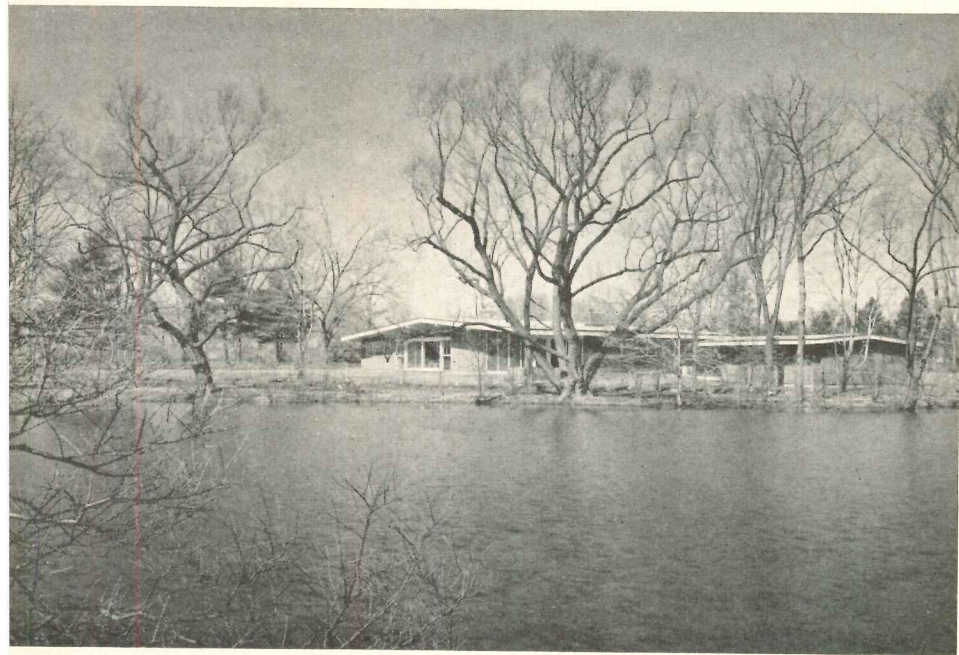

Lionel Freedman

Rear of house faces fine view over a pond; living-dining area and master bedroom are on this side, well away from campus activities and street noises

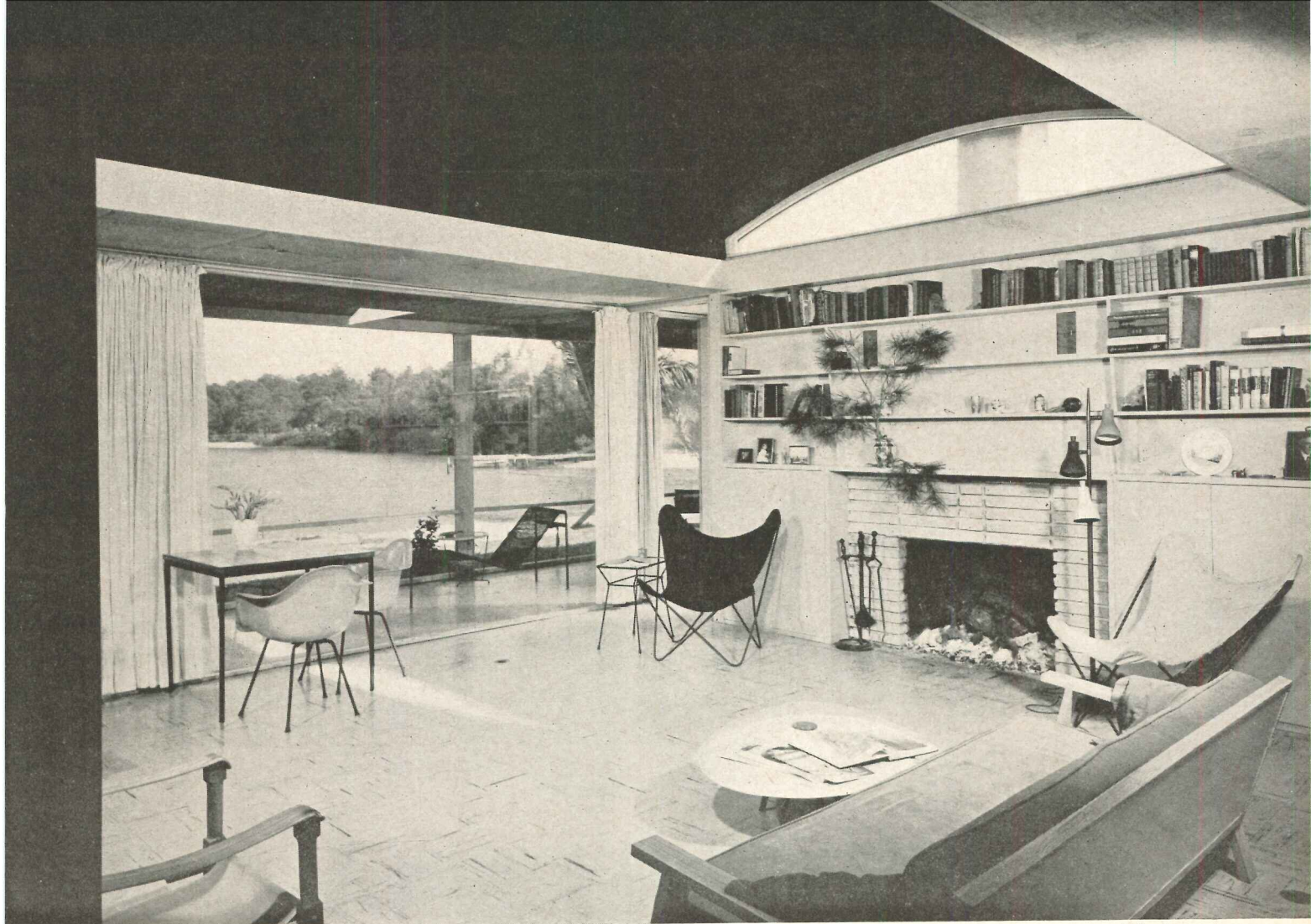

© Ezra Stoller

VAULTED CEILING, FOUR PORCHES IN THE SOUTH

*Residence of Mr. and Mrs. Davidson
Bradenton, Florida
Paul Rudolph, Architect*

Again the architect has addressed the problem of dignity in the small house and has found a most satisfying answer in the calm ordering of precise, repetitive constructional bays. The slim rectangle opens on all sides to the winds; breeze and sun controls — along with the pleasant vaulted living room — have enriched the simple volume of this fine house. It is an excellent example of regional forces generating particular and significant forms.

COMFORTABLE LIVING INDOORS is always a problem in warm climates. As the architect of this house puts it, "the colonnaded four-sided Greek Revival house in the South has possibly never been surpassed in terms of making the southern climate livable. But the forms derived by earlier builders quite often need reinterpretation . . . and this is the underlying thought behind this structure."

The house, designed for a couple with

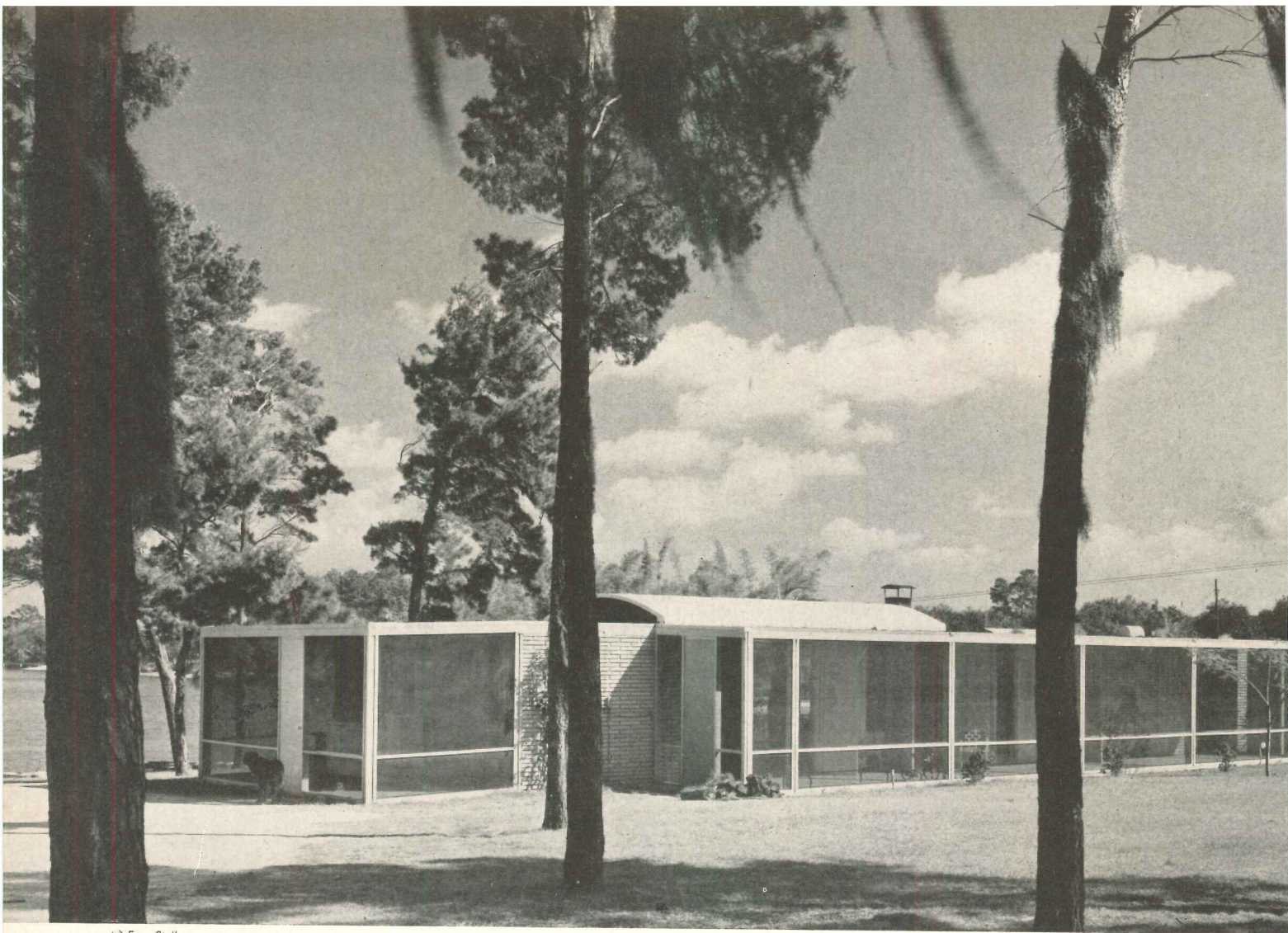

© Ezra Stoller

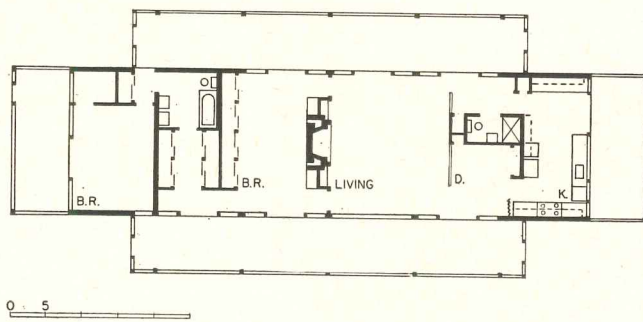

FIVE HOUSES

4. RUDOLPH

Located on the west coast of Florida, south of St. Petersburg, the house is almost on the water's edge to take full advantage of a sweeping view and the prevailing breeze. The original plan for ventilation—the series of horizontal pivoted flaps shown in the drawing below—was abandoned in favor of less expensive doors. Simple detailing, avoidance of expensive construction materials, and an uncomplicated plan resulted in a remarkably low total cost

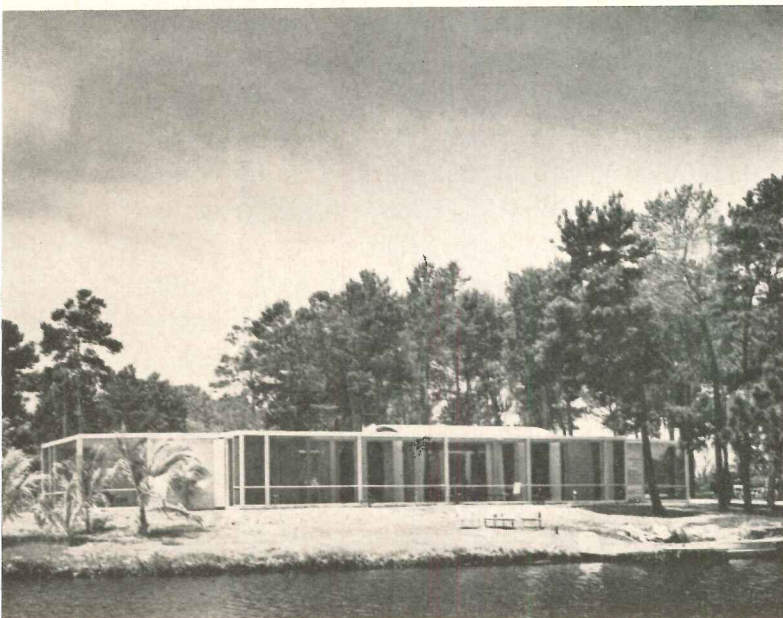
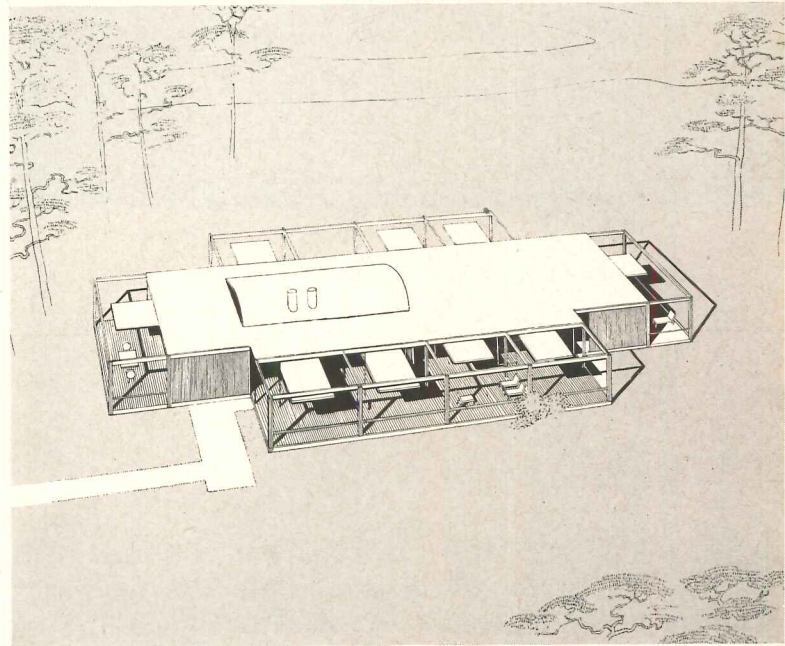
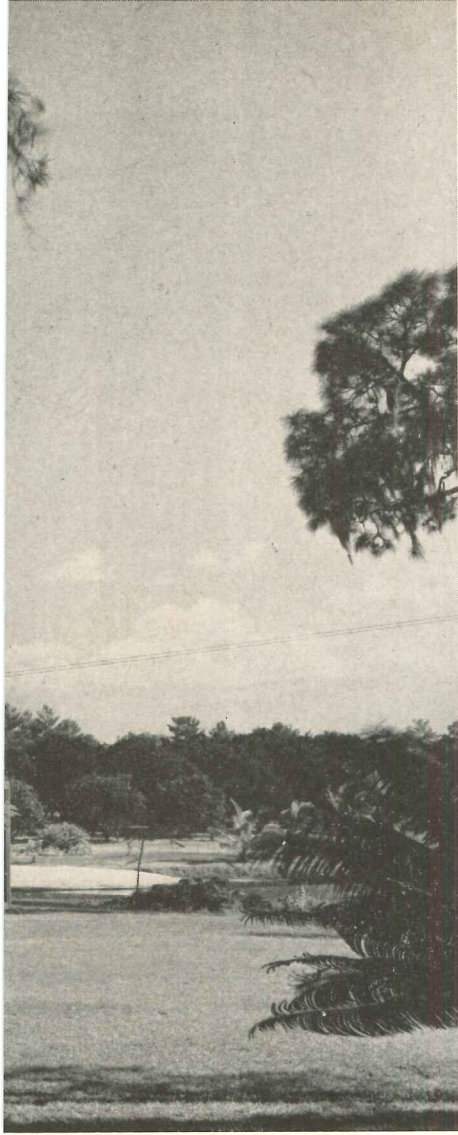

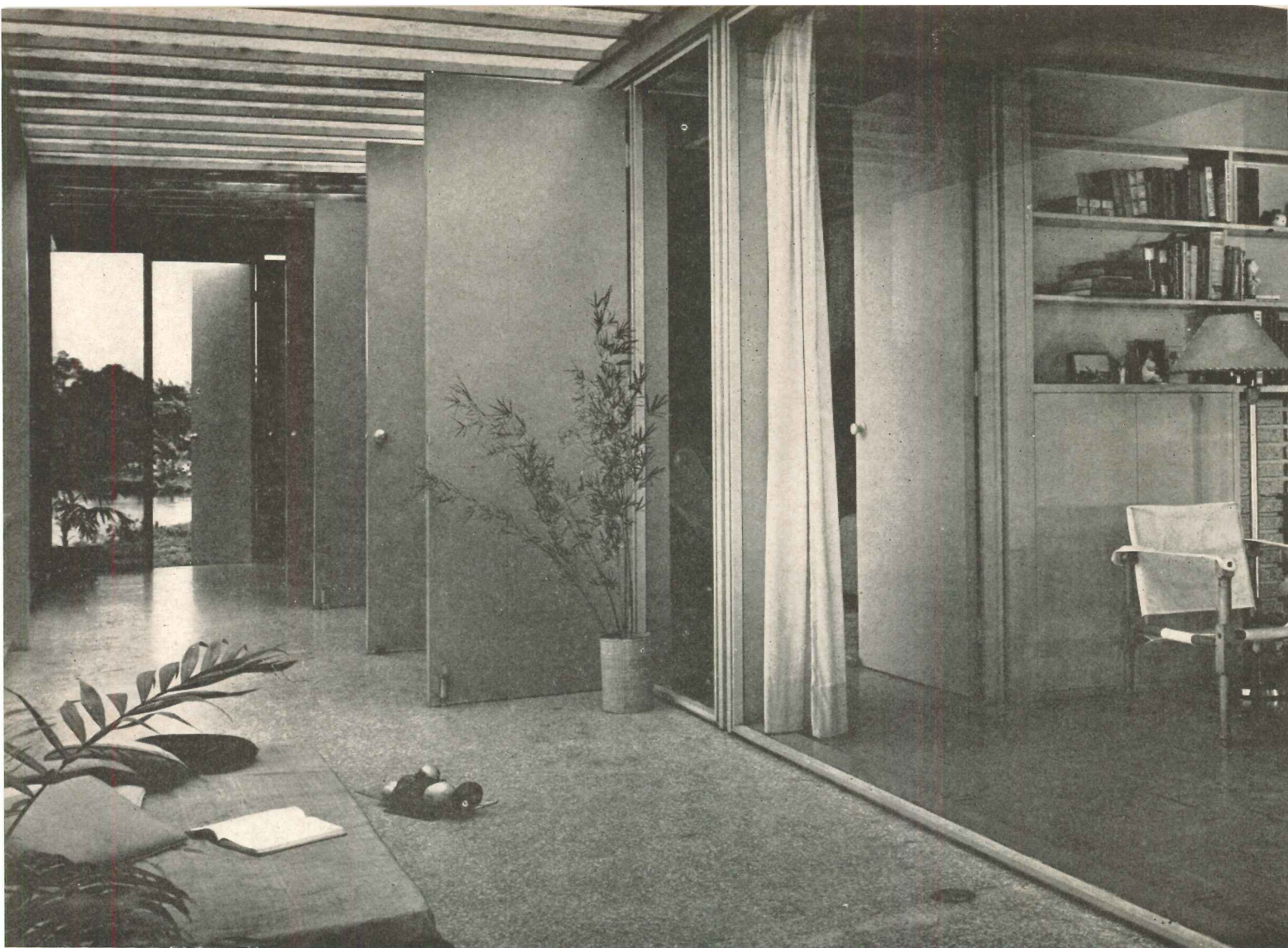

William Amick

one child, is a simple rectangle with screened porches on all four sides. The living room extends the full width of the house and has a plywood vaulted ceiling to "pull the space together" and give it a sense of enclosure which, the architect says, "a room with openings on two sides often seems to lack."

The porches are covered with natural vinyl plastic sheets which allow a soft light to filter through. Two of the four serve as entertainment areas (the one to the south for winter use), one is the daughter's special territory, and the last

is the traditional service porch. Both the latter were especially requested by the owners.

Ventilation originally was intended to be through horizontal pivoted flaps (see sketch on preceding page), but flush panel doors, floor to ceiling, were substituted for simplification of detailing. The openness of plan ensures adequate ventilation regardless of wind direction.

Construction is dry wall with a plywood ceiling covered in the living-dining area with pandanus cloth. Porch floors are asphalt tile.

FIVE
HOUSES

4. RUDOLPH

The hinged ventilation flaps which the original design called for undoubtedly would have been more attractive and less space-consuming than the many doors, but the doors work equally well: when they all are open the breeze can blow straight through both living-dining room and master bedroom, which are flanked by the two long porches. The child's room has cross-ventilation and its own porch, as does the spacious kitchen at the opposite end of the house

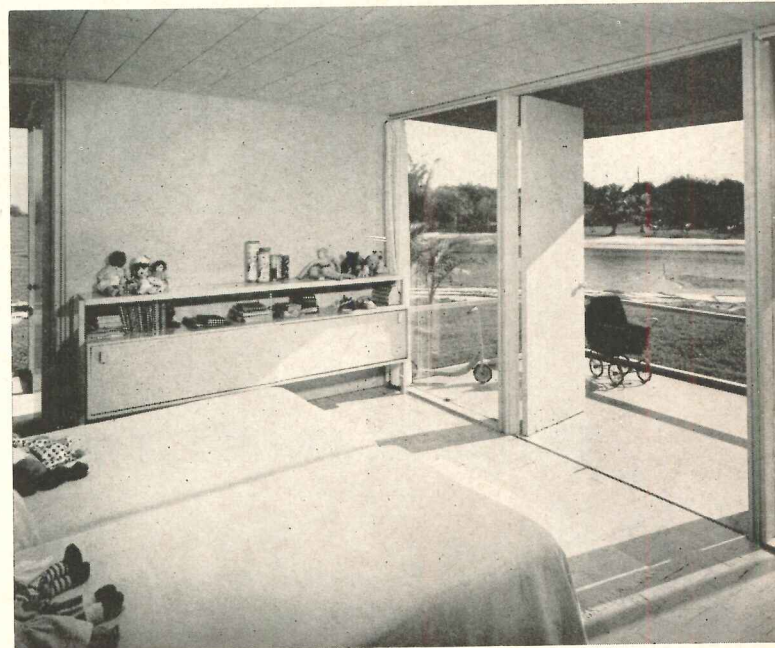

William Amick

© Ezra Stoller

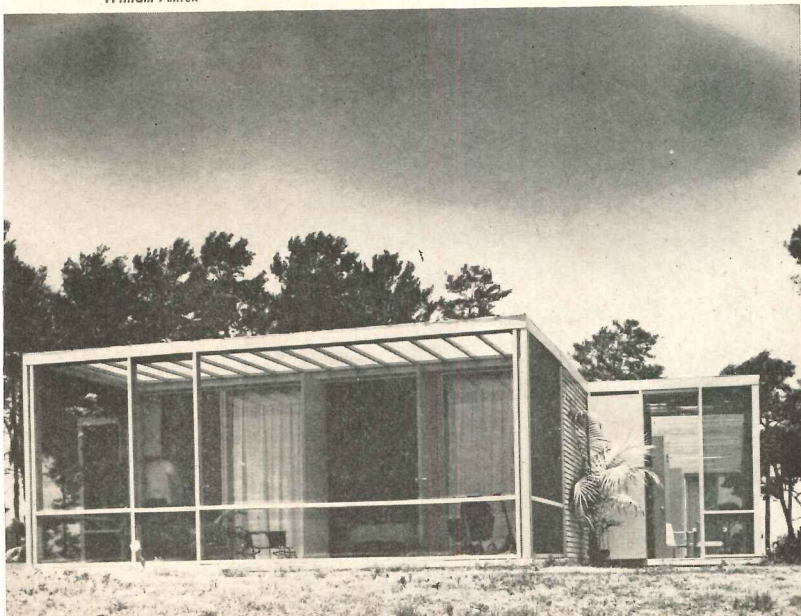

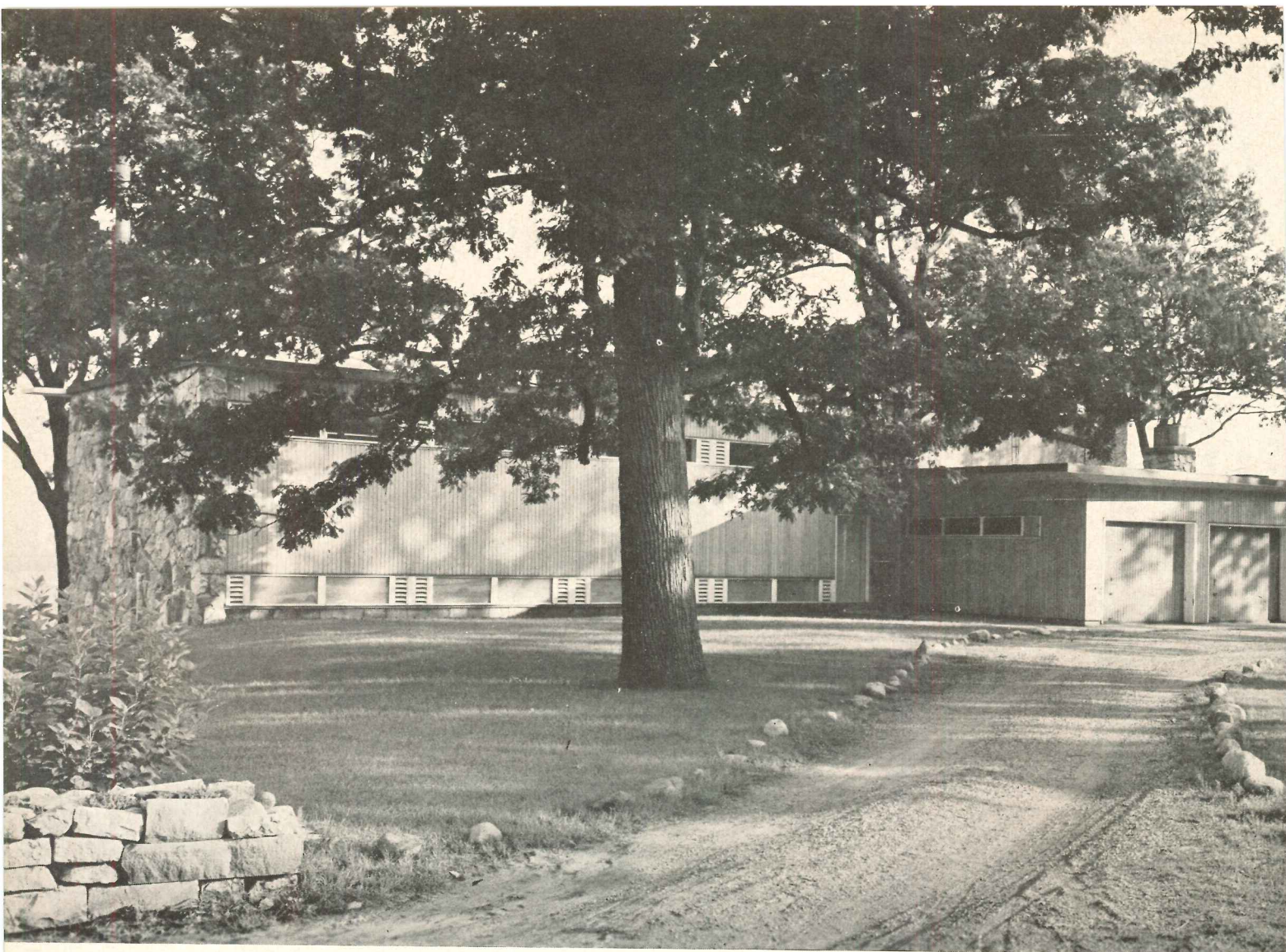

INTERIOR COURT, TERRACES AT REAR

*Residence for Mr. and Mrs. Herman Grossman
North Muskegon, Michigan
George Fred Keck and William Keck, Architects*

A deft juxtaposition of light and solid areas gives this house its individuality: the lightness of vertical cypress siding and glass and the large areas of rough glacial stone are in bold — and effective — contrast. Unusually fine detailing and a spaciousness in plan combine to create a residence of dignity and elegance.

A FINE OLD OAK TREE in the middle of the property played a large part in the selection of an interior court plan for this house on the shore of Lake Muskegon. The court lies between the garage and the living room, providing a safe place for the owners' three small children to play, and giving the living area a pleasant out-

FIVE
HOUSES

5. KECK

One wing of house has two levels, with lower level windows above ground. Street side (left) is largely enclosed for privacy; opposite side (bottom of page) is almost continuous glass. Interest on lake side is heightened by cantilevered stairway to terrace and sun deck and by sun shades for large glass areas. Exterior vertical siding is cypress, grayed out. Glass is all insulating; floors are black, waxed and scored concrete on ground, oak on upper level

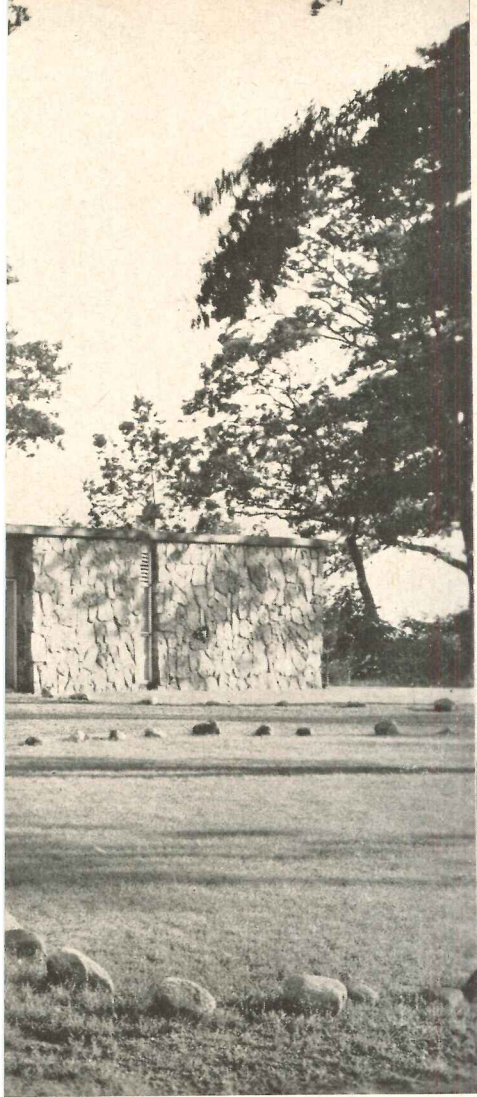

Hedrich-Blessing

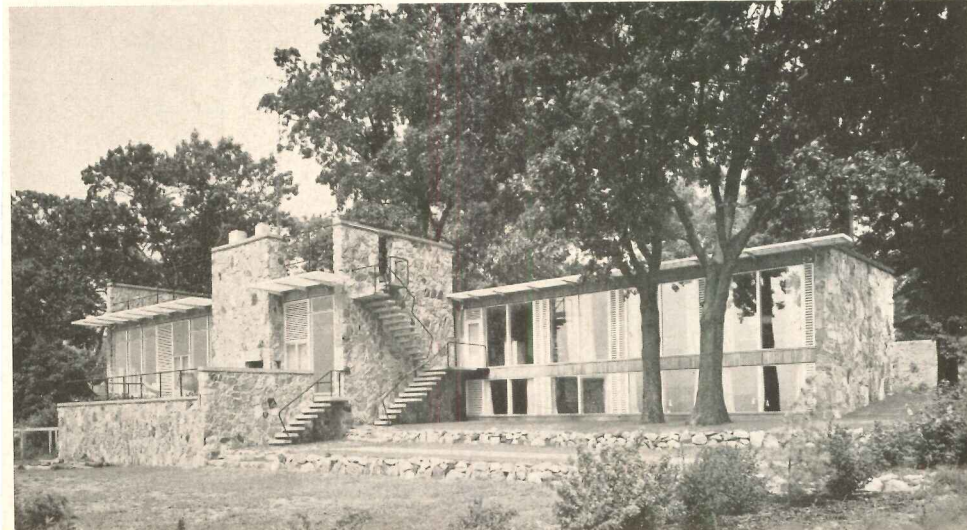
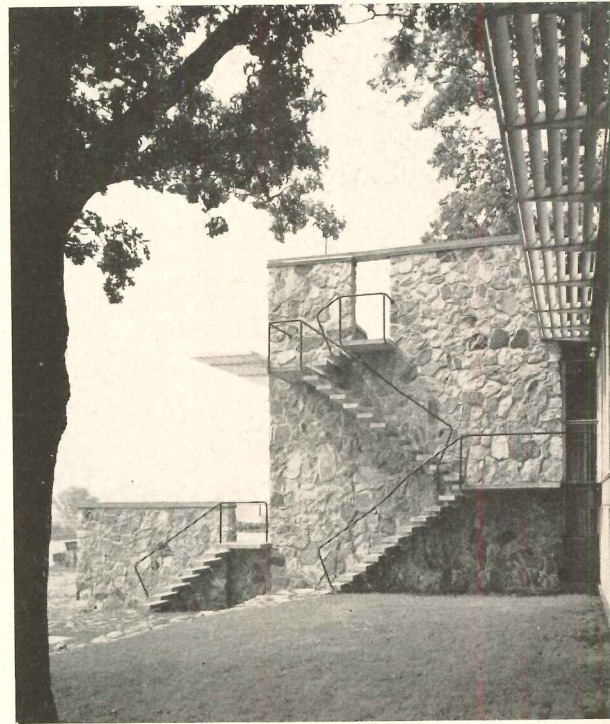

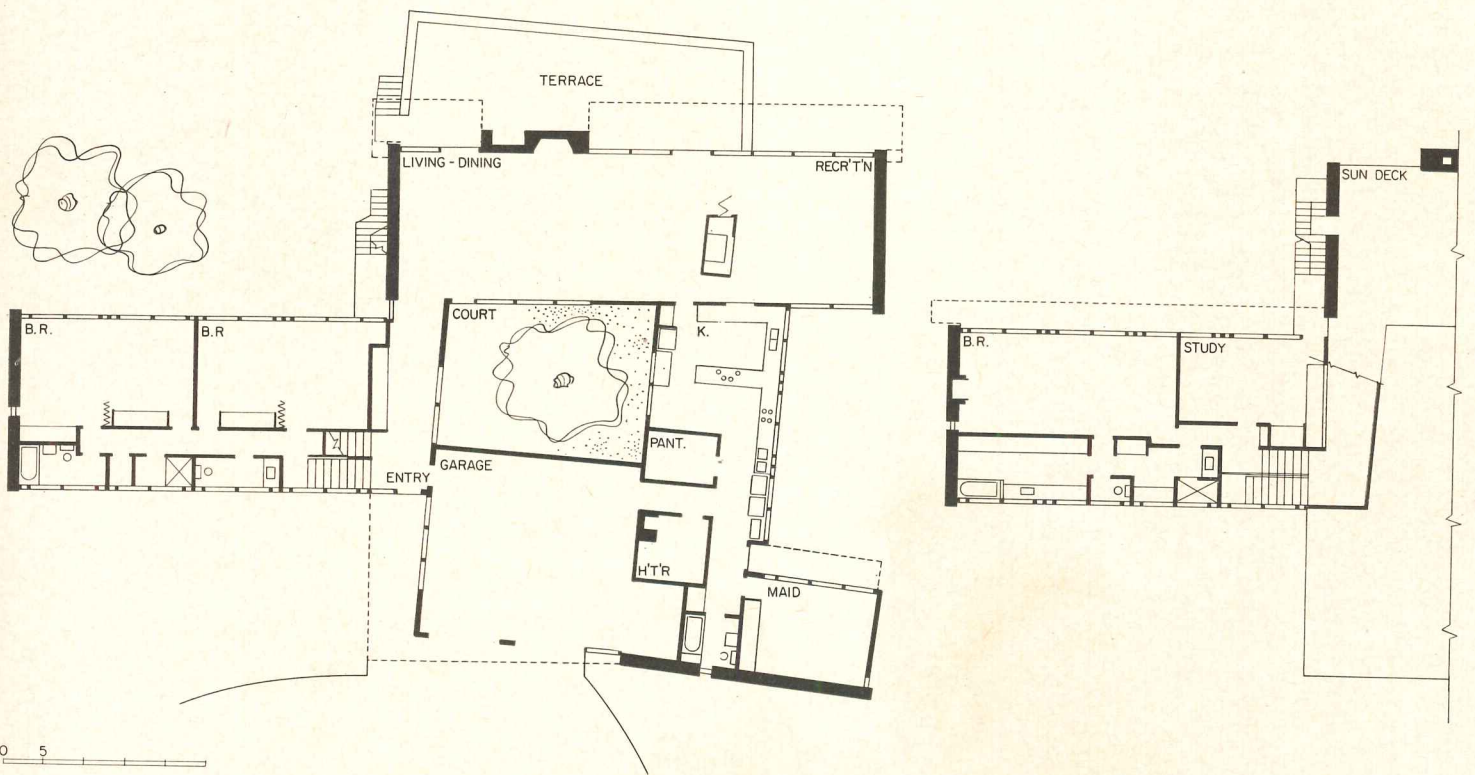
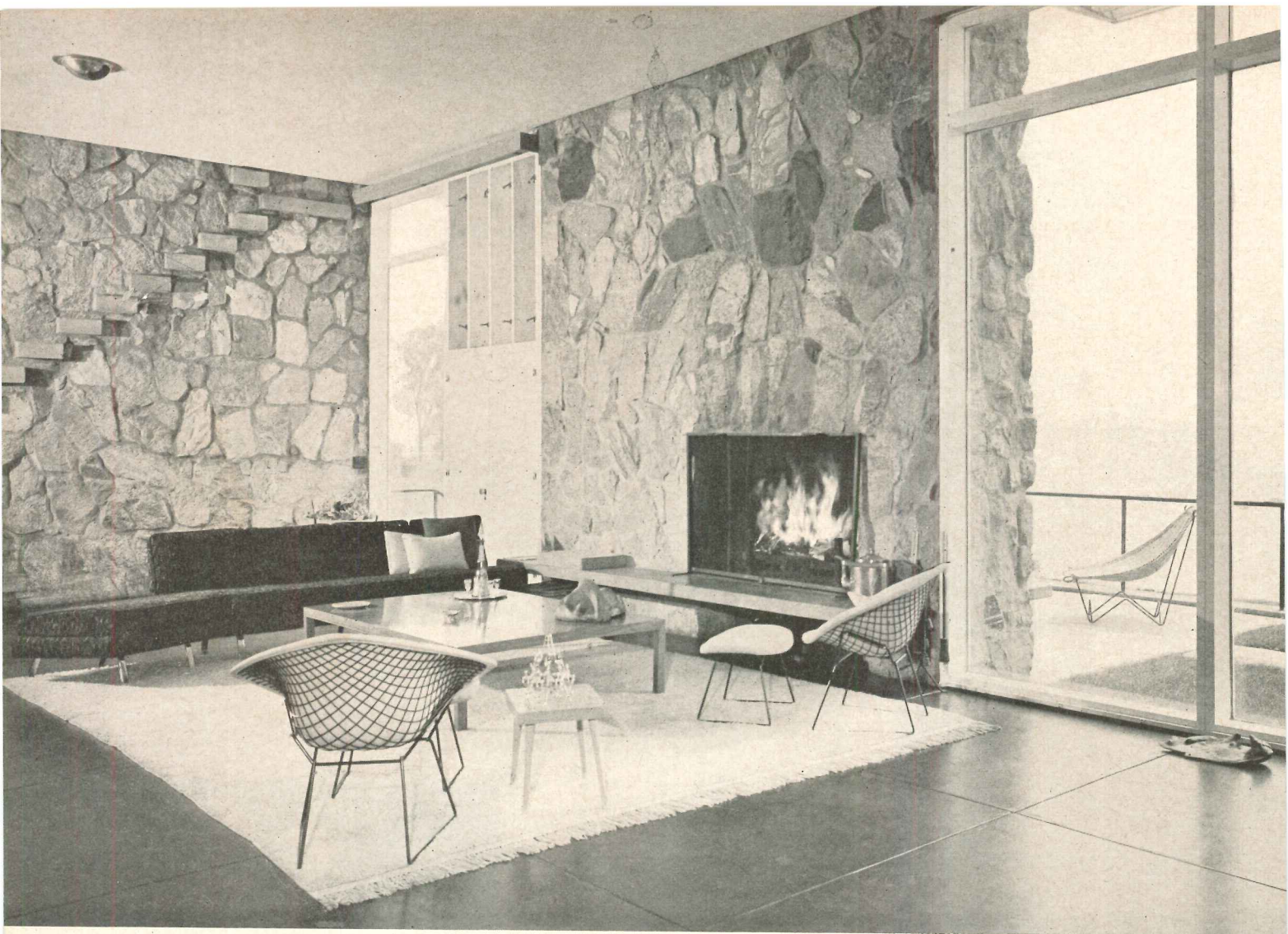

FIVE HOUSES

5. KECK

Stone used is a glacial deposit of gray-to-pink granite with some basalt interspersed; stones were split and selected with great care, and laid up, in most cases, as an insulated hollow wall with metal tiles. Exterior cantilevered stairs to sun deck are expressed on living room wall by exposed ends. Central court (below) is usable most of year; snack bar is served from pass-through to kitchen. Recreation room (bottom) has built-in bar and small projection booth

Hedrich-Blessing



FIVE HOUSES

5. KECK

look on both sides. The rear of the house overlooks the lake; here there are two broad terraces and a sun deck. Although intrinsically part of the master bedroom suite, the deck is accessible from all parts of the house via both exterior and interior stairs. Some of its walls were carried up to afford wind protection and privacy. The house has a flat roof for use as a deck with duck boards and to hold a thin sheet of water for cooling.



Hedrich-Blessing

Master bedroom, on second floor, has built-in over-sized bed and built-in headboard. Walls are cypress, ceiling is plaster with radiant heating coils

THREE JAPANESE CHURCHES

Antonin Raymond & L. L. Rado, Architects

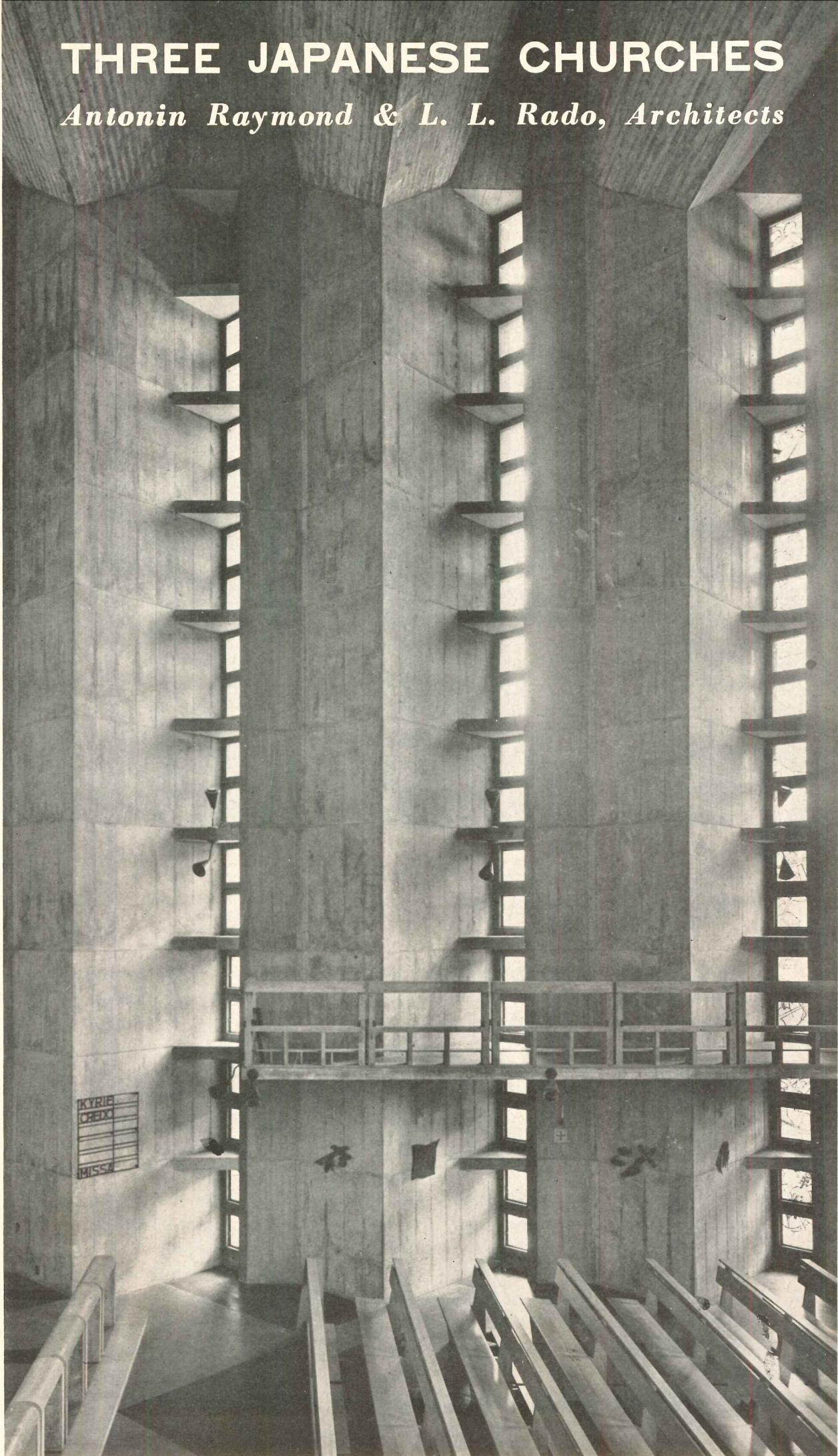

*St. Anselm's Priory
for the
Benedictine Fathers
in Japan*



THREE JAPANESE CHURCHES

ST. ALBAN'S EPISCOPAL CHURCH, TOKYO;
Antonin Raymond & L. L. Rado, Architects.
Located on an open hillside plot of about one-half acre, this church is notable both for interesting structure and for fine handling of natural wood. The double scissors trusses framing the nave, side-aisles and clerestory are made of split cedar poles (half rounds) while the upper wall panels, altar, and altar cross are of contrasting oak. Pews of Philippine mahogany add the richness of a third wood.

The carpentry and furniture were executed in traditional Japanese fashion and with typical Nipponese skill. The fresh-cut, natural look of the surfaces stems from the custom that bars the use of sandpaper on the ground

that its action roughens and "fuzzes" surfaces; softens arrises. Only the saw, plane and chisel are employed, and the finished wood is left completely innocent of stain, filler, lacquer, or varnish.

The handsome trusses and double columns thus become a three-dimensional decorative element. The soft smoothness of the three woods plays effectively against the wire-cut roughness of the orange-red brick in the lower walls and also against the sheen of the polished black asphalt tile floor. Clerestory light is pleasantly softened by white shoji paper patterns pasted upon the glass. Two layers yield two values. They were designed by the architect's wife, Noemi P. Raymond.

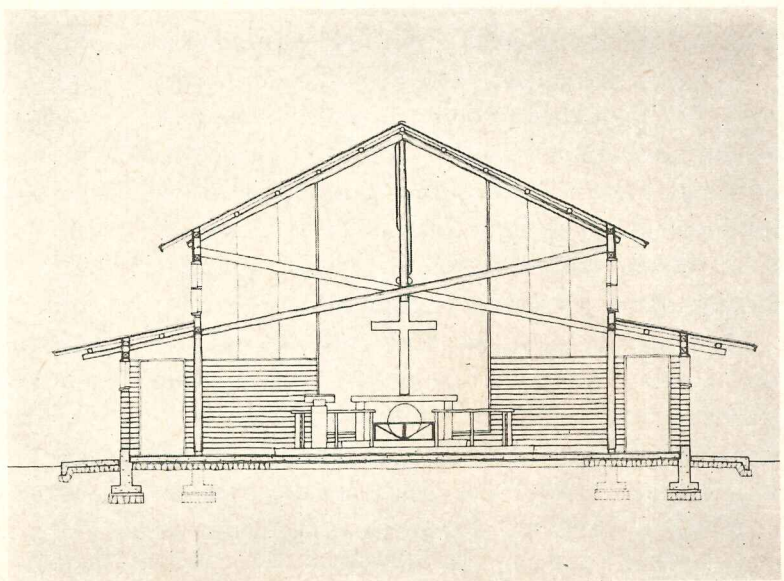
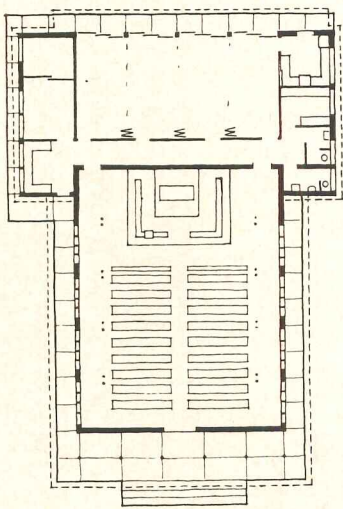
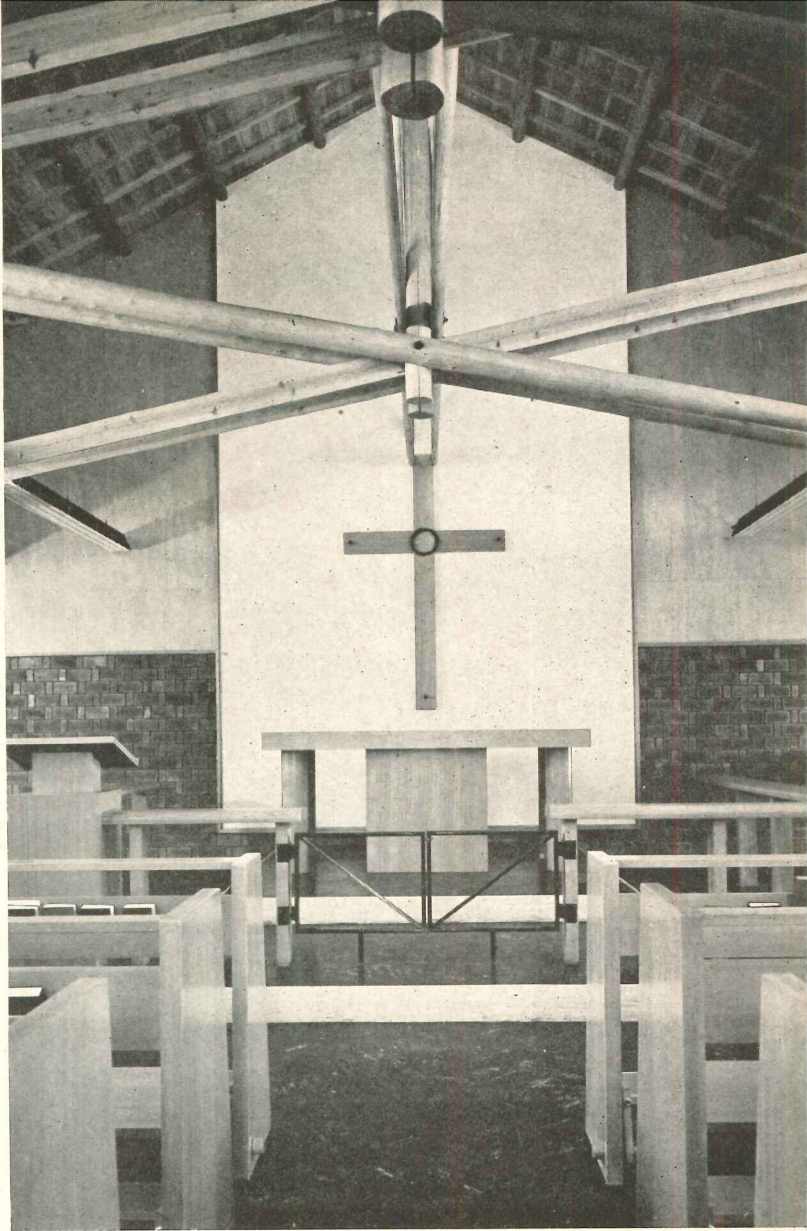
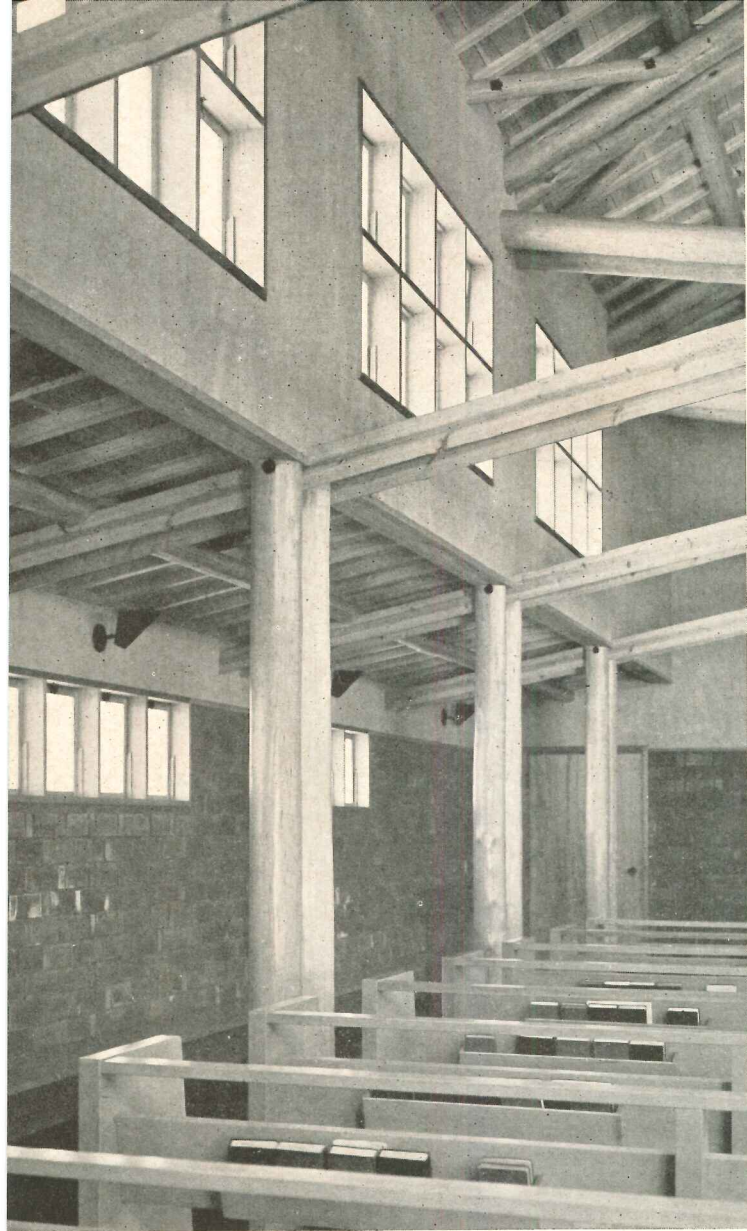



THREE JAPANESE CHURCHES

ST. PATRICK'S CHURCH FOR THE COLOMBIAN FATHERS, TOKYO; *Antonin Raymond & L. L. Rado, Architects.* Distinguished concrete work, both rough and smooth textured as well as large and small in scale, lend interest to this building. Also of note is the manner in which multi-colored daylight plays on various interior forms and surfaces to create a softly glowing, three dimensional tapestry.

The concrete structure and walls are natural colored and purposely rough in texture, due to forms made of bevelled boarding. In contrast, the delicacy and precise smoothness of the concrete baldachino (right page) exhibit, in striking fashion, Japanese virtuosity in forming and finishing this material.

For the firm's Japanese work, architect Raymond and his wife Noemi usually work as a team, with Mrs. Raymond determining color arrangements, making sculpture, designing stained glass, mosaics, fabrics, etc.

The floor is concrete, stained orange-red; the pews Philippine mahogany. Clerestory glass panels are in shades of amber, purple, blue, and red while those at the front of the church are in golds and greens. A fresco will someday decorate the altar panel.

The baptistry (upper right) is top-lighted by amber glass. The architect designed the wrought iron screen, mosaic floor, and font. The font is concrete with stone lining; its cover is highly polished black iron.

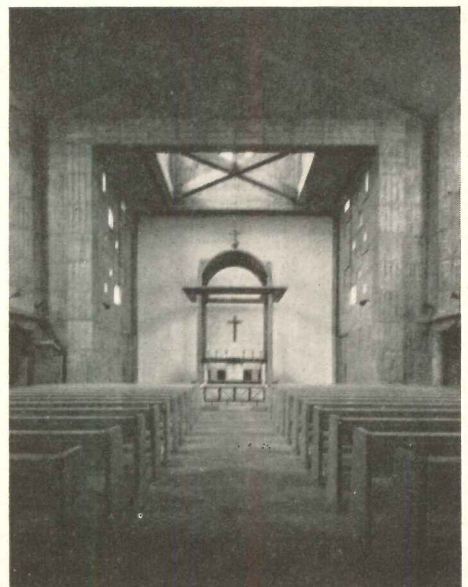
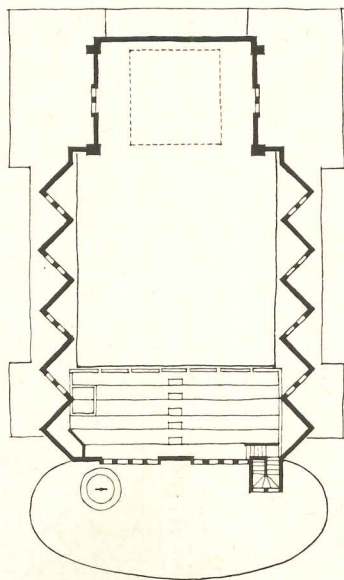
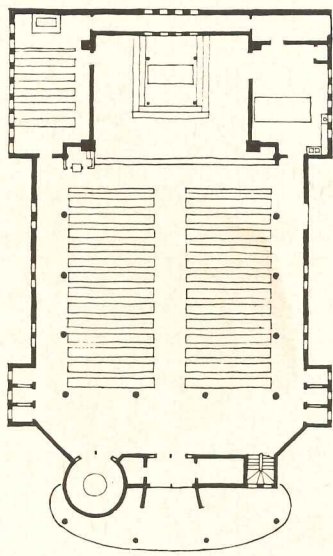
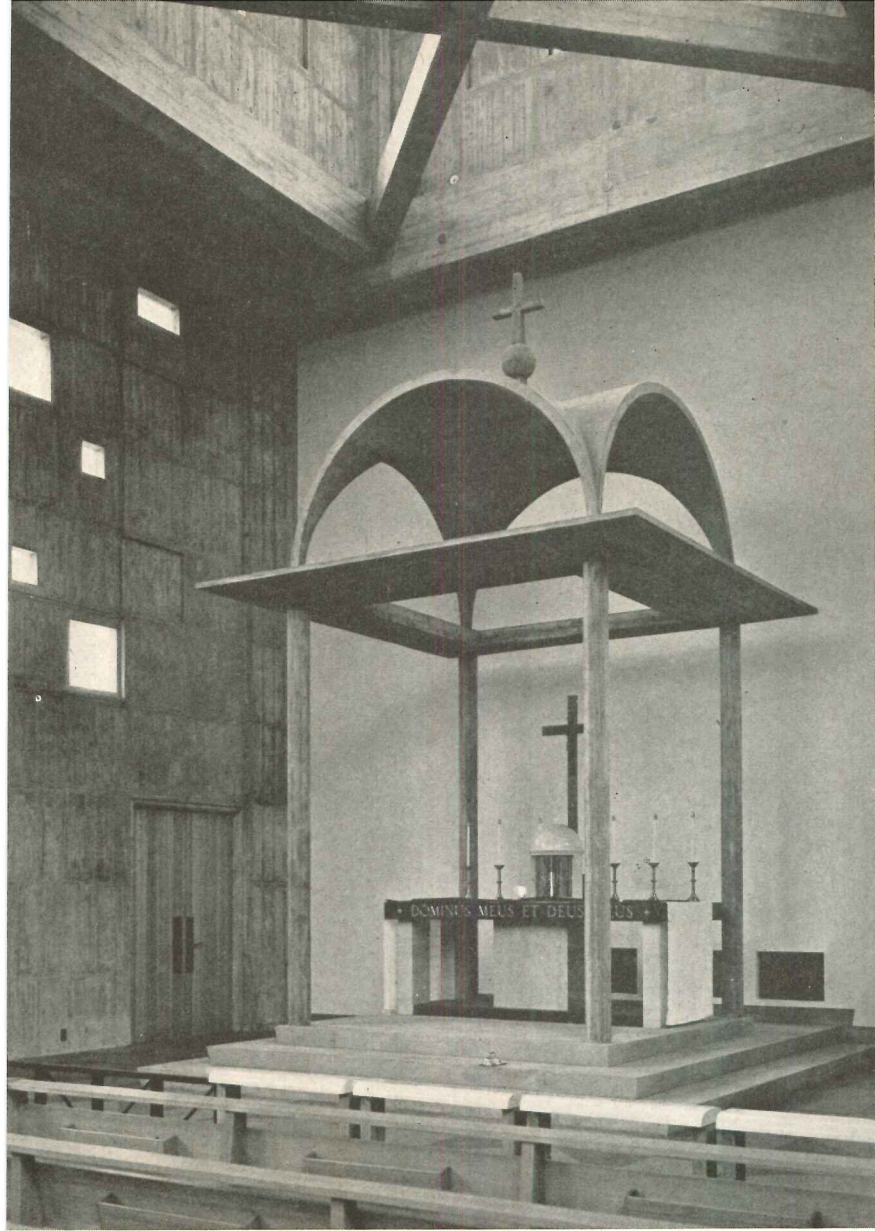



THREE JAPANESE CHURCHES

ST. ANSELM'S PRIORY FOR THE BENEDICTINE FATHERS, TOKYO; Antonin Raymond & L. L. Rado, Architects. Given an unfavorable site, but one on elevated ground, the problem was to design a church for 500, a kindergarten, library, assembly hall and priest's dwelling. The church is flanked on one side by the L-shaped school and assembly facing a play court; on the other by the space set aside for a future cloister and rectory. Covered walks link the elements; serve as corridors.

In the church building proper, there is interest in structure, richness of color, and the extent to which the Raymonds — Antonin and Noemi — participated in the design and execution of all the furnishings.

The side walls and roof are of reinforced concrete in a "folded sheet" form; are laterally braced by the "shelves" between windows in the vertical light strips (pp. 187 & 194). Metal forms were used (for the first time in Japan) and as a result the desired smoothness of surface was achieved. The large nave is in the classic proportion of 50 by 50 by 100 ft. This space creates, for the average parishioner, an effect of serenity and grandeur — a feeling undoubtedly heightened by the manner in which interior color is used.

Portions of the exposed concrete, both exterior and interior, have been dye-stained with transparent washes of color. Since the substance of the concrete remains visible, the

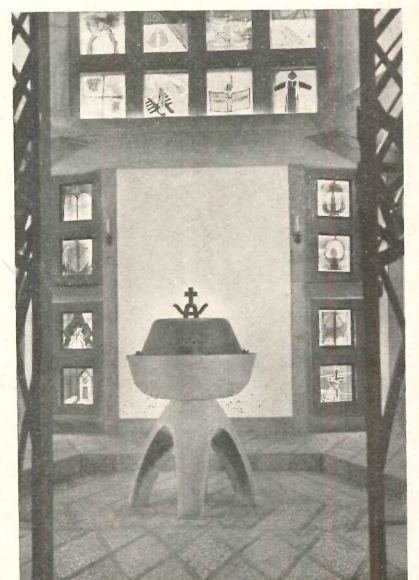
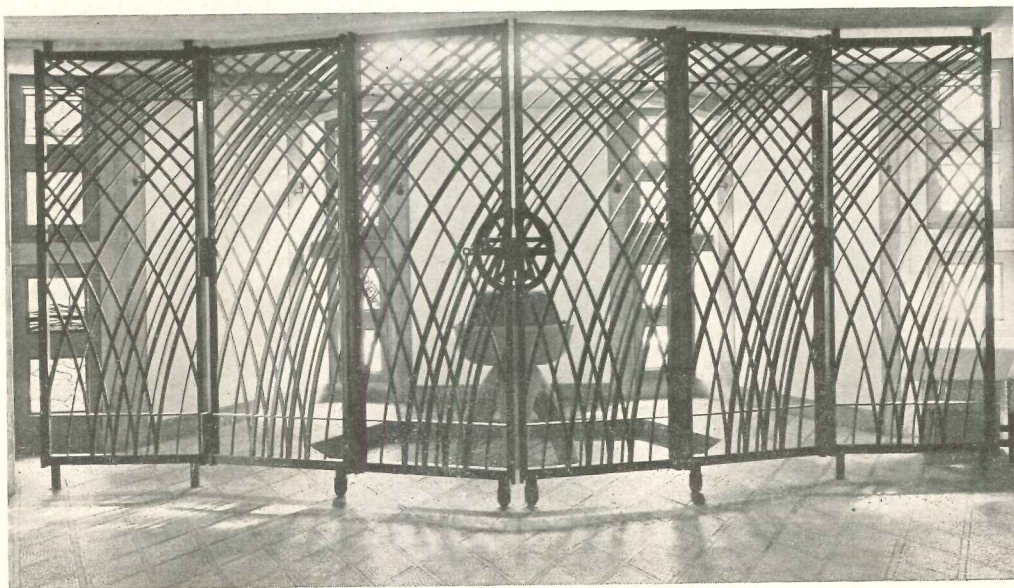
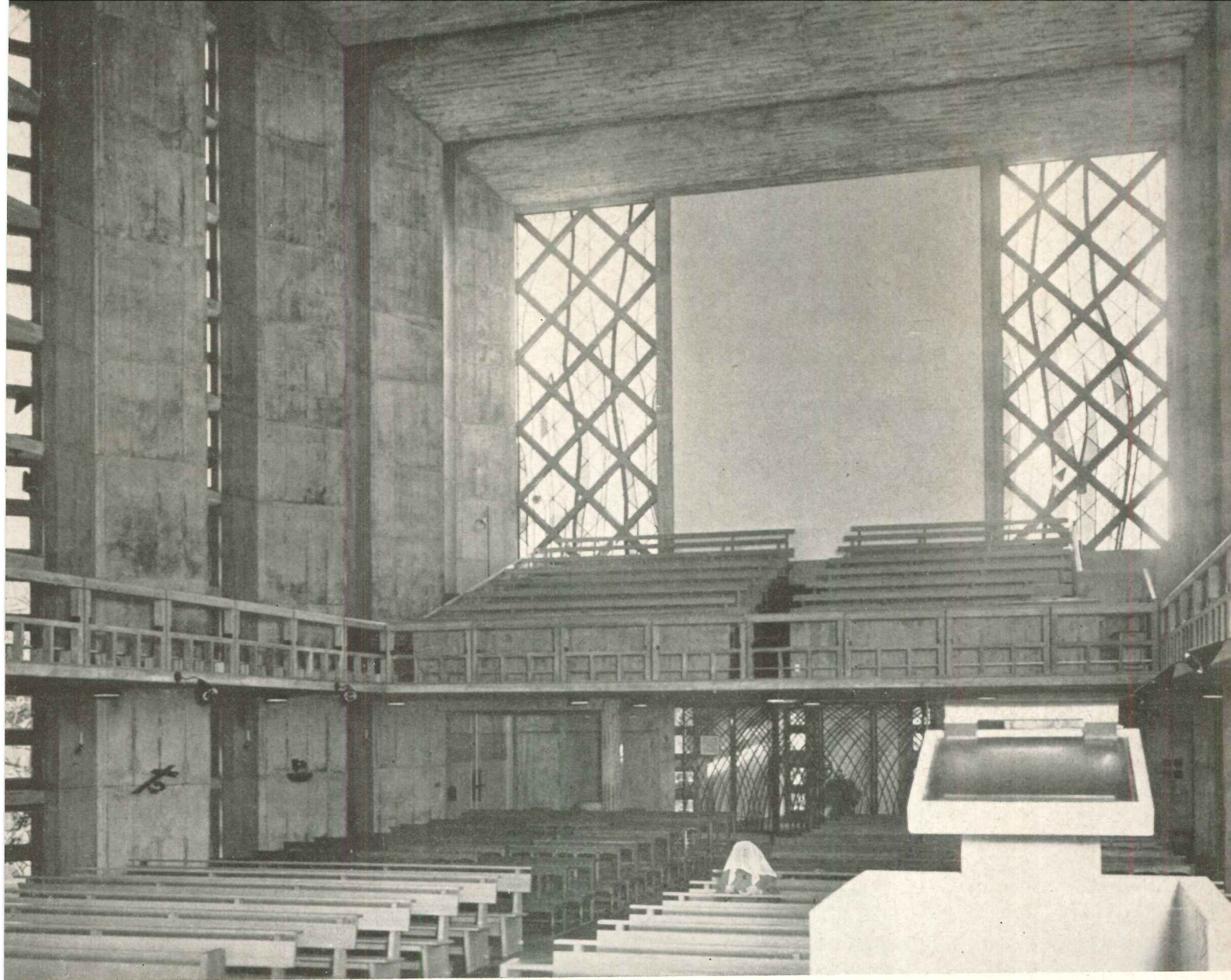

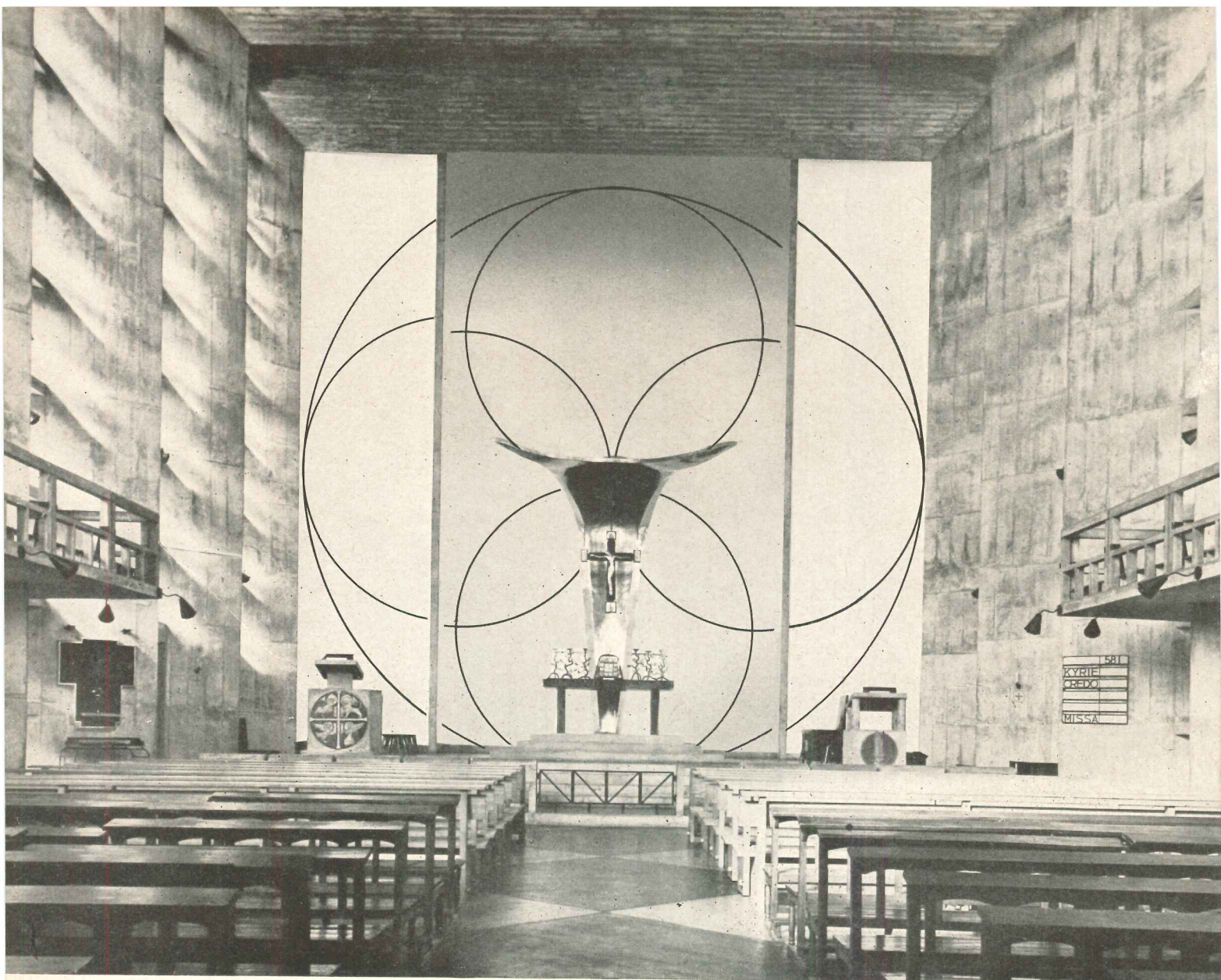

THREE JAPANESE CHURCHES: ST. ANSELM'S

effect is impressive. Earthy colors were used; Indian red, Siena, ochre, gray-green, charcoal gray — and light blue for parts of the ceiling. The large squares in the floor are red and black; the pews and railings are natural Philippine mahogany. The mosaic floor in the baptistry is executed in soft blues and grays.

There is gold lettering on the black stone altar; the flaring baldachino is concrete covered with gold leaf. These were designed by architect Raymond, who modeled the black iron candlesticks; designed and painted the altartabernacle decoration (top right). This decorative panel is in Cloisonnée; consists of areas of baked enamel within raised silver outlines placed upon the black iron supporting frame.

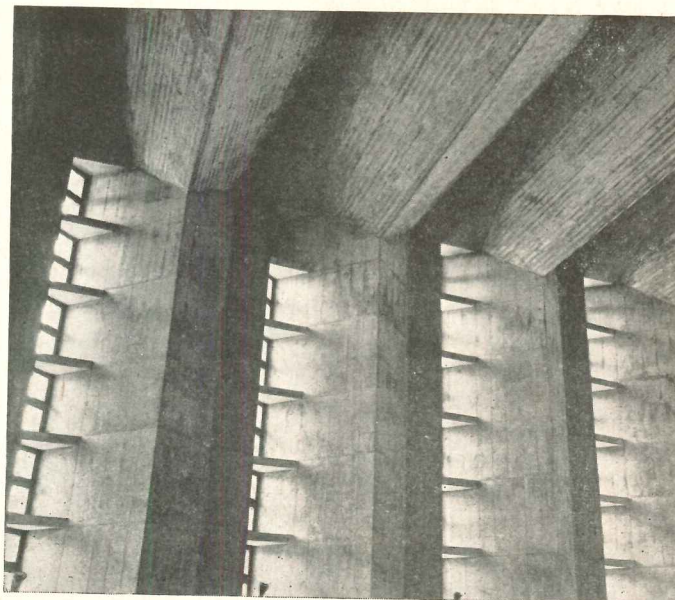

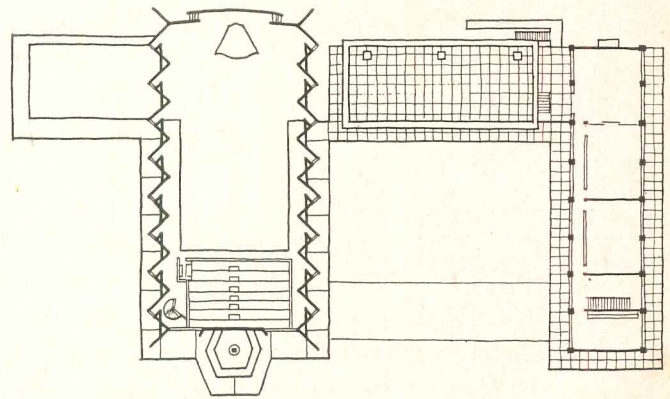
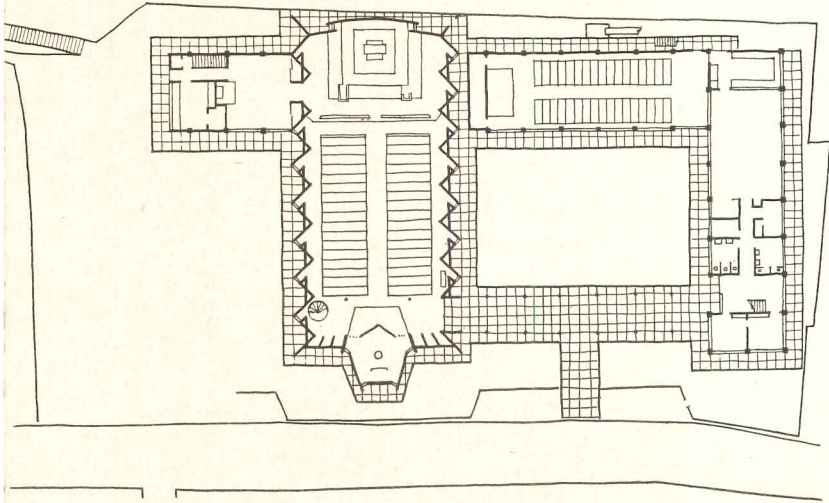
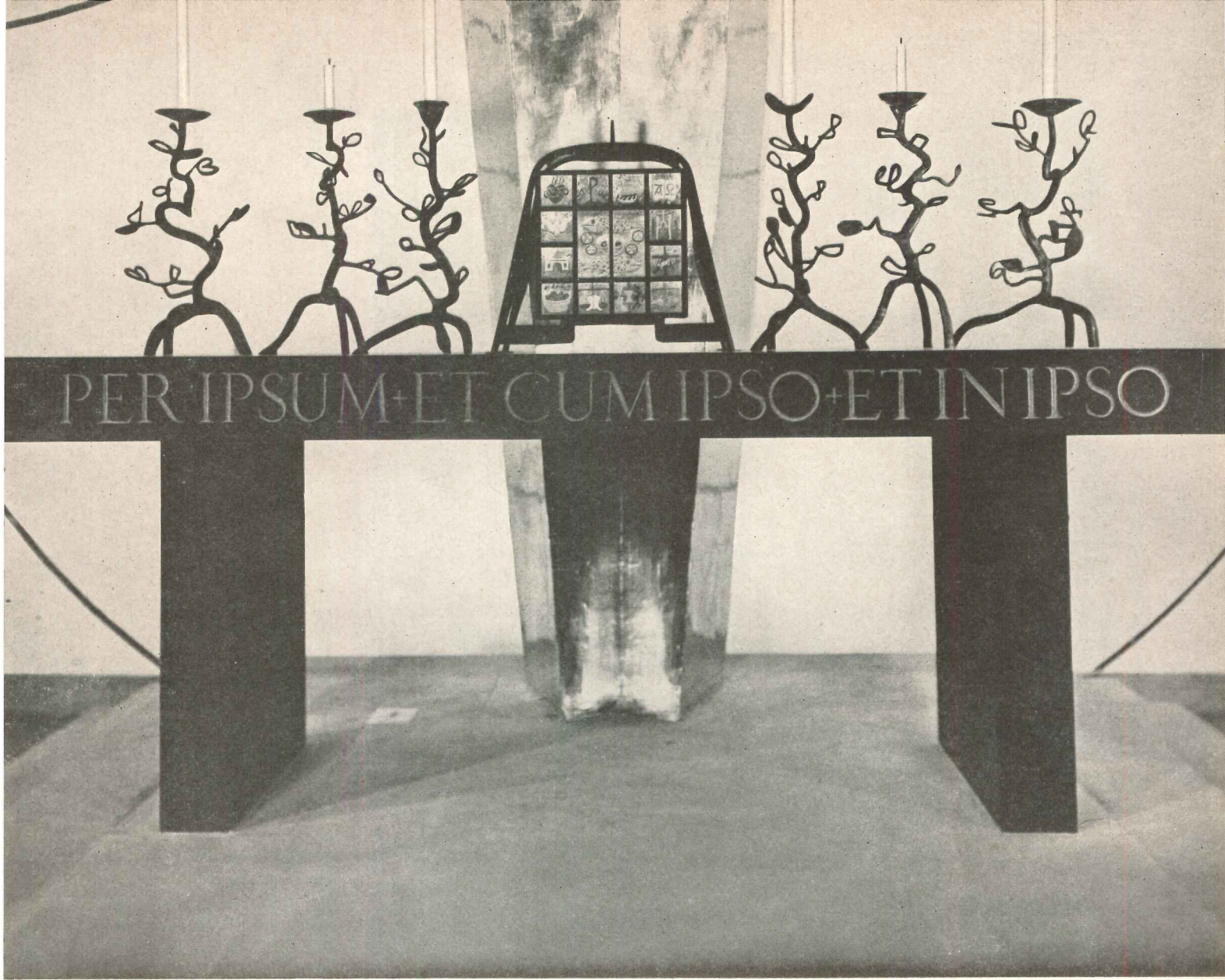

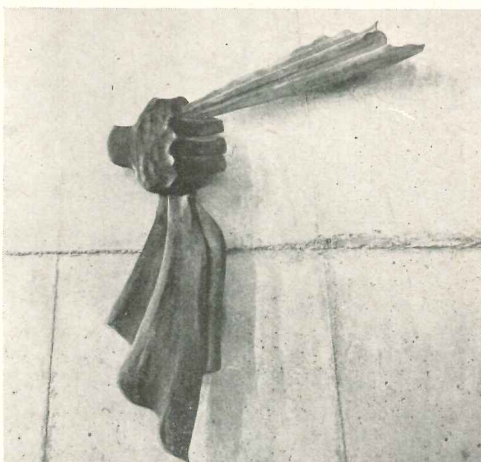
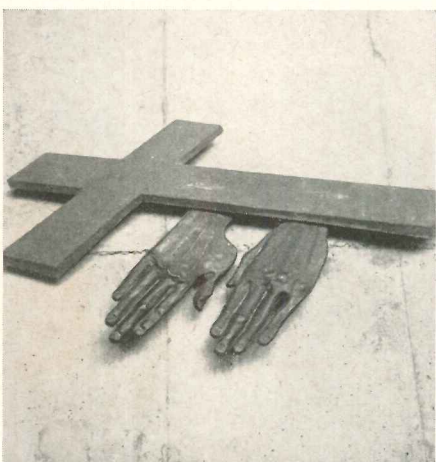
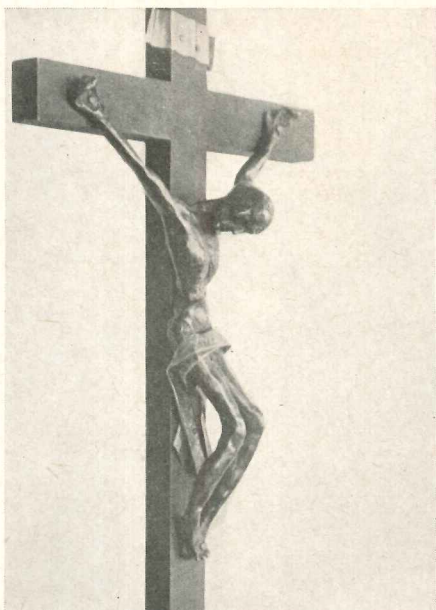

THREE JAPANESE CHURCHES: ST. ANSELM'S

The four top photos show examples of sculpture. The crucifix was modeled by Antonin Raymond and the holy water font — of concrete with a stone lining — was designed by him.

For the stations of the cross, by Noemi Raymond, in all twelve the hands are of black iron while the other elements of the designs are of rusted iron

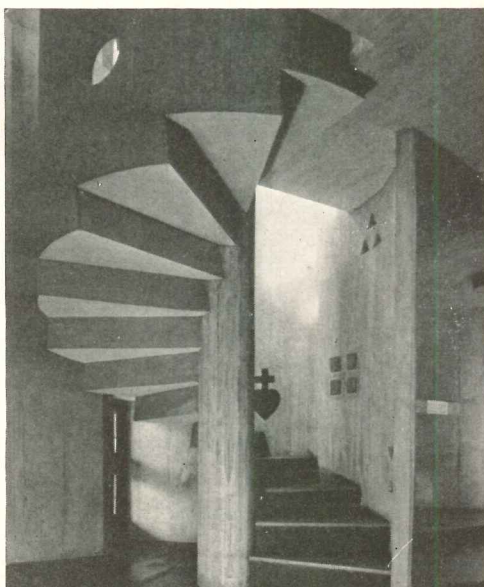
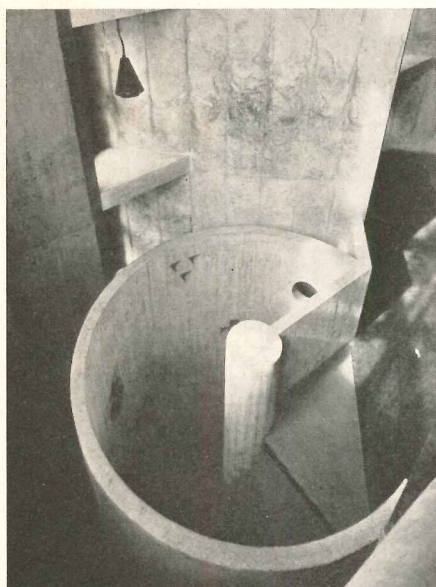

The two bottom pictures show the spiral concrete stairway leading to the balcony choir loft at the rear of the church

6: PUBLIC ASSEMBLY

THE STRUCTURAL SPECTACULARS of our time are the Stock Pavilion at Raleigh and the Kresge Auditorium on the campus of Massachusetts Institute of Technology.

Both of these new buildings have been widely documented and widely appreciated. In all likelihood this is because they have appealed directly to a generation of architects caught up in the search for the sensuous satisfactions of sculptural shape and the intellectual gratifications inherent in the expressive use of materials and techniques peculiar to our day.

In the case of each building, the simple curvilinear profiles have strongly attracted on first viewing and have stamped their simple images in the visual memory. If in detail they are not as satisfying as they are in the large, this must surely proceed from the circumstance that here an unfamiliar language is being spoken. And this must be said too for the structural systems which, though they may not be flawless, are nevertheless so vigorous in concept that their execution has stimulated and encouraged a host of essays in cable and thin shell constructions.

In all time it has been the essentially one-story, one-space building which has afforded the architect the fullest opportunity to work with shape and structural method.

Given in these instances just such relatively simple building programs both Eero Saarinen and Matthew Nowicki with William Deitrick and with, of course, their structural engineers, were able to carry through for clients of imagination buildings which are continuing to urge still other clients and architects to take the bold road which alone can lead toward fuller satisfactions for the spirit.

In buildings of the public assembly category only the elder Saarinen's Kleinhans Music Hall in Buffalo approached these two buildings in the balancing by ARCHITECTURAL RECORD's panel of architects and scholars for the most significant buildings of the past one hundred years in America.

WINWRIGHT BUILDING, St. Louis
Louis Sullivan

PERSON PIRIE SCOTT STORE, Chicago
Louis Sullivan

ROCKEFELLER CENTER BUILDINGS, New York
Reinhard & Hofmeister; Corbett, Harrison
& MacMurray; Hood & Foulthou

ROVER HOUSE, New York
Skidmore, Owings & Merrill

TRINITY CHURCH, Boston
H. H. Richardson

PHILADELPHIA SAVINGS FUND SOCIETY
BUILDING, Philadelphia
Howe & Lescaze

GENERAL MOTORS TECHNICAL CENTER, Detroit
Saarinen & Saarinen

LAKE SHORE DRIVE APARTMENTS, Chicago
Mies van der Rohe

C. JOHNSON & SON, INC., ADMIN. BLDG., Racine
Frank Lloyd Wright

MONADNOCK BLOCK, Chicago
Burnham & Root

DAILY NEWS BUILDING, New York
Hood & Howells

VA NORRIS DAM & POWER HOUSE, Tennessee
Roland Wank, Architect-in-charge

BOSTON PUBLIC LIBRARY, Boston
McKim, Mead & White

STOCK PAVILION, Raleigh
Nowicki & Deitrick

CHRISTIAN SCIENCE CHURCH, Berkeley
Bernard Maybeck

COOLWORTH BUILDING, New York
Cass Gilbert

ROW ISLAND SCHOOL, Illinois
Saarinen & Saarinen,
with Perkins, Wheeler & Will

MANUFACTURERS TRUST BUILDING, New York
Skidmore, Owings & Merrill

TRINITY CHURCH, Oak Park
Frank Lloyd Wright

NEBRASKA STATE CAPITOL, Lincoln
Bertram G. Goodhue

C. JOHNSON & SON, INC., LABORATORY, Racine
Frank Lloyd Wright

UNITED NATIONS SECRETARIAT, New York
Wallace K. Harrison & Consultants

LINCOLN MEMORIAL, Washington
Henry Bacon

M.I.T. AUDITORIUM, Cambridge
Eero Saarinen

EQUITABLE BUILDING, Portland
Pietro Belluschi

ALLEGHENY COUNTY BUILDINGS, Pittsburgh
H. H. Richardson

UNIVERSITY CLUB, New York
McKim, Mead & White

CRANBROOK SCHOOLS, Michigan
Eliel Saarinen

MINERALS & METALS RESEARCH BLDG., I.I.T., Chicago
Mies van der Rohe

ALCOA BUILDING, Pittsburgh
Harrison & Abramovitz

MUSEUM OF MODERN ART, New York
Goodwin & Stone

PENNSYLVANIA STATION, New York
McKim, Mead & White

EXPERIMENTAL SCHOOL, Los Angeles
Richard Neutra

DODGE TRUCK PLANT, Detroit
Albert Kahn

100 MEMORIAL DRIVE APARTMENTS, Cambridge
Kennedy, Koch, DeMars, Rapson & Brown

CENTRAL LUTHERAN CHURCH, Portland
Pietro Belluschi

HOUSES

C. ROBBIE, Chicago
Frank Lloyd Wright

J. KAUFMANN, Pennsylvania
Frank Lloyd Wright

VALIESIN WEST, Arizona
Frank Lloyd Wright

HENRY VILLARD, New York
McKim, Mead & White

WATTS SHERMAN, Newport
H. H. Richardson

EVERY COONLEY, Illinois
Frank Lloyd Wright

V. W. WILLITTS, Illinois
Frank Lloyd Wright

R. R. GAMBLE, Pasadena
Greene and Greene

PHILIP JOHNSON, New Canaan
Philip Johnson

WALKER GUEST HOUSE, Florida
Paul Rudolph

MILLEN SCRIPPS, La Jolla
Irving Gill

WESTON HAVENS, Berkeley
Harwell Hamilton Harris

OVELL "HEALTH HOUSE", Los Angeles
Richard Neutra

EDITH FARNSWORTH, Chicago
Mies van der Rohe

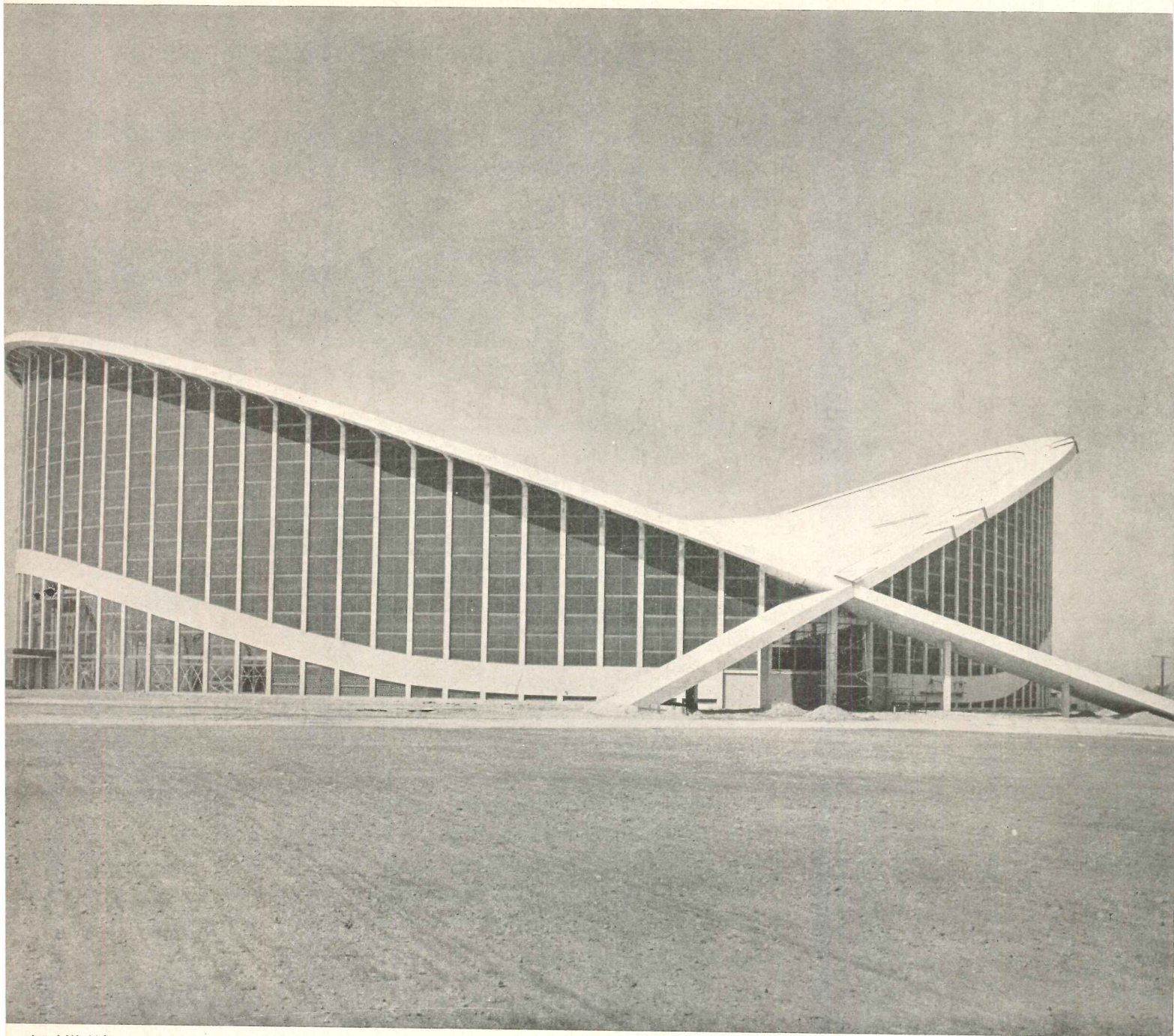

Joseph W. Mallor

*Stock Pavilion (State Fair Arena), Raleigh, 1952-53
Matthew Nowicki and William Deitrick. (Tied for tenth)*



Joseph W. Molitor

*Kresge Auditorium, Massachusetts Institute of Technology, Cambridge, 1955
Eero Saarinen and Associates. (Tied for fifteenth)*

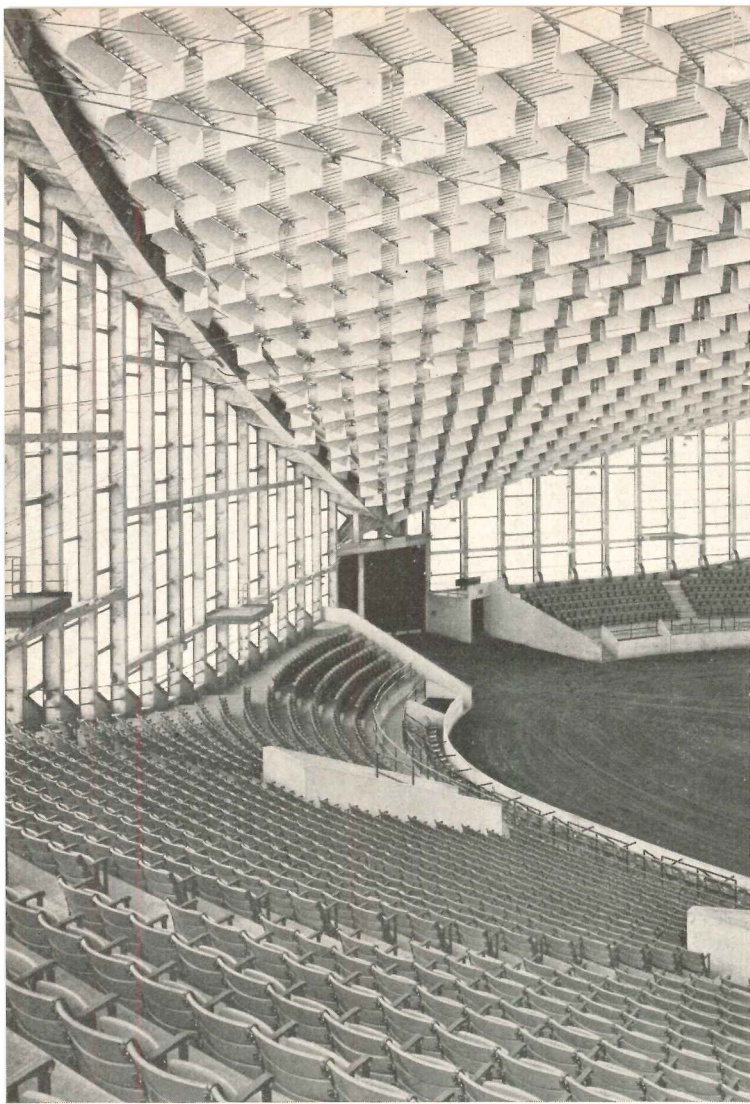

Joseph W. Mollitor

Stock Pavilion (State Fair Arena), Raleigh, 1952-53, Matthew Nowicki and William Deitrick. (Tied for tenth)

"The oppressive uniformity of their structural resources (and their themes) has prompted architects to look for avenues of expression in the more varied and dramatic inventions of engineers. They have been successful recently in giving these an architectural eloquence.

"The great concrete arches that form the essential structure of the Stock Pavilion at Raleigh are like athletes who grasp each other by their hands as they lean outward over the circus-like arena. Like acrobats they exhibit their naked strength, daring, tense and sensational.

"They are charged also with a promise for American architecture."

Joseph Hudnut

Joseph W. Mollitor

Kresge Auditorium, Massachusetts Institute of Technology, Cambridge, 1955, Eero Saarinen and Associates. (Tied for fifteenth)

"The Kresge Auditorium at M. I. T. is a magnificent example of a big architectural idea imposed on a highly complex problem with sufficient skill and reasonableness to make it successful. The interior form of the large auditorium expresses clearly, convincingly, and somewhat surprisingly its relationship to the exterior form of the great structural shell, and this major interior-exterior relationship is strong enough to make the design convincing, despite one's awareness that considerable ingenuity has been exercised in enclosing and concealing some of the less sightly elements. The auditorium is impressive in itself, fine in its carefully studied relationships to its surroundings, and interesting in its overtones of such things as the other big M. I. T. dome, and even (in the articulated stairs) to the nearby Aalto dormitory."

Eliot Noyes

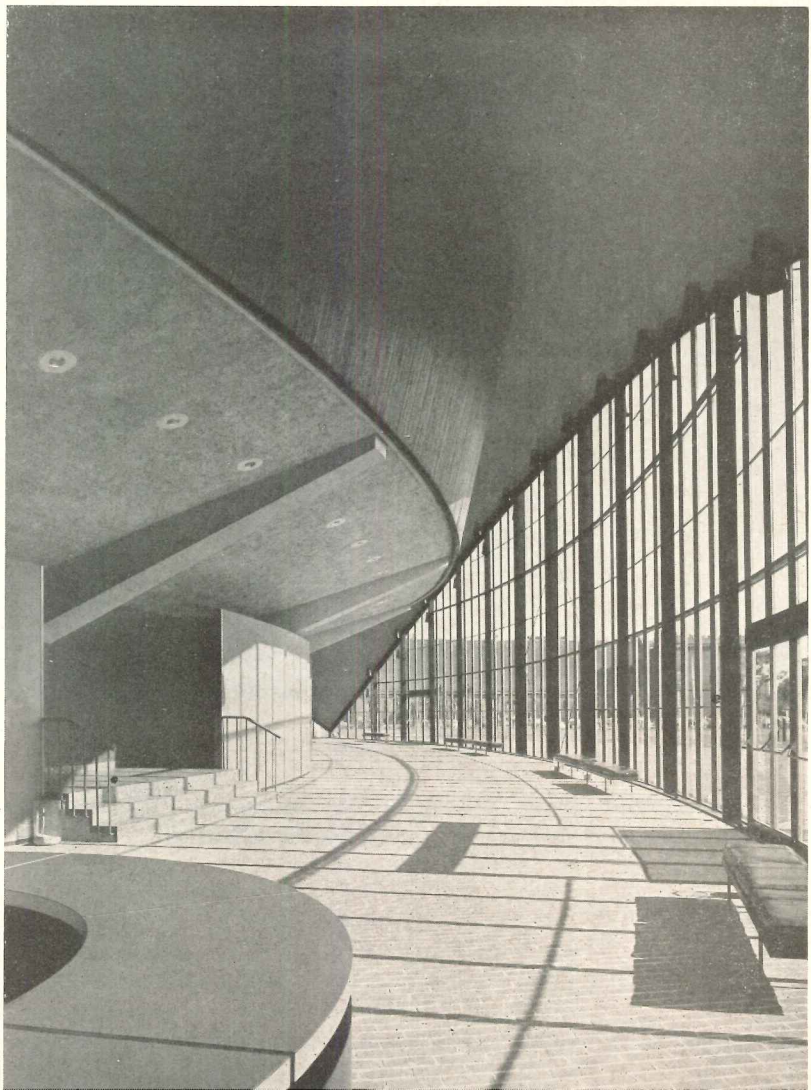

ENVIRONMENT FOR MENTAL THERAPY

By JOHN W. CRONIN, M.D., F.A.P.A., and WILBER R. TAYLOR, Architect *

THE ARCHITECT seeking guidance in mental hospital planning finds himself in a field in which there is limited definitive information. Ten years ago this was more or less true of general hospitals but the postwar building program has provided the experience from which a substantial body of detailed information has been made available. In the mental health field due to many reasons we do not have, comparatively, similar information in scope or in detail.

Too many of the existing mental hospitals are quite inadequate for modern techniques of mental care. Many of them are badly located, crowded, and, to a large extent, have been unable to offer much more than custodial care. Part of the explanation of this lies in the ever increasing number of mental patients and in the rising costs of mental care. Lack of trained personnel and frequently public apathy have also contributed to this unfortunate situation.

A startling one-third of the budget of every state government in the nation goes for the care of the mentally ill each year, yet even this sum has not been adequate to cope with the evergrowing problem. As a result, pared building budgets, understaffing, overcrowding, and inadequate maintenance combine to produce an environment which, by and large, is inadequate for the treatment of the mentally ill. The need for improvement has long been recognized, but now, through the use of the "tranquilizing drugs," and better treatment methods, a drastic change is not only necessary but also possible.

Medical authorities have predicted that the next great breakthrough on the medical front will be in the field of mental illness. The breakthrough may already have begun with the development and use of the tranquilizing drugs, and with the application of newer knowledge in the care of the mentally ill. If the prediction proves true, a considerable change in mental hospital environment will be required.

Completely adequate statistical information of the effect the new drugs will have on the total mental hospital population has not yet been compiled and analyzed. But it begins to appear that as a large number of patients become more quiescent and more accessible for treatment, fewer detention rooms will be required. More recreational and occupational therapy area will be necessary. Vocational rehabilitation will become a still more important factor in the treatment of many patients. With more patients attaining outpatient

status, greater emphasis will be placed on day-care facilities and outpatient treatment areas. The mentally ill patients are for the most part ambulatory patients.

For those who are not helped by the newer drugs, some hydrotherapy facilities may be retained although these can be drastically reduced. Specific areas for insulin and electro-shock therapy may be abandoned entirely, the treatment to be given in bedrooms as required in accordance with prescribed programs of treatment specifically for the individual patient.

The value of a pleasant environment as a contributing factor to improved patient behavior and response to treatment is well established. The effect on the staff in terms of increased efficiency and better morale also cannot be overemphasized. It falls to the lot of the architect to create an environment in which the psychiatric team is given every advantage in the treatment of the patient in order to effect better patient care.

To carry out this responsibility, the architect must have every assistance. A program, based on the medical services to be offered, is paramount. But the program must include medically acceptable specifications and criteria because it is in this area that the architect first finds his difficulties in designing the facility. The American Psychiatric Association's "Standards for Hospitals and Clinics" makes reference to physical requirements, but much more is needed. The American Psychiatric Association is currently engaged in a research project which may provide data on which criteria can be based and made available to architects.

The field of mental hospital planning is a rewarding one in which the architect can make a contribution to the well-being of his fellow man unequalled in any other area of architecture. There exists a tremendous need for adequate mental health facilities. Most of our mental hospitals will require extensive modification to meet the new treatment demands. Day care facilities, diagnostic and treatment centers for outpatient and short-term therapy, and psychiatric units in general hospitals, are urgently needed. Bringing new concepts into the designs for these facilities will provide a challenge for the architect in the next decade. A cooperative endeavor of the psychiatric team members and the architects will result in a better mental health facility planning and better patient care — the ultimate goal.

* John W. Cronin, M.D., is Chief, Division of Hospital and Medical Facilities, Public Health Service, Department of Health, Education and Welfare; and Wilbur R. Taylor is an architect (mental health facilities) in the Division.

NEW HORIZONS IN PSYCHIATRY

By LUCY D. OZARIN, M.D.

Medical Director, Architectural Study Project, American Psychiatric Association

THE PRESENT TIME seems particularly appropriate for the study of architectural requirements for psychiatric patients. Within the past decade, several major advances in treatment have emerged and have been incorporated into psychiatric practice. One is the introduction of new drugs for the treatment of mental disorders. Another is the recognition of the effect of the social environment of the hospital upon patients and its usefulness as a definite treatment measure.

These developments have already given evidence that the treatment of psychiatric patients is entering a new era. There is evidence, too, that these treatment methods are leading to a need for different types of physical facilities than have been traditional in the past.

For the architect who is designing new psychiatric hospital facilities, the philosophy, methods of action and known effects of the new treatments furnish the basis for developing new architectural patterns.

The New Drugs

In 1953 reserpine, the first of the new drugs, was used to treat psychiatric patients in a New York State Hospital. About the same time, chlorpromazine, a second drug with a similar quieting effect on mental functioning, was introduced into this country from France. Reserpine and chlorpromazine have been the major tranquilizing drugs which have been used in psychiatry during the past three years. A series of related drugs have also come into clinical use and have been found effective for various psychiatric illnesses and symptoms. It is likely that additional and perhaps more effective drugs will be found and used in the future.

Writing of the effects of drug therapy, Dr. B. Pollock¹ of the Rochester (New York) State Hospital reported:

From June 1954 to August 1955, 900 patients were treated with these drugs at his hospital, of whom 66 per cent improved significantly. He listed the following as results of drug treatment:

1. The use of electric shock therapy decreased by 60 to 90 per cent.
2. Insulin shock therapy and psychosurgery are rarely used.
3. More patients participate in activities. In 1954, only 15 of 54 patients on a disturbed ward were able to attend a picnic. In 1955, 49 of 51 patients on the same ward went to a picnic.
4. The need for seclusion and restraint were reduced markedly. There were 87 patients at the hospital who had been in almost constant seclusion or restraint for 5 to 20 years. After drug treatment, 43 were out of restraint completely, and 11 more required no restraint much of the time. Most restraint in use at the hospital now is for physically ill psychotic patients who are restrained for such reasons as to prevent them from tearing off bandages, or because they will not remain in bed when their illness so requires.
5. Patients must be given medical and laboratory examinations more frequently in order to adjust drug dosage and watch for untoward physical reactions to the drug.
6. More patients require and can use psychotherapy.

7. Patients do not need to be transferred from ward to ward. If they are on a quiet ward and become disturbed, they can be treated rapidly with drugs. Before drugs were available, such patients would be transferred to a disturbed ward.

8. The wards can be furnished more comfortably and tastefully.

9. The attitudes of patients and staff have changed. Drug treatment seems a more normal way of treating sick people than shock treatment or hydrotherapy.

10. The outpatient department is much more active and important now, since many patients who leave the hospital are maintained on drugs and supervised by the medical staff during the period of trial visit.

11. Hospital staffs are much more interested in their jobs, and are motivated to do a better job. The staff education program has been intensified.

12. The community is more interested in the hospital and in the patients. Relatives visit more often as the patient's behavior becomes normal. Private physicians are more willing to refer patients for admission. The work of volunteer groups in the hospital increases.

There are indications that the use of the drugs may result in a decreased number of psychiatric patients in hospitals. A news note states,

"Commissioner Paul Hoch of the New York State Department of Mental Hygiene reports that for the first time since World War II the population of mental hospitals of the State has shown a decrease. Each year during the preceding 10 years has shown an average increase of 2,000 patients. The resident population on March 31, 1956, (92,916) was 500 less than a year ago. This decrease is attributed mainly to intensified treatment and wide use of the tranquilizing drugs. The present building program will have to continue, however, as the state institutions are still 30 per cent overcrowded and obsolescent buildings must be replaced."²

Thousands of patients in hospitals and clinics, and those under the care of private physicians have been treated with the new drugs. While three years is a relatively brief time to fully evaluate a new therapy, the evidence is impressive that the new drug therapies are affecting many aspects of psychiatric treatment.

Social Treatment

Social treatment is a term used by Greenblatt, York and Brown in their recent book "From Custodial to Therapeutic Care in Mental Hospitals"³ to describe an organized and systematic utilization of the hospital environment as a treatment measure.

That hospital environment affects patients markedly has been recognized since the days of moral treatment 150 years ago. Moral treatment, as it was called, flourished from 1800 to about 1860 in the small mental hospitals of 100 to 300 beds that then existed. Moral treatment was an effort to create a favorable environment in which recovery could take place. It was a group experience in which patients could share and learn.

Charles Dickens when he visited the United States 120 years ago described the mental institution that is now the Boston State Hospital and its emphasis on

kindness, sociability, and satisfying group experiences for the patients.⁴ He wrote,

"Every patient in this asylum sits down to dinner every day with a knife and fork; and in the midst of them sits the gentleman (the superintendent). . . . At every meal moral influence alone restrains the more violent of them . . . and is found even as a means of restraint, to say nothing of it as a means of cure, a hundred times more efficacious than all the strait waistcoats, fetters, and handcuffs, that ignorance, prejudice, and cruelty have manufactured since the creation of the world."

Moral treatment of the mentally ill was considered highly successful. Recovery rates of 80 to 90 per cent were reported. But after 1850 the size of the hospitals began to increase. The pressure for admission plus the emphasis on economy by state legislatures led to the construction of increasingly larger institutions. (Today there is one New York state hospital with more than 14,000 patients.) Greenblatt, York and Brown also believe that the influx of immigrants after 1850 led to changing attitudes on the part of hospital staffs since the immigrants had different cultures and strange ways that did not foster the close intermingling of staff and patients that had existed during the days of moral treatment. The intimate contact of patients and staffs that had marked moral treatment, ceased to exist.

Studies of Social Treatment

The era of custodial care in mental hospitals from about 1880 to 1945 was the dark age in hospital psychiatry, from which we are just emerging. There is now the opportunity to plan the psychiatric hospitals and nursing units of the future. A number of hospital workers assisted by social scientists are studying the effects of social environment on psychiatric patients. Their studies are pointing the way.

The studies of Stanton and Schwartz have helped to clarify the importance of environment, particularly as a background for group experiences. Present psychiatric theory holds that many mental disorders may be due to inadequate patterns of reacting to stressful situations. Treatment must therefore include opportunities for the patient to learn more suitable ways of meeting and handling stress. Since psychological stress is usually in relation to other people, the patient learns new patterns of thinking and behavior through his interpersonal experiences with the hospital staff and with other patients.

The fostering of therapeutic interpersonal relations is a prime function of the mental hospital and psychiatric ward. The hospital must therefore be so arranged and must be provided with the kinds of areas, facilities and environment that promote group experiences

among its inhabitants. To quote Stanton and Schwartz further⁵

". . . our most personal and important experiences, our independence and creativity, are intimately related to our types of experience with others. . . . Since very personal experiences of high value, then, are somehow related to the type of institutional setting rather than to the fact of being in an institution, the question before us is to inquire into the best type of institution and try to approximate it."

Another major research project was carried out in Boston under the Russell Sage Foundation which led to the publication of the book "From Custodial to Therapeutic Care in Mental Hospitals" mentioned earlier.⁶

The Russell Sage project undertook to study public mental hospitals to determine how their environment could be used to help patients recover. The need for security of psychiatric patients was first evaluated. It was found that by increasing and diversifying the daily activities program for patients and by educating and reorientating the staff, the needs for mechanical and chemical restraints, seclusion, wet packs, continuous tubs and other security devices were markedly lessened if not abolished. Once the security needs of patients were realistically evaluated and subsequently decreased it was then possible to improve the physical environment of the hospital. It was demonstrated that mental hospitals could have bright pleasant wards furnished comfortably and tastefully decorated and that patients, if given a decent place to live, carefully maintained their surroundings.

Greenblatt, York and Brown write,⁷

"Once more it is becoming accepted that psychotic patients need a setting that is cheerful, comfortable, friendly, and resembles closely the normal aspects of family and community life. . . . The results of many experiments demonstrate that destructiveness of patients or security regulations can no longer be used as valid reasons for the continued impoverishment of hospital wards or for keeping so many patients closely confined to them. Needed are not only bright and pleasant living units with abundant supplies of pictures, games, music, and reading and writing materials, but other symbols of the home such as plants, pet animals, provisions for making and serving snacks, and so on. Needed equally are meals attractively served in dining rooms,

¹ Pollock, B., *Drug Therapy — Clinical and Operational Effects. Changes in the Mental Hospital Resulting from the Addition of Chlorpromazine to the Total Therapeutic Program*. *Mental Hospitals* 7:14-16 April 1956.

² *News Note*, *American Journal of Psychiatry*, 113:88, July 1956.

³ Greenblatt, York and Brown, *From Custodial to Therapeutic Care in Mental Hospitals*, New York, Russell Sage Foundation, 1955.

⁴ *Ibid.*, p. 409.

⁵ *Ibid.*, p. 484.

⁶ *Op. cit.*, p. 25.

⁷ *Op. cit.*, p. 416.

and a wide variety of social activities both on the ward and to the largest possible degree in other places where men and women may participate together.

"Concern for the details of the patient's life from admission to discharge and from morning to night will, we believe, achieve several ends simultaneously. Selected games and social activities, for example, can be used to allay some of his anxieties, increase progressively his interpersonal competence and skills in recreational and occupational situations, and as a means for helping the staff and other patients to establish relationships with him, and him with them."

The Boston experiment proved without a doubt that mental patients accepted and reacted favorably to comfortable quarters. As in the days of moral treatment, it was by this favorable type of inviting environment that patients and staff were encouraged to mingle, to interchange, to see each other as human beings, living and working together to solve common and individual problems.

The Architectural Implications

The developments of the past 10 years have changed considerably the practice of psychiatry. Psychiatric wards, even those which were once the most disturbed, are becoming quiet tranquil places. By means of drugs, it is now possible to quiet rapidly even the most disturbed patients. The influence of the ward atmosphere helps the patient further in remaining in control of himself.

The use of shock therapies has decreased, hydrotherapy in many hospitals is no longer used. The danger of patients damaging attractive furnishings is greatly reduced and the opportunity to create attractive surroundings is greatly increased. The needs of patients for social exchange is much less hampered by the symptoms of mental disturbance and the capacity of the patient again to find himself in a social world is enhanced.

Recently the staff of the Architectural Study Project spent two weeks studying the 400-bed admission building of a large mental hospital. Practically all the patients were psychotic. In each of three wards, observers were stationed for 10 eight-hour periods. During this time, not a single major disturbance occurred and restraint or seclusion was never used. More than 60 per cent of the patients on these wards were receiving the tranquilizing drugs. The patients were also in a new building which was comfortable and pleasant. The situation was helped further by the availability of a large group of student nurses in addition to the nurses and aides, who spent most of their time in direct contact with patients.

The mental hospitals in some of the Western European countries (England, Holland and Denmark) are reported to be open hospitals. There are few, if any, locked wards.

To the writer's knowledge, there are no open public mental hospitals in this country. Some psychiatric services in general hospitals and possibly some small private mental hospitals operate as open units, but these select carefully the types of patients they admit. However, the trend in the United States is toward

achieving more and more opening of formerly locked wards. Among the 40 mental hospitals of the Veterans Administration, the average rate of patients who are free to leave the wards unaccompanied approaches 35 per cent of the total hospital population. In two VA hospitals close to 50 per cent of the patients are on "privilege" status and one hospital has achieved a 62 per cent "privilege" rate.

By use of drugs and social treatment, as well as older tried-and-proven psychiatric treatment methods, security requirements for mental patients have decreased sharply. Few seclusion rooms are required and the construction and design of the hospital wards have few special requirements, though many psychiatrists still prefer to place newly admitted patients on closed wards until there has been adequate opportunity for observation and diagnosis. There is now no excuse from a psychiatric standpoint to fail to provide most patients with comfortable rooms, suitably furnished, well-lighted, and affording privacy or opportunity for group social life as desired or needed.

Toward the Future

Psychiatric treatment at present is based on psychotherapy, somatic therapies, including drugs and shock treatment, and group living experiences. In most public institutions psychotherapy is very limited by staff shortages so that treatment depends on somatic and social treatment methods.

The physical requirements of somatic therapies are disposed of easily. But in the area of social treatment, the architect has a wide open field. How can he design hospital wards and areas to meet the social treatment needs of mental patients?

Mental patients are like all people — only more human, it is said facetiously. Any symptom found in a mental patient can be found in an individual not considered mentally ill — only in the patient, the degree may be more intense. Instead of designing buildings to fit the traditional stereotypes of mental patients, buildings should rather be designed for people who have certain specialized needs in addition to the needs of everyday living.

Conclusion

New and effective treatment methods for psychiatric patients have reduced sharply the numbers of disturbed patients and those requiring special security measures. More patients now require and can profit from activity therapies (occupational, industrial and recreational) and psychotherapies (individual, group and psychodrama). The social environment of the nursing unit and of the entire hospital acts as a therapeutic force encouraging interpersonal relationships between staff and patients.

These are the ingredients of psychiatric treatment. Out of his knowledge and skill the architect must design the buildings and activity areas in which these therapies can proceed effectively and economically to promote the improvement of patients.

PSYCHIATRIC FACILITIES OF THE FUTURE

By DANIEL BLAIN, M.D., *Medical Director, American Psychiatric Association*

THE PICTURE of mental illness is changing. The subject is bigger and broader and more comprehensive. There is a shift in the relative role of categories of illness and the patients who suffer from them. Scientific knowledge is advancing, treatment and management are more effective and the focus of treatment is changing, as is the optimum timing of treatment in the life history of various mental illnesses. New ideas concerning personnel techniques, equipment and buildings are going through the ordeal of trial and error, and successes and failures of some of these are guiding the way for further experimentation.

The seven categories of mental illness: acute and chronic brain injury, mental deficiency, psychotic disorders, the psychoneurotic disorders, the autonomic sympathetic and visceral disorders (psychosomatic), personality and character disorders (including the psychopath) and the transient situational disorders, are now all receiving attention whereas previously the psychoses received most of the attention and dominated the picture. In fact the sway of the pendulum had gone so far as to include in mental health all of the problems of society; individual, local, national and between nations. This trend toward inclusiveness is now, however, being restricted by many who feel there is a real distinction between social health, and its many components, and mental health which is only a part of the total area of social health. They feel that mental illness should not include those who have occasional and mild symptoms that may be logically laid to a normal psychophysiological response to stress. With respect to the specific total groups of entities listed above there is no evidence of a relative increase in the rates of illness. Increase in absolute numbers of mentally ill is a reflection only of the growth of the population.

There is a shift in the relative importance of certain categories such as the psychoses, chiefly schizophrenia. The latter has increased, while acute brain damage, from trauma injections and vitamin shortage, has lessened. Chronic brain damage due to arteriosclerosis is increasing due to the aging of hospital patients and the increase in numbers of aged who are admitted. Mental deficiency is receiving more attention as training, education and research are successful in getting patients home in large numbers.

Emphasis is on the acute and early case with great demand for facilities for treatment. The rise of the rehabilitation technique has given a new hope for chronic patients ranging from improved cases to successful ones. Childhood needs are receiving special attention particularly in residential treatment centers.

Mental hospitals have grown in many ways: Between 1946 and 1954, numbers of mental hospitals grew to 554, an increase of 16.4 per cent; number of beds up

to 691,176, an increase of 21.6 per cent; average daily census to 668,463, an increase of 29.3 per cent; percentage of occupancy to 97.6 per cent, an increase of 5.7 per cent; number of admissions to 288,780, an increase of 42.9 per cent; total assets to \$1,931,342,000, an increase of 100 per cent; amount of money spent per patient per day, \$3.22, an increase of 131.7 per cent; payroll expenses to \$494,079,000, an increase of 226 per cent; payroll expenses per patient per day, to \$2.03, an increase of 152 per cent; number of full-time personnel to 178,429, an increase of 80.5 per cent; and finally the number of full-time personnel per 100 patients to 27, an increase of 42.1 per cent.*

Provision of mental hospital services alone is not insufficient. The trend is for community and home treatment with emphasis on the community mental health centers, outpatient clinics, home visiting and use of various local resources, the most important of which is the psychiatric unit of the general hospital. Methods of relieving overcrowding and of improving residential services have led to a movement discouraging the enlarging of the traditional mental hospital, or building new ones, and favoring the use of new ideas such as Branch Hospitals for the aged or other groups, Day and Night Hospitals, Half-Way Homes, the Psychiatric Shelter Workshop, Geriatric Hospitals, Colonies for Mental Deficients, Psychiatric Rehabilitation Centers, Diagnostic and Screening Centers, and the Therapeutic Farm. (These are described in other papers by the author.)

There is a decided change in orientation in the field of mental health. Financial support for training, experimentation, research and construction has been remarkably increased from private foundations, state governments, and particularly the Federal government in N.I.M.H. and other branches of the Department of Health, Education and Welfare. An increasingly larger segment of the population is being treated in community facilities where and when they are being made available. All categories of new physical facilities are reflecting in their planning, design and detailing more recognition of the needs of the individual patient; patients are being treated and cared for in smaller groups in smaller buildings; a more normal and acceptable — a more therapeutic — environment is being provided for health-promoting activities in occupation, recreation and socialization; in short, custody and security are no longer the chief concern of responsible authorities; this concern has been replaced by a recognition of the need to provide the wide variety of facilities required in a modern psychiatric program to meet total community needs.

* From Louis Block, M.D., derived from *American Hospital Association Administrative Guide, 1950-1955.*

PROJECTED MENTAL HOSPITAL SHOWS NEW TRENDS

Preliminary Scheme for Psychiatric Hospital

Ponce Medical Center

Ponce, Puerto Rico

Alston G. Gutterson, Architect

EARLY PLANS for this hospital reflect, probably as do no other current plans, two major developments in therapeutic procedures in the mental hospital. These are (1) the new drug therapies, and (2) the so-called "activity program," by which mental hospitals in Europe have been able largely to eliminate security features and maintain an "open hospital." Doctor

Juan A. Pons, Secretary of Health, had visited hospitals in the United States and Europe and wanted recognition, in the planning of the hospital, of trends.

The mental facilities are part of a base hospital, a medical center, to serve the entire regional area. Before the present secretary took office, land had been acquired for a general hospital, but since he decided to

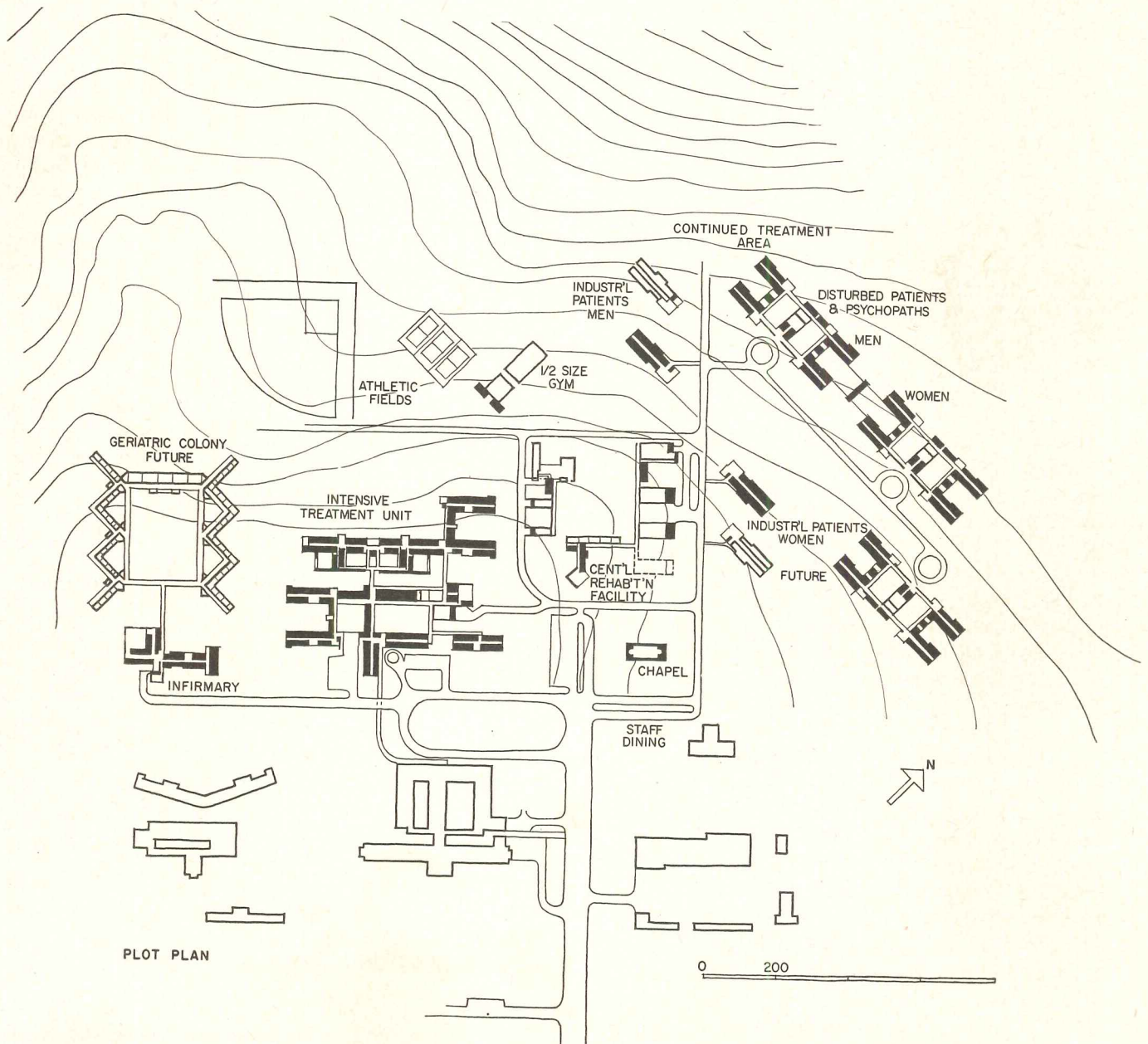

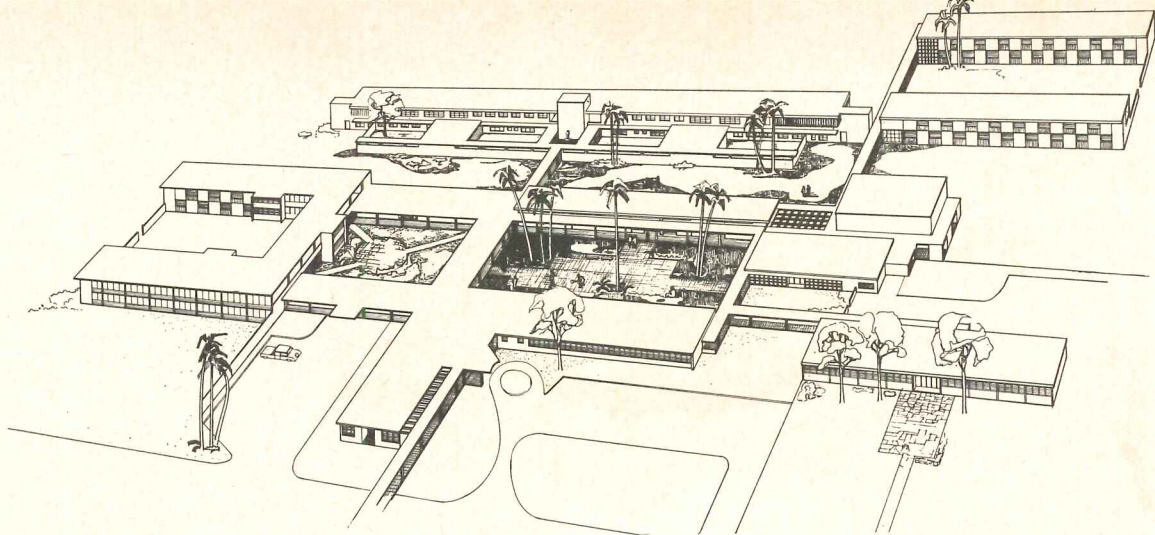

build also a tuberculosis hospital and a mental hospital to serve the same area, it was decided that a larger site should be acquired so that the three services could be integrated.

The general hospital was to be the basic diagnostic and treatment unit, also the basic admission unit. Accordingly, the outpatient department was to include offices for psychiatrists as part of the regular outpatient diagnostic and treatment services, and the inpatient area of the general hospital was programmed to include a 22-bed nursing unit for acutely ill psychiatric patients.

The psychiatric hospital is planned as a base unit to serve the entire region. General hospitals of the region are scheduled to have inpatient and outpatient services where they will be large enough to support such a service. The smaller general hospitals are programmed to have rooms for the receiving and emergency care of any patient until he can be transferred to a psychiatric service.

The intent is to provide at the base unit all services required in a community intensive treatment unit. Thus, the services provided are an outpatient service, this unit also to serve as the facility from which ambulant psychiatric teams are to serve other communities; a day care unit; an open unit for non-psychotic new patients and a receiving and intensive treatment unit of 100 beds with 200 beds in the convalescent service. All nursing units are kept small — from 25 to 30 beds.

In the general planning of the intensive treatment unit the open unit, outpatient and administrative areas are placed on the public side. The latter two are connected by a covered walk to the general hospital. The occupational and recreational therapy areas are located between the outpatient and inpatient facilities; these services are to be emphasized in the treatment program and were given emphasis in the location. The inpatient service is located and oriented away from public side and areas provided for the development of separate private outdoor facilities for recreation and relaxation. The new patients then may go, on the one side, to separate private areas, or, on the other, to recreation and occupation with convalescent and day care patients. Convalescent patients are considered to be part of the new patient group. Due to climatic conditions, intensive sun and sudden showers, dormitories for these groups were pulled in close and covered walks provided. Traffic to and from these cottages is directly to the

occupational, recreational and dining areas.

In the planning of this hospital much emphasis has been placed on activity. In the European hospitals observed, activities in useful work, in recreation and social activities have reached a high level of development. It is said that by the use of "activity therapy," they have been able to get away from the custodial and secure building for a large proportion of their patients. The new buildings, particularly in Holland, have none of the characteristics of the mental hospital as we have known it. They are pleasant, of one- or two-story construction, in small units; many of them, excepting the receiving building, are open and unoccupied during the day as most patients are occupied at regular jobs or other scheduled activities. This program has developed over a period of approximately thirty years; it has been a related development from country to country, and has done much to open up the hospitals, to reduce the cost — both initial and operating — of buildings required in the care of psychiatric patients. It is true that the total problem has been made more manageable by the provision of emergency services, outpatient clinics and short-term services in communities.

The major activities of the total hospital will be of an "industrial" nature in useful hospital and other work. Facilities for these are provided in the shops of the central rehabilitation area. The activities of the new patient area will be those more correctly defined as occupational therapy, as we have known it, in that they will chiefly be employed in occupying the patient while determining the kind of activity most suitable for his treatment. These activities will be in wood work, modeling, painting, sewing, weaving, ceramics, leather work, etc. There will be carts to supply some activities to patients who cannot go to the central facility.

The outdoor area adjacent to the occupational therapy wing will also be used for these activities, the walls being largely formed by overhead doors.

The canteen, having counter area, table area and outdoor terrace area and the exercise gymnasium with outdoor exercise yards, are also located in this general area. The effort is to create an interesting, stimulating environment, with people engaged in activities in work and recreation in an area central to all patients.

In the design of the nursing units two therapeutic pro-

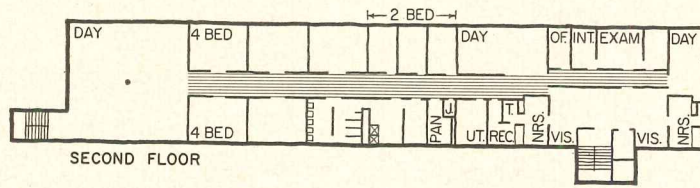

RECREATION AREAS

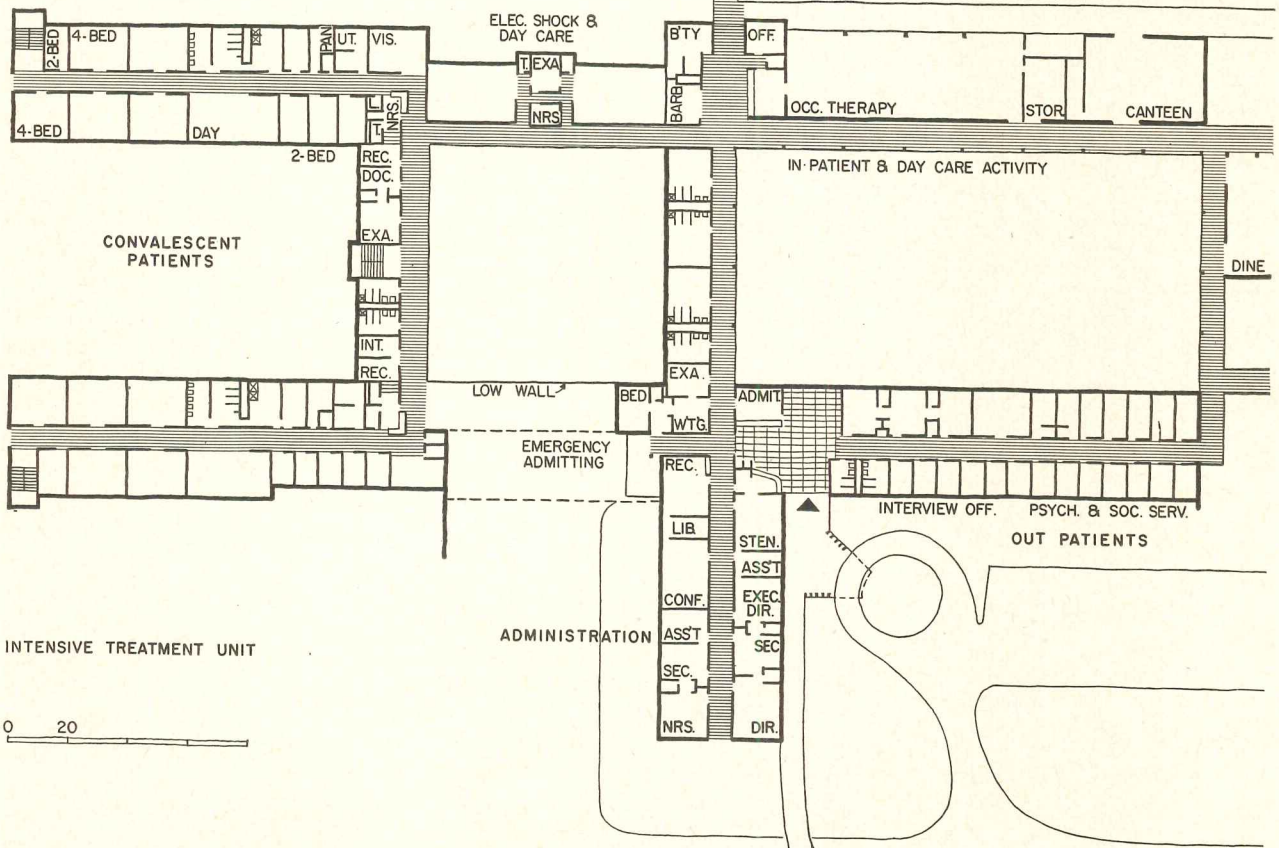
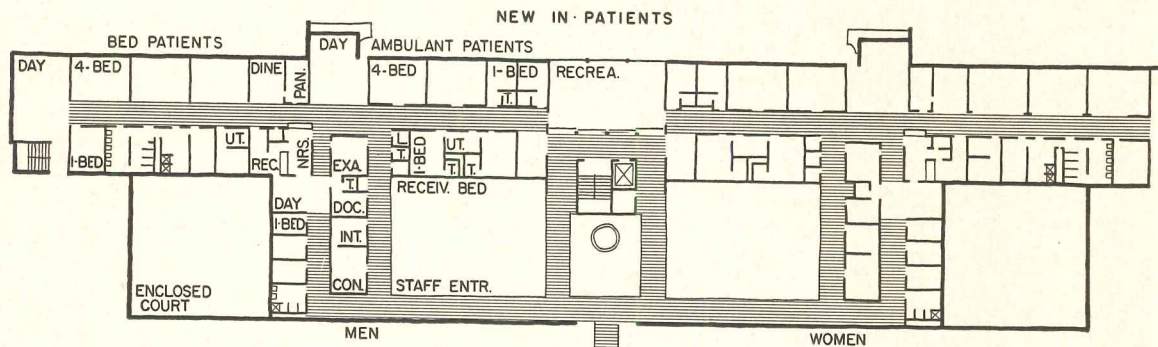

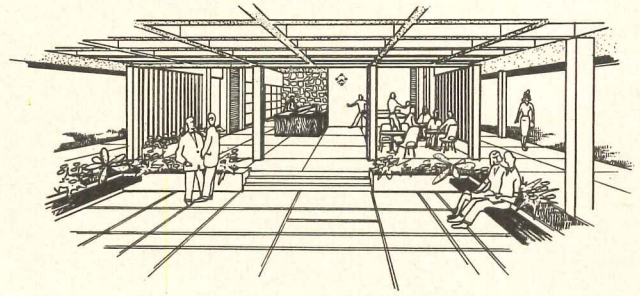

cedures were chiefly responsible for the arrangements of facilities and the environment it was determined to provide; namely activity therapy and newer drug therapies. It has been shown that a large proportion of patients treated with these new drugs very quickly improve in behavior so that they are more cooperative and are more quickly in need of activities. In previous discussions on requirements, when many patients were largely confined to the nursing unit, one-story construction has been recommended so that patients could get outside without great inconvenience to the staff, with the newer drugs — and most hospitals are now using them — fewer patients retain bizarre behavior patterns, so that segregation is not of such importance as formerly. The difficulty of “controlling them” in stair halls is a problem that no longer exists for by far the largest proportion of patients. For these reasons two-story construction was considered to be satisfactory, the better, more active patients to be on the second floor.

The first floor of the inpatient units is arranged for the newest patients. This nursing unit has in general three patient areas projecting from the central core of treatment and service facilities. The rooms to the front are for quiet ambulant patients; those projecting from the main axis are for patients who may need to be isolated from the other patient group; and the rooms beyond the nurses’ station, while they can be used by active ambulant patients, have been planned to provide easy observation by the nursing staff of bed patients under drug treatment. Some hospitals, upon determination that the patient is qualified for tranquilizing drug treatment, give it in sufficiently large quantities so that the patient is required to remain in bed. During this period the patient sleeps a good deal of the time, but can get up to go to the dining room, bath or toilet rooms, and can discuss the nature of his problems with the doctor, but does need careful nursing. Upon completion of this week or ten-day period, the patient is ambulant and in need of activities. It is said that there is an advantage in giving the drug in this way in that new patient management problems are reduced. Little change is required, however, in the detailing; walls between the four-bed rooms are provided with glass areas, and along the corridor with movable panels or fabric to provide better observation of the total area.

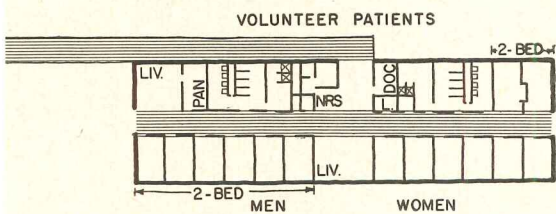
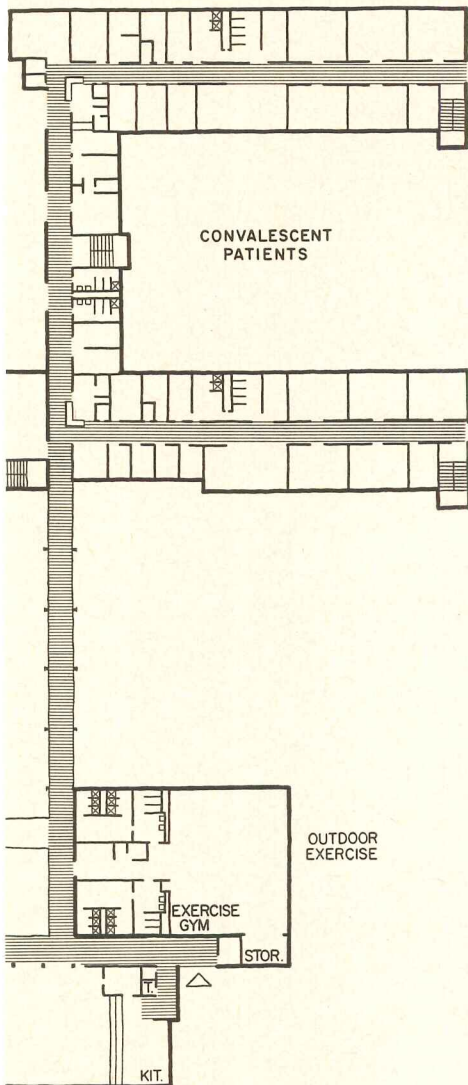

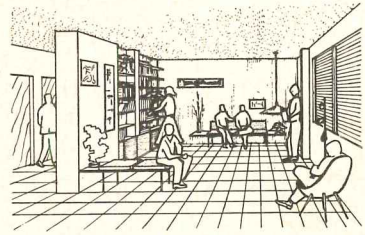
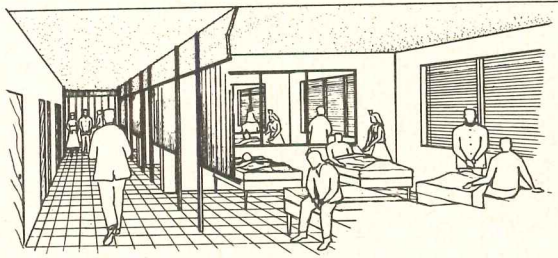

The nurses' station has convenient view along the corridors, into day room areas and the outdoor patio. Treatment and service facilities are removed from the patient areas and occur at the center of the unit. Medical staff and services may enter the nursing unit at this point or at the patient entrance to the ward. A visitors' room is provided at this end of the unit to

provide a good impression upon one entering the nursing unit.

In the forward end of the nursing unit, the four-bed room and two single rooms are planned, in general, for patients who would be ambulant and more active. They may be patients who have gone through a course of treatment in those rooms at the end of the unit; who

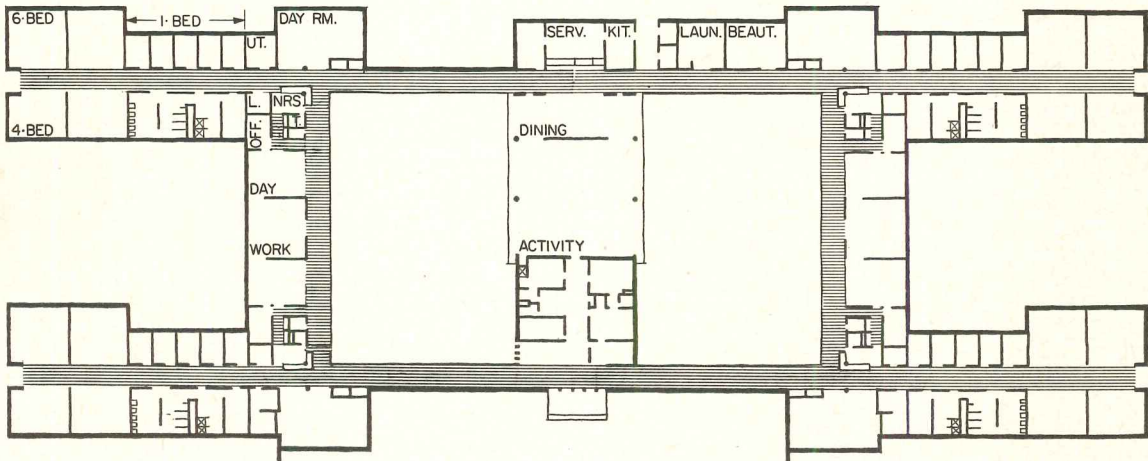

BUILDING FOR DISTURBED PATIENTS & PSYCHOPATHS

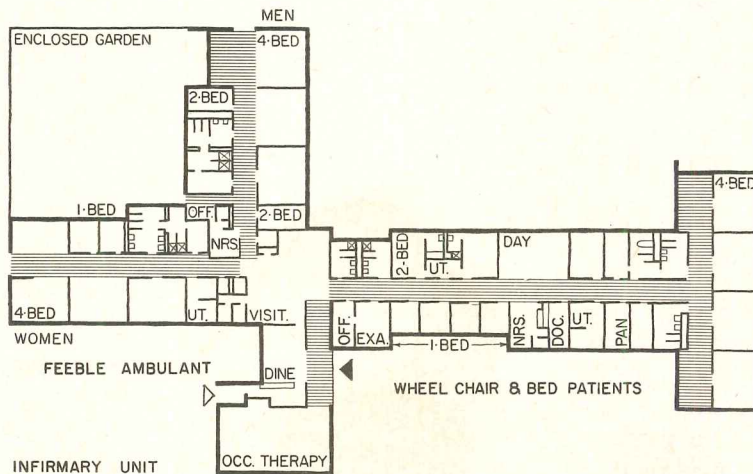

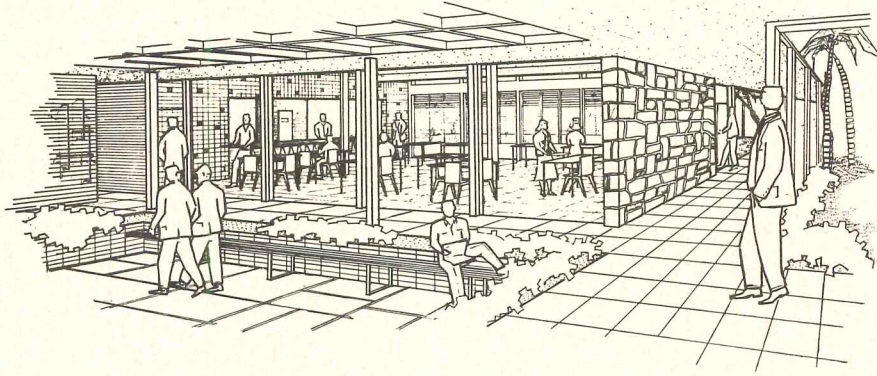

are under a more stimulating treatment regime, or who are qualified for better accommodations. The two bedrooms having private baths with sub-utility will be used for new patients, for special treatment problems such as insulin treatment, sodium amytal interviews, etc. For these reasons these two rooms are air conditioned.

The examination room, doctors' office, interview room and conference room are also air conditioned as privacy in interview or in discussion of a patient is required. These were removed from the main patient area so that these activities would not conflict with the patient day activities.

Most of the patients of these first floor nursing units will not go to the central dining room. For this reason a small dining room is provided for each unit, so that during this early diagnostic, and perhaps critical, period the patient can remain with the small group in a more-controlled environment.

The second floor nursing units are for patients who have been through the initial diagnostic and treatment phases on the first floor. These will be active, ambulant patients most of whom will be starting on activities in the central occupational and recreational therapy facilities of the intensive treatment unit. The environment is intended to be quite different from that of the first floor; it will be furnished more as a dormitory than as a hospital, though medical, nursing and service facilities are retained on the unit. Occupational and recreational areas are included for those patients who are unable to spend several hours in the central OT, RT area.

The eight units for convalescing patients will be used by patients on a full schedule of activities in the central occupational and recreational area of the intensive treatment unit or in the central rehabilitation area of the total hospital. Patients will, therefore, spend most of their time away from their rooms. These units will be furnished completely as a dormitory environment, though doctors' offices will be retained in the area. Any medical examination required will be completed in the facilities near the outpatient and day care area.

Traffic from these units is directly to the occupational, recreational and dining facilities of the total unit. These facilities will be used by day care patients,

patients on the volunteer "open" service, convalescent patients and approximately 50 per cent of those of the inpatient unit.

Facilities for continued treatment patients, for the geriatric group and the active ambulant group, are located in two separate areas. The area for geriatric patients is intended to be developed largely as a separate service, though it will use the diagnostic and special treatment facilities of the general hospital and make some use of the main recreational facilities of the hospital. Facilities for the housing of the active ambulant group are placed near the central rehabilitation area and recreation fields.

The first unit of the geriatric service is planned as 25-bed infirmary for bed, and very feeble, patients together with a 25-bed unit for ambulant patients. The nursing unit for the infirmary group is complete with all facilities required in careful nursing and with a diagnostic and treatment room. The unit for the ambulant patients includes a dining room, two living rooms, a central occupational area and an enclosed garden area or patio. Expansion will be toward the north and is planned to include occupational and recreational therapy facilities.

Some of these patients will be conducted to central areas for movies, games, etc.

The active ambulant patients of the total hospital for which special dormitories were considered necessary are the industrial classification and the chronic disturbed and psychopaths. The former will live in an open dormitory situation; the latter in closed buildings some of which may provide maximum security. In these units special recreational and occupational therapy facilities both indoor and outdoor are planned.

The central rehabilitation area is to include a chapel; library with reading and music rooms; a recreation building having a canteen, bowling, table tennis, a small commissary, barber shop and beauty shop; central dining for continued treatment patients; and work shops. In the latter useful work activities are planned. In Holland and Switzerland the experience of using useful work to develop responsibility in the patient has been so successful that since the war many hospitals have entered into contracts with manufacturers to supply goods that can be largely hand made; the patients get paid for the work they produce.

CLINIC AND TRAINING CENTER FOR A UNIVERSITY

PLANNED AS PART of the Wayne University College of Medicine, the Institute is primarily a training center for psychiatric workers and nurses, but will also engage in research. Secondly, it is to serve directly the mental health needs of the community and the state through a program of inpatient and outpatient therapy, administration of convalescent care supervision, family care placements and pre-admission services. For inpatients, the building is planned for approximately 36 adult psychotics, 50 adult psychoneurotics, 24 adolescents and 40 children. All in all, the institute should prove a valuable link in the chain of mental health facilities designed to keep patients out of the strictly mental hospital (see Dr. Blain's paper, page 205), to catch and cure disturbances in early stages. Also it should be a valuable facility for the important task of adding to the supply of trained psychiatric personnel, and for spreading the gospel into other areas of medical practice.

*Lafayette Clinic, Detroit; Wayne University College of Medicine.
Eberle M. Smith Associates, Inc.,
Architects and Engineers*

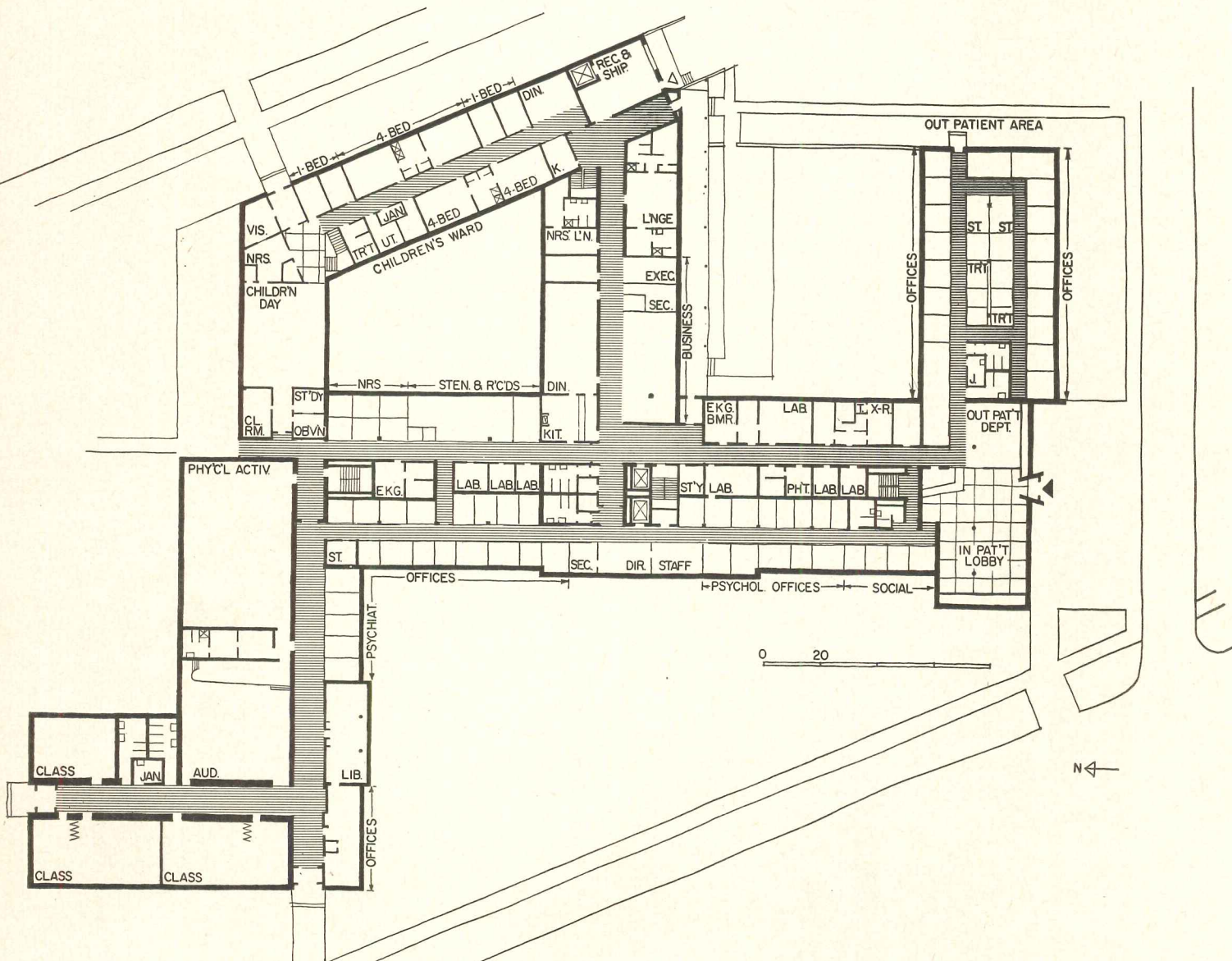



General exterior view, from right-hand end of plan (opposite page). Entrance serves outpatients

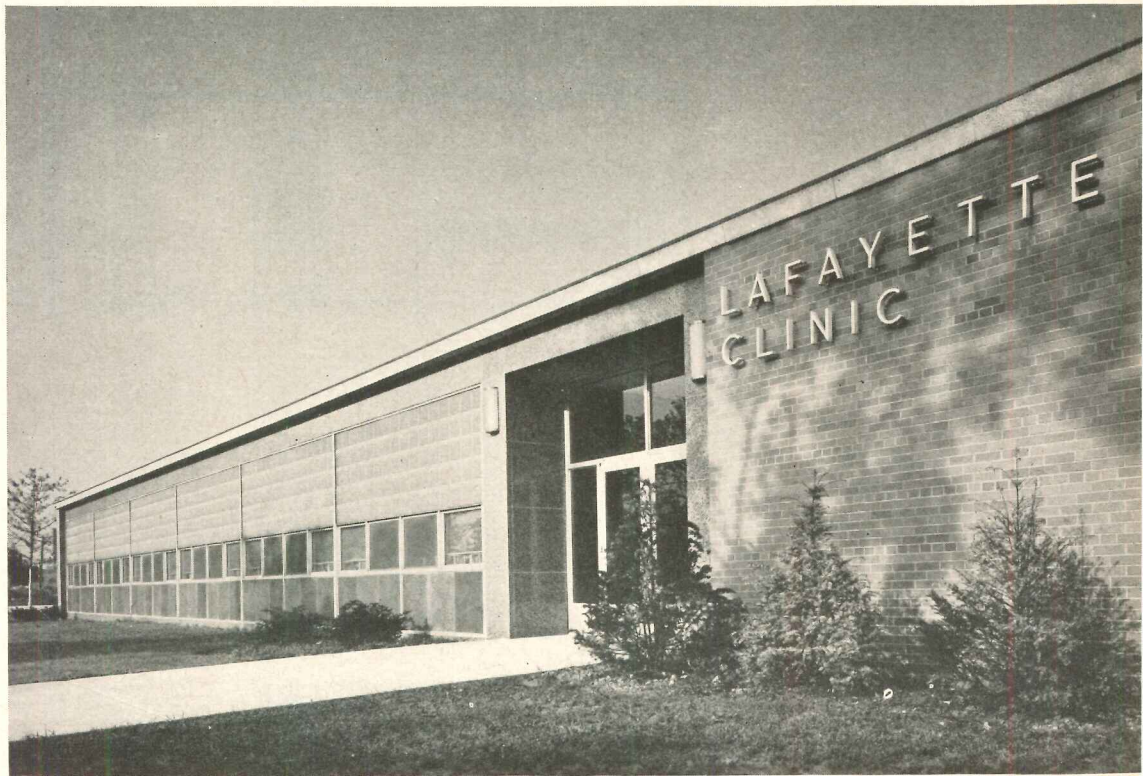

The educational wing of the clinic, (lower left corner of plan). This wing: classrooms, auditorium



Rear view, showing, in left foreground, the outpatient area; at the right, wing for inpatient children

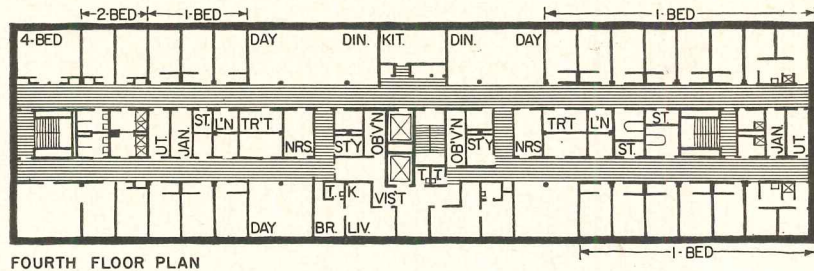

FOURTH FLOOR PLAN

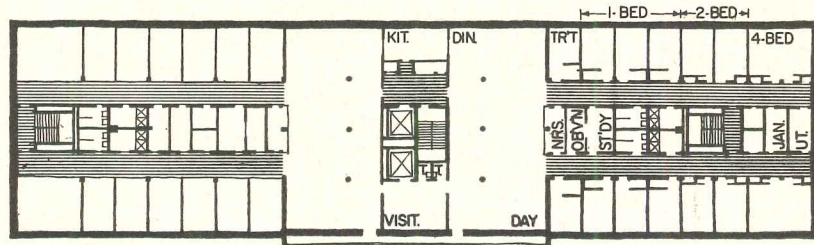

SECOND, THIRD FLOOR PLAN

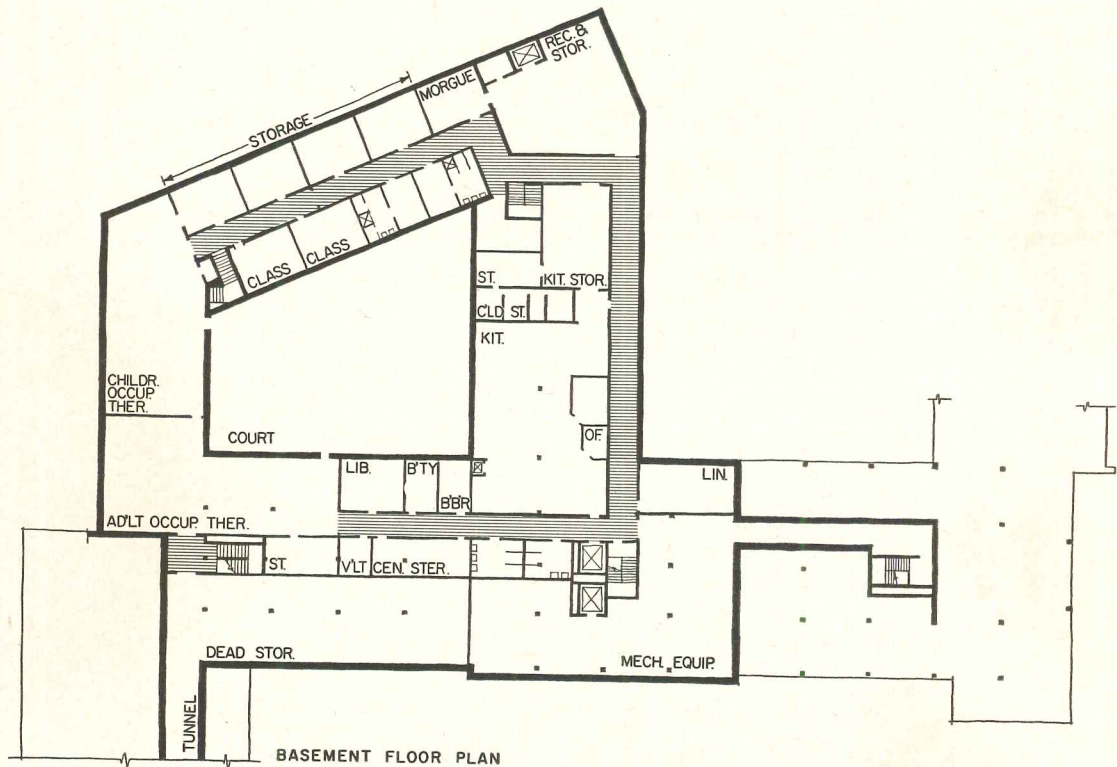

BASEMENT FLOOR PLAN

Hedrich-Blessing



Lobby and reception desk for outpatient department, first floor

Hedrich-Blessing



*Nurses' station, on patient floor.
Note double corridor arrangement*

Lens-Art



*Auditorium in classroom wing
for personnel training lectures*

JUVENILE UNIT FOR A STATE MENTAL HOSPITAL

Camarillo State Hospital, Camarillo, California. California State Division of Architecture: Anson Boyd, State Architect; P. T. Poage, Assistant State Architect; Arthur Dudman, Principal Architect

CHILDREN ARE NOT neglected in an active mental hospital building program by the State of California. The juvenile unit at Camarillo State Hospital is an especially good example of such a facility for the needs of retarded or delinquent children. There are, first, pleasant, small-scale dormitory buildings, known as "cottages," where the youngsters live as they might in an up-to-date private school. There are four of these dormitories, the children being divided by sex and by age. Secondly, there is a great deal of space in the whole unit, space for all sort of outdoor activities. There are also extensive indoor facilities for school, for occupational and recreational therapy, to give the children every chance to develop and to adjust. The administration building houses, along with doctors' offices, the receiving center for the hospital, with some rooms for new patients, including isolation rooms. Dining facilities are also in this building.

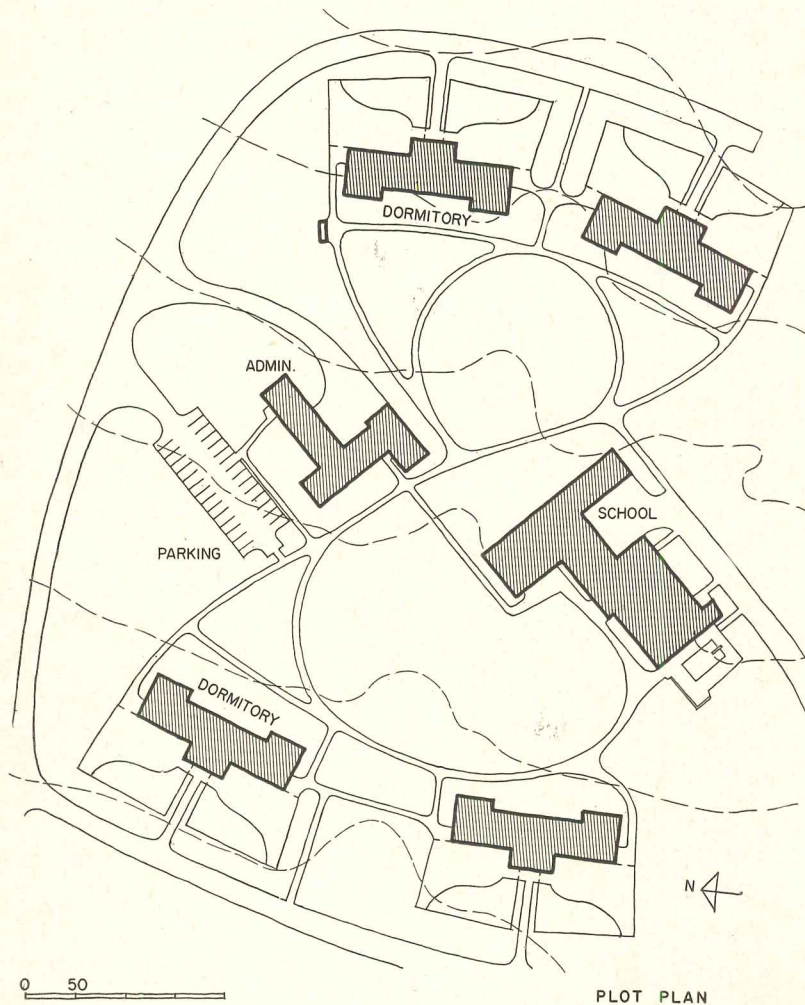

The classroom end of the school building; each classroom has door to its individual sun court

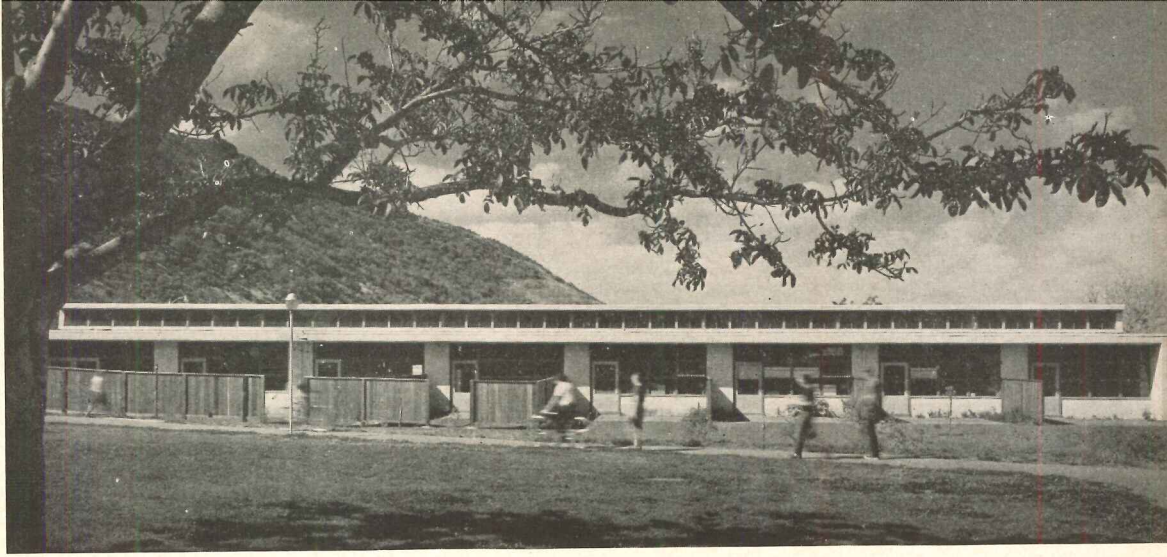

Gymnasium in school building is also used as theater and auditorium for programs and theatricals

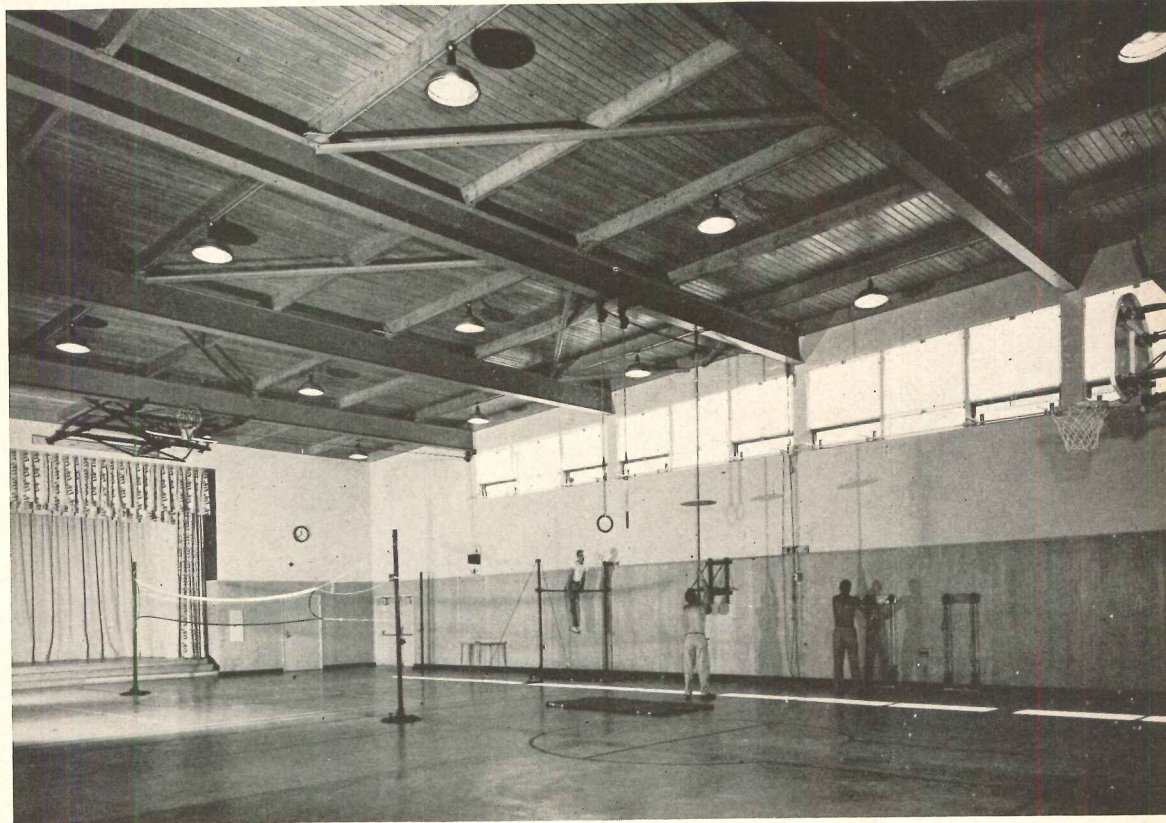

Occupational therapy plays an important role in child development, offers variety of activities

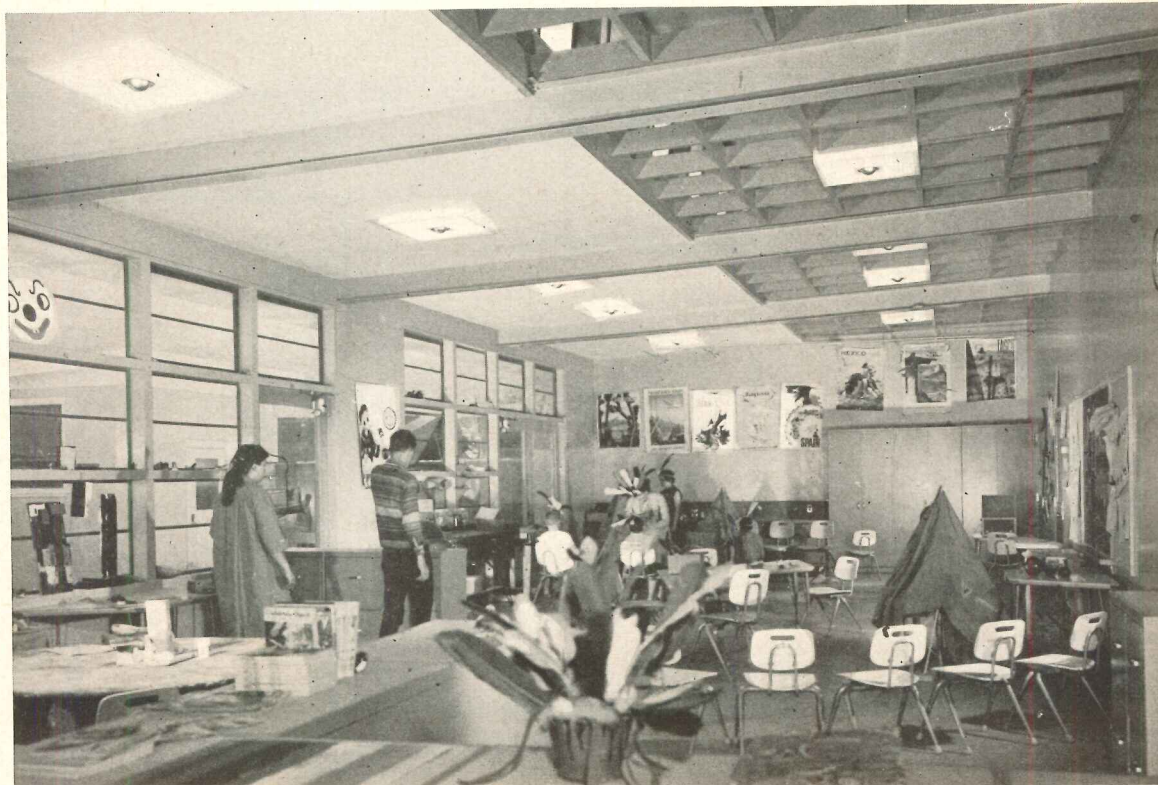

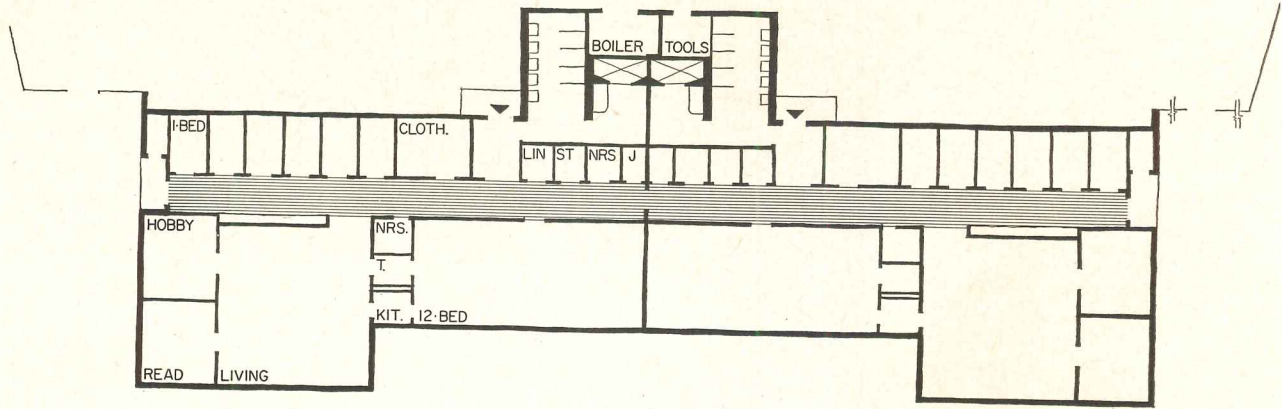

DORMITORY PLAN

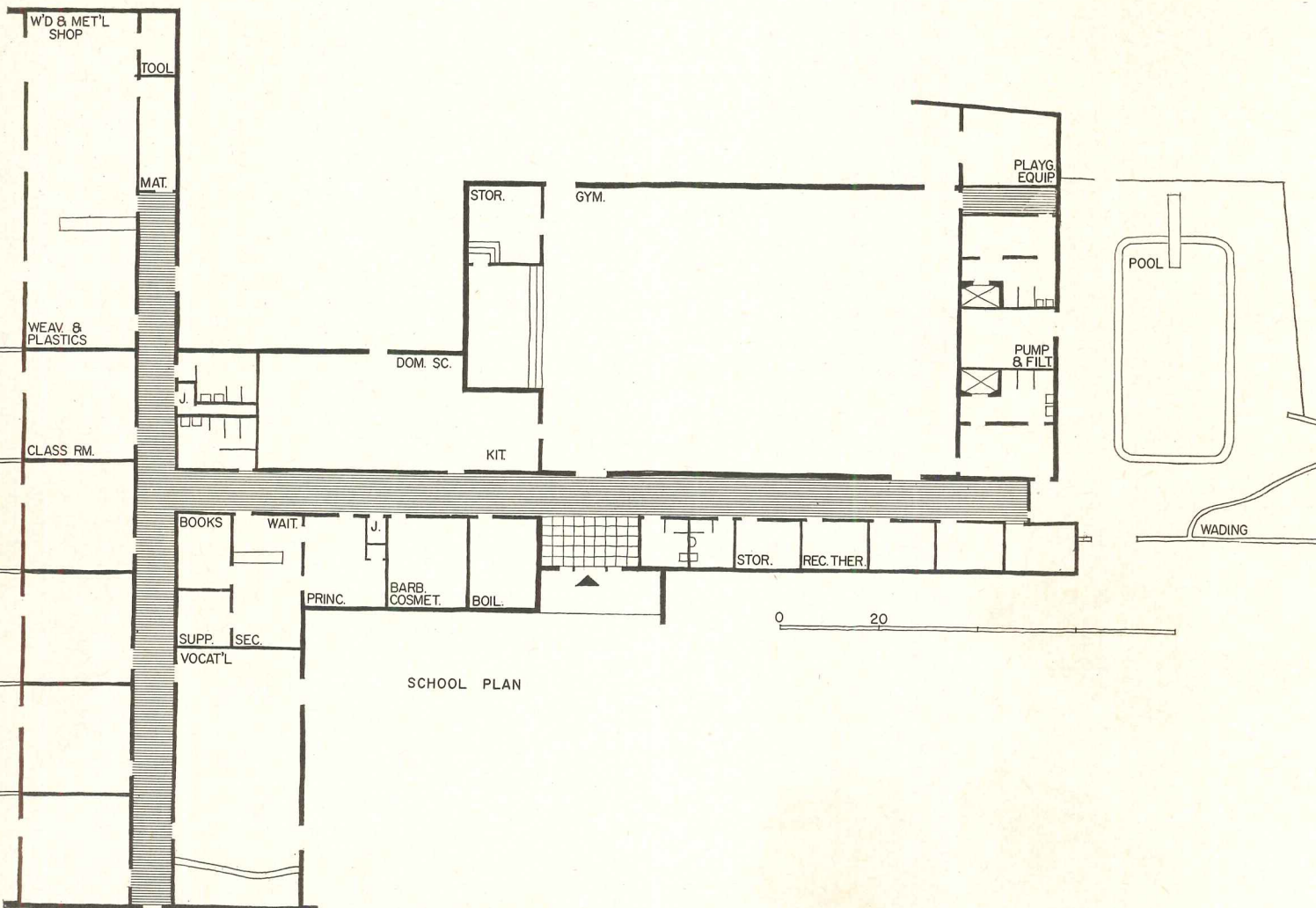

SCHOOL PLAN



Enclosed play area in rear of one of ward units; each building has two separate wards, two play areas

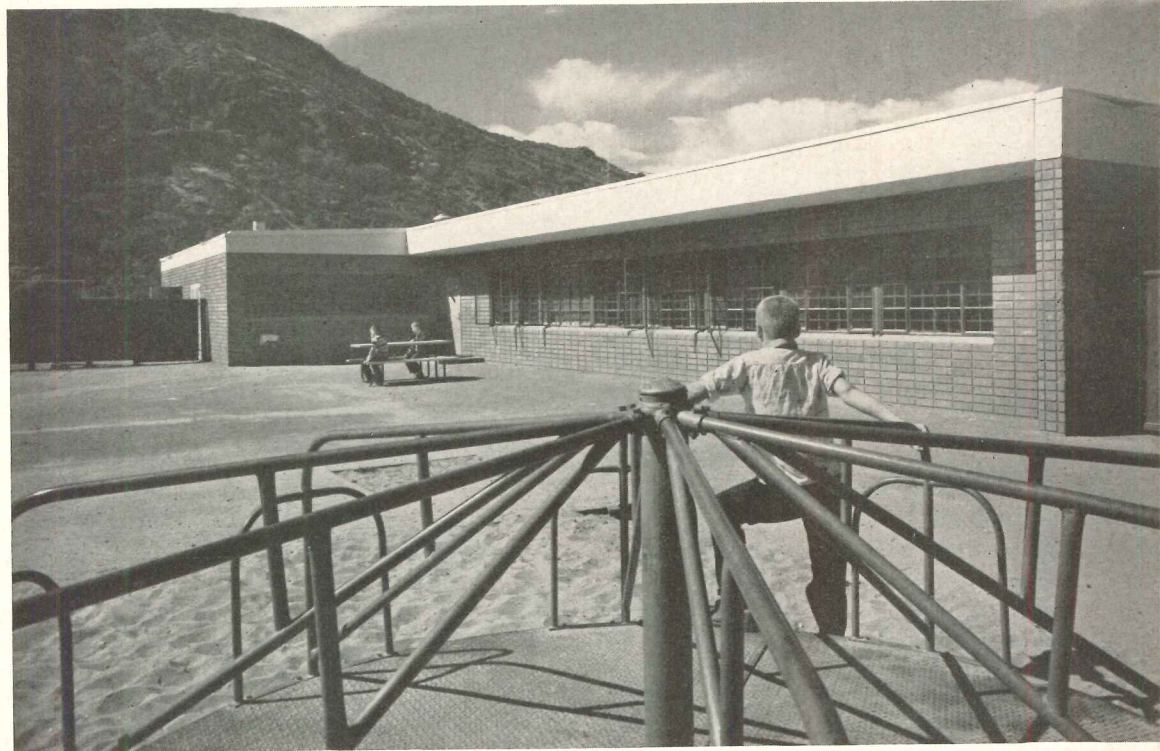

Another of the play areas behind a ward unit in dormitory building

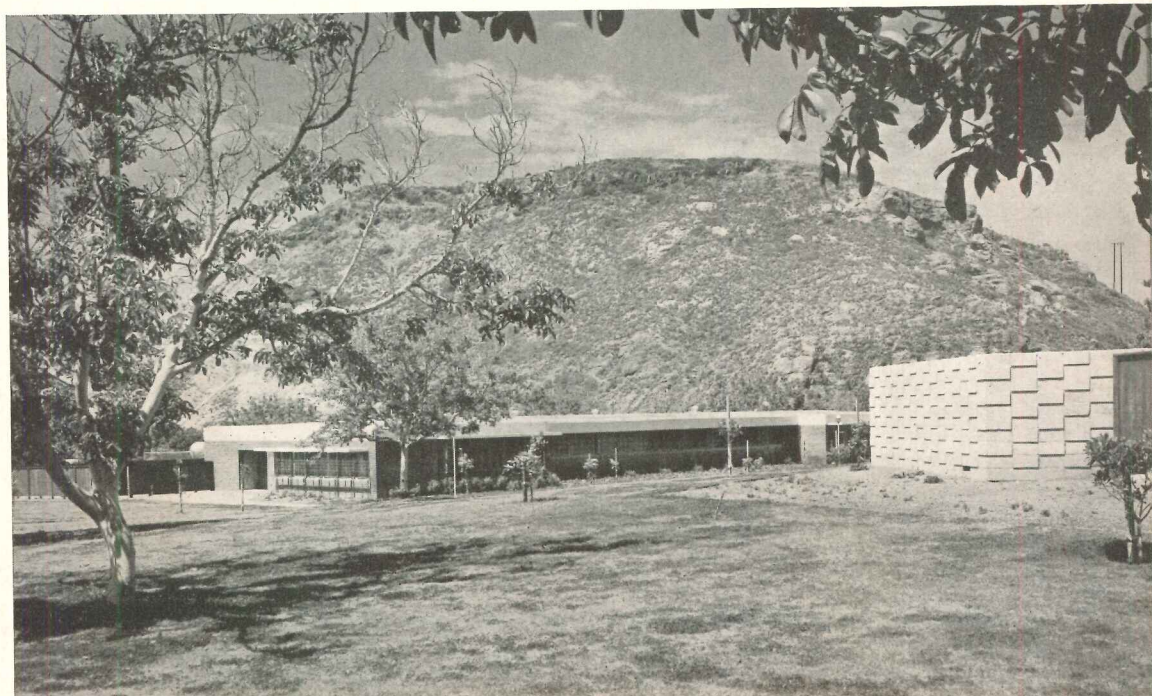

Ward building in background; the wall at right of photograph encloses the swimming pool

CALIFORNIA HOSPITAL FOR MENTAL DEFECTIVES

Porterville State Hospital, Porterville, California. California State Division of Architecture: Anson Boyd, State Architect; P. T. Poage, Assistant State Architect; Arthur Dudman, Principal Architect

A HOSPITAL for mental defectives of all ages, Porterville sets high standards in the amenity values that mean so much in mental health, particularly where the hospitalization may be lengthy. As the accompanying photographs show, spaciousness is one of Porterville's virtues, especially out of doors, along with flowers, scenery and activity equipment. This is a far distance removed from the old custodial institutions. The Division of Architecture puts spaciousness rather high on its list of criteria; Alfred Eichler, supervising architect, Design Section, mentions that "one of the first considerations in a mental hospital is space to avoid overcrowding. This means space between beds, space for day rooms, occupational therapy and outdoor recreation. . . . A mental patient needs room. No one thing can so seriously hinder his recovery as the elbowing of other patients and the absence of privacy when the patient wants it."

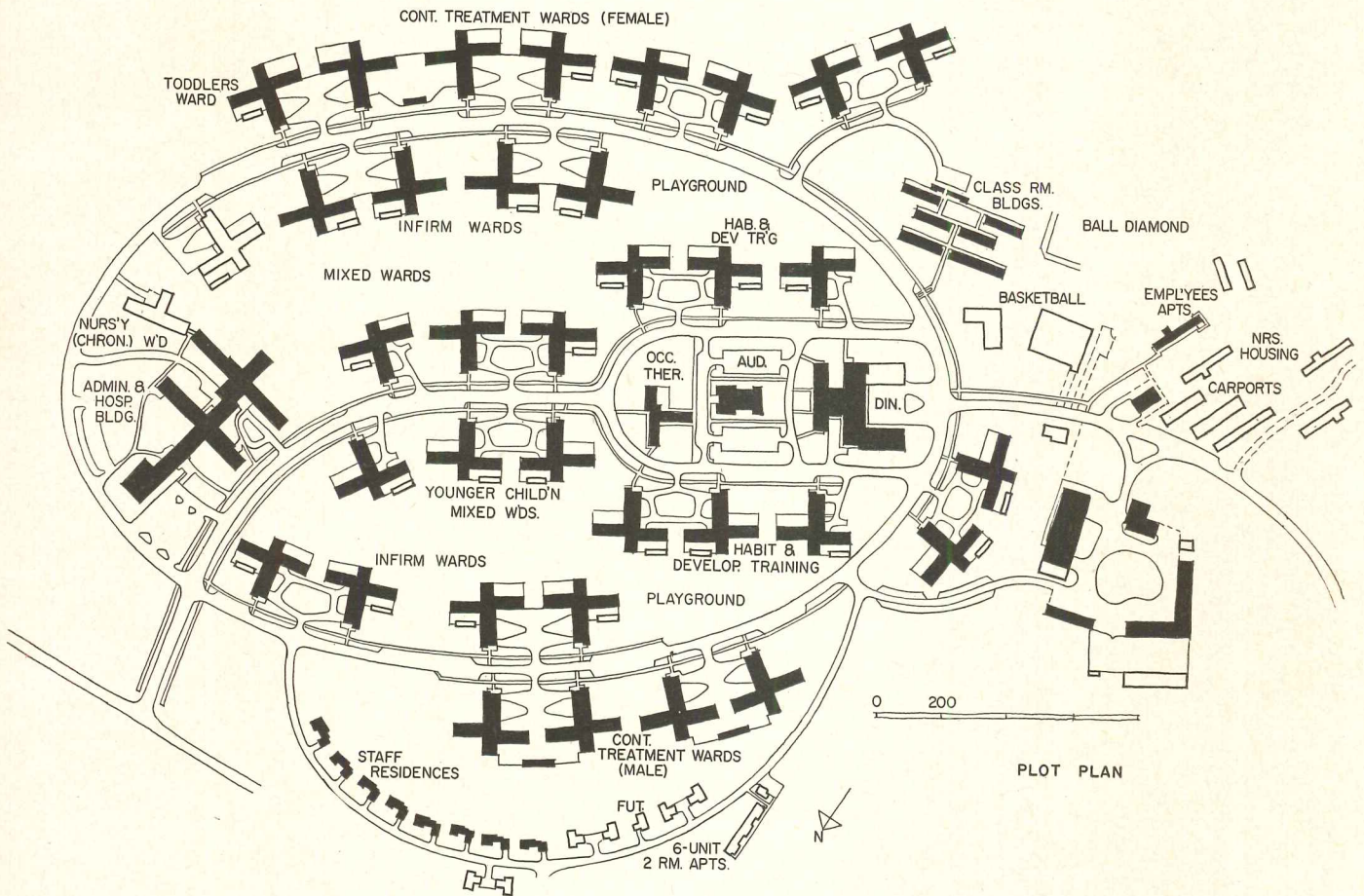



The Administration Building sets a note of spaciousness with a wide entrance plaza and planting beds



Lobby of Administration Building brings the outdoors inside and presents a very cheerful aspect

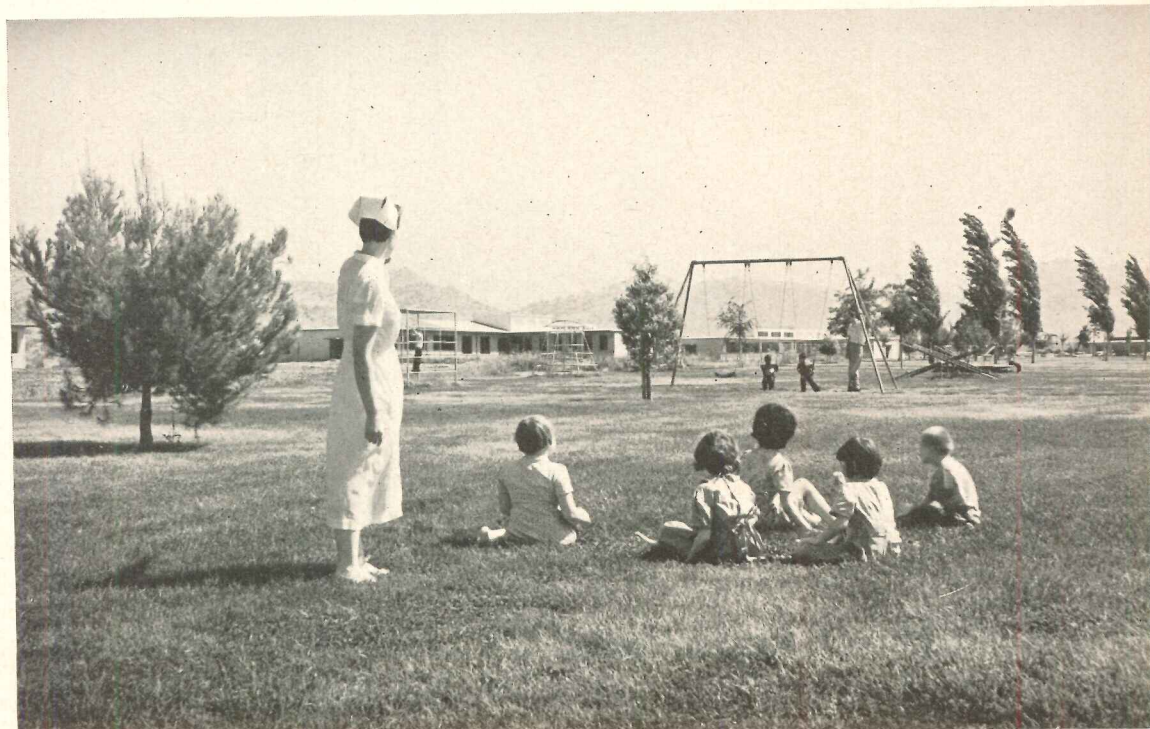

A scene in the toddlers' area, where the smaller ones have their own well equipped playground

In its mental hospital program, the state architects are placing heavy stress on the two principal factors of pleasant environment and provision for plenty of activity. Writes Mr. Eichler: "We provide space for occupational therapy, handicrafts, art work, weaving, pottery and recreational therapy in groups, such as card playing and games, watching television, recorded music or radio programs. Social workers keep in close touch with the problems. All institutions have chaplains for spiritual guidance, an important fact in therapy, and facilities are planned for them. A chapel construction program is being advanced by the Department of Mental Hygiene.

"No one is especially happy in a jail, therefore avoidance of the appear-

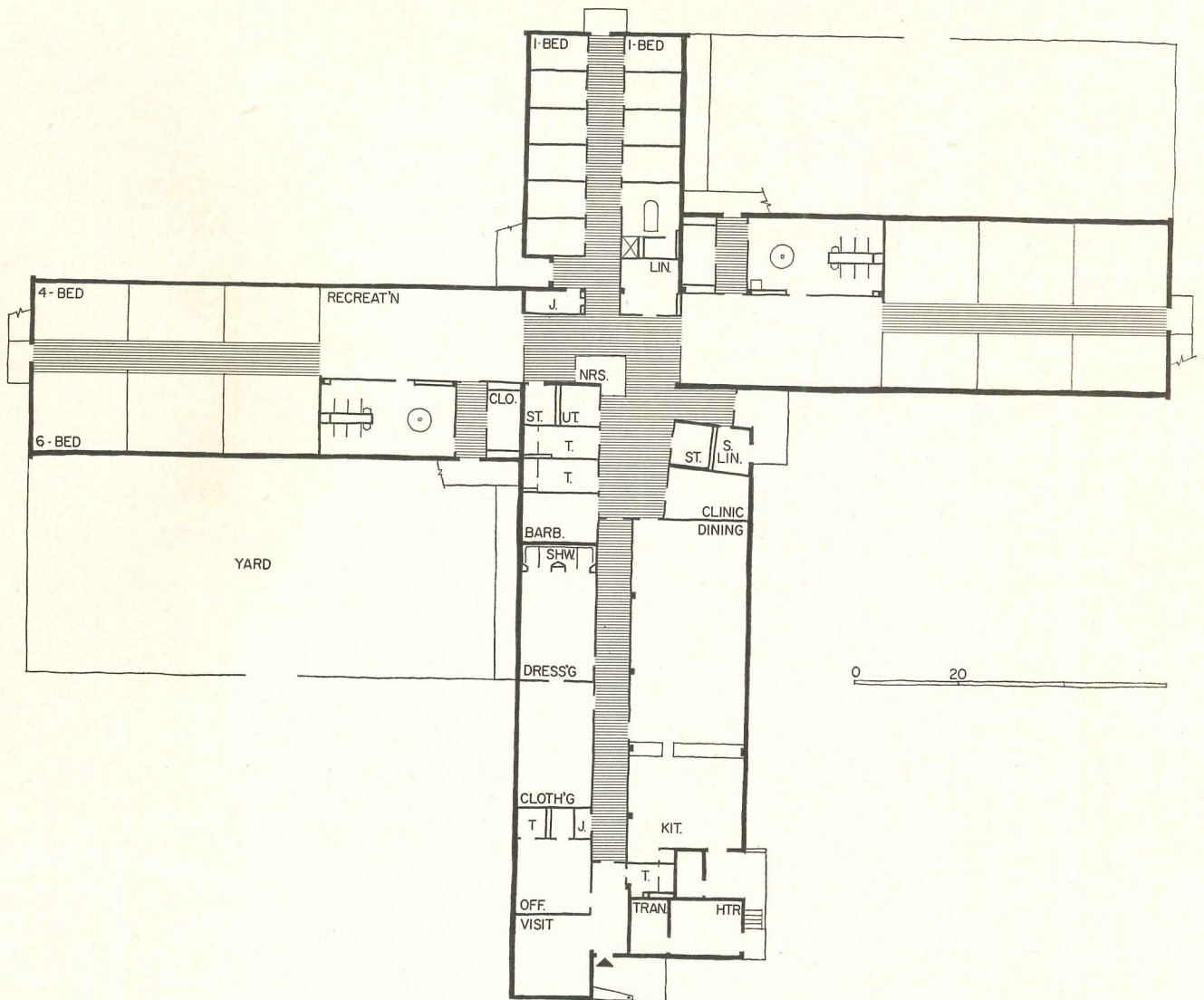

ance of restraint is imperative. This has gone as far as the elimination of built-in means of restraint, such as bars and grilles and locked doors, walls and fences, with a certain degree of success. Again no one is happy in a dreary and drab institution, therefore we brighten up the interior with sunlight, color and modern furnishings."

The California mental hospitals have gone especially far in the use and study of color. As for the study of color therapy, Mr. Eichler remarks: "during World War II state hospital work came to a standstill. Research was carried on and the postwar work was based on new thinking developed in medical committee discussions with the Division of Architecture, and



The activity area outside the music and activities therapy room, Rehabilitation Therapies Building

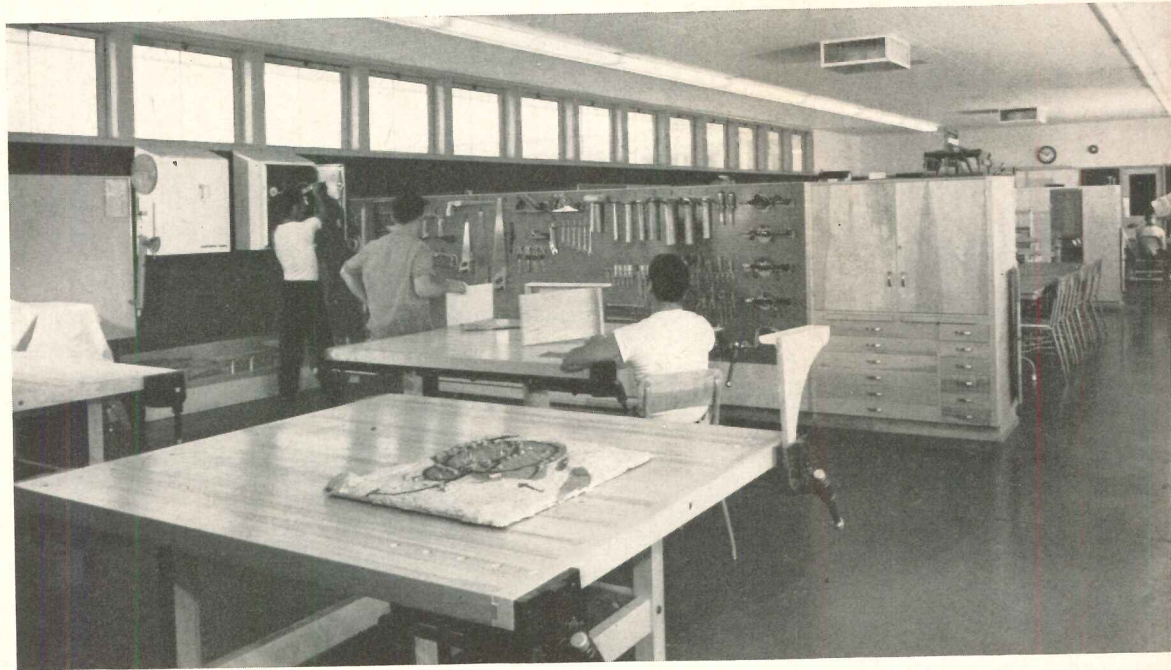

The occupational therapy suite in the same building; use of hand tools is especially good training

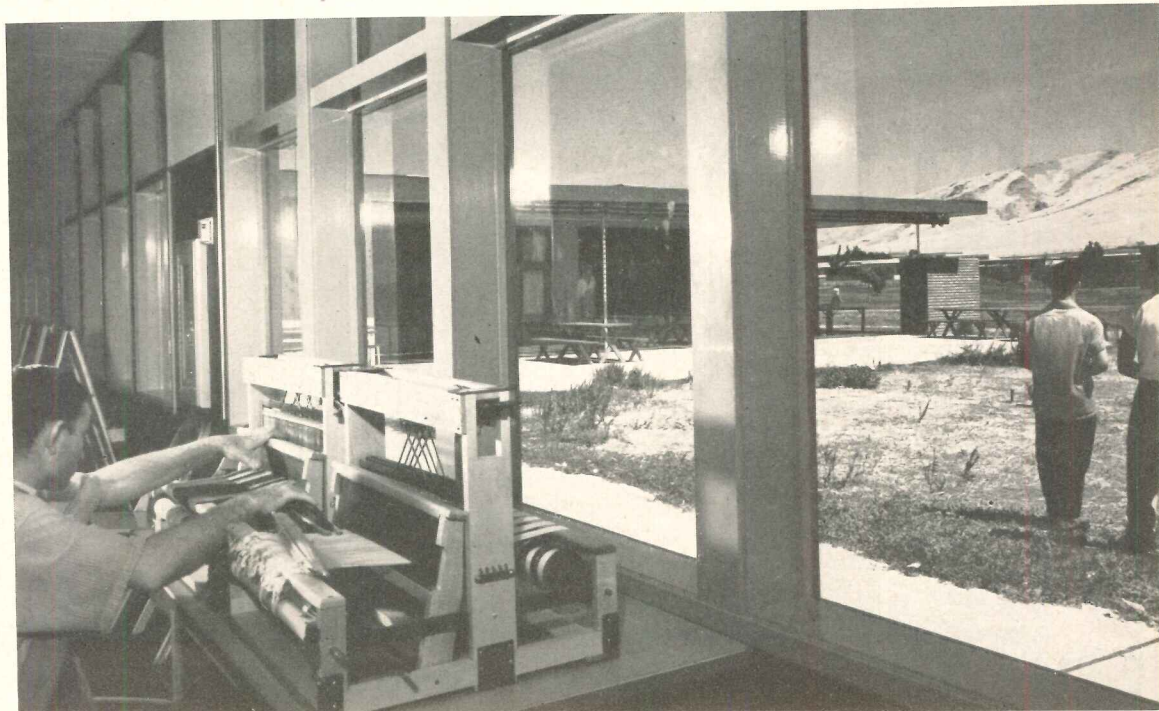

View from the same room; the boy operating the loom looks out on covered picnic area and mountains

resulted in setting new standards. The first of the new patient buildings to be constructed was at Stockton State Hospital, with ward units with a capacity of 1100 beds. This group presented the opportunity to demonstrate the new thinking in color therapy. . . . Color therapy at the other state hospitals is a continuation of the work done at Stockton. . . . There is increasing evidence that planning for use and the introduction of color

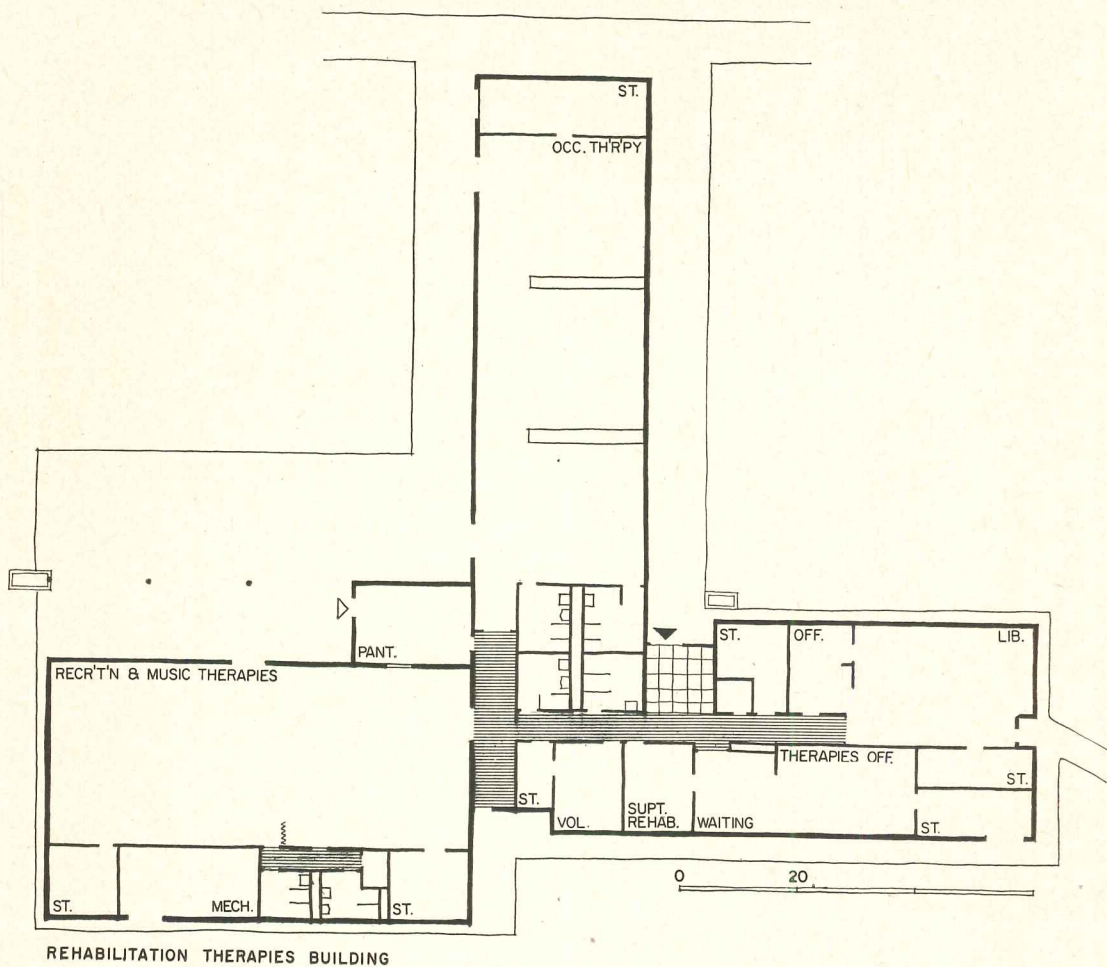

therapy pay off when groups of patients improve when transferred to new buildings. Elderly and infirm patients in greater numbers desire to get up, dress and walk about or use wheel chairs. The untidy improve and the listless take interest. . . . The surroundings affect the employees too, which further adds to the patients' response. Until man finds a way to eliminate mental disease, we are fortunate to have the kind of hospitals that are possible today."

A typical non-acute ward showing the sleeping wings on either side of central dining and office wing

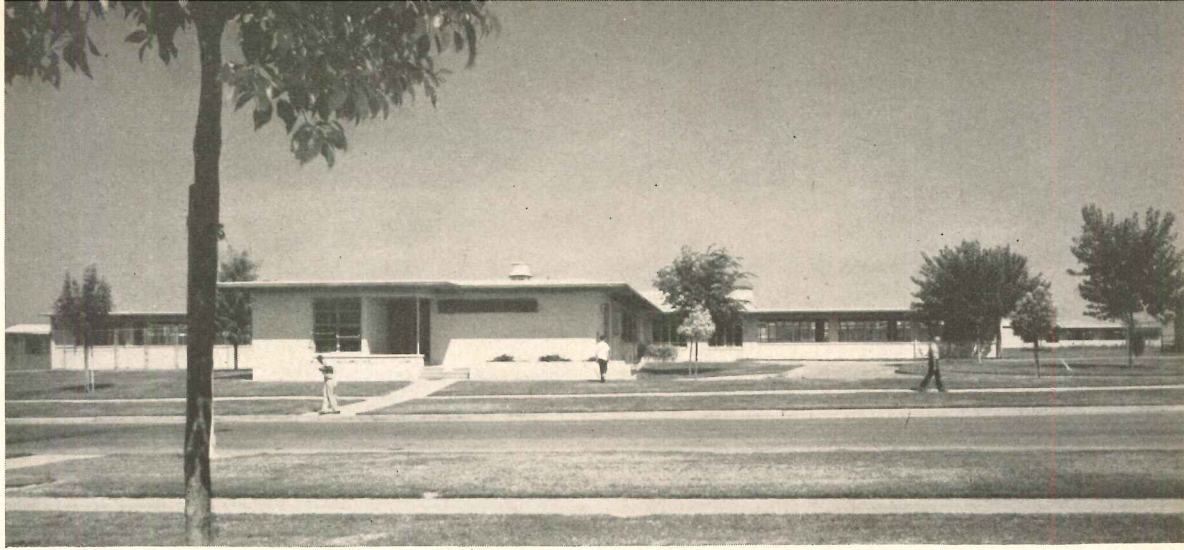

One of the ward play areas covered by a sun shelter. In the distance is the toddlers' play area

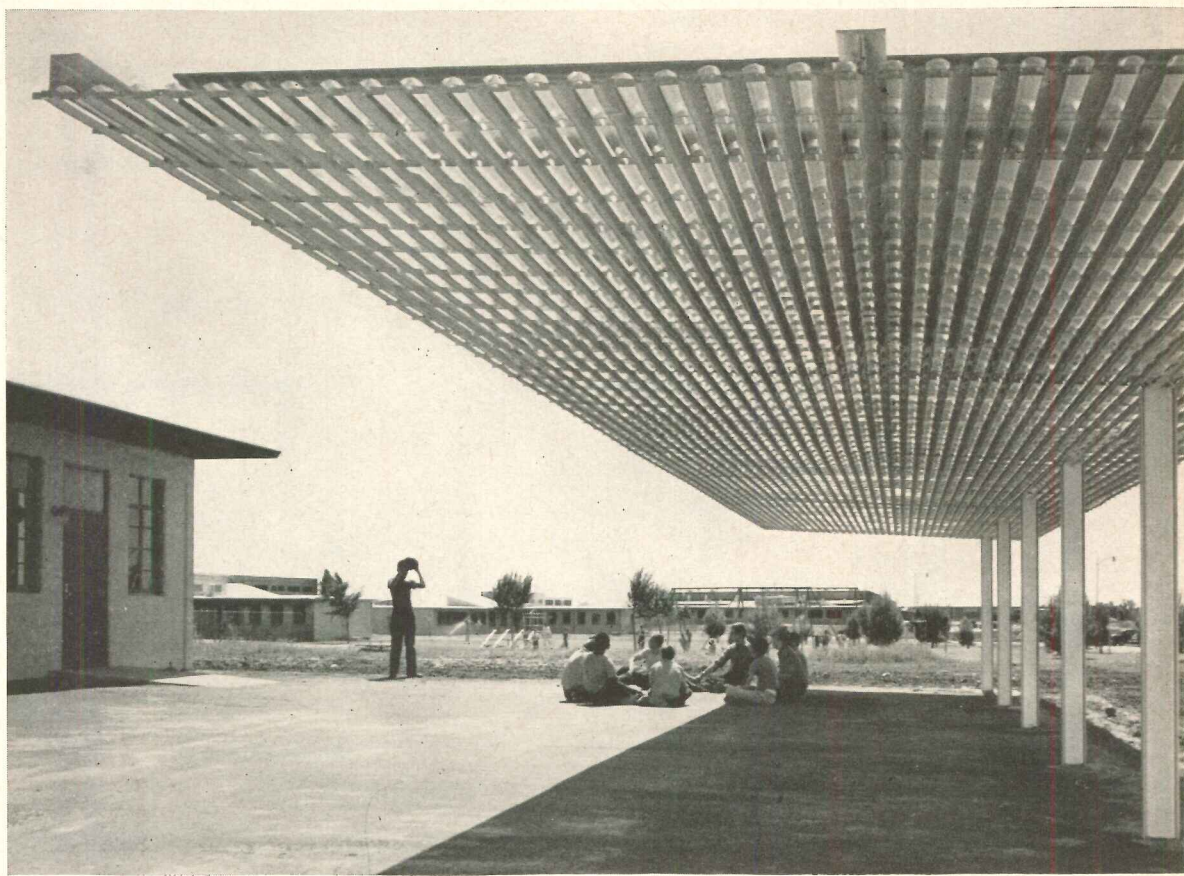

Certain patients in the non-acute wards sleep in dormitory wards; these are only for adult patients

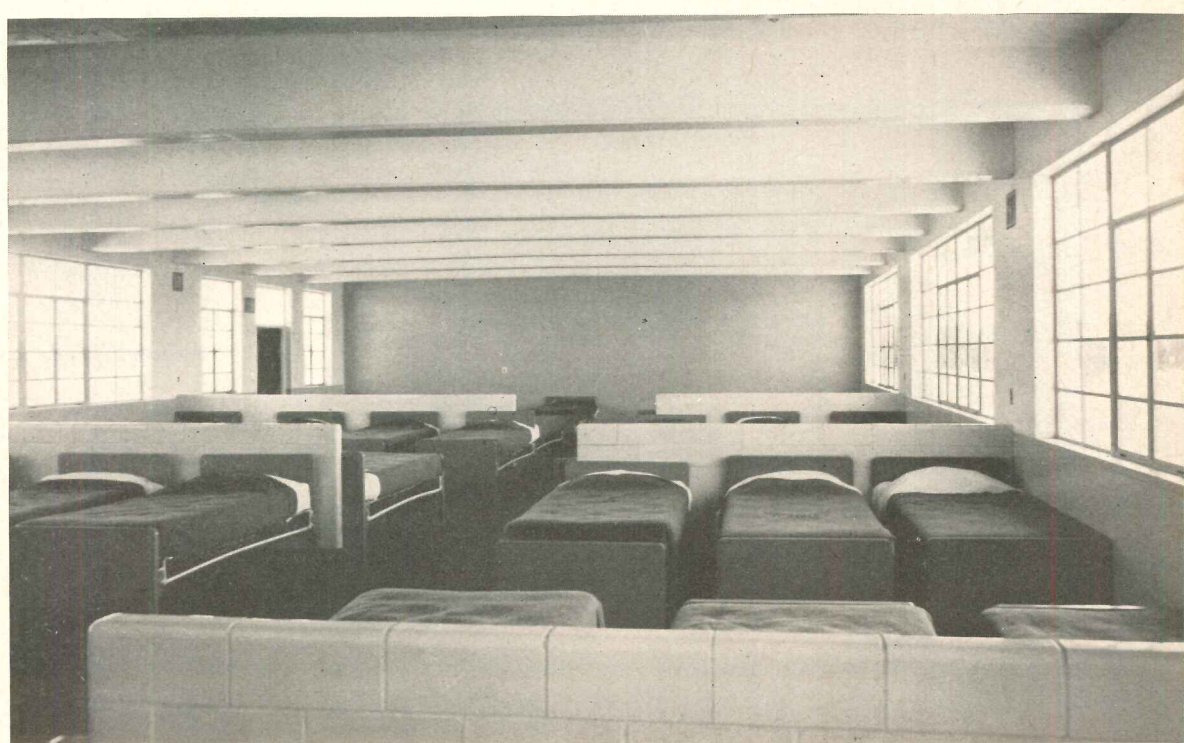

MENTAL HEALTH PAVILION FOR GENERAL HOSPITAL

Jacob L. Reiss Mental Health Pavilion, St. Vincent's Hospital, New York City. Eggers and Higgins, Architects

AUTHORITIES IN PSYCHIATRY place heavy emphasis on psychiatric sections in general hospitals, with a view to early diagnosis and treatment on a voluntary basis. This new mental health pavilion, attached to one of the largest of voluntary medical centers, is unusually comprehensive and complete. It is, in fact, a seven-story addition with a current bed capacity of 90 inpatients plus outpatient facilities. Inpatient treatment is limited to adults, children being admitted only for observation and disposition. All admissions are voluntary, and medical eligibility is based on probable response to short-term treatment. The pavilion has no true medical facilities, since these are available in the hospital. Each patient floor is essentially self-contained, an arrangement believed to be conducive to good therapy. Maximum use is made of a tight site, the top floor being a recreation center, with roof terraces fulfilling outdoor space needs.

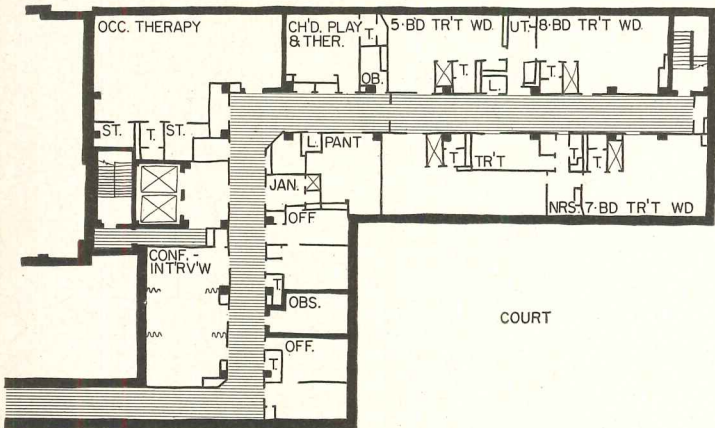

SECOND FLOOR PLAN

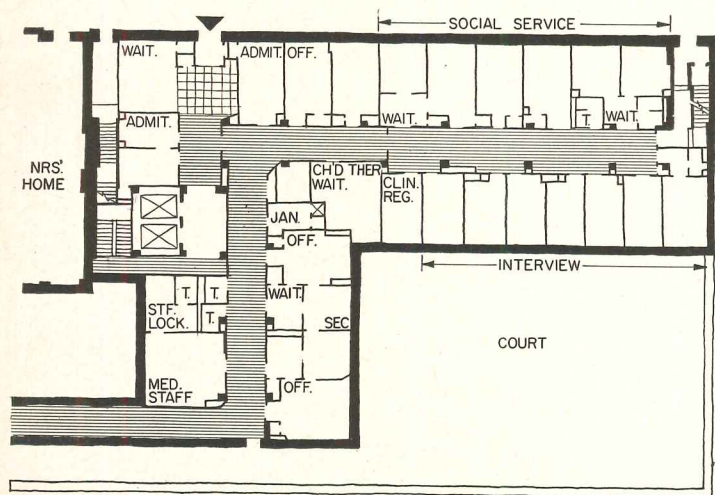

FIRST FLOOR PLAN

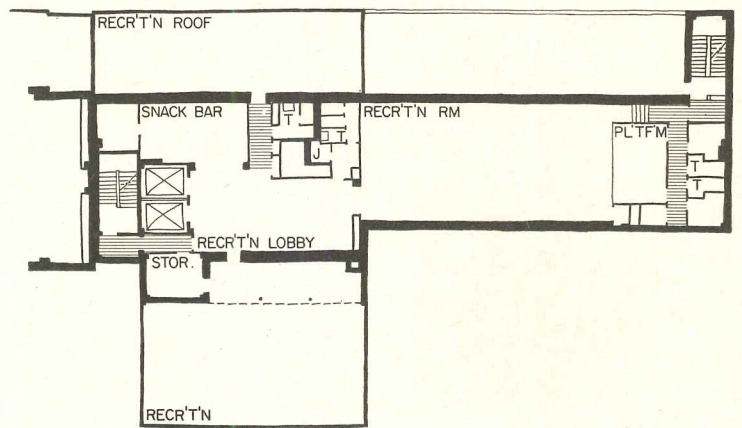

SEVENTH FLOOR PLAN

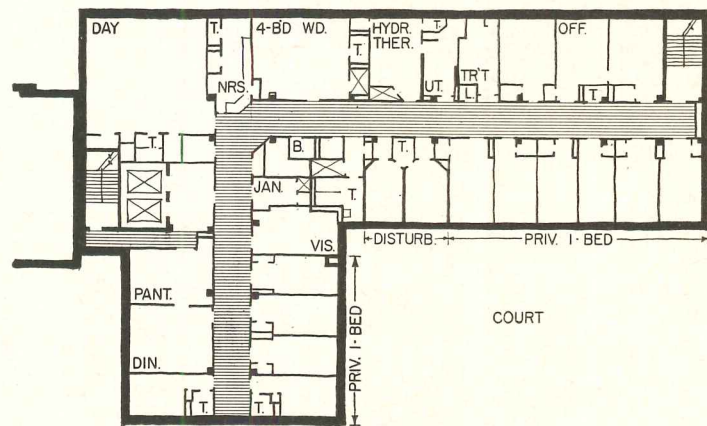

FIFTH FLOOR PLAN



Large dayrooms put patients in homelike surroundings, aid in re-establishing social adjustments

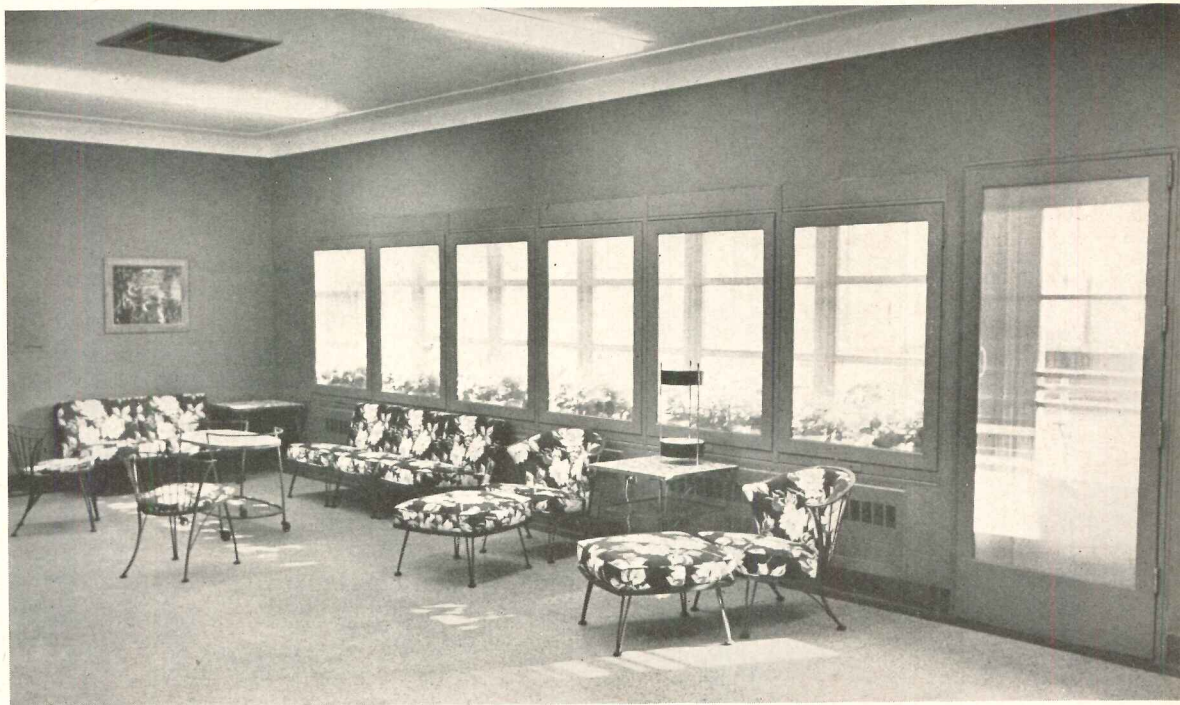

Seventh floor lounge has large planting boxes, opens to two roof decks for use of patients



Two open roof terraces provide protected places for enjoying the outdoors on a big-city site

Typical patient's room; 70 per cent of beds are in single rooms

Each patient floor has its own dining room, to avoid large scale



RECEIVING BUILDING FOR A MODERN HOSPITAL

*Receiving Building for Southeast Louisiana Hospital
Mandeville, La.
Richard Koch, Architect*

AS THE MEDICAL CONCEPT of the receiving and intensive treatment building has progressed, so also has its architectural planning. This is one such building that has progressed quite far. The one-story, spread out scheme keeps the several units at small scale, intimately related to outdoors, especially to interior courts and patios which are developed for patient use. The plan makes it possible to separate patients by sex and by race, as well as by diagnosis and treatment. There is flexibility also in the plan; notice that in the intermediate patient classification section it is possible, by merely resetting corridor doors, to vary the number of rooms in each nursing unit. The three patient classifications in each of the four main groups have separate dayroom, but all are served by a single nurses' station. The central axis makes offices, treatment, recreation, occupational therapy and dining areas available to all patients, also to inpatients from other buildings and to outpatients.

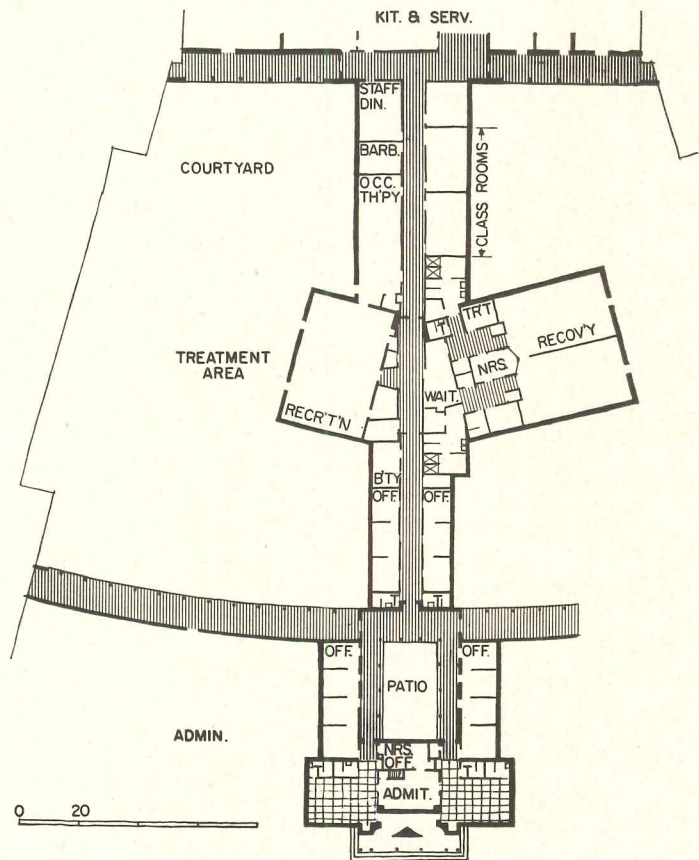
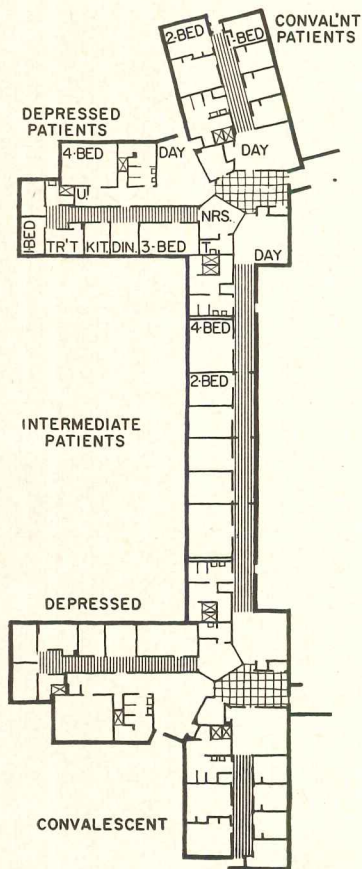

*Just now reaching completion,
it has yet to be landscaped*



*Main entrance, in fact the whole
building, is kept at small scale*



*Central axis contains common
areas for all patients; outer
wings are four separated nursing
units, each with three patient
classifications*

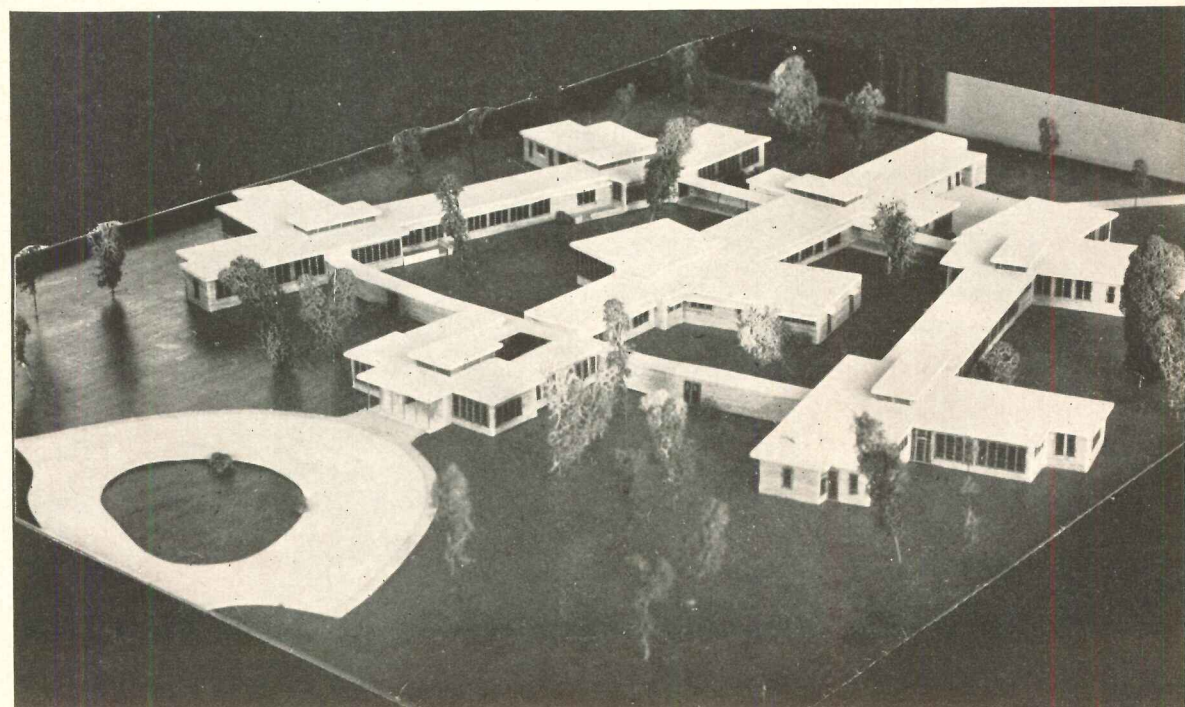

RECEIVING BUILDING FOR A LARGE HOSPITAL

SOME YEARS AGO the State of Minnesota commissioned these architects to plan complete replacement of the Rochester State Hospital, housing 1500 patients. The already excellent site was added to on three sides and the target established as "the last word in mental hospitals." The Receiving Building here illustrated was one of the first units to be built, the hope being, of course, that a large proportion of patients admitted will come here, be treated intensively and discharged, without ever entering the continued treatment buildings. While this receiving building has dayrooms and recreation and occupational therapy space, the overall plan calls for a separate group of buildings for patients' recreation, occupational therapy shops, library, and so on, plus extensive outdoor recreation facilities. Rising building costs have hampered the program, but it is proceeding toward completion as new funds are made available.

Rochester State Hospital, Rochester, Minn.

Ellerbe and Company, Architects and Engineers

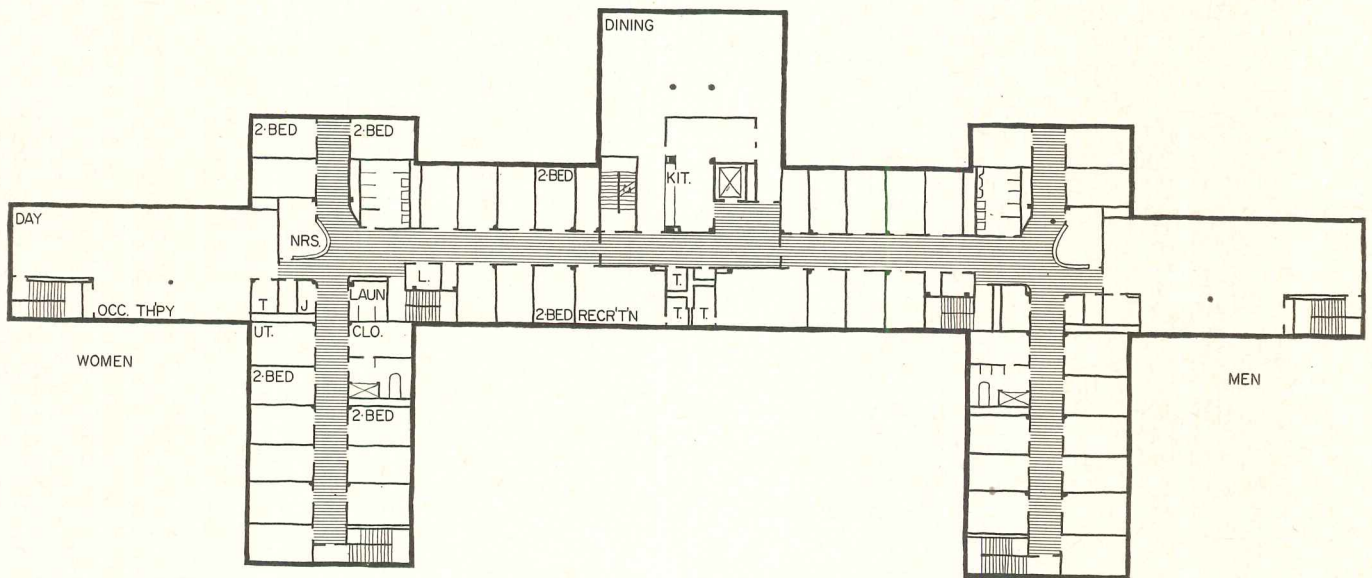

SECOND FLOOR PLAN

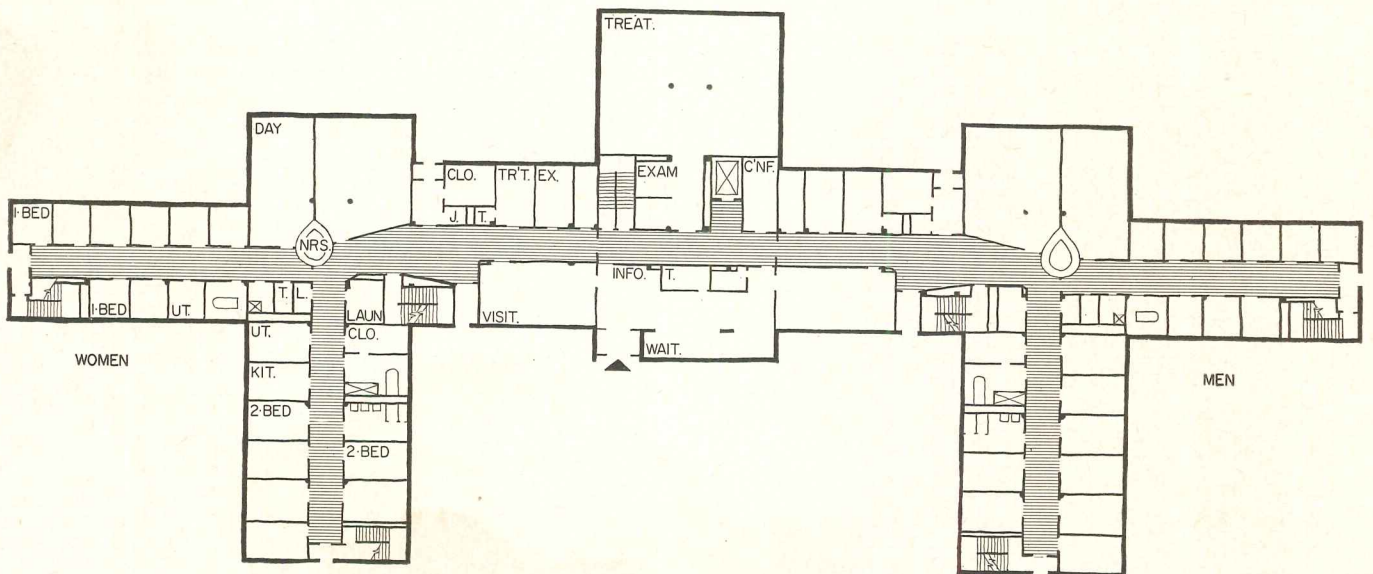

FIRST FLOOR PLAN

0 20



Receiving Building is in concept two T-shaped hospitals, one for men, one for women, joined by common facilities in the center



Women's dayroom on second floor is large, and has pleasant outlook



Master plan has central group of receiving building, medical hospital, recreation and service buildings, five continued treatment buildings, and, at right (not in this program) two for geriatrics

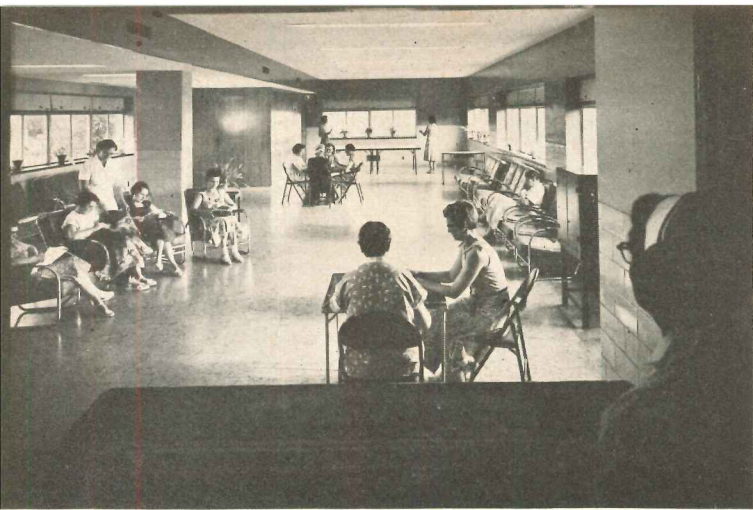

Clark Dean-Infinity, Inc.

MENTAL HOSPITALS

Dayroom in women's section adjoins nursing station for easy control



Dining room is a common facility joining men's and women's sections

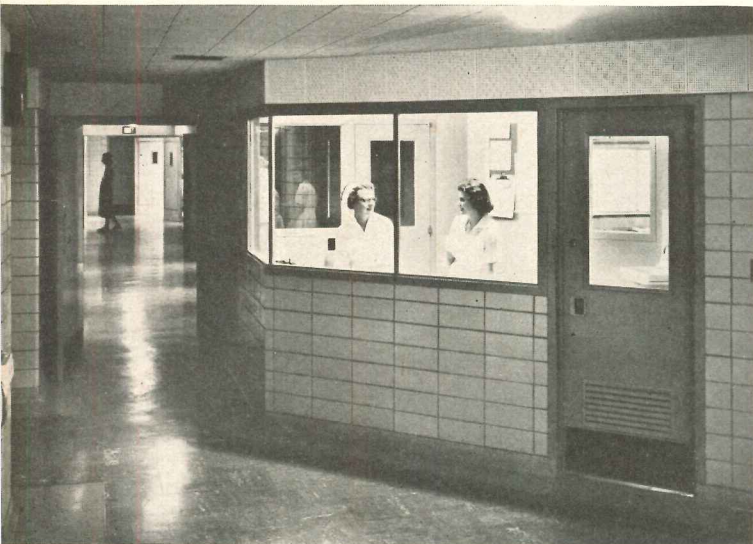

Nurses' station at joint of the T has good visual control four ways



Patients under shock treatment are closely attended in central area

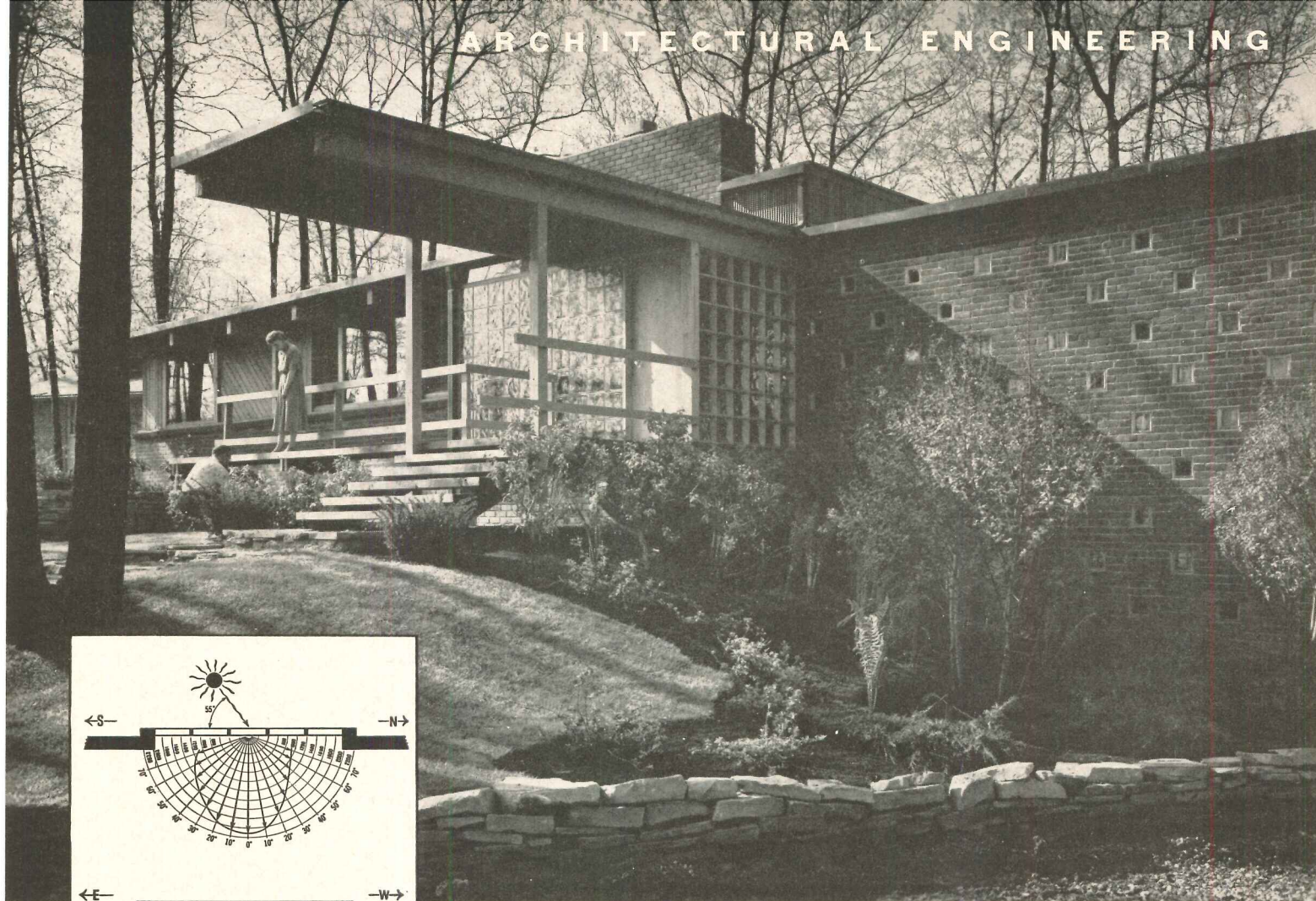

All photos by Hedrich-Blessing

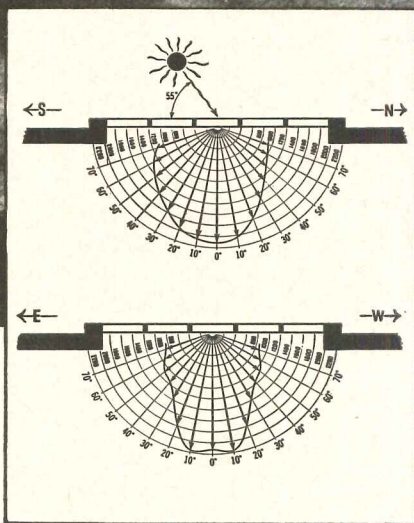

DAYLIGHT RESEARCH HOUSE

Architect Harris Armstrong has designed a "brightness-controlled" house for the well-known daylight-researcher Robert A. Boyd

GOOD VISUAL ENVIRONMENT, it has been said, is one in which the brightness of all interior surfaces and views is substantially the same. Much experimentation has been done to achieve this ideal of daylighting in schools and in industry, but it has been largely ignored in residential construction. This lack has been remedied at last by what has been called "the most perfectly daylighted dwelling yet constructed"—and happily enough, it was built for a man who, perhaps better than anyone else, can appreciate and analyze its technical as well as its esthetic aspects; Dr. Robert A. Boyd, head of the Daylighting Research Laboratory of the University of Michigan.

Dr. Boyd has been living in his "perfectly" daylighted house since last spring. Aside from his own personal satisfaction with the quality and quantity of light admitted to the house, Dr. Boyd,

as a scientist, has been conducting continuing studies on the house so that he can have figures as well as enthusiasm to prove its "lighting comfort." By far the most significant fact to be noted in his data is the remarkable brightness control attained. In conventional homes, where daylighting is achieved through normal window arrangements, the daylight illumination in remote areas is only 1 or 2 ft-candles, and the brightness ratio between these areas and the source of light is extremely high. In Dr. Boyd's house, as can be seen from the figures tabulated on the following pages, the brightness ratios are very low—generally lower even than the 15/1 recommended for close visual tasks.

Both side lighting and overhead lighting have been used to achieve the feeling of "relaxed living" described by Dr. Boyd on pages 236 and 237. Toplite glass block panels, which have a low

roof silhouette, were used in the living room, the study, the kitchen and in the interior bathroom to provide adequate illumination for areas that would be poorly lighted by wall fenestration only. These panels, which consist of hollow, hermetically sealed glass units set in an aluminum grid, are selective in their transmission of daylight. They transmit 20 per cent of the winter sunlight but only 8 per cent of the summer sunlight (see drawing on page 236). This transmission of direct sunlight is accompanied by a higher transmission of light from the sky as a whole. The charts above show brightness for observer's angles of view in the north, south, east and west planes for a sun altitude of 55 deg.

For wall fenestration, both plate glass and wall blocks have been used. Wall blocks appear in one bedroom, the outside bathroom, the kitchen and as a clerestory in the living room. These

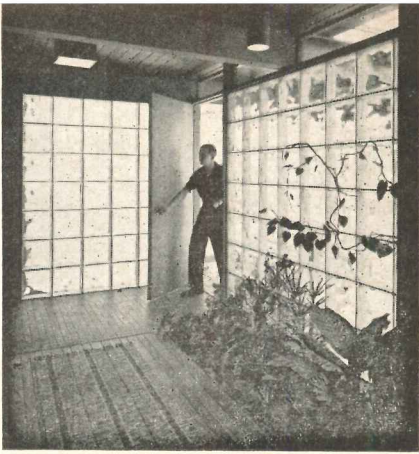

DAYLIGHT RESEARCH HOUSE

blocks incorporate the same prismatic light-rejecting principle as the overhead panels, except that the maximum rejection of direct sunlight occurs for a sun altitude of 45 deg, which is the most severe sun position for vertical surfaces. Where blocks cover almost the entire surface of a wall, some provision is made for a ventilation opening. For example, in the bathroom two casement windows are installed above head level, and in the kitchen a jalousie window is built into the block wall at the far end. Two interesting block effects that are utilized in the kitchen are the treatment of cabinet interiors to take advantage

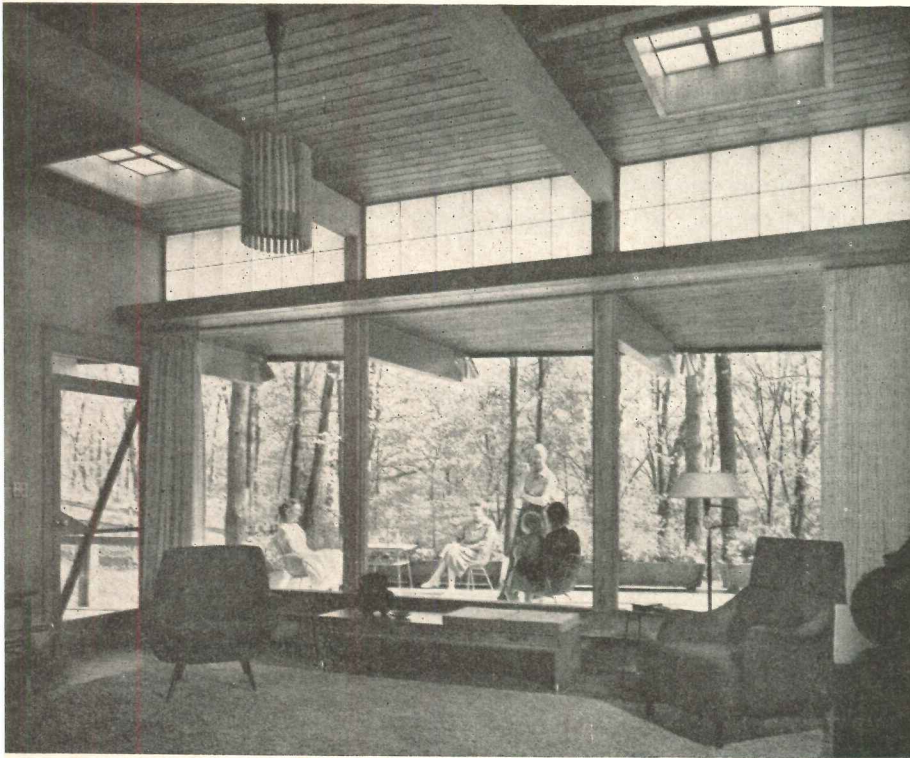
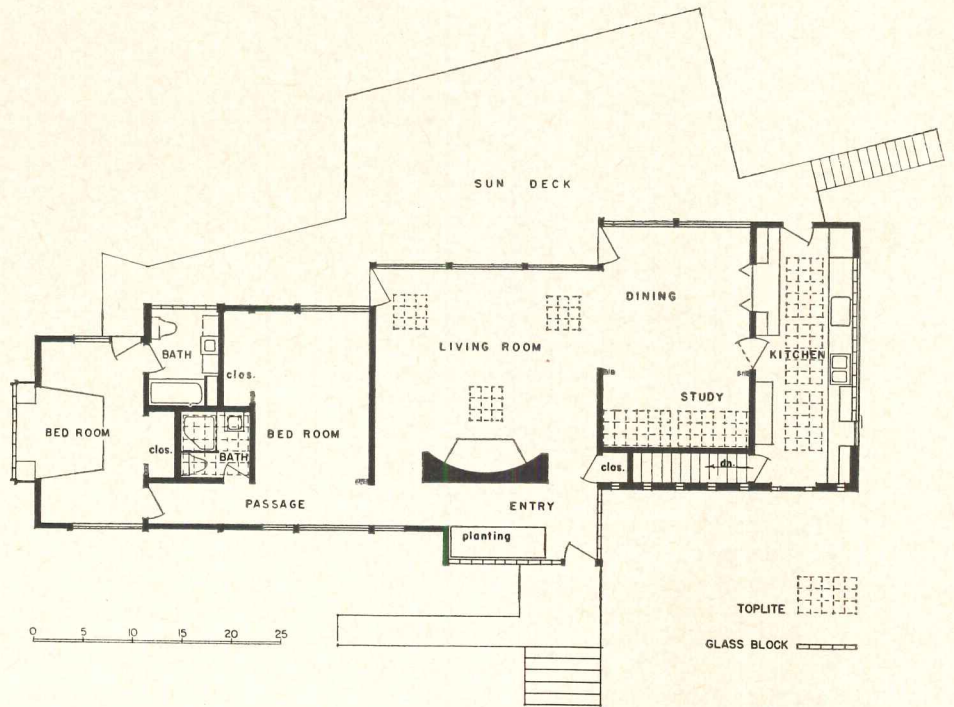

LIVING ROOM

	Illumination (ft-candles) (5 general, 20 at lamps)	Chair Near Fireplace	Chair Near Window	Brightness (ft-lamberts)				Ratio of Brightness to Avg. Illumination			
				Toplite	Clerestory Block	East Wall	Window Wall	Toplite	Clerestory Block	East Wall	Window Wall
Clear Day	10 a.m.	35	35	680	150	20	100-300	19/1	4.3/1	1/1.7	8.6/1
	Noon	65	60	850	700	30	100-300	14/1	11/1	1/2.1	4.8/1
Overcast	2:30 p.m.	20	40	500	150	15	60-250	17/1	5.0/1	1/2.0	8.4/1

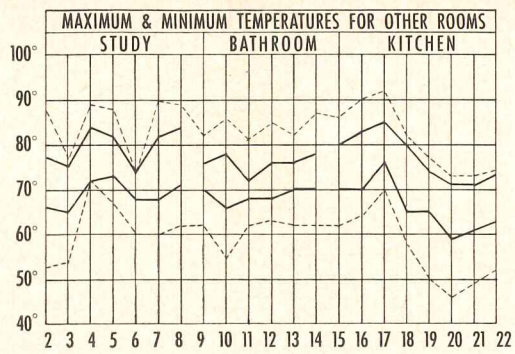
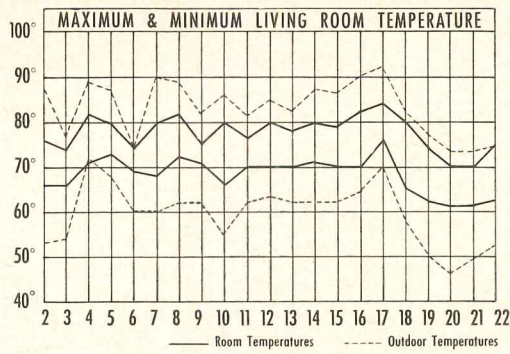

Temperature charts show slight variation of indoor air temperatures compared with outdoors from August 2 to August 22

of the wall of light, and of the north wall, in which blocks not only add to the total lighting of the room but also provide a unique architectural effect on the front of the house.

In addition to the careful planning and placement of daylighting facilities, the house has been adapted to its surroundings so as to take maximum advantage of "built-in" brightness controls. The main view from the living and dining rooms into the ravine is principally due south, but the trees provide a low angle brightness control, and the overhang controls the entrance of direct sunlight during the summer months. The

clerestory above the overhang admits controlled daylight for indirect lighting of the ceiling. Since the prismatic blocks in the roof and walls transmit a higher percentage of the direct sunlight and solar heat during the winter months than during the summer, there should be an appreciable solar heat gain during the winter.

The figures for illumination and brightness stripped in below were tabulated on two days in August — one a clear day and the other an overcast day. Two sets of figures were collected for the clear day: one at 10:00 A.M. and the other at noon, when the sun is most

intense. The brightnesses given for window views represent the variation caused by the changing density of the foliage. The figures given in parentheses after Illumination are illumination levels for just electric lighting. Thermometer readings were taken constantly during the days that the illumination data were recorded, and the charts of these readings are shown above. The graphs show that the variation of indoor air temperatures is considerably less than the variation of outdoor temperatures. When the readings were taken, all doors and windows were open during the day and only the windows at night.

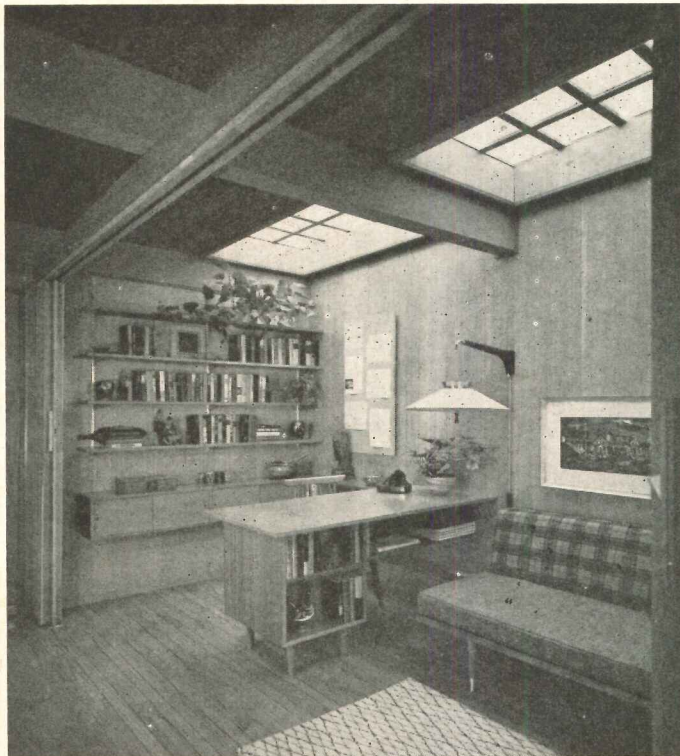

STUDY AND DINING ROOM

Illumination (ft-candles)	Brightness (ft-lamberts)		Ratio of Brightness to Illumination		
	Table (20 at table)	Desk (40 at desk)	Dining Window View	Study Toplite	Study Window View
20	100	100-300	850	25	100-300
20	110	100-300	800	35	100-300
15	60	60-250	420	25	60-250

DAYLIGHT RESEARCH HOUSE

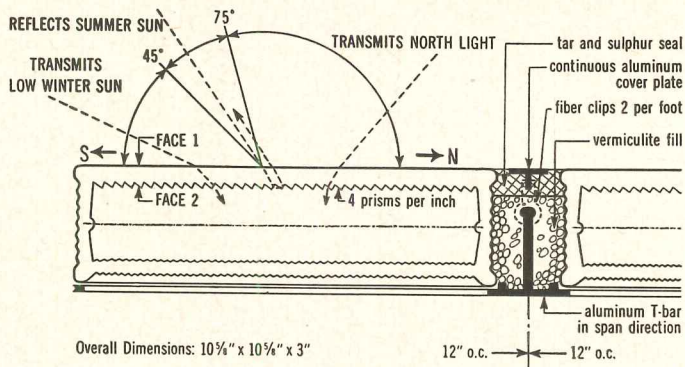

Dr. Boyd gives his reactions to living in the Daylight Research House

CONSIDERING THE FACT that daylighting, and the advantages of proper daylighting, are the things with which I concern myself daily, it's easy to understand that I might reasonably have some qualms about being completely objective when I talk about how it feels to live in what must certainly be the most perfectly daylighted dwelling yet constructed.

Happily, however, the house is honestly providing me — and Mrs. Boyd — with pleasures and advantages which go even beyond those I had foreseen on the basis of strictly scientific reasoning. Typical of those unexpected advantages,

perhaps, is the sense of relaxation I experience in the house, an almost complete release of tension which I feel can be attributed directly to the low brightness ratios effected by the daylighting techniques employed. The abrupt physical adjustment which a person makes, unconsciously but constantly, between bright and shaded areas in the conventional home must have a mental side-effect which is certainly no help to tension and which may, in fact, produce it. The even, glareless effect of daylighting in this new house is apparently conducive to the easing of tension.

Visitors have definite reactions to the

daylighting effects in the house. One which causes considerable comment is the realistic touch which daylighting gives to the decorating scheme. Daylight seems to pick up and accent the touch for which the decorator was striving.

Another visitor reaction is the realization that in this house there are no dark corners. Comments usually follow a pattern: first, that there's something different about the house on which they can't quite put their finger, and then the realization that dark corners are missing. They aren't conscious, at first, of any unusual lighting conditions.

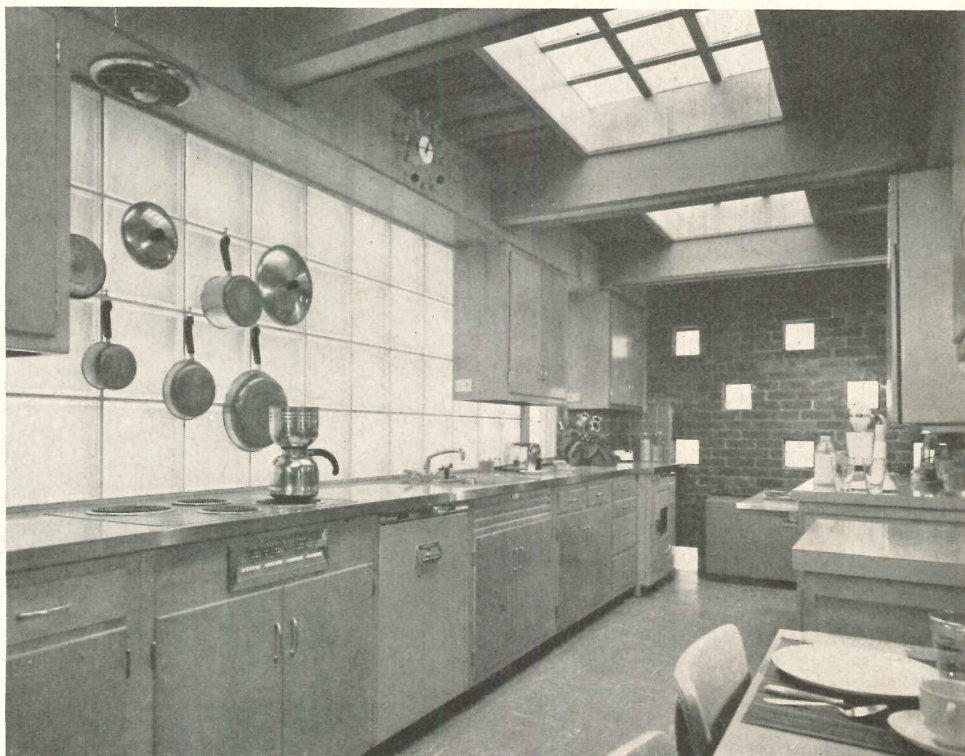

KITCHEN

	Illumination (ft-candles) (22 general)	Breakfast Counter	West Side Work Counter	Brightness (ft-lamberts)			Ratio of Brightness to Avg. Illumination		
				Toplite	Wall Block	Cabinet	Toplite	Wall Block	Cabinet
Clear Day	10 a.m.	75	100	1000	75	25	11/1	1/1.2	1/3.5
	Noon	115	135	1000	90	25	8.0/1	1/1.4	1/5.0
Overcast	2:30 p.m.	50	80	420	100	15	6.5/1	1.5/1	1/4.3

Back of house faces south. Overhang protects open porch and shades floor-to-ceiling glass wall of living room; clerestory provides selective light. Block wall lights bathroom

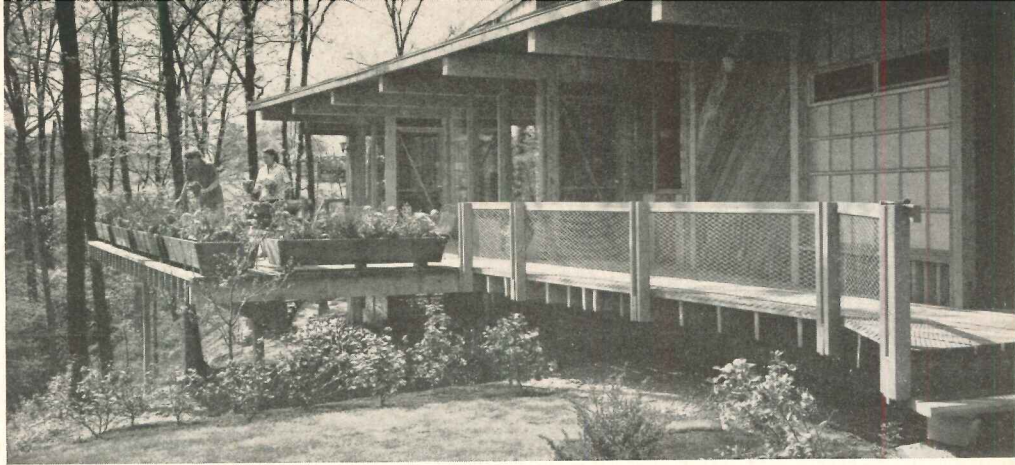

Once they do realize that even lighting is responsible, they don't understand how it's being achieved until it's pointed out.

One of the most pleasant and increasingly apparent conditions in the house is that brightness is so much more comfortable — or rather, perhaps, that brightness in the uncomfortable sense just doesn't exist. Bright, sunny days, which might in a conventional house cause sharp brightness ratios and resultant discomfort, are no different in this house from softly lighted, overcast days. Interior illumination merely rises or falls to match exterior conditions, and the

brightness ratio remains fairly constant.

Mrs. Boyd and I have had specific reactions to certain features of the house which I think might be interesting.

She is especially pleased with her kitchen and the light source, without brightness, provided by the extensive panel of solar-selective glass block used in the west wall over the work area. She much prefers it to having a vision port in the same area because such an opening would effect excessive brightness. Another factor which contributes to an elimination of excessive brightness in the kitchen is, of course, the overhead daylighting. The diffused daylight from

the overhead panels illuminates areas which otherwise might provide distracting brightness ratios.

One of my personal reactions is particularly amusing. I've been impressed by the results obtained with the use of Toplite in the interior bathroom, where the only source of outside light is from overhead. Here, even on the darkest days, I find it unnecessary to use artificial illumination for a "close-work task" like shaving. I can't help but be amused when I find myself, even after six months of living in the house, automatically reaching for the light switch after I've finished with the razor!



BEDROOM AND BATHROOM

Bedroom Illumination (ft-candles) (3 general, 25 at vanity and dresser)	Near Bed	Bathroom Illumination (ft-candles) (20 general)	Brightness (ft-lamberts)	Bedroom Window View	Bedroom Block	Bathroom	Ratio of Brightness to Illumination	Bedroom	Bathroom
								Window View	Block
15		10		100-300	45	50	20/1	3/1	5/1
15		15		100-300	40	50	20/1	3/1	3/1
15		15		60-250	25	40	17/1	2/1	3/1

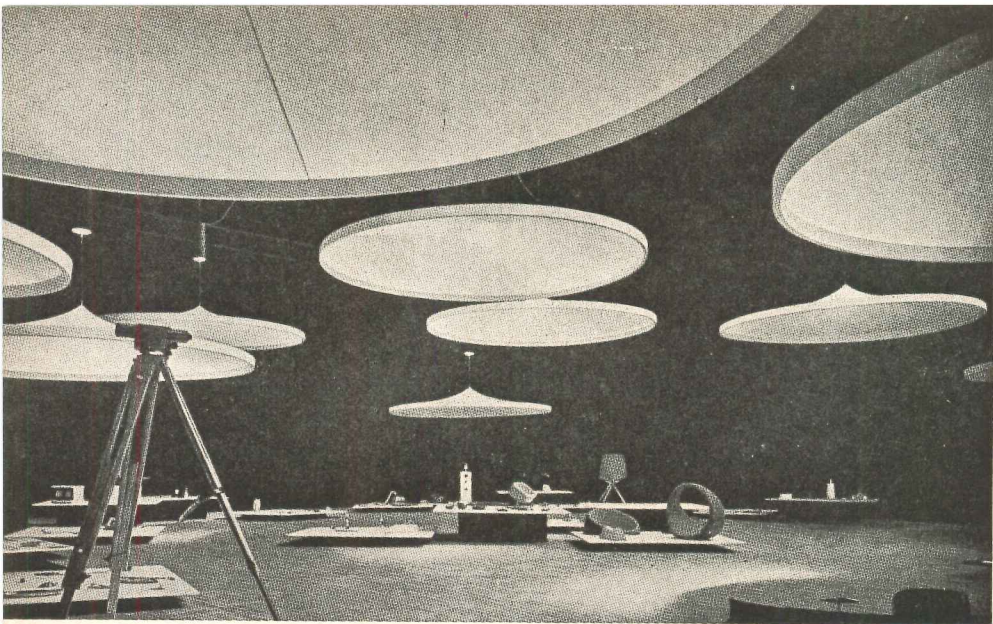
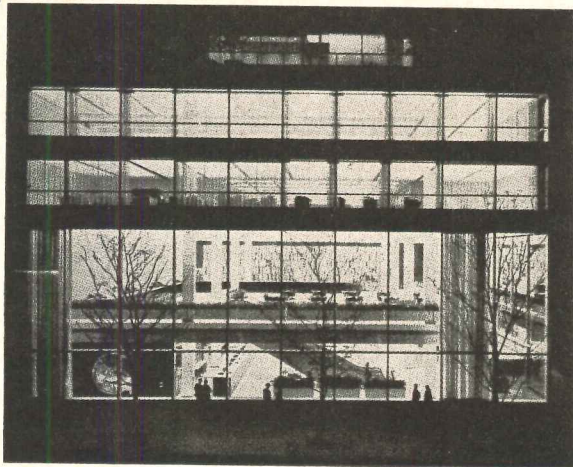
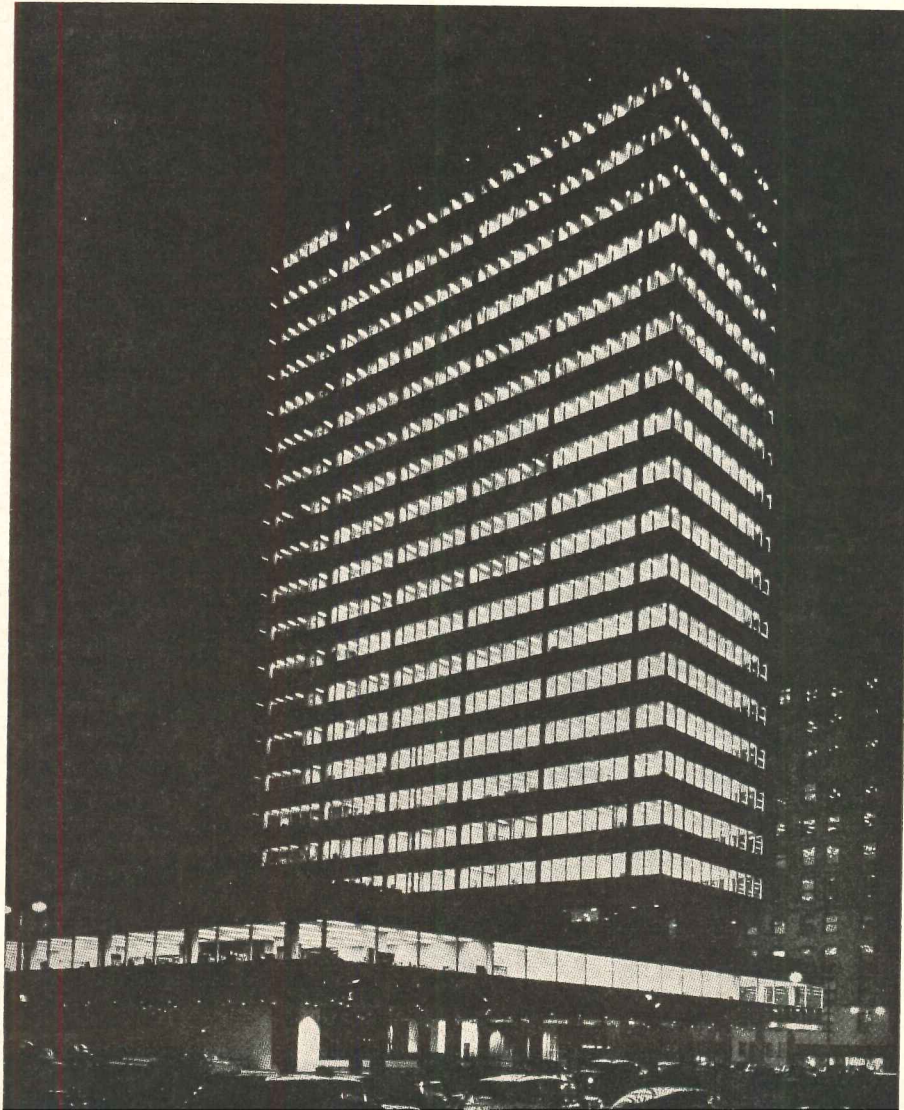

Exhibit at the 10th Triennale in Milan. A. and P. G. Castiglioni, Architects



Lever House. Skidmore, Owings and Merrill, Architects



Manufacturers Trust Co. Skidmore, Owings and Merrill, Architects

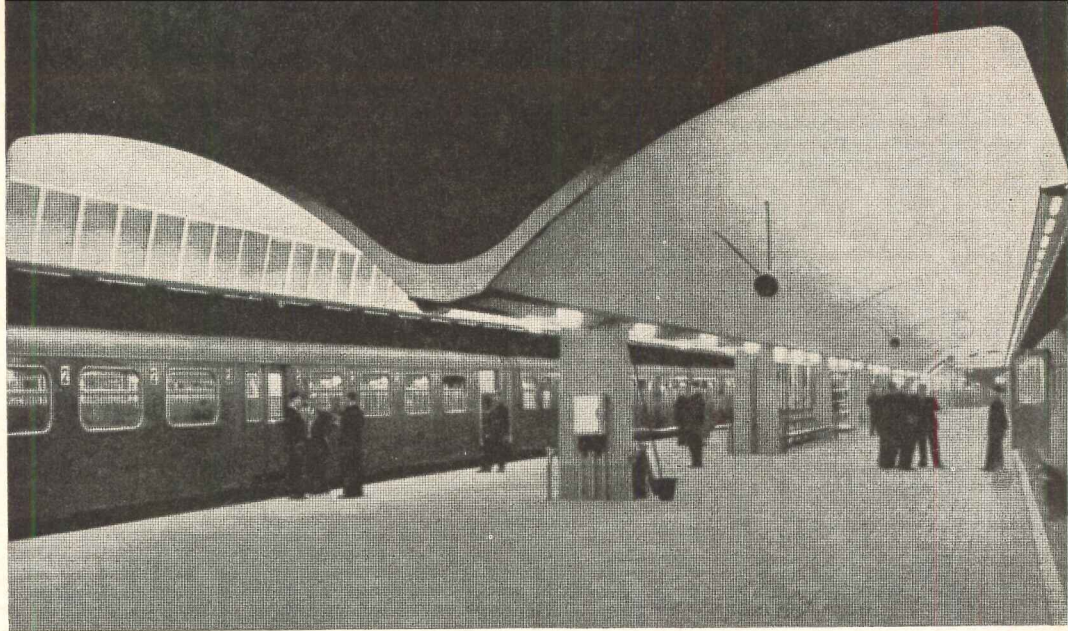

Main station in Rotterdam. S. v. Ravesteyn, Architect

LIGHT AS A DESIGN MATERIAL

A changing attitude toward the lighting of buildings can be detected, a shift in emphasis toward the emotional and form-giving values inherent in the medium. An examination of the art today is followed by reviews of a new book and an article on the subject

THERE ARE SIGNS of increasing interest in lighting as well as a certain dissatisfaction: with its emotional use to provide serenity or excitement, warmth or coolness, and with its use to delineate form, emphasize texture, enhance circulation, etc. Functional requirements have been pretty well emphasized, recognized and practiced, even though there is some disagreement between architects and engineers concerning the premises of certain existing standards. The desire is growing, however, among architects to exploit the use of *light as a design material* rather than to provide merely for "seeing."

The problem is involved and many-faceted. Certain things are apparent, though. Most architects have not yet made lighting a part of their building vocabulary as they have shapes, masses, structures, and, more recently, acoustics. Now many architects, in cooperation with consultants, think of acoustics from the beginning of design, not only in connection with special rooms such as auditoriums, but from the outside in, to the extent that rooms are located and often shaped on the basis of acoustical considerations.

Lighting is not exactly a parallel situation in that many times acoustical

principles are employed solely to prevent annoying distractions (although this has been the basis for much of lighting design in the past few years). Designs have been calculated to prevent glare, bad reflections and so on. Lighting can, but doesn't very often, provide pleasurable sensations. Why isn't light more successfully used to (1) create mood, (2) stimulate responses, (3) work with interior and exterior surfaces so as to accent them or play them down, and (4) implement the plan by aiding circulation through spaces? An appraisal of the current situation in lighting appears to be about as follows:

While the talented architect may often have definite and worthwhile ideas as to what he wants the lighting to accomplish in a building, the results frequently fall short of the intended purpose. Perhaps one reason for this is that lighting for "design" effects lends itself only partially to rational analysis. Architects need to know more about human responses to light and color. Then it seems that many architects choose lighting systems on the basis of which fixtures have the best (or in some cases the least offensive) appearance. And since this has become their criterion for judgment, they have not acquired a

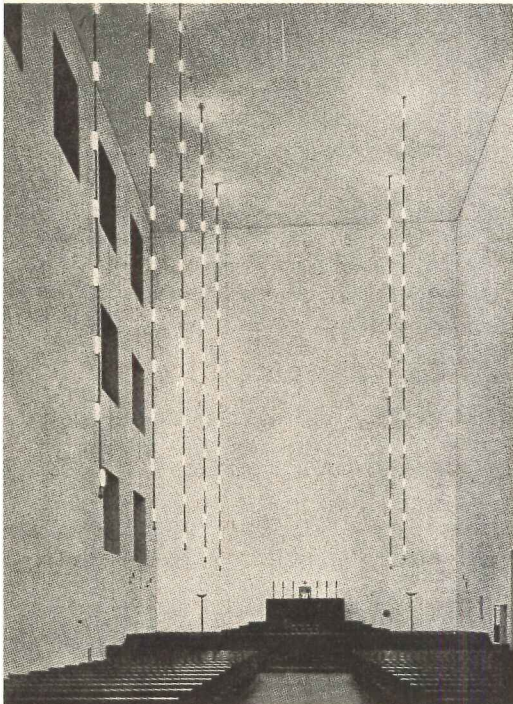

Corpus Christi Church in Aachen, Germany. R. Schwarz, Architect

All illustrations are from the book, *Lichtarchitektur*, just published in Berlin, which is reviewed on page 241 by G. B. Gusrae

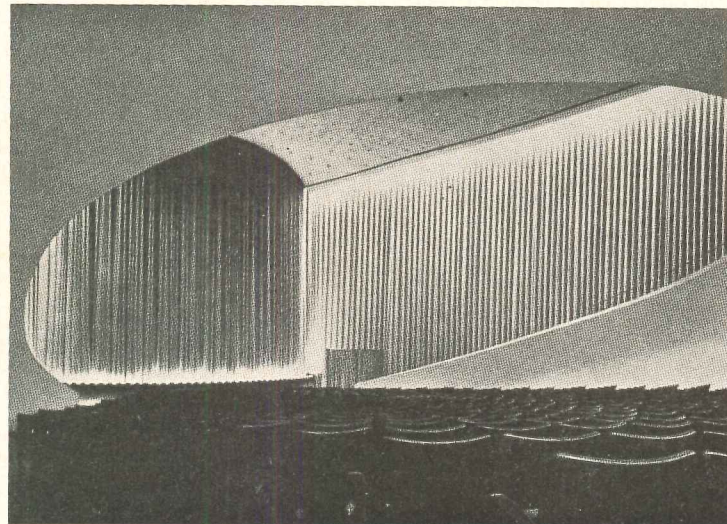
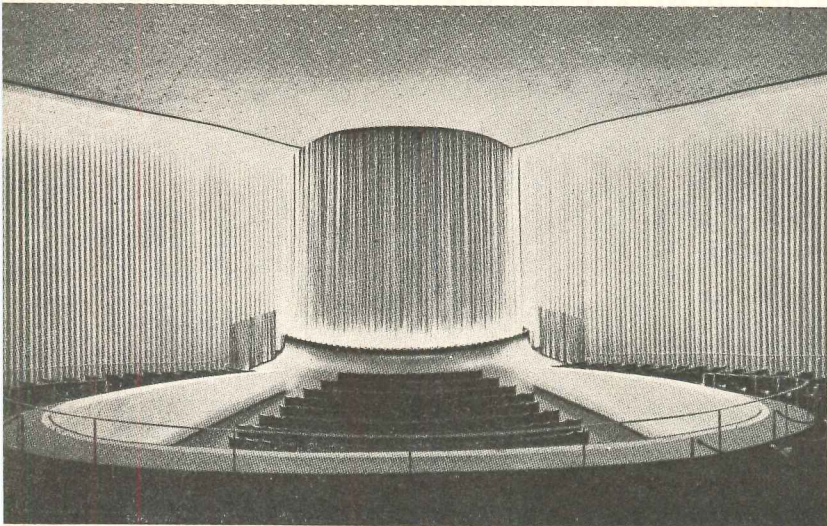

Film theater in Nurnberg. P. Bode and Fr. Reichel, Architects

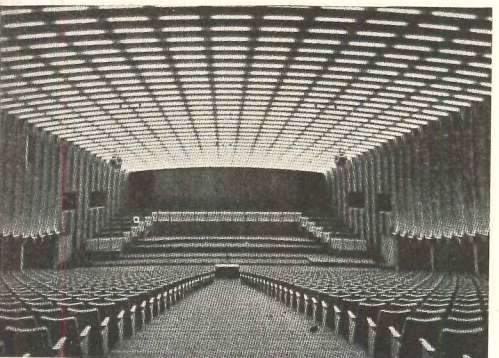
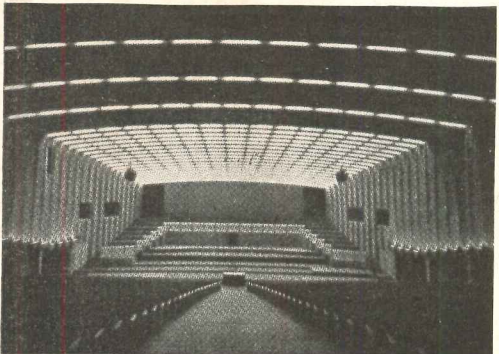
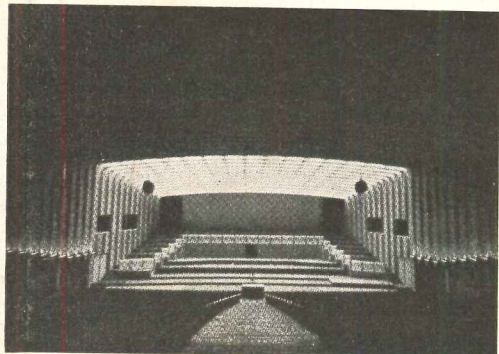

Orchestra broadcast studio
in Frankfurt a.M. G. Weber, Architect

LIGHT AS A DESIGN MATERIAL

general knowledge of how various light sources perform in the way of distribution, brightness, glare, etc.

The engineer has been concerned mainly with lighting efficiency, distribution, intensities needed for various critical tasks, and brightness problems. Eye comfort has become his principal criterion for good lighting. He thus may not be sympathetic to the architect's wish to make lighting a positive contribution to the whole design.

What about the stage lighting designer; can he help? No doubt he can draw on his experience in achieving dramatic effects. But it must be realized that the stage lighting designer is working with a completely controlled situation. He doesn't have to worry about the effects of heat and brightness of his spotlights on the actor; neither does he have to be concerned with the same sort of economy as the architect. One designer put it this way, "On the stage we are after efficiency of effect, whereas in buildings the architect wants efficiency of operation." So while the lighting designer is an expert in creating tech-

nically an emotional framework, he cannot, on the basis of this experience alone, appreciate fully building requirements.

Within the past several months, two pieces of writing have appeared which bear directly on this dilemma. The need to consider light as a basic component in architecture has been expressed in 113 pages of atmospheric photographs and 112 pages of text and instructive photographs in the book *Lichtarchitektur* by Dr. Walter Köhler and Wassili Luckhardt¹. A review of this book by G. B. Gusrae follows.

Suggestions as to how the current situation might be improved through new concepts in the education of architects and lighting engineers have been proposed by an architect, Derek Phillips, in the September issue of the *Journal of the Royal Institute of British Architects*.² The author not only has very accurately put his finger on the problems discussed above, but suggests a number of remedial measures which seem both logical and achievable. A condensation and excerpts from the article appear on the next page.

¹ *Lichtarchitektur*, by Dr. Walter Köhler (*Light and Color as Elements of Architectural Planning*) and Wassili Luckhardt (*Idea and Creation of the Sequence of Illustrations*), 232 pages with 226 illustrations, and 52 drawings, published by Bauwelt Verlag, Berlin.

² "Lighting of Buildings—Training and Practice," by Derek Phillips, *The Journal of the Royal Institute of British Architects*, September, 1956.

INTEGRATION OF LIGHT INTO ARCHITECTURAL DESIGN

A review by G. B. Gusrae of the German book
"Lichtarchitektur," authored by Köhler and Luckhardt¹

The thesis "light determines architecture,"* is so audacious that undoubtedly there are many who would reject it at once on the grounds of its one-sidedness. It would be natural to argue that stone, brick, steel, concrete, glass, and the many functional equipments equally affect and determine architecture.

On the other hand, few would quarrel with Dr. Köhler's modified and more palatable premise that light must be carefully considered as an important factor in modeling a space. The development of light sources has reached an advanced stage, and the application of these sources to architectural lighting on a purely functional basis is well defined. Lighting, to be of greatest use, must step over the functional lines to take its rightful place at the side of architecture in creating new forms related to man who is physically, physiologically and psychologically an "optical being."

It cannot be denied that architecture must have light for its expression. It is equally true that light cannot stand isolated: it must have the architectural

*Köhler says this thesis was introduced 25 years ago by Joachim Teichmüller.

surfaces, the materials and the textures to prove itself. It follows that the ultimate in architecture can be obtained only when there is a marriage between the two arts: the art of creative spatial design and the art of lighting, the modifying agent which can create by the play of light and shadow, a gain or a loss in the intended effect.

Heretofore, "Architekturlicht," the art of architectural lighting, has only considered the functional aspect of light in spaces. The author proposes that "Architekturlicht" graduate into "lichtarchitektur," light architecture or the integration of light into the architectural design to obtain specific effects over and beyond the purely functional.

The complementary relationship between light and architecture is illustrated well in the book by photos which show the directional effects of light on a checkerboard pattern of small cubes. The various facets of this relationship are explained further through some theoretical considerations of natural lighting, of optical illusion and psychology of color. The sum total is applied to a variously lighted synthetic structure where, in turn, effects of stability, disorder and several spatial

relationships are obtained depending upon the type and location of the light source.

It is perhaps disappointing that the author's premise, begun so auspiciously, is largely limited to a discussion of the application of artificial light to interiors and the effect of such application upon the building exteriors at night. He does not delve into the uses of natural light or manner of control. This may be understandable, considering the fact that only recently have successful attempts been made to control natural light scientifically, and that most engineers' experience is confined to electrical illumination.

Nevertheless, the premise is stimulating. It may lead to the concept that from the architectural viewpoint, natural and artificial lighting sources are related and should be linked together in their application to the architectural art. The architect and the lighting engineer may join hands, the one applying the principles of lighting in the initial stages of building design and the other applying his lighting knowledge in relation to a newly acquired sensitivity towards architecture. The current concept in the lighting art that it is only required to obtain the absence of discomfort to provide comfort, may be replaced by the desire to combine light, color and shape to produce a structure, a "thing of beauty that is a joy forever."

AN APPROACH TO IMPROVE LIGHTING DESIGN

Condensation and excerpts from an article
by Derek Phillips in the R.I.B.A. Journal²

Buildings where artificial lighting offers a positive contribution to architectural unity are the exception rather than the rule, says Derek Phillips. He feels that the root of this trouble is the lack of understanding on the part of both architects and lighting engineers of each other's approach. The remedy for this, he believes, is to start right at the beginning with the courses these groups are taught in school. He suggests that the architect needs to know more about the scientific problems related to man, since his training already is directed toward an appreciation of man's esthetic needs and the psychological values implicit in design. The engineer, on the other hand, not only lacks training in this direction, but also needs to know more about some of the practical problems involved in buildings including structure, mechanical services, modular coordination and interior decoration as they relate to lighting.

The author has written an extremely thoughtful statement on the role of lighting in buildings in the following paragraphs:

"In general there may be more overriding considerations of planning, structure, and economics which will dictate the form of the building; but there are occasions when these more practical aspects of a building become second in importance

to the purely formal qualities when light may be used to assist in modelling a space, to create positive impressions for functional or esthetic reasons. In such cases as this, the structure may be modified to accept light in a specific manner to gain an architectural effect; similarly, all lighting equipment itself, whether a decorative chandelier, or some form of lighting closely integrated with the structure, has its own formal quality over and above the functional lighting job that it is called upon to perform.

"... Lighting design [cannot] be studied in isolation, for although there is no architecture without light, it is equally true to say that there is no lighting in buildings without the surfaces and edges of the materials of which they are made. The study of lighting must relate light to materials, color and those other elements of design, such as structure, with which the architect is concerned."

The list of subjects the author proposes for the architect's study are as follows:

- a. Characteristics of natural and artificial light sources, their spectral qualities. Illumination levels and economics, and the special characteristics of sunlight.
- b. Criteria for lighting design.
- c. Methods of light control and optical systems.

Principles of window design and design of lighting fixtures. Materials and additive and subtractive mixture of color.

d. Physical properties of surfaces.

e. Simple calculations for design of both artificial and natural lighting.

f. Methods of installation related to structure; methods of electrical distribution.

Concerning the lighting engineer's training, not only should he know what characteristics of lighting inhibit vision and cause discomfort, but he should be cognizant of the ways in which positive comfort or delight can be produced. Therefore, in addition to the purely theoretical studies of light, the author suggests the following subjects for the engineer's curriculum:

a. Elementary psychology, with emphasis on its application to vision.

b. Subjective study of man's reaction to different light sources and the effect of their geometry and color on form.

c. Theories of esthetics.

One of the stumbling blocks in the way of good lighting is the lack of fundamental criteria for the illumination of a variety of objects. In some instances, for example lighting of jewelry, we may know the different effects achieved by the geometry of the illumination, intensity, color and temporal characteristics. But this type of information may not be available for other cases such as machine dials, food, and lighting of textured and highly polished materials.

SKIDMORE DESIGNS NUCLEAR RESEARCH PLANT FOR INDUSTRIAL COOPERATIVE GROUP

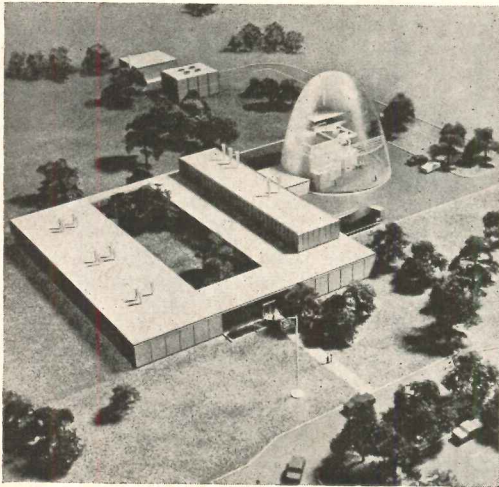

INDUSTRY HAS FOUND a solution to the economical problem of financing atomic research: cost-splitting. Ten corporations have pooled the high investment costs necessary to buy the equipment necessary for a nuclear energy research building, and the site work has already started on an "Oak Ridge for Industry" at Plainsboro, N. J. Designed by the New York firm of Skidmore, Owings & Merrill, the center should be operating by early 1958.

A model of the center, shown at left, houses the reactor in a plastic cocoon only so that the interior elements can be readily seen. Actually its construction will be of heavily reinforced concrete, 12 in. thick at the bottom and thinning out to about 4 in. at the top. The reactor itself will be surrounded by water, which will act as moderator, cooler and shield. The buildings to the left in the model will house hot cells, shops, offices, etc. The hot cell storage area will be

directly under the air conditioning pent-house and separated from the adjacent general office area by a thick wall. To the far left, on the other side of the open courtyard, will be the private company laboratories. The passageway connecting the reactor building to the hot storage area will contain decontamination areas.

The ten companies which have cooperated in forming the Industrial Reactor Laboratories, Inc., are Atlas Powder Co., AMF Atomics, Inc. (a subsidiary of American Machine & Foundry Co.), American Tobacco Co., Continental Can Co., Corning Glass Works, National Distillers Products Corp., National Lead Co., Radio Corp. of America, Socony Mobil Oil Co. and U. S. Rubber Co. Each firm will staff its own laboratory and each is represented on the board of directors. A staff from Columbia University will operate the reactor.

ICE SKATING ARENAS BECOMING INTEGRAL PART OF COMMUNITY

WITH THE INCREASING INTEREST in ice shows and traditionally winter sports, development and planning of the well-integrated modern community often includes today a civic arena which has facilities for ice skating — or, in the smaller community, an outdoor rink for public skating and hockey. Different engineering and maintenance considerations figure into the planning of each type of rink. One of the most important is the fact that the arena type rink is not limited strictly to ice skating functions but can be used also for other activities.

The outdoor rink is, of course, less costly than a permanent rink and usually consists of pipes laid in a sand or gravel fill. A bed of clean sand or washed gravel should be provided beneath the piping, with the pipe runs supported on iron saddles or cement blocks. The use of cinders, slag or similar sulfur or chloride-bearing materials should be carefully avoided. The pipe

should be hardy enough to absorb the nicks of skate blades on the infrequent occasions when they cut through the ice.

Permanent floors are more expensive, but, as mentioned before, more useful. Covered with a portable wood or composition floor, they can be used as a staging area for shows, meetings, sports events and conventions. In the permanent floor, the piping is completely embedded in concrete, with approximately 1½ in. of concrete both above and below it. It is usually surfaced with a cement or terrazzo finish. The piping must be well supported and maintained in a level position. Insulation may be necessary, and provision must be made for expansion and contraction of the rink floor and headers. Normally expansion joints are used in the floor. However, the monolithic floor avoids the need for expansion joints because the concrete slab in which the pipe is embedded is distinctly separate from the material

on which it is supported. The separation is effected by a layer of sheet zinc that prevents the rink floor from adhering or attaching itself to its underlying support. The slab is free to move in every direction.

Corrosion is a subject that must be given careful attention in closed floors, since it is very expensive to tear up a concrete floor to repair the piping system. Corrosive attack in closed floors usually comes from the brine refrigerant, and so it is important that the type of piping be selected carefully and that chemical treatment of the brine be instituted where necessary. Three types of piping material are commonly used in ice floor construction: wrought iron, steel and plastic. As a source of information for architects, engineers and others interested in ice floor programs, the Engineering Service Department of the A. M. Byers Co. in Pittsburgh has compiled an extensive consulting file.

(More Roundup on page 254)

Each cabinet is formed from a single sheet of the plastic sandwich, which is scored and mitred for corners and then folded together like a carton around interior partitions

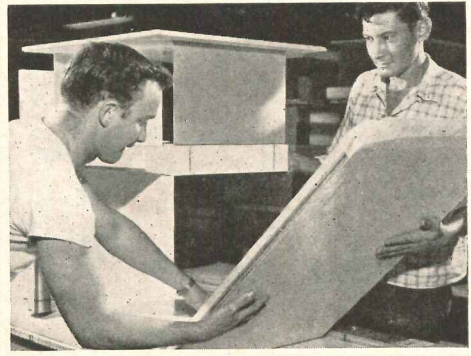
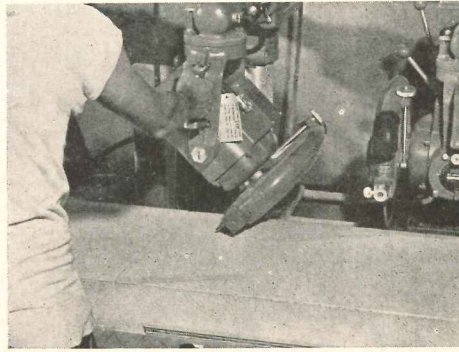

With refrigerating units installed, the cabinet is assembled to the back sheet. The steel doors are attached, and the unit is ready to be "built in" as shown

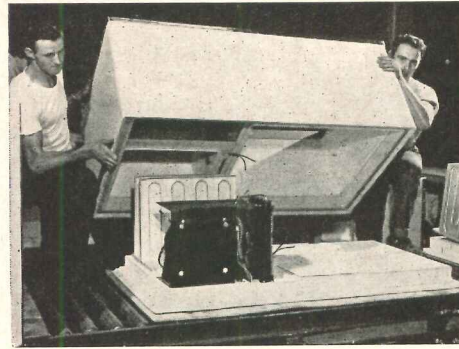

ALL-PLASTIC REFRIGERATORS ARE LIGHT, FLEXIBLE IN DESIGN

PLASTICS is about to enter the kitchen in a new way — as the basic component of an all-plastic refrigerator. The first models, which will be introduced by Westinghouse around the first of the year to retail at about the same price as a steel built-in model, will feature plastic interior and exterior skins sandwiched around a foamed plastic core. Only the doors will be steel, and these will be replaced with plastic doors eventually.

The major advantages of the plastic refrigerator are: (1) low tooling costs, (2) speedy production, and (3) light weight. Although the plastic sandwich is more expensive than steel, its tooling

costs will be appreciably lower than those for conventional steel models, and so the final costs will be about the same. Also, with plastic bodies, production line changes can be made for a new model within a couple of weeks instead of the customary six months necessary with steel models. The weight of the plastic refrigerators, even with steel doors, is about 150 lb less than steel models with the same cubic capacity.

The outer skin of the sandwich wall of the new refrigerator is a polyester resin impregnated glass fabric. The inner skin is 1/16-in.-thick polystyrene sheet. These are sandwiched around 2 1/2 in. of polystyrene foam insulation. Actually

the exterior could be wood, aluminum or another lightweight metal, and the interior could be colored or plain aluminum. Each refrigerator cabinet is formed from a single flat sheet of the sandwich material. Corners are mitred out and the cabinet folded together like a carton. The corners are bonded and sealed by a plastic resin which is cured electronically.

The model which will be introduced in January will have a capacity of 13 cu ft and will come in both horizontal and vertical built-in styles so that the refrigerator and freezer can be either side by side or on top of each other. *Westinghouse Electric Corp., Columbus, Ohio.*

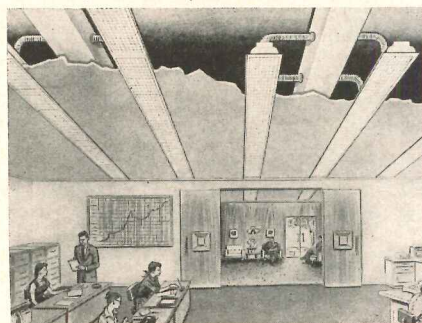
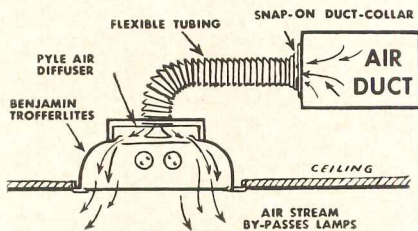

LIGHT, AIR CONDITIONING FROM ONE FIXTURE

LIGHTING AND AIR CONDITIONING are now possible from the same fixture with the *Multi-Vent Trofferlite*, a combination light fixture and air diffuser which is adaptable to any drop-type ceiling. The fixture uses an air pressure displacement principle instead of high-velocity injection, so temperatures are said to be easily balanced and to stay uniform throughout the area. As shown in the drawing, flexible tubing feeds from the main ducts into the tops of the light

fixtures, carrying air out into the room. Where minimum cooling is needed, the fixtures can remain unattached to the air duct or shut down. The main attraction of the dual-unit, according to the manufacturers, is its time- and money-saving feature, since it reduces the number and variety of ceiling fixtures needed. The fixture was engineered and designed jointly by the *Pyle-National Co., Chicago 51*, and the *Benjamin Electric Mfg. Co., Des Plaines, Ill.*

(More Products on page 260)

LITERATURE

Catalogs • Brochures • Booklets

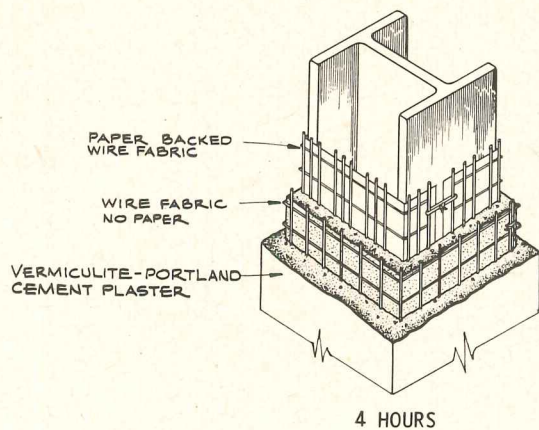

VERMICULITE FIRE RATINGS

(AIA 21-C-1) This booklet, which gives ratings for plaster, acoustical plastic and concrete, contains 38 drawings that show fireproofing details for both concrete and steel roof and floor assemblies, columns, beams, girders and trusses, panel or spandrel walls and solid plaster partitions. An example is the illustration at left showing a column covered with paper-backed wire fabric, wire fabric without paper and Vermiculite-Portland cement plaster. Included are new assemblies that have proved more economical than earlier types, such as direct-to-steel fireproofing of formed steel floors and roof decks. 8 pp. *Vermiculite Institute, 208 South LaSalle St., Chicago 4, Ill.*

Low-voltage Switch Systems

(AIA 31-R) Manual 55 catalogs the elements of *Touch-Plate* low-voltage switch systems. 8 pp. *Touch-Plate Mfg. Corp., Long Beach, Calif.*

Glass for Industrial Use

(AIA 26-A-3, 5, 6) Catalog 56-I covers figured glass, wire glass, Coolite glass and glare-reducing finishes. 12 pp. *Mississippi Glass Co., 88 Angelica St., St. Louis 7, Mo.*

Standard Steel Doors and Frames

(AIA 16-A) Lists recommended specifications for flush-type interior steel doors, frames and sliding closet door and frame units. *Steel Door Institute, 2130 Keith Bldg., Cleveland 15, Ohio.*

Thermostatic Control Valves

Condensed Catalog C-7 contains brief descriptions and engineering data on a complete line of thermostatic control valves. 8 pp. *Lawler Automatic Controls, Inc., Mount Vernon, N. Y.*

Food Facilities Engineering

Brochure details specialized engineering services provided to architects and owners of all types of commercial and institutional feeding establishments, from original planning to job completion. 40 pp. *J. E. Stephens Associates, Inc., 116 Delaware, Detroit 2, Mich.*

School Lighting (AIA 31-F-21)

Presents "the ABC's" of school lighting using *Celluliner* cold cathode lamps and fixtures. 4 pp. *CELine Inc., Batavia, Ill.*

Air Conditioning

Bulletin C-1100-B86P presents central station, cabinet-type air conditioning units. 52 pp. *Worthington Corp. (Editor, Climate Chart, Adv. & Sales Promotion Dept.), Harrison, N. J.*

Spero Reflectors (AIA 31-F-2)

Catalog 10 presents a complete line of industrial and commercial lighting fixtures and materials for electrical construction, including reflectors, high bays, vaportight units and floodlights. 52 pp. *The Spero Electric Corp., 20500 St. Clair Ave., Cleveland 17, Ohio.*

Increase Production

Bulletin K7A describes how Korfund mountings permit efficient plant layout, make possible utilization of all available space, prevent rejects and eliminate down-time. 8 pp. *The Korfund Co., Inc., 48-08A 32nd Place, Long Island City 1, N. Y.*

Sliding Glass Doors

Presents engineering information and details of the new *Fleelite* aluminum framed sliding glass door. 4 pp. *Fleet of America, Inc., 2015 Walden Ave., Buffalo 25, N. Y.*

Draftless Air Diffusers

Presents new ceiling panel diffuser, aspiration diffuser, high-capacity vane-type diffuser for high sidewalls, diffusers for ceiling mounting and diffusers with air extraction in outer cones. 12 pp. *Anemostat Corp. of America, 10 East 39th St., New York 16.*

Temperature Controls

Bulletin RT-771 describes *Thermal Eye* Model TE top-element temperature controls for electric ranges. *Robertshaw-Fullton Controls Co., 110 East Otterman St., Greensburg, Pa.*

Fire Alarm System

Bulletin F249 describes the *Flexalarm* fire alarm system, which can be installed to meet design requirements. 12 pp. *The Gamewell Co., Newton Upper Falls 64, Mass.*

Lighting for Commercial Kitchens

IES report covers all phases of lighting for food handling and preparation in restaurants and other institutional kitchens. Includes recommended lighting levels, brightness ratios, reflectances of walls, ceilings and floors and selection of types of fixtures. 8 pp. 15¢. *Illuminating Engineering Society, Publications Office, 1860 Broadway, New York 23, N. Y.*

Checking Floor Hinges and Pivots

(AIA 27-B-4) Catalog 55 presents a complete line of double- and single-acting checking hinges and pivots, including a section on specialty hardware for X-ray room doors. 64 pp. *The Shelby Spring Hinge Co., Shelby, Ohio.*

Business Furniture

Catalogs 16 basic models of chairs, settees, sofas and tables for business interiors. 4 pp. *Hamilton Mfg. Corp., Columbus, Ohio.*

Figure Types in Mahogany

Presents 40 mahogany veneer plates and descriptions of the characteristics of each. 32 pp. \$1.00. *Mahogany Assn., Inc., 666 Lake Shore Dr., Chicago 11, Ill.*

Lighting a Remodelled Kitchen

(AIA 31-F-23) Gives data and describes fixtures for lighting a remodelled kitchen suite in a home. 4 pp. *Holophane Co., Inc., 342 Madison Ave., New York 17.*

Weather Controls

Bulletin N-756 presents a chart for scheduling the most suitable outdoor controls for use with different types of heating systems under varying conditions and requirements. 4 pp. *Automatic Devices Co., Inc., Western Springs, Ill.*

* Other product information in *Sweet's Architectural File, 1956*

(More Literature on page 334)

USEFUL CURVES AND CURVED SURFACES: 13—Spirals

By SEYMOUR HOWARD Assistant Professor, Pratt Institute, Architect associated with Huson Jackson and Harold Edelman

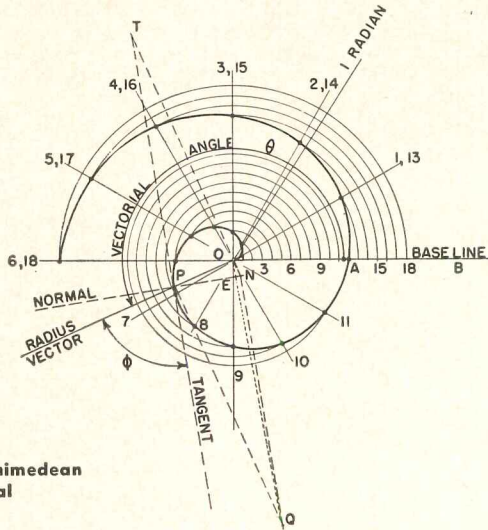

Archimedean Spiral

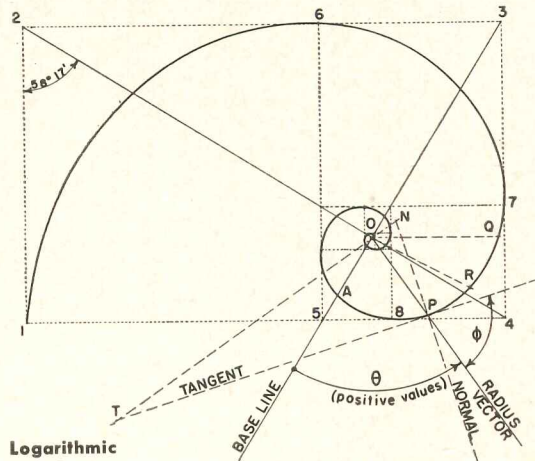

Logarithmic Spiral

ARCHIMEDEAN SPIRAL

The locus of a point P which moves with uniform linear velocity along a line OP as OP revolves with uniform angular velocity about O is called a Spiral of Archimedes.

EQUATION:

$$r = a\theta \quad (\theta \text{ in radians})$$

METHOD OF DRAWING (only positive values of θ are shown) Draw baseline OB. Measure off OA = $2\pi a$. Divide OA into whole number of parts (here 12). Through O draw radial lines at equal spaces corresponding to the same number of parts (here $\frac{360}{12} = 30^\circ$ or $\frac{2\pi}{12} = \frac{\pi}{6}$ radians). With O as center, draw arcs of circles with radii = O1, O2, O3 etc. Where each radius intersects corresponding radial line is a point on the spiral. Note that successive values of r are in arithmetical progression. To measure a, draw radial line at 1 radian ($57^\circ 18'$), where $r = a$.

NORMAL

Through O draw ON = a perpendicular to radius vector OP. PN is normal. TANGENT is drawn at right angles to normal at P. Note that the angle Φ between radius vector and tangent is the angle whose tangent = $\frac{r}{a}$ and that this angle is constantly increasing as θ increases.

RADIUS OF CURVATURE

Through N draw NQ parallel to tangent.

Through P draw PQ at right angles to radius vector. Line OQ cuts PN at E. E is center of curvature to spiral at P. Radius of curvature

$$R = \frac{(r^2 + a^2)^{3/2}}{r^2 + 2a^2}$$

LENGTH OF ARC = OP

$$\frac{a}{2} \left[\theta \sqrt{1 + \theta^2} + \log_e (\theta + \sqrt{1 + \theta^2}) \right]$$

LOGARITHMIC (EQUILANGULAR) SPIRAL

The curve which cuts the radius vector at a constant angle Φ is called an Equiangular Spiral. If successive values of the vectorial angle θ are in arithmetical progression, the corresponding values of the radius vector are in geometric progression.

EQUATION

$$r = ae^{m\theta} \text{ or } \log_e \frac{r}{a} = m\theta$$

$$m = \cotan \Phi \text{ and } a = r = OA \text{ (when } \theta = 0^\circ)$$

METHODS OF DRAWING

In general, draw radial lines from pole O for equal increments of θ , calculate corresponding values of r and measure on each radial line. If r is calculated for large increments of θ and the points plotted, intermediate points can be found as follows: If OP and OQ are any two radii and if OR is a radius bisecting angle POQ, then OR is the mean proportional between OQ and OP (see sheet 12 for drawing method).

NORMAL

Through O draw ON = $rm = r \cot \Phi$ perpendicular to radius vector OP. PN is normal. TANGENT is drawn at right angles to normal at P and intersects ON extended at T.

RADIUS OF CURVATURE

$$R = PN = r \sqrt{1 + m^2} = r \operatorname{cosec} \Phi.$$

Center of curvature is at N. Evolute is an identical spiral whose axis is inclined $\left[\frac{\pi}{2} - \frac{\log_e m}{m} \right]$ to axis of given spiral.

LENGTH OF SPIRAL from O to p = $r \sec \Phi = PT$

AREA swept by radius (from $r = 0$ to $r = OP$) = $\frac{r^2}{4m} = \frac{1}{2}$ triangle OPT

The golden section spiral shown here is one whose radius vectors, separated by 90° , are in the golden section ratio. It is extensively discussed in theories of proportion. It can be drawn geometrically, without calculation. Here the rectangle 1234 is shown whose sides are in the golden section ratio. If a square (here 1265) is cut off, a similar rectangle (3456) is left, turned through 90° . This process can be continued indefinitely. Note the value of the diagonals in drawing the rectangles correctly. The diagonals cross at right angles at the pole O and are the axes of the equiangular spiral for which $\Phi = 73^\circ$ (approx.) The corners of the squares (1, 6, 7, 8 etc.) are points on the spiral. The spiral crosses outside of the rectangle at these points.

.....
MARS outstanding design **SERIES**

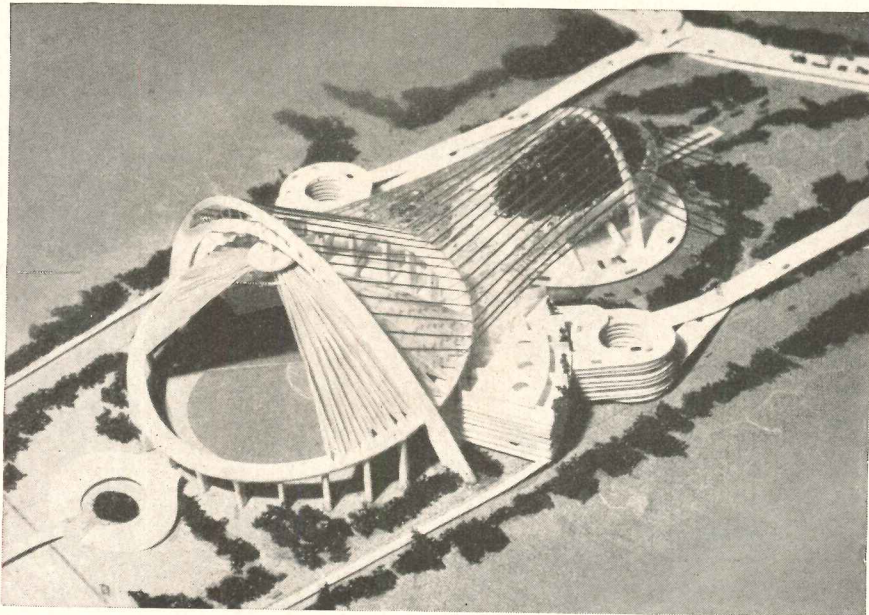

umbrella'd stadia

While it isn't always true, an interesting approach often results in a good design, as in these twin all-weather stadia designed by Harry Barone and Arnold Horn, Pratt architecture students. Each bowl would be umbrella'd by its own tentlike roof of translucent plastic, hung from the center of soaring arches. Accordion-pleated, these roofs are planned to fold together out of the way in fair weather, their lower edges riding along the rims of the bowls. Cables that guy the arches form a decorative pattern tying the two stadia together. The big football-baseball bowl would hold 65,000 spectators; the smaller, 20,000.

No matter which of today's bright ideas become tomorrow's reality, it will be as important then as it is now to use the best of tools when pencil and paper translate a dream into a project. And then, as now, there will be no finer tool than Mars—from sketch to working drawing.

Mars has long been the standard of professionals. To the famous line of Mars-Technico push-button holders and leads, Mars-Lumograph pencils, and Tradition-Aquarell painting pencils, have recently been added these new products: the Mars Pocket-Technico for field use; the efficient Mars lead sharpener and "Draftsman's" Pencil Sharpener with the adjustable point-length feature; and—last but not least—the Mars-Lumochrom, the new colored drafting pencil which offers revolutionary drafting advantages. The fact that it blueprints perfectly is just one of its many important features.

The 2886 Mars-lumograph drawing pencil, 19 degrees, EXEXB to 9H. The 1001 Mars-Technico push-button lead holder. 1904 Mars-lumograph imported leads, 18 degrees, EXB to 9H. Mars-lumochrom colored drafting pencil, 24 colors.

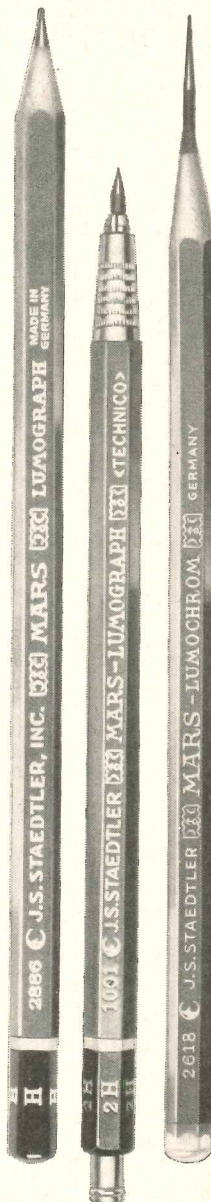

J.S. STAEDTLER, INC.
 HACKENSACK, NEW JERSEY.

at all good engineering and drawing material suppliers

Mars Pencils Sponsors

Tomorrow's Designs

MARS OUTSTANDING DESIGN SERIES—featured in the current advertising of J. S. Staedtler, Inc.—has attracted widespread attention among the users of fine drafting pencils. It has fulfilled our expectation that the men who appreciate the finest working tools are those with a lively creative interest in new designs, new projects, new ideas.

Concerned with unusual projects—*designs of the future*—Mars Outstanding Design Series provides a "showcase" for originality, for interesting work of engineers, architects, and students which so often lies buried. To stimulate you to send in *your* designs, Mars Pencils

will pay you \$100

for any design accepted. This \$100 is paid you simply for the right to reproduce your project in the Mars Outstanding Design Series. There are no strings attached. You will be given full credit. (See ad on this page—one of the ads in the current series.) All future rights to the design remain with you. You can reproduce it later wherever you like and sell or dispose of it as you wish.

The subject can be almost anything—aviation, space travel, autos, trains, buildings, engineering structures, household items, tools, machines, business equipment, etc. It should be a project that appeals to design-minded readers, be of broad interest, and be attractively presented. Do not submit a design that has been executed. As a matter of fact, the project does not need to have been planned for actual execution. It should, however, be something that is either feasible at present or a logical extension of current trends. It cannot be unrealistic or involve purely hypothetical alterations of natural laws.

There is no deadline for entries but the sooner you send yours in, the greater the probability of its use as one of the subjects in the 1957 Mars Outstanding Design Series.

**It Is Simple To Submit a Design
 For Mars Outstanding Design Series**

Just mail in an inexpensive photostat or photocopy of the subject—one you can spare, since it cannot be returned.

If your entry is accepted, we will ask you to send in a sharp photograph of the design, or the design itself, so that we can make a sharp photograph suitable for reproduction—after which it will be returned to you promptly.

Send your entry to:

J.S. STAEDTLER, INC.
 DICAROLIS COURT, HACKENSACK, NEW JERSEY

USEFUL CURVES AND CURVED SURFACES: 14 — Remarks on Surfaces, Skew Curves

By SEYMOUR HOWARD Assistant Professor, Pratt Institute, Architect associated with Huson Jackson and Harold Edelman

ANALYTIC DESCRIPTION

Surfaces and skew curves can be described by a greater variety of analytical systems than curves which exist in only one plane. In architectural and related work we do not need all of these and will limit the descriptions to three types: 1. Triaxial Cartesian coordinates (a point is fixed by its projected distance on x, y and z axes); 2. Cylindrical coordinates (a point is fixed by a plane normal to a z axis and by its radius vector from a pole on this axis); and 3. Spherical coordinates (the familiar latitude and longitude or meridian lines). The purposes in analyzing a surface are:

- a) to be able to recreate the surface;
- b) to know its area and the volume enclosed;
- c) to discover the stresses acting in the surface;
- d) to discover the manner in which the surface will reflect light, heat, sound.

METHODS OF STUDY

Models are the best, and should be made as large as practicable. Wire and string can be used; sheet materials (cardboard, plastic) can be bent into the shape of developable surfaces, or can be cut to represent planes cutting the surface and put together like an egg-crate. Soft white pine can be carved in the solid and its surface studied. A solution of soap and glycerine can be used to create minimal surfaces or membranes between wire boundary curves. From the models the surfaces can be transferred to paper, showing the traces of the surface as it is cut by a system of planes. Once drawn, the best method of construction in the field can be worked out. Usually a table of offsets should be prepared.

SKEW CURVE

A skew curve (also called a space curve or a twisted curve) is one which does not lie entirely in one plane. (See dwg.) The tangent line at any point defines the direction of the curve at that point. The normals to the tangent define the normal plane. The osculating plane makes a right angle with the normal plane, contains the tangent and is the plane in which the curve most closely lies at the

given point. The curve will pass through the osculating plane at a regular or ordinary point. The principal normal is the intersection of the osculating and normal planes. The radius of curvature (R) is found on this principal normal. The ratio $\frac{1}{R}$ is called the first curvature. The third orthogonal line of reference at the point is called the binormal and its plane the rectifying plane. The angular rate of change of the binormal as a point moves along the curve is called the torsion or second curvature.

SURFACES

At any regular (i.e. not singular) point on a surface there will exist a **tangent plane**. If the surface is cut by any variable plane, the tangent to the curve of intersection at the given point will always lie in this tangent plane. For a cup-shaped region of a surface this tangent plane will be entirely on one side of the surface; for a saddle-shaped region it will cut the surface. (See dwg.)

At right angles to the tangent plane an infinity of normal planes can be drawn. Each of these cuts the surface in a curve called a normal section; each of these sections has a radius of curvature at the given point. One of these radii will have a minimum value R_1 and another a maximum R_2 . The normal planes in which these two radii lie are called the **principal normal planes** and they are at right angles to each other. The tangents to the principal normal sections are called the **principal directions**. For a cup-shaped region of a surface the centers of both radii will lie on the same side of the surface, (See dwg.), and will have the same sign. Such a point is called an elliptic point and the curvature of the surface is called positive. For a saddle-shaped region the center of one radius will lie on one side, and the center of the other on the opposite side of the surface; and the radii will have opposite signs. Such a point is called a hyperbolic point and the curvature is called negative. Parabolic points also exist; at these the maximum radius of curvature is infinite.

On a surface can be traced a **line of curvature**, which lies along one of the principal directions of each of a sequence of points (Continued on page 251)

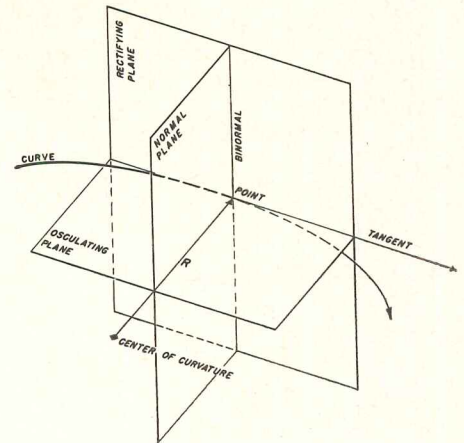

Skew Curve

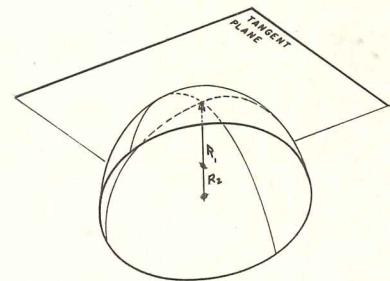

Surface of Positive Curvature

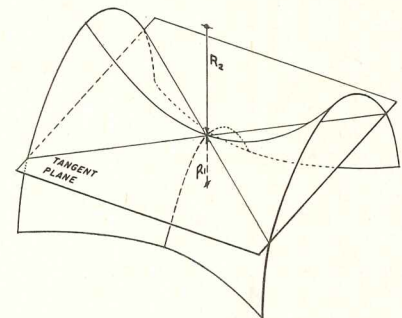

Surface of Negative Curvature

HEARD EVERYWHERE Lowell[®]

THE SOUND CHOICE / AL SERIES BAFFLE

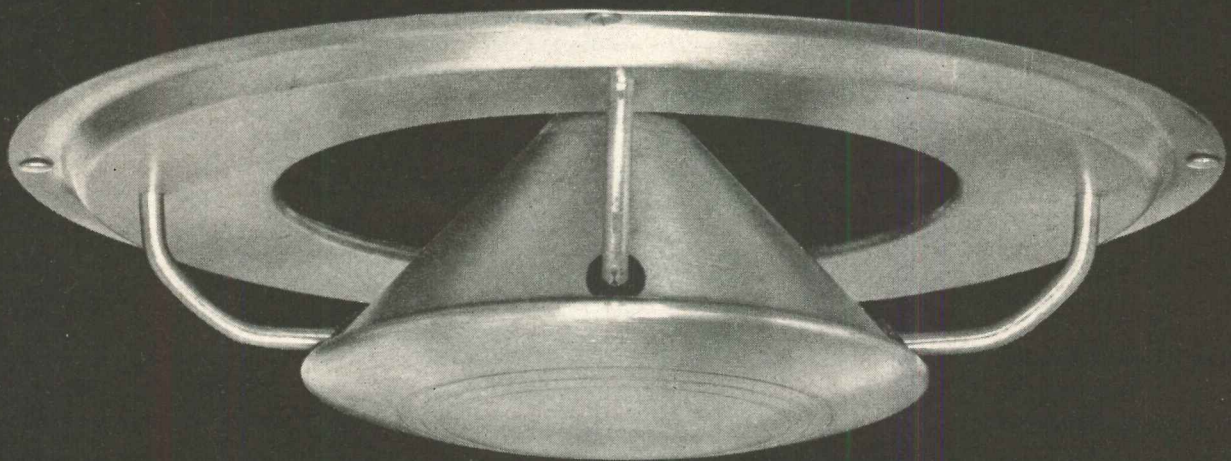

Beautiful . . . in appearance and in performance.

Mounts flush for low-ceiling areas. Effective 360° dispersion of clear "ear level" sound. Conical diffuser "floats" on soft rubber grommets. Heavy gauge aluminum. Sizes available for 6" to 15" speakers. Easily installed.

LOWELL: One source for immediate delivery. More than 100 models of ceiling and wall baffles, enclosures, grilles, accessories, intercom equipment.

Write for complete information and specifications.

World-wide representation

HEARD EVERYWHERE
Lowell MANUFACTURING CO.
3030 LACLEDE STATION ROAD • ST. LOUIS 17, MISSOURI
IN CANADA: ATLAS RADIO CORP., LTD., 50 WINGOLD AVENUE, TORONTO 10, ONTARIO



USEFUL CURVES AND CURVED SURFACES: 15 — Remarks on Surfaces, Skew Curves

By SEYMOUR HOWARD Assistant Professor, Pratt Institute, Architect associated with Huson Jackson and Harold Edelman

Through each point there will regularly be two such lines of curvature, which are at right angles to each other. On any surface of revolution the lines of curvature are the meridians (intersection with the surface of a plane containing the axis) and the circles of latitude. On any developable surface the rulings constitute one family of lines of curvature.

The **mean (or average) curvature** of a surface at a given point is the arithmetic mean of the two principal curvatures: $\frac{1}{2} \left(\frac{1}{R_1} + \frac{1}{R_2} \right)$. It is always zero for a minimal surface.

The **Gaussian curvature** (also called the total curvature) of a surface at a given point is the product of the two principal curvatures: $\frac{1}{R_1 R_2}$. It is positive at elliptic (cup-shaped) points, negative at hyperbolic (saddle-shaped) points, and zero at parabolic points. When a surface is bent, its Gaussian curvature does not change. This fact can be used to determine whether one surface can be formed or developed into another.

The **Dupin indicatrix** at a point is found by plotting, on the tangent plane, in the direction of every normal section, a distance from the point equal to the square root of the radius of curvature corresponding to that section. The indicatrix is always a conic section (including the degenerate conics). (At an **elliptic point** (cup-shaped or synclastic region) the Dupin indicatrix is an ellipse. When both radii of curvature are equal, the ellipse becomes a circle and the point is called an **umbilic**. The umbilics are therefore singular points and have no principal directions. At a **hyperbolic point** the indicatrix is a hyperbola for all the radii of curvature on one side of the surface and the conjugate hyperbola for all the radii on the other side. The asymptotes of the hyperbolas give the **asymptotic directions**. The **asymptotic lines** consist of the family of curves which follow the asymptotic directions for every hyperbolic point and form a net over a negative surface. At a **parabolic point** one of the radii of curvature usually becomes infinite (and the corresponding curvature vanishes) and the Dupin indicatrix becomes a pair of straight lines.

On a surface on which some regions are negative, some positive, the locus of points separating the two regions traces a curve called the **parabolic curve** of the surface.

A **ruled surface** is generated by a straight line (called a generator of the surface) which moves continuously in some predetermined manner with respect to a curve or curves (called the directrix) and/or a point.

A **developable surface** is always a ruled surface, and the tangent plane to the surface at any point as the point moves along a given ruling lies in one plane throughout the length of the ruling. Cones and cylinders are typical. In general any surface generated by the tangents to a skew curve is a developable surface (called the tangential developable of the curve.) The Gaussian curvature of a developable surface is everywhere zero (as is that of a plane) and all its points are parabolic.

For all **other ruled surfaces** (which are not developable) the tangent plane at any point as the point moves along a given ruling turns through two right angles as it moves from infinity at one end to infinity at the other. The point at which the tangent has moved through only one right angle is called the **center point**. The locus of center points for the surface is called the **line of striction**.

Doubly ruled surfaces have two distinct families of rulings or straight lines on them. Only two such surfaces exist: the hyperbolic paraboloid and the hyperboloid of one sheet. The rulings are the asymptotic lines of the surfaces. The Gaussian curvature is everywhere negative and all the points are hyperbolic.

A **conoid** is generated by a straight line which, remaining parallel to a given plane, moves along a straight line (which is not parallel to the plane) and along some other geometrical figure. The hyperbolic paraboloid is thus a conoid as are the helicoids. The surface commonly referred to as a conoid in construction is Pluecker's conoid or cylindroid, generated by a straight line which moves along a straight line and an ellipse (or circle).

A **surface of revolution** is generated by rotating a curve about an axis. Typical are: the right circular cone and cylinder; the spheroids; the paraboloid of revolution; the hyperboloids of revolution, of one sheet and of two sheets; the unduloids (generated by rotating the roulette of any conic curve.) The two centers of curvature at any point on a surface of revolution are: 1) In the meridian plane, the center of curvature of the curve whose rotation generates the surface; and 2) The intersection with the axis of revolution of the line normal to the surface.

A **geodesic curve** is the shortest distance, measured on the surface, between two points on the surface. For any developable surface it can be found by drawing a straight line on the surface when developed out onto a plane and then bending the plane back onto the surface. Through any point on a surface there exists in general an infinite number of geodesic curves, going out from it in every direction and joining it to every other point on the surface. On a sphere all the geodesics are great circles. On a cylinder all the geodesics are helices (including meridian lines which are helices of infinite pitch and latitude circles which are helices of zero pitch). On a surface of revolution all the meridians are geodesics, but the other geodesics cannot be found so simply. The circles of latitude are generally not geodesics.

A **minimal surface** is the surface of smallest area among all the surfaces bounded by a given closed curve or curves. It is created automatically by the membrane formed when a wire model of the boundary curve(s) is dipped into a soap solution. Except for the plane, a minimal surface is saddle-shaped (anticlastic) at all points; all points are therefore hyperbolic. The Gaussian curvature is everywhere negative. The mean curvature vanishes for every point; i.e.

$$\frac{1}{2} \left(\frac{1}{R_1} + \frac{1}{R_2} \right) = 0.$$

In other words the least radii of curvature at any point are equal in magnitude and on opposite sides of the surface. The Dupin indicatrix for every point is an equilateral hyperbola and the asymptotic lines form an orthogonal net over the entire surface.



Amos Parrish & Company selects Bigelow for fashionable store



James H. Pickering is Vice-President and Director of Store Design for Amos Parrish & Co., Inc., New York. The firm's most recent success is the interior of the National Clothing Store in Rochester, New York.

Other current design work includes the B. Altman & Company branch in Short Hills, New Jersey; a second suburban store for the Denver Dry Goods Company in Denver; a branch of Walker-Scott in San Diego, California; the 100,000-square-foot ground floors of the new Macy's on Long Island; and J. Fred Johnson Co., Kingsport, Tenn.

For over 35 years, Amos Parrish & Company has been noted for its success in the fields of retail merchandising consultation and store designing. And in designing store interiors, one of their foremost considerations has always been to achieve a pleasant, attractive atmosphere.

To do this, the selection of the right carpet was essential, both from the standpoint of appearance and wearing quality.

Mr. Pickering says this about the Bigelow Gro-point® Carpet used in the National Clothing Store:

are folding doors faddish...or functional?



Overhead track needs no unsightly cornice

Vinyl covered, many colors. Easily washed while in place.

Double-strength, all-steel framework

Available in standard or custom sizes.

Superior construction features account for MODERNFOLD's leadership. More MODERNFOLDS are in use than any other make of folding door!

what's behind the growing popularity of **MODERNFOLD DOORS?**

Ask any of your friends in the profession why *he* has used MODERNFOLD Doors. Was it to save space? Was it as a room divider? Or did he devise some completely *new* application for this door?

In recent years, architects have seen how MODERNFOLD allows them greater freedom of design by eliminating door-swing. They have witnessed the long service life of this door. And they are employing them in commercial, residential and institutional designs. How can MODERNFOLD Doors best serve *you*? When your MODERNFOLD distributor shows you their many quality features, your imagination will be stimulated to find new applications for them.

modernfold doors have no equal

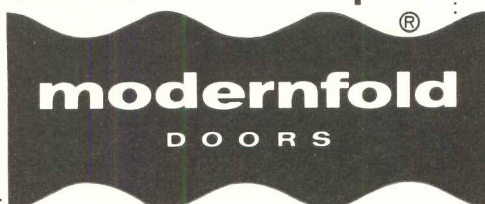

MODERNFOLD distributors are listed under "Doors" in city classified telephone directories

© 1956, NEW CASTLE PRODUCTS, INC.

NEW CASTLE PRODUCTS, INC., New Castle, Indiana • In Canada: New Castle Products, Ltd., Montreal 23 • In Germany: New Castle Products, GMBH, Stuttgart

New Castle Products, Inc., Dept. L30, New Castle, Indiana
Please send me full information on MODERNFOLD Doors.

NAME _____

BUSINESS ADDRESS _____

CITY _____ ZONE _____ STATE _____

THE RECORD REPORTS

(Continued from page 48)

STONE PIERS ACCENTUATE ALTAR IN CHURCH DESIGN

Stone piers rising almost 100 ft in height yield special emphasis to the altar area in the projected cathedral to be built at Valparaiso University, Valparaiso, Indiana.

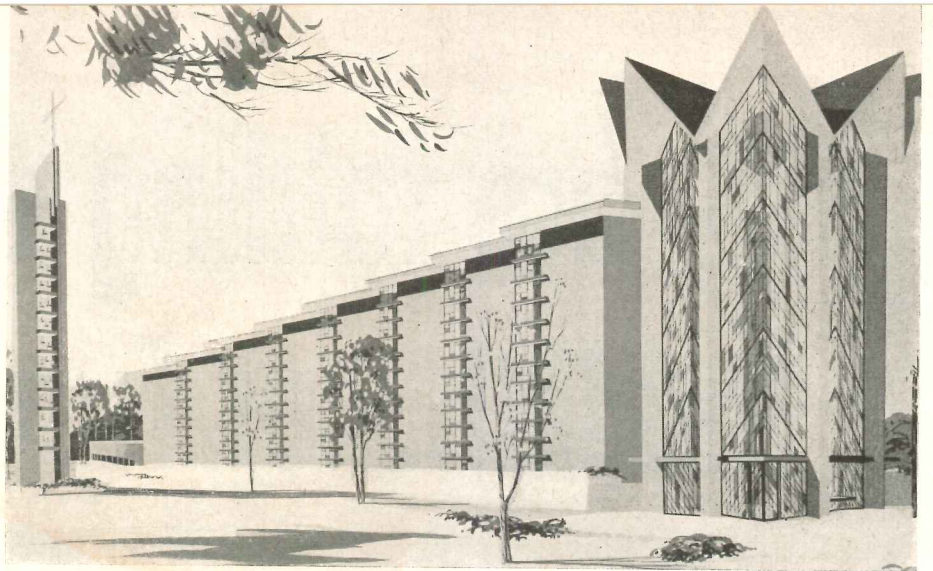

NEW DESIGN

for MENTAL HOSPITALS

SHAW MODEL I RADIATOR

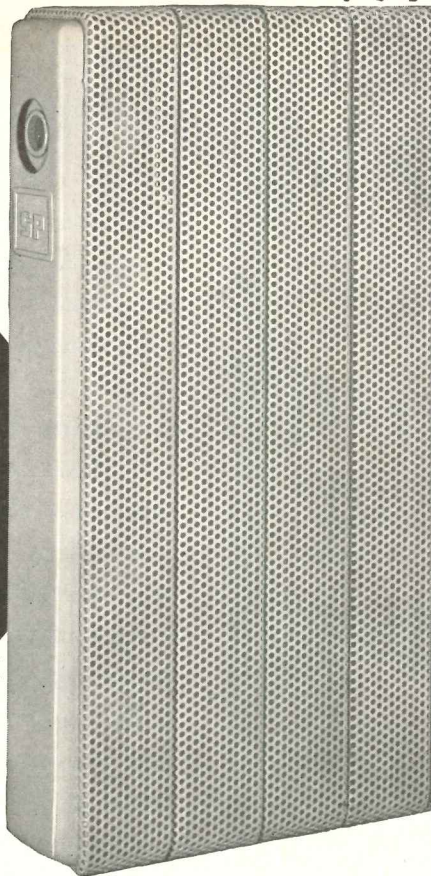

Originated and constructed specifically for use in mental hospitals and corrective institutions, the Shaw Model I offers exclusive advantages.

Box type housing, heating fins, and copper tubing are permanently bonded together under 3750# pressure to form an assembly that is indestructible in institution service. The housing—of heavy perforated steel—completely covers the interior construction, to prevent tampering and entry of foreign matter, yet the entire unit can be cleaned simply by hosing down, even during operation. For safety, all corners are rounded and surface temperatures never reach a degree harmful to inmates.

Our new Bulletin SI-1, giving full details on these and other important features of the Shaw Model I, will be sent on request. Write for your copy today.



SHAW-PERKINS MANUFACTURING CO.
201 EAST CARSON ST., PITTSBURGH 19, PA.

The cathedral will be one of the largest Protestant churches in the country, seating 2200 people in the nave and an additional 800 people in the balcony.

Plans call for the altar to be raised seven ft above the nave, enabling a clear view from all areas in the building. Cathedral glass is set between the stone piers of the altar area, enclosing the space and creating a colorful background for the altar. The nave is formed by a series of masonry louvered walls giving natural indirect light.

Design of the church, by architects Charles Edward Stade & Associates, was based on results of a study of some 90 various chapels, churches, and cathedrals throughout the world. Prof. Jean Labatut of Princeton University's School of Architecture, Dr. A. R. Ketzmann, critic of liturgics and church architecture, and the firm of Bolt, Berenak & Newman, Boston acoustical consultants, worked with the architects in the planning of Valparaiso's new church.

An additional Guild Chapel, donated by the Ladies Guild of Valparaiso University, will be set under the chancel portion. The grade of the entire project slopes at the chancel end. Entrance to the Guild Chapel is on the lower grade.

A free standing bell tower, containing a set of 35 carillon bells, completes the exterior composition.

(More news on page 340)

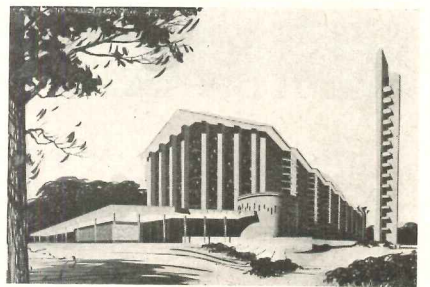

Walls, ceilings, floors and glass areas of Valparaiso church are shaped to produce "acoustically perfect" building. Bell tower is at right

when only the finest is adequate...

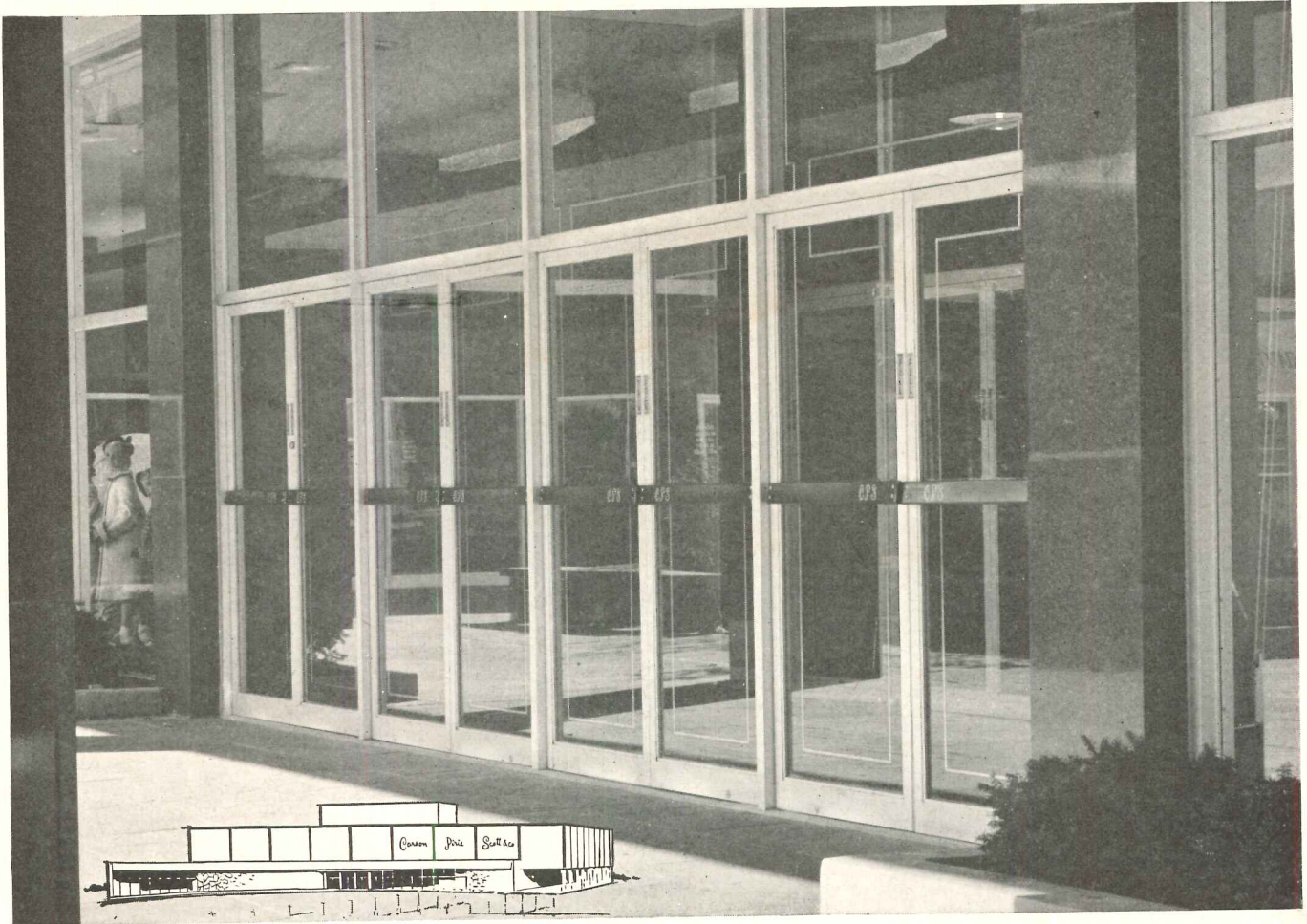

CARSON PIRIE SCOTT & CO., EDENS PLAZA
Architects and Engineers: Welton Becket & Associates, Los Angeles
Graham, Anderson, Probst and White, Chicago

equip **ENTRANCE DOORS** with **RIXSON**
for durability and appearance

CONCEALED floor type CLOSERS

for single acting doors
wood, metal or glass

- offset hung
- center hung
- butt hung

for double acting doors

- wood or metal doors
- glass doors

Entrance doors create the first impression of a building. Openings should be smooth and gentle, closings silent and safe. Still the door must withstand great abuse and be under complete control at all times. This requires an efficient, rugged, durable closing mechanism. RIXSON is world famous as the originator of concealed floor type closers with more than half a century's experience in engineering, testing, and development. There are installations over 45 years old in which RIXSON "floor checks" continue to function satisfactorily.

RIXSON floor type entrance closers give maximum strength of installation and *complete* concealment of the mechanism—including the arms, on offset hung and center hung doors.

THE OSCAR C. RIXSON COMPANY

9100 west belmont ave. • franklin park, illinois

THE RECORD REPORTS

(Continued from page 338)

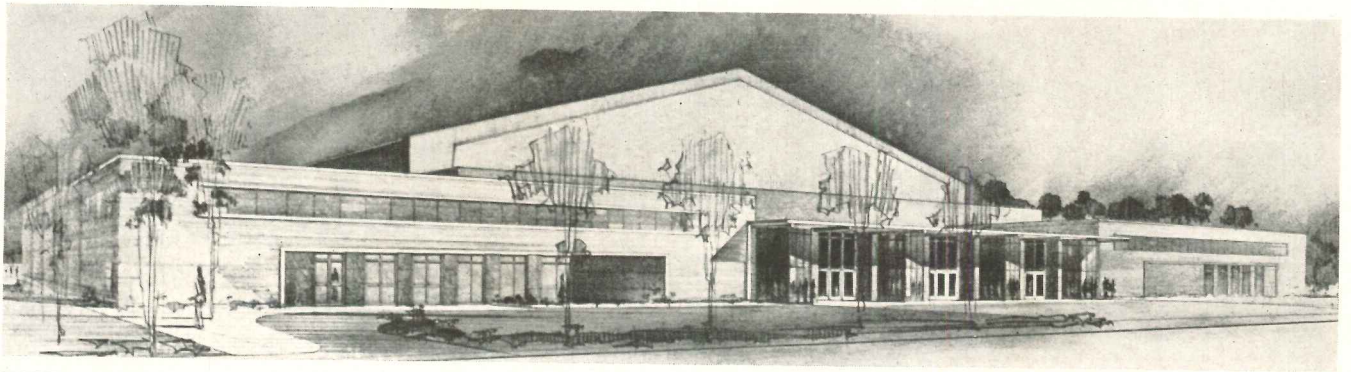

•General Telephone Office Bldg., San Angelo, Tex.
Architects: Pace Associates, Chicago
Plumbing Contractors: Bollinger & Sames, San Angelo

Here is a bold and unique conception in modern design that fairly echoes the spirit of telephone progress. And, in keeping with such advanced architectural planning, Halsey Taylor fountains and coolers were specified for this structure.

The Halsey W. Taylor Co., Warren, O.

Illustrated are some modernly-styled fountains and coolers in the Halsey Taylor line. Write for catalog.

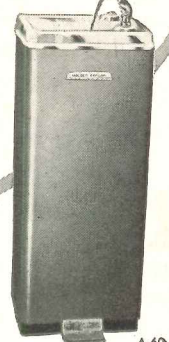

HALSEY TAYLOR

The Favorite Specification for
Fountains and Coolers

SEE OUR CATALOG IN SWEET'S

A-60

NEW CIVIC CENTER DESIGN FEATURES FLEXIBLE SPACE

A civic center designed so that any principal area in the building can be used without opening the other areas is under construction in Charleston, West Virginia.

Associated architects Irving Bowman, Glenn C. Hancock and Martens and Son planned the building in such a way that folding gates may be used to block off separate areas. Care was taken to provide acoustical barriers between various parts of the building to prevent disturbances when more than one activity is taking place at the same time.

The center will provide facilities for exhibitions, theatre, art, and recreation not available in the town until now.

An exhibition hall which provides 30,000 sq ft of unobstructed floor space will be used for industrial exhibits, conventions, sporting events, and other functions requiring large area. A press box will be suspended from roof framing in the hall. Seating will consist of 850 permanent chairs in the balcony and up to 5000 additional folding bleacher sets for use at sporting events.

Roof of the exhibition hall is supported by seven steel rigid frames each spanning 206 ft. Construction is a combination of steel frame and wall bearing, principally steel frame, all supported on concrete piling.

Meeting rooms contain 8300 sq ft of floor space on the second floor, and are available for various civic groups. The recreation section is intended primarily for use by local boys' and girls' clubs and scouting groups and has direct access from the outside.

Exterior wall surfaces other than metal are brick. Interior wall finishes are plaster and exposed masonry. Roof construction is poured gypsum on mineral acoustical form board in exhibition hall and poured gypsum over sheetrock elsewhere in the building.

(More news on page 342)



The New York Coliseum, New York City. Owners: Triborough Bridge & Tunnel Authority. Architects: Leon & Lionel Levy. Mechanical Engineers: Guy B. Panero Engineers. Heating Contractors: Almirall & Co., Inc.

New \$35,000,000 Coliseum where the best is a must!

depends on Sarco Heating Specialties

LARGEST AND MOST modern exhibition building in the world—that's New York's new Coliseum!

The 9 acres of exhibition space accommodates four expositions at one time. Each day, on the average, over 25,000 people visit the shows.

With a \$35,000,000 investment at stake...with uninterrupted service to exhibitors of vital importance...no chances could be taken with equipment that might cause shut-downs!

Unfailing record of dependability... that's one of the reasons Sarco Specialties, for low-pressure heating and air conditioning systems, are installed in this world's largest exhibition hall... where dependability is "a must."

For undivided responsibility on your installations, it pays to specify and order from one "Complete Line" source...SARCO-SARCOTHERM.

Write for catalogs to Sarco Company, Inc., Empire State Bldg., New York 1, N. Y.

**Sarco Dependability...
proved by
many repeat orders
from America's leaders**

Aluminum Co. of America
Bethlehem Steel Co.
Caterpillar Tractor Co.
Ford Motor Company
Lederle Laboratories Division
American Cyanamid Company
United Aircraft Corporation
U. S. Steel Corporation
Western Electric Company

2186-B

SARCO

AN AFFILIATE OF SARCOTHERM CONTROLS, INC.

Steam Traps... Temperature Controllers... Heating Specialties

Weather-Compensated control systems for steam, hot water and radiant heating

THE RECORD REPORTS

(Continued from page 340)

HIGH SCHOOL WILL OCCUPY 60-ACRE SITE IN ILLINOIS

Designed for an initial enrollment of 2200 students, Proviso West High School may one day have to house a student body of 4000. Architects Perkins & Will therefore planned this campus-type school for future expansion.

The school will be composed of six units. Two three-story buildings will

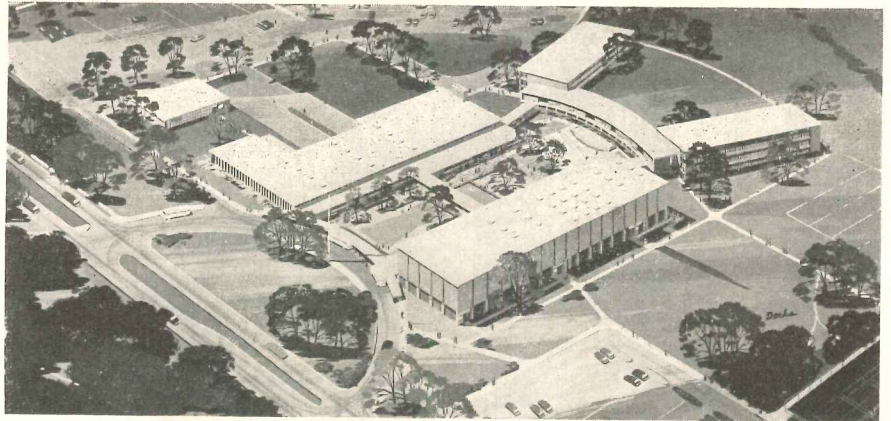

NATURAL SLATE . . . RIGHT

YESTERDAY
TODAY
TOMORROW

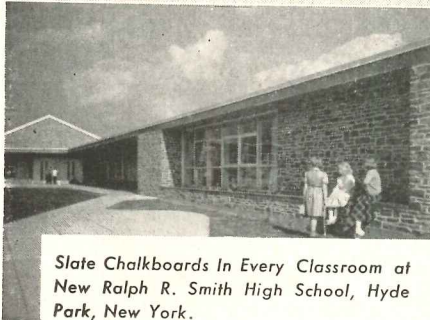

Slate Chalkboards In Every Classroom at New Ralph R. Smith High School, Hyde Park, New York.

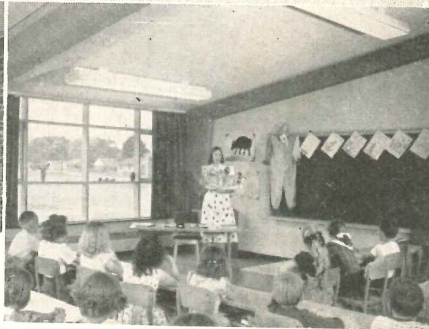

Perkins & Will, architects—engineers, Chicago, Ill.

Natural Slate chalkboards are still the choice in leading schools throughout the country . . . like the modern Ralph R. Smith High School.

The neutral color and smooth finish of slate add a soft, subdued effect to the strong, colorful decor of today's classrooms. Easy to clean . . . low on maintenance costs under normal usage conditions, slate makes a practical and eye-pleasing addition to the classroom. Because white chalk on slate produces the desired high contrast for quick, easy perception of the written message, the slate chalkboard permits the student to grasp the written message immediately. In addition, the writing surface of slate is so superior that it is the standard to which the writing quality of all other chalkboards is compared.

For timeless, durable chalkboards . . . be sure, specify slate. Inquiries welcomed on specific properties of slate.

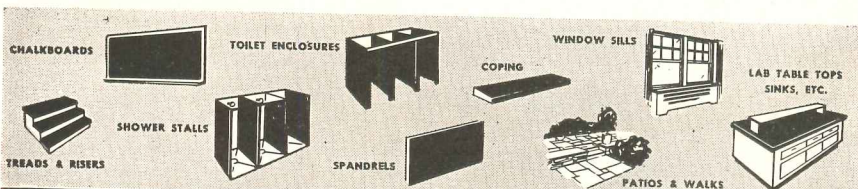

For Your Protection . . . Insist on Slate Quarried in Pennsylvania, U.S.A.

STRUCTURAL SLATE CO.
NATURAL SLATE BLACKBOARD CO.

PEN ARGYL PENNSYLVANIA

natural slate . . . 500 million years in the making



contain academic classrooms — one will house science, mathematics, speech and English classes, the other home economics, social studies, languages, commercial studies, "special education" and counselling services; each will have 30 classrooms. The two-story curved building, connecting the classroom units, will house administration offices and the library, as well as two study halls and counselling offices. The physical education building seems lavish indeed for a high school; it will include a swimming pool; four gyms which can be made one for exhibitions, when it can accommodate an audience of 4000; a wrestling room, an orthopedic gym, a dance studio, nine locker rooms and four classrooms, as well as a lobby and offices. A fourth building, also with two stories, will house shops, drawing rooms, music rooms, cafeteria and two small theaters, while a fifth will contain a vocational auto shop and classroom on its single floor. The auto shop, located near the other shops, will nonetheless be separate from the main buildings.

The area around which the buildings will be grouped, and which in the plans is called the Mall, will be used as a social center and an outdoor classroom area.

In the event that expansion is required, classroom units could be built to the east of the buildings (the administration building is at the east end of the Mall.) Additional gym facilities could be built to the south, shops and a cafeteria to the north. An auditorium may eventually be built, also to the north. This scheme for expansion is only tentative, however, the architects point out.

Structure will be reinforced concrete in the administration and class room buildings, structural steel in the others, with non-load-bearing partitions for flexibility in space arrangement. Exterior walls will be masonry and metal panels.

(More news on page 344)

Look at it from this angle

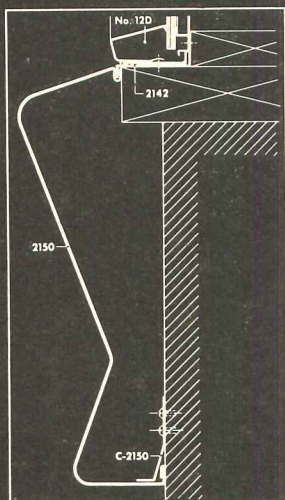
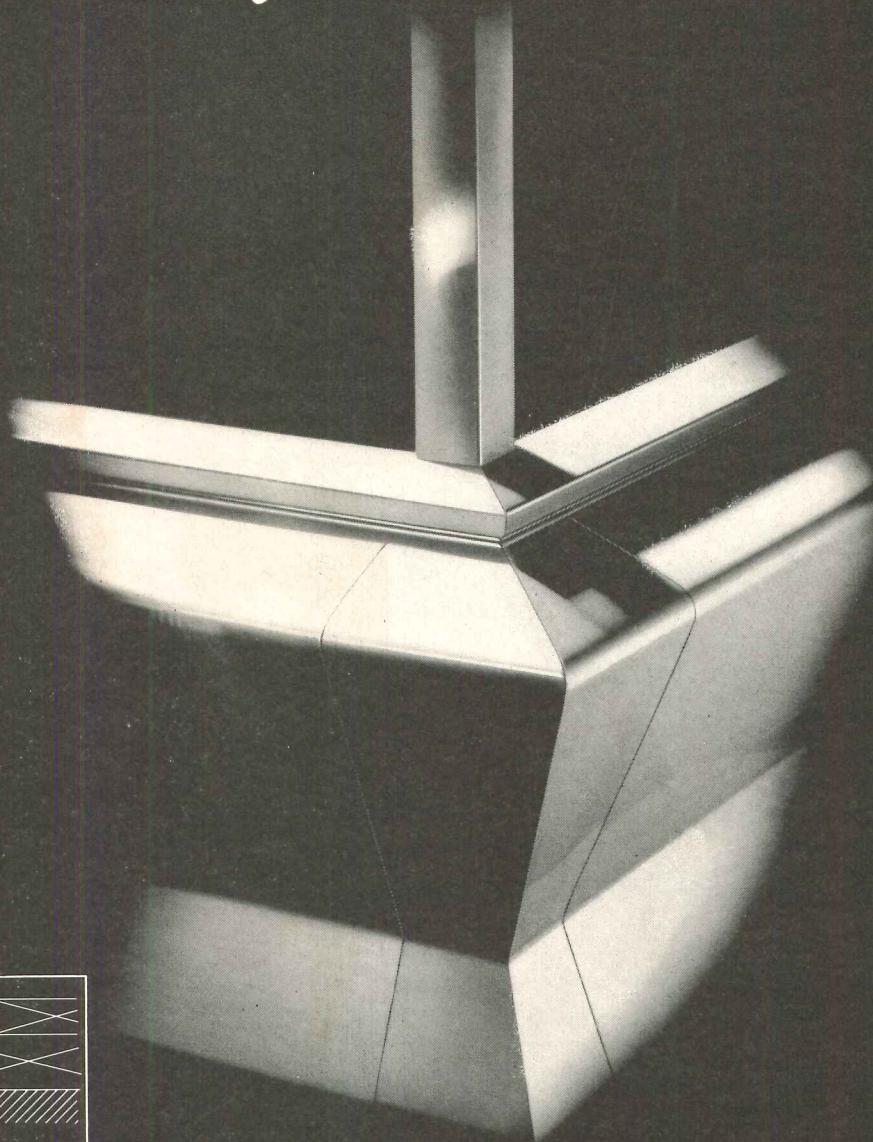

In fact, any angle. This moulding, like all Pittco Metal, has a pleasing way of blending with surroundings, of expressing light and shadow, serving as a sill, an awning fascia or as a decorative band. For complete details, see your Pittco[®] Store Front Metal Representative.



PAINTS · GLASS · CHEMICALS · BRUSHES · PLASTICS · FIBER GLASS

PITTSBURGH PLATE GLASS COMPANY

IN CANADA: CANADIAN PITTSBURGH INDUSTRIES LIMITED

THE RECORD REPORTS

(Continued from page 342)

WEWS TV STATION READIED FOR EARLY 1957 OCCUPANCY

A new building for television station WEWS in Cleveland is nearing completion and should be ready for occupancy in early 1957.

Design for the WEWS Building is based on the station's plan to expand the

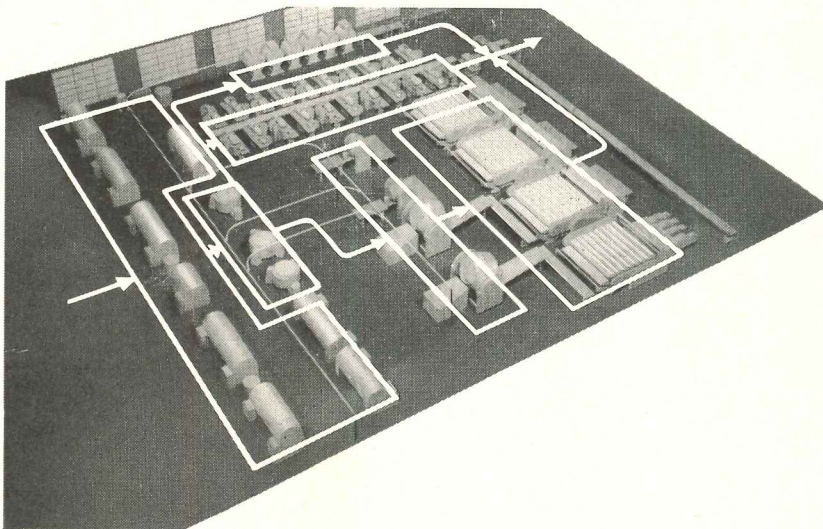
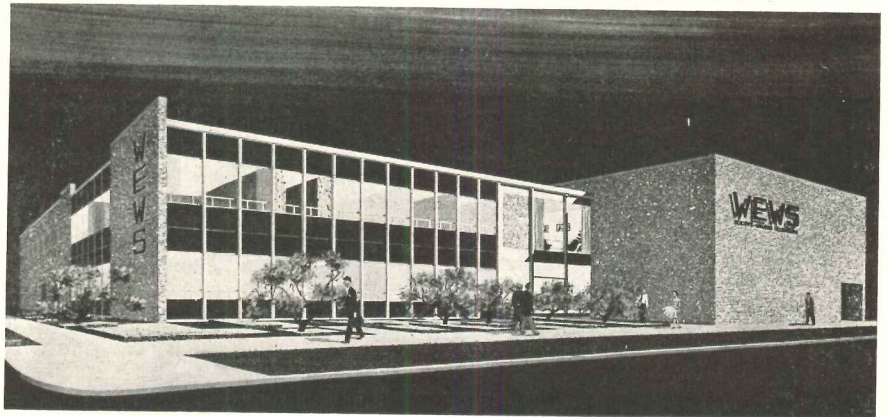

TROY SURVEY SERVICE insures efficient laundry work flow

Whatever the job — a laundry plan for a hospital, hotel, other institution or industrial plant — rely on Troy Survey Service to provide you with an experience-tested laundry layout based on direct work flow — plus modern labor-saving machinery. Your client will be assured the most efficient laundry possible in the least floor space, and will always enjoy prompt, reliable help on maintenance, supplied by Troy's strategically located sales and service offices.

Ask to see the Troy man. Or send for free literature and details on Troy laundry layout service.

Troy
LAUNDRY
MACHINERY

TROY LAUNDRY MACHINERY
Division of American Machine and Metals, Inc.
Dept. AR-1156, East Moline, Illinois

- Have a Troy man call on me.
 Send free literature and details on Troy laundry layout service.
- Type of laundry Hotel Hospital
 Institution Other

FIRM NAME _____
ADDRESS _____
CITY _____ ZONE _____ STATE _____
ATTENTION MR. _____

"World's oldest builders of power laundry equipment"

program of locally produced live telecasts. The building contains 32,000 sq ft of usable floor space with 22,000 sq ft devoted to studio and storage space. Three studios with control rooms will give the station twice its present area for live telecasting. The Austin Company are designers, engineers, and builders of the project.

All three studios and a 540 sq ft lobby are located on the first floor. The largest studio, 54 by 100 ft in area, runs along the east side of the building. One is 54 by 70 by 25, larger than the present big WEWS studio, and the third is 35 by 50 by 25 ft.

The studios are two-stories high and have a centrally located control-room section on the mezzanine level. There is a master control area here, as well as control consoles for individual studios.

A projection room is on the first-floor level directly beneath the control area, and has facilities for film-handling and film-editing directly adjoining it.

A storage and shop area for construction of sets is situated in the center of the plan where it is adjacent to all three studios.

Completing the first floor layout is the program, sales and traffic department offices, newsrooms, program employee lunchroom, talent dressing-room and lounge, engineers locker-room, lounge and lunchroom.

A winding open staircase leads from the lobby up to second-floor offices where the client's reception room and client's screening and audition rooms are located.

Front elevation of the two-story building will have large plate-glass panels alternating with porcelain-finished steel spandrels. Construction is of steel and concrete.

The station is owned by Scripps-Howard Radio, Inc.

(More news on page 346)



Henry W. Carlson Residence, Rock Island, Illinois • Architect: Gerald B. Cox • Builder: H. George Schloemer Construction Co., Davenport, Iowa

Pella® wood folding doors close quietly...suggest new open-plan designs

Separate one end of the living room for use as a den or study — or unite the areas to create a feeling of spaciousness. Divide one large meeting hall into two or more smaller rooms for committee conferences. Conceal a closet or utility area with handsome wood panels — yet retain complete accessibility.

Creative plans such as these are doubly practical with PELLA WOOD FOLDING DOORS — because of their natural-wood beauty — and quiet operation. When doors are folded, surface areas come together flat, capturing and compressing air between panels and muffling operation sounds — makes doors whisper quiet. New, individual

spring hinging of the door panels provides this flat-folding action. The improved spring hinge system also tends to hold door in any position between full-stacked and closed. PELLA doors not only fold quietly — they also have excellent acoustical properties.

PELLA doors can be selected in pine, oak, birch or Philippine mahogany veneers — factory assembled and packaged, complete with hardware and concealing track mould. Representatives in principal cities throughout U. S. and Canada. See our catalog in Sweet's Architectural File, or mail coupon.

Pella®
WOOD FOLDING DOORS

COMPANION PRODUCT TO PELLA WOOD CASEMENTS,
MULTI-PURPOSE WINDOWS AND ROLSCREENS

ROLSCREEN COMPANY Dept. H-110, PELLA, IOWA

GENTLEMEN: Please send Pella Topics No. 69 featuring details on PELLA WOOD FOLDING DOORS, and illustrating 11 different uses. Include name of nearest PELLA representative.

NAME _____

FIRM _____

ADDRESS _____

CITY _____

ZONE _____

STATE _____

THE RECORD REPORTS

(Continued from page 344)

CONTINENTAL OPENS LABS FOR RESEARCH IN CANNING

Continental Can Company recently opened its \$7 million Research and Development Center near Chicago for the study of more efficient design and manufacturing of metal containers. ("Tin cans," they say, is no longer the proper

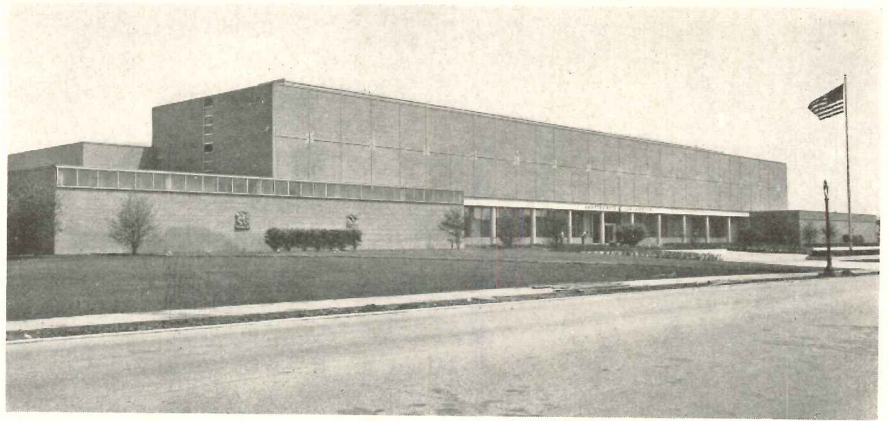

New research center in South Chicago will serve 41 plants in Continental Can's metal division

Prevent Leaks ... in curtain walls

Tremco research, aided by representatives of leading glass manufacturers, has developed new glazing and sealing techniques for curtain wall construction.

You'll find these new specifications important to insure leak-free installations. Ask your Tremco Man for a copy of "NEW PRODUCTS AND METHODS FOR NEW GLAZING AND SEALING PROBLEMS," or write: The Tremco Manufacturing Company, 8701 Kinsman Road, Cleveland 4, Ohio, or The Tremco Manufacturing Company (Canada) Limited, Leaside, Toronto, Ontario.

"When you specify a Tremco product — you specify a Tremco service!"

TREMCO

PRODUCTS AND METHODS FOR BUILDING
MAINTENANCE & CONSTRUCTION



term — modern cans are about 99 per cent steel.)

A three-story structure, the center was designed by architects Schmidt, Garden & Erickson without windows to provide three walls of uninterrupted working space in each laboratory. Windows were included in the executive office and lobby areas, however. The building is completely air conditioned.

To relieve the unbroken facade, the architects employed aluminum cross grids, and commissioned sculptor Milton Horn to do the cast aluminum reliefs on the facade — a farmer, a mother and child and a woman, as people who contribute to or benefit from the canning operation — and four terra cotta reliefs, depicting farming, fishing, research and engineering, to be mounted on the lower section of the facade and at the entrance.

Labs and a Kitchen

Facilities in the 260,000 sq ft building include complete pilot plants for can-making and can closing, as well as equipment to design, produce and test machines to make and close cans. There are also laboratories for chemical, physical and microbiological research, and a 6000-volume library. Since the company is concerned not only with the container but with the contained, the building also houses a test kitchen, and facilities for a tasting panel to develop new cannable foods.

The center, which serves 600 employees, is of flat slab construction with reinforced concrete beams. Interior walls, faced with glazed tile, are hollow and movable. The center was designed to handle the company's projected research needs for the next 25 years.

George A. Fuller Company was the builder.

(More news on page 348)



THE FINAL *touch*
THAT SELLS YOUR HOUSES

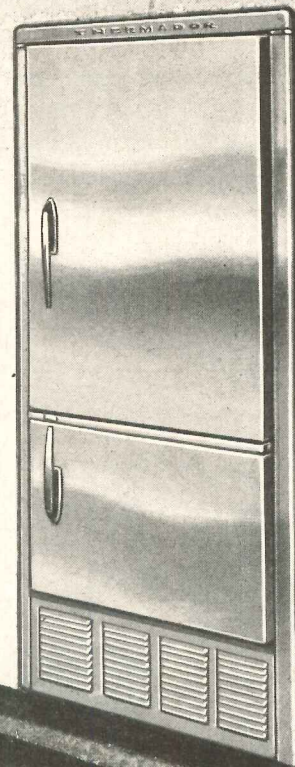
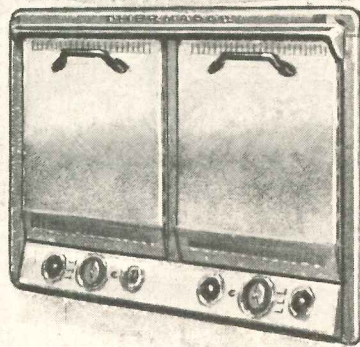

...so perfect to specify
...so easy to install



It's the sensational new
THERMADOR MASTERPIECE
bilt-in Refrigerator-Freezer

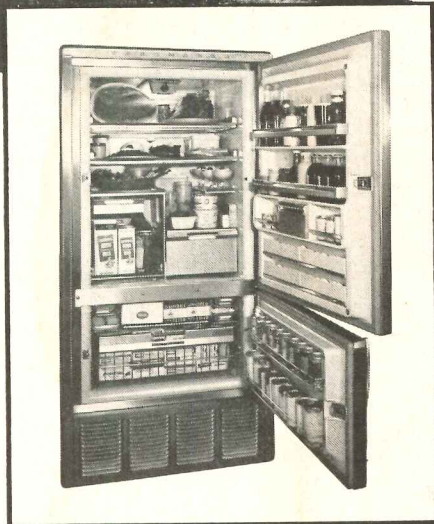

Scientifically proportioned for the modern family's everyday needs, the new Thermador Masterpiece has spacious refrigerator area (10.2 cu. ft.) and ample frozen-food storage space (4.0 cu. ft.). Choice of right or left door.

This new concept in *bilt-in* refrigeration is a real money-maker for the builder because it can be installed so easily and quickly, and at a lower cost.

The architect finds added attraction in this new *bilt-in* refrigerator-freezer... it's so eye-appealing, so practical to work with, and fits into any kitchen decor or room arrangement.

The new Thermador Masterpiece is a self-contained refrigerator-freezer with a single refrigerating system. It's installed on the floor—just slide it into the recess. No need for rigid supports or above-floor bracings to add extra dollars to building costs. No separate ventilating grilles or flues required. These extra advantages mean still *more* money saved.

Thermador was the first with *bilt-in* ovens and cooking tops. Now the new Thermador *bilt-in* Refrigerator-Freezer is the final touch that completes the most modern kitchens... and sells homes for you!

Installed on the floor, the new bilt-in refrigerator-freezer slides easily into recess without need for extra bracings. For complete information send coupon today.

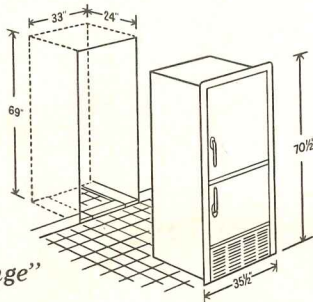

"The Originator of the Bilt-in Range"

THERMADOR

--- MAIL COUPON TODAY ---

THERMADOR ELECTRICAL
MANUFACTURING COMPANY
A Division of Norris-Thermador Corporation
5119 District Blvd., Dept. AR-1156
Los Angeles 22, Calif.

Please send descriptive literature on

- Bilt-in Refrigerator-Freezer
- Other Thermador Products

Please check classification:

- Builder Architect Wholesaler Dealer

Name _____

Address _____

City _____ Zone _____ State _____

THE RECORD REPORTS

(Continued from page 346)

ARCHITECTS' NEW OFFICES USES HEAT PUMP SYSTEM

The Ballinger Company, a Philadelphia architectural and engineering firm, moved recently into a new office building they designed themselves which features floor-to-ceiling glass panels, air source heating and cooling, and luminous ceilings.



planning makes the difference in Kewaunee Educational Equipment

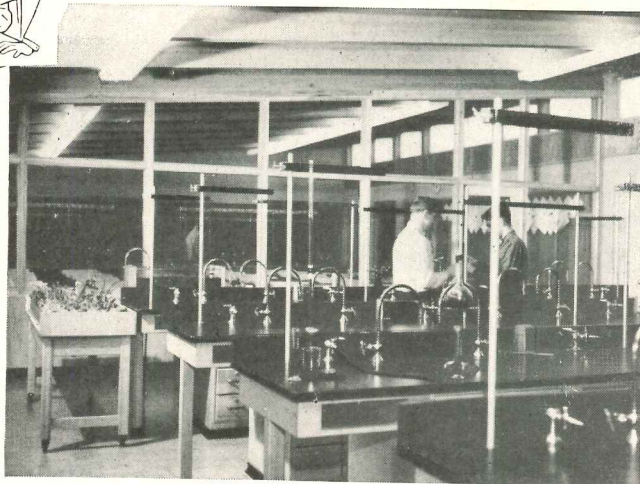

for LABORATORIES, INDUSTRIAL ARTS, HOMEMAKING, FINE ARTS

From first to last—from the initial design of every unit to its final installation—*planning* makes the difference in Kewaunee Educational Equipment.

Based on a half century of experience in the educational field, each Kewaunee unit and complete floor layout is *planned* for maximum classroom efficiency, maximum flexibility, long life and low cost.

Whatever *your* educational equipment needs may be—for science laboratories, or industrial arts, homemaking, and fine arts classrooms—consult Kewaunee. Our *planning* services are yours without cost or obligation.

FREE PLANNING AIDS. New 44-page catalog of Educational Laboratory Equipment, Section 5. Also new 48-page Planning Manual, Section 5A. Write for your copies.

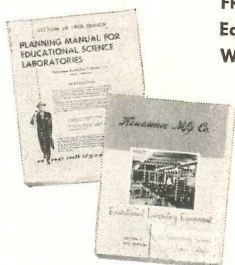

Kewaunee Mfg. Co.

J. A. Campbell, President

5046 S. Center St., Adrian, Michigan

REPRESENTATIVES IN PRINCIPAL CITIES

New home of The Ballinger Company provides space for private offices, conference rooms, general administrative office, file and drawing storage room, equipment rooms, and the architectural drafting room. A partial basement holds power distribution sub-station.

Located on Race Street in Philadelphia, the two-story structure affords 15,840 sq ft of space—7420 sq ft on each level plus 1000 sq ft partial basement. The building has steel frame construction with a tar and gravel roof over insulation, lightweight concrete slab and steel joists.

Frosted blue-green and clear heat-absorbing glass panels run 15 ft high and 36 ft across on the second-floor front of the building. Adjustable vertical blinds are used for sun control.

The heating and cooling system uses air as its only fuel by means of the compound pressure principle. Enough heat is removed from outdoor air—even when the air is below freezing—to produce the hot water which circulates throughout the building. Air is the direct heat source rather than oil, coal, or other fuel. The system is reversed during the hot summer months and the same unit is used to cool the building.

The ceilings in the new Ballinger building consist of suspended fluorescent lighting fixtures beneath which is arranged a grid of metal channels, also supported from above. Corrugated plastic is set in the grid channels, producing a full-lighted ceiling. The architects say this luminous ceiling has the advantages of evenly diffused light, no shadows, no glare, and light of low brightness at any intensity. The intensities developed by the ceiling range from approximately 65 to 80 footcandles at desk level.

The second floor is shared with the Ballinger-Meserole Company, consultants in the mechanics of warehouse distribution.

(More news on page 350)

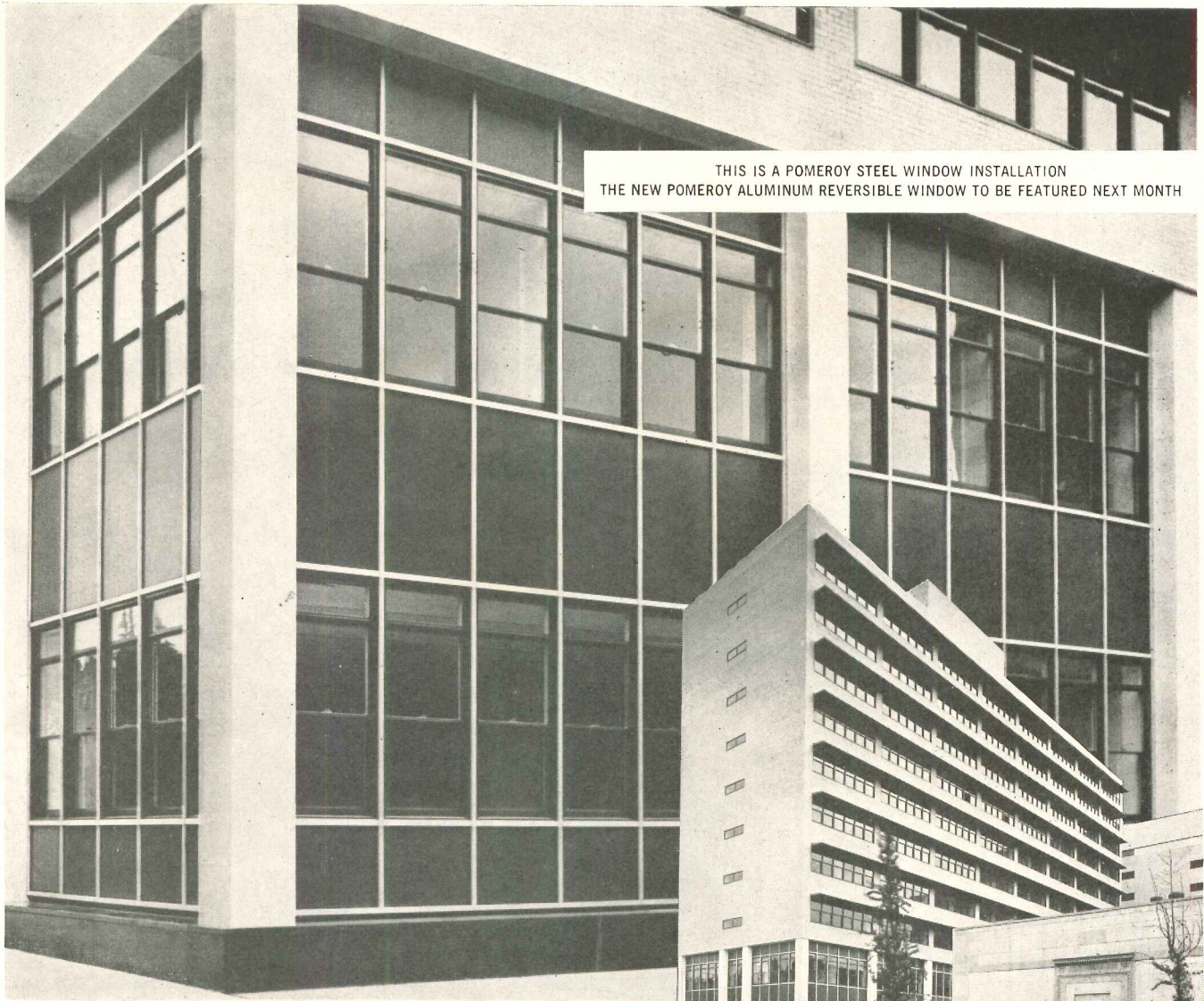

THIS IS A POMEROY STEEL WINDOW INSTALLATION
 THE NEW POMEROY ALUMINUM REVERSIBLE WINDOW TO BE FEATURED NEXT MONTH

TEMPLE UNIVERSITY MEDICAL CENTRE

ARCHITECT: Skidmore, Owings & Merrill
 ASSO. ARCHITECT: James A. Nolen, Jr.
 BUILDER: John McShain, Inc.



INSTITUTIONAL WINDOWS CALL FOR POMEROY

Hospitals and schools by necessity have to be *more critical* and *more aware* of the greater importance that windows play in comfort and convenience. POMEROY windows long recognized for their superior qualities *now* offer advanced designs with important features to complement today's modern construction methods. Call in our engineers for special window treatments to help with your next project.

see our catalog in

 or write for copy

SINCE
POMEROY
 1897

S. H. POMEROY CO., INC., 25 BRUCKNER BOULEVARD, NEW YORK 54, N. Y.

manufacturers of

DOUBLE-
 HUNG
 WINDOWS

VERTICALLY
 PIVOTED
 WINDOWS

CUSTOM-
 BUILT
 ENCLOSURES

SPANDRELS
 SYSTEMS

ACOUSTICAL
 CEILING
 SUSPENSION
 SYSTEMS

METAL
 PARTITION
 STUDS

FABRICATION IN ALUMINUM — STAINLESS STEEL and COATED STEEL

THE RECORD REPORTS

(Continued from page 348)

PUERTO RICO GETS NINTH PRIVATE HOUSING PROJECT

The ninth modern private housing development in Puerto Rico, this one to provide 3200 middle-income houses, is under construction near San Juan.

Architect Edward Larrabee Barnes of New York City designed nine different models for the new project, which will give buyers a choice in size, design, and

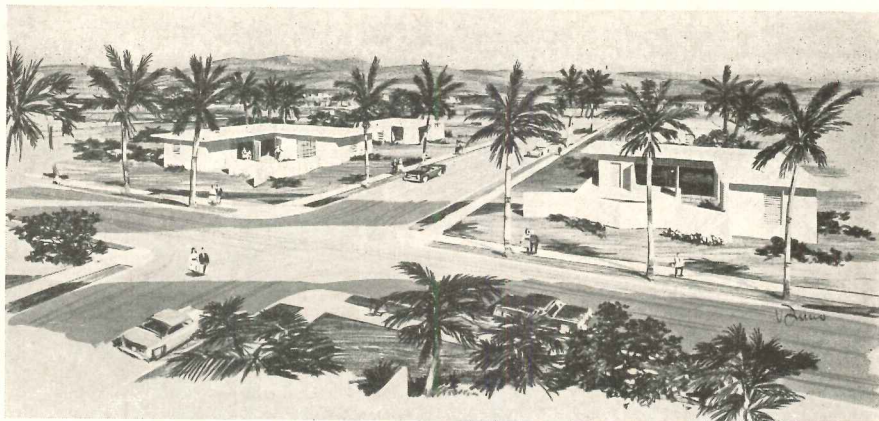

Architects—Engineers

Arrange now for your demonstration of the COUCH Fully-Automatic Audio-Visual Nurse Call System

Dependable performance is the big factor in an automatic nurse call system — the kind of performance offered only by a COUCH system. Call your COUCH representative for a thirty-minute demonstration today.

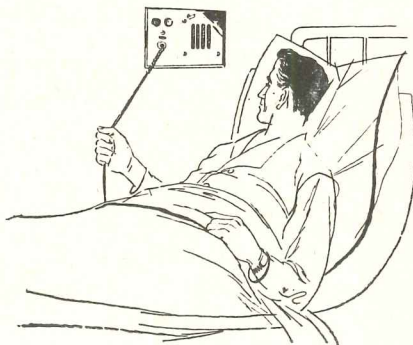

Send for Bulletin #126. For other hospital signalling equipment, ask for Bulletin #125.

Couch also makes

Private Telephone Systems

(Bulletin #121)

Apartment House Phones

(Bulletin #128)

Fire Alarm Systems

(Bulletin #124)

DATA SHEETS AND BULLETINS AVAILABLE UPON REQUEST.

S. H.

Couch

Company, Inc.

NORTH QUINCY 71,
MASSACHUSETTS

**Built-in
Dependability**

cost. Price ranges from \$5690 to \$10,500, and sizes vary from two to four bedrooms.

Ibec Housing Corporation of Puerto Rico is sponsoring the \$25,000,000 project. Ibec is a subsidiary of International Basic Economy Corporation (I.B.E.C.).

The project will be called Lomas Verdes (green hills) community, and will occupy 417 acres of rolling hills south of the city of Bayamon just 25 minutes from the center of metropolitan San Juan.

Since Puerto Rico's mild year-round climate permits maximum indoor-outdoor living, the architect gave special attention to the design of patios and porches of each model. Other features include planting strips inside and out, and extra large carports.

The community of Lomas Verdes will be divided into four neighborhoods, each with its own shopping center, school and parks, located within easy walking distance of every house.

An influx of new industry in Puerto Rico in the last eight years has stimulated a demand for more and better housing to serve the rising managerial class. More than 400 factories have been established on the island since 1948.

The nine private housing developments underway in Puerto Rico will provide some 17,000 middle class homes. Four of the developments have been completed and four are nearing completion. Other projects in San Juan are Puerto Nuevo, Caparra Terrace, Metropolitan, Las Lomas, Buenos Aires, and Los Angeles. Similar developments are located near the island's second and third largest cities, Ponce on the south coast, and Mayaguez on the east coast.

Ibec was founded by Nelson A. Rockefeller and his brothers. Lomas Verdes will be the second housing project in Puerto Rico undertaken by the corporation. The first, Las Lomas, is now nearing completion.

(More news on page 352)

Brunswick announces the newest addition to its famous family of folding gym equipment

BRUNSWICK FOLDING BASKETBALL BACKSTOPS!

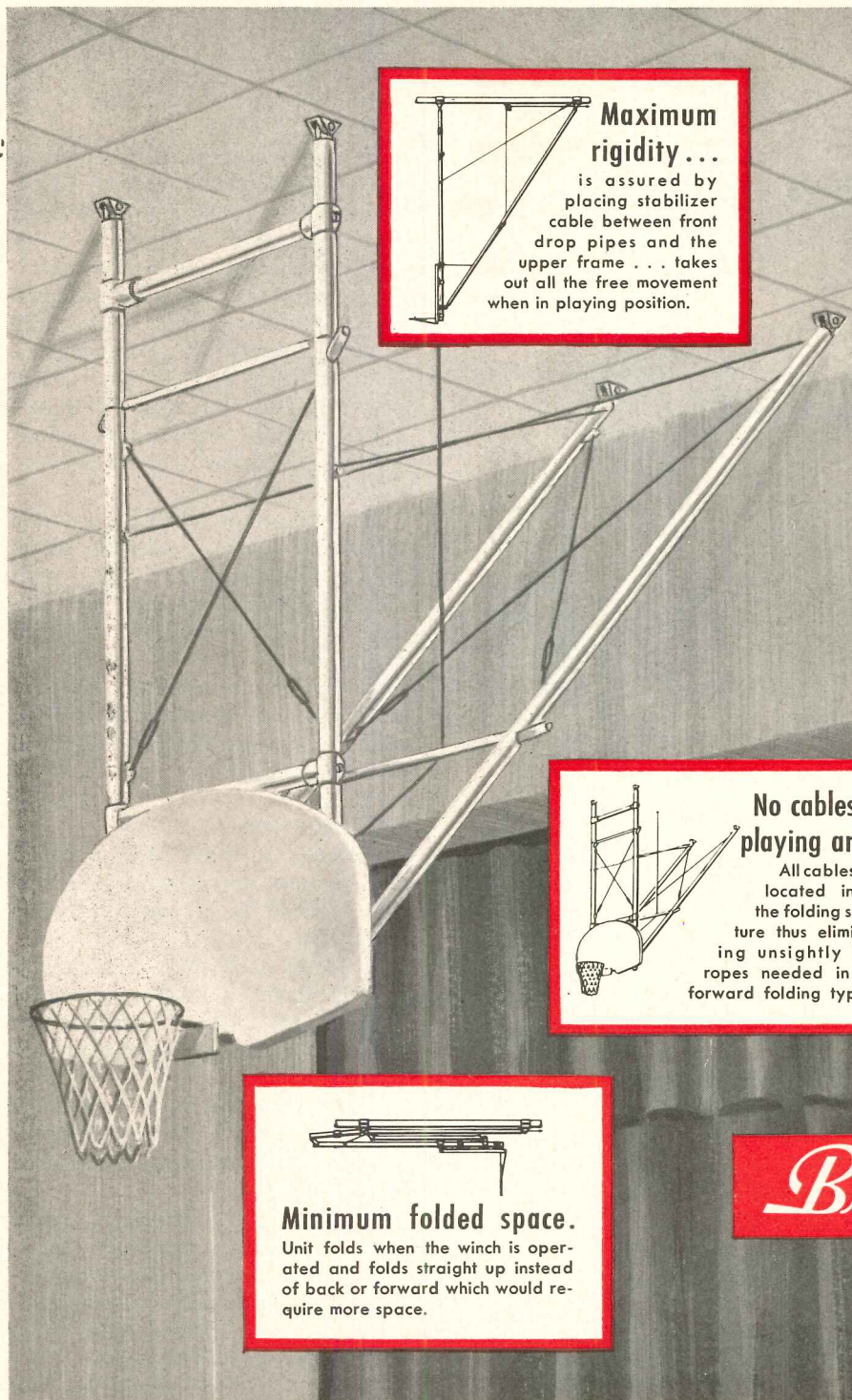

Maximum rigidity...
is assured by placing stabilizer cable between front drop pipes and the upper frame... takes out all the free movement when in playing position.

No cables in playing area.
All cables are located inside the folding structure thus eliminating unsightly pull ropes needed in the forward folding types.

Minimum folded space.
Unit folds when the winch is operated and folds straight up instead of back or forward which would require more space.

Brunswick offers a completely new and different type of folding basketball backstop. It folds flat when not in use. It is rigid when opened. It eliminates cables in the playing area.

Mounting methods vary to meet any gym requirements, including wall, ceiling, side and window-span. There are three types of backboards available: metal, wood and glass. New type operating winch combines safety and appearance with convenience and trouble-free operation.

Talk to your Brunswick-Horn representative or write direct for free illustrated folder.

See SWEET'S $\frac{23k}{Ho}$

Brunswick **Horn**

THE
BRUNSWICK-BALKE-COLLENDER
COMPANY
Horn Division • Marion, Virginia

THE RECORD REPORTS

(Continued from page 350)

NEW CARRIER CORPORATION BUILDINGS BEING ERECTED

New administration, personnel and research development buildings costing about \$5 million are being constructed at the Carrier Corporation's headquarters at Syracuse, N. Y. The center, to

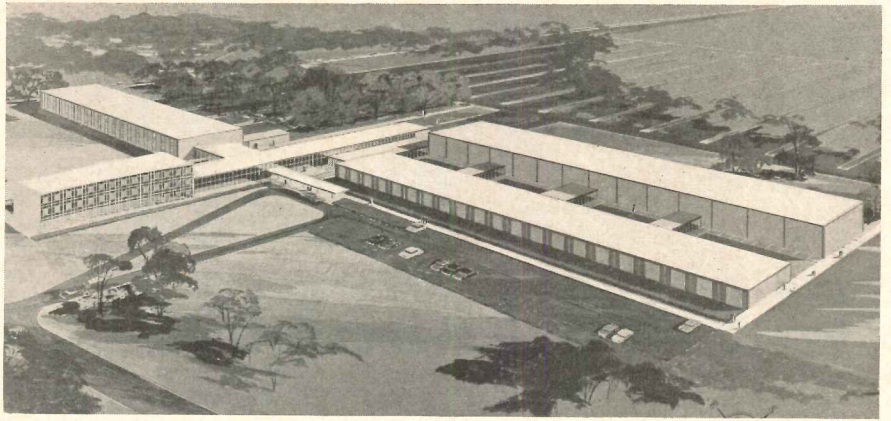

CD
SCHLAGE
SCHLAGE
CD

MANUFACTURER'S LIFE INSURANCE BUILDING
TORONTO, CANADA
ARCHITECTS:
MARANI AND MORRIS

FONTAINEBLEAU HOTEL
MIAMI, FLORIDA
ARCHITECT: MORRIS LAPIDUS

SIMON BOLIVAR GOVERNMENT AND BUSINESS CENTER
CARACAS, VENEZUELA

world-wide symbols of...

HEAVY-DUTY SECURITY

To architects, builders, and owners of commercial and institutional buildings the world over, Schlage's key and latch plate are symbols of precision mechanisms and quality construction... assurances of smooth, efficient lock performance under the most extreme operating conditions.

Engineered by the leaders in lock science, Schlage heavy-duty locks offer many "plus-value" features: a friction ring that eliminates loose roses and bothersome lock rattles, perfect alignment of heavy-gauge spindles, positive latch retraction by heavy cast slides... only a few of the reasons why Schlage heavy-duty locks are the quality standard for the world's finest buildings.

For the latest information on Schlage heavy-duty locks, contact your Schlage representative, or write to Dept. A-11

SCHLAGE SCHLAGE LOCK COMPANY
SAN FRANCISCO • NEW YORK • VANCOUVER, B. C.
Address all correspondence to San Francisco

be built on a site outside of Syracuse, will house the main offices and the central engineering operations of the company.

The new structures will add approximately 400,000 sq ft of space to the corporation's area for a total of nearly two million sq ft. Completion of the project is expected by the end of 1956.

Interconnected administration and research and development buildings will be the largest of the new structures. They will be located on either side of a central service area which will include a main entrance, a combination auditorium and exhibit hall, dining rooms and cafeteria facilities.

The administration building will have two stories, while the other new structures will be single-story. Outer walls will be of light gray masonry brick with strips of black anodized aluminum around the large window areas. The auditorium and the laboratory portion of the research and development building will be windowless. The entire plant will be air conditioned.

Concave Walls

The auditorium will have two solid concave walls. Reception room and exhibit hall will be enclosed with glass panel walls.

Architects and engineers for the project are Schmidt, Garden & Erikson of Chicago, with Carson & Lundin of New York City acting as architectural consultants.

Landscape architects are Clarke & Rapuano, also of New York City.

Completion of the center is scheduled for late this year.

In addition to the building expansion, Carrier Corporation's production facilities will be expanded at a cost of approximately \$5.5 million. The company manufactures air conditioning, refrigeration and heating equipment.

(More news on page 354)