

ARCHITECTURAL RECORD



Copyright 1951 by F. W. DODGE CORPORATION, with all rights reserved • Publishing Director, Magazine Division, H. Judd Payne • Business Manager, Robert F. Marshall • **EDITORS:** Managing Editor, Emerson Goble; Senior Associate Editor, Frank G. Lopez, A.I.A.; Associate Editor, Florence A. van Wyck; Associate Editor (Engineering), Robert E. Fischer; Western Editor, Elisabeth Kendall Thompson; Assistant Editor, Herbert L. Smith, Jr., A.I.A.; Assistant Editor (News), Jeanne M. Davern; Contributing Editors, Ernest Mickel (Washington), Frederic A. Pawley, John Caulfield Smith, M.R.A.I.C. (Canada); Editorial Assistants, Dorothy C. Jackson, Jeanne G. Whitbeck • **DESIGN:** Consultant, M. Peter Piening; Director, Frances Torbert; Assistant, Elaine Sehnert; Drafting, Sigman-Ward • **CONSULTANTS:** Industry Relations Consultant, Thomas S. Holden, Statistical Consultant, Clyde Shute; Field Research Consultant, Clifford Dunnells, Jr.; Public Relations Consultant, Samuel C. Pace.

Architectural Record (combined with American Architect and Architecture) is published monthly by F. W. Dodge Corporation, 10 Ferry St., Concord, N. H., with Editorial and Executive Offices at 119 West 40th Street, New York, N. Y. Western Editorial Office, 2813 Channing Way, Berkeley, Calif. Thomas S. Holden, Pres.; Howard J. Barringer, Vice-Pres. and Treas.; Irving W. Hadsell, Vice-Pres.; Chauncey L. Williams, Vice-Pres.; Sanford D. Stockton, Jr., Secy.; Walter F. De Saix, Asst. Treas.; Edwin H. Freed, Asst. Treas.; Irving B. Satin, Asst. Treas. Member Audit Bureau of Circulation and Associated Business Papers Inc. Architectural Record is indexed in Reader's Guide, Art Index, Industrial Arts Index and Engineering Index. Subscription rates: United States and Possessions, Canada, Cuba, Mexico, Central and South America, and Spain, \$4.50 the year, \$7.50 for two years, \$9 for three years; elsewhere, \$6.50 the year, \$11.50 for two years, \$15 for three years. Single copy \$2. Circulation Manager: Marshall T. Ginn. Every effort will be made to return material submitted for possible publication (if accompanied by stamped, addressed envelope), but the editors and the corporation will not be responsible for loss or damage. Other Dodge Services: Real Estate Record & Builders' Guide, Sweet's Files, Home Owners' Catalog, Dodge Reports & Dodge Statistical Research Service.

THE RECORD REPORTS	11
News from Washington. By Ernest Mickel	17
News from Canada. By John Caulfield Smith	18
Construction Cost Indexes	28
REQUIRED READING	30
THE INTERNATIONAL STYLE 20 YEARS AFTER	89
By Henry-Russell Hitchcock	
NEW CANAAN, CONN., ELEMENTARY SCHOOL AT- TRACTS PROFESSIONAL ATTENTION	98
Many Architects and Educators Are Impressed with South School. Sherwood, Mills & Smith, Architects. O'Connor & Kilham, Consulting Architects	
CLEMSON HOUSE AND CLEMSON HOMES	106
Clemson A. & M. College, Clemson, South Carolina. William G. Lyles, Bissett Carlisle & Wolff, Architects	
HOUSE FOR MR. AND MRS. SAMUEL RUBINSTEIN	114
Seattle, Washington. J. Lister Holmes & Associates, Architects	
ROBERT LINER WATCHMAKER SHOP	120
Beverly Hills, Calif. Mark & Joyce Sink, Designers	
H. J. BURKHARDT OPTOMETRIST SHOP	121
New York City. S. J. Glaberson, Architect	
STORE FOR EDYTHE NELSON, INC.	122
New York City. Schiffer & Klein, Architects-Engineers	
BUILDING TYPES STUDY NO. 177	
RELIGIOUS BUILDINGS	
INTRODUCTION	124
THE CONVENT OF MOUNT ST. MARY	127
Wrentham, Massachusetts. Charles A. Maguire & Associates, Engi- neers. Milton E. Nelson, Architectural Associate	
RESURRECTION CHURCH	132
St. Louis, Mo. Joseph D. Murphy and Eugene J. Mackey, Asso- ciated Architects	
ROSLYN JEWISH COMMUNITY CENTER	137
Roslyn Heights, Long Island, New York	
LUTHERAN STUDENT CENTER AND CHAPEL	140
Ann Arbor, Michigan. Ralph W. Hammett, Architect	
THE FIRST BAPTIST CHURCH	142
Long Beach, California. Kenneth S. Wing, Architect	
ARCHITECTURAL ENGINEERING	
TECHNICAL NEWS AND RESEARCH	
U. S. PROGRESS IN PRESTRESSED CONCRETE	148
A Pioneer Building Uses a New Technique at Prestressing. Bryan and Dozier, Engineers	
SCHOOL COSTS APPRAISED BY QUALITY VALUES ..	156
PRODUCTS . . . For Better Building	159
LITERATURE FOR THE OFFICE	160
TIME-SAVER STANDARDS	163
Radiant Heating Systems for Houses — 1, 2, and 3: Hot Water. By William J. McGuinness	
INDEX TO ADVERTISEMENTS	6

INDEX TO ADVERTISING

MANUFACTURERS' PRE-FILED CATALOGS
 Symbols "a", "b", and "e" indicate that catalogs
 of firms so marked are available in Sweet's Files
 as follows:

- a—Sweet's File, Architectural, 1951
- b—Sweet's File for Builders, 1951
- e—Sweet's File, Engineering, 1951

ab Acme Appliance Mfg. Co.	20	a Haws Drinking Faucet Co.	264	a Paulding, John I., Inc.	78
abe Adam, Frank Electric Co.	75	a Haynes Products Co.	268	Perma Products Company	264
Aerofin Corporation	274	a Hilliard Chemical Co.	224	ab Pittsburgh Plate Glass Co.	46-236-237
Air Devices, Inc.	249	ab Homasote Company	29	ab Pittsburgh Steel Product Company	63
a Albarano Stone Corp. of Virginia	265	a Hope's Windows, Inc.	68	Powers Regulator Co.	19
a Allon, W. D. Manufacturing Co.	264	a Horn, A. C. Company	178	Preferred Utilities Mfg. Corp.	268
ab Allied Chemical & Dye Corp.	72	House & Garden			
Aloe, A. S. Co.	276	ab Hunter Fan & Ventilating Co., Inc.	234		
a Alumiline Corporation	252			Radio Corporation of America	218
ae Aluminum Company of America	66-67			ae Ramsel Fasteners, Inc.	192
ab Aluminum Window Mfgs. Assoc.	258	a Imperial Brass Mfg. Co.	16	ae Raynor Mfg. Co.	278
a American Air Filter Company, Inc.	185	Infra Insulation, Inc.	15	a Republic Steel Corporation	69-273
ae American Blower Corporation	259	ae Inland Steel Company	277	ab Revere Copper & Brass, Inc.	275
a American Seating Company	254	ab Inland Steel Products Company	166	abe Reynolds Metals Company	59-174
a American Steel & Wire Co.	53	ab Insulite Division	256	Richmond Radiator Co.	59
abe American Structural Products Co.	255			a Rilco-Laminated Products, Inc.	219
ab American Welding & Mfg. Co.	180			a Roberts Co.	175
a Anemostat Corp. of America	270	a Jackson & Church Co.	3rd Cover	ae Robertson, H. H. Co.	201
Architectural Record	240-241	Jenkins Bros.	43	ab Roddis Plywood Corporation	246
abe Armstrong Cork Company	269	ae Johns-Manville	40	ab Roliscreen Company	186
Art Metal Company	244	Johnson, S. T. Co.	278	a Rotary Lift Co.	226
abe Asbestone Corporation	23	ae Josam Manufacturing	272	ae Rust-Oleum Corporation	191
ab Associated Plywood Mills, Inc.	58	a Just Manufacturing Co.	76		
				Samson Cordage Works	276
ae Barber-Colman Company	257	abe Kaylo Division	231	a Sarco Company, Inc.	170
abe Barrett Division	72	ab Kentile, Inc.	177	ae Scott Paper Company	247
ab Bell Electric Company	250	a Kennecott Copper Corp.	164	ae Servicised Products Corp.	252
ab Bell & Gosselt Company	87	ab Kewanee Boiler Corporation	80	Shepard Elevator Company	262
ab Bell Telephone System	34	Kohler Co.	64	ab Siskrafft Co.	260
abe Bethlehem Steel Company	48	ae Koppers Company, Inc.	270	ae Sloan Valve Co.	4th Cover
abe Bilco Company	260	ab Kwikset Sales and Service Company	2nd Cover	a Smith, H. B. Co., Inc.	217
Books	248-272			Sola Electric Co.	226
a Brasco Manufacturing Co.	268	a LCN Closers, Inc.	209	Soss Manufacturing Company	198
Breidert, G. C. Co.	82	Laclede Steel Company	182	Square D Company	45
Brown Company	50	LaSalle Products Inc.	234	ab Standard Dry Wall Products	42
ab Bruce, E. L. Co.	51	ab Libbey-Owens-Ford Glass Co.	84	a Steel & Tube Division	69
Bulldog Electric Products Co.	215	a Litecontrol Corporation	52	Sterling Hardware Company	250
a Bundy Tubing Company	179	Lone Star Cement Corp.	1	abe Stran-Steel Division	83
Burnham Corporation	260	a Lorio Iron Works	252	Superior Electric Co.	172
ae Burt Manufacturing Co.	196	ab Louisville Cement Company, Inc.	187	ab Surface Combustion Corporation	24
a Byers, A. M. Company	4	ab Ludman Corporation	197	Sweets Catalog Service	210-211
		ab Ludowici-Celadon Company	22	a Symmons Engineering Co.	78
C-O-Two Fire Equipment Co.	267				
ab Cabot, Samuel, Inc.	216	ae Macomber, Incorporated	239	a Tile Council of America	35
Cambridge Tile Mfg. Co.	77	ae Mahon, R. C., Company	31	abe Tile-Tex Division	227
ae Philip Carey Mfg. Company	181	a Marble Institute of America, Inc.	274	Timber Engineering Company	200
Cast Iron Soil Pipe Institute	207	Market Electric Products, Inc.	234	ae Timber Structures, Inc.	33
ab Cast Steel Products Corp.	74	ab Marsh Wall Products, Inc.	233	a Titus Mfg. Corp.	256
abe Celotex Corporation	213	a Marvin Manufacturing Co.	276	ab Trade-Wind Motofans, Inc.	232
a Century Lighting Inc.	26	Masland Duralath Co.	270	abe Trane Company	202-203
ae Certain-teed Products Corp.	245	a Medart, Fred Products, Inc.	79	a Tremco Mfg. Co.	272
Certified Ballast Manufacturers	49	ab Mengel Company	65	a Trinity Portland Cement Division	266
a Chase Brass & Copper	164	Meyer Furnace Co.	208	ae Trumbull Electric Mfg. Co.	27
Cleaver-Brooks Company	57	a Michaels Art Bronze Co., Inc.	222	a Tuttle & Bailey, Inc.	85
Committee on Steel Pipe Research	86	Miller Company	228		
a Concrete Reinforcing Steel Institute	229	ae Mills Company	205	ae United States Air Conditioning Corp.	263
Connor, W. B. Engineering Corp.	250	ab Minnesota & Ontario Paper Co.	256	ab United States Plywood Corp.	238
a Corning Glass Works	221	a Minwax Co., Inc.	230	United States Rubber Company	220
ae Coyne & Delany Co.	88	ae Mississippi Glass Company	161	ae United States Steel Corp. Subsidiaries 53-242	253
b Crane Co.	56	Monroe Company	258	a Universal Atlas Cement Company	253
Crucible Steel Co. of America	183	ae Moore, P. O., Inc.	278	Uppco Co.	274
ab Cuprinal Division	262	ab Mosaic Tile Company	70-71	a Uvalde Rock Asphalt Co.	206
a Cutler Mail Chute Co.	278				
		a Nator Store Fronts	256	Van-Packer Corporation	204
ab Darworth, Inc.	262	National Clay Pipe Manufacturers, Inc.	67		
Dodge, F. W. Corporation	210-211	abe National Fireproofing Corp.	261	ae Wakefield, F. W. Brass Co.	251
Dravo Corporation	266	a National Gypsum Company	235	Wallace, William Company	194
		a National Radiator Company	254	ae Webster, Warren & Co.	224
Eastman Kodak Company	39	abe National Steel Corporation	83	West Coast Lumbermen's Association	47
Electric Storage Battery Co.	271	a National Terrazzo & Mosaic Assoc., Inc.	212	ab Westinghouse Electric Corp.—Elec. Appliance Div.	41
a Electro Manufacturing Corp.	280	National Tube Co.	242	Westinghouse Electric Corp.—Lighting	223
Employment Opportunities	254	ae Nelson, Herman Division	185	Weyerhaeuser Sales Company	25
		a Neo-Ray Products, Inc.	258	ae Wheeling Corrugating Company	60-61
Faber, A. W., Castell Pencil Co.	230	ae Nesbitt, John J., Inc.	199	Wood Window Program	21
a Fairbanks-Morse & Co.	44	Nichols Wire & Aluminum Co.	82	a Wright Manufacturing Co.	32
ae Federal Cement Tile Company	274	ab Nova Sales Co.	29		
Federal Seaboard Terra Cotta Corp.	276	NuTone, Inc.	8-9		
a Fenestra Building Products	188-189			Yale & Towne Manufacturing Co.	2-3
a Fitzgibbons Boiler Company	162	a Ohio Can & Crown Co.	76		
abe Flintkote Company	227	a Otis Elevator Company	168	abe Zonolite Company	184
ab Fremont Rubber Company	173	abe Owens-Corning Fiberglas Corp.	243		
		abe Owens-Illinois Glass Company	231-255		
General Electric Co., Apparatus	193				
ab General Electric Co., Home Bureau	54-55	ab Paine Lumber Co., Ltd.	225		
General Electric Co., Wiring	10	a Parkwood Laminates, Inc.	266		
a General Portland Cement Co.	266				
ae Globe Hoist Company	190				
Governair Corporation	214				
a Granco Steel Products Co.	176				
ab Grant Pulley & Hardware Co.	232				
abe Great Lakes Steel Corporation	83				
Guth, Edwin F. Company	195				
a Hachmeister, Inc.	7				
a Hager, C., & Sons Hinge Mfg. Co.	38				
Hall-Mack Company	81				
ab Haskelite Manufacturing Corp.	73				
ae Hauserman, E. F. Company	36-37				

NEW YORK—H. Judd Payne, Publishing Director; Robert F. Marshall, Business Manager; Tom Tredwell, Advertising Mgr.; Benton B. Orwig, Creative Service Manager; M. A. Murphy, Advertising Production Manager, 119 West 40th Street; BOSTON—Herry M. Horn, Jr., 855 Park Square Bldg.; CHICAGO—C. B. Riemersma, Robert T. Fanden, John M. Cogan, 700 Merchandise Mart; CLEVELAND—John C. Jackson, David K. Bortz, 321 Hanna Bldg.; DALLAS—Joe Sanders, 2909 Maple Ave.; DENVER—Allan Clevenger, 1217 Welton St.; LOS ANGELES—Bob Wettstein, 672 South Lafayette Park Place; PHILADELPHIA—Tom Tredwell, 1321 Arch St. PORTLAND—Bob Wettstein, 907 Terminal Sales Bldg.; SAN FRANCISCO—Bob Wettstein, Howard Bldg., 209 Post St.

THE RECORD REPORTS

HOUSING MATERIALS ANALYSIS SUGGESTS DWELLINGS USE LITTLE CRITICAL METAL

"Housing and the Emergency," Part I, by Leonard Haeger, Shows Small Materials Gain in Reducing Usage by Units

A DETAILED ANALYSIS of metals and cement requirements in house building, *Housing and the Emergency*, Part I, has been prepared by Leonard G. Haeger, materials expeditor for the National Association of Home Builders, in cooperation with the N.A.H.B.-Producers' Council Committee on Production and Distribution of Building Materials.

The study points out that no great savings in critical materials can be expected from the house building industry considering the small proportion of these materials that go into dwelling unit construction.

While the home building industry will account for nearly 33 per cent of the dollar volume of the entire construction industry in 1951, the analysis reports residential construction will require only 13 per cent of the steel, 26 per cent of the copper and eight per cent of the aluminum used by the construction industry.

In 1952, the study shows, new housing produced at the rate of 850,000 units would require 1.88 per cent of the total production of steel (as a percentage of product tons), 6.05 per cent of the production of copper and 1.33 per cent of the production of aluminum. At the rate of 1,000,000 units, new housing produced next year would take 2.22 per cent of the production of steel, 7.11 per cent of the production of copper and 1.56 per cent of the production of aluminum.

The analysis summarizes the conclusions as follows:

"First, in relation to housing's importance to the national economy and the national health and welfare, housing's requirement in terms of critical materials is extremely small and represents a very small drain on the production of these materials. Second, while all concerned in the home building industry are willing and ready to conserve critical materials, the fact remains that the amounts involved per dwelling unit are

so small that attempts to reduce usage by individual dwelling unit will result in small gains."

Finally, the study concludes, "Coupled with these facts, the importance to the national welfare of the maintenance of an adequate housing supply to serve the ever-expanding need speaks against any policy of further reduction of housing, either in number of units or in quality."

The report notes that if 850,000 dwelling units are built this year, it will require only 1,586,100 product tons of steel, 127,075 tons of copper, 19,975 tons of aluminum and 549,000 tons of cast iron. One million dwellings will require 1,866,000 product tons of steel, 149,500 tons of copper, 23,500 tons of aluminum and 647,000 tons of cast iron.

All new construction in 1951, now estimated at \$25,700,000,000 or 8.7 per cent of the gross national product, will require about 14,497,100 product tons of steel, 583,362 tons of copper and 271,000 aluminum, the study shows. Expressed as percentages of total production these requirements would be: steel, 18.30; copper, 29.53; and aluminum, 19.35.

There are tables showing end uses of steel and iron, copper and aluminum in the United States by per cent of total consumption and one showing expected distribution of estimated new construction in 1951. There are also figures on estimated consumption of steel, copper and aluminum for the entire construction industry by types of construction, in residential, private non-residential and public non-residential categories.

Beyond summary tonnage figures, there are also detailed figures on metals for specific products going into house building. For example, the appendix on steel and iron shows that for each dwelling unit built during 1951, the average requirement will be 255 lb of girders, 280 lb of sheet metal duct work, 153 lb of gas piping.

These appendices, on copper and alu-

minum as well as steel and iron, are based on a summary of the characteristics of individual dwelling units built in this country in 1950. Source was "the experience of the home building industry, with substantial reliance on the housing characteristics as developed to date in the Housing and Home Finance Agency's survey of approximately 30,000 dwelling units insured by FHA." Some of the characteristics reported are: 64 per cent of the houses were basementless; 80 per cent had warm air heating of some type; 60 per cent used gas for fuel; 72 per cent had frame walls.

A comparison of production of a group of building materials commonly used in the home building industry shows production in the first quarter of 1951 substantially exceeded production in the early months of 1950. Production of fabricated structural steel, for example, was 422,000 tons for first quarter 1950; 526,000 tons fourth quarter 1950; and 541,000 tons first quarter 1951.

Charts which are part of the study show steel, copper and aluminum production, projected through 1953, in terms of expected civilian and defense consumption; end users of these metals; and gross national production, and relationship to it of defense, of construction and of home building.

Copies of the analysis are available in booklet form from N.A.H.B., 1028 Connecticut Ave., N.W., Washington 6, D. C.

Building Sets New Mark For Six Months of 1951

Another construction record was made when contracts awarded in the 37 states east of the Rockies for the first six months of 1951 reached an all-time high of \$8,808,109,000, F. W. Dodge Corporation announced.

The new six-months record was 29 per cent over the previous top of \$6,854,148,000 for the first half of 1950.

June 1951, 45 per cent under the all-time monthly high of \$2.5 billion for May 1951, still was five per cent over June 1950.

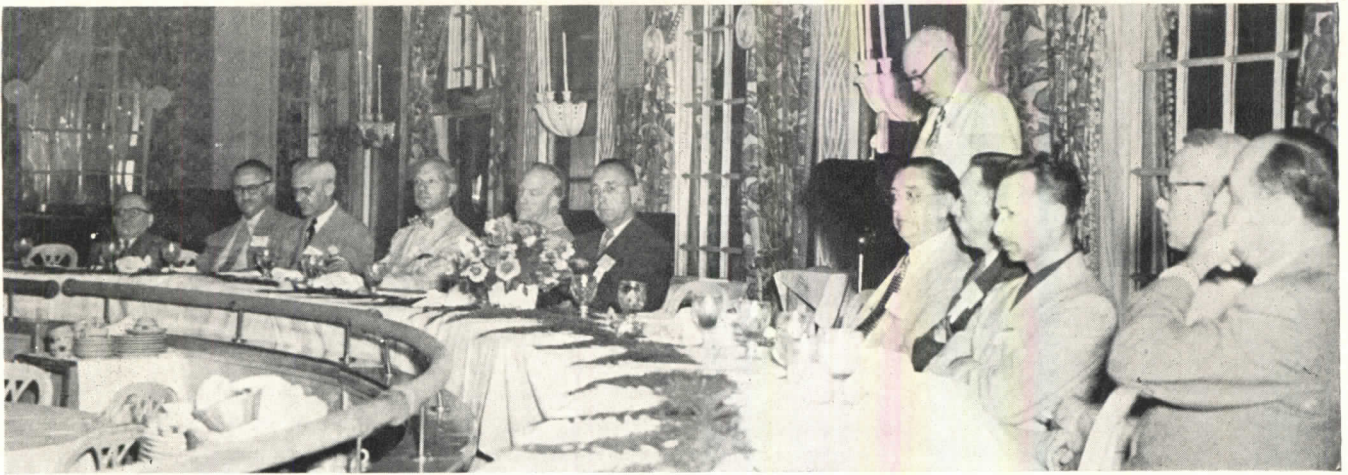

At the New Jersey conference (left to right): three A.I.A. chapter presidents — Samuel M. Moreno, Rhode Island, Maurice Uslan, Staten Island, and Ralph Marx, Bronx; Julian E. Berla, past president, Washington-Metropolitan Chapter, A.I.A.; Mayor George A. Smock, Asbury Park; A.I.A. Regional Director C. E. Silling;

Lauren V. Pohlman, retiring New Jersey president; F. Ferdinand Durang, convention chairman; Thomas H. Creighton, Progressive Architecture; Dean Pietro Belluschi, M.I.T. School of Architecture and Planning; Emerson Goble, ARCHITECTURAL RECORD; and S. Z. Moskowitz, president, Northeastern Pennsylvania Chapter, A.I.A.

NEW JERSEY-MIDDLE ATLANTIC CONFERENCE CONSIDERS TODAY'S ARCHITECTURE, A.I.A. FUNCTIONS, DEFENSE

ARCHITECTS from New Jersey, Pennsylvania, Maryland, West Virginia and Washington, D. C., convened at Asbury Park late in June for a three-day joint meeting of the Middle Atlantic District of the American Institute of Architects and the New Jersey Society of Architects. Host was the New Jersey Chapter, A.I.A. Top A.I.A. officials present included President Glenn Stanton, Secretary Clair W. Ditchy, Executive Director Edmund R. Purves and his assistant, Frederick Gutheim, Walter A. Taylor, director of Education and Research, William Demarest Jr., A.I.A. secretary for modular coordination, and the district's own regional director, C. E. Silling.

Pietro Belluschi, dean of the School of Architecture and Planning at the

Massachusetts Institute of Technology, and Morris Ketchum Jr., of the New York architectural firm of Ketchum, Giná and Sharp, drew conference discussions into the context of the profession's present concern with architecture and humanity. They were the major speakers on the opening panel on contemporary architecture.

A.I.A. functions and services to the profession were set forth in talks by all the A.I.A. officials present; and architectural editors Thomas Creighton of *Progressive Architecture*, Douglas Haskell of *The Magazine of Building* and Emerson Goble of ARCHITECTURAL RECORD were speakers at a breakfast session.

"National Defense and the Architect" was the announced theme of the

conference; and speeches by government and civil defense leaders highlighted three sessions. Resolutions passed by the architects deplored confusion in existing controls and urged national A.I.A. effort to speed clarification of the building outlook.

Elmer S. Tuthill of Summit was named to head the New Jersey A.I.A. Chapter and the New Jersey Society of Architects. Also elected were: J. Raymond Knopf, Camden, first vice president; Romolo Bottelli Jr., Newark, second vice president; Frederick A. Elsasser, Union, treasurer; Eugene M. Dennis, Elizabeth, secretary. D. A. Hopper Jr., Irvington; C. Willard Wands, Caldwell; Clinton D. Seaman, Newark; and N. Lester Troast, Passaic, were elected chapter directors; and Carl O. Kaiser, Leonia, was named society director-at-large.

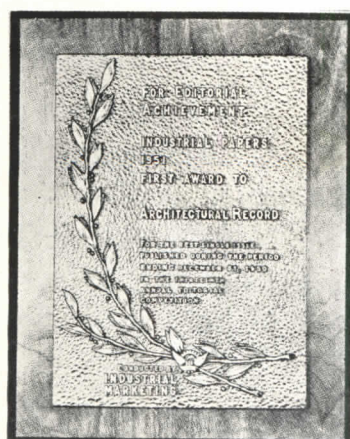
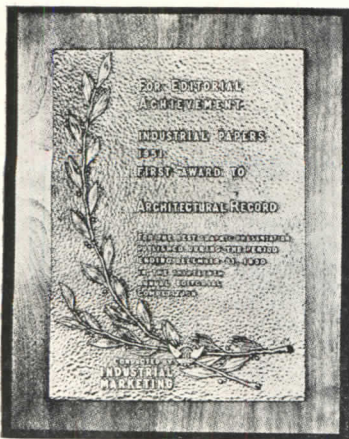

Industrial Marketing, a professional magazine for those who plan and execute sales promotion programs for manufacturers, annually makes awards to business publications for editorial excellence. In this year's competition, a jury appointed by Industrial Marketing to elect winners had to sift more than 600 entries. Of seven First Awards, ARCHITECTURAL RECORD won two: one for the best single issue of 1950 — the October issue, with *Building Types Studies* on schools and mental hospitals, and the other for the best graphic presentation of 1950 — "Architecture in Hawaii," in the October and November issues. In addition, the RECORD won two Awards of Merit for outstanding original research in 1950: for the *Building Types Study* on motels, in the March issue, and "Next Year's Boom Will Be Different," in the November issue.

VIRGINIA A.I.A. BRIEFED ON PROSPECTS FOR JOBS

MEMBERS OF VIRGINIA CHAPTER of the American Institute of Architects, many of them comfortably busy with work for the armed forces and government, took three days out in June for a spring meeting of their chapter and were rewarded with a heartening picture of even more work to come and of better ways to accomplish it.

Meeting at the Chamberlin Hotel, Old Point Comfort, the architects heard Col. W. F. Powers, district engineer for the Army's Norfolk District, outline his plans for his district's huge (currently \$42 million) construction program, plans that include a place for private firms.

William Demarest Jr., A.I.A. secretary for modular coordination, presented his study of that system, and Virginia architects were impressed with what they felt might be the answer to a larger volume of better planning, in spite of the handicap of war-depleted staffs.

Members also heard a plan to "make the architect felt in the political community." Presented by former Chapter President Marcellus Wright Jr., now head of the Subcommittee on Implementation of the chapter's Legislative Committee, the plan envisions continuing action by the chapter in opposing bureaucratic architecture in Virginia.

The chapter's concern with political activity in the state stems from an extensive and successful battle during the 1950 legislative session, when it mustered its forces to defeat establishment of a Virginia State Department of Architecture, which would have been charged with architectural planning for the state.

The Governor of Virginia's Research Committee on School Construction presented the chapter with a summary of its comprehensive plan for studying, analyzing, revising and modifying school building codes now in use in the state.

HHFA BACKS RESEARCH ON MULTI-STORY APARTMENTS

MULTI-STORY APARTMENT BUILDING construction will be the subject of research at Illinois Institute of Technology under a contract awarded to the Institute by the Housing and Home Finance Agency.

The Institute's civil engineering department will do the work under the direction of Elmer I. Fiesenhiser, associate professor of civil engineering, with supervision from HHFA's Division of Housing Research, of which Richard U. Ratcliff is director.

Part of the study will be done under a subcontract by Howard T. Fisher and Associates of Chicago, architectural engineering consultants. The Structural Clay Products Research Foundation, which has been carrying on a broad program aimed at lowering "in-the-wall" costs of masonry construction, has made plans to assist in the new HHFA project.

Development of building methods to cut costs and save manpower and critical materials needed in the defense program is an immediate objective of the research. It will be sought through adaptation and application of advanced developments in materials, use of space, structural and mechanical design, assembly and installation of equipment.

Long-range objective is finding a way for the building industry to produce

more housing at lower costs for more lower income families.

The work will be keyed initially to the specific needs of the Chicago Housing Authority in connection with its low-rent housing program.

All the essential structural features will be covered in the investigation — footings, frames, walls and partitions, floor systems, roof, stairwells, etc. There will be no attempt to develop new materials and compounds, but the researchers will try to locate, investigate and adapt items and ideas already developed and demonstrated.

It is hoped that the work will encourage building industry groups to supply technical and economic data on new materials and methods and to stimulate development within their own areas.

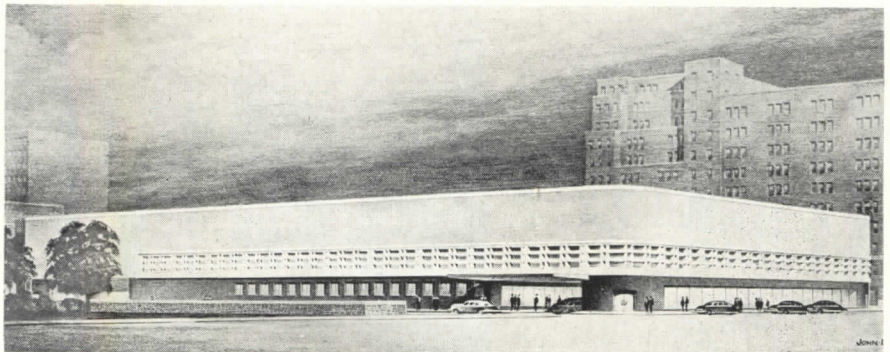

New York's \$5,500,000 East Side Airlines Terminal, on a 400- by 200-ft plot adjacent to the Manhattan approach to the Queens Midtown Tunnel, will replace 11 different passenger loading centers now used by the city's 21 airlines. The story-and-a-half building will have basement bus facilities, public parking for 275 cars on the roof. Horseshoe-shaped loading area will surround 25,000-sq-ft lobby. Triborough Bridge and Tunnel Authority expects completion within two years. Architect is John B. Peterkin

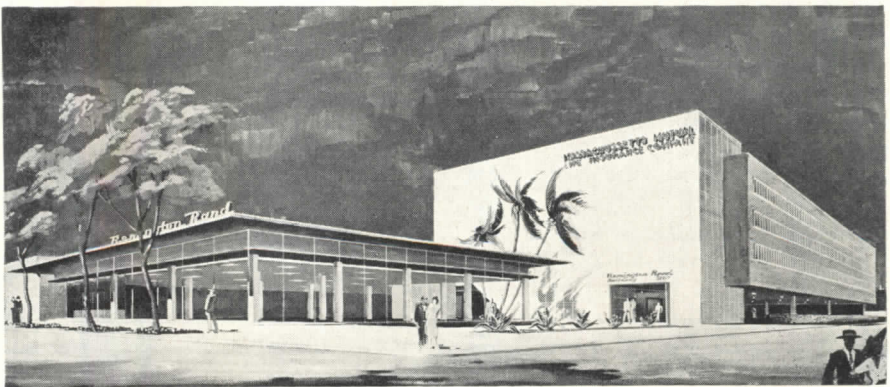

Kahn and Jacobs and Welton Becket and Associates are architects for this Massachusetts Mutual Life Insurance Company project in Los Angeles. The glass pavilion will be a display center for Remington Rand, which will have both buildings on long-term lease. The four-story office building, joined to the pavilion by a conference room, will have a first floor devoted to covered parking. Facade will be marble, with red brick facing; windows shielded by vertical louvers. Mutual will lease back top floor for agency

FOLLIN RETURNS TO DPA FOR CONSERVATION ROLE

JAMES W. FOLLIN has returned to the Defense Production Administration to head a new push to conserve building materials in government construction projects, including military facilities. Four standards already have been proposed for adoption by 11 federal agencies.

Mr. Follin, who resigned several months ago as chief of the Construction Controls Division of the National Production Authority, is chairman of a new subcommittee of the DPA's Conservation Coordinating Committee. His group will investigate present conservation techniques and encourage their application where possible in federal building.

A special group headed by Louis Orendorff of the Housing and Home Finance Agency will investigate use of modular

coordination for the subcommittee, and a contract already has been arranged with the Building Research Advisory Board to supply technical services in identification of conservation efforts and collection of materials on the subject from each of the eight federal agencies with substantial building programs.

The four standards already recommended for adoption are:

1. *Structural Steel Construction* — "Specifications for Design, Fabrication, and Erection of Structural Steel for Buildings (Riveted, Bolted and Arc-Welded Construction)," revised June 1949. Copies available from the American Institute of Steel Construction, 101 Park Ave., New York 17.

2. *Reinforced Concrete Construction* —

"A.C.I. Standard Building Code Requirements for Reinforced Concrete (A.C.I. 318-'51)." Copies available from American Concrete Institute, 18263 W. McNichols Road, Detroit 19, Mich.

3. *Lumber and Timber Construction* — "National Design Specification for Stress-Grade Lumber and its Fastenings, 1944; Revised 1950." Copies available from the National Lumber Manufacturers Association, Washington, D. C., at 25 cents each.

4. *Plumbing* — "The National Plumbing Code," June 1951. Copies of this code, developed by the National Plumbing Code Committee and issued jointly by the U. S. Department of Commerce and the Housing and Home Finance Agency, available from the Superintendent of Documents, U. S. Government Printing Office, Washington 25, D. C., at 50 cents each.

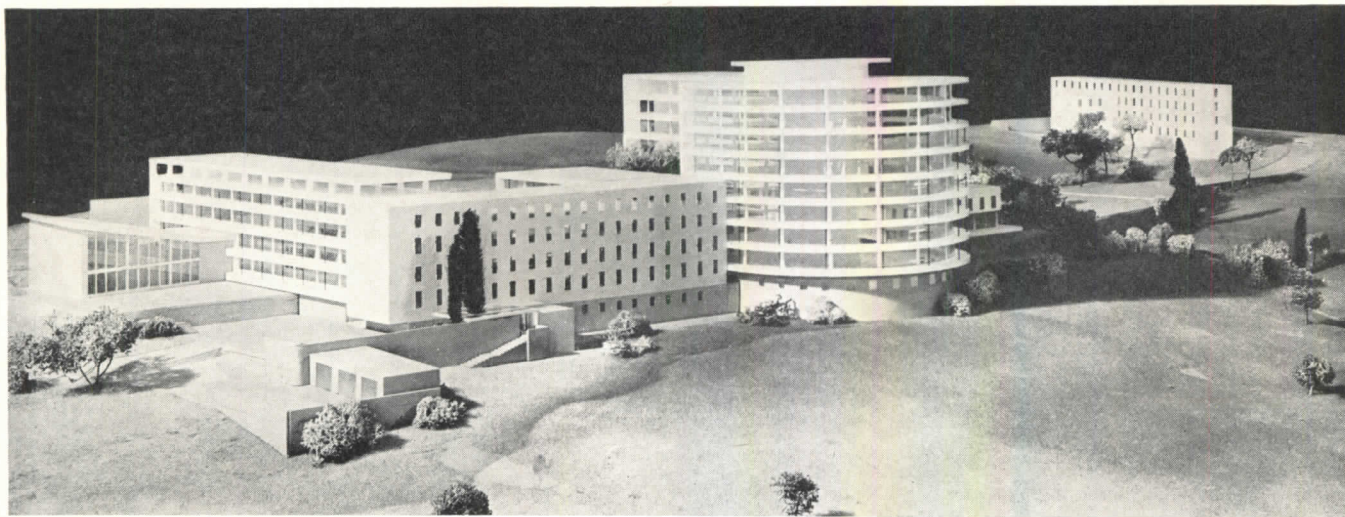

RADIAL NURSING UNIT PLANNED IN HOSPITAL FOR NEW UNIVERSITY MEDICAL CENTER IN JERUSALEM

SOME MUCH-TALKED-ABOUT innovations of modern hospital planning will be incorporated in the proposed new Hadassah-Hebrew University Medical Center for Jerusalem.

Core of the hospital section will be a "radial" nursing unit planned to place the nursing center not more — and on the average less — than 50 ft from the farthest patient's bed. (In Israel, economy of nursing care has a special urgency because of the high rate of hospital admissions and the acute shortage of nurses.) A rectangular wing projecting from the radial unit will provide separate quarters for the ambulatory sick. Courtyards have been planned to get maximum shade in a climate which is sunny nine months a year; and numer-

ous balconies will provide large outdoor areas for both patients and hospital personnel. A service drive under the Center will facilitate handling of supplies.

Joseph Neufeld is the architect for the Center, which will be built on a hilltop site overlooking the city. Hadassah, the Women's Zionist Organization of America, Inc., is now engaged in a drive to raise \$8,500,000 to finance the initial stages of the project.

The completed Center will comprise three major units: new quarters for the Henrietta Szold School of Nursing, with teaching and living facilities for 150 nurses; the 430-bed Rothschild-Hadassah University Hospital; and the Hebrew-University-Hadassah Medical School, only medical school in Israel (opened in

1949). All three units have been in temporary quarters since Arab-Jewish hostilities forced closing of the 10-year-old Hadassah Medical Center on Mt. Scopus, outside Jerusalem.

The medical school will contain library and in- and outdoor reading rooms and terraces as well as classrooms, laboratories, anatomy and research divisions and auditorium. A laboratory wing connects the school with the hospital.

In the nursing school building, with a total area of 30,000 sq ft, two of the floors will have 75 rooms for two students each. Plans provide for self-contained recreational and dining units, snack rooms for students, etc.

Construction will be steel and concrete, with facing of the tan and gold and pink native Jerusalem stone on the lower story. Roofs will be flat and insulated, to permit easy future extension.

NEWS FROM WASHINGTON *by Ernest Mickel*

Construction Industry Awaits Materials Verdict; Congress Debates Defense Production Act; First FCDA Manual Is Out; Design Revisions Likely from Eniwetok Tests; BRAB Planning Shelter Session; \$6.5 Billion Asked for Military Building

THE WHOLE COUNTRY was waiting last month. As the ceasefire talks began their difficult progress in Korea, and the President sent an emissary to troubled Iran, the Defense Production Act — pivot of the entire mobilization economy — was under stern scrutiny in the Congress. Price and wage controls drew the heaviest fire, and in the prolonged debate the Administration's anti-inflation program hung in the balance.

Material controls were not under attack in Congress, and the Controlled Materials Plan went into effect July 1; but almost before CMP Regulation 6 and its CMP-4C had joined M-4 and NPA F-24 in control of building, the National Production Authority had called its Construction Advisory Committee to Washington to discuss revocation of M-4 and issuance of "a new order based on quantitative materials restrictions" and the construction industry was waiting for the amended version of Regulation 6.

How much construction for the second half of the year? NPA officials said any definitive answer awaited screening of CMP-4C applications for fourth-quarter steel, copper and aluminum allotments, due in Washington July 20. Structural steel shapes were the major worry for the fourth quarter: NPA reported preliminary unscreened requirements total nearly 2,400,000 tons against estimated production during the quarter of about 1,300,000 tons. Construction alone would take 1,400,000 tons, according to these preliminary figures.

For the first half of 1951, the construction industry had hung up a new record. Joint preliminary estimates by the Bureau of Labor Statistics and the Building Materials Division of the Department of Commerce put total expenditures for the first six months at close to \$14 billion, or 16 per cent above the same period in 1950. "In spite of the increase in costs," said the joint release, "this represented a larger physical volume of construction than in 1950 and exceeded that of the

same period in any previous year." The new high was attributable to increases of \$740 million in industrial construction, about \$270 million in military and naval facilities, and about \$240 million in commercial construction." Residential building was at the same dollar level in both periods, but was lower in physical volume this year.

First FCDA Manual Published

Another month has passed and only the first in the series of the four long-promised civil defense manuals on bomb shelters has come to light publicly. It deals with the identification of existing buildings and shelter types, and was published in July, several months after the first announcement on it.

This manual will be followed by others dealing with the strengthening

of existing buildings, communal types of shelters, and home types. This is the series planned by the Federal Civil Defense Administration on the basis of technical information gathered and studied by Lehigh University, Bethlehem, Pa.

On July 23 FCDA called to Washington the panel of construction experts who first passed on the preliminary Lehigh results. At that time the final research statistics were submitted, and the panel personnel reviewed data on all of the three remaining subjects, according to Ray D. Spencer, director of the agency's Shelter Division. It was his hope, he said, that the other three manuals in the series could be published within 60 days of the Washington conference. This would put them into public print — all at approximately the same time — around October 1.

At an earlier conference, Mr. Spencer outlined the basic FCDA thinking on shelter construction and use. The best shelter in large buildings will generally be near the core of the structure between ground level and four floors from the top, he said.

Then he explained: "We do not mean by this that basements will not provide suitable shelter if utilities are properly protected and if a sufficient number of exits are available to insure egress from the building."

(Continued on page 20)



—Drawn for the RECORD by Alan Dunn

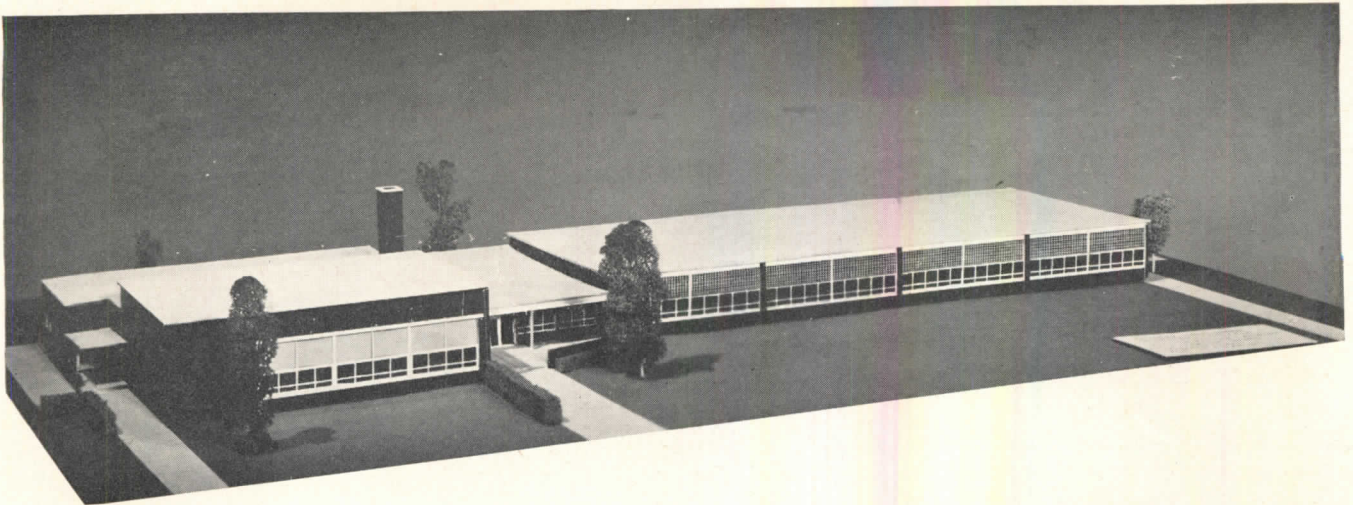

Duncan Neil McIntosh of Hamilton is architect for Waterford, Ont., public school (model photo above). The school was designed to meet a low, predetermined price and considerable thought was given to structural elements to achieve economy.

Lump sum contract, awarded to James Kemp Construction of Hamilton for \$189,099, includes all mechanical trades, a clock and intercom system. Steel roof deck in original plan was replaced by wood to avoid delivery delay; all materials were stockpiled

NEWS FROM CANADA by *John Caulfield Smith*

May Contract Awards Are 72 Per Cent Over May '50

VALUE OF CONSTRUCTION contracts awarded in May reached \$192 million, a total of 72 per cent above that for the same month a year ago, and three per cent ahead of the figure for the entire year of 1939.

The loftiest peak in award history was being scaled as the cumulative total for the first five months of 1951 reached \$796 million, 89 per cent over the total for the same period last year.

Housing was the only category to register a dip in May. Higher down payments and interest rates caused a fall-off of \$2 million compared with the same month a year ago. Observers doubt that the dip marks the beginning of a sharp downward trend, however, especially in view of the anticipated government action to increase housing production in Sorel, Toronto, Edmonton, Saskatoon and other centers facing a critical shelter shortage.

MacLean Building Reports notes that defense spending on construction was more clearly marked in May. Several large awards were made for direct military installations.

Three large housing projects, one an apartment building, joined the ranks of undertakings worth an estimated million dollars or more. Two factories in

suburban Toronto, a cement plant in Alberta, a pulp mill modernization in British Columbia and a base metal job in Manitoba were among the outstanding industrial enterprises started.

Expansion of water and sewer facilities on a large scale continued, with Scarborough Township and Ottawa leading in Ontario and Ville Jacques

Cartier in Quebec. Street paving in Vancouver, a million dollars worth of contracts for Alberta, and a large paving and rebuilding job in Quebec comprised the principal road work.

A Y.M.C.A. building was started in St. John, N. B., a hospital in Chicoutimi, an orphanage in Rimouski and a library in Montreal. Aluminum smelting needs sparked initiation of another hydro power project on the Peribonka River in Quebec. (Continued on page 222)

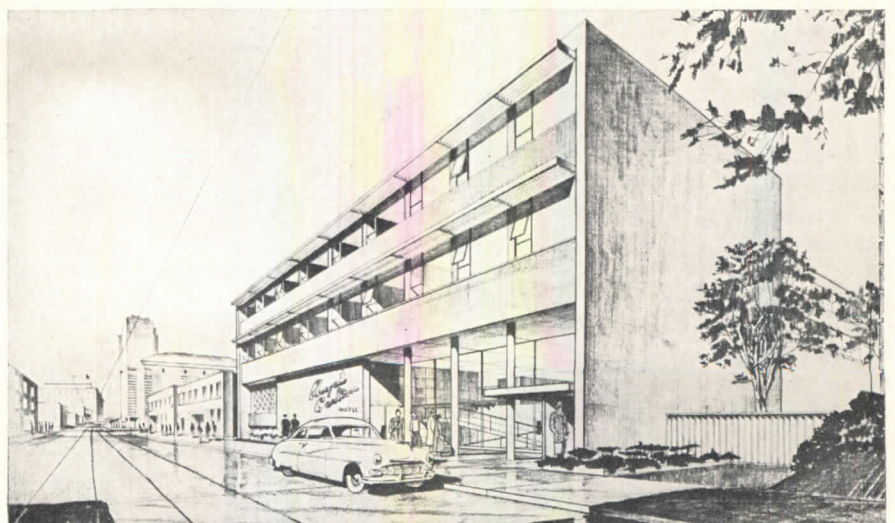

Photo of rendering shows proposed "Royal Carlton" Hotel for Toronto. The building, which would be near growing theater-shopping district at Yonge and Carlton, has interior ramps and louvered sun shields. Leo E. Venchiarutti of Toronto is the architect

Only a good
Thermostatic
Water Mixer
Can Prevent
Accidents
Like These

Baby Girl Scalded in Bath Tub

A 14-months-old girl was burned critically today when she turned on scalding hot water while she was being bathed in the

Mrs. Johnnie Mason, attendant at the nursery, said she was bathing Joan about 11:30 a. m. today just before the child turned on the hot water faucet.

'Heard a Scream'

"I stepped in the next room to get a towel," Mrs. Mason said, "and heard a scream. I ran back and grabbed her out of the tub." She said Joan stood up in the bath tub to operate the faucet.

Joan Dodd, daughter of

ALMOST "BOILED ALIVE" IN APARTMENT HOTEL SHOWER

Seeking \$40,000 damages for her injuries, Miss Rosalie B. Chivington, living at [redacted] a school teacher, yesterday in the Superior Court described how she was almost "boiled alive" in her apartment shower in [redacted] apartment hotel.

"I set the handle of the shower mixer at Warm," Miss Chivington testified. "Instantly a flood of scalding water was poured upon me. I slipped and fell into the tub."

"Unable to see because of the

"BOOBY TRAP SHOWERS" are old-fashioned dangerous and expensive

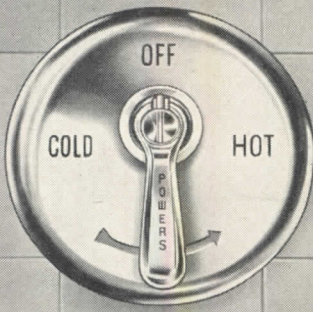

Only ONE shower or tub accident may cost many times more than a



THERMOSTATIC WATER MIXER

Safety tests prove it will outperform all other thermostatic or pressure actuated mixers

How it works—Hot and cold water are piped to mixer where they are blended and thermostatically controlled at any temperature desired between 60° to 115° F. (Note safety limit).

For shower or tub bath, Powers mixer handle is turned to right until water flowing into tub reaches temperature desired. Then bather enters tub. For a shower, diverter spout knob is pulled up diverting water to shower head. When shower is completed, handle of mixer is turned to OFF. Diverter spout flapper valve returns to "tub" position automatically.

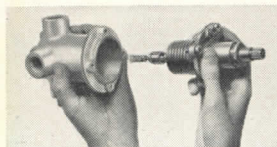

Only one moving part easily accessible from the front. Minimum of maintenance, simple, rugged construction.

Safety Features that give better control:

(1) Powers mixers prevent delivery to shower or tub above 115° F., (2) Temperature remains constant wherever set regardless of pressure or temperature changes in water supply lines, (3) Failure of cold water supply instantly and completely shuts off delivery to shower or tub.

Powers thermostatic water mixers are completely automatic, convenient, dependable and the safest temperature regulator made for tub and shower combinations.

THE POWERS REGULATOR CO.

Established 1891 • OFFICES IN OVER 50 CITIES • See Your Phone Book
CHICAGO 14, ILL., 2752 Greenview Ave. • NEW YORK 17, N.Y., 231 E. 46th St.
LOS ANGELES 5, CAL., 1808 West 8th St. • TORONTO, ONT., 195 Spadina Ave.
MEXICO, D. F., Edificio "La Nacional" 601 (H2C)

60 YEARS OF WATER TEMPERATURE CONTROL

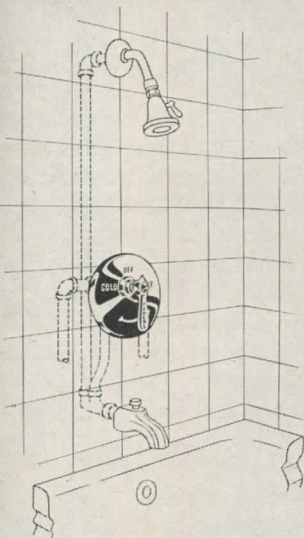

TYPICAL SHOWER & TUB COMBINATIONS

with Diverter Spout and Fitting.

Unsurpassed for
SIMPLICITY
CONVENIENCE
COMFORT
SAFETY

Contact your nearest
POWERS
office for
specification
data

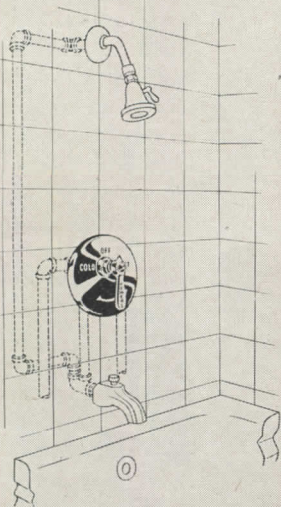

THE RECORD REPORTS

WASHINGTON (Cont. from p. 17)

The best buildings for shelters are those built of reinforced concrete or steel frames with sufficient overhead and lateral shielding to protect against radiation and blast, Mr. Spencer said. Twenty-two inches of concrete or similar material will protect against radiation. FCDA has received recommendations from a panel of engineer experts asserting that five minutes' travel time to shelters would be the minimum required

between a red alarm and a bomb explosion. On this basis a shelter for each block was recommended in critical areas. The panel also said that shelter areas should contain six sq ft of usable space per person, except in the case of short occupancy when considerably less space would be required.

The fine details of these recommendations are to come out in the series of manuals now being published. These

will be distributed to state civil defense directors but, according to present plans, not to the general public.

A representative of the American Institute of Architects (Fred Pawley) who was on the advisory panel reviewing the Lehigh data, has expressed the A. I. A. objection to extremely large communal-type shelters. Architects long have taken the view that attempts to use the so-called dual purpose shelter areas as defense against bomb blast would be ridiculous. For example, a large garage area used to store cars and then suddenly turned into a shelter for personnel would present many dangers to those seeking refuge. The oil and gas collection would be a dangerous fire hazard and the presence of glass would present another potential danger.

Another objection raised by the architects to use of these communal-type shelters is the time element involved in entering them. It is pointed out that too many minutes would be required for thousands of people to enter these areas after the alert had sounded.

President Asks Funds

Late in June President Truman asked Congress for \$250 million for use in the FCDA shelter construction program during the 1952 fiscal year. This money would be used by the agency to match equal funds put up by the states to construct refuge areas. Thus, it would provide, if used in its entirety, a half-billion-dollar program of shelter building throughout the country. There was no indication of what Congress would do with the White House request; but if earlier actions on civil defense money requests were any indication, the fund was in for a trimming at the hands of the House Appropriations committee.

The President told Congress he also wanted \$45,225,000 for federal contributions to states for other supplies and equipment; \$200 million for stockpiling materials and equipment needed in areas struck by disaster; \$20 million for working capital; and \$19,745,000 for operating the warning system and for other functions of the agency administering the civil defense program.

This budget of \$353 million in all for FCDA operation in fiscal 1952 (ending next June 30) was accompanied by a letter in which Mr. Truman said that for the first time in its history, the country now faces threat of a sudden devastating attack at any time on its major cities.

"We must act on the assumption that
(Continued on page 22)

ACME sliding door hardware

Acme Wheels Proven By 20 Years Trouble Free Operation

Doors hung on Acme Sliding Door Hardware ride on rubber wheels that guarantee smooth silent operation, free from all squeaks and rattles. The center core of graphite means lifetime lubrication for Acme wheels.

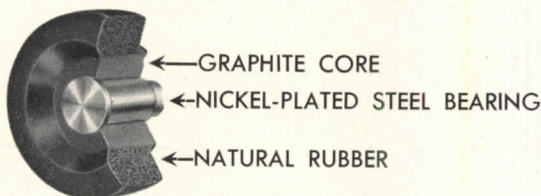

Acme Wardrobe Hardware gives silent easy operation for sliding wardrobe doors. Available in two easy-to-install models — Acme Jr. single track and Acme Bi-rail double track.

Acme Door Hardware is supplied as hardware alone or is available in frames ready to install. Vertical adjustment is made by merely turning eyelet.

ACME TYPE "Z" DOOR HARDWARE

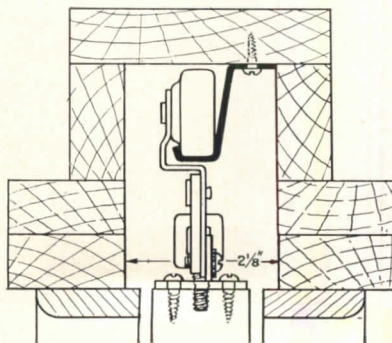
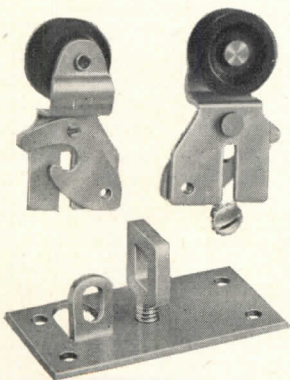

Acme "Z" Track Sliding Door Frames are distributed through sash and door jobbers, sash and door dealers, and lumber yards.

See our catalog in Sweet's 1951 architectural file 18d or write for complete information and specifications AC

ACME APPLIANCE MFG. CO.
35 S. Raymond Ave., Pasadena 1, California

economy WITH WOOD WINDOWS

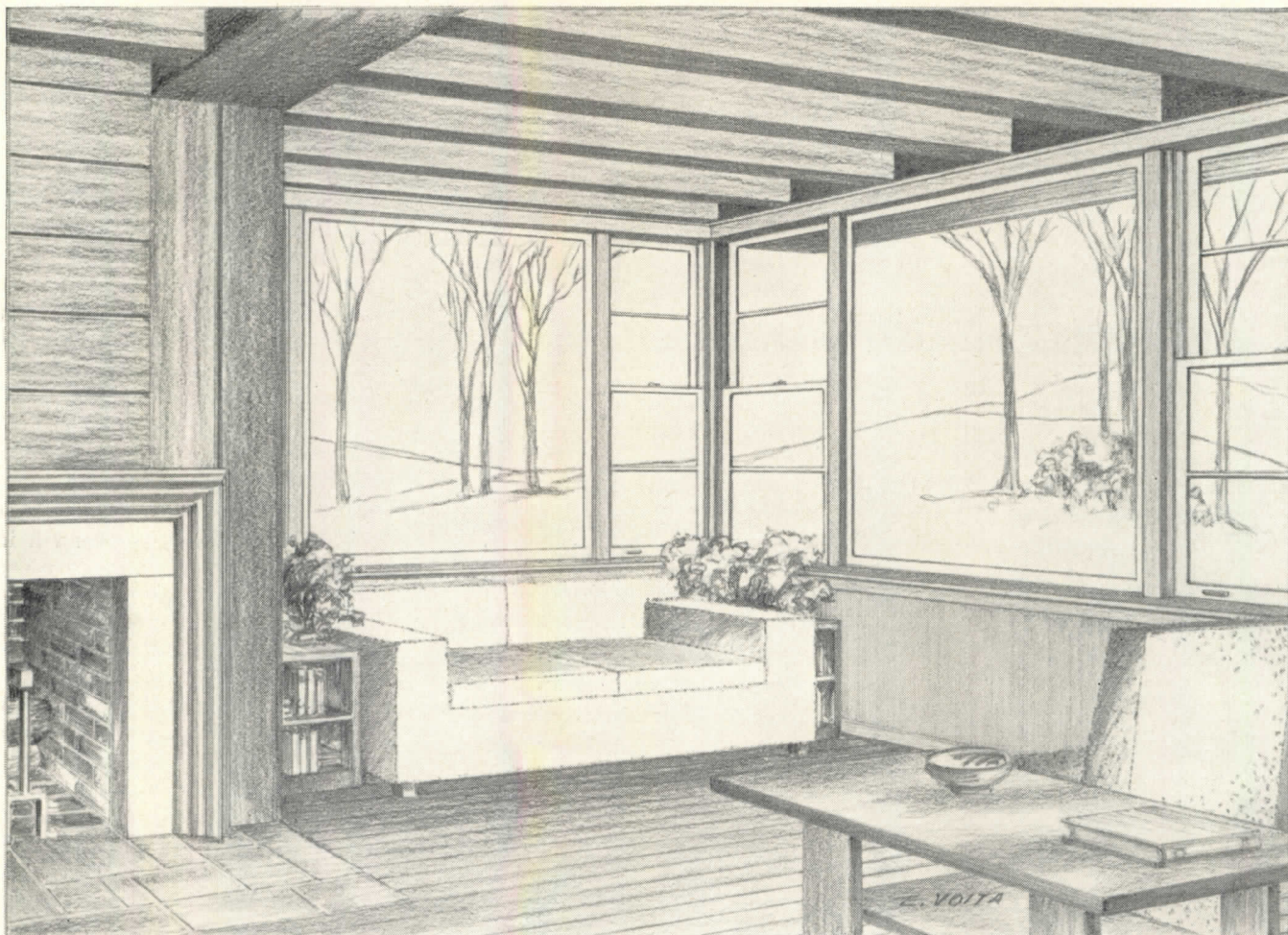

Stock design wood windows can be obtained as completely assembled units, ready to be installed—a time-saving, cost-saving feature. Such windows are pre-glazed, efficiently weatherstripped, equipped with modern sash balances. And wood window units are obtainable in modular sizes to avoid cutting, fitting, and waste of materials on the job. Wood Window Program, 38 South Dearborn Street, Chicago 3, Illinois.

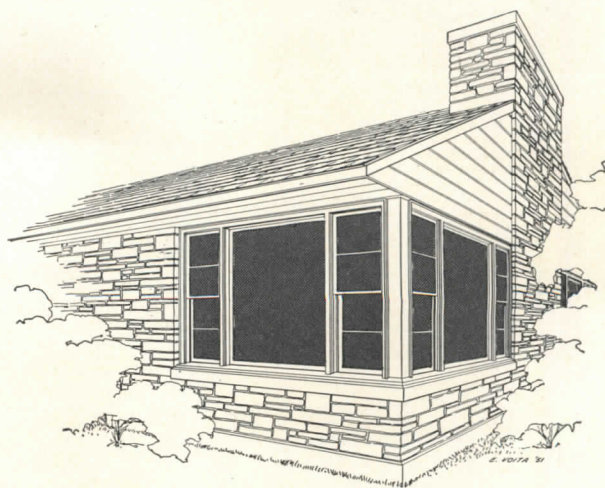

wood windows

for modern beauty and modern performance

THE RECORD REPORTS

WASHINGTON (Cont. from p. 20)

the Soviet Union has atomic bombs and that they have the planes that can drop these bombs on our cities," he wrote the *Speaker of the House*. "Our Air Force experts tell us that in any determined air attack enemy planes could drop bombs on our cities, no matter how good our defenses may be."

Against this background of urgency as outlined by the Administration, the talk of cease fire in Korea began to

make its mark on public attitude early in July. As Congress debated the final form of the Defense Production Act extension (after putting through a temporary 31-day continuance of the law), the Administration's statements on need for strong controls became more numerous. There was an obvious fear in federal circles that public apathy would develop to the extent that the entire controls program, as developed over

many months, might suddenly crumble. Congress was expected to give the nation a much-modified defense production law, amending but not repealing essential features of the 1950 Act.

The Eniwetok Tests

The need for lengthy consideration of this legislation put the Congress behind schedule on its appropriations bills. At the turn of the fiscal year July 1 not a single measure for fiscal 1952 had been enacted and cleared for the White House. The final outcome of the requested budget for civil defense operations was still up in the air.

The question of shelter construction was likely to be influenced later by results of the Eniwetok bomb tests made in May. But it appeared that more than a year might elapse before all details of the experimental runs on the remote Pacific atoll are made available by the Atomic Energy Commission and the Defense Department. FCDA was looking forward to the receipt of useful data from these two agencies as soon as it could be cleared by security officials. This, it was promised, would be worked into future recommendations for shelter construction.

There were advance indications that the estimates of building strength in relation to bomb explosion will have to be revised. The Eniwetok test, for one thing, produced an entirely different basis for appraising the effects of radiation from atom bomb bursts. And this, it is believed, will have a strong bearing on the future design of protective construction.

Of course the explosive force of modern weapons changes constantly as more lethal charges are discovered. This fact alone has prompted an Atomic Energy Commission official to remark that a quantitative revision of that agency's book on the effects of atomic weapons now is in order in view of the Eniwetok findings. AEC issued its guide book a couple of years ago with findings based largely on results of the Nagasaki and Hiroshima explosions of World War II.

Said Dr. Alvin C. Graves, director of the test division of the Commission's Los Alamos laboratory, in commenting on the obsolescence of the first atomic effects report: "Both military and civil defense leaders must plan on the basis of weapons several times more powerful than the Hiroshima-Nagasaki, or nominal weapon. The Eniwetok program included test detonations of sufficient energy-yield to permit checking or

(Continued on page 24)

Ludowici Tile Roof on modern school

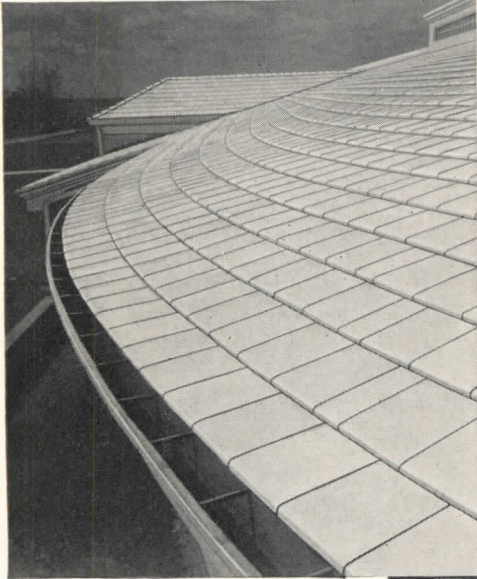

Tilton Grade School, Rochelle, Ill. Raymond A. Orput, Architect, Rockford, Ill.

Roof is laid with Ludowici light-weight smooth white interlocking shingle tiles.

THE LUDOWICI white tile roof on this new school is unusually pleasing against the verdant green of the land or the warm colors of the seasons. It will last long and shelter many generations of children. It will require no maintenance and because it is tile, and imperishable, it has all the elements of protection. This beauty and economy is available for many kinds of roofs.



LUDOWICI-CELADON COMPANY

104 South Michigan Avenue, Chicago 3, Illinois

NOTE: Full information is available to architects and builders about all of the colors, surfaces and patterns of Ludowici tile. We will be glad to furnish samples, details, specifications and architectural service on request.

New York 17, New York
565 Fifth Avenue
Washington 5, D. C.
740 15th Street, N. W.
Cleveland 20, Ohio
12734 Woodland Avenue

What goes on in your clients' minds?

Will this siding look nice?

Will it last?

Will it save us money?

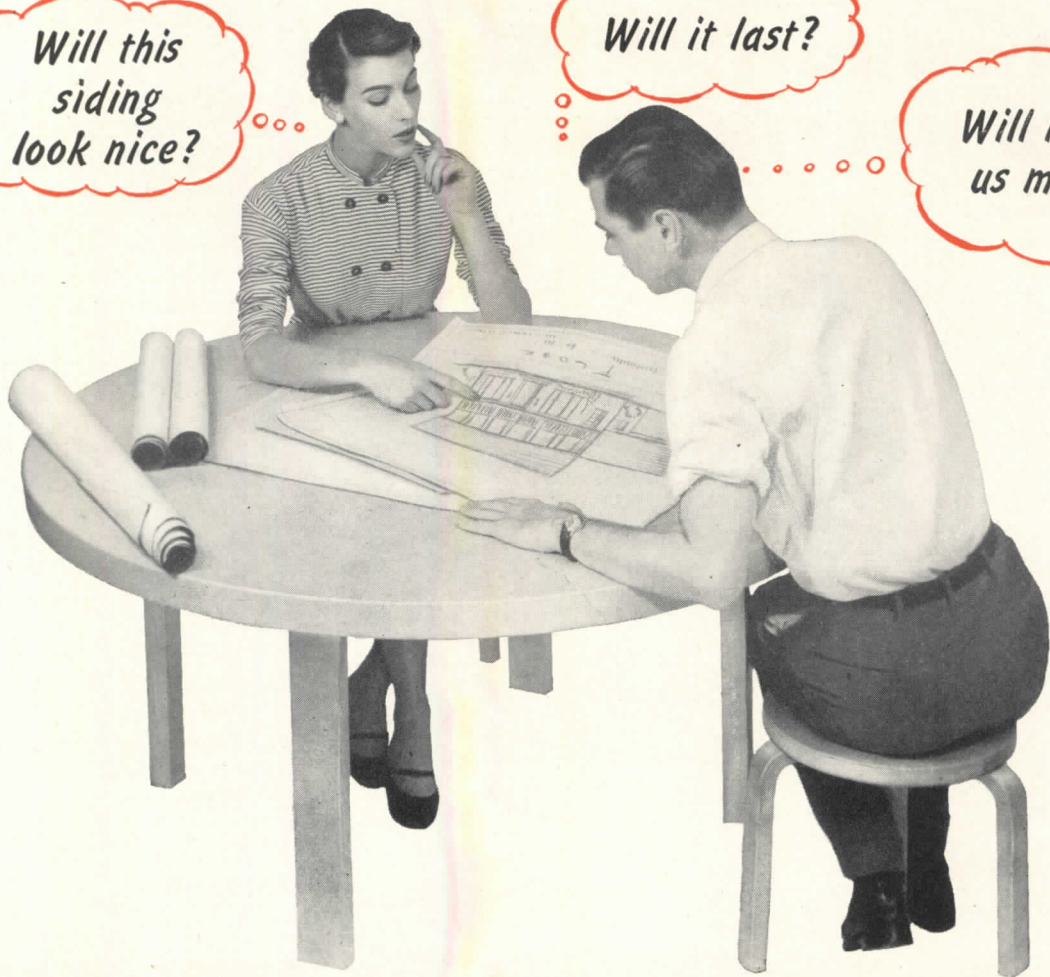

ASBESTONE SIDING SHINGLES say, "Yes", to all three questions

Show your clients this check list of Asbestone benefits:

- ✓ Lifetime protection
- ✓ Lifetime beauty
- ✓ Fireproof
- ✓ Weatherproof, weather-tight
- ✓ Freedom from rot and corrosion
- ✓ Termite-proof
- ✓ Rodent-proof
- ✓ Insulating (saves fuel)
- ✓ Needs no paint
- ✓ No upkeep expense
- ✓ Long-range economy

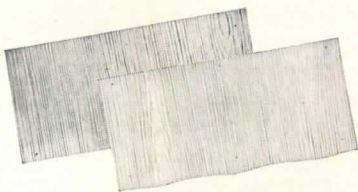

ASBESTONE SIDING SHINGLES

Straight edge or Wavy edge

Finish: Deep wood-grain texture

Colors: White, Gray, Bufftone Blend, Greentone Blend

Specialists in Asbestos-Cement Building Products for over 25 years

ASBESTONE

C O R P O R A T I O N

OTHER LIFETIME PRODUCTS MADE BY ASBESTONE

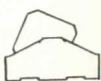

Asbestone Roofing Shingles

—designs and colors that sell on sight



Corrugated Roofing and Siding

—Standard "400" and Economy "250" weights



Asbestone Wallboard

—Utility and Flexible grades—for interior and exterior use

Asbestone Corporation
5386 Tchoupitoulas St., New Orleans, La.
Please send us free specification catalog and literature.

Name

Street

City State

Combine AIR CONDITIONING AND HEATING IN

SHOP



RESTAURANT

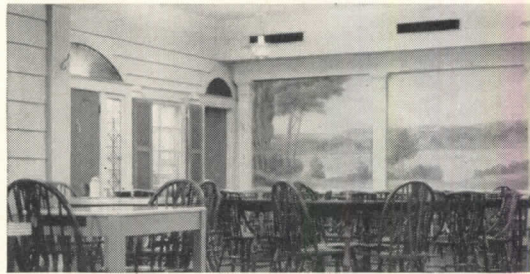

OFFICE

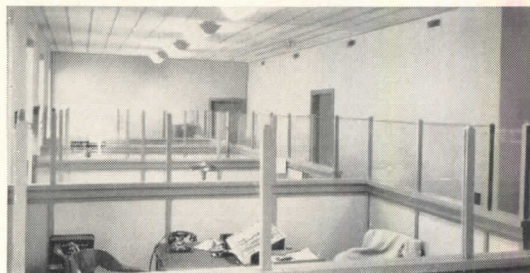

IN ONE SIMPLE, COMPACT LOW COST INSTALLATION

It is easy and practical to install Janitrol Gas-Fired Unit Heaters right in the duct work of your new or present air conditioning system.

One compact installation and distributing system gives cool, comfortable air conditioning in the summer ... the flick of a switch gives clean gas heat for winter comfort.

Experience in hundreds of stores, restaurants, offices and many types of plants shows that Janitrol equipment, installation and operation is both

economical and practical.

WRITE FOR NEW BOOKLET

If interested in combined heating, ventilating and summer cooling, or heating only, write for a copy of the booklet, "Businessman's Blue Book of Better Heating;" it's full of useful information on many types of unit heater installations.



Janitrol

Gas-Fired UNIT HEATERS

SURFACE COMBUSTION CORPORATION • TOLEDO 1, OHIO

THE RECORD REPORTS

WASHINGTON

(Continued from page 22)

confirmation of the estimates and predictions as to the effects of these high-power weapons."

The exact energy-yield of the bombs used in the recent tests is not being announced, again for security reasons. A number of partially-assembled structures of various types and many different kinds of building materials reportedly were subjected to the force of the blasts on the Eniwetok proving grounds.

But as they await the findings to be released at a much later date, architects as a group are convinced:

1. That it is more feasible to use existing buildings — strengthened if necessary — as shelter than to construct entirely new areas.

2. That basements, as the general rule, do not make good shelter locations. There is too much danger of injury from debris piling down from above. And of course there is additional hazard in utility mains that might burst and trap victims.

3. Subways cannot be considered good shelter areas if utility lines such as steam, gas and water are exposed to possible breakage.

4. Glass, broken and hurled by the impact of the explosion, constitutes one of the most troublesome problems in the civil defense picture.

5. Huge, or dual-purpose, shelters cannot serve the purpose.

BRAB Sets Shelter Conference

Protective construction in all its aspects will be considered by the Building Research Advisory Board at its next correlation conference to be held the third week in October. The study will deal with developments in atomic energy affecting the design of buildings.

This meeting is to be sponsored by the Nuclear Science committee of the American Institute of Architects and the Atomic Energy Commission. It is expected to produce the first set of documents on this new topic.

Proceedings of the B.R.A.B. correlation meeting will be published in collaboration with the A.I.A. It is believed that this method will result in the dissemination of much material on design

and construction of atomic installations that is now classified. B.R.A.B. Executive Director William Scheick points out that it will be especially beneficial to architects called upon to plan the construction of laboratories and other buildings to be used for atomic energy development.

Plans for the conference still are in the formulative stage, Director Scheick said. But he listed some possible topics for discussion: design of a tracer laboratory; design of laboratories handling radioactive materials; shielding for radioactivity; building materials and surface finishes for laboratories; and disposal of solid and liquid radioactive wastes from research laboratories.

The October meeting, the third research correlation conference, will be open to architects, engineers, contractors, manufacturers and the business and trade press.

Commenting on the October session, Mr. Scheick said:

"In discussions of the program for this conference, B.R.A.B. learned that the peacetime uses of atomic energy will affect many buildings in the future, and will introduce completely new problems into building design and technology. New hospitals and research laboratories for universities and industry are already involved with the uses of nuclear energy. The few men who have had experience with these problems will present papers and engage in panel discussions at the conference."

Full discussion of the Eniwetok tests, at least as much as is known about them, is expected.

Plant Dispersal in the News

It was announced that the Atomic Energy Commission has established a Division of Construction and Supply. This is headed by Edward J. Bloch, the former deputy director of AEC's Division of Production. He will be assisted by Frederick H. Warren, deputy director, and John R. Brindel, assistant to the director.

The new division will be responsible for staff supervision of AEC construction and related engineering activities. It will administer priorities, allocations and the Controlled Materials Plan for that agency. In addition, the new division will handle the production facilities licensing and export control programs.

Component parts will include the Construction Engineering Branch, under William K. Maher; the Defense

(Continued on page 26)

Weyerhaeuser *offers* **TIMBER TRUSSES** **and other structural wood parts**

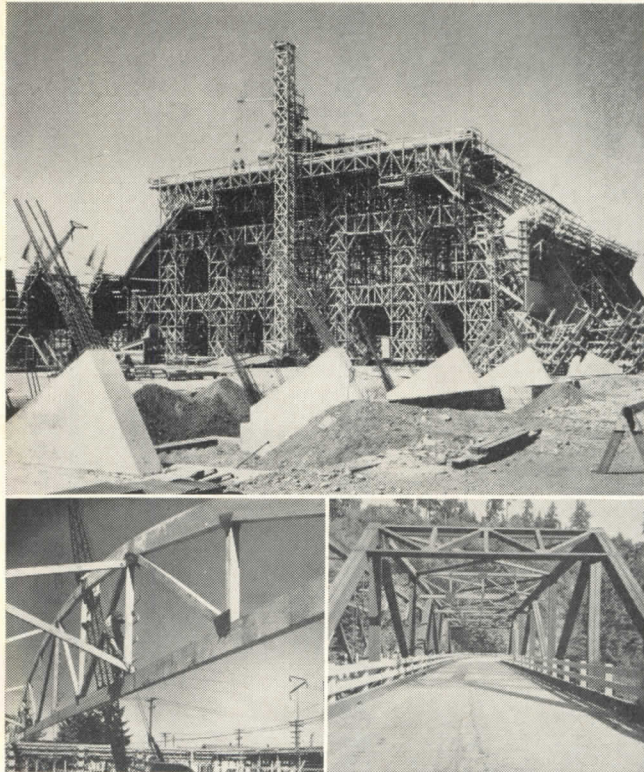

WEYERHAEUSER'S Fabricating Department offers a complete service in factory-made structural wood products, engineered for light or heavy timber construction.

Ready-to-use structural products, including hardware, are shipped as complete units through retail lumber dealers. Units are easily, quickly and economically assembled on the job with regular local crews.

Weyerhaeuser manufactures structural framing members for wall and roof systems—trusses, columns, girders... arch centering... bridges, box culverts, retaining walls... framework for factories, warehouses and schools... church trusses.

Here is a service upon which you can depend for prompt delivery of required structural wood products. Write, wire or phone for complete details and catalog.

WEYERHAEUSER
SALES COMPANY

SAINT PAUL 1, MINNESOTA

TACOMA, WASH.

NEWARK, N. J.

THE RECORD REPORTS

WASHINGTON (Cont. from p. 25)

Requirements Branch, under Ever R. Price; the Export Control Branch, under Lyall E. Johnson; the Supply Branch, under George C. Taylor; and the Special Assistance Branch, under C. R. Lee, Jr.

While these atomic matters claimed the attention of the building industry, the Defense Production Administration attempted to counteract some adverse information emanating from the Senate-

House Economic Committee. The joint committee had issued a report critical of the absence of any adequate government program for the dispersal of new plant construction. It said that the actual trend under the government's defense program is toward even greater concentration in existing industrial areas. At the same time, the committee's staff report recommended that Congress look to new provisions in the law for

requiring location of new plant facilities as far as possible in "areas which have greater geographic security from enemy attack." It was suggested that the amendments to the Defense Production Act of 1950 contain this provision.

Just as the House was debating the new measure, and while the controls program continued under the interim 31-day extension, DPA announced that U. S. industry is shifting from coastal and populated areas to new or less industrialized regions. A study conducted by the agency gave data to suggest that manufacturers who are expanding or building now under accelerated tax amortization benefits are turning more and more to such states as Arkansas, Texas, Oklahoma and Colorado.

DPA Studies Plant Locations

The agency compared distribution of plant activities and capital expenditures for 1947 with distribution of capital investment proposed under certificates of necessity issued to May 7 this year. This showed that in 1947 in the Mountain states capital investment in plant and equipment amounted to only nine tenths of one per cent of the total national volume of manufacturing. But as of May 25, 1951, the proposed investment under approved certificates of necessity in that area totalled 5.8 per cent of the value of all certificates issued. In the East South Central states the same percentage rose from 3.7 to seven in the same period; in the West South Central states, from 3.9 to 18.1, and in the West Coast states, a trend away from the port areas toward inland centers.

It was interesting to note that nearly half the expansion in the current program is within the iron and steel industry. Here, location depends heavily upon raw materials and their vicinity. Eliminate this one industry, said DPA, and the concentration of plant expansion is even greater in the three state areas cited. In fact, the combined share of the Mountain States, the East South Central area, and the West Coast region then rises from 30.9 per cent to 46.4 per cent, or almost half of the proposed capital investment.

DPA carefully qualified its statement with four factors:

1. Not all certificates of necessity issued are for new plant and equipment. A large portion will go for additional equipment for existing plants. In such cases, equipment will be installed

(Continued on page 196)

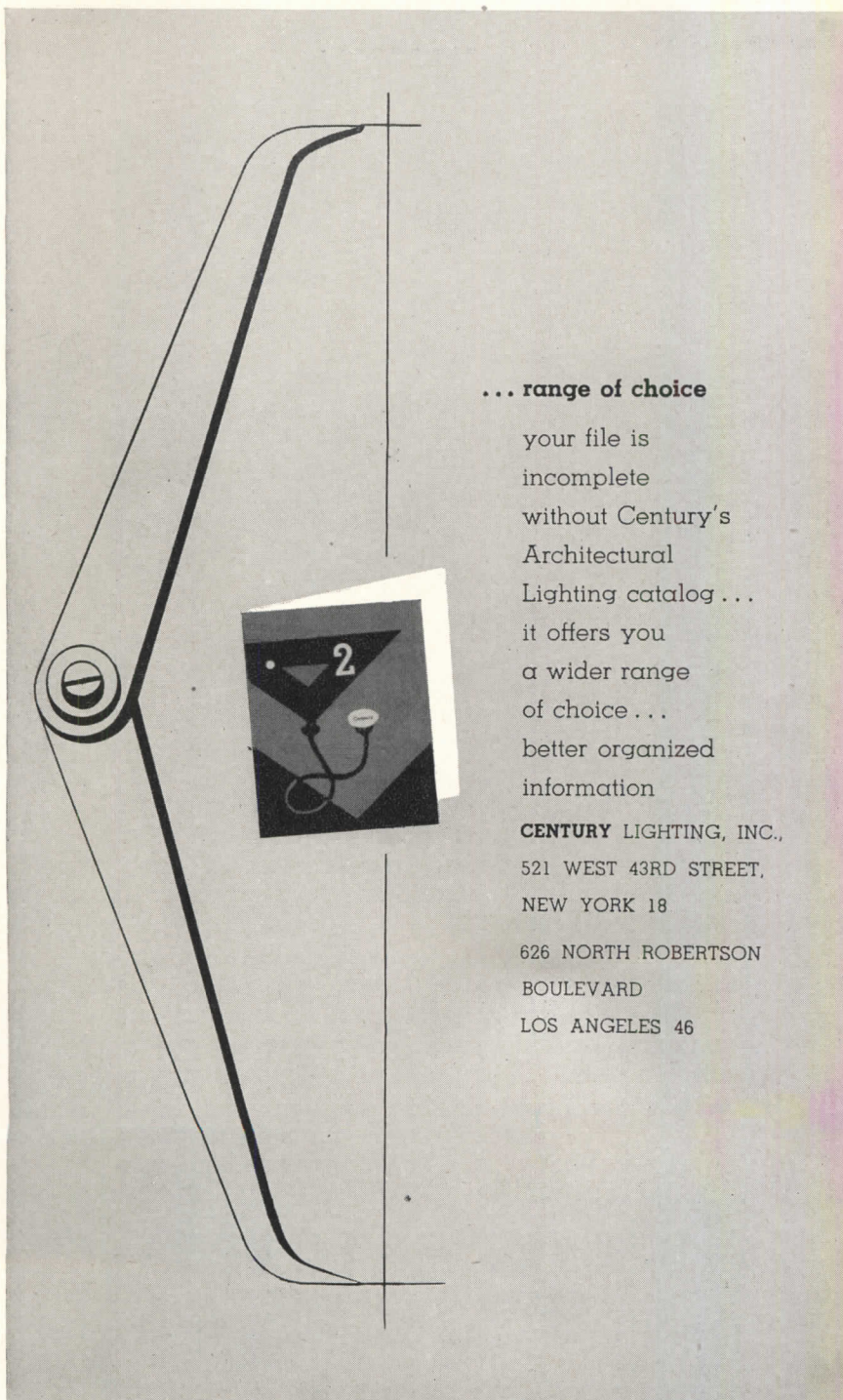

... range of choice

your file is incomplete without Century's Architectural Lighting catalog ... it offers you a wider range of choice ... better organized information

CENTURY LIGHTING, INC.,
521 WEST 43RD STREET,
NEW YORK 18

626 NORTH ROBERTSON
BOULEVARD
LOS ANGELES 46

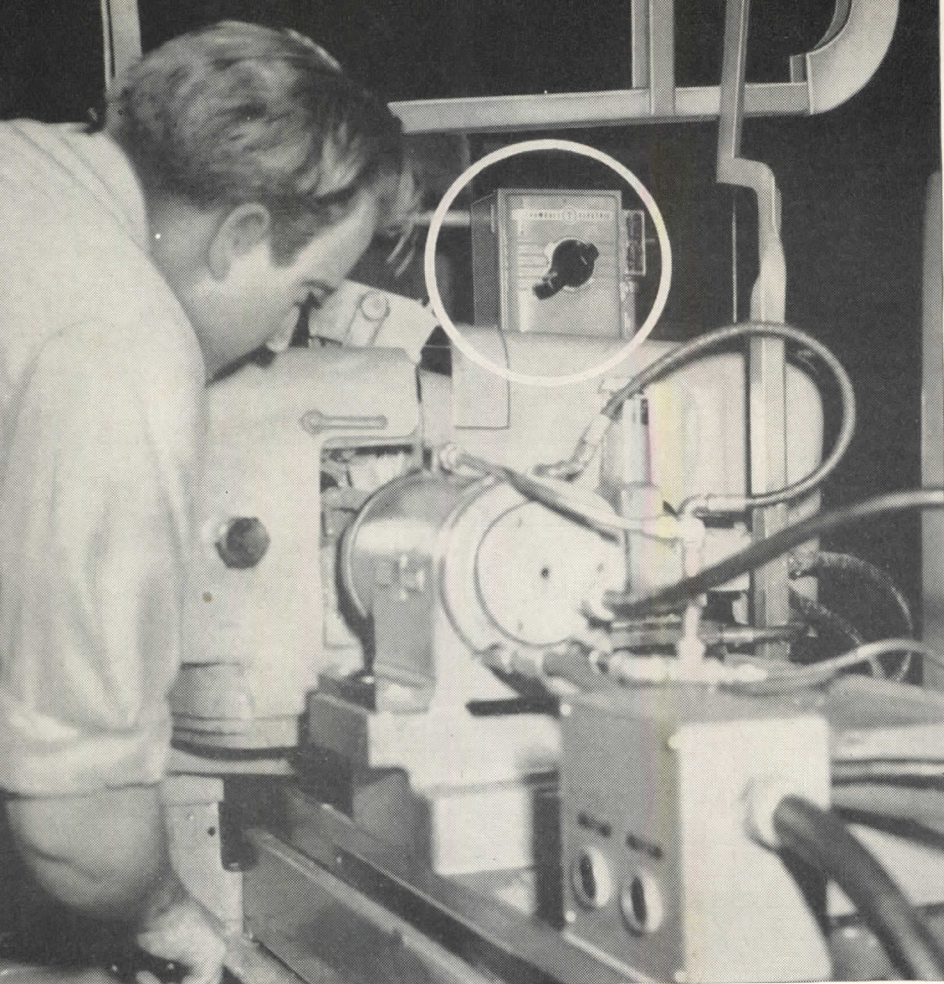

IN SAFETY SWITCHES—Marlin-Rockwell Corporation's ball bearing factories use 30 ampere HCI switches as disconnects for high frequency motors used to power internal grinders. HCI interior is removable for easy wiring and inspection. No exposed live parts when switch is OFF and door open. Underwriters' Laboratories Approved.

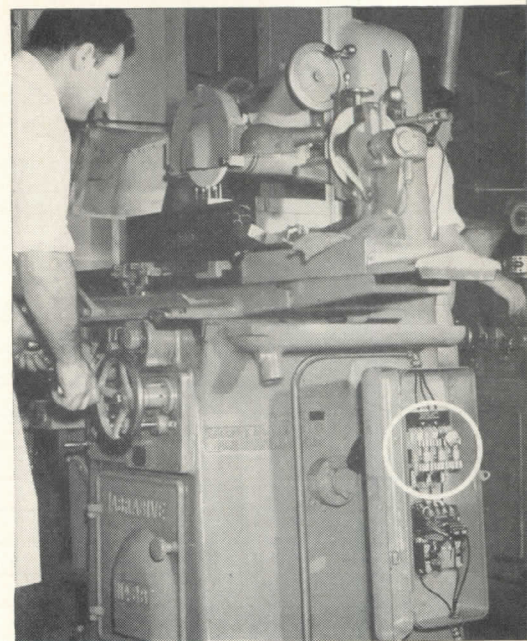

IN COMBINATION STARTERS—Rugged, simple construction of HCI is perfectly adapted to use as disconnect in combination starters.

SAFE LOAD BREAKING with Unique "Arc-Quench" Action

For the first time in a safety switch, magnetic repulsion is used to break load quickly, safely.

In Trumbull's HCI (High Capacity Interrupter) Type A switch, double-break contacts are projected and withdrawn with piston-like speed and force. The arcs repel each other and strike against grid pins, breaking into smaller arcs which cool rapidly.

The unique arc-quenching action provides safety, lengthens contact life by preventing pitting, and gives the switch much greater life expectancy. HCI withstands heavy short circuits without damage.

Its initial success as a safety switch has led to its adoption for use as disconnect in combination starters, control centers and switchboards.

Write for Bulletin TEC-10 which describes the HCI fully.

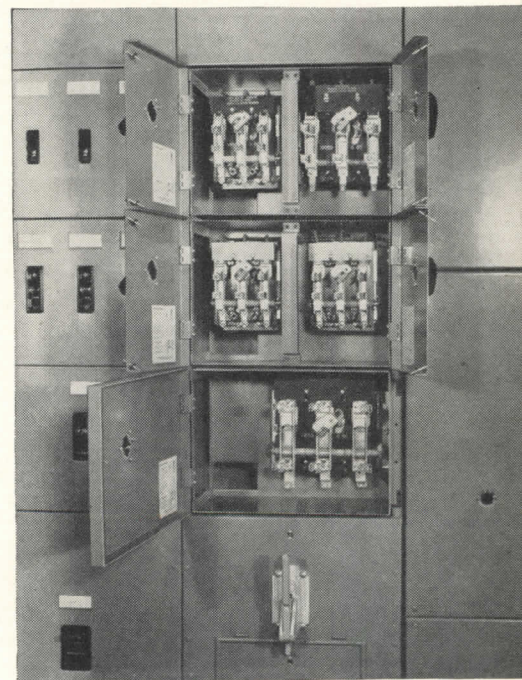

IN SWITCHBOARDS AND CONTROL CENTERS—Compact 30 and 60 ampere HCI switch interiors can be mounted in twin switchboard units (100 ampere HCI takes same vertical space), saving trough space and providing dependable short-circuit protection and sure ON-OFF handle indication.

TRUMBULL ELECTRIC

DEPARTMENT OF GENERAL ELECTRIC COMPANY
PLAINVILLE, CONN.

CONSTRUCTION COST INDEXES

Labor and Materials

United States average 1926-1929 = 100

Presented by Clyde Shute, manager, Statistical and Research Division, F. W. Dodge Corp., from data compiled by E. H. Boeckh & Assocs., Inc.

NEW YORK

ATLANTA

Period	Residential		Apts., Hotels Office Bldgs. Brick and Concr.	Commercial and Factory Bldgs. Brick and Concr.		Residential		Apts., Hotels Office Bldgs. Brick and Concr.	Commercial and Factory Bldgs. Brick and Steel	
	Brick	Frame		Brick and Concr.	Brick and Steel	Brick	Frame		Brick and Concr.	Brick and Steel
1925	121.5	122.8	111.4	113.3	110.3	86.4	85.0	88.6	92.5	83.4
1930	127.0	126.7	124.1	128.0	123.6	82.1	80.9	84.5	86.1	83.6
1935	93.8	91.3	104.7	108.5	105.5	72.3	67.9	84.0	87.1	85.1
1939	123.5	122.4	130.7	133.4	130.1	86.3	83.1	95.1	97.4	94.7
1940	126.3	125.1	132.2	135.1	131.4	91.0	89.0	96.9	98.5	97.5
1946	181.8	182.4	177.2	179.0	174.8	148.1	149.2	136.8	136.4	135.1
1947	219.3	222.0	207.6	207.5	203.8	180.4	184.0	158.1	157.1	158.0
1948	250.1	251.6	239.4	242.2	235.6	199.2	202.5	178.8	178.8	178.8
1949	243.7	240.8	242.8	246.4	240.0	189.3	189.9	180.6	180.8	177.5
1950	256.2	254.5	249.5	251.5	248.0	194.3	196.2	185.4	183.7	185.0
Mar. 1951	273.5	271.7	262.7	263.8	262.3	212.8	214.4	203.0	201.6	202.7
April 1951	273.5	271.7	262.7	263.8	262.3	212.8	214.4	203.0	201.6	202.7
May 1951	273.6	271.8	262.9	264.2	262.4	213.0	214.6	203.5	202.4	202.9
May 1951	% increase over 1939			% increase over 1939		% increase over 1939			% increase over 1939	
May 1951	121.5	122.1	101.1	98.1	101.7	146.8	158.2	114.0	107.8	114.3

ST. LOUIS

SAN FRANCISCO

1925	118.6	118.4	116.3	118.1	114.4	91.0	86.5	99.5	102.1	98.0
1930	108.9	108.3	112.4	115.3	111.3	90.8	86.8	100.4	104.9	100.4
1935	95.1	90.1	104.1	108.3	105.4	89.5	84.5	96.4	103.7	99.7
1939	110.2	107.0	118.7	119.8	119.0	105.6	99.3	117.4	121.9	116.5
1940	112.6	110.1	119.3	120.3	119.4	106.4	101.2	116.3	120.1	115.5
1946	167.1	167.4	159.1	161.1	158.1	159.7	157.5	157.9	159.3	160.0
1947	202.4	203.8	183.9	184.2	184.0	193.1	191.6	183.7	186.8	186.9
1948	227.9	231.2	207.7	210.0	208.1	218.9	216.6	208.3	214.7	211.1
1949	221.4	220.7	212.8	215.7	213.6	213.0	207.1	214.0	219.8	216.1
1950	232.8	230.7	221.9	225.3	222.8	227.0	223.1	222.4	224.5	222.6
Mar. 1951	249.0	245.4	233.5	236.3	234.9	242.9	238.7	237.2	240.8	241.1
April 1951	250.7	247.9	236.4	236.7	235.9	242.9	238.7	237.2	240.8	241.1
May 1951	252.9	249.1	240.1	241.7	240.2	245.0	240.4	239.9	244.1	244.2
May 1951	% increase over 1939			% increase over 1939		% increase over 1939			% increase over 1939	
May 1951	129.5	132.8	102.3	101.8	101.8	132.0	142.1	104.3	100.2	109.6

The index numbers shown are for combined material and labor costs. The indexes for each separate type of construction relate to the United States average for 1926-29 for that particular type — considered 100.

Cost comparisons, as percentage differences for any particular type of construction, are possible between localities, or periods of time within the same city, by dividing the difference between the two index numbers by one of them; i.e.:

index for city A = 110
 index for city B = 95
 (both indexes must be for the same type of construction).
 Then: costs in A are approximately 16 per cent higher than in B.

$$\frac{110-95}{95} = 0.158$$

Conversely: costs in B are approximately 14 per cent lower than in A.

$$\frac{110-95}{110} = 0.136$$

Cost comparisons cannot be made between different types of construction because the index numbers for each type relate to a different U. S. average for 1926-29.

Material prices and wage rates used in the current indexes make no allowance for payments in excess of published list prices, thus indexes reflect minimum costs and not necessarily actual costs.

These index numbers will appear regularly on this page.

ANOTHER ADVANTAGE OF BUILDING WITH HOMASOTE . . .

IN ONE MATERIAL:
ROOF SHEATHING
PLUS
INSULATION
for ASPHALT,
ASBESTOS or WOOD SHINGLES

With ASPHALT or ASBESTOS SHINGLES

1" x 2" furring; 12" on centers

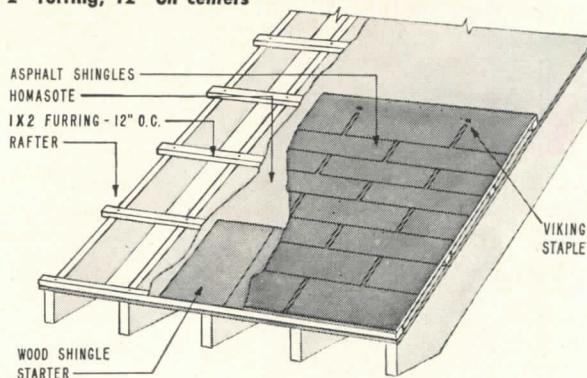

With WOOD SHINGLES

1" x 2" furring on centers determined by shingle size

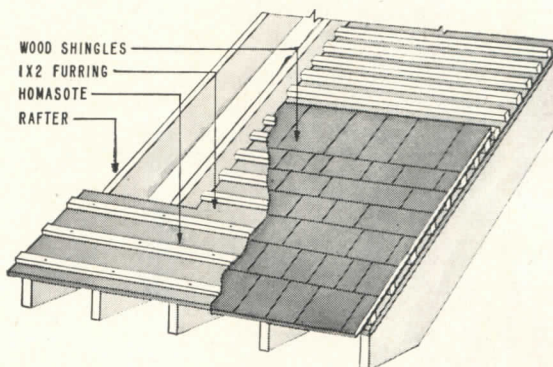

• In many thousands of homes, Homasote is now serving as under-flooring, exterior wall sheathing and roof sheathing. In every case the Homasote provides great structural strength and maximum insulating value as well as an efficient, fast, economical and easy-to-use sheathing material.

Now—with Homasote and the Viking Staple—asphalt or asbestos shingles can be applied directly to the Homasote sheathing. Furring strips, 12" on centers, are applied to the rafters. The pre-expanded Homasote is then nailed to the furring strips. The shingles are applied to the Homasote in the usual manner, using 3/4" Viking Staples. The staples cross and lock in the Homasote—providing a holding power which has been tested with wind velocities up to 110 miles an hour!

For wood shingles—the pre-expanded Homasote is applied directly to the rafters. Furring strips are then applied to the face of the Homasote and nailed into the rafters at whatever centers the shingle size demands. The air space between the shingles and the Homasote further increases the insulation value and prevents rotting of the shingles. For this application, we recommend the use of Homasote nails, specifically designed for this purpose.

For both new construction and re-roofing—with asphalt, asbestos or wood shingles—you gain many advantages when you use Homasote for roof sheathing. Homasote is more economical—will not rot out. Remember also—Homasote's big sizes, up to 8' x 14', mean fewer handlings, fewer nailings, less labor, than are required with materials of smaller size.

Write today for literature and specifications data showing the many uses of Homasote. Please give us the name of your lumber dealer!

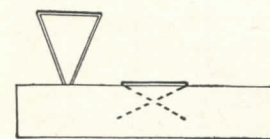

THE VIKING STAPLE
crosses and locks
in the Homasote

HOMASOTE COMPANY, Trenton 3, N. J.



. . . in Big Sheets up to 8' x 14'



. . . oldest and strongest insulating-building board on the market



Nova Sales Co.—a wholly-owned Homasote subsidiary—distributes the Nova Roller Door, Nova-I. P. C Water-proofing Products, the Nova Shingle and Nova-Speed Shingling Clip and the Nova Loc-Nail. Write for literature.



REQUIRED READING

TOWN PLANNING

Toward New Towns for America. By Clarence S. Stein. The University Press of Liverpool. Western Hemisphere agents: Public Administration Service (1313 East 60th St., Chicago 37, Ill.), 1951. 7¼ by 9¾ in. 245 pp., illus. \$5.00.

REVIEWED BY KENNETH REID

It is impossible to think of community design and planning without thinking of Clarence Stein. His life has been devoted to a practical search for ways of making the American community a safe, pleasant and economically sound place to live and work, instead of the dangerous, chaotic and costly institution that has resulted from *laissez faire* civic growth. In this book he has presented the wise conclusions drawn from his fruitful experience of 30 years. As Lewis Mumford says in his Introduction, "Let the planners of the coming generation ponder this testament."

Since just after the first World War, Clarence Stein has been in the forefront of the battle for better town building. He was at the center of the group of

pioneers who formed, in 1923, the Region-Planning Association of America — which included such men as Fred Ackerman, Fred Bigger, Alexander Bing, John Bright, Stuart Chase, Bob Kohn, Benton MacKaye, Lewis Mumford, Charles Whitaker and Henry Wright. For 10 years these gifted citizens met regularly and often, with no stimulus other than their common passionate interest in the betterment of the man-made social environment through foresighted planning. From their varied points of view, they brought their combined intelligence to bear on the problems involved. Their discussions were not only mutual education of a high order; they had concrete results as each individual applied in his own field the principles arrived at in collaborative thought. As a result, the influence of the group has been widespread and effective through the subsequent years and almost all contemporary planners are intellectually in their debt.

In the author's own words, this book tells the story of "new communities at

Sunnyside, Radburn, Chatham Village, Phipps Gardens, Hillside, Greenbelt, and Baldwin Hills Village primarily to see what could be found to help us in successfully conceiving, planning, constructing and operating New Towns, they are steps toward creating New Towns. Each is limited but rich in suggestions . . . I do not call them solutions . . . That is too final a word; at least they point the way . . . I have reviewed them to see what might be regarded as warnings against errors, or might form the basis of future work."

The communities reviewed are those in which Stein was directly involved, either as a principal or as an associate. They cover an evolution extending over 17 years, from 1924 when the City Housing Corporation was organized to build Sunnyside Gardens on Long Island, New York, to 1941 when Baldwin Hills Village was built as a suburb of Los Angeles. He has told the story of each, thoughtfully and critically and with clarity and simplicity, stating his observations and conclusions at the end of each presentation. The illustrations are admirably informative and meaningful, not just pictures to enliven a book. The lessons he learned as he went along were applied on the successive problems he worked on, and are set down here for the benefit of all who read them. At the end, he has summed up the principles he has discovered and tested, in a chapter looking toward the future.

No one concerned with community planning and town building can afford to overlook this volume, wherein he may draw upon the life experience of this quiet persistent man, Clarence Stein, who has combined the imagination of a sensitive artist, the orderly thinking of a scientist and the practical sense of a business man so effectively in following his purpose to help fashion a better world. I would have been proud to have been his publisher.

(Reviews continued on page 32)

"The illustrations are . . . not just pictures to enliven a book"

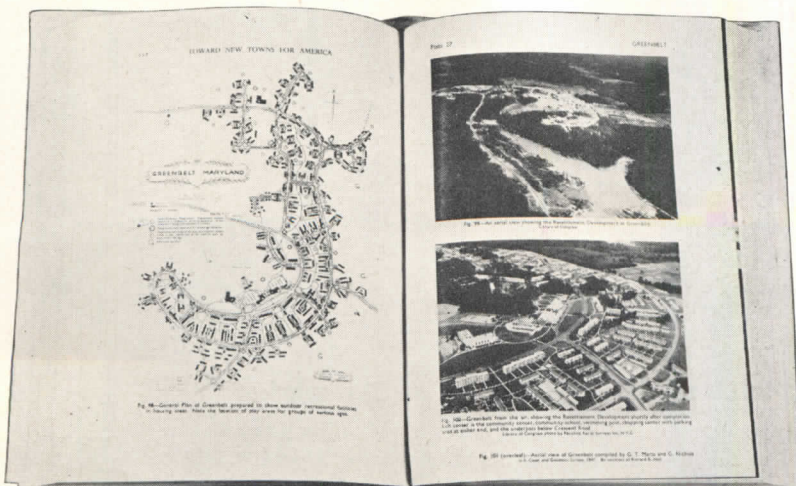

INSULATED METAL WALLS

for INDUSTRIAL and COMMERCIAL BUILDINGS
ALUMINUM, STAINLESS or GALVANIZED STEEL

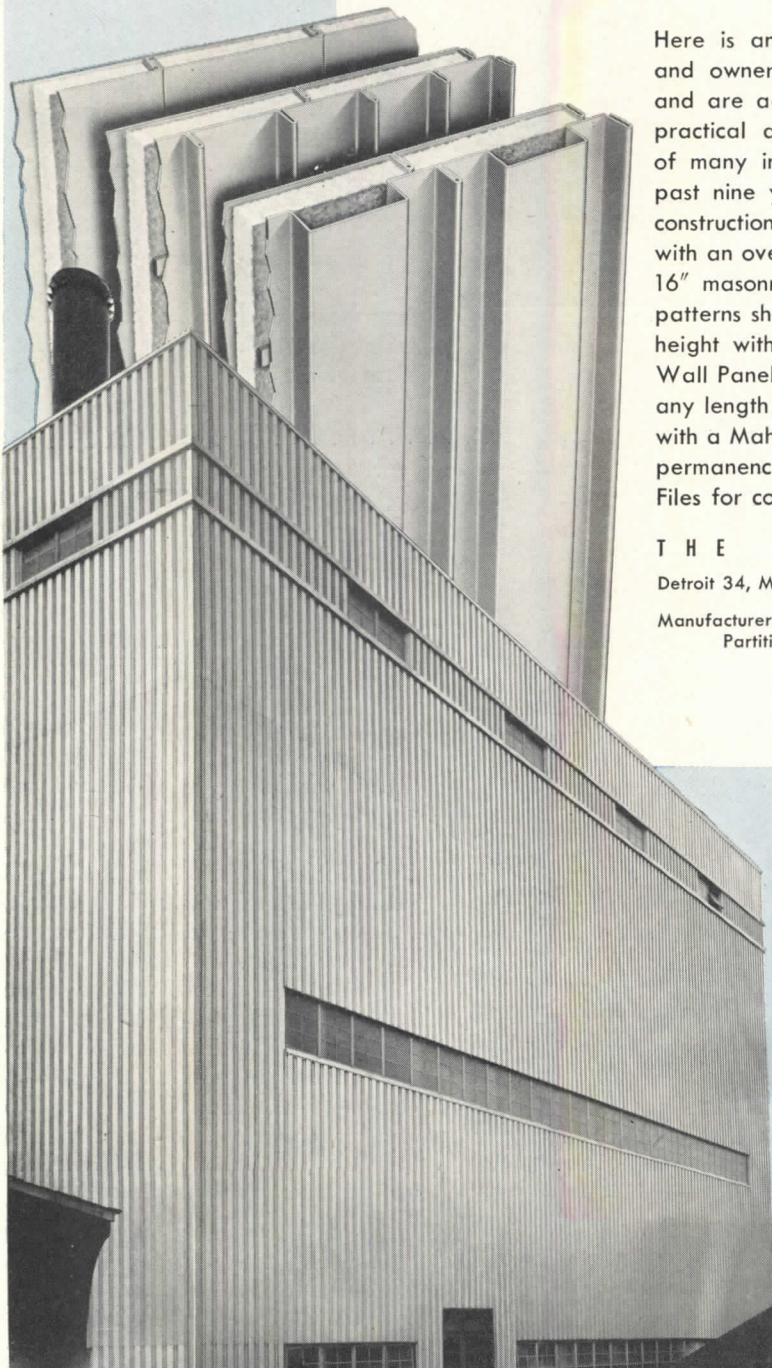

Here is another completed building in which both designers and owners are enthusiastic about the over-all appearance, and are agreed that Mahon Insulated Metal Walls are more practical and decidedly more economical . . . it is typical of many industrial and commercial buildings designed in the past nine years for employment of this modern exterior wall construction. Mahon Field Constructed Insulated Metal Walls, with an over-all "U" Factor equivalent to that of a conventional 16" masonry wall, are available in the three distinct exterior patterns shown at left. Walls may be erected up to 50 feet in height without horizontal joints. Prefabricated Insulated Metal Wall Panels are also produced by Mahon and are available in any length up to 30 feet. These Insulated Metal Walls together with a Mahon Steel Deck Roof, provide the ultimate in economy, permanence, and fire-safety in modern construction. See Sweet's Files for complete information or write for Catalog No. B-51-B.

T H E R . C . M A H O N C O M P A N Y
Detroit 34, Mich. • Chicago 4, Ill. • Representatives in Principal Cities
Manufacturers of Insulated Metal Walls; Steel Deck for Roofs, Floors and Partitions; Rolling Steel Doors; Grilles; and Underwriters' Labeled Rolling Steel Doors and Fire Shutters.

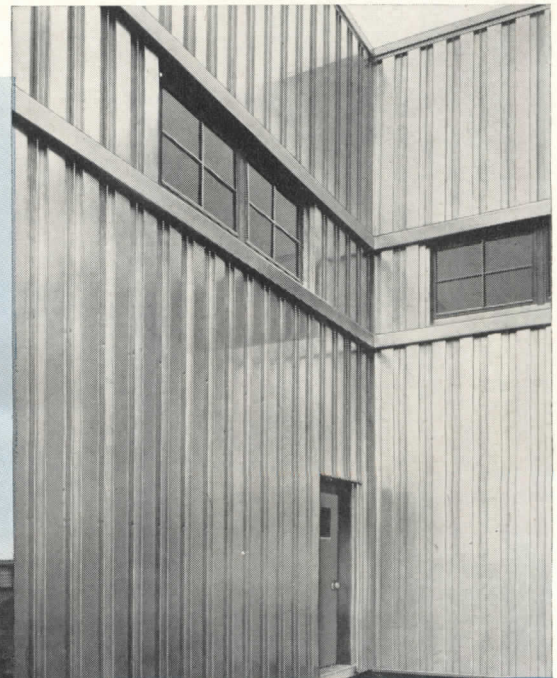

Mahon Insulated Metal Walls Employed in the Construction of a New Powerhouse for Fairbanks-Morse & Co., Beloit, Wisconsin. Stone & Webster, Architects & Contractors.

MAHON



WILL THE FLOORS YOU SPECIFY TODAY LOOK THIS GOOD IN 1979?



The John Jorgensen Clothing Company of Racine, Wisconsin, has been using this floor of Wright Rubber Tile for 28 years. Laid in 1923, it shows so little wear that even today customers frequently ask if the floor is new.

How will the floor you specify today look 28 years from now? With most flooring materials you can't be sure — but with Wright Rubber Tile there is ample proof to back up your judgment.

Before you specify another floor, you owe it to yourself and your clients to get the entire story on Wright Rubber Tile. See Sweet's Architectural File for specifications. Write us on your letterhead for a free set of samples.

WRIGHT MANUFACTURING CO.
5204 Post Oak Road • Houston, Texas



FLOORS OF DISTINCTION

- ◆ WRIGHTEX—Soft Rubber Tile
- ◆ WRIGHTFLOR—Hard Surface Rubber Tile
- ◆ WRIGHT-ON-TOP Compression Cove Base

REQUIRED READING

(Reviews continued from page 30)

SOUTHERN CALIFORNIA ARCHITECTURE

A Guide to Contemporary Architecture in Southern California. Edited by Frank Harris and Weston Bonenberger. Watling and Company (Los Angeles), 1951. 6 by 9 in. 91 pp., illus. \$1.95.

Here is a must book for any architect traveling in California — and for those living there. This book, similar in style to one published a number of years ago by the Museum of Modern Art, is a guide to the outstanding contemporary architecture in that state.

Most of the buildings mentioned in the "Guide" have been erected since World War II. About 230 residential, commercial and public buildings are listed. Each listing gives the address, name of the architect, the contractor, date completed and a brief description of the important features of the building. Some plans are also included.

BRICK AND TILE

Brick and Tile Engineering. Handbook of Design. By Harry C. Plummer. Structural Clay Products Institute (Washington, D. C.), 1950. 6 by 9 in. vii + 392 pp., illus. \$5.00.

This is an exceptionally well written and organized manual containing extensive engineering data on brick and tile construction. In substance it is a revised edition of those facts of volumes *Brick Engineering* and *Tile Engineering* published in 1939 and 1946. It doesn't, however, include reinforced brick masonry and structural tile floors.

The material on modular coordination is exceptionally well presented with clear illustrations indicating the modular dimensioning process. Other chapters deal with properties of structural clay products, design of brick and tile walls, design of chimneys and fireplaces, and brick bonds and patterns.

BUILDING INVESTMENT

Building for Investment. By Clinton H. Cowgill. Reinhold Publishing Corp. (330 West 42nd St., New York 18, N. Y.), 1951. 5½ by 8½ in. xiv + 482 pp., illus. \$7.00.

Mr. Cowgill's book examines the problems of building primarily from the standpoint of the investor. It was pre-

(Continued on page 232)

THE INTERNATIONAL STYLE

TWENTY YEARS AFTER

By *Henry-Russell Hitchcock*

In the spring of 1928, the building boom of the Twenties was already past its national peak by several years, but the wave of skyscraper production was still rising in New York. Certainly America's faith in her own architectural achievement had never been higher, even though her greatest architect Frank Lloyd Wright was, in those halcyon years, more active at writing articles for magazines than at building. Concurrently with the series "In the Cause of Architecture" by Wright, which began in the January number of the RECORD, there appeared in the April and May numbers two articles, advance samples from my book on *Modern Architecture* which was published the following year. The second article, "The New Pioneers," presented very briefly, but perhaps for the first time to many Americans, the thesis that the work of a group of young European architects, some part of it actually executed in the previous five or six years, but much of it merely in the form of projects, proposed and illustrated a drastic and unified architectural revolution.

In 1931, the Museum of Modern Art, a new institution in New York devoted primarily to the presentation of the work of modern painters, planned an ambitious venture. Dissatisfied with the selections from contemporary architectural production then being shown in the Architectural League's annual exhibitions and convinced that modern architecture was at least as significant as

modern painting, the director of the Museum, Alfred Barr, asked Philip Johnson and me to organize an International Exhibition of Modern Architecture to be held at the Museum early the next year. The exhibition emphasized the work of four European architects, Gropius, Le Corbusier, J. J. P. Oud, and Mies van der Rohe, and of five Americans, Wright, Raymond Hood, Howe and Lescaze, Neutra, and the Bowman Brothers (about whom very little has been heard since). But it also included a section devoted to the "Extent of Modern Architecture" in which work from 15 countries and by some 40 architects was included.

At the same time, Philip Johnson and I prepared a book, *The International Style: Architecture since 1922*. In that we attempted to set down the characteristics of the new architecture of the previous decade as it had first been developed, largely by the four Europeans whose work was stressed in the Exhibition, and as it had already been extended by so many others to various countries throughout the world.

This article takes the form of a series of quotations from the 1932 book with comments made in the light of what has happened since. Typographic differentiation indicates which are the passages quoted from the text of the book prepared in 1931 (and published in 1932) and which are remarks of 20 years later.

— *H.-R. H.*

THE INTERNATIONAL STYLE was prefaced by a statement by Alfred Barr, the Director of the Museum of Modern Art. In his first paragraph he made a claim which the authors themselves might well have considered immodest:

. . . They have proven beyond any reasonable doubt, I believe, that there exists today a modern style as original, as consistent, as logical, and as widely distributed as any in the past. The authors have called it the International Style.

To many this assertion of a new style will seem arbitrary and dogmatic . . .

And how! A quarter century after Gropius's Bauhaus at Dessau and Le Corbusier's Pavilion de l'Esprit Nouveau at the Paris Exposition of Decorative Arts of 1925 first made evident that something like a concerted program for a new architecture existed, it is still by no means necessary to conclude that the "International Style" (which they and other European architects were then maturing) should be considered the only proper pattern or program for modern architecture.

The work of many architects of distinction



Architectural Record, October 1930

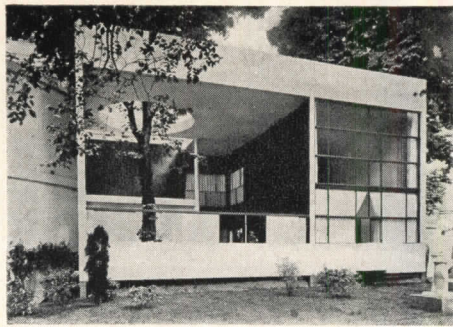

Courtesy Museum of Modern Art

"A quarter century after Gropius's Bauhaus and Le Corbusier's Pavilion de l'Esprit Nouveau . . ."

such as Frank Lloyd Wright, who make no bones about their opposition to the supposed tenets of an International Style, certainly belongs to modern architecture as much as does the work of Gropius and Le Corbusier. Yet the particular concepts of a new modern style which date from the Twenties *do* conveniently define that crystallization — that convergence of long imminent ideas — which then took place in France and Germany and Holland, and which a quarter century later has spread throughout the civilized world. (Only, I believe, in Russia are the forms of the International Style unpopular — to put outright official proscription rather mildly!)

In general, it has been the concept of "style" itself, as implying restraint or discipline according to *a priori* rules of one sort or another, which has been hardest for architects, as distinguished from critics and writers, to accept. The introduction of the 1932 book was therefore devoted to defending "The Idea of Style" and this defense is still relevant — even if its validity is also still debatable — today:

The chaos of eclecticism served to give the very idea of style a bad name in the estimation of the first modern architects of the end of the nineteenth and the beginning of the twentieth century.

The most distinguished older modern architects, notably Wright and Gropius, are still perhaps the most perturbed by the idea that anything that can properly be called a style, in the historic sense of that word, can have any worthwhile part to play in the architecture of the 20th century. Yet Wright himself obviously has a highly individualistic style — several, for that matter — and it is also obvious that that personal style (or those styles) of his could be utilized as a framework of architectural advance, if his precepts for "Organic Architecture" were widely accepted and conscientiously followed.

Gropius is proud of the fact that it is difficult to tell the work of one of his pupils

from that of another — a difficulty that he in fact rather exaggerates. (For the work of Paul Rudolph, for example, differs a great deal from that of the members of what might be called the Boston Suburban School.) But what is this anonymity that the Chairman of the Harvard Department of Architecture admires in his pupils' work but a common style? It is not the "Gropius" or the "Bauhaus" style, moreover, but merely an important part of the broader International Style, as that is practiced by the third generation of modern architects in the North Eastern United States.

The individualistic revolt of the first modern architects destroyed the prestige of the (historic) "styles", but it did not remove the implication that there was a possibility of choice between one aesthetic conception of design and another.

To refuse a comparable liberty of choice today, merely because 25 years ago the development of modern architecture began to be notably convergent, is certainly a form of academicism. This is already only too evident in just the places one would expect to find it, that is, in prominent architectural schools and in large highly institutionalized offices. Modern architecture in the 1950s should have room again for a range of effects as diverse, if not as divergent, as Victor Horta's Maison du Peuple in Brussels of 1897, an early modern building largely of metal and glass that is too often forgotten now, and Wright's River Forest Golf Club (as first built in 1898), of ordinary wooden-frame construction, in which most of the concepts of his now "classic" prairie houses of the next decade were already almost fully mature.

The individualists decried submission to fixed aesthetic principles as the imposition of a dead hand upon the living material of architecture, holding the failure of the (stylistic) revivals (of the 19th century) as a proof that the very idea of style was an unhealthy delusion.

Much of what Dean Wurster has called "Drugstore Modern" suggests that the "individualists" were less completely in the wrong than we admitted 20 years ago. Certainly too rigid a concept of what is stylistically "permissible" is always stultifying. But throughout most of the intervening period our contention that:

The idea of style, which began to degenerate when the revivals destroyed the disciplines of the Baroque, has become real and fertile again

has been supported by what has occurred.

The idea of modern style should remain, as it presently is in fact, somewhat loose

Ezra Stoller

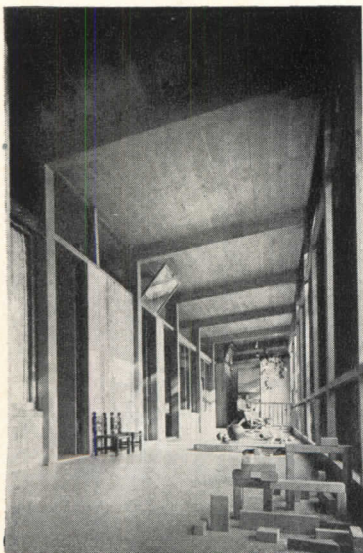

Russell House, Twitchell and Rudolph, architects

"... work of Paul Rudolph differs a great deal . . ."

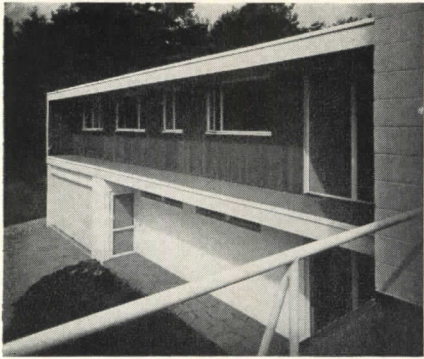

Ezra Stoller

Eldredge House, E. H. and M. K. Hunter, architects

... third generation of modern architects ...

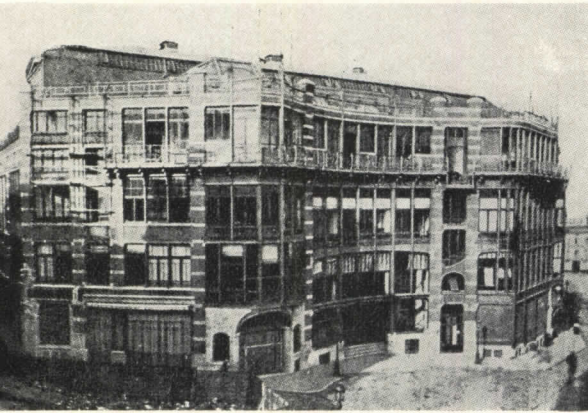

Courtesy Museum of Modern Art

“Victor Horta’s *Maison du Peuple* of 1897 . . . too often forgotten now . . .”

rather than too closely defined. There will, however, always be some sort of style in the arts of self-conscious periods, whether it is so recognized, and so called, or not. Since it is impossible to return, under the circumstances of advanced civilization, to the unselfconscious production of supposedly styleless “folk arts,” it is well to be aware that there *is* a problem of style. To attempt to dismiss style altogether is culturally ingenuous; it is also Utopian, or more accurately, millennial (in one sense at least, there were no “styles” in the Garden of Eden!).

The unconscious and halting architectural developments of the nineteenth century, the confused and contradictory experimentation of the beginning of the twentieth, have been succeeded by a directed evolution. There is now a single body of discipline, fixed enough to integrate contemporary style as a reality and yet elastic enough to permit individual interpretation and to encourage general growth.

Today that “fixing” is resented, just because it has been so successful. Yet the establishment of a fixed body of discipline in architecture is probably the major achievement of the 20th century, not any technical

developments in building production that have yet become universally accepted; modern technical developments have recurrently disappointed the optimists and they have failed, perhaps even more conspicuously, to live up to the bolder prophecies of 19th century critics.

After 25 years, it is the “elasticity” and the possibility of “general growth” within the International Style which should be emphasized. That was already beginning to be evident to Philip Johnson and myself 20 years ago. Few of our readers, alas, seem to have given us credit for what were then readily dismissed as mere “escape-clauses.”

The idea of style as the frame of potential growth, rather than as a fixed and crushing mould, has developed with the recognition of underlying principles such as archaeologists discern in the great styles of the past. The principles are few and broad.

Too few and too narrow, I would say in 1951 of the principles that were enunciated so firmly in 1932:

There is, first, a new conception of architecture as volume rather than as mass. Secondly, regularity rather than axial symmetry serves as the chief means of ordering design. These two principles, with a third proscribing arbitrary applied decoration, mark the productions of the international style.

Today I should certainly add articulation of structure, probably making it the third principle; and I would also omit the reference to ornament, which is a matter of taste rather than of principle. The concept of regularity is obviously too negative to explain very much about the best contemporary design; but I can still find no phrase that explains in an all-inclusive way the more positive qualities of modern design.

In opposition to those who claim that a new style of architecture is impossible or undesirable, it is necessary to stress the coherence of the results obtained within the range of possibilities thus far explored. For the international style already exists in the present; it is not merely something the future holds in store. Architecture is always a set of actual monuments, not a vague corpus of theory.

After twenty years there are many, many more “architectural monuments” in existence; the results are still coherent, but the “corpus of theory” is both firmer and broader, if also harder to define. The mistake made by many readers of the “International Style” was — and if any one reads the book now, instead of depending on his memory or on second-hand reports of its contents, I fear, still is — to assume that what the authors offered as a diagnosis and a prognosis was intended to be used as an academic rule-book.

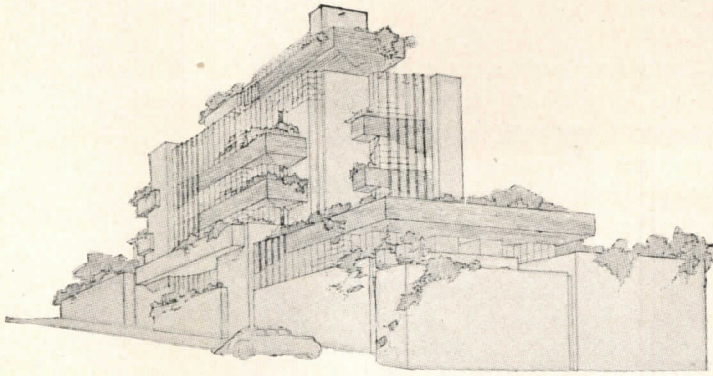

"Wright came very close indeed to the International Style in . . . apartment house for Elizabeth Noble in Los Angeles . . ."

In the Nature of Materials

It is an old story now, on the other hand, that Wright came very close indeed to the International Style in certain projects of the late 1920s, or such as that for an apartment house for Elizabeth Noble in Los Angeles, and that many of his most famous later works, such as Falling Water, seem to include definitely "international" ideas. The architects of the San Francisco Bay Region, whom some critics have wished to build up as the protagonists of a more humanistic school opposed to the International Style, have also frequently followed its principles almost to the point of parody — although admittedly not in their best and most characteristic country-house work. Between these extremes of loose interpretation by one of the original definers of the International Style and of partial, or even at times complete, acceptance of its tenets by those theoretically most opposed to it, lies the great bulk of current architectural production.

Following the section devoted to "The Idea of Style" in the 1932 book came one on the "History" of modern architecture. We said then (rather condescendingly) of the architects active from 1890 to 1920:

Today it seems more accurate to describe the work of the older generation as half-modern.

In 1951 there seems no reason at all not to claim that the work of the older generation of modern architects was "early modern," not "half-modern." The achievements of the earlier men seem much greater today in retrospect, moreover, than they did 20 years ago. Without Wright's work of the last 20 years, it is hard to believe now that the full scope of his greatness could have been appreciated as it certainly had been in 1932 by many architects and critics for almost a generation. Yet it still seems a true enough historical statement to say that:

There was no real stylistic integration until after the war (of 1914-18).

The crystallization of what will perhaps in historical terms some day be called the "high" phase of modern architecture came in the 1920s. Now I suspect we are entering the "late" phase. Leaving that prognosis aside, much of what we wrote twenty years ago about the "early modern" architects still seems true.

Wright was the first to conceive of architectural design in terms of planes existing freely in three dimensions rather than in terms of enclosed blocks. Wagner, Behrens and Perret lightened the solid massiveness of traditional architecture, Wright dynamited it.

Such things as the interior of Otto Wagner's Postal Savings Bank in Vienna, of about 1910, or Behrens's German General Electric turbine factory in Berlin, of 1912, appear today more extraordinary, in relation to what had preceded them in the previous century, than they did then.

Wright from the beginning was radical in his aesthetic experimentation.

Wright's Yahara Boat Club, of 1902, in Madison, Wisconsin, prefigured, a decade before Cubism reached maturity, most of the plastic innovations that contact with abstract painting and sculpture were to suggest, some 15 years later, to the young European architects who initiated the International Style. The plan Wright prepared for a house to be built for himself in 1903, incorporating all the living areas except the kitchen in one articulated flow, is obviously an early prototype of the one-room houses that are frequently supposed to be a post-war development of the last five years.

Perret was, perhaps, a more important innovation in construction.

" . . . prefigured, a decade before Cubism reached maturity, most of the plastic innovations . . ." (Wright's Yahara Boat Club, 1902)

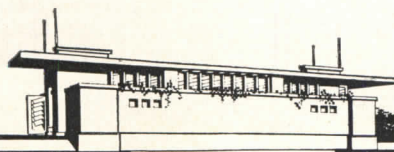

Perret's church at LeRaincy outside Paris, of 1923, remains more striking than much of the shell-concrete construction of the last decade. But Perret's later work has seemed less bold, both structurally and aesthetically, and he belongs in the main to the early 20th century. Wright's Johnson Wax Building in Racine, of 1938, particularly with the addition of the new laboratory tower completed last year, reveals on the other hand that the American architect's feats as an innovator in construction had not even reached their peak in 1932. If such buildings as Notre Dame du Raincy and the Racine structures are not prime examples of modern architecture, the word "modern" has no meaning. On the other hand, they certainly do not fit conveniently into the frame of the International Style as it was envisaged between 1922 and 1932.

With regard to the moment of stylistic crystallization in the 1920s I think it is still true to say, as we wrote in 1931:

... the man who first made the world aware that a new style was being born was Le Corbusier.

Furthermore, no one has done more than Le Corbusier ever since to extend and loosen the sanctions of the International Style. That was already apparent in 1932 in his house for Mme. de Mandrot at Le Pradet, of 1931, and in his Errazuriz house of the same date in Chile. It is in some respects perhaps less evident today, at least in New York, since the UN office building (in whose design he played some part) may be considered "early" Le Corbusier — like his Paris projects of the Twenties — rather than post-War Le Corbusier, at least in the form in which it has been executed.

In (Le Corbusier's) Citrohan house model of (1919-)1921 . . . the enormous window area and the terraces made possible by the use of ferro-concrete, together with the asymmetry of the composition, undoubtedly produced a design more thoroughly infused with new spirit, more completely freed from the conventions of the past, than any thus far projected.

It is interesting to compare the Citrohan house with Wright's Millard house in Pasadena, designed a year later. Note the similarity of the volume-concept of the interior, with the two-story living-area in front opening on a balcony, and the bedrooms and services on two levels behind. In 1931 it was hard to appreciate the originality in concept and in structure of the Millard house, because the patterned surface produced with the concrete blocks was so different from the

J. G. Perret et l'Architecture du Beton Armé—Paris et Bruxelles

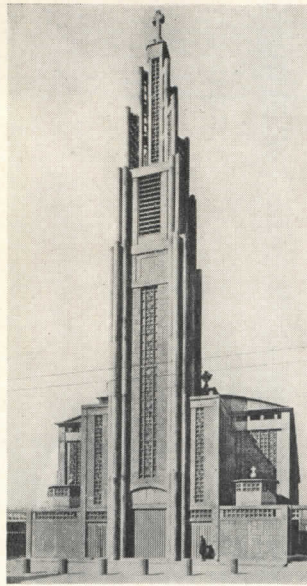

"Perret's church at LeRaincy . . . remains more striking . . ."

Architectural Record, December 1950

"Wright's Johnson Wax Building . . . architect's feats as an innovator . . ."



Courtesy Museum of Modern Art

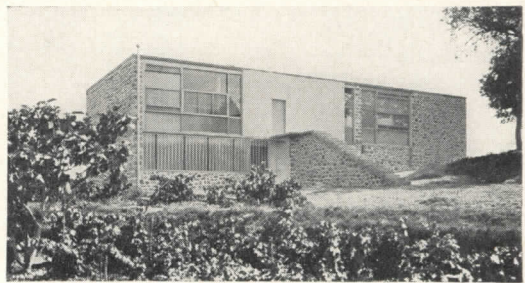

Le Corbusier's house for Mme. de Mandrot

" . . . to extend and loosen the sanctions of the International Style . . ."

"It is interesting to compare the Citrohan house (Le Corbusier) with Wright's Millard house in Pasadena . . ."

Le Corbusier

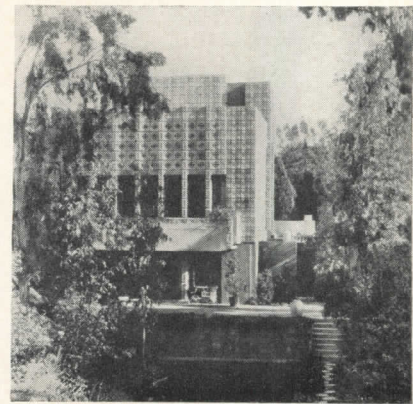
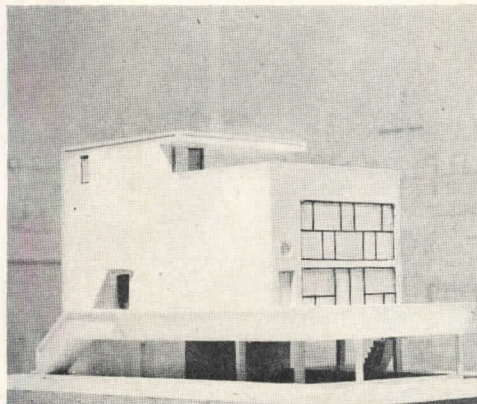

Courtesy Museum of Modern Art

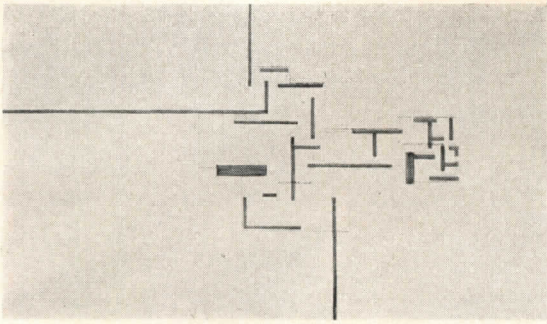

"Mies's country-house project of 1922 . . . seems even more significant today . . ."

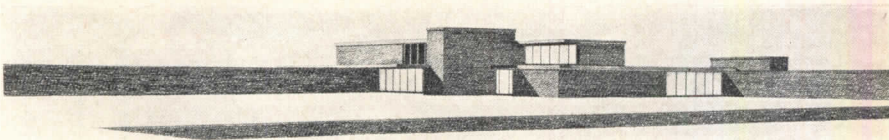

smooth rendered surfaces which were still the sign-manual of the International Style, particularly as illustrated in the work of the Le Corbusier before 1930. Now I think it is evident that such surface-patterning is a perfectly legitimate expression of the casting process by which Wright's blocks were made. Above all, 30 years have proved that patterned concrete surfaces, like Wright's of the 1920s, generally weather rather agreeably. The rendered surfaces of the early "International" buildings of the same period too often cracked and grew stained, thus losing all that quality of platonic abstraction which made them so striking.

(Le Corbusier) was not the only innovator nor was the style as it came generally into being after 1922 peculiarly his own. He crystallized; he dramatized; but he was not alone in creating.

Le Corbusier was certainly a good deal responsible for there being a recognizable international style. Yet Gropius's work and the work of his pupils is doubtless more typical of the style; and he has always been an equally effective proponent, even if he does continue to disown the idea of style at every opportunity.

It was in Mies's projects of 1922 that his true significance as an aesthetic innovator first appeared. In a design for a country house he broke with the conception of the wall as a continuous plane surrounding the plan and built up his composition of intersecting planes. Thus he achieved, still with the use of supporting walls, a greater openness even than Le Corbusier with his ferro-concrete skeleton construction.

Mies's country-house project of 1922, with its bearing walls of brick and its Van Doesburg-like plan, seems even more significant today than it did twenty years ago. It very evidently does not fit either the principle of enclosed volume or the principle of regularity. (This serious critical dilemma seems hardly to have been noted in 1931.)

The next section of the book was concerned with "Functionalism." For in 1932 *The International Style* was conceived as a counterblast to functionalism, at least as we then understood that term.

Some modern critics and groups of architects both in Europe and in America deny that the aesthetic element in architecture is important, or even that it exists. All aesthetic principles of style are to them meaningless and unreal.

There are still those who insist that architecture ought to be entirely a matter of technics and that architects should therefore hand over the whole field of building to engineers. But the glorification of engineering is a less popular critical gambit than it was earlier. (Then it will perhaps be recalled there was even a "Great Engineer" in the White House!) Yet, looking back over the building production of the last two generations, it is evident that the really great engineers have frequently built edifices which were more monumental and in many ways more visually effective than what most architects were able to achieve. The grain elevators of the Great Lakes ports stimulated Le Corbusier's ideas of what the new architecture might be like quite as much as did the "Tubism" of his friend the painter Leger. The engineer Freyssinet's hangar at Orly, of 1925, is still something that architects have been unable to rival for grandeur and clarity of form. The Goodyear Airship Dock at Akron is almost as impressive. What this really means is that some engineers are very good architects!

. . . (It is) nearly impossible to organize and execute a complicated building without making some choices not wholly determined by technics and

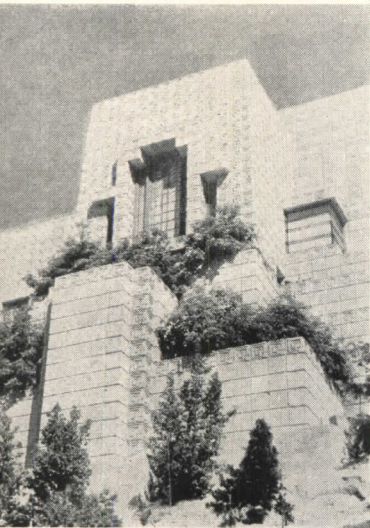

Architectural Record, August 1928

"... patterned concrete surfaces like Wright's of the 1920's generally weather rather agreeably."

"... Freyssinet's hangar at Orly, of 1925 . . . architects have been unable to rival . . ."

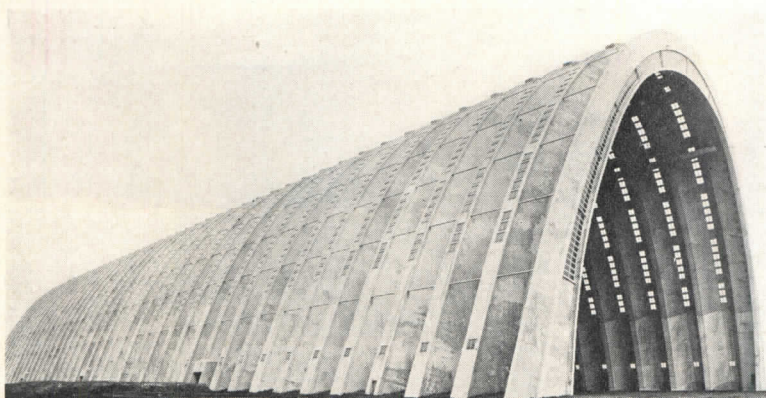

economics. . . . Consciously or unconsciously the designer must make free choices before his design is completed.

Some sort of architectural style inevitably arises from the characteristic ways in which those free choices are made. Thus functionalism, even in the drastic terms of the Twenties, could have turned into a style, and to some Europeans it seems to have become one — the International Style, in fact! It is not necessary, of course, that engineers, or those architects who prefer to think of themselves as “pure” functionalists, should be able to explain in words their principles of design. (Some engineers at least, such as Arup and Samuely in England, can do so, however, and often very ably.)

. . . Critics should be articulate about problems of design; but architects, whose training is more technical than intellectual, can afford to be unconscious of the effects they produce. So, it may be assumed, were many of the great builders of the past.

As I have already noted, Mr. Johnson has given the most effective evidence of his own broad interpretation of the International Style in the buildings he has designed, rather than in writing. My own writing of the last 20 years, and perhaps particularly the book on Frank Lloyd Wright, “In the Nature of Materials” (1942), indicates — sometimes implicitly, sometimes explicitly — how my own ideas have been modified. It is worthwhile, none the less, to consider here a particular principle of the International Style as we saw it in 1932, notably the one concerning “Architecture as Volume.” That was at best an ambiguous phrase, since volume is properly “contained space,” while we were then chiefly concerned with the avoidance of effects of mass in the treatment of the exteriors of buildings.

Contemporary methods of construction provide a cage or skeleton of supports. Now the walls are merely subordinate elements fitted like screens between the supports or carried like a shell outside them.

The particular relationship of skeleton and shell which we then considered most characteristic of the International Style can best be illustrated, paradoxically, by the plan of a building that has never been accepted as representative of the style, Perret's church at LeRaincy, of 1923.

It is true that supporting wall sections are still sometimes used in combination with skeleton structure.

An early example of this, by one of the recognized leaders of the International Style, is illustrated in the plan of Le Cor-

busier's de Mandrot house of 1931. We considered that rather an exception. But today a very large number of modern American houses include (often quite arbitrarily it would seem) sections of supporting masonry, sometimes of brick, sometimes of rustic stone-work, and very frequently of cinder or other concrete blocks introduced for effects of contrast and also because of their suitability in certain functional and structural situations. The idea may be abused but it can no longer be considered exceptional or reactionary.

The effect of mass, of static solidity, hitherto the prime quality of architecture, has all but disappeared; in its place there is an effect of volume, or more accurately, of surface planes bounding a volume. The prime architectural symbol is no longer the dense brick but the open box.

Certainly this statement is even truer, in a general way, than it was twenty years ago. Yet my fellow-author, Mr. Johnson, not only used a tower-like cylinder inside his house of glass in New Canaan, but contrasted the ultimate openness of the main house with a guest house of brick, almost as solid in appearance as if it had no interior whatsoever!

The most dramatic illustrations of the various methods of expressing interior skeletons still remain the American skyscrapers; but there are now rather more of them than there were in 1932, so that the character of their construction is better understood by the general public.

The McGraw-Hill Building comes nearest to achieving aesthetically the expression of the enclosed steel cage, but it is still partially distorted into the old silhouette of a massive tower. . . . Yet the architect, Raymond Hood, in the Daily News Building which is in other ways less pure in expression, handled the setbacks so that they did not suggest steps and brought his building to a clean stop without decorative or terminal features.

It has too often been forgotten — and apparently was by us when writing in 1931 — that long before Raymond Hood's day the

“ . . . plan of a building that has never been accepted as representative . . . Perret's church at LeRaincy . . . ”

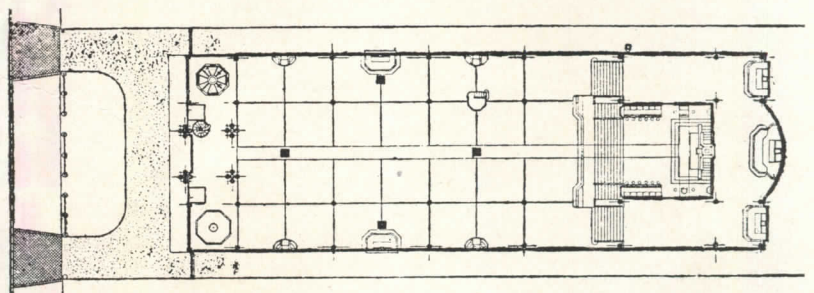

J. G. Perret et l'Architecture du Béton Armé — Paris et Bruxelles



Louis Sullivan's Gage Building of 1898 . . .

"the proper architectural expression of steel skeleton . . ."

Bayard or Conduit Building, of 1897, in New York, by Louis Sullivan, or better still his Gage Building, of the next year, at 18 South Michigan Avenue in Chicago, illustrated more clearly than Hood's skyscrapers, then newly completed, the proper architectural expression of steel-skeleton construction in the external cladding of a tall edifice. The later New York skyscrapers (and particularly those since the War that seem most literally to follow the precepts of the International Style in their design) are certainly not more expressive than these 50-year-old buildings. It is also interesting to note that Mies van der Rohe, in his Chicago apartment houses of the last few years, has moved closer and closer to Sullivan in the exterior treatment, whether the skeleton inside be of ferro-concrete or of steel. Even 20 years ago it was very difficult, apparently, to see the grandeur of the Sullivanian forest through the lush foliage of the ornament.

Style is character, style is expression; but even character must be displayed, and expression may be conscious and clear or muddled and deceptive. The architect who builds in the international style seeks to display the true character of his construction and to express clearly his provision for function. He prefers such an organization of his general composition, such a use of available surface materials, and such a handling of detail as will increase rather than contradict the prime effect of surface of volume.

The articulation of visible supports should also have been mentioned, whether isolated (as for example in the Johnson glass house or Mies's Farnsworth house on the Des Plaines river near Chicago) or actual sections of bearing wall (as in Le Corbusier's Le Pradet house or his house in Chile). A very striking example of vigorous articulation, in a quite sculptural way, of interior supports was in fact illustrated in the book, Aalto's Turun Sanomat Building at Abo in Finland, of 1930.

The flat roof was almost the sign-manual of the International Style in the early days. A loophole which proved very prophetic was left (fortunately) in the text on this subject:

Roofs with a single slant, however, have occasionally been used with success. Flat roofs are so much more useful that slanting or rounded roofs are only exceptionally justified.

The last sentence certainly represented a puristic and also a pseudofunctional position. But roofs are certainly of great importance

in determining the character of the architecture of any period, particularly as regards small structures such as houses. Many architects have now swung so far from the belief that roofs must be flat that there is a tendency to over-exploit elaboration of the sky-plane.

Since the roof was expected 20 years ago to be invisible, a great deal of space was given to the surfacing of exterior walls in the 1932 book.

The spirit of the principle of (continuous) surface covers many exceptions to its letter. The type of construction represented by Mies van der Rohe's Barcelona pavilion, as well as that represented in Le Corbusier's house at Le Pradet, leads to a treatment of surfaces sensibly different from that which has been primarily stressed here.

Obviously these exceptions should have been a warning that the aesthetic "necessity" for the treatment of exterior walls as continuous surface was being much exaggerated. Curiously enough, California architects, working mostly with wood, have of late years been more faithful to the principle of continuity of surface than the European architects who were originally the most devoted to rendered and painted surfaces of cement.

The general statement with which this section concluded had its sound points:

The principle of surface of volume intelligently understood will always lead to special applications where the construction is not the typical cage or skeleton of supports surrounded by a protecting screen. The apparent exception may not prove the validity of the general principle, but it undoubtedly indicates its elasticity. Rigid rules of design are easily broken once and for all; elastic principles of architecture grow and flourish.

Rather than proceed with so detailed a commentary, it may be well to lead into a conclusion to this article by quoting a few of the more general remarks of 20 years ago which seem to remain valid still.

The second principle of contemporary style in architecture has to do with regularity. The supports in skeleton construction are normally and typically spaced at equal distances. Thus most buildings have an underlying regular rhythm which is clearly seen before the outside surfaces are applied. Moreover, economic considerations tend to favor the use of standardized parts throughout. Good modern architecture expresses in its design this characteristic orderliness of structure and this similarity of parts by an aesthetic ordering which emphasizes the un-

"... Mies in his Chicago apartment houses . . . moved closer and closer to Sullivan . . ."

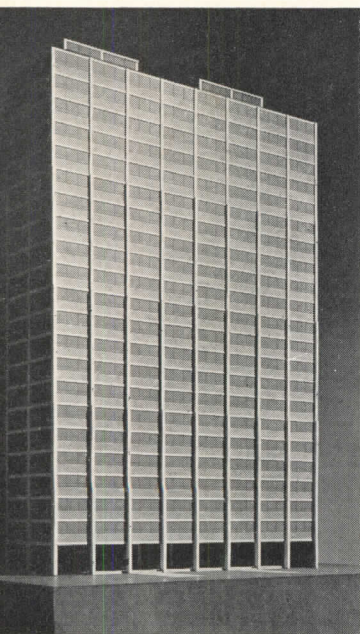

"A very striking example of vigorous articulation . . ."

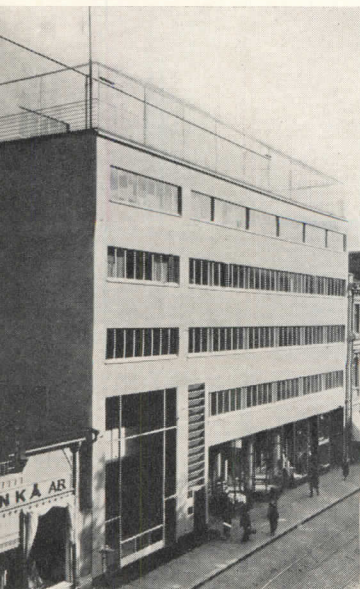

Photos Courtesy, Museum of Modern Art

derlying regularity. Bad modern design contradicts this regularity. Regularity is, however, relative and not absolute in architecture.

. . . the nearer approaches to absolute regularity are also approaches to monotony. . . . The principle of regularity refers to a means of organization, a way of giving definite form to an architectural design, rather than to an end which is sought for itself.

. . . The avoidance of symmetry should not be arbitrary or distorted. . . . The mark of the bad modern architect is the positive cultivation of asymmetry for decorative reasons. For that can only be done in the majority of cases at the expense of common consistency and common sense. The mark of the good modern architect, on the other hand, is that the regularity of his designs approaches bilateral symmetry.

Exceptions to general rectangularity are only occasionally demanded by function and they may introduce complications in the regular skeleton of the structure. Non-rectangular shapes, particularly if they occur infrequently, introduce an aesthetic element of the highest positive interest. . . . They need seldom occur in ordinary building, but in monuments where the architect feels justified in seeking for a strongly personal expression, curves will be among the elements which give most surely extreme positive or negative aesthetic value. Curved and oblique forms seldom find a place in the cheapest solution of a given problem. But, if they can be afforded, they succeed, as they fail, on aesthetic grounds alone.

Aalto's Senior House at the Massachusetts Institute of Technology, of 1948, is obviously the most striking illustration of the increased use of curved and oblique forms. Whether most people approve of this prominent building or not, they tend to assume that Aalto was here consciously breaking with the rigidities of the International Style. Actually, as the paragraph above makes evident, even this notable post-War structure, though it may be at the extreme limit of the International Style as we understood it 20 years ago, is still in actual opposition to its sanctions only in the expressive irregularity of the plan and a few rather minor details, such as the willful roughness of the brickwork and the excessive clumsiness of some of the membering. Aalto was really reacting here, not against the International Style, but against that vulgar parodying of its more obvious aspects — the "Drugstore Modern" — which had become ubiquitous in the previous decade.

It was naturally to be expected, as the International Style became more widely accepted, that more and more weak and imitative architects would attempt to exploit its characteristic features. In 1932 we were amazingly optimistic and full of faith. We wrote:

Anyone who follows the rules, who accepts the implications of an architecture that is not mass

but volume, and who conforms to the principle of regularity can produce buildings which are at least aesthetically sound. If these principles seem more negative than positive, it is because architecture has suffered chiefly in the last century and a half from the extension of the sanctions of genius to all who have called themselves architects.

But it has not, of course, worked out that way. Many docile architects, and even builders outside the profession, have followed the rules dutifully enough, but their buildings can hardly be considered aesthetically sound. Doubtless the principles educed twenty years ago were too negative, and now we are ready, probably too ready, to extend the sanctions of genius very widely once more. If my tentative prognosis be correct, that we stand now at another change of phase in modern architecture between a "high" and a "late" period, we must expect

Aalto's Senior House at M.I.T.

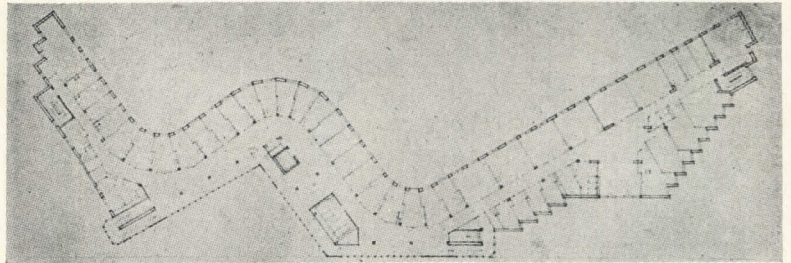

“. . . . striking illustration of the increased use of curved and oblique forms.”

many vagaries in reaction against the too literal interpretation of the International Style. We may also expect — and indeed already have with us — an academic current which is encouraging the repetition of established formulas without creative modulation. If the next 25 years are less disturbed by depressions and wars than the last have been, I suspect that our architecture will grow more diverse in kind. But I doubt if we will, for the next generation or more, lose contact altogether with the International Style, if that be interpreted as broadly as it was meant to be in 1932.

The International Style was not presented, in the 1932 book which first gave currency to the phrase, as a closed system; nor was it intended to be the whole of modern architecture, past, present, and future. Perhaps it has become convenient now to use the phrase chiefly to condemn the literal and unimaginative application of the design clichés of 25 years ago; if that is really the case, the term had better be forgotten. The "traditional architecture," which still bulked so large in 1932, is all but dead by now. The living architecture of the twentieth century may well be called merely "modern."



Geoffrey Baker Photo

NEW CANAAN, CONN., ELEMENTARY SCHOOL

*Sherwood, Mills & Smith
Architects*

*O'Connor & Kilham
Consulting Architects*

*Seelye, Stevenson & Value
Structural Engineers*

*Hill and Harrigan
Mechanical Engineers*

*Lynch and Kline
Landscape Architects*

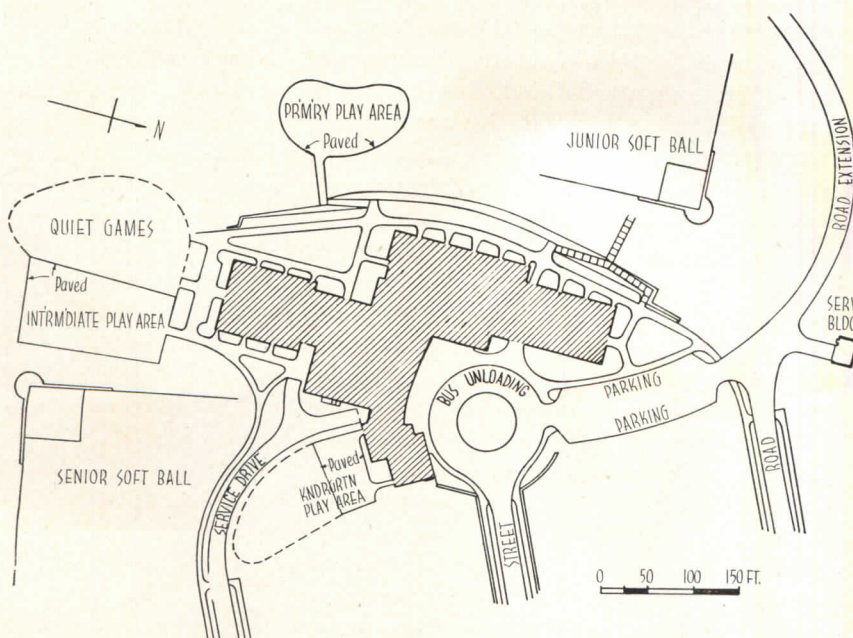

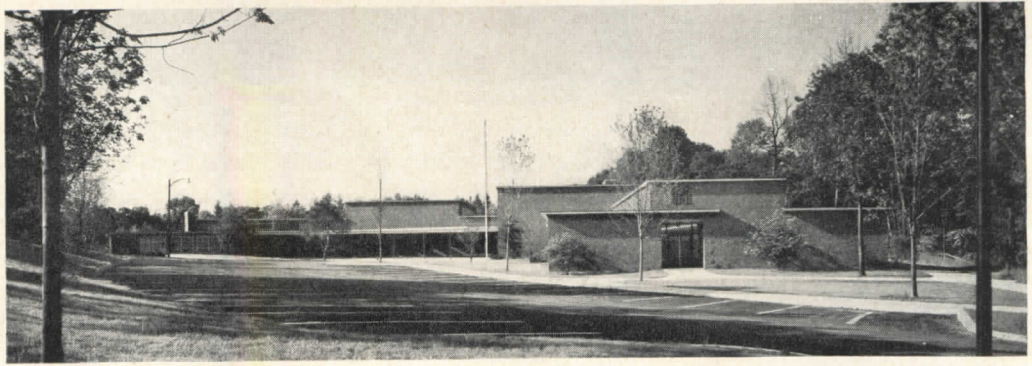

Joseph W. Monitor Photos

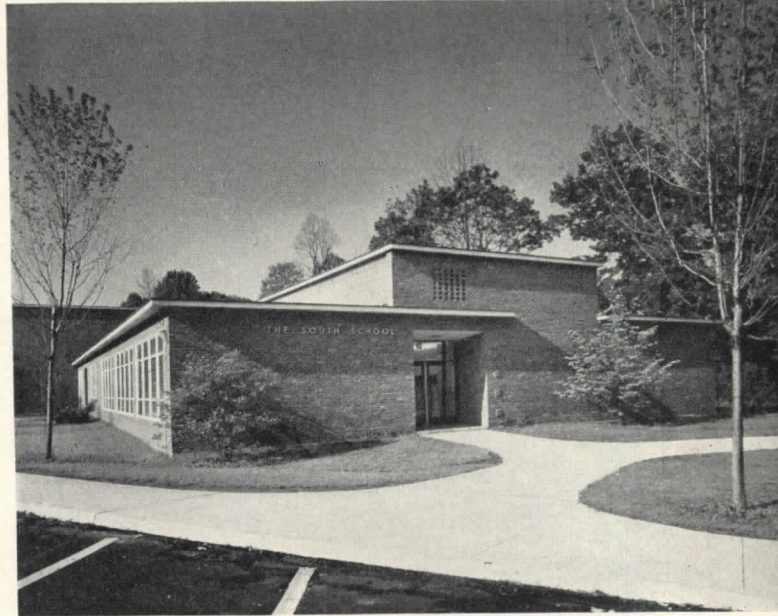
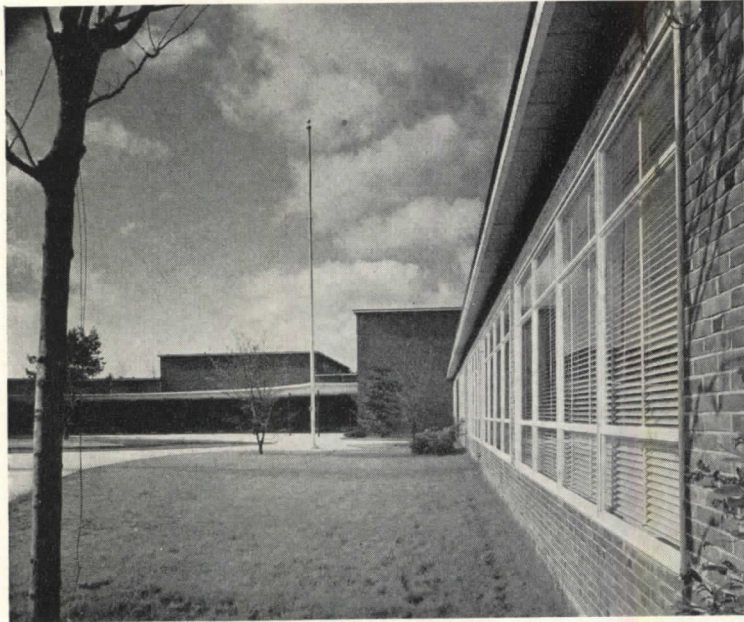

ATTRACTS PROFESSIONAL ATTENTION

Many Architects and Educators Are Impressed with South School

WITH THE NEED for elementary schools so great, most school boards must resolve most questions largely on the basis of cost, and a great many schools come into the public eye as demonstrations of cost-cutting ideas. This one, much visited by school people and architects from near and far, has another claim to distinction; it is rather a demonstration of better standards of school building.

The new South School came into being only after unusually thorough study of criteria and plan suggestions. The building committee stayed by its criteria much more firmly than is usually the case when the cost figures come in, so that the spaces are what they wanted without much paring down. This is a school, then, that rates with visitors on the basis of desirability.

On the cubic foot basis the school is not expensive — something like 78¢, equipped. Square foot cost is \$13.50. But when the total space is absorbed on a per-classroom basis, the cost per classroom runs to \$41,600 or \$1,280 per pupil.

Such matters were not tossed off lightly. One scheme,

for example, called for a two-story classroom wing. Studies indicated a cubic foot saving of 6 per cent over the one-story scheme, but the committee decided that maintaining high standards was more important than undue economy. Similarly, other standards — separate auditorium and gymnasium, for another example — were upheld.

On the other hand, the school makes full use of a cost-saving idea that school architects have long discussed — the lower ceiling. Classroom ceilings have been brought down to 10 ft, with, of course, a substantial cut in cubage. Architects have been asking for this concession in state codes, not only for the saving in building volume, but also for the more intimate character it gives classrooms through more logical scale for small children. Sherwood, Mills & Smith were instrumental in getting this provision in the code, as one of the partners helped prepare a new code for the state department of education.

Contributing importantly to the feasibility of the low ceiling is a scheme of bilateral lighting to bring daylighting to the inner third of the classrooms. A monitor

NEW CANAAN SCHOOL

over the center of the classroom wing has a high clerestory of glass block fenestration, with angled reflectors supported on the under side on one of the truss members. Light thus reflected is shielded by eggcrate louvers. Light readings show excellent daylighting in the inner part of classrooms, and the lower ceiling aids in the perennial problem of glare at the window side. There are, however, venetian blinds for more positive control.

One very apparent feature of the school is the space luxury noted above, especially in extra corridor space. The central corridors are considerably widened, and several benefits accrue. Perhaps best of all, there is a nice freedom of movement in moments of heavy youngster traffic. The corridors also function as indoor play space in bad weather, and they make good exhibit rooms. And in one a widened corridor end has been furnished

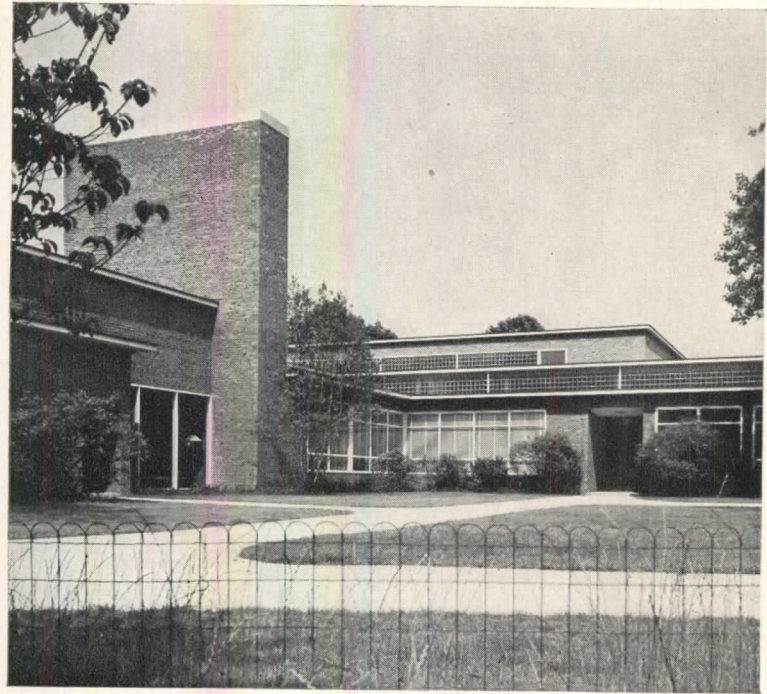
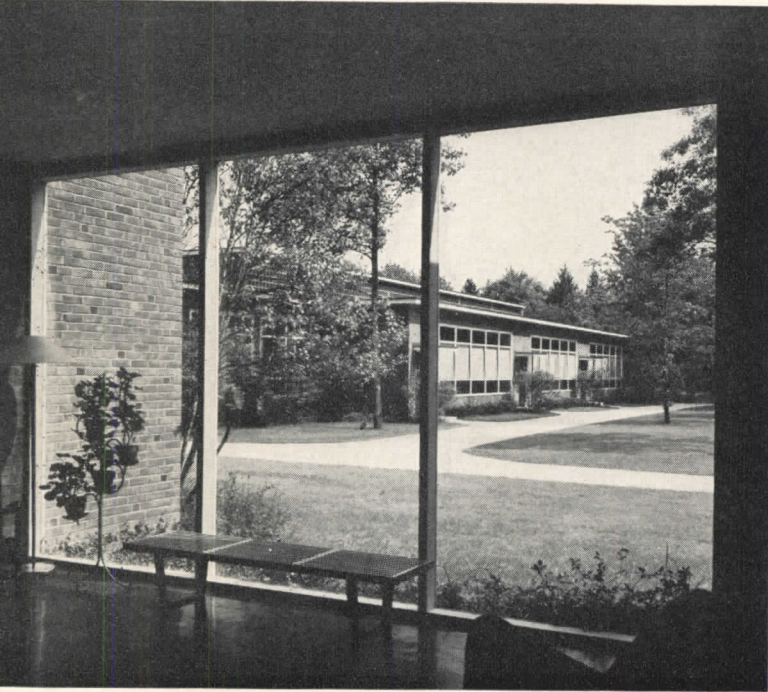

Joseph W. Molitor Photos

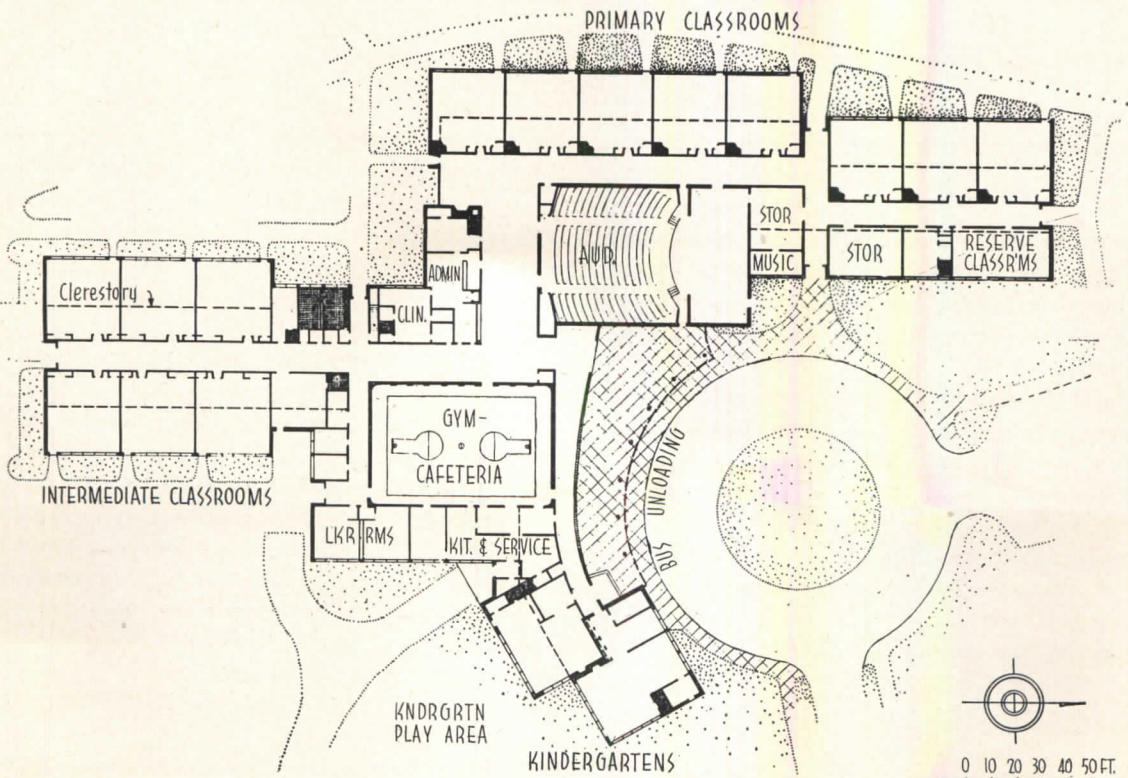

as a lounge, with fireplace and full-length mirrors, which serves as an extra room for conferences with parents or committees. These corridor-play-spaces have been done with considerable gaiety and a great deal of natural lighting (see page 102) and do much to lighten the feeling of the school.

The inviting quality that comes from space and bright notes is apparent at the main entrance. Here is a

wide covered platform where busses unload, lighted at the inside by plastic bubbles overhead, which throw odd patterns of light. The large platform, as well as giving plenty of room for active kids, is very useful space in rainy weather.

Once the requirements for spaces and facilities were shaken down to a fairly firm agreement all around, the architects tried a number of layout schemes to study



Joseph W. Molitor Photos

The plan finally used was the tenth scheme studied. Relationships of the several elements, together with full use of the wooded site, determined the development of the design. Exterior lines are kept low and rather informal, and in a scale suitable to primary school ages. In corridors, below, colors are gay; a cork strip is inserted in wall finish for exhibits

Geoffrey Baker Photos

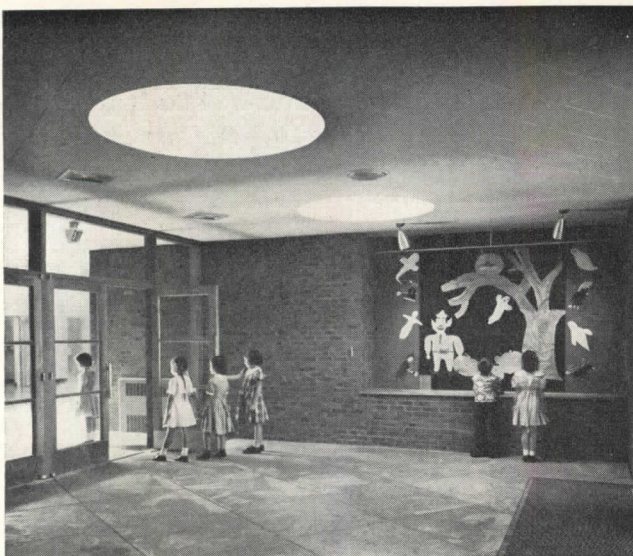

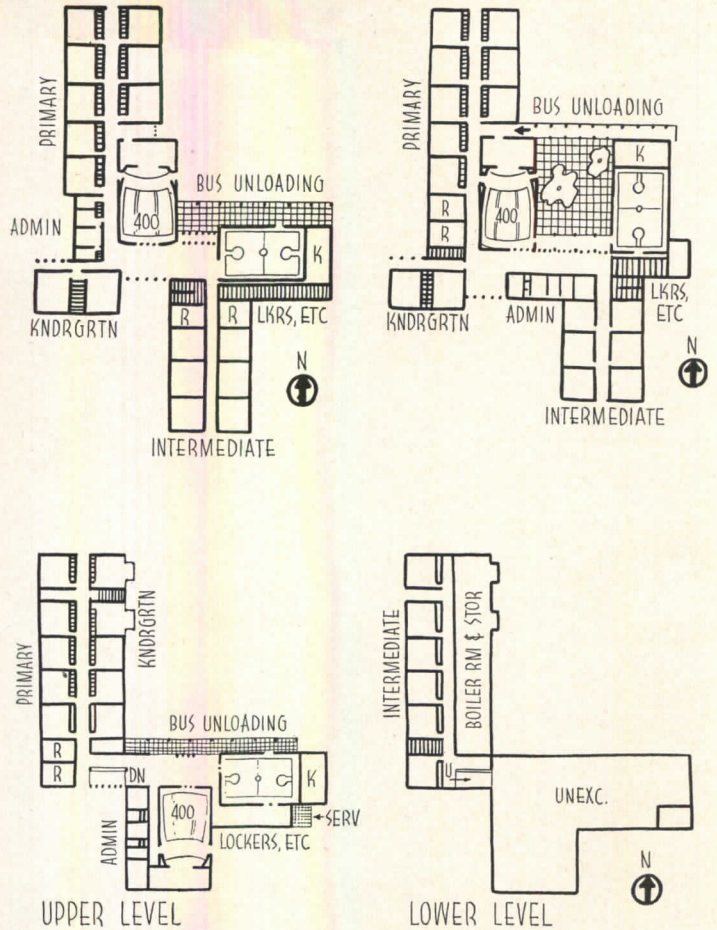
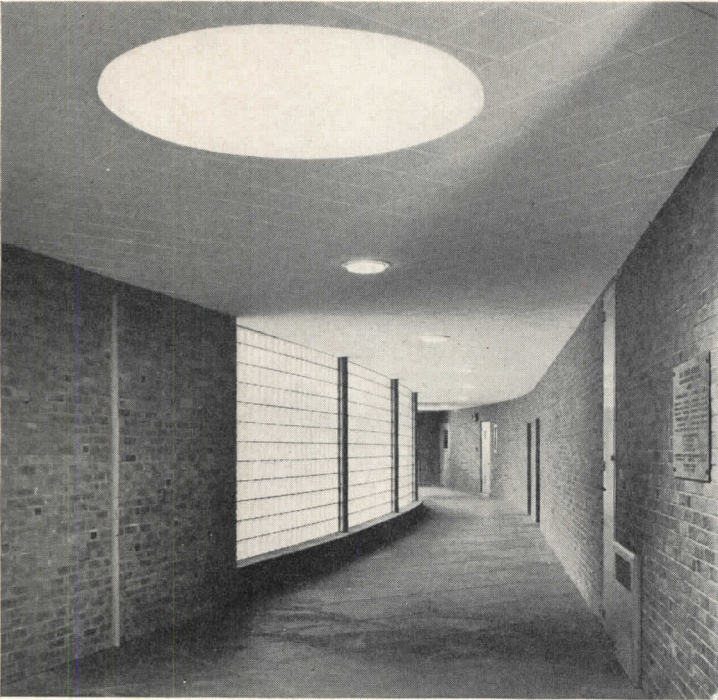
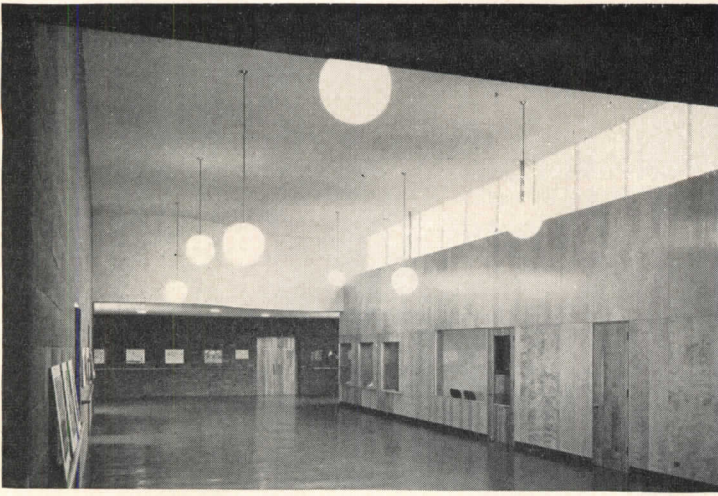

Three of the nine preliminary schemes are sketched above

the relationships of various elements, the planning of the classrooms, and then to test these for construction problems and costs. Three of the early schemes, including one for a two-story classroom wing, are shown above. The final plan (page 100) was the tenth of the series. It will readily be seen that this was a study of functioning. It will also be seen that exterior vistas are largely determined by the studied use of the site for segregated play areas; and that they are quite pleasant.

The site, by the way, was a difficult one, even though it met quite fortunately the important criteria of accessibility, safety, and so on. But contours thrust the building to one side of the site, and forced the landscaping and use somewhat.

The building is oriented to give the desirable exposures to various groups of classrooms — east or west for primary and intermediate rooms, southeast for the kindergarten. Classrooms were arranged to allow natural

separation of pupil age groups: kindergarten rooms in the east wing, primary (grades one to three) in the west wing, intermediate (grades four to six) to the south.

The square classroom was chosen as the type best suited to the criteria set up. These are given as: 1. maximum flexibility, 2. convenience, 3. uniform lighting, 4. economy, 5. intimate character, 6. low maintenance, 7. adequate storage space. The square classroom stood up against various other shapes and schemes with which it was compared in study conferences.

The final units are just under 30 ft on a side. Each has separate outside entrance as well as corridor door. Inside walls are developed for closed storage closets and toilets (through primary grades).

The exterior has the low, informal lines that were suggested by the plan. And the architects particularly tried to maintain a small, intimate scale consistent with the purposes, and occupants, of the school.

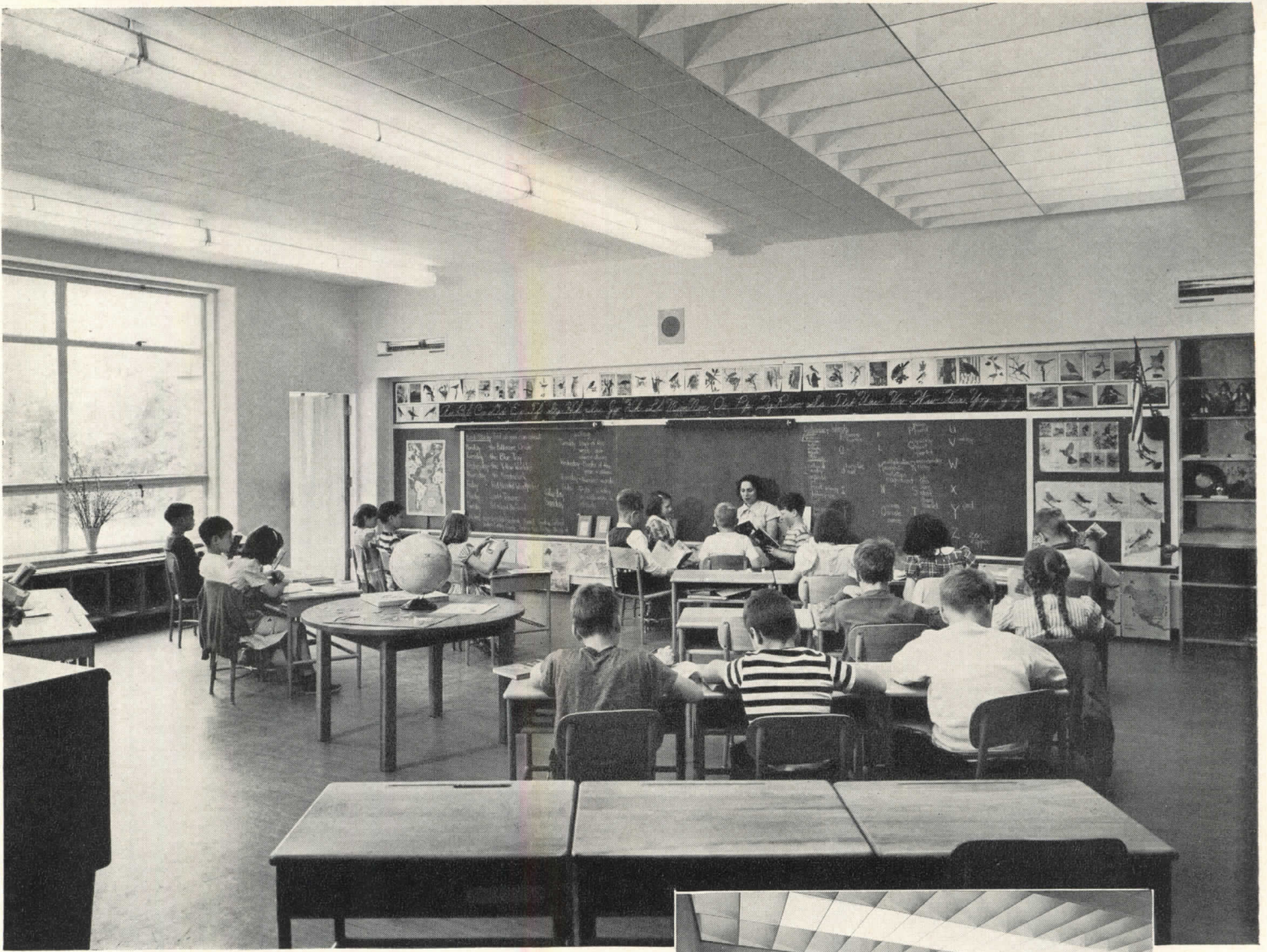

Joseph W. Molitor Photos

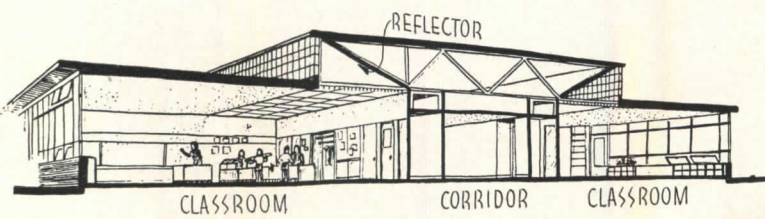

Notable about the classrooms is the low ceiling, 10 ft, maintaining a child scale and a more intimate character. Interior daylighting, necessary to this ceiling height, comes via glass block clerestory, light reflectors angled with one of the truss members, and an eggcrate light shield

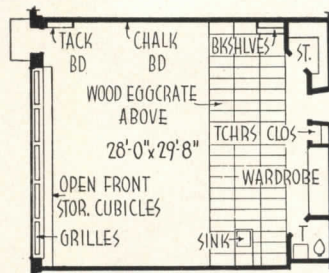

TYPICAL PRIMARY CLASSROOM

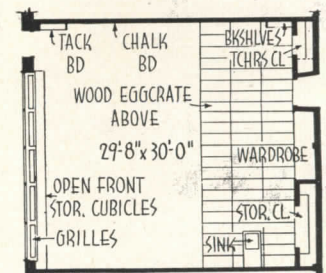

TYPICAL INTERMEDIATE CLASSROOM

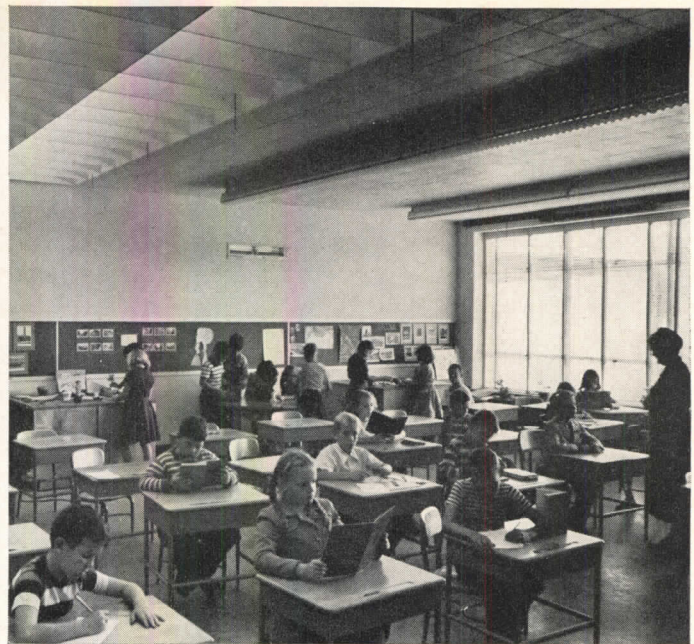

Geoffrey Baker Photos

Kindergarten rooms (above left and below) have more extensive eggcrate-shielded bilateral lighting than do the rooms for older children (above right). Interior daylighting helps make acceptable the low ceilings desired in schools

Joseph W. Molitor Photo





Joseph W. Molitor Photos

The South School combines lunchroom with gymnasium, instead of gymnasium with auditorium. Lunch tables and seats fold into gymnasium walls. Auditorium seats 400, has full stage; serves also for community functions





Joseph W. Molitor

CLEMSON HOUSE AND

CLEMSON A. & M. COLLEGE

CLEMSON, SOUTH CAROLINA

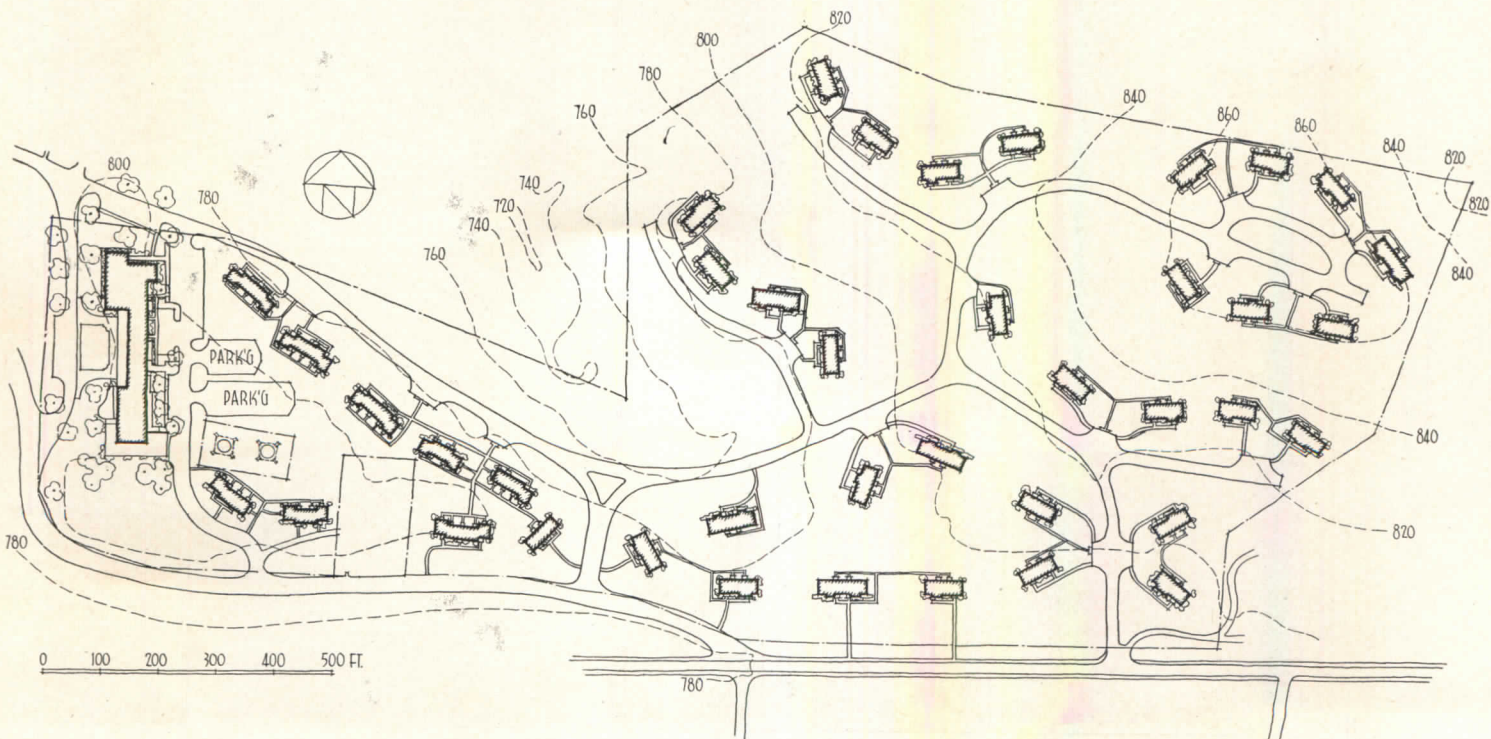

CLEMSON HOUSE is, in effect, a hotel for transients plus an apartment hotel; it has, besides its 96 bedroom-bath combinations, 60 one-room efficiency apartments, 24 one-bedroom apartments, 12 two-bedroom units and one three-bedroom penthouse called the Farmer's Club. This last is occupied from time to time by visiting dignitaries, concert stars and other notables. In addition to providing living quarters for faculty and student personnel, Clemson House amply accommodates visitors, conventions and the periodic meetings normal at such a college. Formerly, this type of accom-

modation did not exist within 20 miles of the campus.

Clemson Homes, on the other hand, is a large group of multifamily dwellings, primarily for faculty members, developed logically on land adjacent to Clemson House but not entirely tied to it in design. Clemson Homes has 32 duplexes with two- and three-bedroom units, four quadruplexes and four quintuplexes, providing a total of 100 apartments. Every effort was made in their design to preserve the individuality of each Clemson Homes apartment, in contrast to the usual design of multifamily buildings.

William G. Lyles, Bissett,

Carlisle & Wolff, Architects

CLEMSON HOMES

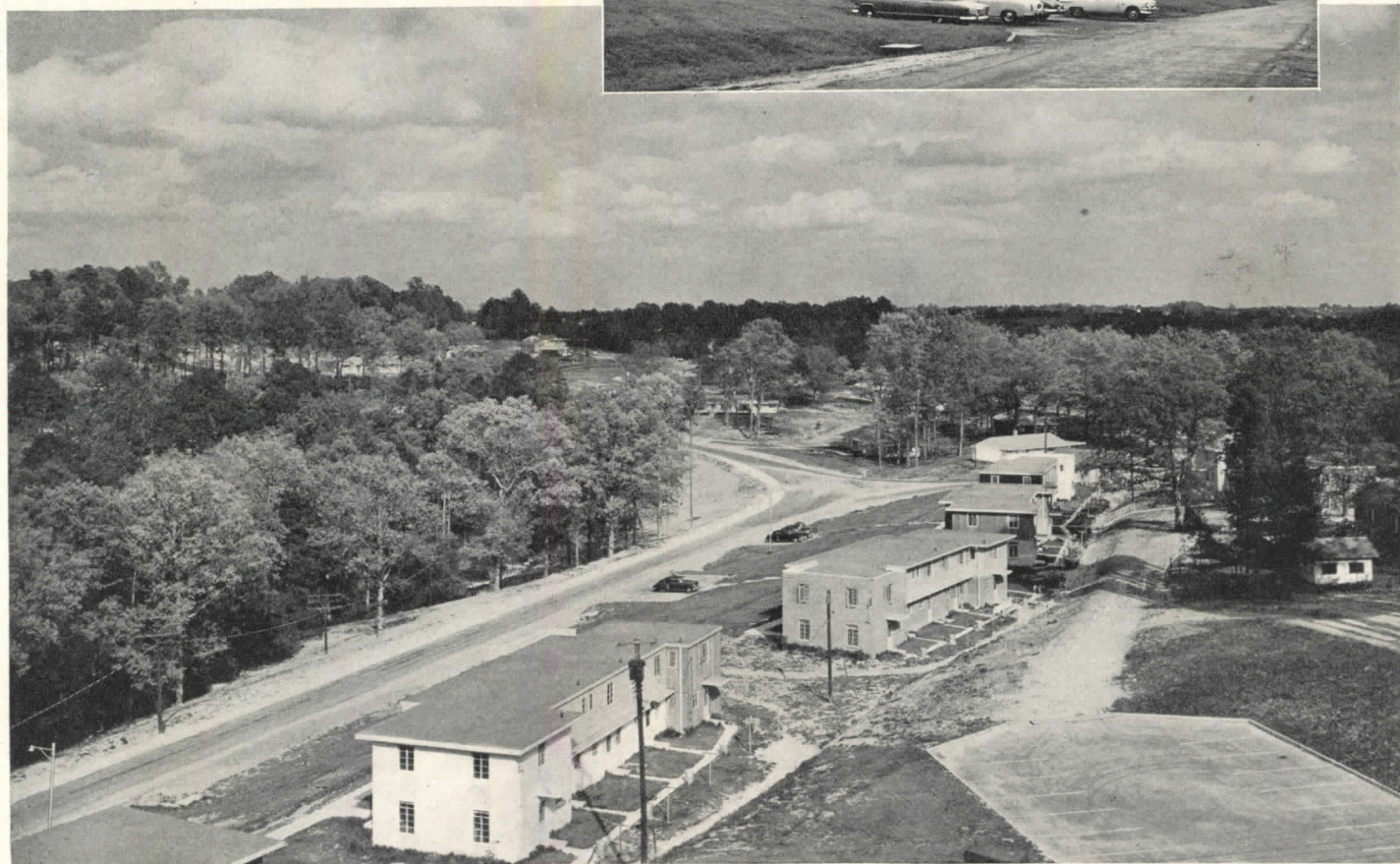

CLEMSON HOUSE AND CLEMSON HOMES

Patchen & Zimmerman, Engineers
Eugene R. Martini, Landscape Architect
Willard Hirsch, Sculptor
Daniel Construction Co., General Contractors



Clemson is a military college, so the main dining room is called the Saber Room; it has places for 300 diners and has a polished slate floor suitable for dancing. Above, first-floor entrance facade and (right) hotel desk and elevators. The ornamental sculpture in the middle of the reflecting pool at the entrance is a stainless steel tiger, the Clemson mascot, which bobs and weaves pugnaciously when a breeze blows. Below, first-floor corridor. Facing page, ground-floor IPTAY Tavern, named for the alumni athletic club, "I Pay Ten A Year"

Joseph W. Molitor

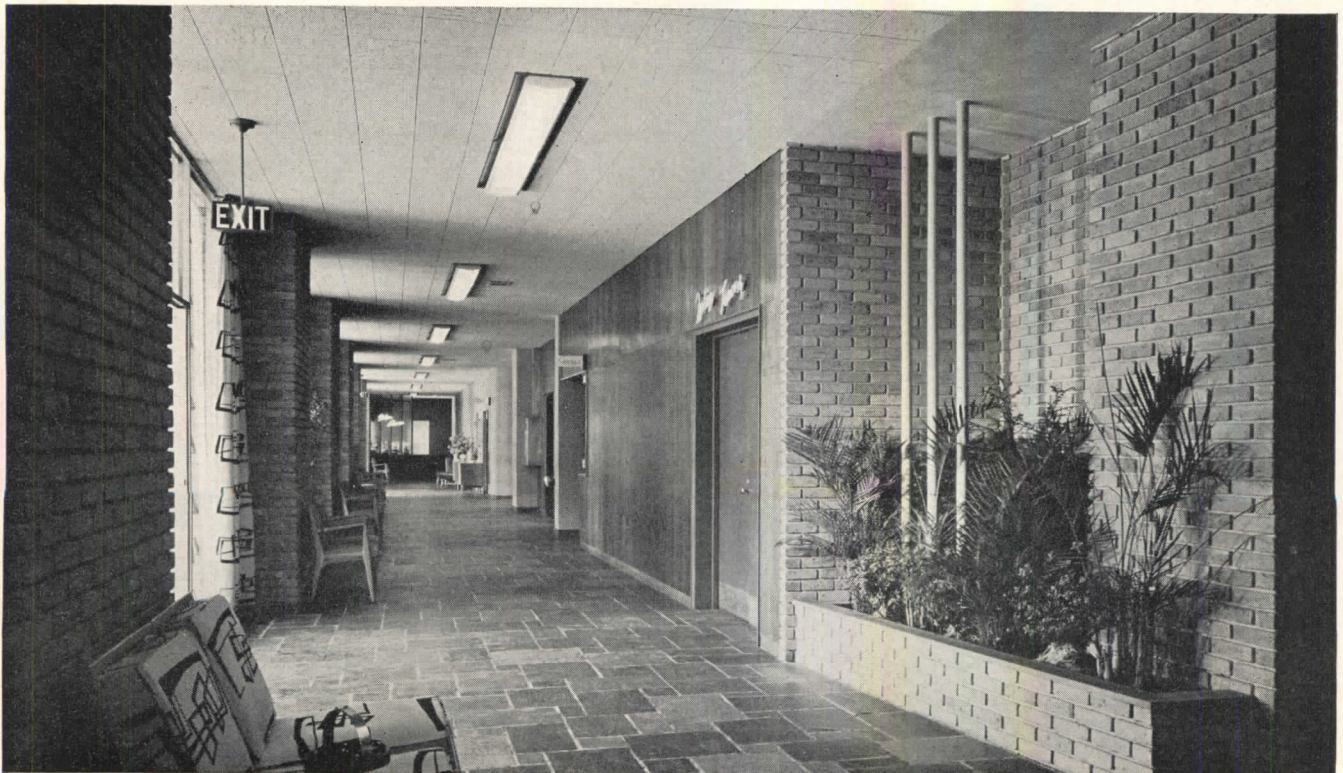

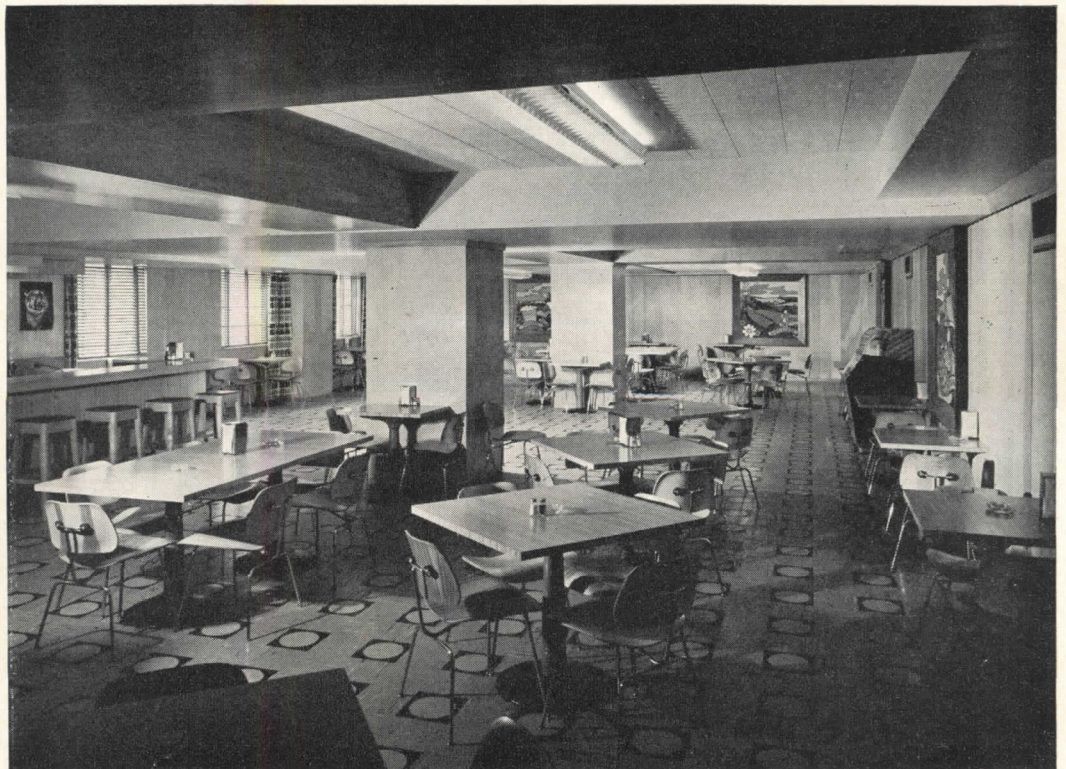
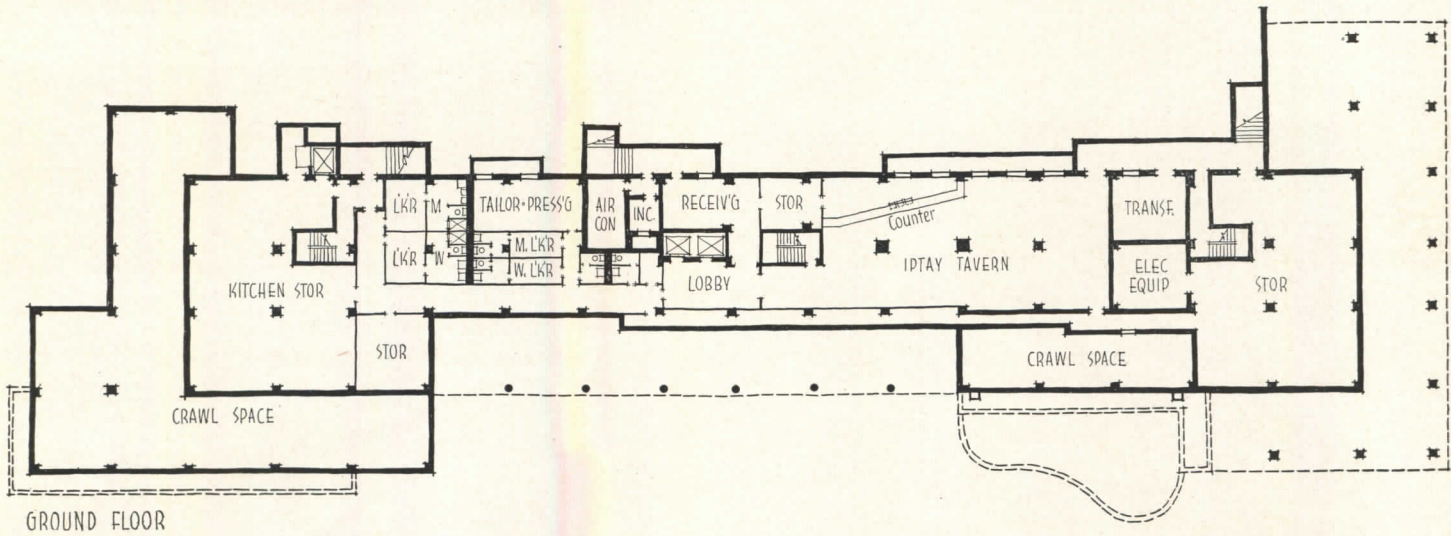
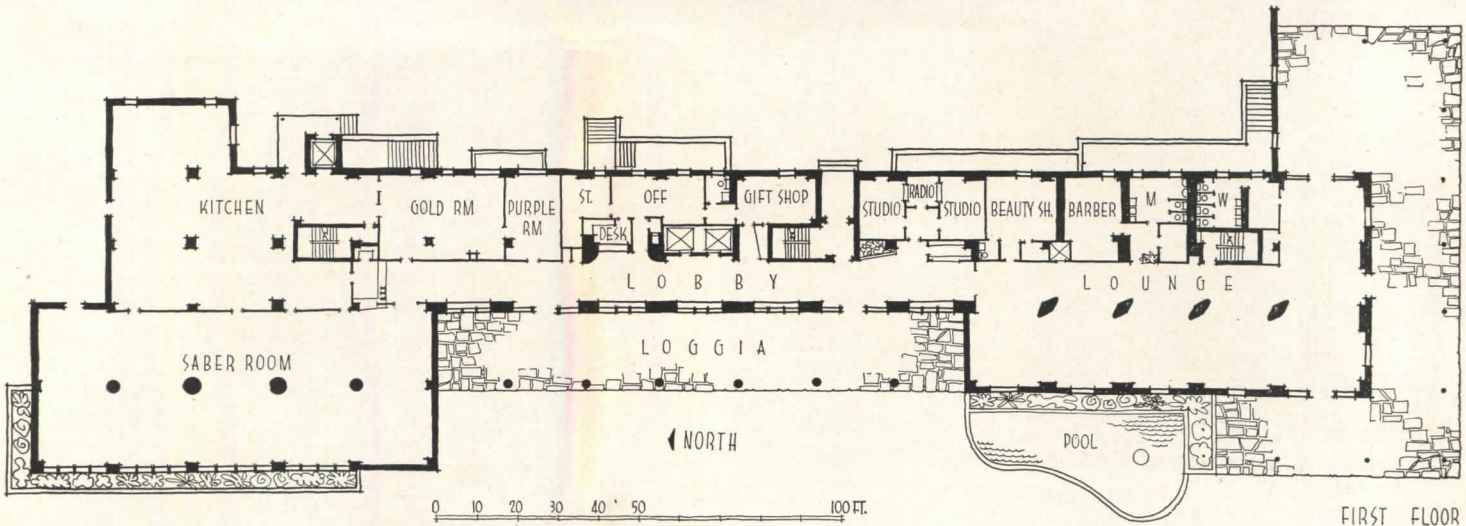

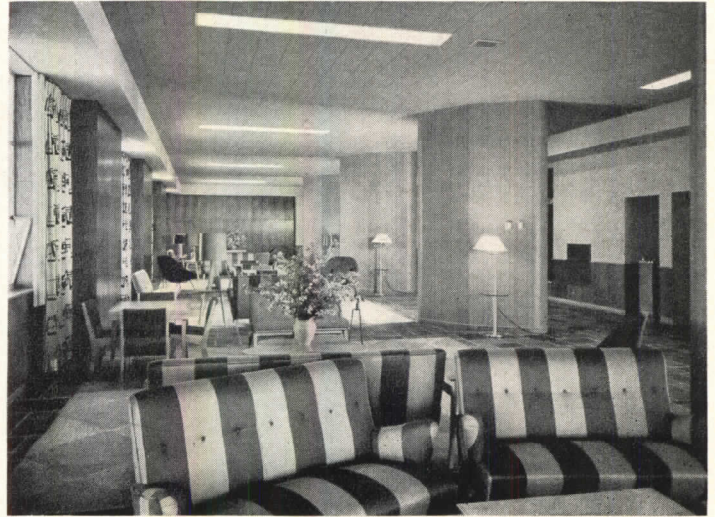
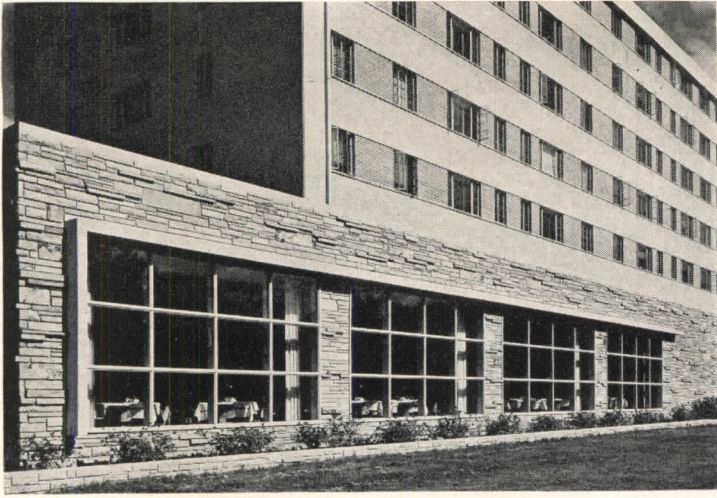

Above, left to right, top row: exterior and interior Saber Room; second row: entrance to Saber Room; Main lounge. Below, Farmers Club (penthouse); photos show, left to right, dining room, living room, bedroom

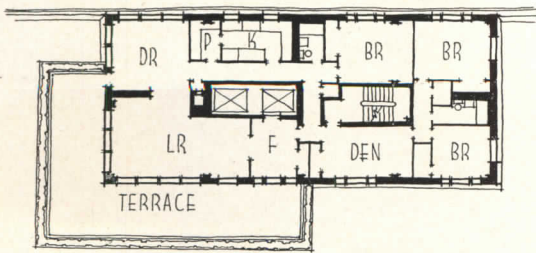

FARMERS CLUB FLOOR



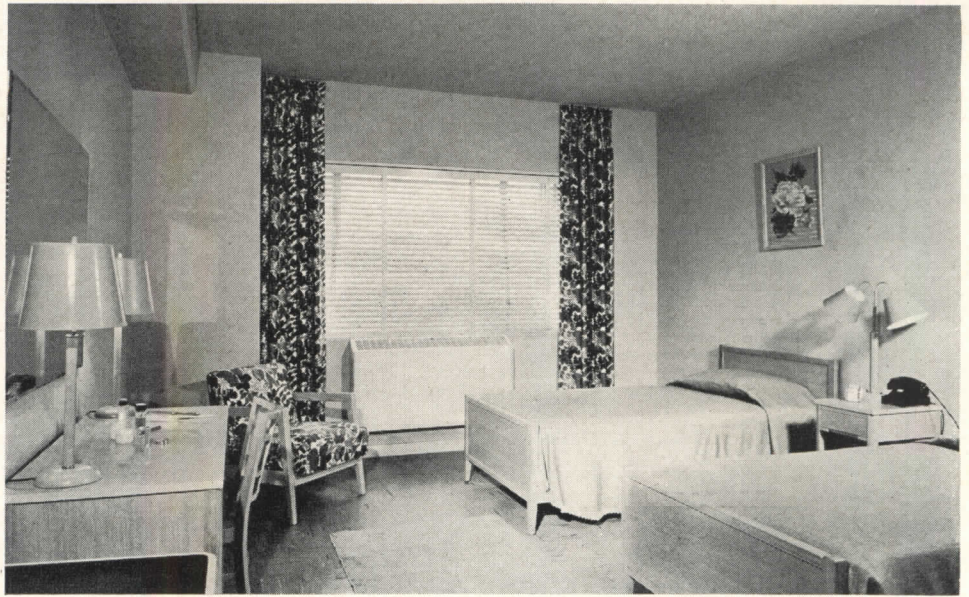

Above, typical transient room; below, typical hotel floor containing both transient rooms and one- and two-bedroom apartments. Building is of fireproof construction with reinforced concrete frame; walls are surfaced with brick, Tennessee Quartzite and concrete. Public rooms have slate floors, acoustic ceilings, and walls of exposed brick, stone, wood or plastic-treated fabric. First floor and penthouse are fully air conditioned

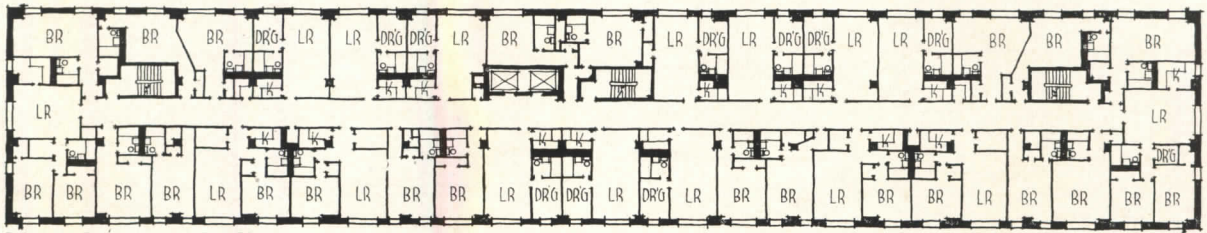

TYPICAL FLOOR • 2ND TO 7TH

Joseph W. Molitor

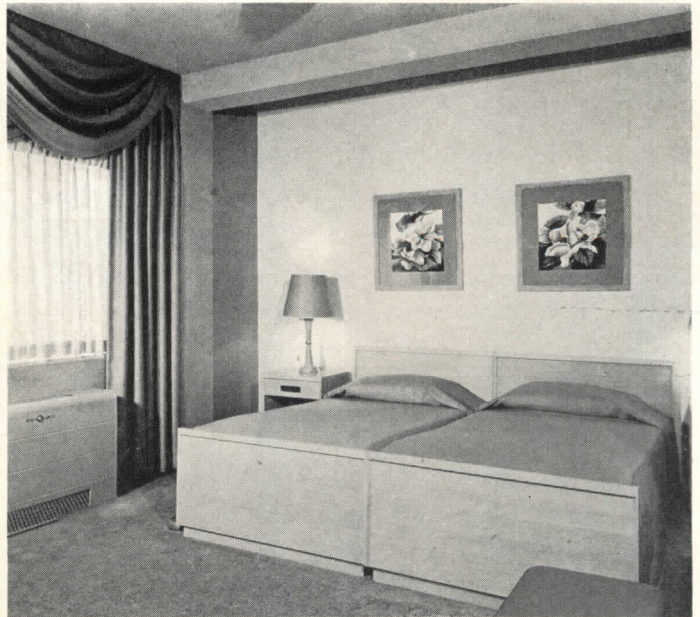
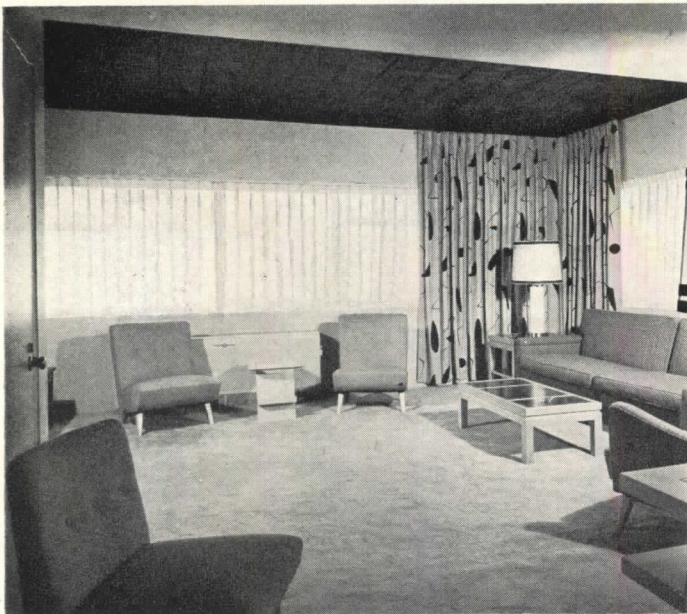

CLEMSON HOMES

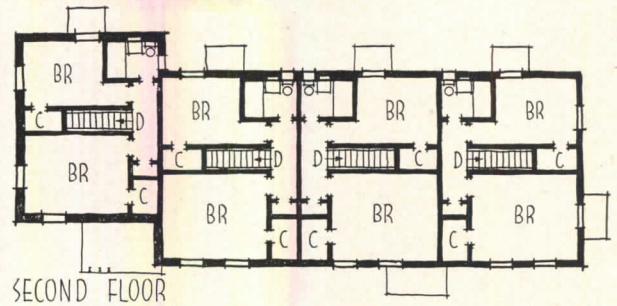
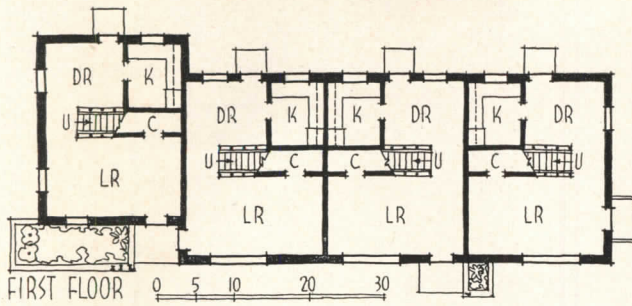

Plans of 4-family duplexes, above, are identical; facades, on facing page, are varied. 5-family dwellings are similar, with another apartment added. Throughout the project every attempt is made to give each apartment individuality

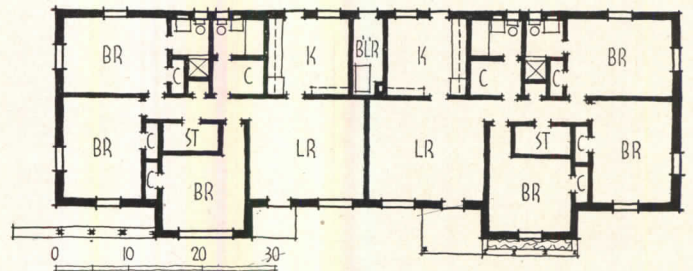
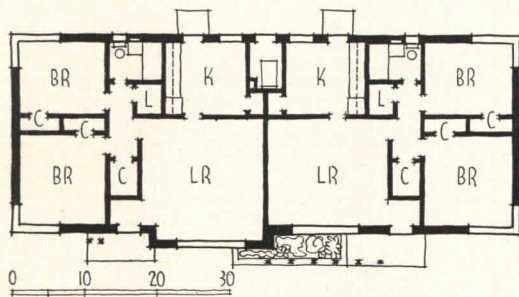

One-story units in Clemson Homes have several types of plans, of which two are shown above. Variations in exterior treatment appear in the photos on the facing page. Interiors, bottom of facing page, show living room, dining space and stairs in a typical two-story apartment

Clemson Homes, on land adjacent to Clemson House, provides faculty quarters for the college. Together, the Homes and the House solve a difficult housing problem common to many educational institutions, particularly those which are not located in large metropolitan areas.

Structurally, Clemson Homes have wood framing supported by concrete and brick foundations. Exterior wall surfacing varies; redwood, brick, cedar shingles, asbestos-cement board, and wood siding are all used.

Interiors are plastered and painted. Roofs are either built-up or covered with asbestos shingles. Floors are asphalt and ceramic tile; sash are steel; doors, wood. Thermal insulation is applied above ceilings. Heating plants (note location in plans above) have oil-fired furnaces supplying one-pipe hot water systems with recessed convectors. Kitchens have electric ranges and refrigerators, wood cabinets, and cast iron enameled sinks.

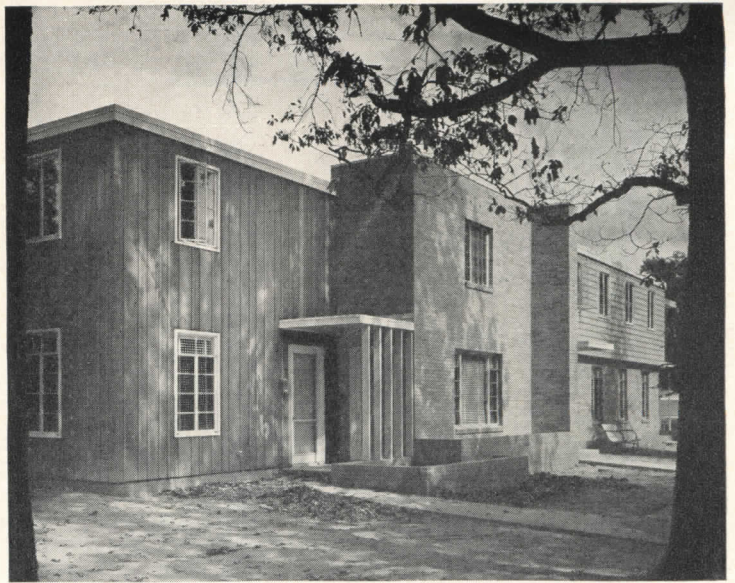

Joseph W. Molitor

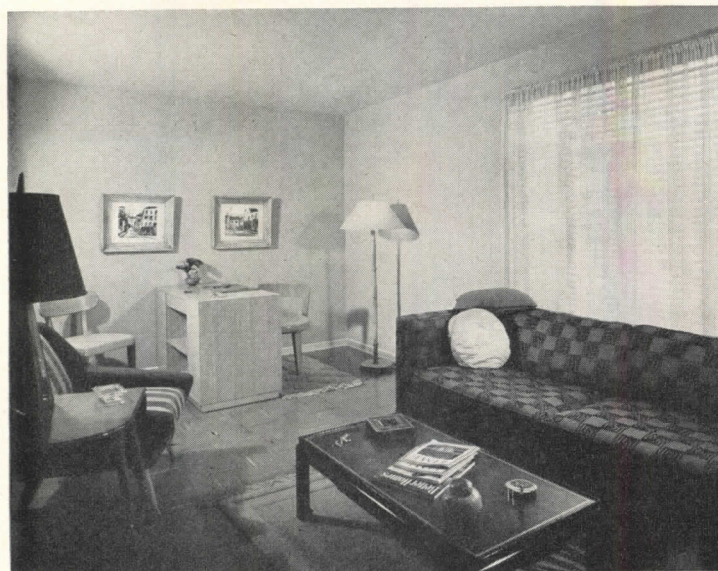

RESIDENCE OF MR. AND MRS. SAMUEL RUBINSTEIN

Seattle, Washington

J. Lister Holmes & Associates, Architects

Tucker, Shields and Terry, Interiors

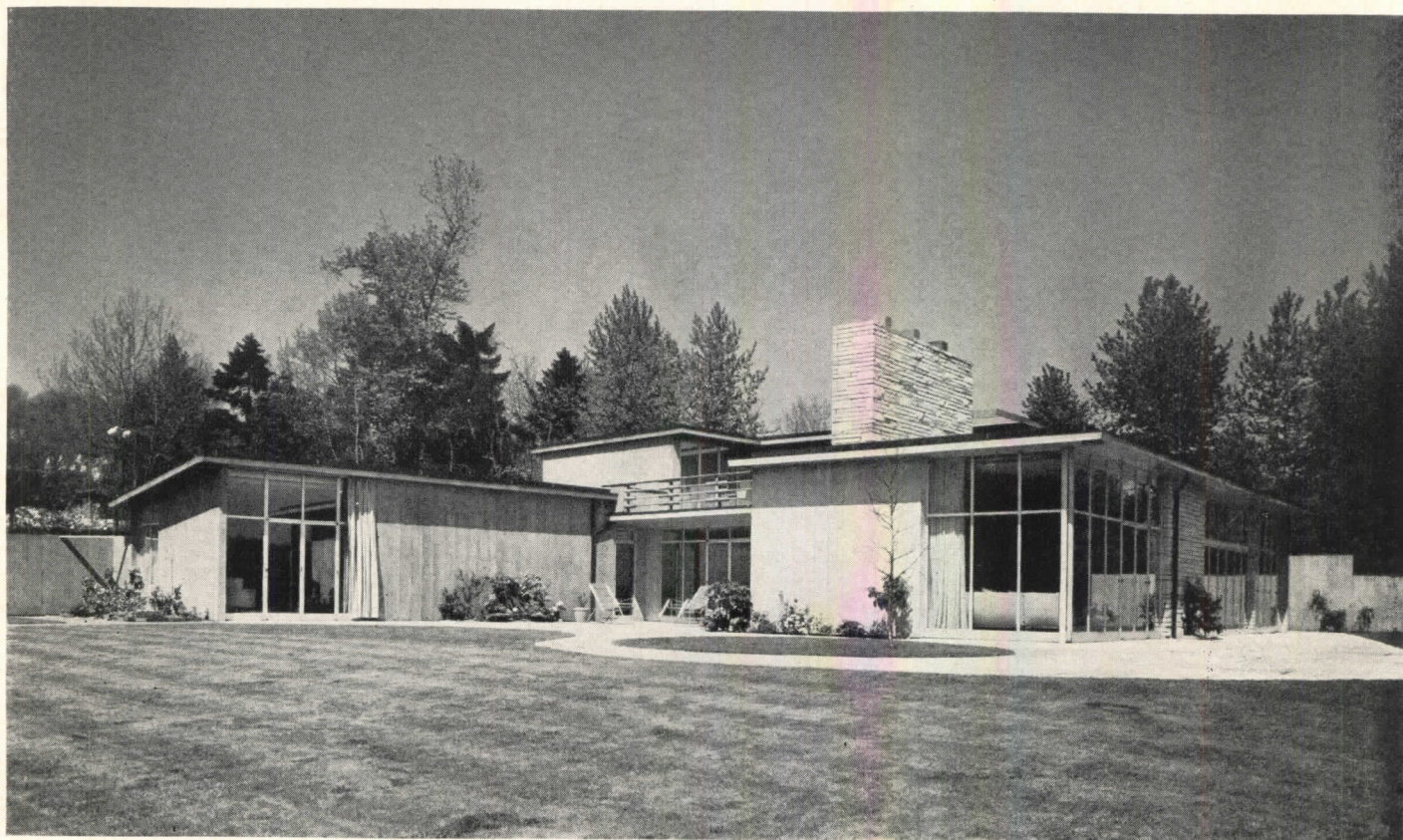

Dearborn-Massar Photos

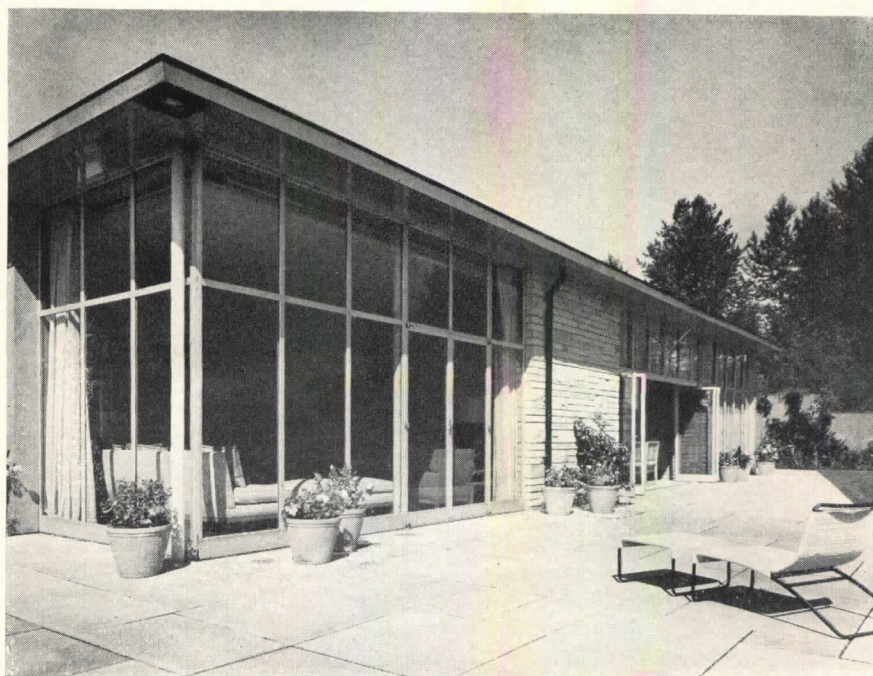

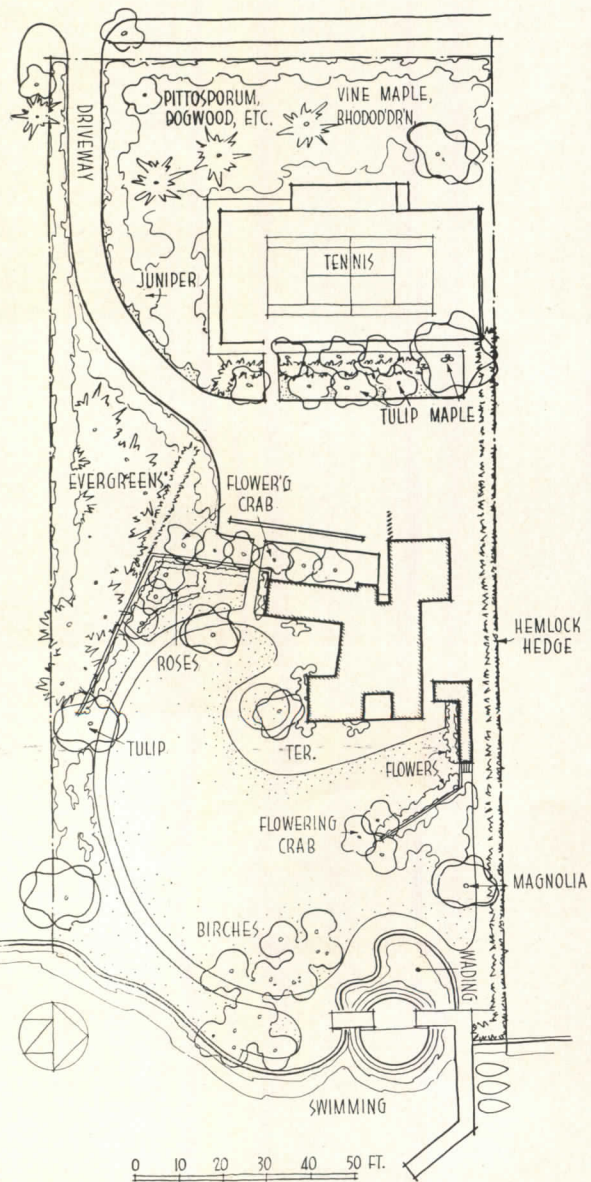

Although this house on the shore of Lake Washington is not exceptionally large, it makes more than the usual provision for family activities. It is built around a play-room opening to a sheltered terrace, and has a lanai as well as a large living room. Tennis courts, swimming and wading pools and a dock are also provided



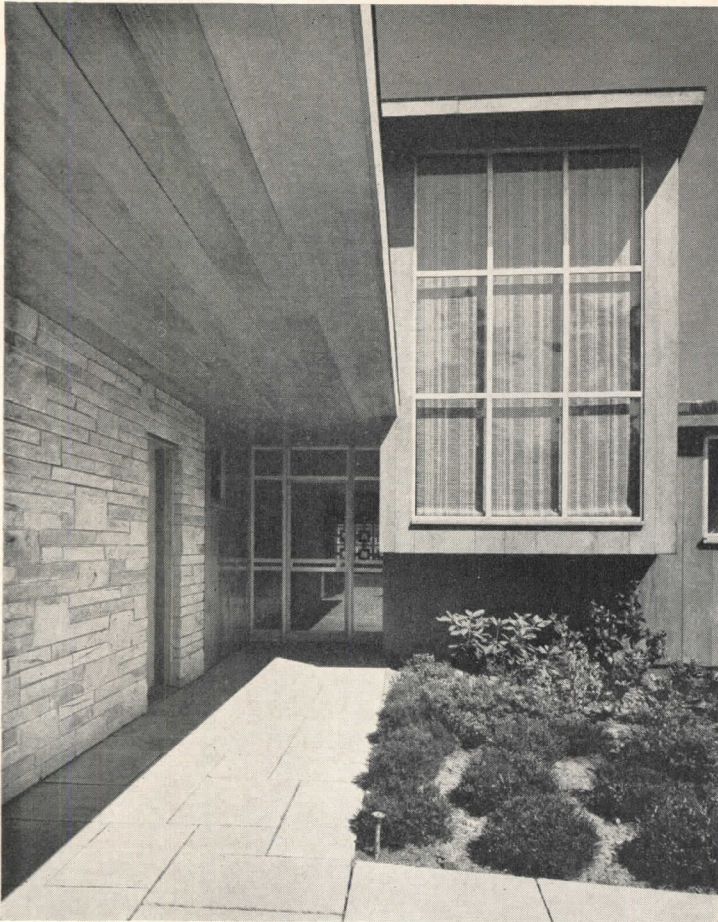

Left: looking east past garage wall to windowed stair landing. Below: playroom opens along almost entire south wall to a sheltered terrace. Exterior walls are vertical cedar plank siding and a native Washington sandstone

Dearborn-Massar

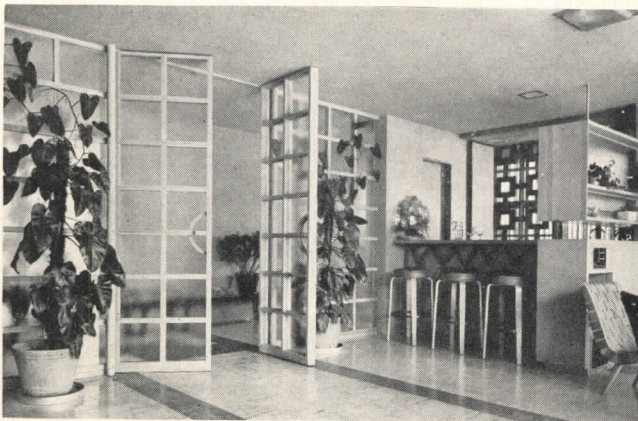

Left: the built-in bar is handy not only to playroom and living room, but also to lanai and dining room. Bar is natural birch, with stainless steel counter and sink and a small refrigerator. Opposite page: terrace, with playroom in background and living room at right

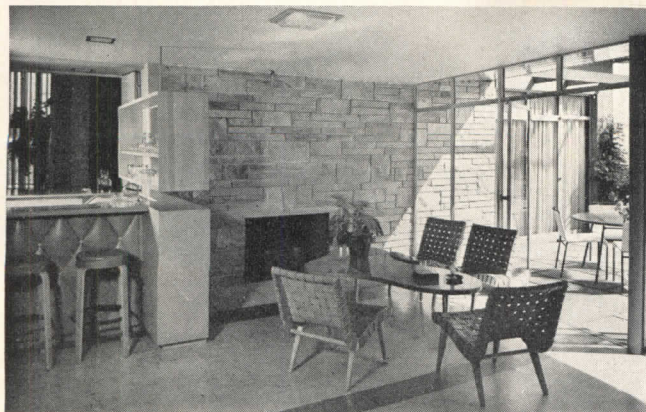

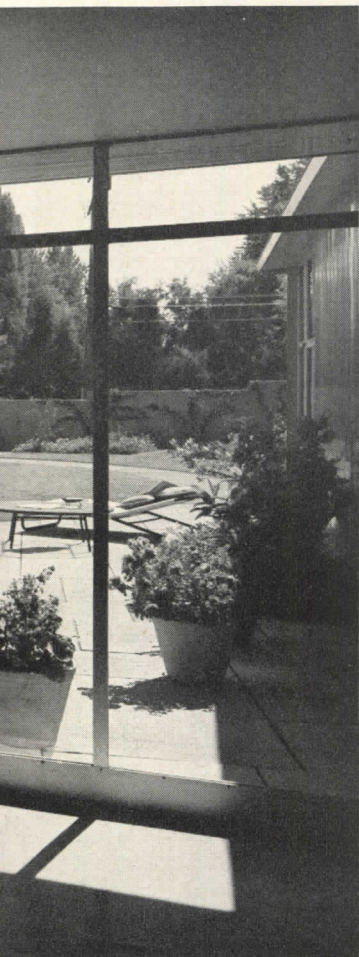
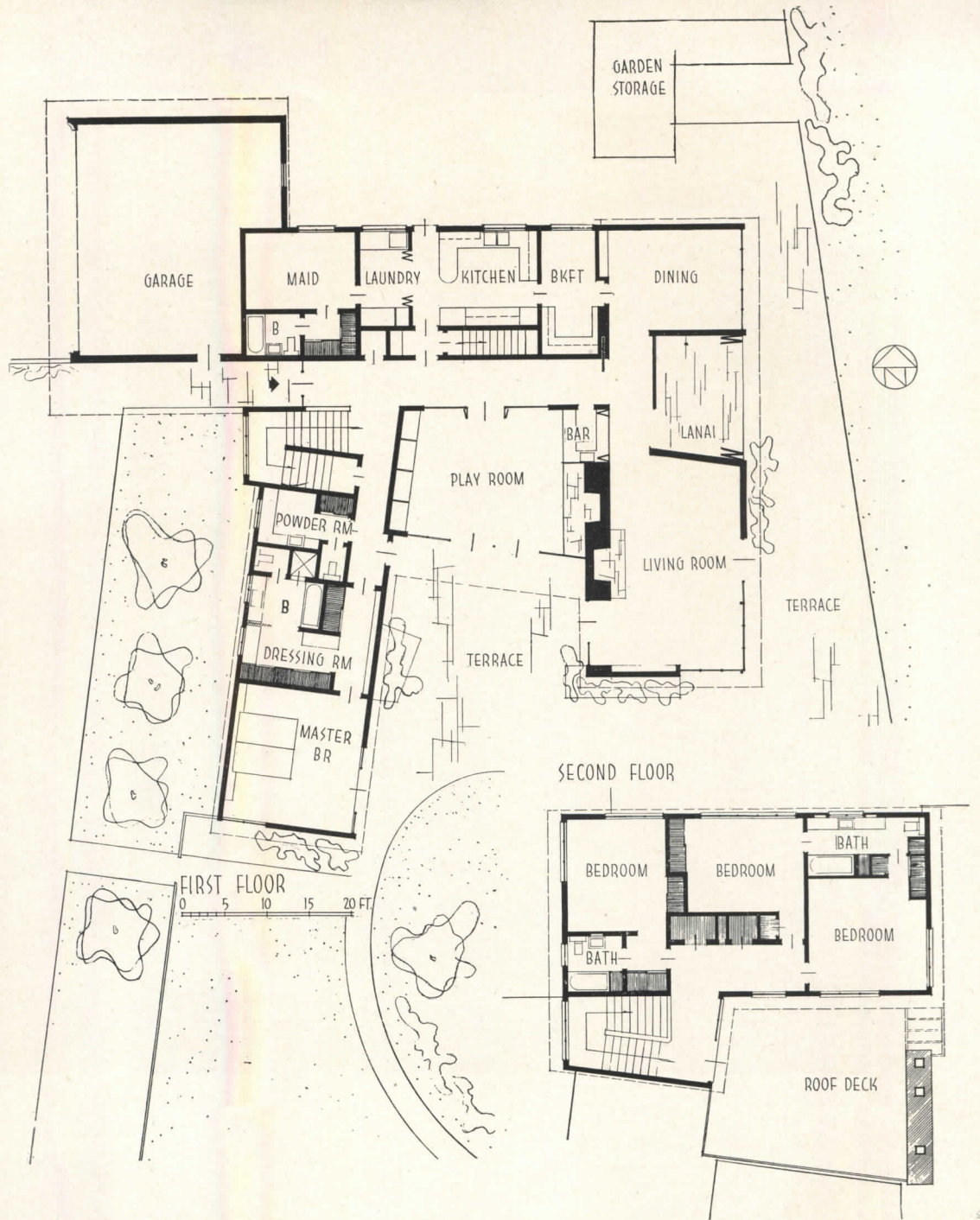

RUBINSTEIN HOUSE

Dearborn-Massar

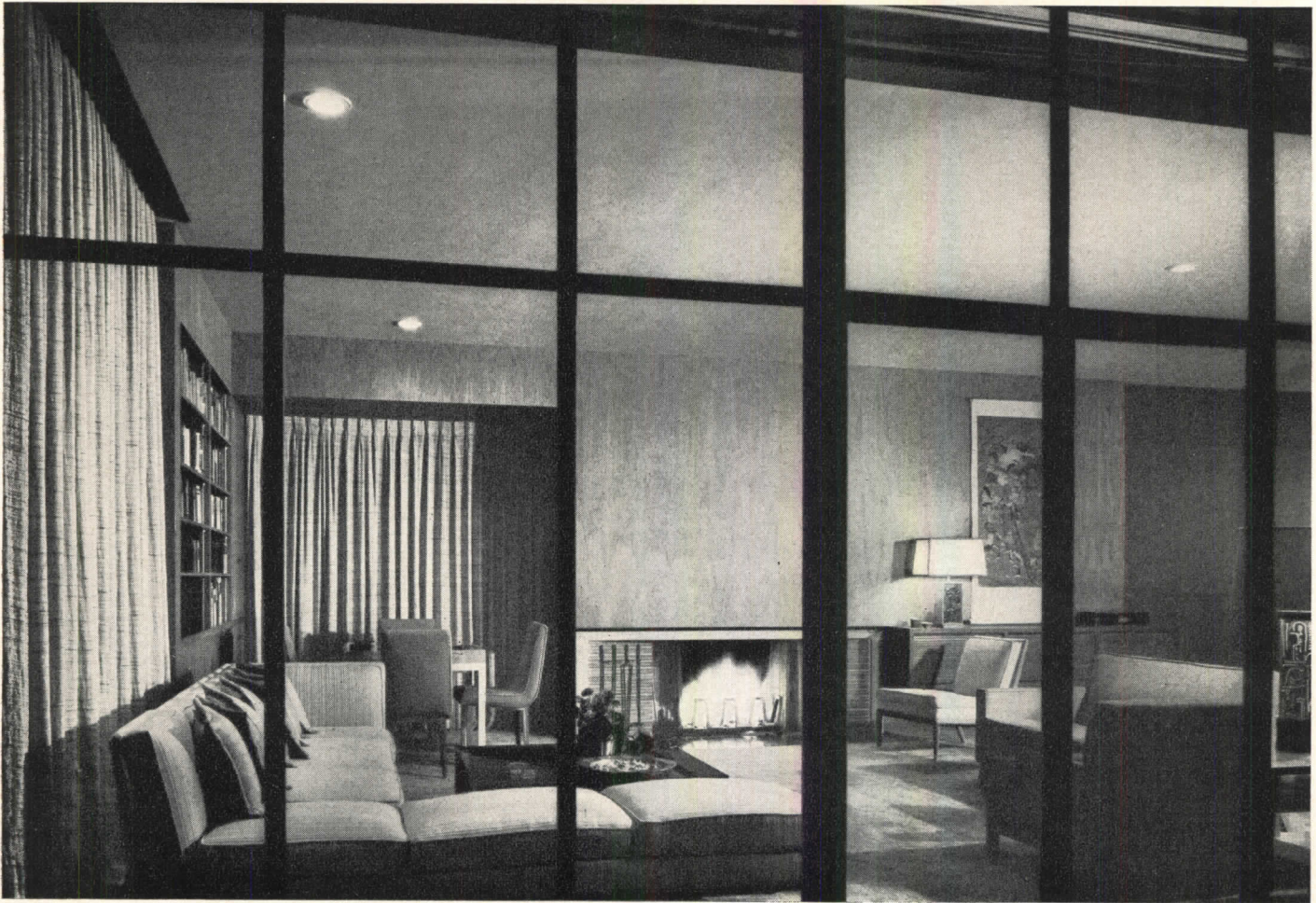

Above: fireplace wall and bookcase in living room are walnut in natural finish. Fireplace frame is local sandstone and salmon-colored natural brick; hearth is rust-mauve marble

Right: a corner of the dining room. Here one wall is of glass, one of sandstone. Dining room has a set of three tables — two square and one rectangular — which may be used separately or together; they were custom designed, like much of furniture in house, by the decorator

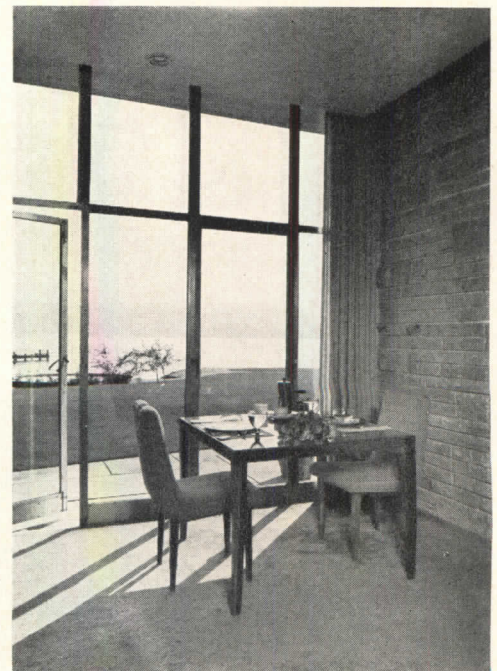

Left: a corner of living room. Immediately below: the powder room. Below left: the lanai. Bottom right: master bedroom

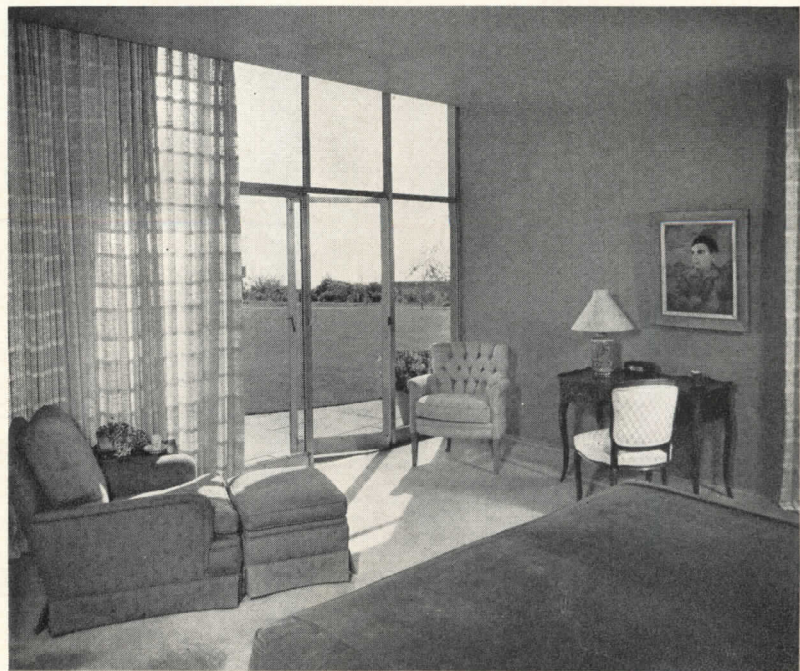
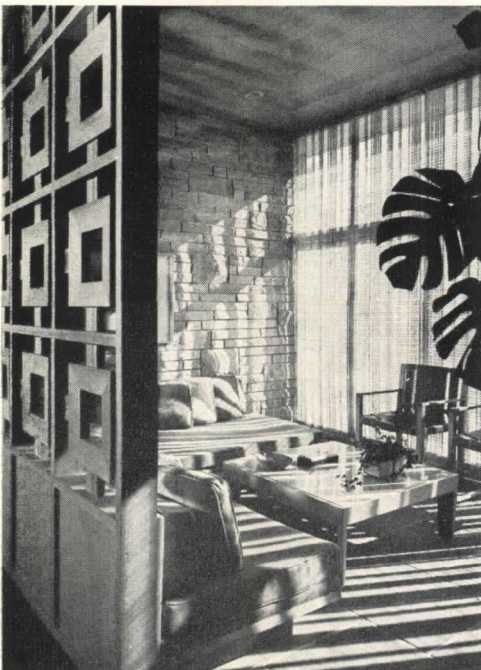
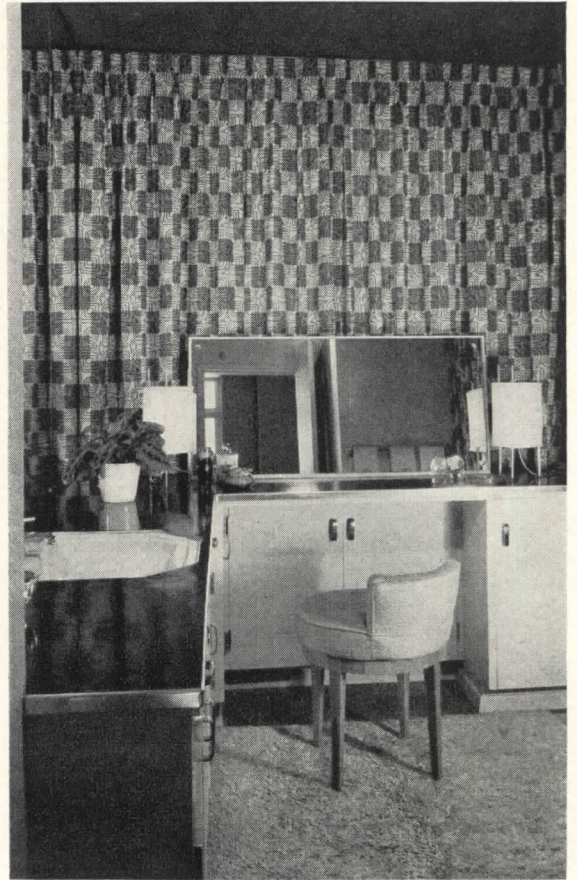



Lou Jacobs Jr. Photos

Above and below: to make most effective use of the very small area of Robert Liner's shop, the 35-ft ceiling had to be lowered. This was done—meeting city codes and keeping expenses to a minimum—by stretching clothesline cable from wall to wall and hanging sheets of corrugated aluminum. Corrugated aluminum was used also on curved rear wall



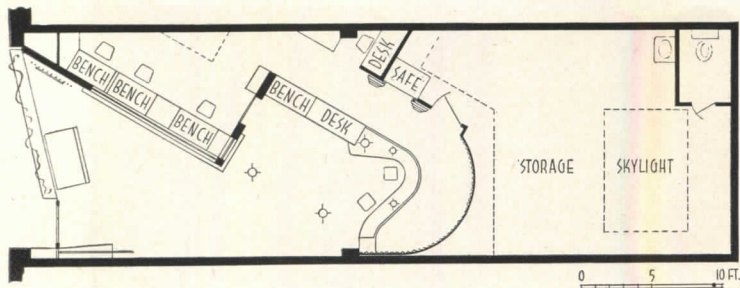

ROBERT LINER

← WATCHMAKER SHOP

Beverly Hills, Calif.

Mark & Joyce Sink, Designers

ATTENTION in this long and narrow watchmaker shop is focused on the four watchmakers, their instruments and their activities. The sales area, normally close to the entrance, is behind and to one side of the work-room, but clearly visible from the door. Small though the total floor space is (16 by 50 ft), a sizable area in the rear was salvaged for storage.



Lionel Freedman Photos

Exterior is vertical mahogany siding and stone, with bronze trim. Display case is small, but has proved adequate

H. J. BURKHARDT → OPTOMETRIST SHOP

New York City

S. J. Glaberson, Architect

WITH A FRONTAGE of only 9 ft, this small shop was designed to be as open and attractive as possible, and have the character of a professional office. Space was so limited that all rooms had to be dimensioned carefully for the equipment each was to contain. The examination room, for instance, had to be long enough for use of the chart, but in such tight quarters had to be kept to the minimum.

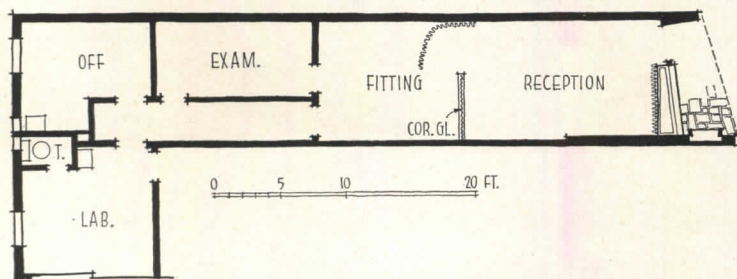

AUGUST 1951





Lionel Freedman

Deep open lobby permitted raising of ceiling inside building front despite low awning box. Front of mezzanine (opposite page, far right) is curved and used for indirect cove lighting and for air conditioning ducts and grills. Lighting is indirect fluorescent, with incandescent spots over displays



STORE FOR EDYTHE NELSON, INC.

New York City

Schiffer & Klein, Architects-Engineers

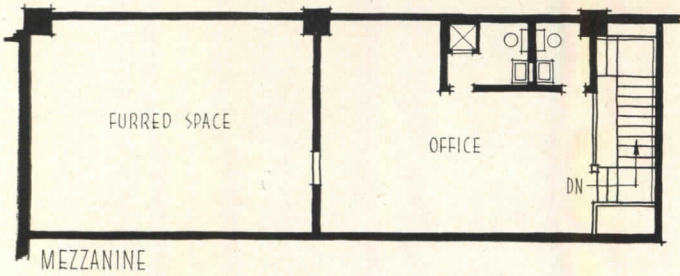

VISIBILITY FROM THE STREET and adequate window display space were major problems in the design of this small store on Broadway: the building has a staggered front, and the shop occupies an inner corner; a low awning box, which had to be kept, also cut down on visibility. The problem was solved with a deep open lobby across the entire width of the store.

The costume jewelry display at the left of the lobby faces the main flow of traffic and constitutes the main feature of the front, extending into the store itself. Display space for handbags, blouses, etc., is provided in recessed wall cases and counters. A stairway at the rear of the store leads to the mezzanine, where the office, stockroom and washrooms are located. Under the stairs is a small dressing room.

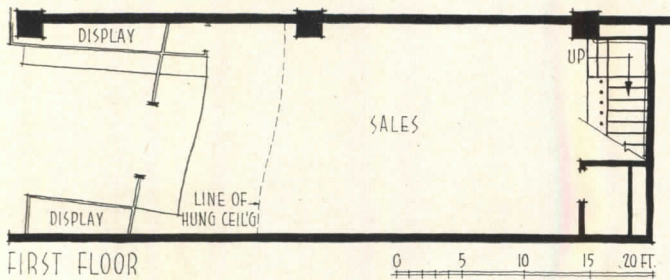



do the monumental designs of the past . . .

Traditional religious buildings emphasized soaring heights, as in Amiens Cathedral (right), vast size and gigantic scale, as St. Peter's (above), richness, and drama of light from many windows, as in Church of the Fourteen Saints, in South Germany (below)

Space, Time and Architecture, by Sigfried Giedion
Harvard University Press

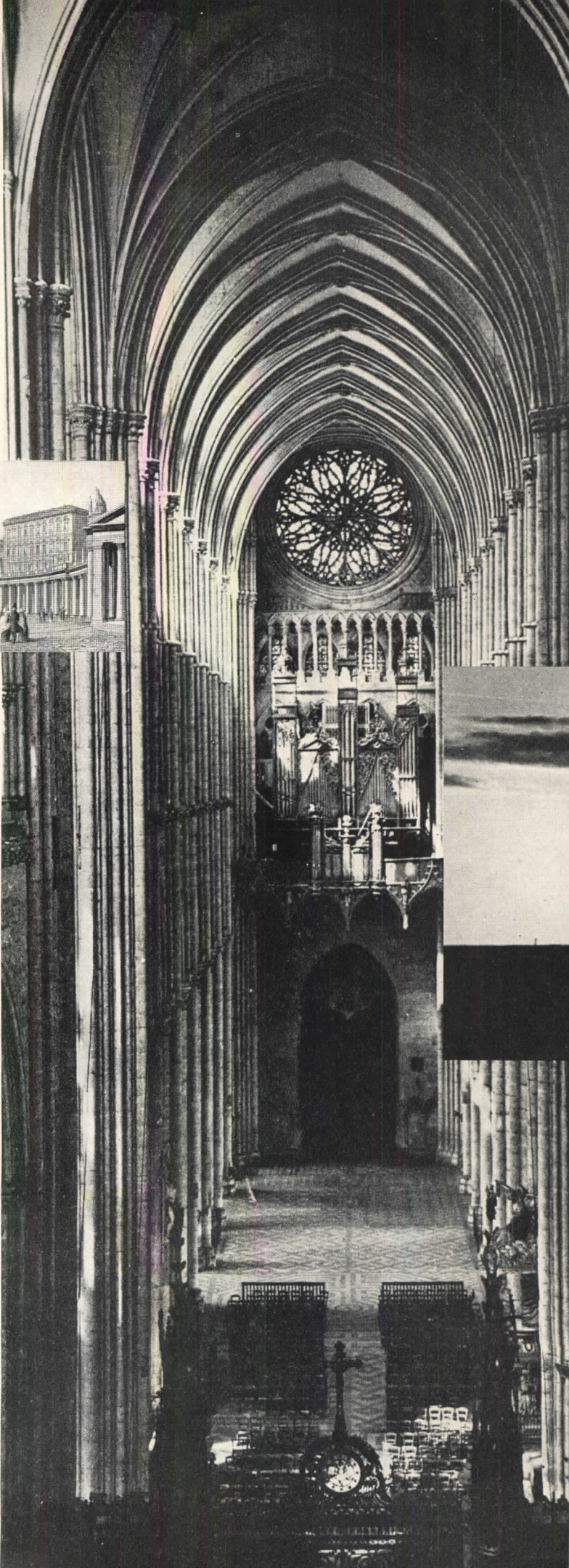

RELIGIOUS BUILDINGS

ARCHITECTURAL RECORD'S BUILDING TYPES STUDY NUMBER 177

WHAT PRODUCES a religious atmosphere in a building? What identifies it as a place of worship? Every epoch has argued these questions. Historical tradition leaves us the impression that the myriads of answers resolved in the past were successful for their eras. However, do these traditional solutions produce a genuine religious emotion today?

The critic of modern churches and other religious buildings claims they lack feeling and inspiration. These qualities are indeed vital parts of religious services. Perhaps, for that critic, who may be lacking in esthetic sophistication, they *do* lack feeling. Yet our society is made up of people whose degrees of cultural development vary; and the religious building has to serve all equally. Generally, credit is given to the functional, structural and economic values of the new designs, but

Photo Courtesy British Information Services

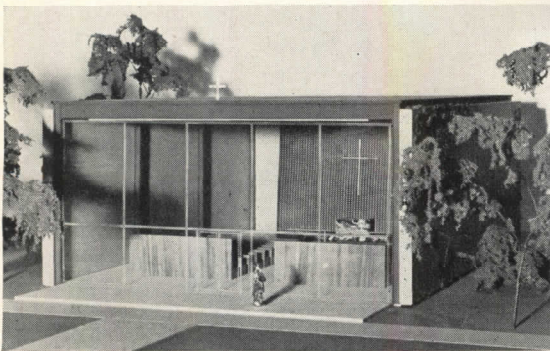

... produce a religious emotion today?

Modern skyscrapers supersede religious buildings as tallest, richest structures (right: Rockefeller Center, St. Patrick's Cathedral), by contrast help reveal inherent religious qualities in primitive Stonehenge (top), lead to experiments with simplicity and glass as chapel (above) designed for Illinois Tech by Mies Van der Rohe

Space, Time and Architecture

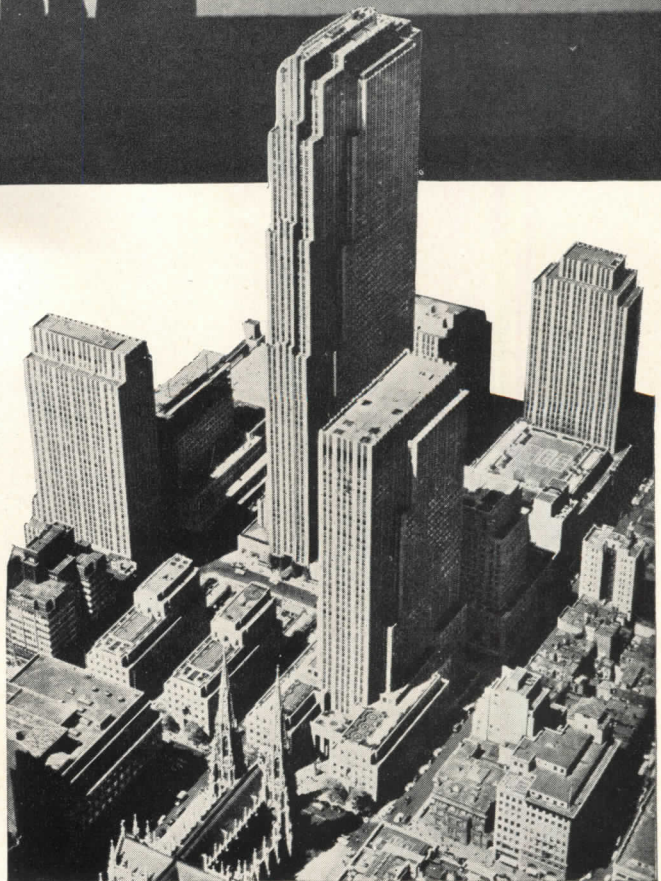

emphasis on these factors alone is regarded as fostering the creation of a secular structure with a few applied religious symbols to identify its purpose; the emotional reaction of the individual is overlooked. Consequently, designers lacking in original inspiration often turn to traditional forms.

Earlier agrarian societies — close to natural elements and the soil — found their answers through contrasting the simplicity of their daily lives with grandeur, richness, monumentality. Through change it gave them inspiration. Religious buildings were designed as refuges against physical attack, and generally speaking, the clergy controlled a good share of the world's riches. All the wealth and technical skill the civilizations could afford were spent on religious structures. Symbol was subordinated by the designer to the general sensation of great heights, huge enclosed areas and scale, which reflected psychological needs and desires of the times.

acknowledged interest in human relations. The programs of many churches are changing to satisfy these needs by expanding social programs and recreational facilities. City life in its growing separation from nature has also, perhaps through sheer contrast, fostered tremendous interest in the natural countryside. Thanks to the automobile, thousands can now escape the city's hubbub for after-work hours, or at least for weekends and holidays. One interpretation of this phenomenon might be that people are seeking mental refuge against disagreeable elements of their environment, much as their forebears sought physical refuge. Perhaps these are reasons why so many find religious emotion expressed to a great degree by such simple outdoor chapels as the Cathedral in the Pines — a simple altar and pulpit located in a mountaintop pine grove near Rindge, New Hampshire — or receive renewed inspiration from visiting such sites as Stonehenge.

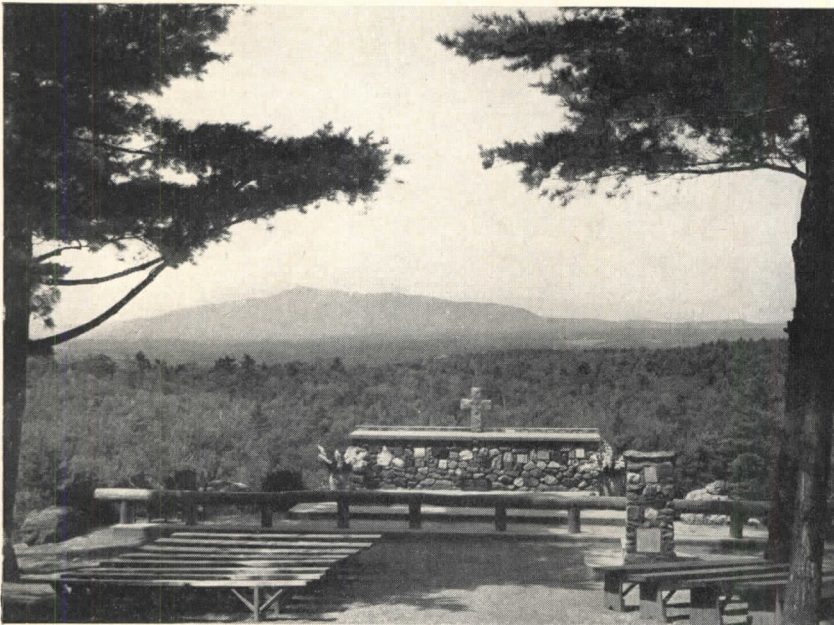

Photo Courtesy New England Homestead

Religious inspiration is found by many of today's city-dwellers within the grove of a simple outdoor chapel, such as the Cathedral in the Pines, near Rindge, New Hampshire (left). Nature, light and space produce a serene atmosphere for worship

Today civilization is more complex. The church is surrounded on all sides by commercial and industrial buildings of skyscraper proportions. Economic factors alone prohibit religious buildings from even trying to compete with them. Few congregations could build to the size of an Empire State Building or a Chicago Merchandise Mart, or would want to; the religious context previously attributed to vast heights and structural bulk has in the large part disappeared. Many congregations are struggling, in fact, to finance a minimum structure. Simplicity is often a necessity, often a fundamental tenet of the particular sect or creed.

Crowded cities are changing the outlooks of their inhabitants; they create the need and desire to preserve one's identity; they bring about a renewed but hardly

The interplay of space, light and a sense of infinity was among the objectives of the earlier architects. Their experiments included use of plastic shapes to increase the sense of interior space, or to conceal the definition of the enclosing structure, as well as use of false perspectives and the interspacing of shadowy areas with brilliantly lit spaces. The Cathedral in the Pines achieves these qualities with no enclosing structure at all.

Perhaps the simple device of opening religious buildings out on the abundance of light and space in nature might help in creating an atmosphere of worship. Modern materials and techniques lend themselves to this type of expression; it is certainly compatible with western culture.

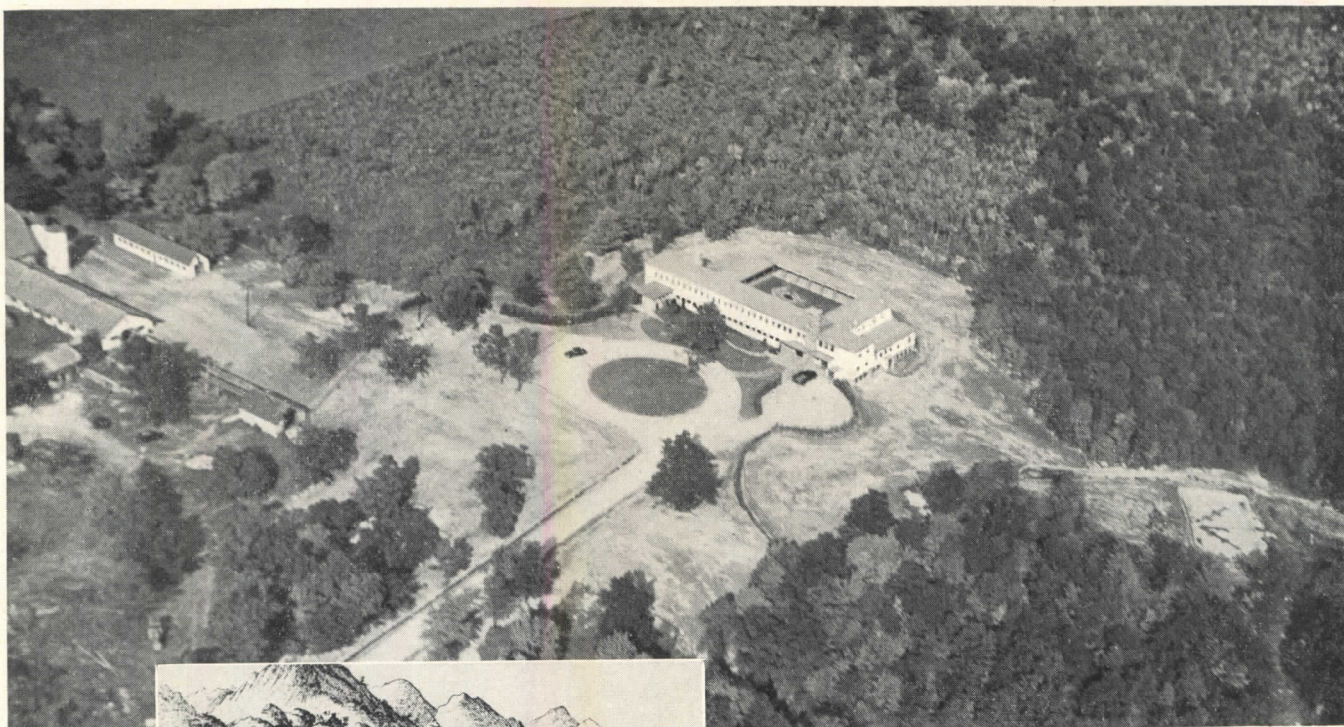

Lawrence E. Tilley Photos

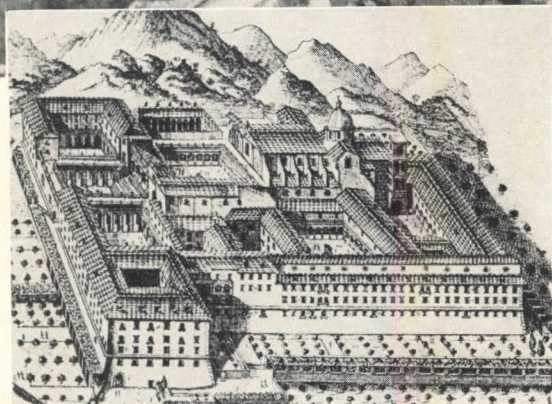

The Bettman Archive

In its simple, straightforward forms, Mount St. Mary resembles such monasteries as Monte Casino (left), but is more open, human-scaled, less fortress-like

THE CONVENT OF MOUNT ST. MARY

Wrentham, Massachusetts

Charles A. Maguire & Associates, Engineers

Milton E. Nelson, Architectural Associate

THE FIRST CISTERCIAN CONVENT to be built in the United States, Mount St. Mary adheres strictly to the order's dictums of simplicity and closeness to nature. Regarding the design, the planners state that "Since the cost of superficial, false, sentimental imitation of architectural styles very often results in a sorry imitation of the original, it was decided to use all materials in an honest, direct expression of their purpose in the building structure. Therefore, this building is not pseudo-Gothic, Romanesque, or an imitation of any other existing style or building." However, in its sheer forthrightness, the structure develops a virile character closely akin to many of the very early monasteries. The building is located on a large wooded tract with adjoining farm lands and buildings. The exterior of the convent conforms well to this site. Rough textured brick and stone are used without ornament except for the repetitive pattern of the brick piers, and the vertical

extension of the chimney and one pier to form supports for the cross and bells.

This comparison to the medieval buildings applies only to the manner of approach, for the plan, structure, interiors and equipment are as modern and efficient as the budget would allow. The exterior veneer of hard burned brick is backed with cinder masonry units. Precast concrete slabs, supported in precast T-beam sections, form the floor of the south wing, the second floor, and the roofs of the cloister and the two-story portion. Economical slab lengths were a deciding factor in the structural design. T-beams are located at each of the solid brick piers expressed on the exterior. The precast slabs are left exposed on the underside and form the finished ceilings. Copper radiant heating, using forced hot water, is installed on the first floor, baseboard convectors elsewhere. First and second floors are divided into two zones with thermostatic controls.

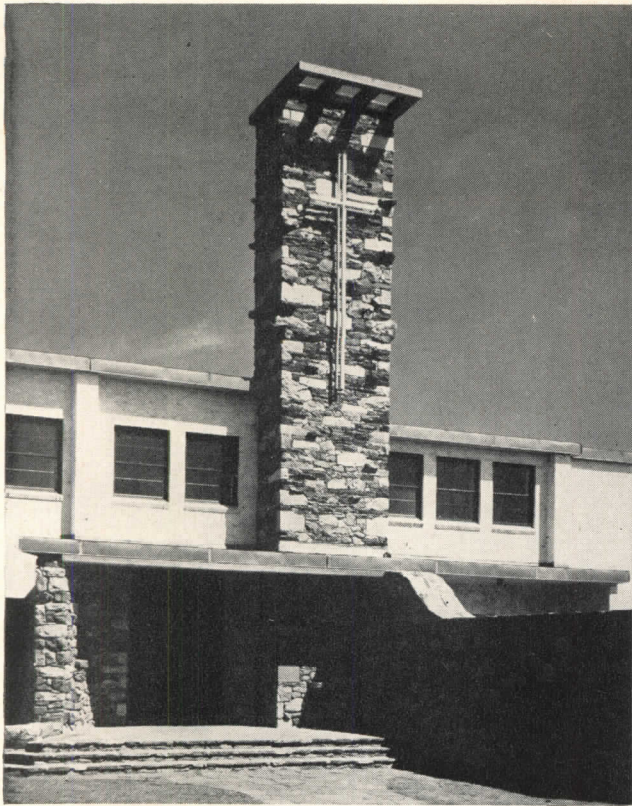

Lawrence E. Tilley Photos

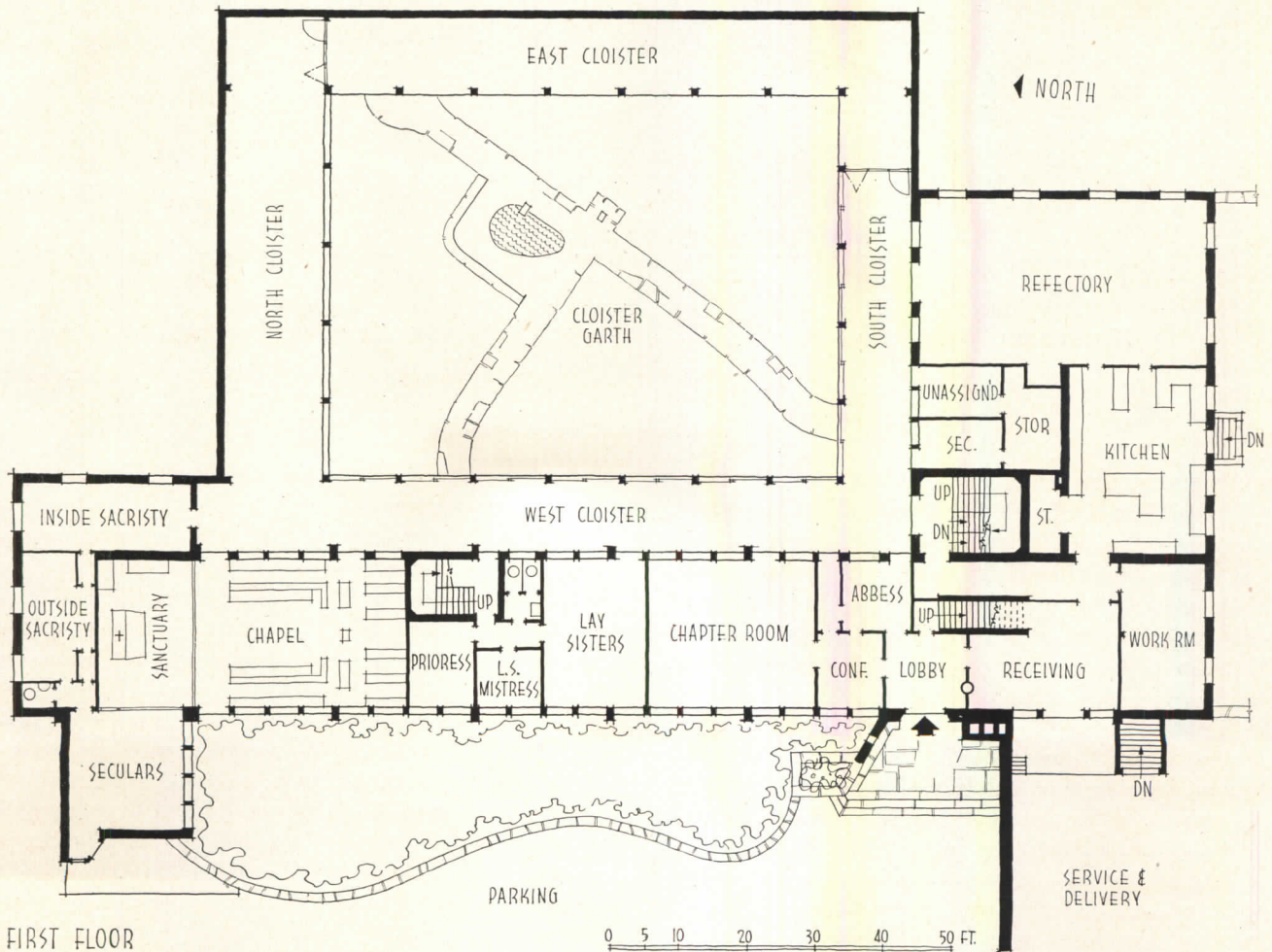

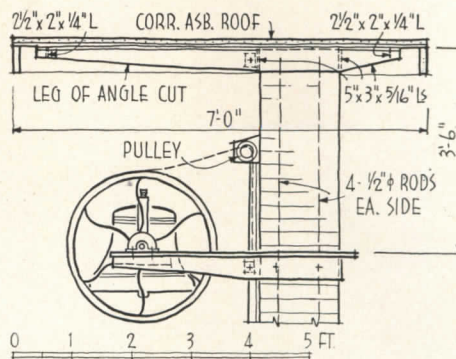

Utilitarian bells form the principal decorative feature of the cloister (detail above and below). They are openly mounted on the continuation of a brick pier, which is capped with a small canopy for emphasis. Pull cords run in metal tubing



The main entrance to the convent (upper left) is dominated by a large cross mounted on an extension of the stone chimney. The cross was made on the site, using standard copper tubing, and gold leafed. All major rooms open on the cloister (above), which also serves for circulation. The ultimate development of the convent will be a completely enclosed cloister, with a chapel on the north side, second dormitory unit on the east

Interiors are severely simple, offer no distraction from contemplation. The north or reading cloister (below) is enclosed with masonry wall and steel sash. Other cloisters have glass sliding doors. The refectory is shown at bottom, chapel at center right. Walls are plastered, finished with a sand float, unpainted

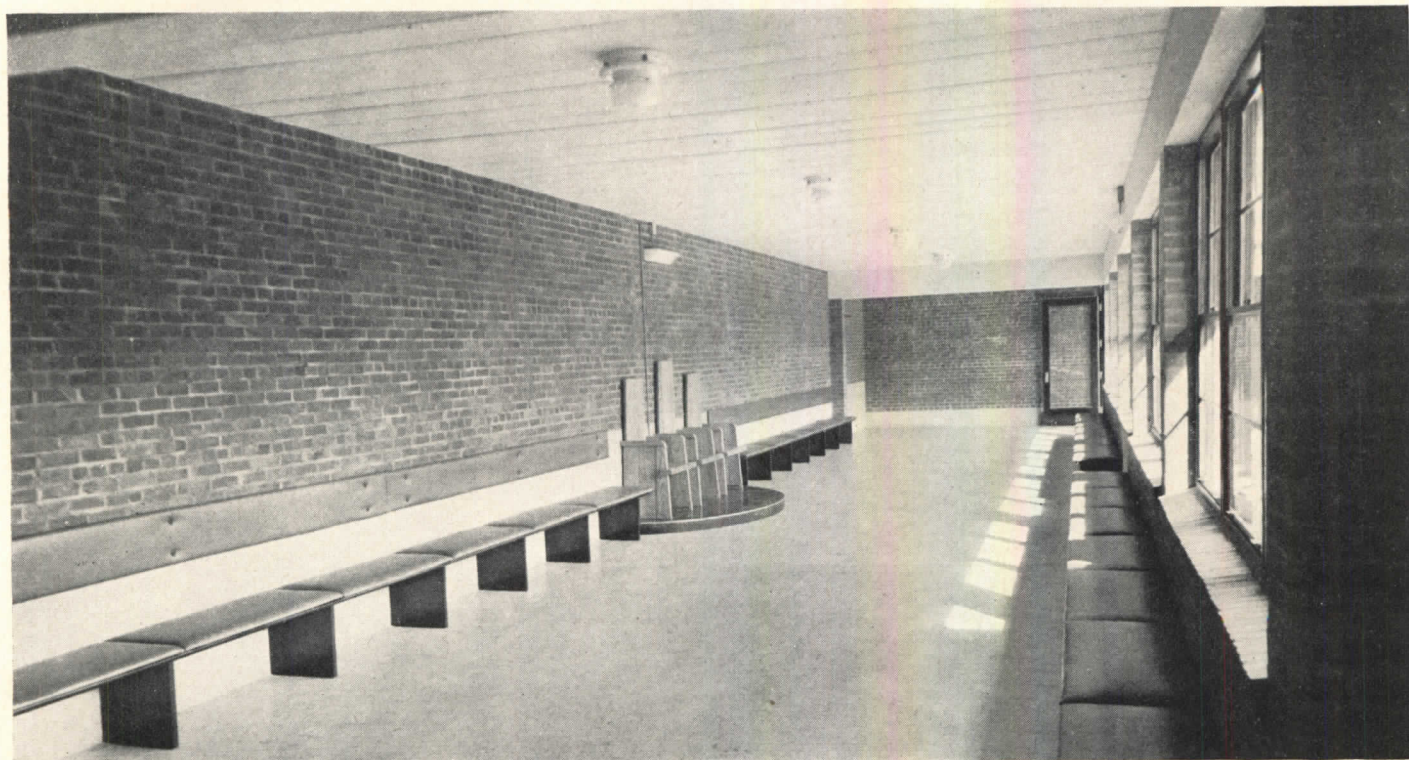

Lawrence E. Tilley Photos



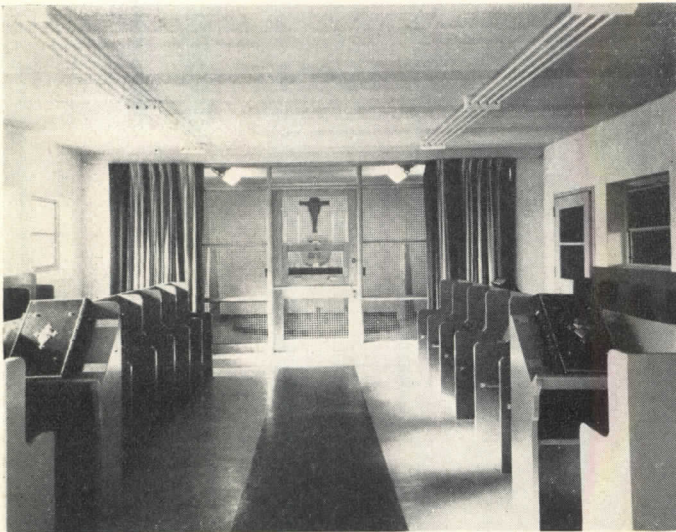
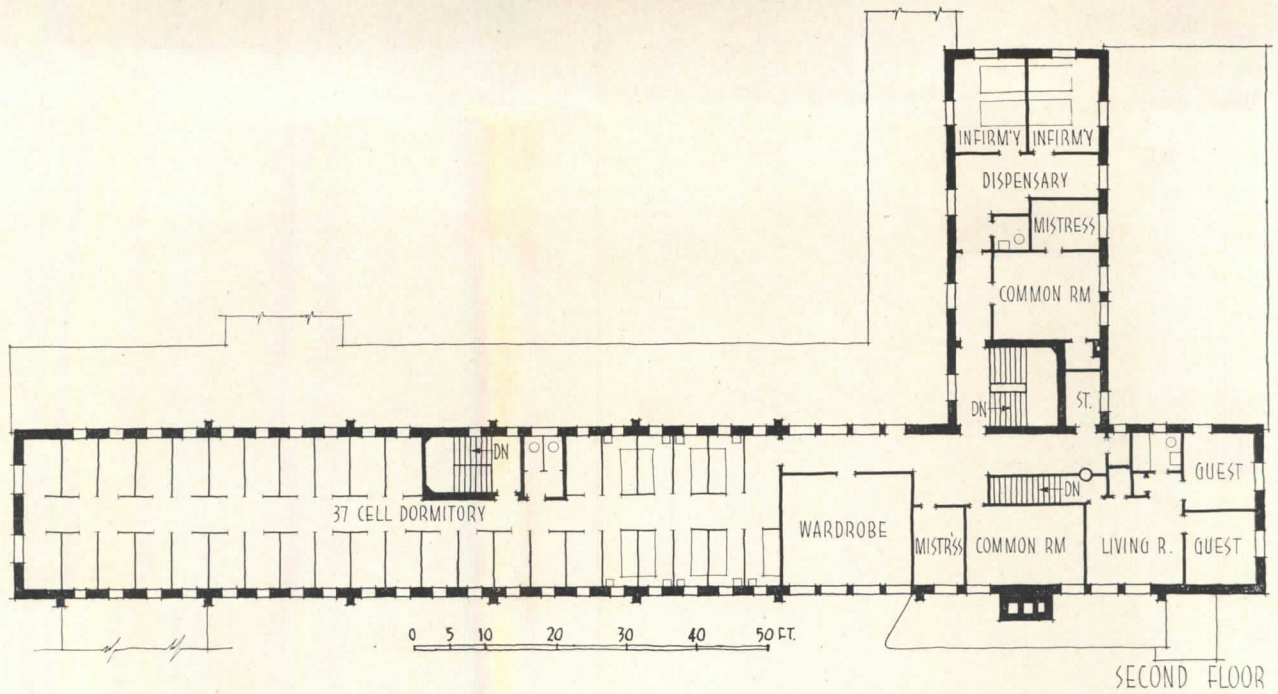

Living quarters are located on second floor (above) and in basement (below left). Dormitory cells (below) are separated by metal half-partitions, equipped with bed and wash basin. Floors throughout are asphalt, most lighting fluorescent with remote-control wiring

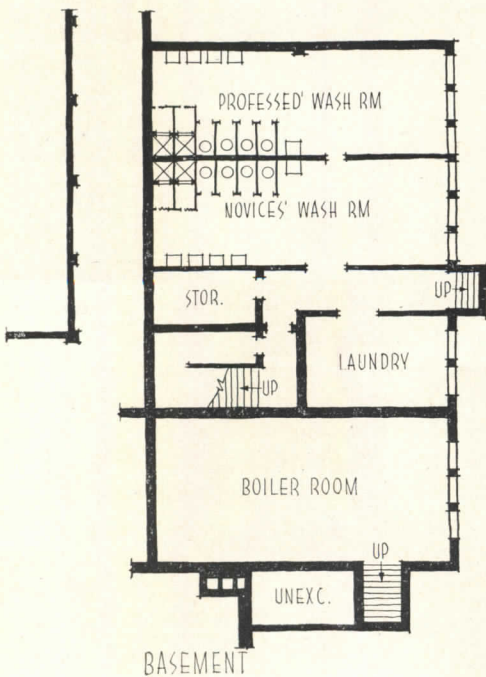

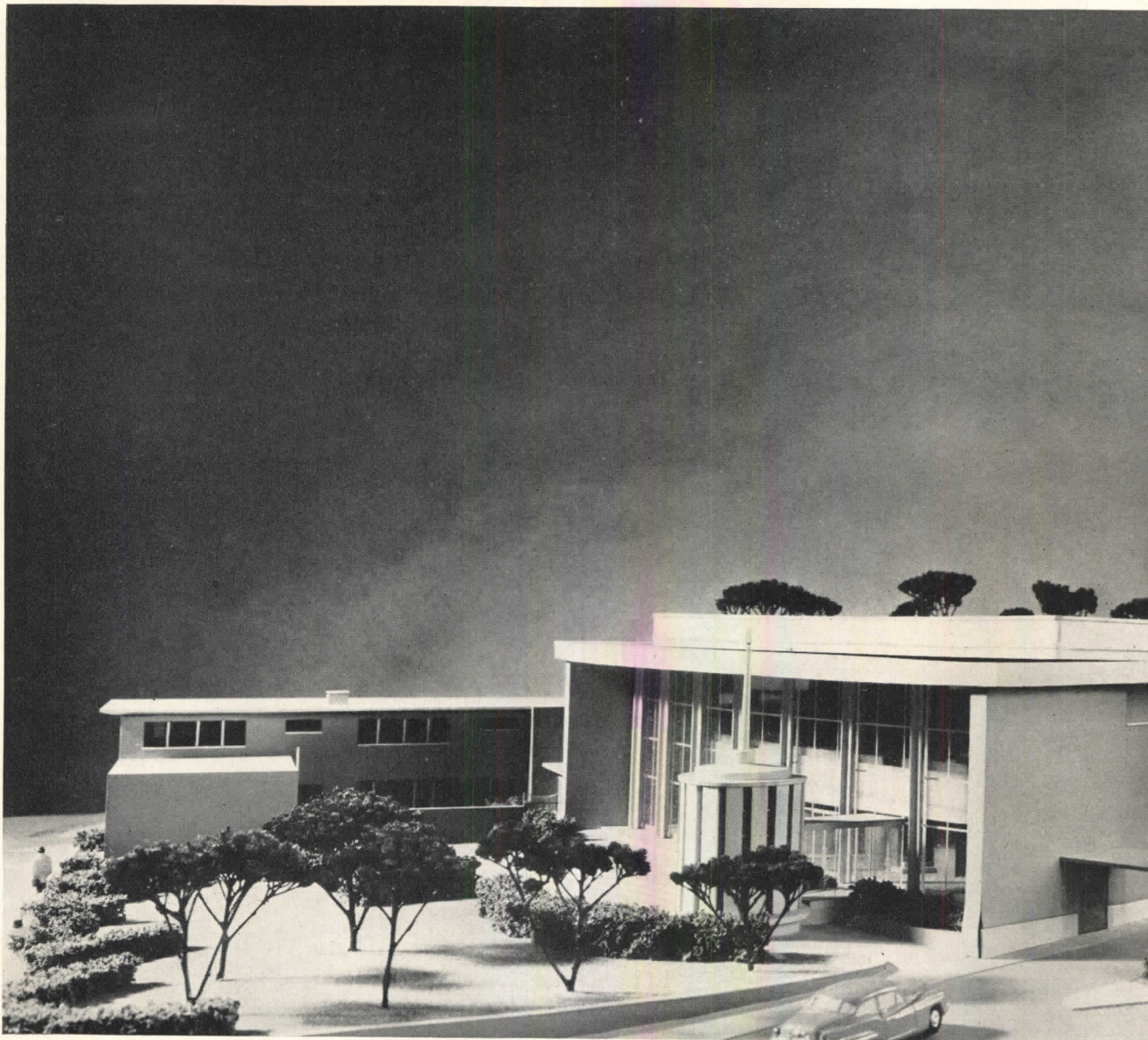

RESURRECTION CHURCH, ST. LOUIS, MO.

A QUIET SENSE OF DRAMA pervades the design of this projected Catholic church. Much of this stems from methods devised to carry out the basic program requirement of centering maximum attention on the altar. Plan shape and the interplay of light and spatial forms all serve this end.

The church layout is parabola shaped, with the altar near the focus. A niche, surfaced in mosaic, forms a background for the altar and extends up and through the main ceiling plane. Directly above this sanctuary, a clear dome admits light and permits a soaring view of sky and tower cross as one approaches the altar; it is purposely kept out of view of the seated congregation.

The nave, which seats 660, fans out from the altar to a wide glass front, designed to allow the east morning light to penetrate deeply into the church. A balcony seats an additional 140, and houses choir and organ. It is a free-standing form within the nave, with the ceiling of the church passing over it and out to the front wall of glass. Beneath are small lounges which are insulated acoustically and have double-pane view windows toward the altar.

On the exterior, the baptistery is given special prominence as an independent form, the symbol of joining the Church. A glass corridor connects it to the nave. Walls of the church are light red brick inside and out-

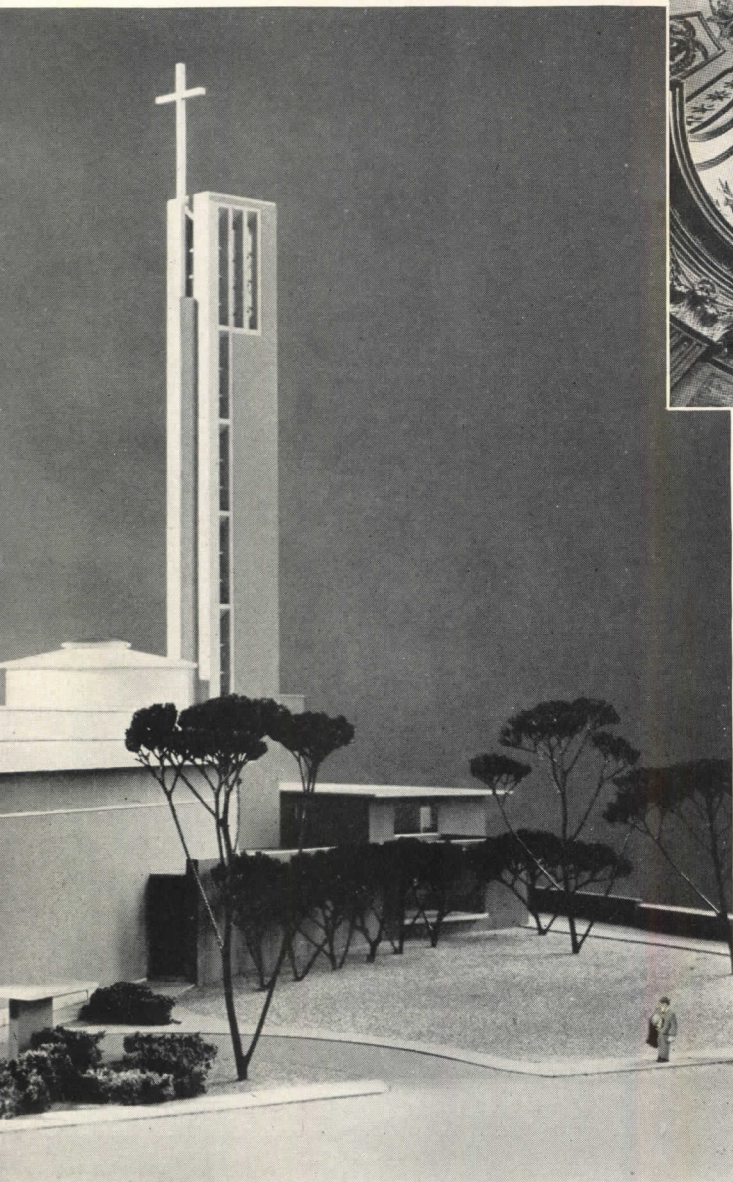

Space, Time and Architecture

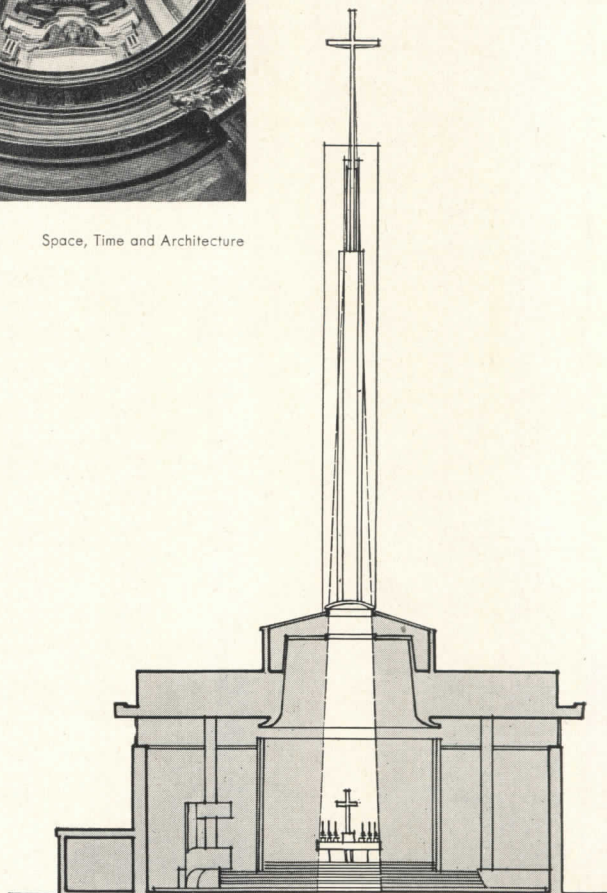

Joseph D. Murphy and Eugene J. Mackey

Associated Architects

The conception of an illuminated dome in this project contrasts sharply with previous examples, such as Borromini's Sant' Ivo, Rome (inset), where light emphasizes surface ornament of the dome itself. In Resurrection Church, light is focused on altar (right), clear glass gives dramatic view of exterior cross

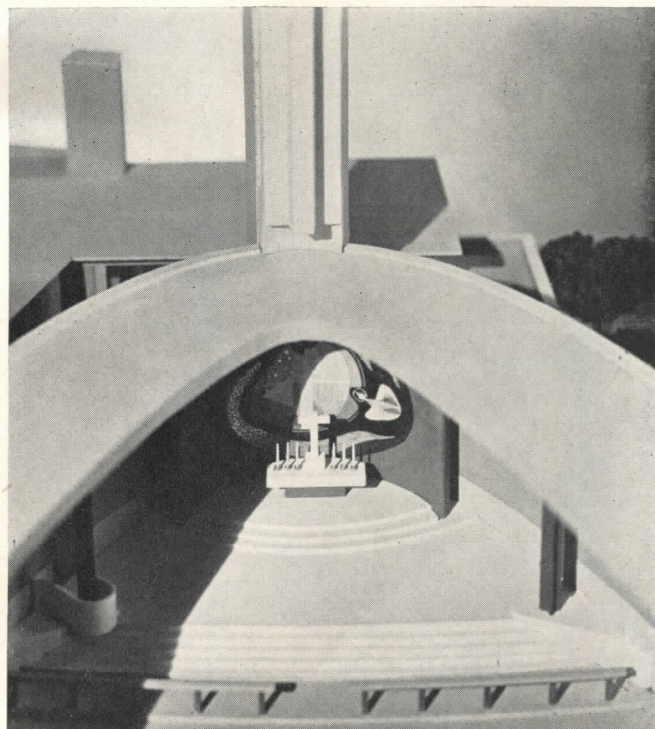

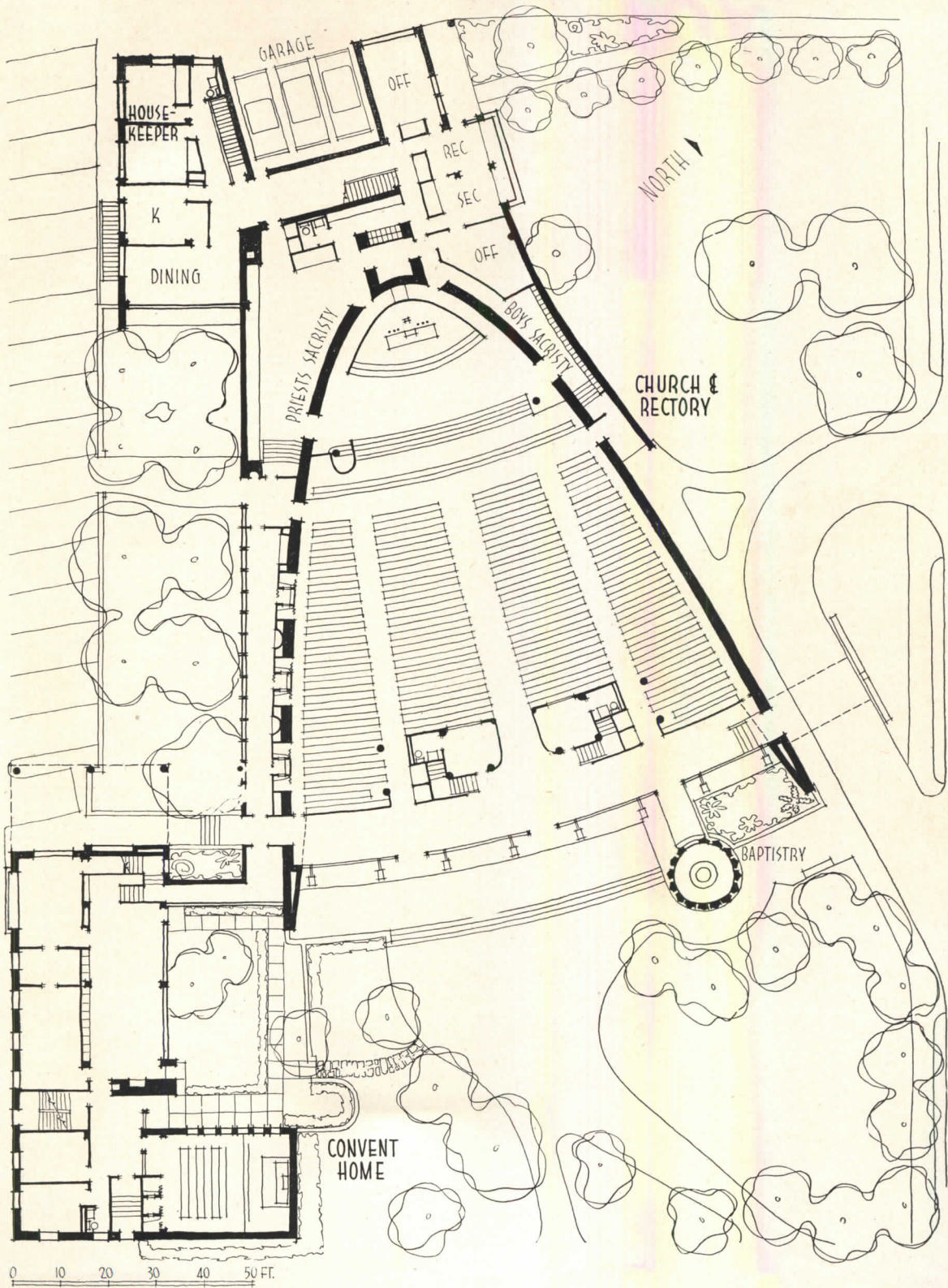

The open curves of the parabola-shaped plan afford an excellent unobstructed view of the altar from all pews. Functional elements of the compound are compactly arranged for maximum convenience

The wide glazed facade serves to integrate church and gardens, provides inviting view of interior. The church will be of light red brick. All interiors except the nave will be plastered. Concrete pan construction is planned for first floor, concrete over steel joists for upper floors. Ceilings are to be suspended metal lath and acoustic plaster

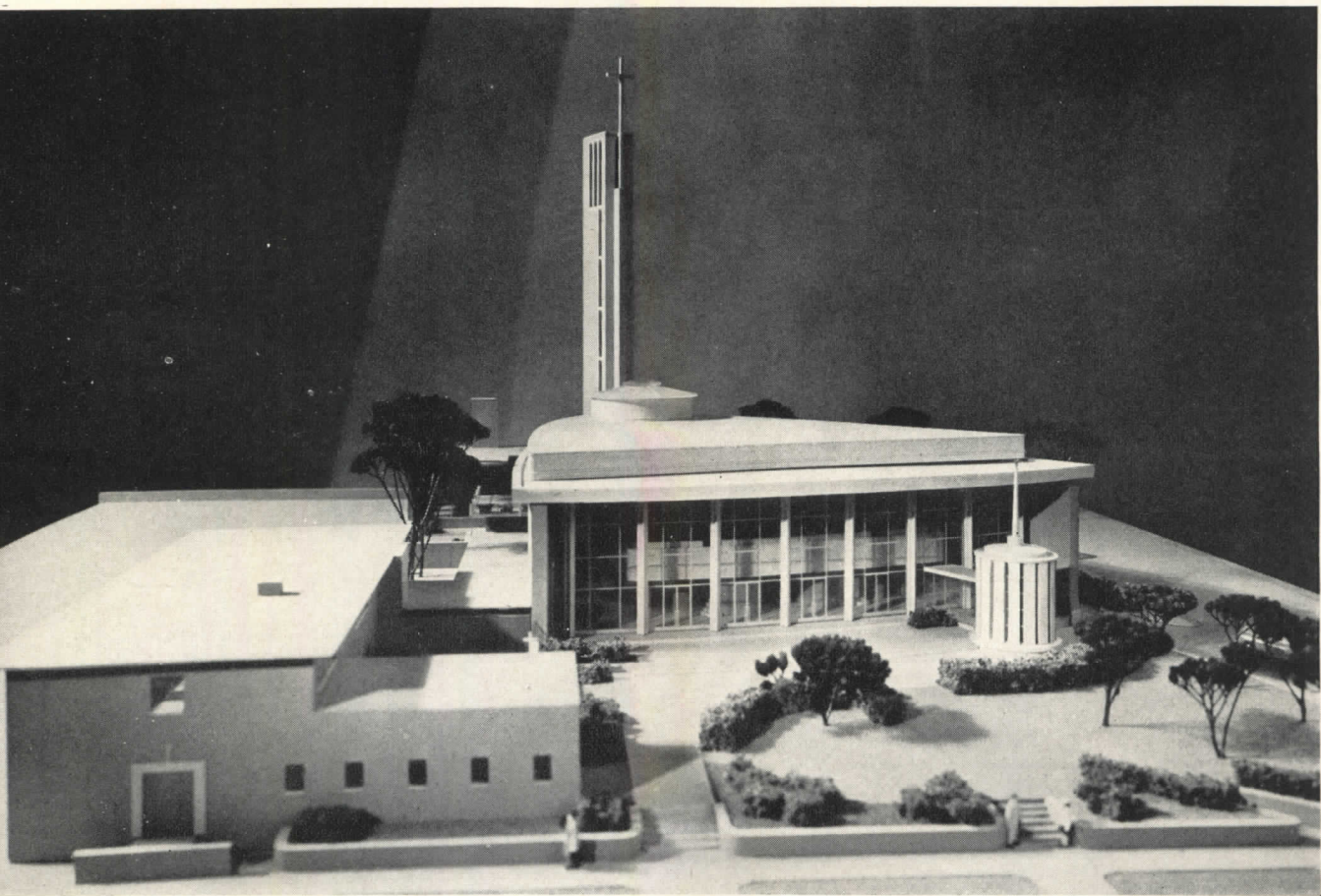

side to preserve continuity. The parabola-shaped plan has also been ingeniously used to give space for a park-like setting on the restricted site. The gardens form a helpful buffer against the busy intersection of city streets. Use of the automobile has been kept in mind during the planning, leading to the inclusion of a sheltered entrance for weddings and funerals in bad weather, a three-car garage, and a parking area to the south west.

This area may also be used for play, socials, etc., when required.

The church compound also includes a rectory and a convent home. These are simply designed to emphasize the form of the church and tower. Gardens and lawns are integrated with rooms wherever possible. An existing education building is across the street, and is built of materials similar to new church compound.



Gottscho-Schleisner Photos

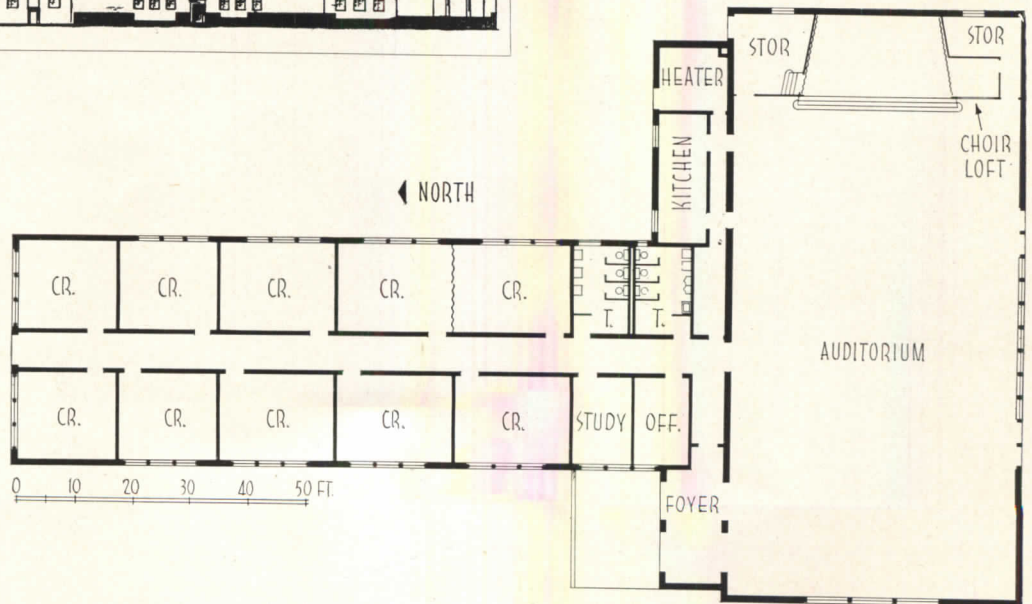
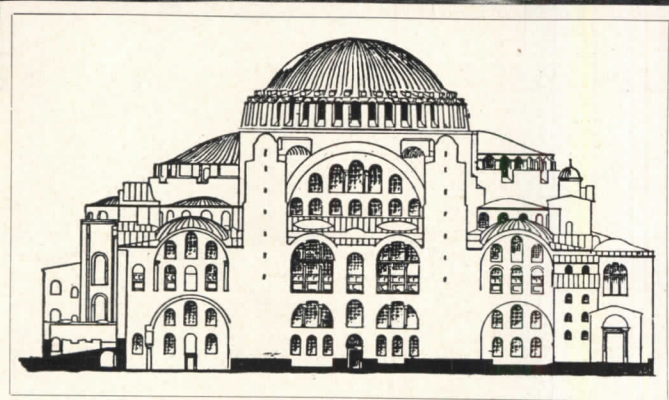

A sense of interior space and light is simply achieved in this small Roslyn temple, compared with the great enclosed areas, modeled after Santa Sophia (inset), of many of its near-recent predecessors. Large banks of windows extend its visual size through woodland

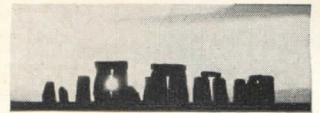

ROSLYN JEWISH COMMUNITY CENTER

Roslyn Heights, Long Island, New York

THIS SIMPLE, economical temple and community center is the product of close teamwork of an entire congregation. Faced with a limited budget, the members decided to erect a small, straightforward structure which would reflect the "ranch-type atmosphere" of developments adjoining the suburban tract.

The result is a fresh design reflecting its multi-use purpose. A near-domestic scale and restrained use of religious symbols permit easy conversion of the auditorium into a social hall. The stage, containing Ark and pulpit, can be curtained off for such functions. On the other hand, the sheer open simplicity of the interior is well suited to religious ceremonials. Its apparent interior size is extended greatly by large banks of windows, and by spotlights illuminating the ceiling above exposed wood trussed rafters. The Center also provides facilities for religious education, a week day Hebrew School, adult education classes and assembly for various

church and social groups. A second classroom wing, flanking the existing one, is planned for future expansion.

The building is set back from the highway in a grove of trees. Parking areas and recreational grounds are provided to the rear. The structure is brick over cinder block; floors are concrete slab. To preserve the horizontal quality of the design, brickwork was finished with flush vertical joints, raked horizontal joints. The exterior and basic structure of the building was adapted from the Village Green Center in Levittown, L. I., designed by Alfred Levitt. These plans were simplified, expanded by a classroom wing, and opened out with large glazed areas, by J. Sierks, under the supervision of the Roslyn Center Building Committee with I. Jalonack, I. Stein, M. Eagle and J. Ebstein. The site layout and all interiors were planned by John Ebstein, Architectural Designer.

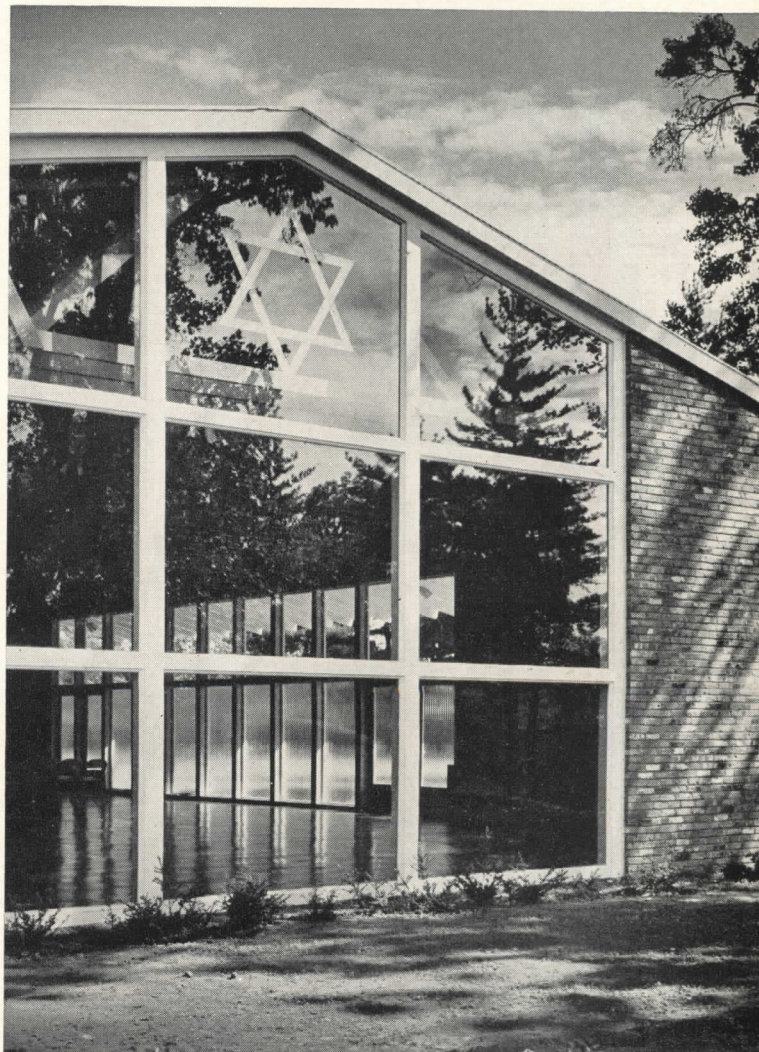
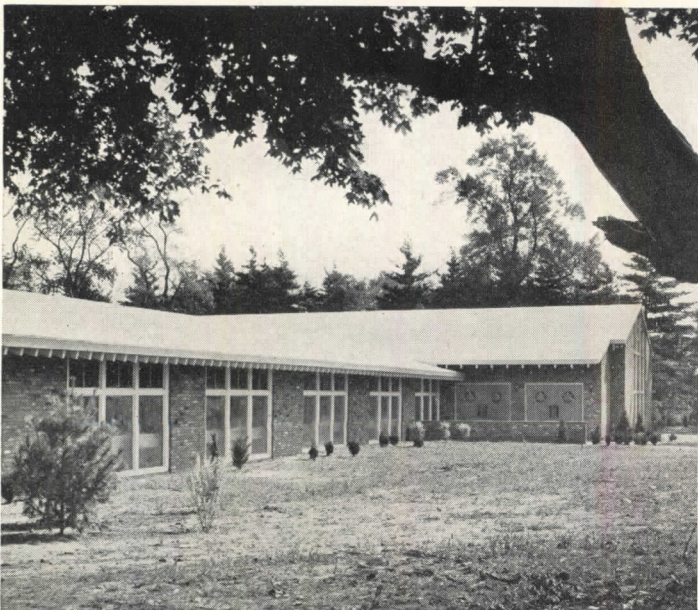

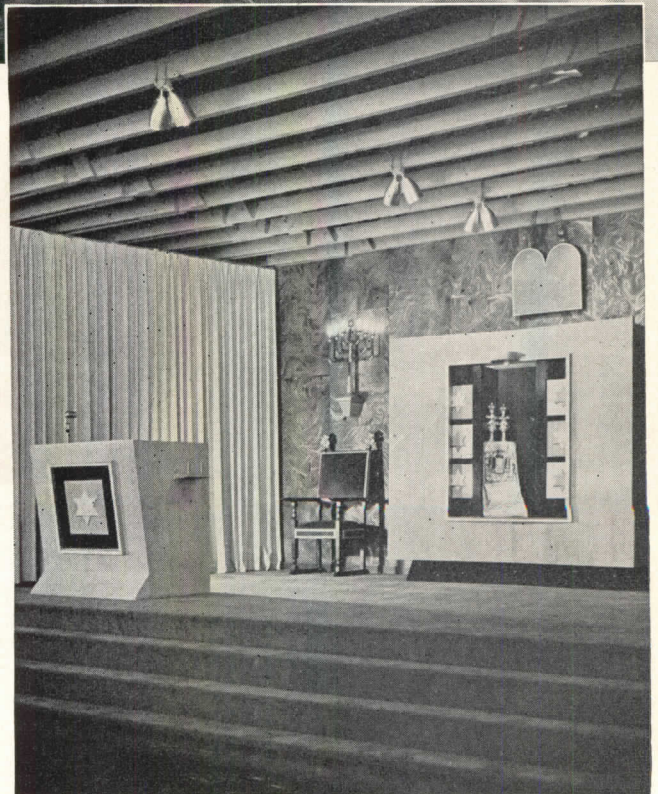
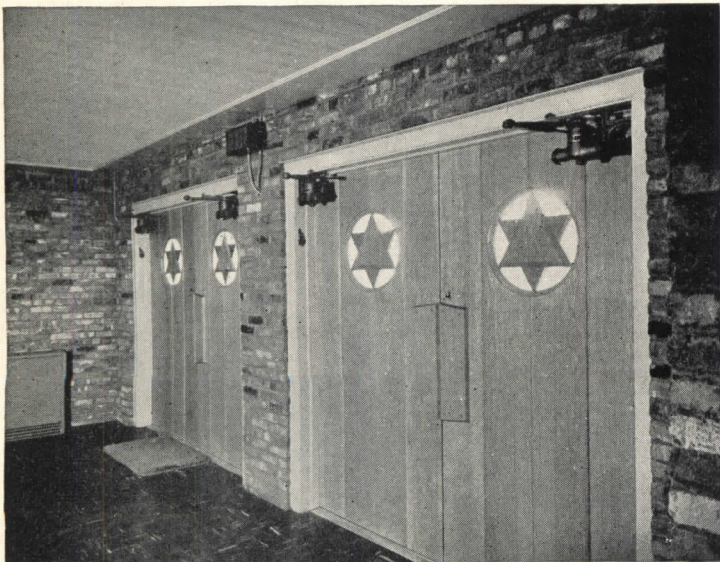
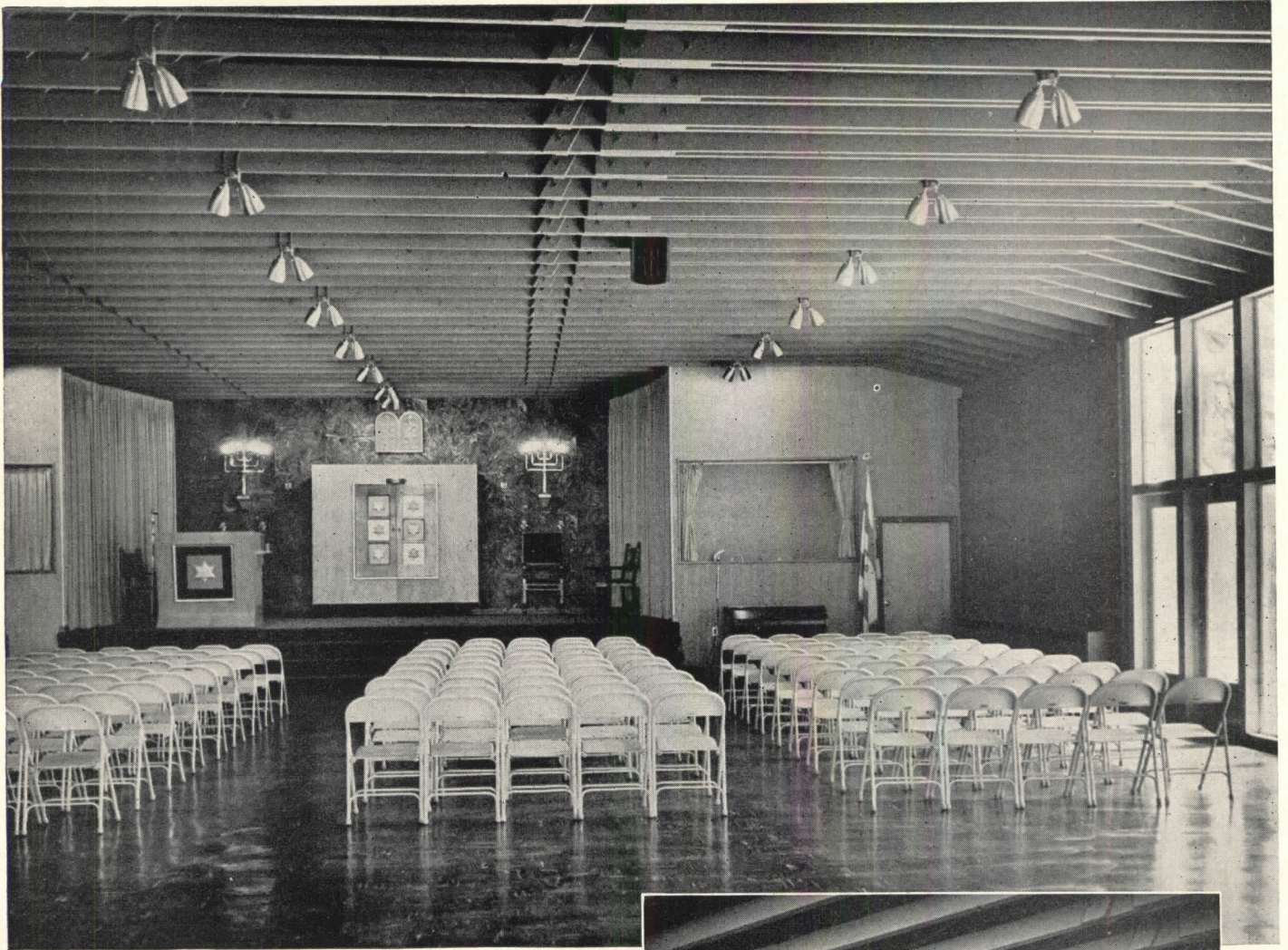

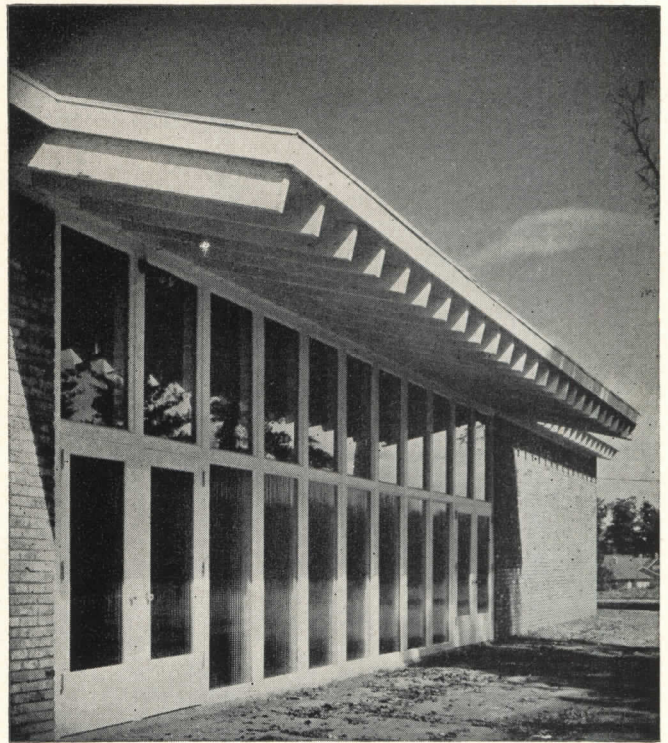
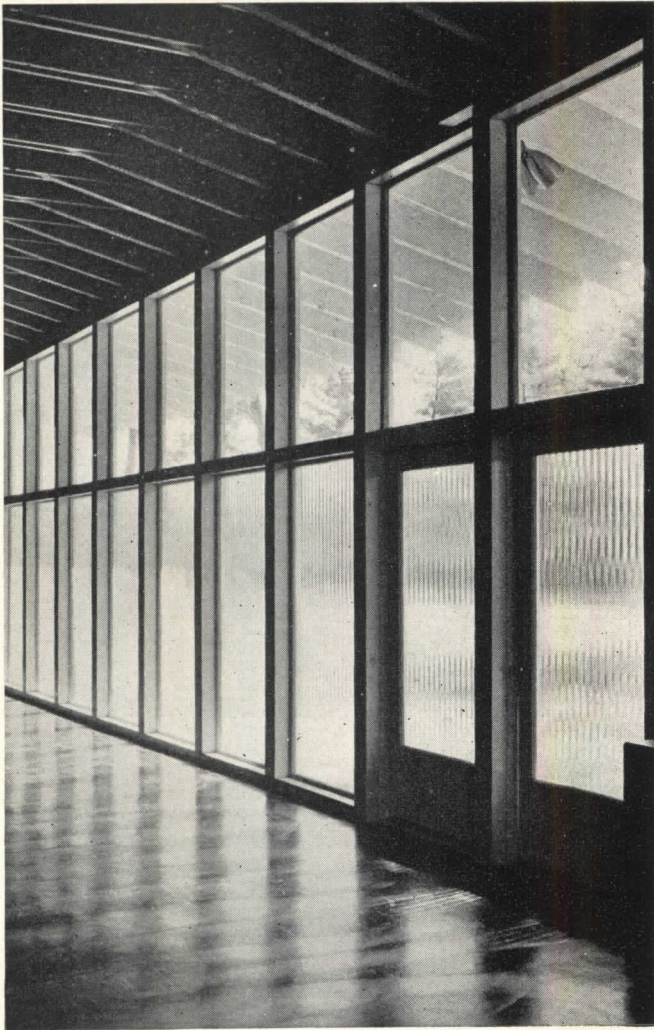

Lower window sections in the auditorium (left and above) are fitted with translucent glass to obscure view of simultaneous outside activities; clear glass upper sections give view of trees and sky. Exposed ceiling beams are painted a dark terra cotta, and extend to form sunshade over south windows. Roof is surfaced with white marble chips

Classroom walls and partitions are of cinder block, sprayed with enamel. All floors are asphalt tile. Classroom at right will be fitted with a folding partition to accommodate varying size groups. A future wing is planned for expansion; it will be at right angles to the north end of the present wing. The entrance foyer is shown at far left

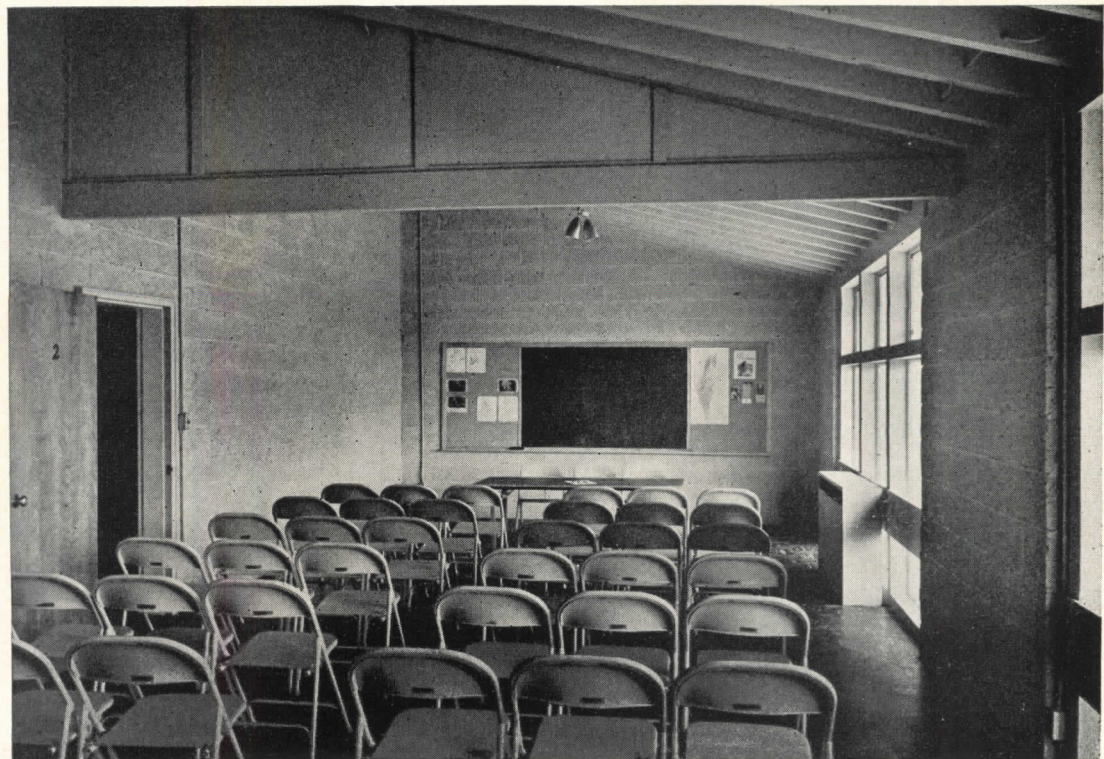

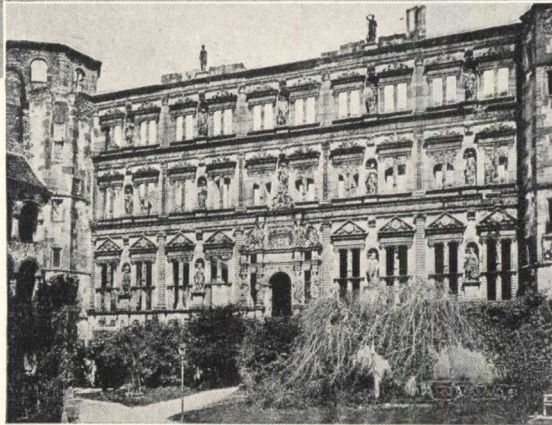
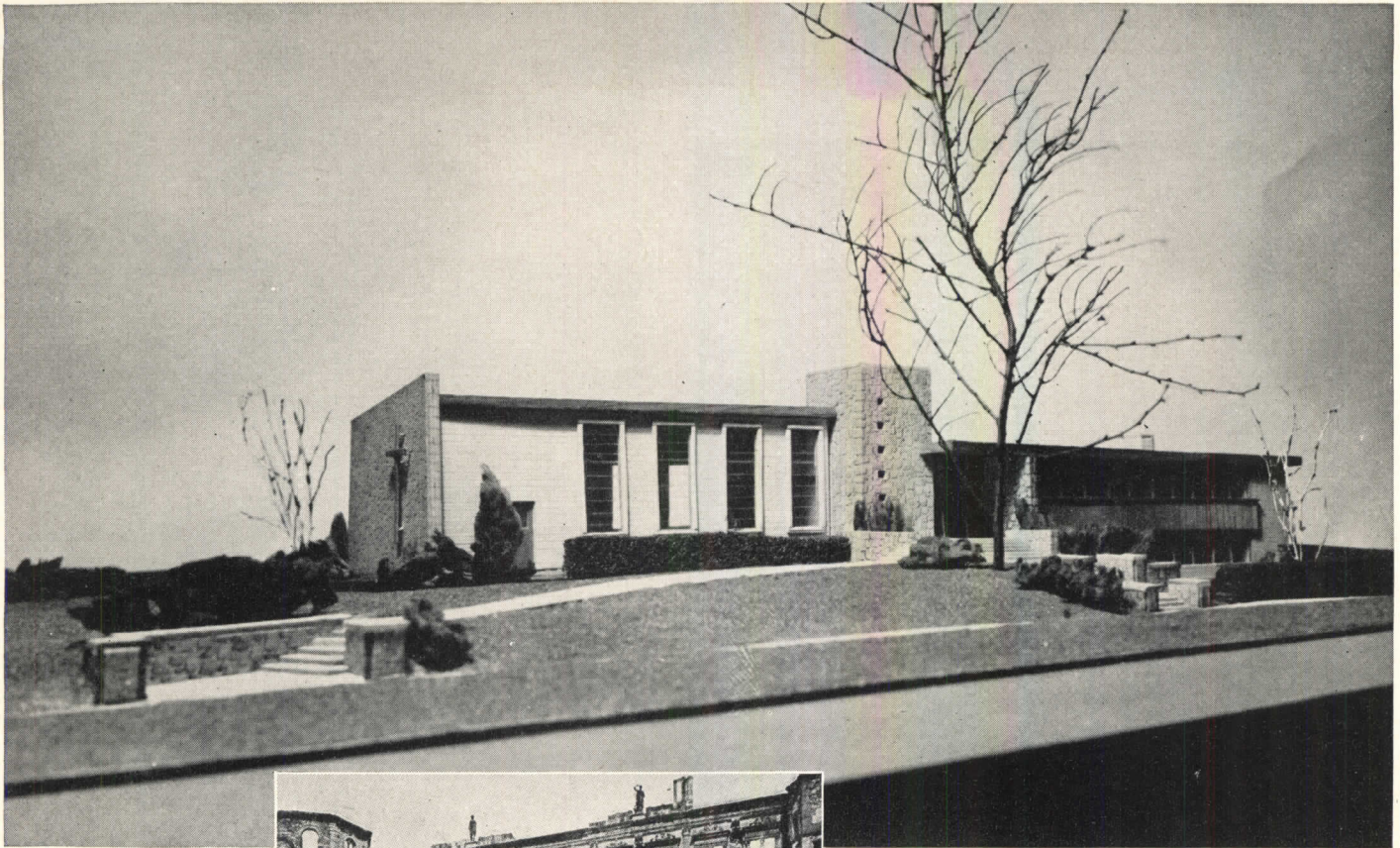
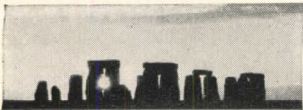

Luther's reforms show clearly in the design of this new Center, as well as in its services, when contrasted with over-ornamented Heidelberg Castle, typical of his epoch

LUTHERAN STUDENT CENTER AND CHAPEL

Ann Arbor, Michigan

STUDENT FELLOWSHIP is correlated with religious activities in this Lutheran Center at the University of Michigan. Designed to house an expanding program of work among students, conducted under sponsorship of the National Lutheran Council, the building has a three-fold function — to provide a chaplain's residence, a recreational center, and a student chapel and place for religious education. Each of the three sections is defined by a change of level in the plan. All are accessible from the central entry.

Contrasts of materials, and of vertical and horizontal lines are used to express the different functions of the building on the exterior. The chapel is lined with a series of tall windows set in the cinder block wall, and is flanked by a field stone end wall bearing a large cross and by the dominating staircase tower. The residential section of the building is characterized by horizontal lines and the use of wood for accent. The frame of the structure is steel and cinder block. A sunken garden gives light and access to ground floor recreation areas.

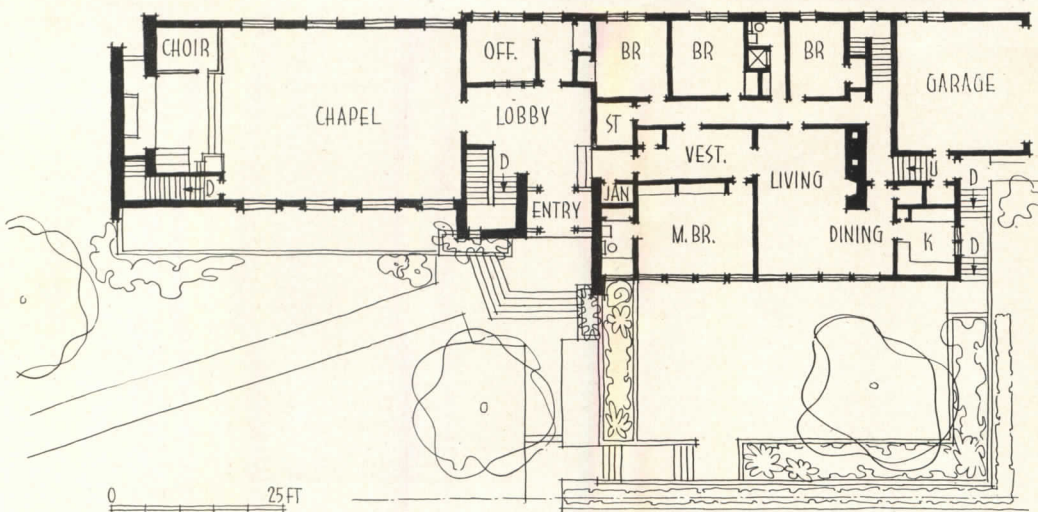

The three main sections of the plan are clearly separated to prevent interference of the several activities, yet have good circulation between them. The chapel forms a wing of the first floor, flanked by the chaplain's quarters. Recreation rooms are confined to the ground floor, which may be reached through a sunken garden. Construction photos below show the portion of the building now being built. Chapel will be built when house in upper photo is removed

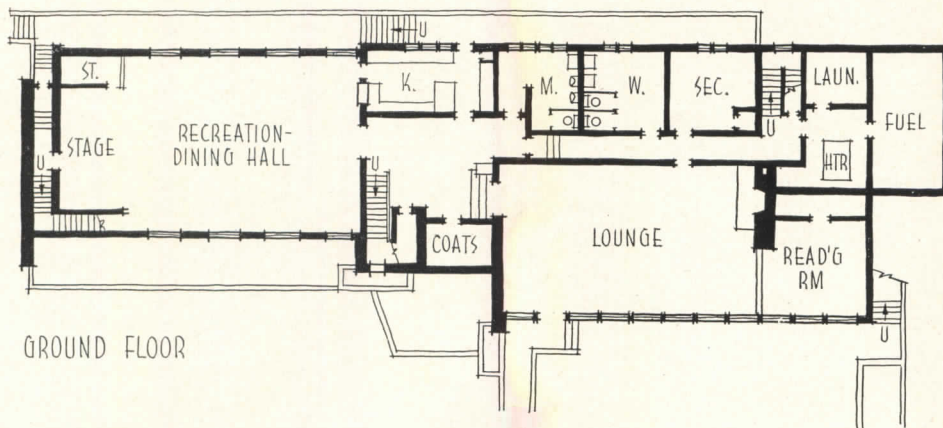

Ralph W. Hammett, Architect

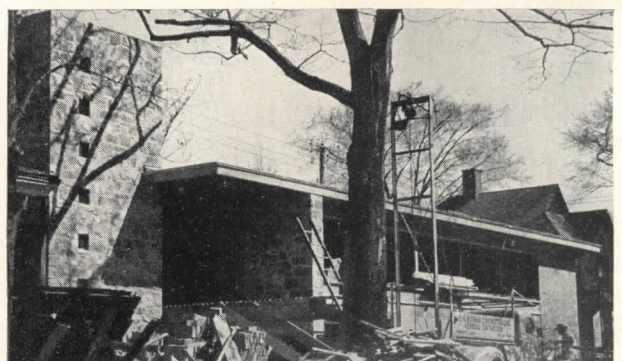

The Center is now under construction, and will be completed in two stages: first the recreational section with pastor's apartment, and then the chapel. The latter will be built after the Center has moved from a house on the property which they have occupied for the past several years. Interior partitions will be of cinder block, either painted or surfaced with sand-finished plaster. Floors are concrete over bar joists, ceilings plaster on metal lath. Heating will be by hot water and regular or baseboard convectors.



In the use of attenuated, glass-filled structural forms, the entrance of the First Baptist Church parallels such gothic conceptions as Rheims (inset). Here, though, the entry is transparent, leads eye into interior; unadorned block forms replace plastic surfaces

Julius Shulman Photos

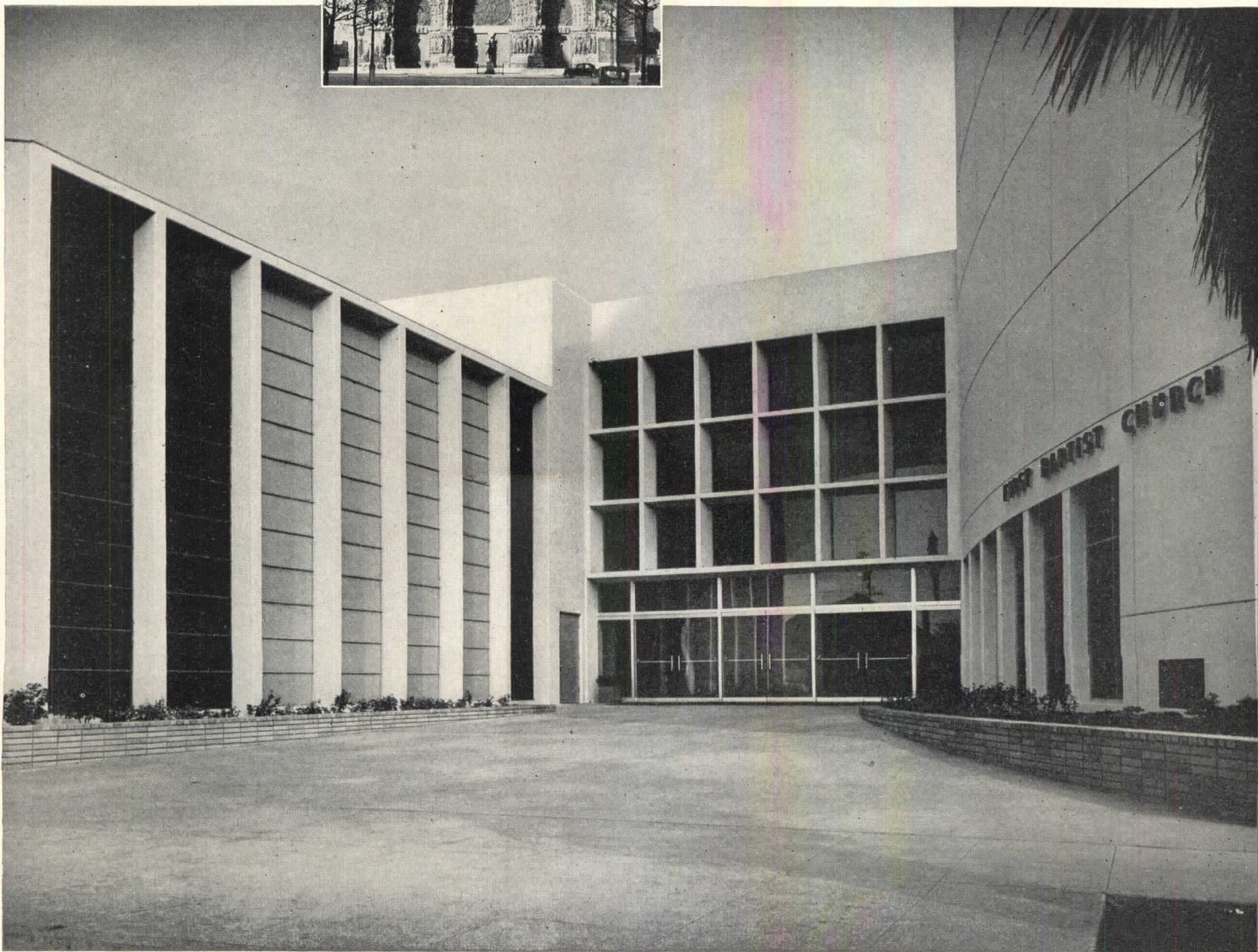



THE FIRST BAPTIST CHURCH, LONG BEACH, CALIF.

Kenneth S. Wing, Architect

A CHANGING CONCEPT of religion is exemplified by this large city church. The architect was asked to provide not only the customary areas for church services and Sunday Schools, but facilities for weekday social and recreational programs for every age group in the 3485-member congregation. The resulting plan consists of two floors, basement and penthouse. The main floor centers on an open entrance court and a glazed foyer, which gives direct access to all parts of the building. A double fire wall separates the 1500-seat auditorium from the classroom and office portion of the floor, which has its own entrance court. The Sunday School division extends to the second floor, and includes 32 classrooms and an assembly room for each department. Recreation facilities include two parlors with kitchen on the first

level, and meeting, social, and dining rooms in the basement. A study for the pastor, and part of the organ mechanism are housed in the penthouse. Two chapels are incorporated in the plan for small services and prayer meetings.

The resulting block form of each of the plan elements is frankly expressed on the exterior. This expression is further carried out by completely detaching the spire from the building, and erecting it as an independent symbol. The proportions of each of the block units were studied to give a balanced, unified rhythm to the facade. The entire structure is of reinforced concrete, with interiors plastered and painted. The only obvious traditional ornament used is the series of stained glass windows to be eventually installed in the memorial chapel.

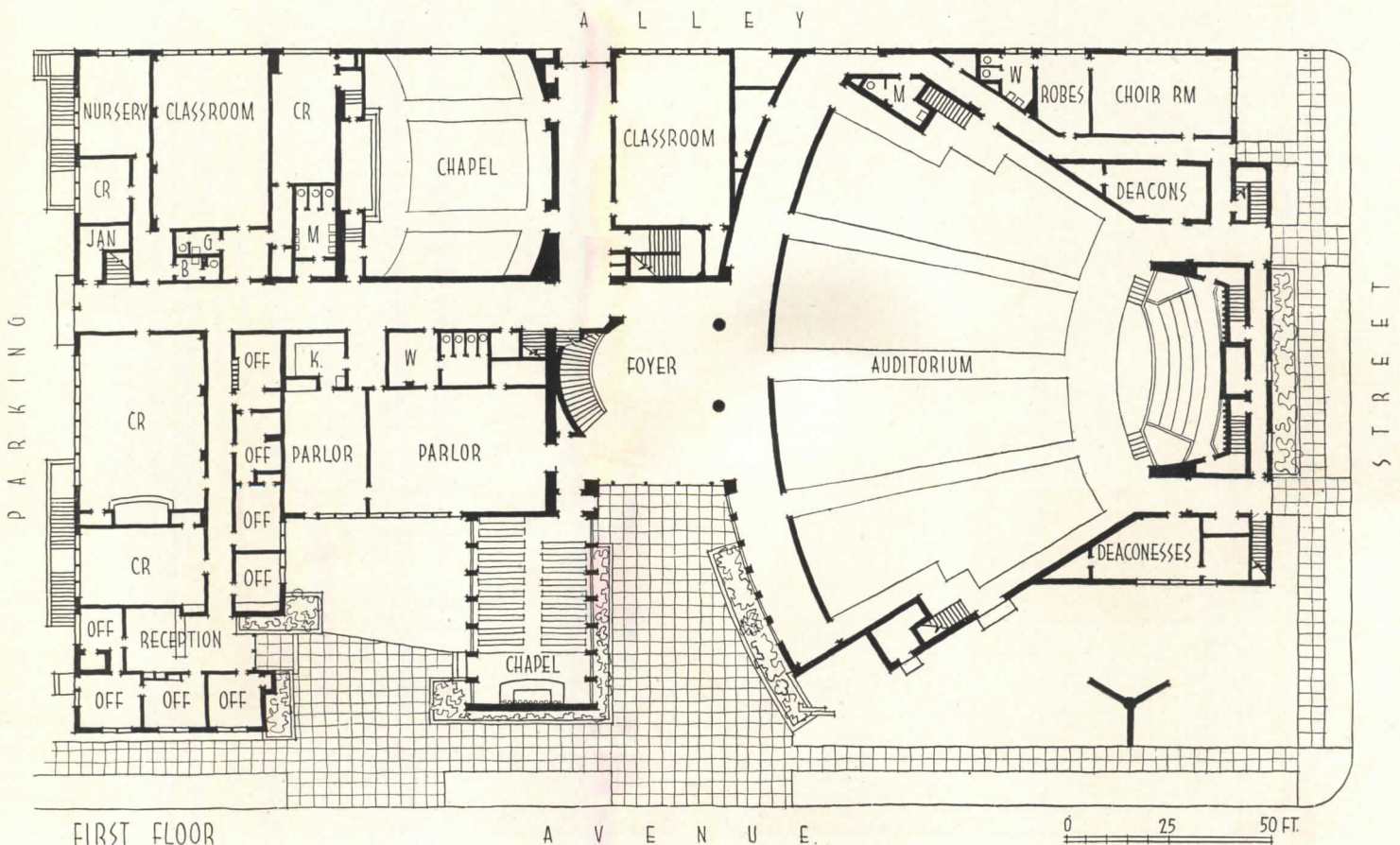

The auditorium, entered through spacious foyer (below), was designed to eliminate any supporting columns which might obstruct view (below right). The balcony is constructed with a 30-foot cantilever support of all-welded structural steel girders. Interior walls are painted plaster, ceilings are suspended metal lath and plaster, floors concrete. The grills behind the altar (below center) shield organ pipes, flank curtained baptismal. Equipment includes ceiling downlights, public address and intercommunication systems

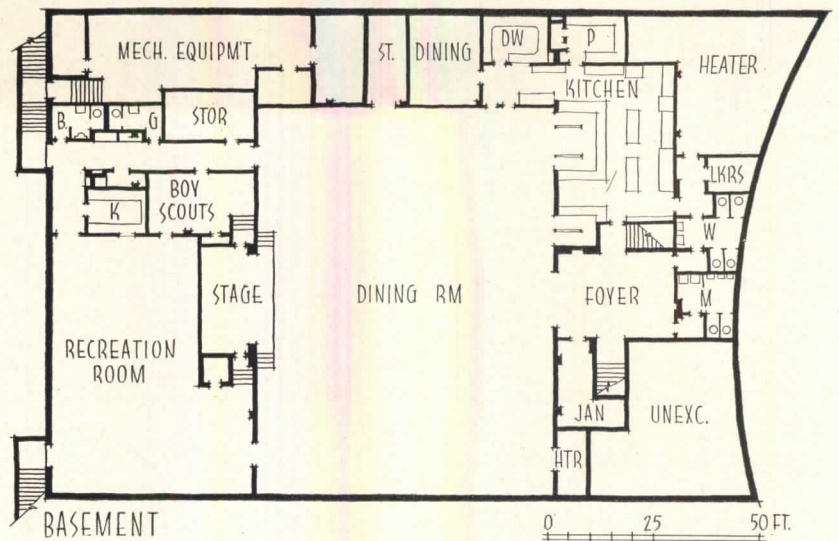

Julius Shulman Photos

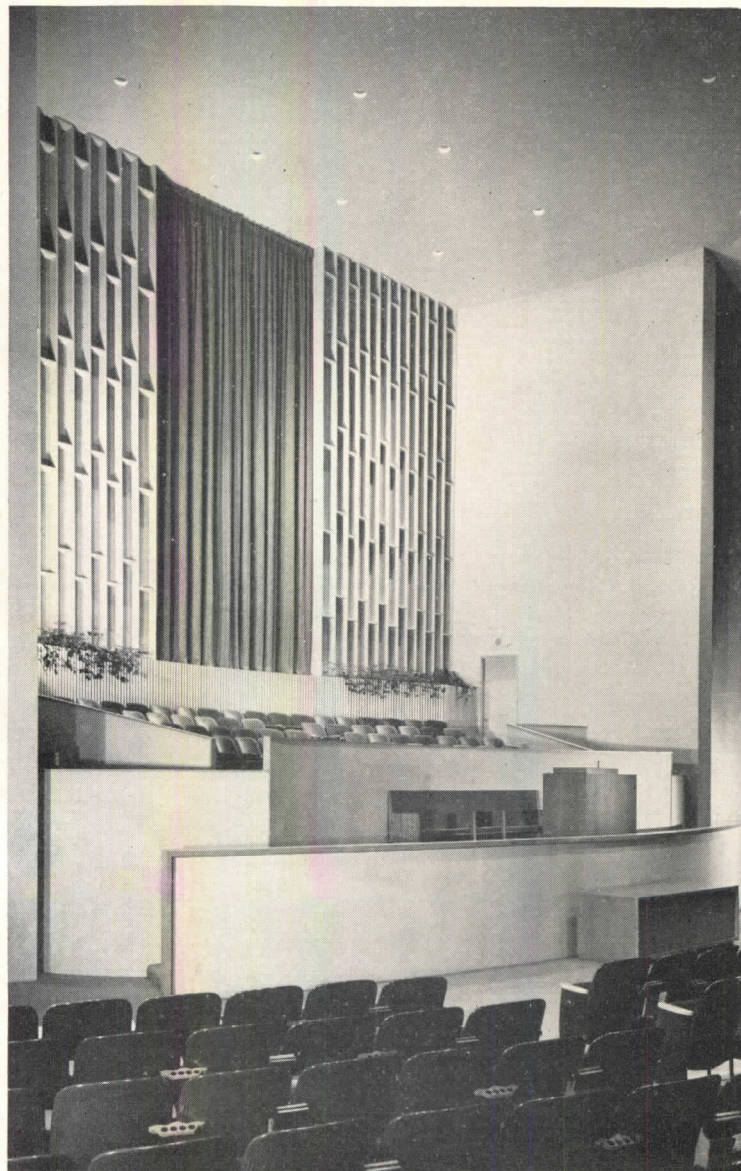

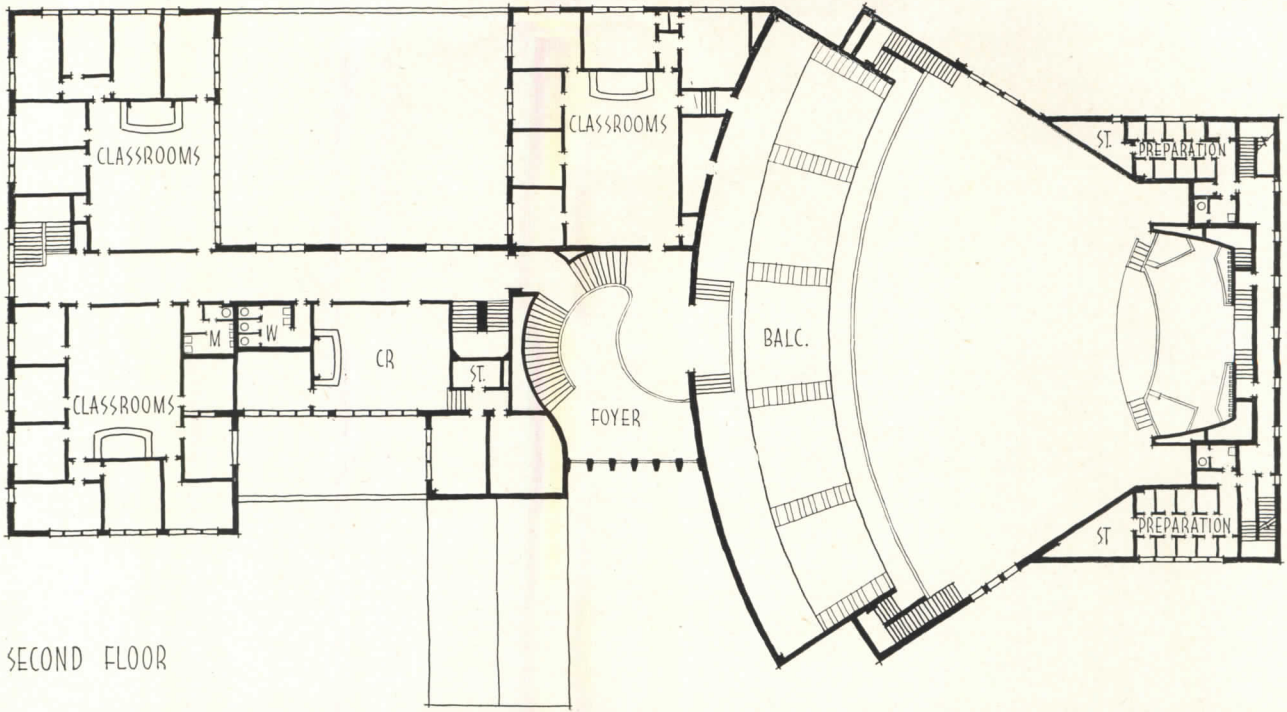

SECOND FLOOR





The interior of the memorial chapel (right) is perhaps the most expressive element of the church. Spaces between exposed reinforced concrete piers are filled with 14 floor to ceiling windows. All will eventually be of stained glass, portraying the life of Christ, and will form a decorative element of the facade (left). The detached concrete trefoil is capped by a copper spire and 6-ft cross, is 125 ft high over-all

Julius Shulman Photos

The office and Sunday School section of the building has its own entrance court and entry (right). Courts and grounds were landscaped by Edward R. Lovell

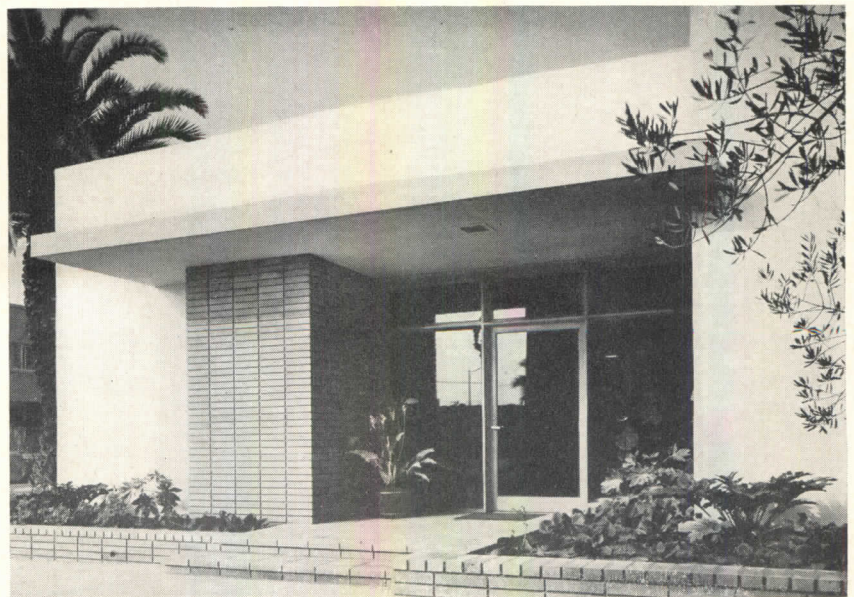



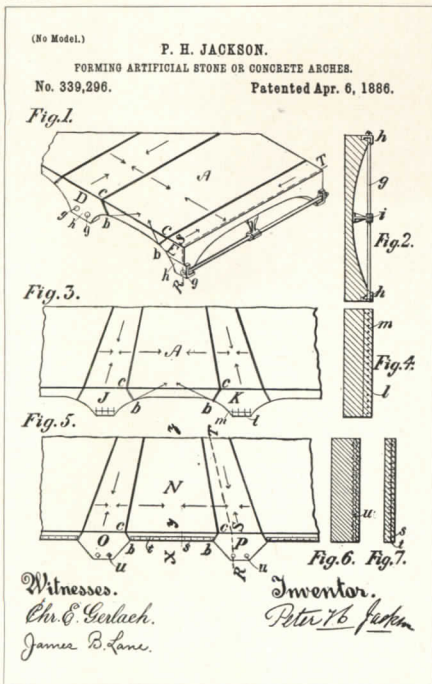

U. S. PROGRESS

1. Historical Background

THREE DAYS of this month will probably stand out in the history of U. S. prestressed concrete and the building industry. The "First U. S. Conference on Prestressed Concrete" was held from August 14-16 at M.I.T., which sponsored the meeting along with co-sponsors representing technical and professional societies including the A.I.A.

like rubber with the force released against the concrete — placing it in permanent compression and thus eliminating tensile stresses in the concrete under normal loads. This article emphasized the many advantages of prestressing for exploitation in the U. S. At that time there was believed to be only one prestressed structure, a bridge, scheduled for construction in this country. Although circular tanks and pipe had been built here for some 20 years, Europe led in linear prestressed structures where materials are scarce, labor inexpensive.

The purpose of the Conference was to outline the present status and potentialities of the technique in American practice. The reason for holding it at this time was that improved techniques here, extensive application abroad, and now the pressing need for conserving critical materials during defense mobilization, have stimulated considerable interest among architects and engineers. Thus, the sponsors feel that this meeting may well be the impetus for a much wider use of this system.

Yet, ironically, the basic principles of prestressing were conceived in the U. S. As long ago as 1886, only 25 years after the Frenchman Monier invented reinforced concrete, P. H. Jackson of San Francisco patented methods of tightening steel tie rods in artificial stone or concrete arches to be used as floors of buildings or sidewalks over excavations.

In August 1949, ARCHITECTURAL RECORD published a general article on prestressed concrete — the building material in which reinforcing steel is tensioned

However, the first logical theoretical treatments of principles underlying prestressed concrete are attributed to J.

1928

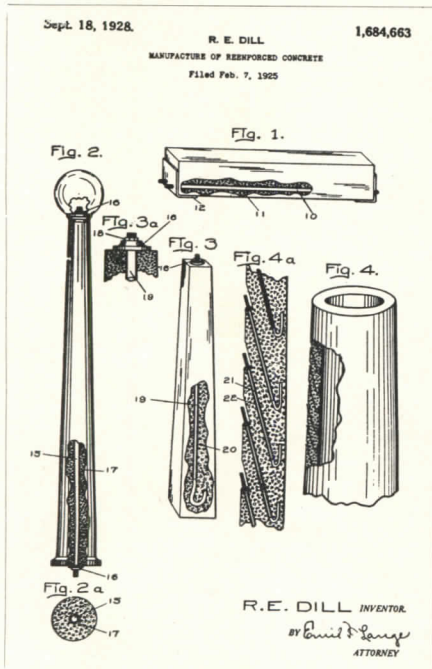

1937

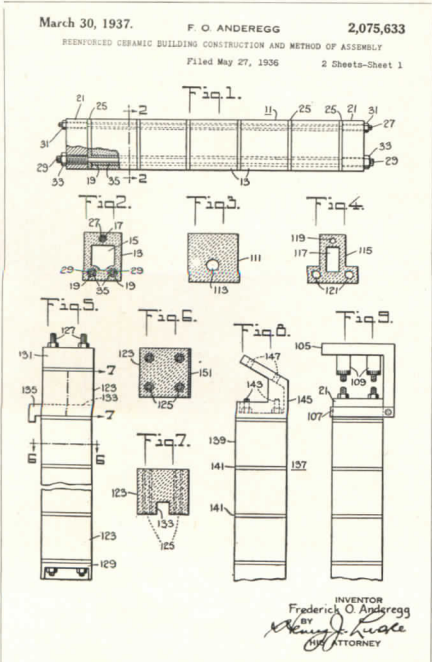

First to propose precompression was P. H. Jackson of San Francisco in his 1886 patent on forming artificial stone or concrete arches. In 1928, R. E. Dill from Nebraska obtained a patent which was the first one proposing a method by post-tensioning which eliminated the loss of prestress. F. O. Anderegg patented in 1937, a method of prestressing standard clay blocks by tensioning steel ties. Below: photo shows workers tightening nuts on tie rods



IN PRESTRESSED CONCRETE

Mandl (Austria) in 1896, followed by M. Koenen (Germany) in 1907.

In 1908, C. R. Steiner, an American, proposed to tighten reinforcing rods against green concrete and then to increase the tensioning force after the concrete hardened.

Early attempts to evolve a practicable system of prestressing failed because of the unavailability of high strength concrete and high tensile steel, or because the developers lacked knowledge of shrinkage and plastic flow in concrete (shortening due to the squeeze on it) and the "creep" in steel. What happened was that most of the prestressing force placed on the member was lost because the concrete became shorter and after a while the mild steel stretched.

First to Succeed

R. E. Dill of Alexandria, Nebraska, was the first one (patent applied for in 1925) to succeed in producing prestressed concrete members (posts and slabs) in quantity. The method was post-tensioning. Post-tensioning, or unbonded prestressing, means the steel is stressed after the concrete is hard and stress is transferred by end plates to the member. In pre-tensioning, the steel is stressed before the concrete is poured and the stress is transferred by bond of the steel to the concrete.

In Dill's method, high tensile strength or hard steel was coated with a plastic substance to prevent bond with the concrete, and was tensioned after the concrete set — which avoided the loss of the prestressing force due to shrinkage of the concrete. Although he thought that steel rods and nuts would be the least expensive, he suggested other possibilities.

In 1928, the French engineer M. Freyssinet came to the same conclusion as Dill, concerning the use of high strength steel. However Freyssinet went a step further in recognizing the serious effect of creep in the steel (the lessening of tension). In Freyssinet's first scheme, the steel was bonded to the concrete (pre-tensioning).

Practical application of pre-tensioning

1950

Photo Courtesy Preload Corp.



Above: first prestressed bridge to be started in this country was the Walnut Lane Bridge in Philadelphia. Below: the West's first, the Arroyo Seco Pedestrian Crossing, Los Angeles, Calif.

1951

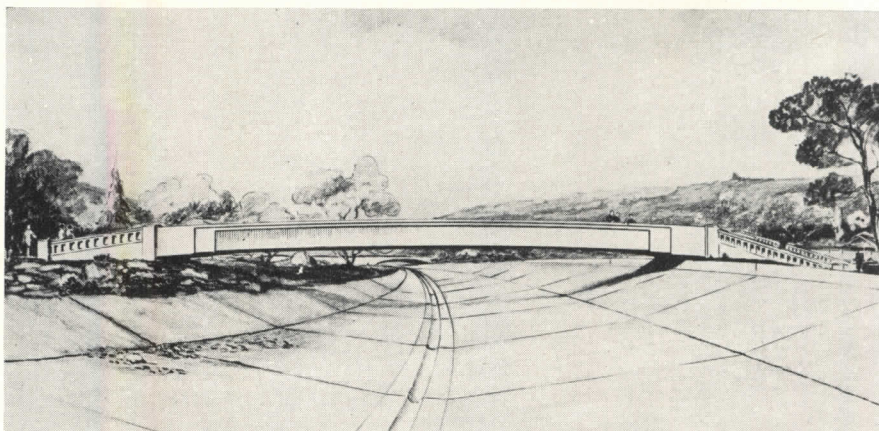

Below: Doric Bldg., called the first "truly prestressed" building in U. S.

1951

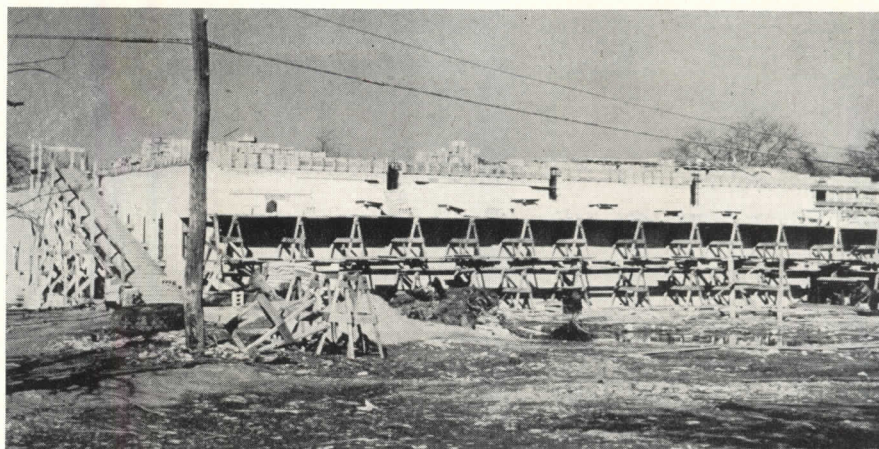

2. Theory, Methods, Advantages

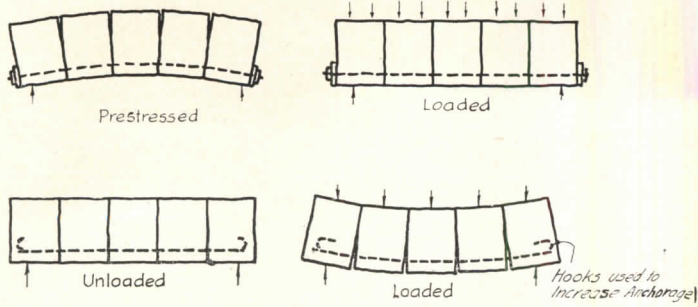

In prestressed concrete, the steel is tensioned against the concrete member to put it in permanent compression, so as to eliminate tensile stresses under load. Ordinary reinforcing (bottom sketch) helps restrain tension, but is inadequate

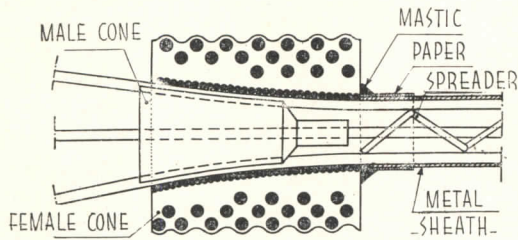

Freyssinet tensions wires with a hydraulic jack, anchors them with conical wedges. Orleans (France) reservoir—water tank supported on top of offices—was built with this method

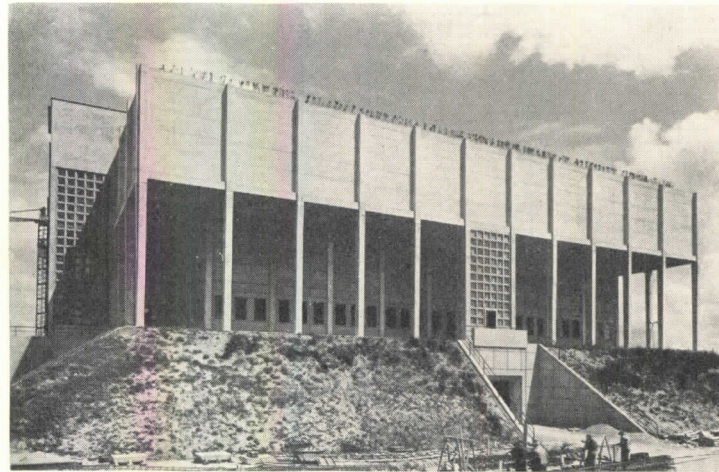
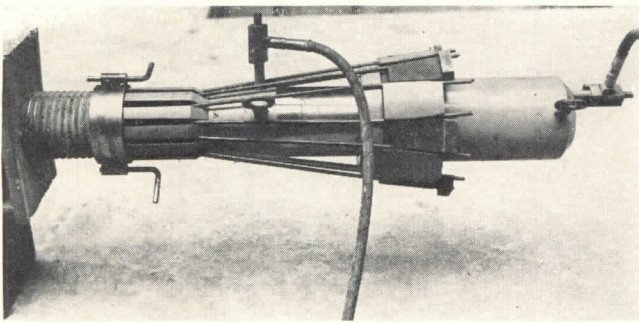

Photos courtesy Freyssinet

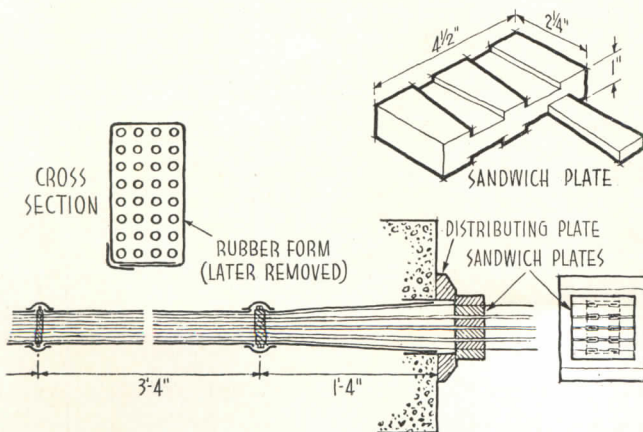

Magnel (Belgian) method also uses a hydraulic jack, wires are fastened, two at a time, with the anchorages shown. Walnut Lane Bridge in Philadelphia is of this type



was attained in 1938, by the German Hoyer, who tensioned thin wires over a long distance before concrete was poured over them. Smaller prestressed units were then made by slicing up the long continuous piece, greatly simplifying production.

An idea, which presaged some applications of today, was patented in 1937 by F. O. Anderegg, now Director of Building Materials Research, John B. Pierce Foundation. He prestressed perforated clay blocks by means of threaded high tensile steel ties. It set forth the idea that beams of various lengths could be made up of small, standardized precast units.

Post-tensioning became practical in Europe following Freyssinet's introduction, in 1939, of a technique for stretching cables by means of a double-acting jack, and anchoring them at the ends of the members with conical wedges.

Another method of end anchorage by wedges was developed by Prof. Gustave Magnel of Belgium in 1940. It was used in the Walnut Lane Bridge in Philadelphia, the first prestressed bridge to be started in this country. The first bridge to be completed, Oct. 1950, was located in Madison County, Tennessee (see pages 154-155).

On pages 152-153 is presented what is believed to be the first building in the U. S. constructed with prestressed beams and girders which take full advantage of high tensile steel. Prestressing forces running as high as 125,000 psi are placed on cables after they are threaded through concrete blocks. It is assumed that plastic flow of the concrete may reduce the tension to 105,000 psi. Holes in the blocks are located so the cables will follow the right curve through the beam to get more prestress where loads are largest.

The cables are made up of galvanized bridge wire having cylindrical terminals threaded for nuts. The cable system has just been announced by Roebling to provide a technique they thought more amenable to our labor-cost relationship. It is well adapted for application in the U. S. because it utilizes familiar materials and practices. They foresee in the near future production of a galvanized bridge wire which will have a maximum design working tension under live load of 120,000 psi without creep of the steel. More details of the system will be given later in this article.

Still another contemporary method, patented by the Prestressed Corp. of Kansas City, was employed in the West's first prestressed bridge (ARCHITECTURAL

RECORD, Western Section, March 1951). Here, wires are threaded through a steel stressing block after which case hardened washers are placed on and the wires are peened to form an anchorage.

Prestressing Combines Virtues

How does prestressed concrete differ from ordinary reinforced concrete? The theory of both is to compensate for the low tensile strength of concrete and prevent cracking by adding steel. Ordinary reinforcing helps by placing steel where tensile stresses are likely to occur. But it remains inert until the concrete member is under load and starts to bend. Over long spans and with very heavy loads, the member must be excessively large and require too many steel rods.

Prestressing puts an initial stress on steel and concrete to take advantage of the virtues of each, forming a practically new building material.

Advantages of Prestressed Concrete

A number of advantages have already been stated or are self-evident. However, they will all be listed briefly now to re-emphasize the potentialities:

- (1) cracks can be eliminated.
- (2) smaller depth-to-span ratios are possible, giving more headroom.
- (3) less materials are used, especially steel.
- (4) the architect can design concrete structures with cleaner, slimmer lines.
- (5) design calculations can be quicker and more accurate.
- (6) even under extremely heavy loads, the member will return to its original shape as long as the elastic limit of the steel has not been exceeded.
- (7) long spans can be constructed from

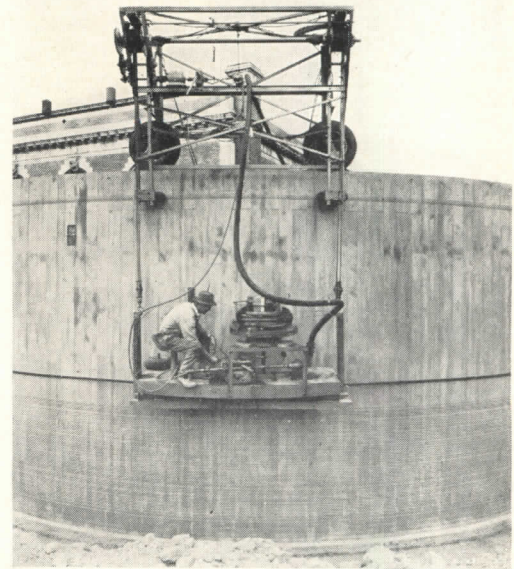
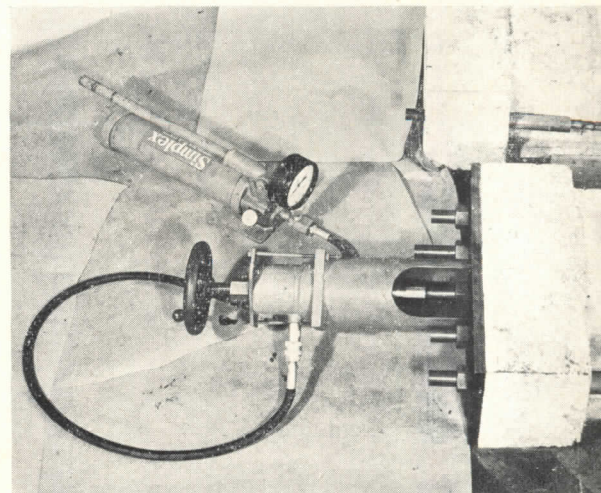
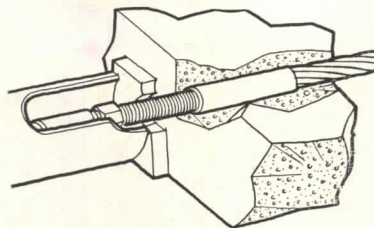

Photo courtesy Preload

History of prestressed tanks in the U. S. dates back some 20 years. Here is the Preload method in which the prestressing wire is pulled through a die to stress it as it is wrapped around the tank from the platform. Wire is then covered with a coat of pneumatically applied concrete

Method introduced by Roebling consists of high tensile strength bridge cable. Cylindrical terminals (called swaged fittings) have threads at the end so that nuts can be tightened up against steel bearing plates after the cable has been tensioned by a jack. Cables either can be threaded through concrete blocks, or, with a sheath, can be cast in the beam

Photo courtesy John A. Roebling's Sons Co.



3. Pioneer Building in Prestressed Concrete—Bryan and Dozier, Engineers



1

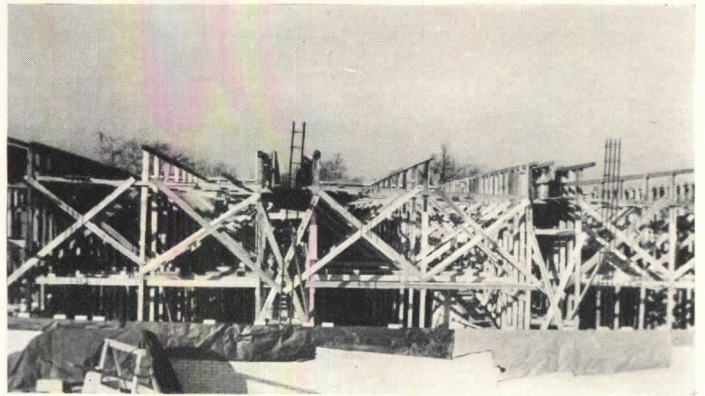

2

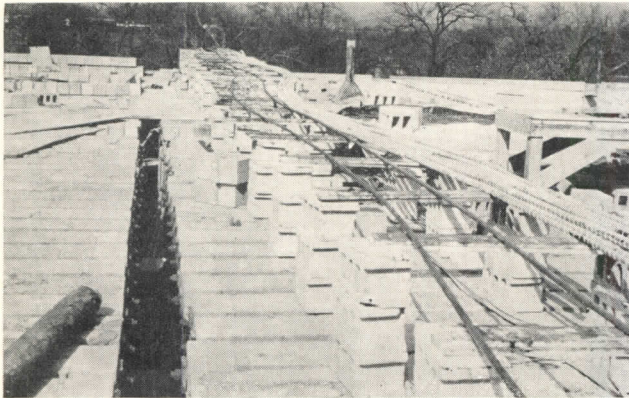

3

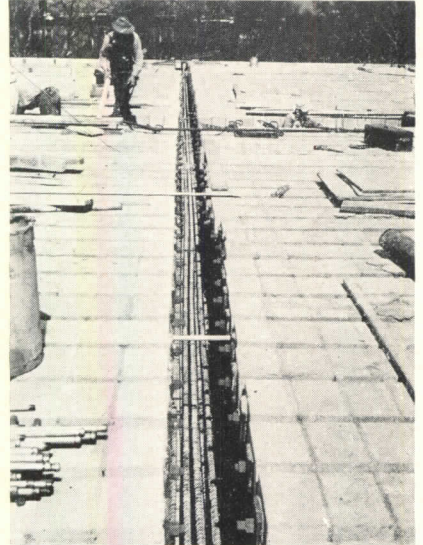

4

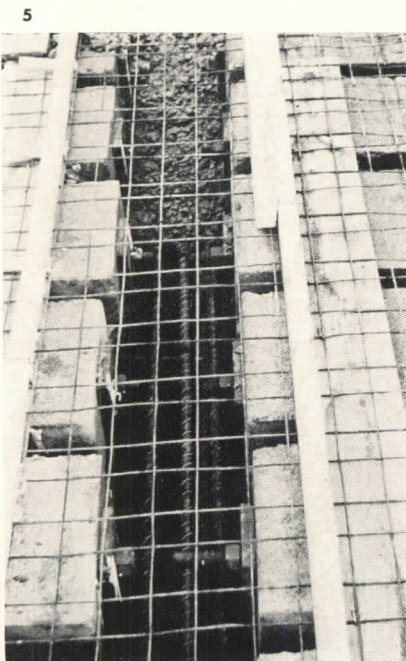

5



6

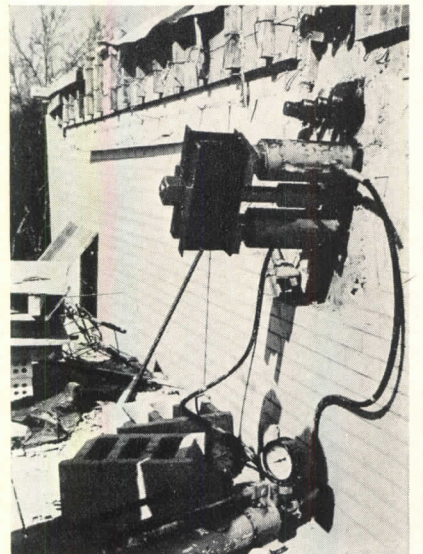

7

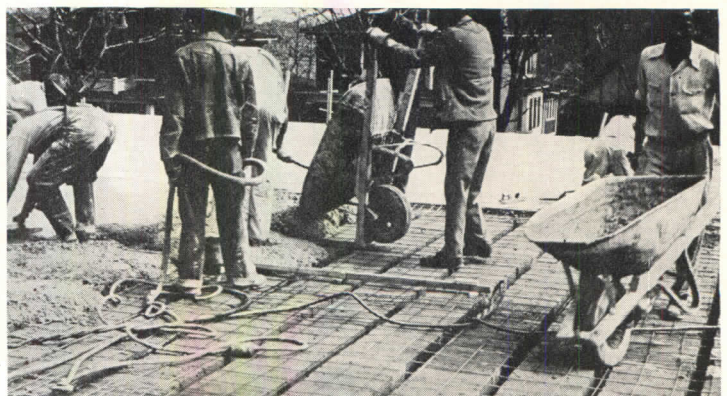

8

Doric Bldg., Nashville, Tenn. 1. Second floor block beams ("y" in drawing) being prestressed on the ground. 2. shoring for these beams and formwork for prestressed girders "x". 3. beams are in place, and cables for girder "x" are at right. 4. cables have been placed in the form. 5. girder is poured. 6. threaded terminals stick out of hardened girder (note bearing plates.) 7. cables are pulled by hydraulic jack to prestress girder. 8. concrete topping. 9. exterior view

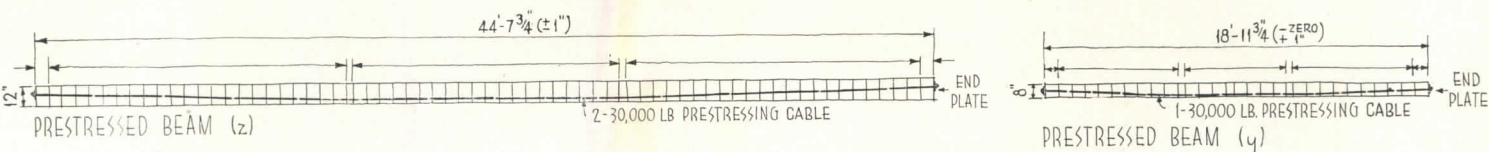
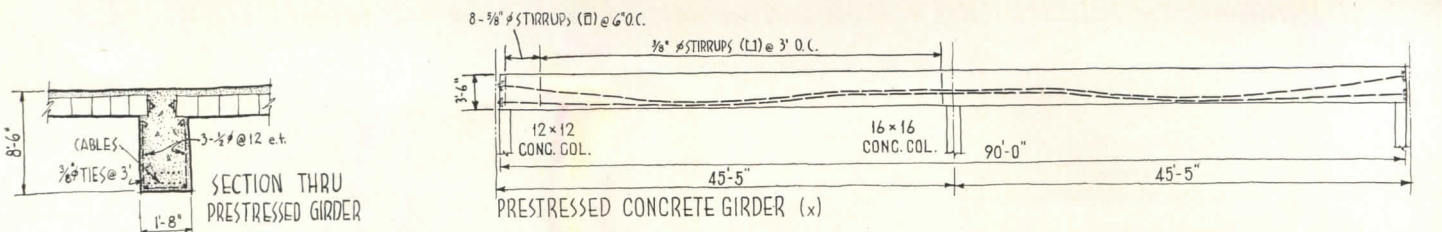

Above: "y" beams span between "x" girders for second floor; "z" beams span whole distance for the roof and run perpendicular to "y" beams. Dimension lines without figures indicate usage of various concrete blocks. Left block in each series is

used on the ends of the beam, middle block depresses cables for eccentricity, right block is used for rest of beam. In the framing plan, shading designates ordinary reinforced concrete. Cross-hatching shows the length of the peripheral girder

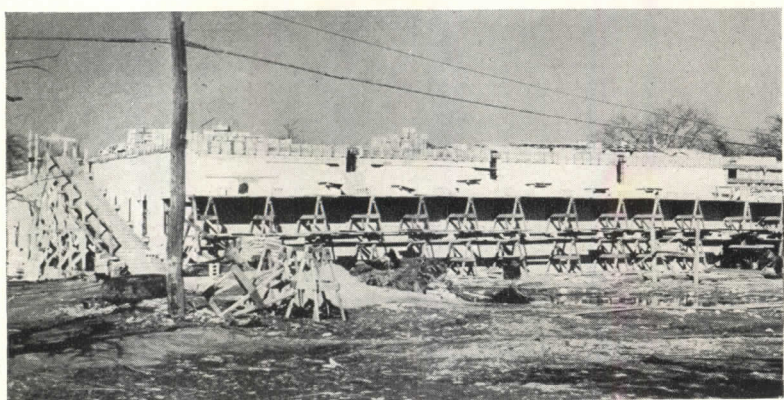
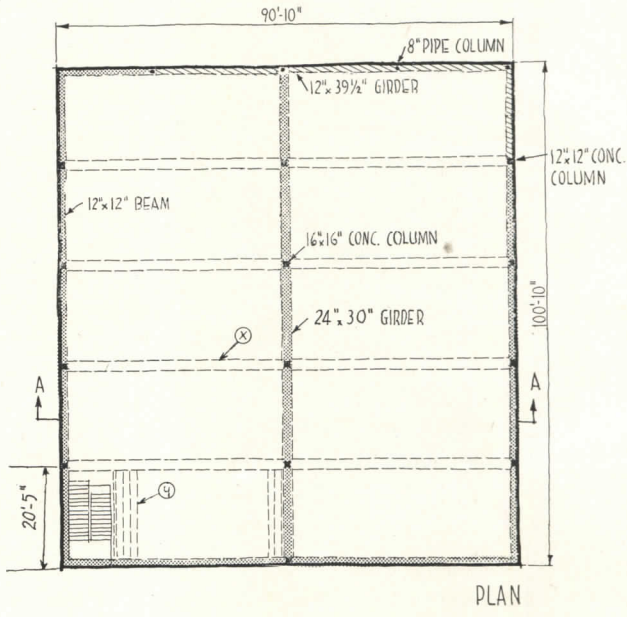
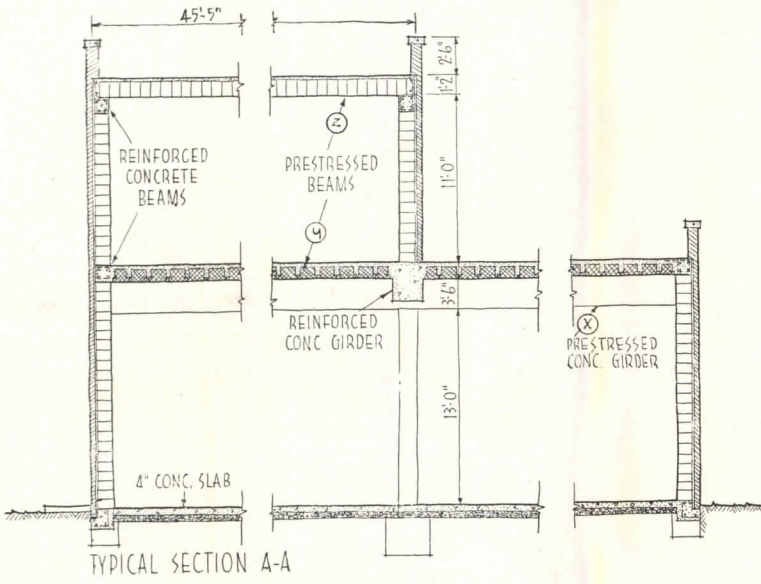

small precast units, made in a factory and trucked to the site for assembly.

Methods of Prestressing

Prestressing is accomplished by either post-tensioning or pre-tensioning, previously described. The few structures completed here have used the first method which requires end anchorages, but doesn't have the disadvantage of loss of stress due to concrete shrinkage. In this article are illustrated some of the bet-

3. Pioneer Building in Prestressed Concrete

ter known post-tensioning techniques.

Freyssinet tensions the wires of his cables with a double-acting jack placed against one end of the beam, and anchors the wires after they are stressed by ramming a conical wedge into a hollow cone which is cast in the beam. The cables may be cast in the beam, and protected by a sheath from bonding; or they may be threaded through a hole cast in the beam.

Magnel casts holes in the beam with rubber forms; then wires, arranged in rectangular cables, are drawn through, stressed, and then anchored by pushing flat wedges into "sandwich plates" (see sketch).

The *Roebbling* system consists of galvanized bridge wire in the form of pre-stretched strands. Cables covered by paper tubes may be cast right in the beam, or, unprotected, they may be threaded through holes in precast blocks. Attached to the ends of the cable are small terminals, threaded for nuts which are tightened up against steel bearing plates at the ends of the beams. An advantage of this system is that beams can be fabricated by ordinary laborers guided by an experienced supervisor.

Pioneer Doric Building

In but two years, the young firm of Bryan and Dozier, Consulting Engineers, has designed and seen completed three prestressed concrete structures. The building shown in various stages of construction in this article has been called by authorities the first "truly prestressed" one in this country.

When Ross Bryan became excited about the idea of prestressed concrete, he thought of using a standardized system of concrete blocks which could be formed into beams by stringing them on tensioned cables. He obtained the cooperation of the Nashville Brecko Block and Tile Company, which helped in the research and testing of the beams. First the engineers and the Brecko Co. built demonstration stands of the concrete block beams and so attracted interest of the Fayetteville High School in Tennessee, that the engineers were asked to design football stands for the school. Madison County engineers were equally enthusiastic, which resulted in the two-lane bridge illustrated.

The ground floor of the Doric Building, Nashville, Tenn., will be used for a supermarket by the Kroger Co., which prepared the architectural plans with architect Victor Stromquist acting as local consultant. The second floor will be used as a meeting hall by the Doric

Masonic Lodge. Although the second floor has only one-half as much area as the ground floor, the structure is designed for addition of the other half.

The engineers say a safe estimate of steel savings would be about 40 per cent of that required for ordinary reinforced concrete.

Quantities of steel used are:

Prestressing cables.....	27,300 lb
Anchor plates for cables.....	7,700
Reinforcing steel in columns, short girders.....	21,700
Wire mesh in slabs.....	4,500
Total steel.....	61,200 lb

Final costs will run close to \$6.50 per sq ft, excluding store fixtures.

Construction Steps

Second floor prestressed beams of concrete block were assembled on the ground and hoisted into place on top of

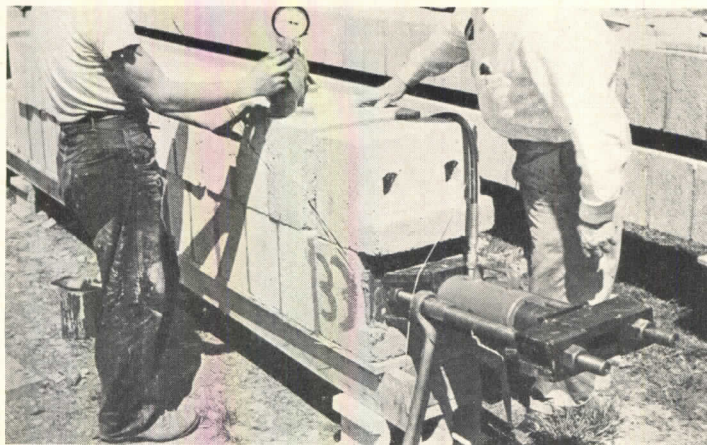

Gauge indicates prestressing force for the stadium beams

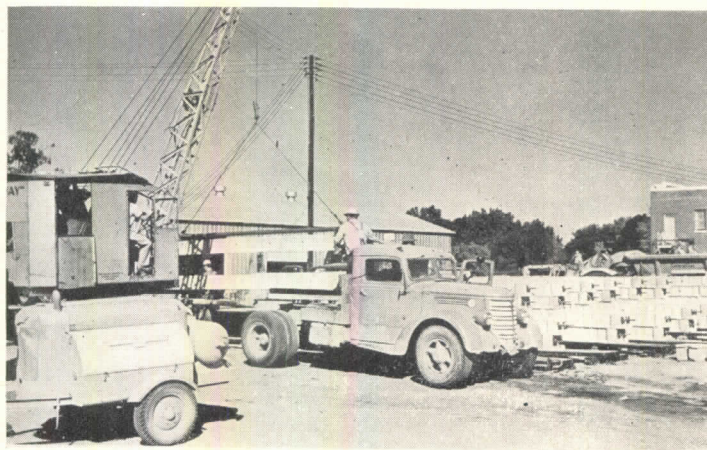

Bridge beams were fabricated by the highway maintenance crew

shoring until there was enough space for a working platform to fabricate the remaining second floor beams and the roof beams. The shoring which supported the prestressed beams spanning between monolithic prestressed girders, prior to pouring of the girders, will be eliminated on future jobs and is expected to effect considerable saving.

Ordinary reinforced concrete beams were used around the perimeter, and some girders elsewhere, due to short spans and the high costs for some applications.

The concrete blocks were buttered with mortar when assembled into beams, and a slight amount of prestressing was applied with the mortar still wet. This insures that the prestressing force will be distributed equally through the beam. Since cables are galvanized, there is no fear of rusting. Component blocks of the beams are shown in the drawings.

4. Stadium and Bridge by Bryan and Dozier

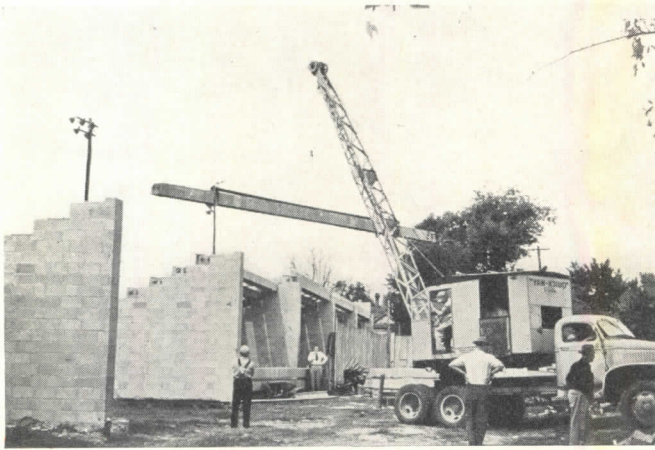

31-ft beams span between conventional concrete block piers

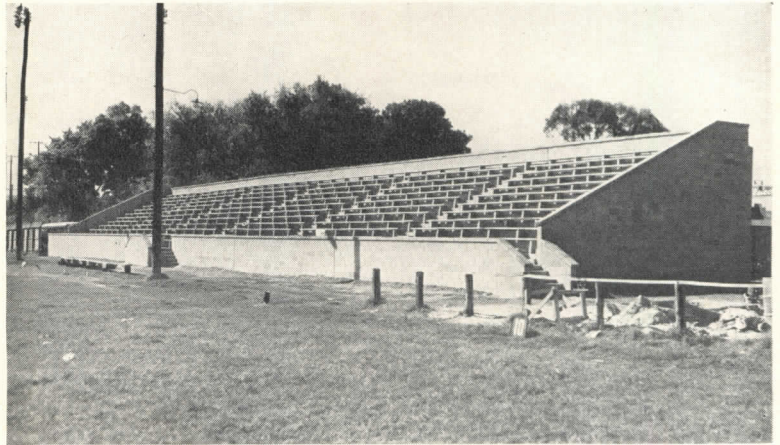

Football stands with 1500 capacity cost only \$7.65 per seat

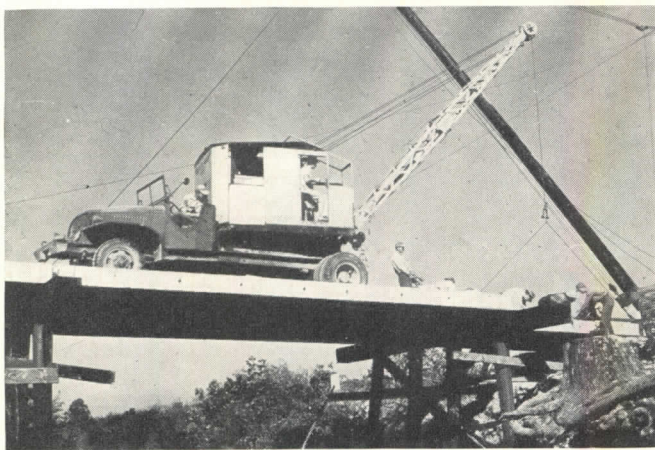

Crane supported by beams laid beforehand now sets final span

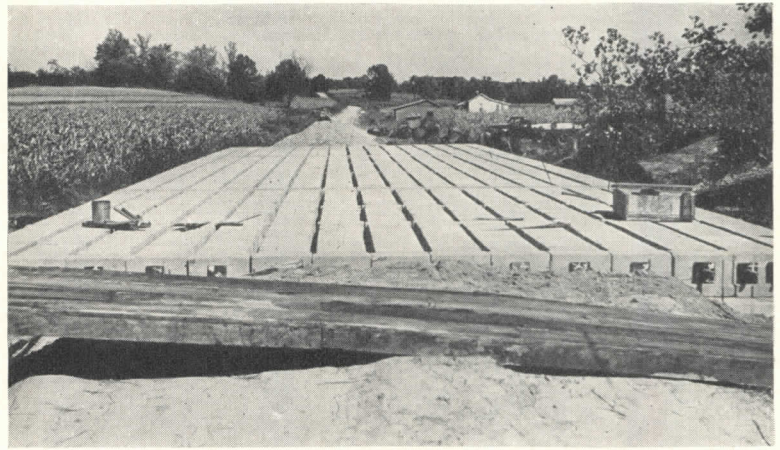

Bridge beams before high-early concrete slab was poured

Conservation of Materials in Stadium and Bridge

The football stadium, located at Fayetteville, Tenn., was first designed in poured-in-place, reinforced concrete providing seats for approximately 1500. However, a preliminary cost estimate of \$15 per seat exceeded the budget. A second design, using prestressed concrete members spanning 30-ft between concrete masonry piers, was prepared and new cost estimates indicated a price somewhere between \$7 and \$8 per seat.

Construction was completed in 32 working days using a crew of 9 men under the supervision of a superintendent hired by the school. The final cost of the completed stands was \$11,500 or, \$7.65 per seat. The savings in materials due to the use of the prestressed design are even more impressive than this cost figure. The reinforced concrete design would have required 15 tons of reinforcing

steel, 260 cubic yards of concrete and an undetermined amount of form lumber. The prestressed construction used 5 tons of steel (67 per cent less than the reinforced design); 191 cubic yards of concrete in the form of concrete blocks and 16 cubic yards of footing concrete (20 per cent less).

The bridge, which is approximately 10 miles from Jackson, Tenn., in Madison County, was the first prestressed concrete bridge to be opened to traffic in the United States. The crossing is 70 ft long and consists of three spans.

Each span is constructed from a series of prestressed beams laid edge to edge and covered with a 3-in. poured concrete topping slab. There are 2600 lb of wire mesh and reinforcing steel in the topping, slab and curbs; 2700 lb of steel in the prestressing cables, terminals and end plates; 23 cu yd of poured concrete and 25 cu yd of concrete in the form of

blocks used in the prestressed beams.

A conventional, reinforced concrete slab and steel girder bridge of the same length would require the following quantities: 12,880 lb of structural steel, 9100 lb of reinforcing steel and 33 cu yd of concrete. A comparison of these quantities with those used in the prestressed structure gives a saving of 75 per cent in steel with an increase of 43 per cent in concrete requirements.

Like the stadium, this bridge was erected without the use of any shoring or formwork other than that required to construct the roadway curbs. Erection was accomplished with a motor crane which traveled across successive spans as the work progressed. The prestressed members were hauled to the site on log trailers and set in 2 days, the poured concrete slab and curbs completed in 2 days and the transverse prestressing applied in less than one day.

SCHOOL COSTS APPRAISED BY QUALITY VALUES

*An economic analysis of 10 schools in New England.
Four charts present graphically the unit costs
and show relative efficiency of different designs*

A LOT MORE ATTENTION is being paid to thorough evaluation of school costs. No longer do progressive architects think in terms of one cost figure alone, whether it be per sq ft, per cu ft, per classroom or per pupil. They know, too, that quality of design and construction are just as much a part of the picture as dollars and cents.

Walter Bogner, Professor of Architecture at Harvard and member of the firm Bogner and Richmond, urges care in using cu ft costs and per pupil costs. He warns that high cost per cu ft does not necessarily mean that a building is expensive. A high figure may indicate that no cubage is wasted on useless space like attics or basements. He also says that cost per pupil must be carefully scrutinized in terms of the space and

equipment provided in classrooms and special rooms.

Last month ARCHITECTURAL RECORD presented evidence of this trend in a review of a report by the California Institute of Architects (pp. 160-161). In response to a request from the state government, the Council set out to establish a fair basis for comparing school costs, particularly needed in planning disbursement of state funds in distressed areas.

As a result of their research, the Council proposed a yardstick of construction features common to all schools which could be used in evaluating costs given on a sq ft basis.

But when there is a need to compare total values of school buildings, the additional factors of how well the school

functions and amenities must be considered.

Four Cost Charts

During planning of the Kingston School (ARCHITECTURAL RECORD, June 1951), the firm of Bogner and Richmond analyzed the costs of 10 New England schools, including the Kingston School (School "H" in charts). In a series of cost charts they interpreted cost according to a set of standards so that "plus" qualities attributable to careful planning would be recognized as well as low cost.

The charts bring out several points:

1. *Influence of building design on unit costs.* The charts, together with "Construction and Design Data," permit comparison of a variety of types of plans and exterior designs. Differences in plans

Charts compiled by Walter F. Bogner and Carleton R. Richmond, Jr., Architects

QUALITY VALUE IN SCHOOL DESIGN

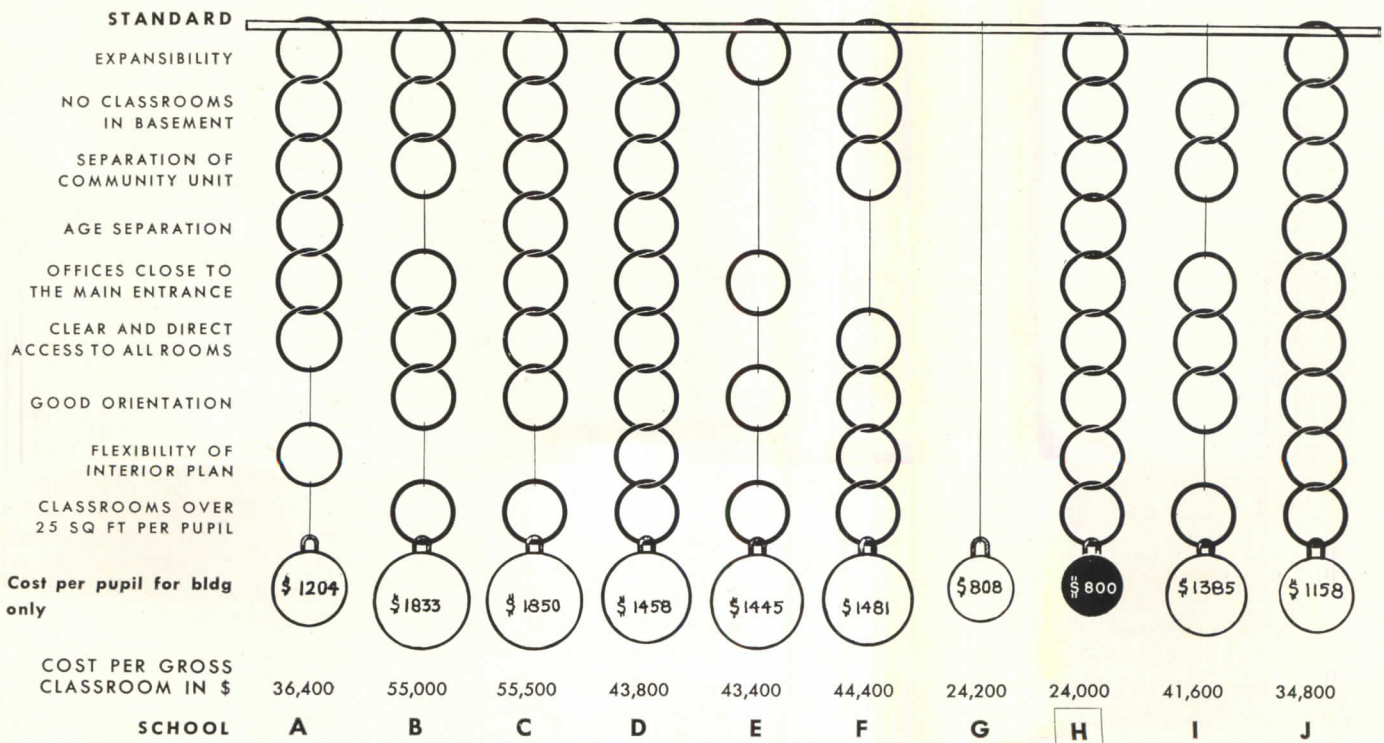

CONSTRUCTION AND DESIGN DATA

are: classroom size; classrooms on one or both sides of corridors; shape of classroom, unilaterally or multilaterally lighted. Exterior variations are: conventional designs with sloping roofs and traditional fenestration; designs with flat roofs and larger windows placed for greater freedom.

2. *Relative efficiency of the various design types and utilization of space.* Charts show how much of each construction dollar was allocated to space used for teaching (education space); to circulation, toilets and miscellaneous services (service space); to dead space represented by thickness of walls, floors, foundations and attics, and the space taken by the heating apparatus (construction space).

3. *Influence of the functional qualities of the designs on the cost.*

Answers to the following questions which architects or building committees are confronted with while planning a school may be deduced from these charts and "Construction and Design Data":

1. How does the size of a school influence its unit costs?
2. How do special rooms such as

	Classrooms	Corridor	Daylighting	Roof	Stories
A	16-24 by 30 ft	Double	unilateral	gable	1
B	10-22 by 35	Single	unilateral multilateral	gable flat	1
C	6½-22 by 36	Single	unilateral	gable	1½
D	6-24 by 37	Single	bilateral	shed	1
E	6-21 by 29	Double	unilateral	hipped	2
F	8-28 by 32	Double	monitor	flat	1
G	12-20 by 32	Double	unilateral	gable	2
H	12-23 by 36	D & S	bilateral	gable	1
I	6-24 by 36	Double	unilateral	flat	1
J	6-30 by 30	Single	bilateral	gable	1

auditorium, gymnasium, cafeteria and shops reflect themselves in building costs?

3. Do sloping roofs and traditional embellishments affect building costs seriously?

4. What is the relative cost of various plan types that are now being used?

5. How do multi-story schools compare in cost with single story?

Cost Basis

In all cases the unit prices have been based on contractors' prices for building construction. Costs of site development, building equipment and architects' fees have not been included because differences in these did not provide a uniform basis for fair comparison. School costs are based on actual contracts except for "J" which is estimated.

ROOM PROVISION IN SCHOOLS

Each symbol indicates one room

Where two or three different symbols appear in one block a room of multiple use is indicated

	B	C	D	E	F	G	H	I	J	K
CLASSROOMS	16	10	6	6	6	12	12	6	6	6
KINDERGARTEN	1	1	1	1	1	1	1	1	1	1
ACTIVITY ROOM						1				
WORKSHOP				1			1			
MUSIC ROOM							1			
LIBRARY								1		1
CAFETERIA	1	1		1				1	1	1
AUDITORIUM	1	1	1	1	1	1		1	1	1
GYMNASIUM		1		1	1			1		1
HEALTH UNIT	1	1	1	1	1	1	1	1	1	1
OFFICES	3	3	3	3	3	3	3	3	3	3
TEACHERS ROOM	1	1	1	1	1	1	1	1	1	1
COST PER STUDENT	\$ 1833	1850	1445	1481	1458	1385	1158	1204	800	808
SCHOOL	B	C	D	E	F	G	H	I	J	K

DOLLAR VALUE IN SCHOOL DESIGN

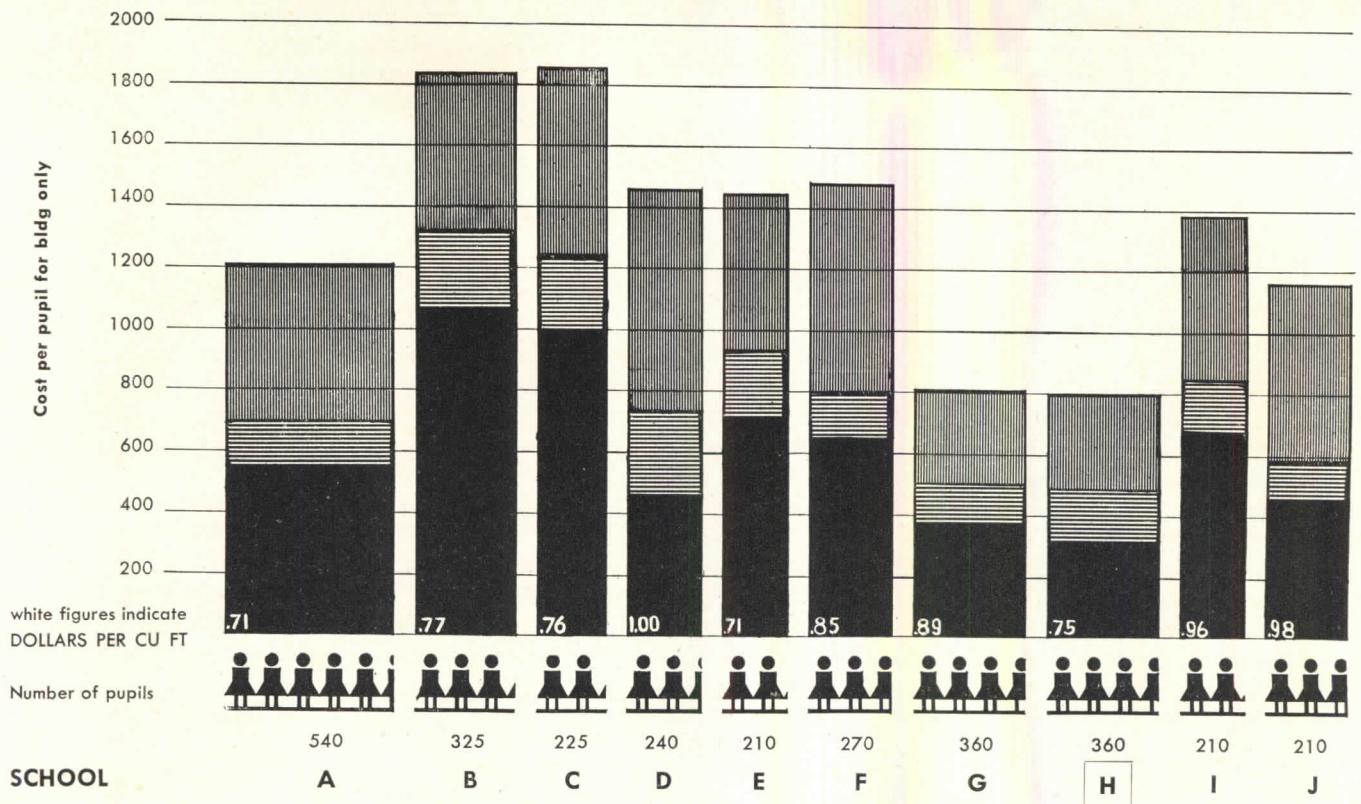

Cost per pupil is charted above. Black indicates construction space, horizontal lines service space, vertical lines education

THE TAXPAYER'S DOLLAR IN SCHOOL DESIGN

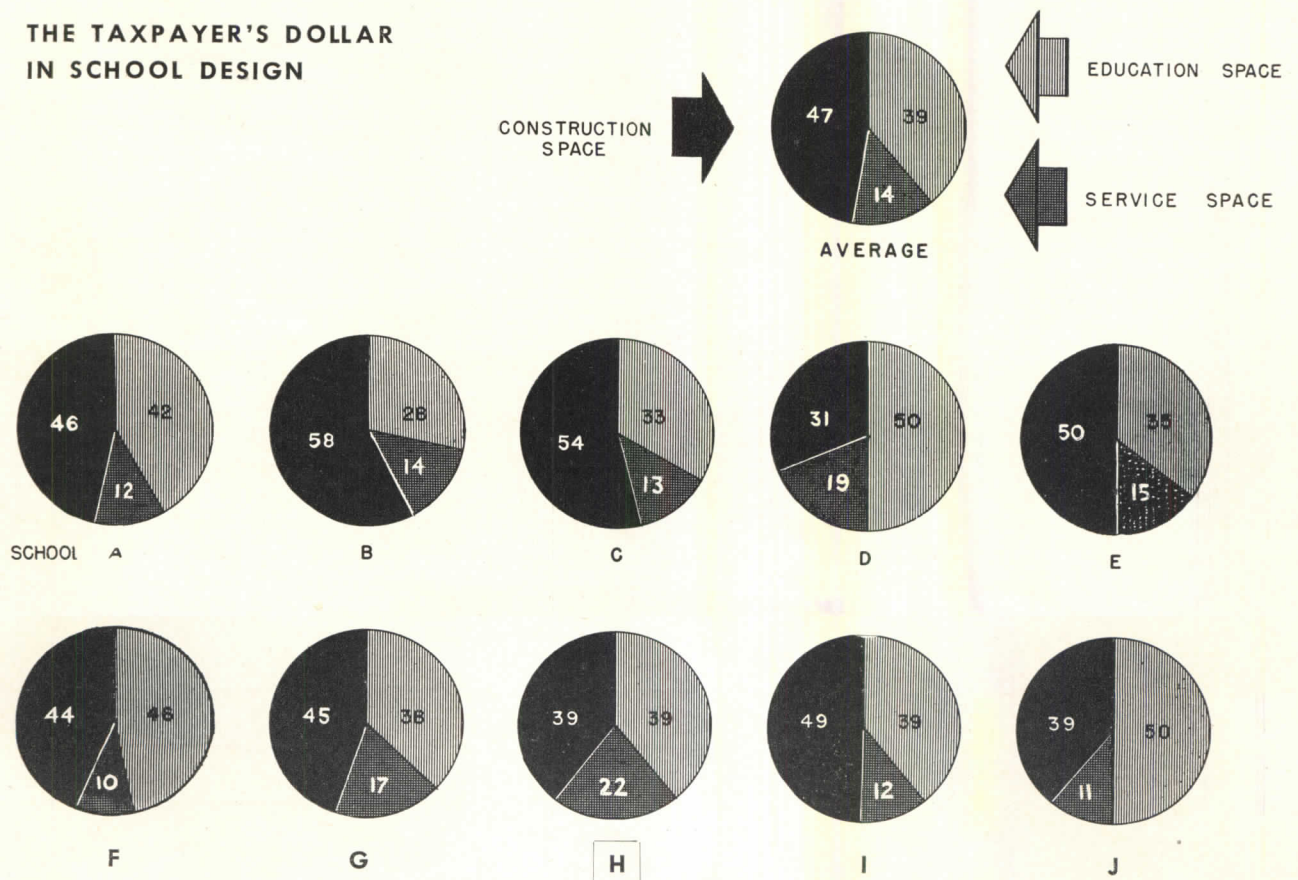

PRODUCTS for Better Building

Cellular Concrete

Thermo-Con cellular concrete is a new lightweight building material which possesses the unique property of rising to more than twice the level of the initial pour as it sets. The mix is prepared from Portland cement, water and chemicals of mineral origin, contains no aggregate. It is prepared as a liquid slurry by combining ingredients in a specially-designed generator, then pumped into forms. The finished material is said to

be composed of countless very small and uniformly sized spherical cells, having a density of about 45 lb per cu ft. Superior qualities are claimed for transverse bending, racking and impact shock, making it suitable for regions subject to earthquakes and storms. The concrete is also said to be fire-, vermin-, rot-, and dust-proof, moisture resistant, sound-deadening and a good insulation against heat or cold. Higgins, Inc., Thermo-Con Div., New Orleans 22, La.

Ultra-Violet Water Sterilizer

Using ultra-violet radiation to sterilize water, this automatic electric unit offers a safe water supply to areas where water is apt to be contaminated. Since this unit does not use chemicals it adds no taste to the water. The unit is composed of a stainless steel tank 72 in. high, 12 in. in diameter; internally mounted are four vertical ultra-violet tubes. The manufacturer states that

(Continued on page 172)

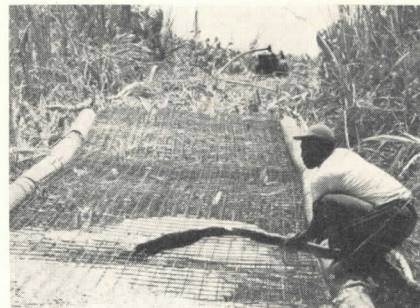
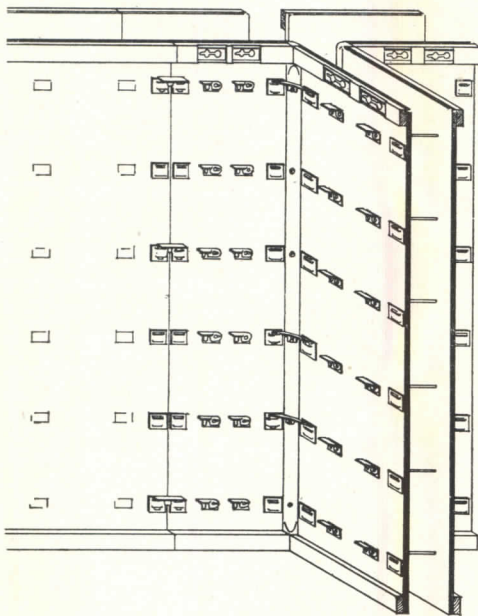

A variety of types of forms have been developed for use with the expanding cellular concrete. Above: reusable, plastic-faced wall forms; right: single form raised for erection of multi-story buildings. Below: walls poured on ground, raised by tilt-up method. Top right: experimental roadway made by pouring concrete directly over roll mesh

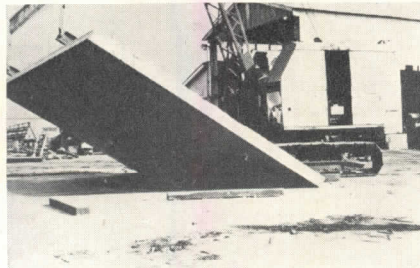
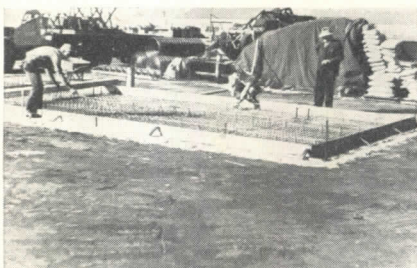
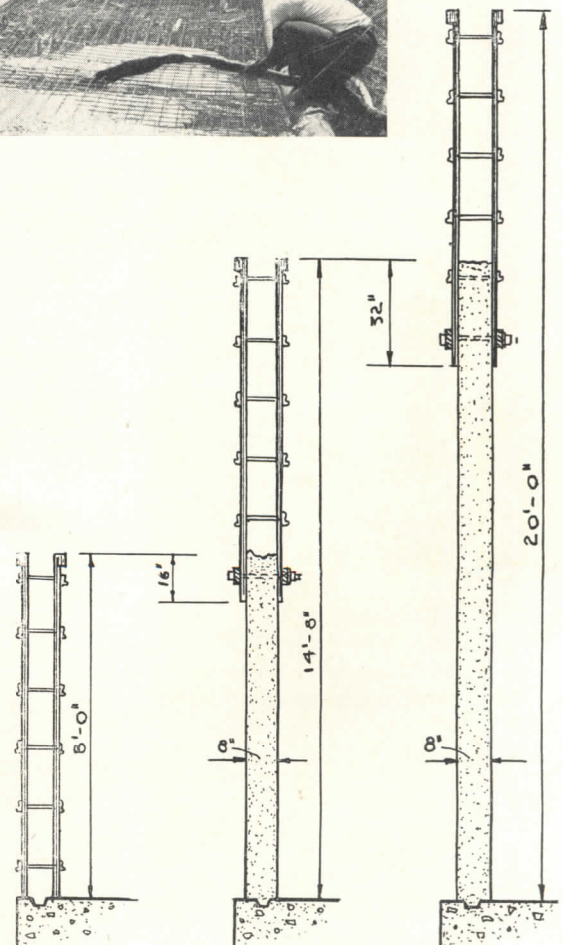

LITERATURE FOR THE OFFICE

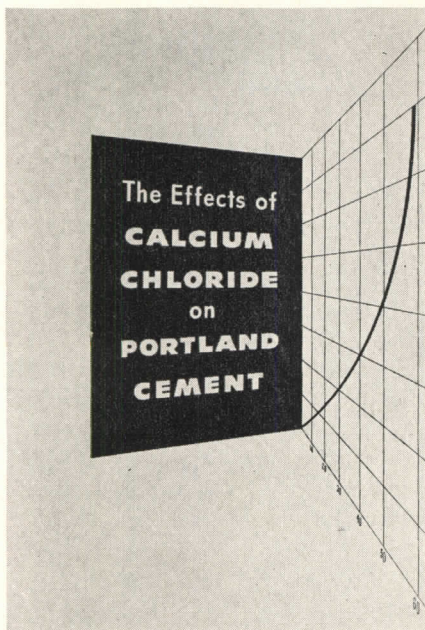

New booklet compares regular mix concrete with admix including calcium chloride

Calcium Chloride and Cement

The Effects of Calcium Chloride on Portland Cement. Showing graphically how calcium chloride affects cement's compressive strength, flow, water loss during setting, and acceleration of set, this booklet affords a source for comparative study between regular mix concrete and concrete with calcium chloride included. Standard as well as cold weather applications are discussed. A section answering commonly asked questions about use of calcium chloride is also included. 39 pp., illus. Solvay Sales Div., Allied Chemical & Dye Corp., 40 Rector St., New York 6, N. Y.*

Steel Swimming Pools

Koven Swimming Pool Manual. Presents factors involved in planning various type pools, and gives features of a line of steel swimming pools. Each type is discussed, and has construction and erection methods indicated by details. Each design feature is illustrated by drawings or sketches. Notes are also included on lighting, accessories and treatment of water. 12 pp., illus. Koven Steel Swimming Pools, Inc., 155 Ogden Ave., Jersey City, N. J.

*Other product information in Sweet's File, 1951.

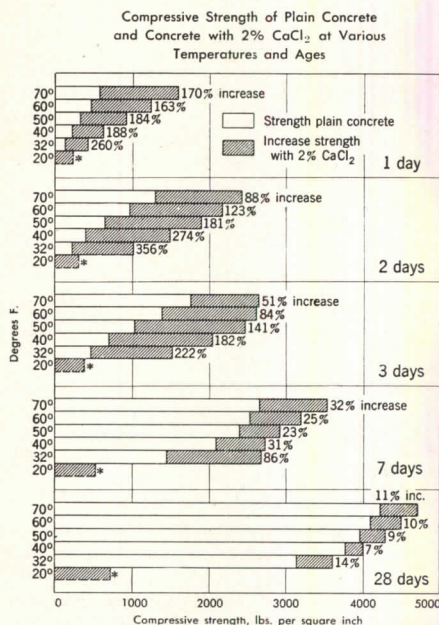

Forced Air Circulation

How to Have Comfort from Moving Air. Catalog illustrates many varieties of ventilation, air conditioning and heating systems. This catalog presents the products of 113 manufacturers of this type of equipment, rather than the description of a single producers line. Short descriptions of the products are given including pertinent data. 180 pp., illus. Price 50 cents. The Torrington Manufacturing Co., Torrington, Conn.

Built-Up Roofing

Ruberoid Built-Up Roof Selector. Slide-rule-like device, made of heavy cardboard, designed for use with the Ruberoid 1950 Specification Book to simplify selection of specifications for various types of built-up roofing.

On the front of the device, a vertical scale covers three basic factors to take into account: slope of roof deck, type of roof, and whether or not roof insulation is to be employed. When the pointer is set to the desired factors, page reference to corresponding specification appears. On the reverse side are details of flush and open eaves and low parapets. The Ruberoid Co., 500 Fifth Ave., New York 18, N. Y.*

Rolling Doors

(1) *Kinnear Rolling Doors* (Bulletin No. 68); (2) *Kinnear Wood Rolling Door Saves Steel For Armament Needs* (Bulletin No. 37-A). The first of these booklets is the 1951 catalog of a line of interlocking steel-slat rolling doors for service and fire-protection purposes. The doors are presented with notes on features, construction, mounting and operation. Tables of sizes and specifications are included. A section is devoted to rolling grilles and special doors.

The second bulletin describes a wood rolling door available as a substitute for steel models in case of defense shortages. 32 pp., 4 pp., illus. The Kinnear Manufacturing Co., 5120 Fields Ave., Columbus 16, Ohio.*

Floor Covering Tests

Indentation Characteristics of Floor Coverings Used Over Radiant Floor Panel. By H. F. Mullikin and L. C. Horpedahl (Montana State College Bulletin No. 11). Relative indentation characteristics of several asphalt, linoleum and rubber tiles, determined in part of a research program at Montana State College's radiant heating laboratory, are presented here. Relative indentation, states the booklet, was determined by loaded floor gliders on floor coverings heated to 103 F over periods of 24 hours. Indentation characteristics in general are described, and test procedures given. Two tables giving some test results are included. 4 pp., illus. Montana State College, Bozeman, Mont.

Registers

Lima, The World's Finest Registers, and *The New Lima Diffuser* (Technical Bulletin No. 40-214). First booklet catalogs various types of manufacturer's line of registers including: wall, baseboard and floor registers, and ceiling diffusers. Tables give specification, dimensions and prices. 16 pp., illus.

Second booklet gives details on new diffuser, designed for perimeter heating, special warm air heating applications and/or air conditioning. Detail drawings and engineering data are included, as well as tables giving dimensions. 8 pp., illus. Lima Register Co., 651 No. Baxter St., Lima, Ohio.

(Continued on page 190)

RADIANT HEATING SYSTEMS FOR HOUSES: 1—Hot Water Systems

By William J. McGuinness

Professor of Architecture, Pratt Institute

The author and editors wish to express appreciation to the following for their generous help and suggestions during the preparation of this study: Mr. George Lain, American Iron and Steel Institute; Mr. J. B. Fullman, A. M. Byers Co.; Mr. William P. Chapman, National Tube Company; Mr. Huson Jackson, Architect; Mr. D. L. Mills, Revere Copper and Brass, Inc.

Radiant Systems in General

Radiant or Panel Heating, which consists of making up heat losses by creating warm surfaces within the rooms, can have as its heating medium hot water, electricity or warm air. The response, economy and design differ somewhat. This discussion is limited to systems which use hot water and the design tables apply to residential installations only.

Human Comfort

The function of any heating system as it affects human comfort is to maintain a constant rate of heat loss from the body. The possible adjustments to regulate this loss are temperature of the air and temperatures of surrounding surfaces of spaces, air motion and relative humidity.

The latter two are confined largely to convection systems, but the proper relationship of the first two is the special province of radiant heating. By raising the temperature of the room surfaces, radiant loss from the body is retarded and the convective body loss can be increased by dropping the air temperature.

With a lower room temperature, the hourly heat loss from the room is reduced with a favorable effect on operating economy. The combined effect of warm surrounding surfaces and a lower air temperature is one which most people consider more com-

fortable and even invigorating. The "cold shoulder" effect is eliminated.

Other comforts are inherent in this system. Temperature distribution throughout the room is very uniform. This is especially noticeable in the constancy of the air temperature at various heights above the floor. Often the temperatures from floor to ceiling remain within 2 deg, while in other systems they often vary from 10 to 15 deg with cold floors and hot ceilings.

The absence of hot radiators prevents the "baked" sensation in the air and eliminates fast vertical convection air currents which cause dirt streaks on walls and ceilings. The relative humidity is slightly higher in radiant systems because of the lower air temperature.

Relative Economy

The comparative cost of radiant heating and other methods is quite special to the individual installation. In general, it is 15 to 20 per cent more costly to install, although some radiant installations have cost less than conventional ones. Structural savings, like the omission of basements and crawl spaces, can offset the extra cost of radiant heating.

Floor systems are often more economical to install than ceiling systems. Operating costs as already stated are usually less than in other heating systems because of the lower room tem-

perature that can be maintained for equivalent comfort.

While there is a difference in the actual material cost of copper, wrought iron and steel, the total job cost will depend largely upon the facilities available for fabrication. This should be investigated locally.

Panel Location

Floor, ceilings and walls are available as possible panel locations. Walls are seldom used because of the difficulty in finding enough area to provide sufficient heat output. Their use is generally confined to auxiliary panels.

Fig. 1 illustrates the most commonly used ceiling and floor panel construction. For simplicity, this discussion will be confined to the use of these types. The floor slab which is more economical is well suited to basementless houses with concrete slabs on the earth. The mass of concrete surrounding the pipes has greater heat retaining qualities than the thinner plaster panels of the ceiling and therefore is appropriate to houses in which the call for heat is steady without fast fluctuations.

Ceiling panels, though more expensive than floor panels, are more truly radiant, have a greater permissible temperature and output, and will heat or cool off more rapidly upon demand. They are suitable for houses with much glass. Ceiling pipes must have at least one-half of their sur-

Want to carry
power vertically?



**CHASE SQUARE COPPER
TUBE BUS CONDUCTOR**
is the way to handle it

THE SQUARE SHAPE of Chase Copper Tube Bus Conductors means more rigid construction . . . higher mechanical strength to resist the stresses of short circuits. With four flat sides, and a large cross-sectional area, they can be securely anchored to the floor, assembly is easier . . . efficient and economical connections can be made to power-and-light panels. And — there is no danger of insulation moving downward, to leave thinly protected sections.

IN ADDITION to having excellent current-carrying capacities and extreme resistance to corrosion, Chase Square Copper Bus Conductors require only one tube per phase . . . minimize "skin effect" . . . can be arranged in triangle-formation, resulting in equal spacing and equal voltage between phase conductors.

• For complete information about these stronger, better Bus Conductors, write to Dept. AR851, Chase Brass & Copper Co., today!



Chase  **BRASS & COPPER**

WATERBURY 20, CONNECTICUT • SUBSIDIARY OF KENECOTT COPPER CORPORATION



• The Nation's Headquarters for Brass & Copper

- | | | | | |
|------------|--------------|------------------|--------------|-----------------------|
| Albany† | Cleveland | Kansas City, Mo. | New York | San Francisco |
| Atlanta | Dallas | Los Angeles | Philadelphia | Seattle |
| Baltimore | Denver† | Milwaukee | Pittsburgh | Waterbury |
| Boston | Detroit | Minneapolis | Providence | |
| Chicago | Houston† | Newark | Rochester† | († sales office only) |
| Cincinnati | Indianapolis | New Orleans | St. Louis | |

RADIANT HEATING SYSTEMS FOR HOUSES: 2—Hot Water Systems

By William J. McGuinness Professor of Architecture, Pratt Institute

FIG. 1. TYPICAL CEILING AND FLOOR PANELS

Panel Details

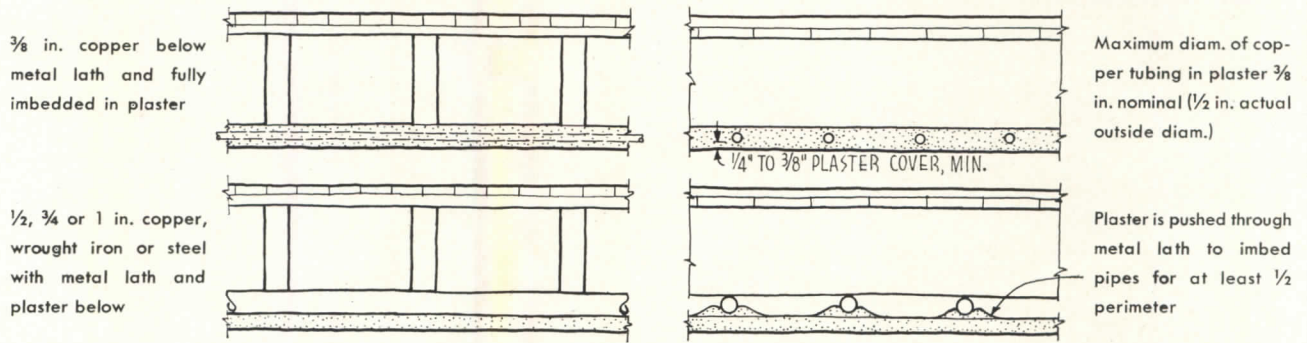

Either of the above ceiling types will perform as shown in A, B and C below

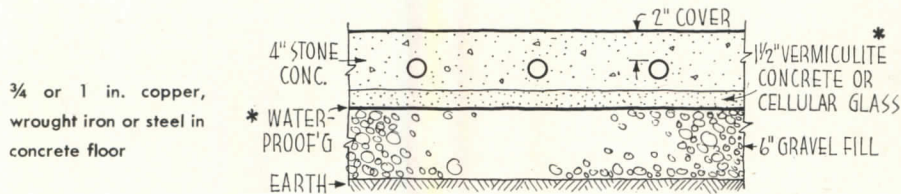

Floor Panel Performance as shown in D and E below

Panel Performance (based on above details)

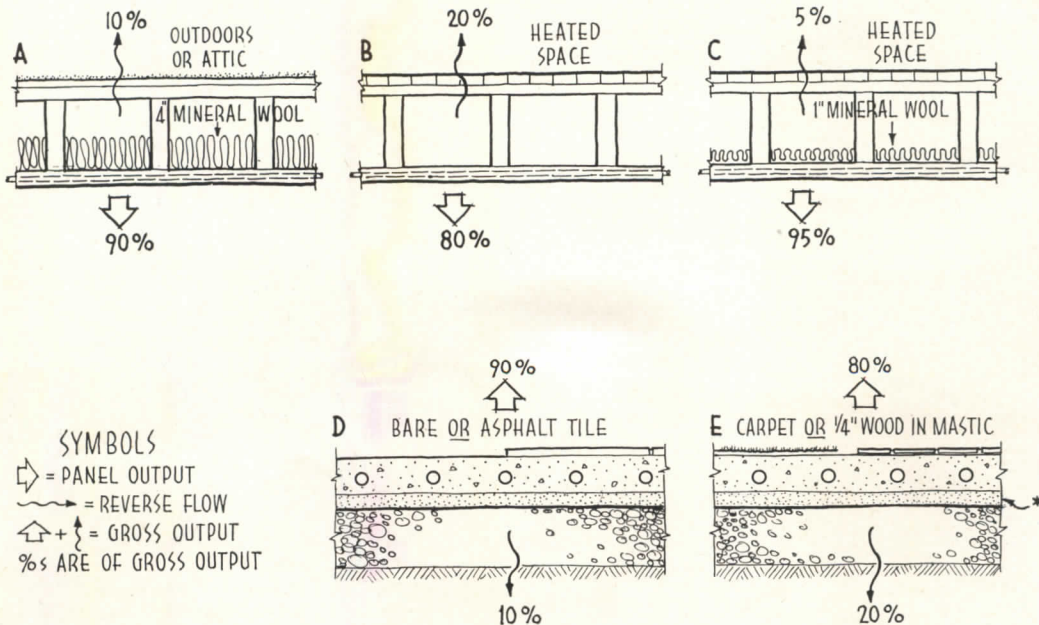

* Necessary only when slab is directly above ground water, heavy clay or rock. Otherwise may be omitted with negligible change in reverse flow.

Milcor self-supporting window stools with removable
facia panels installed in Boston University School of
Theology by Dillaby Fireproofing Co., Cambridge, Mass.

Architect: Cram and Ferguson, Boston, Mass.

General Contractor: Turner Construction Co., Boston, Mass.

Metal Trim Sub-contractor: Dillaby Fireproofing Co., Cambridge, Mass.

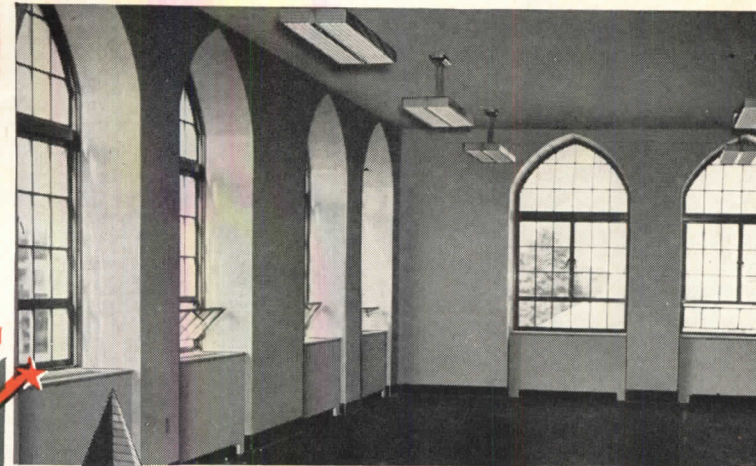

MILCOR* Steel Window Stools

...practical, permanent, and firesafe



Milcor Window Stools are
available in radius, flat, or
splay types, plain or
moulded, solid or grilled to
meet any requirement.

Milcor Steel Window Stools are *practical* — because they are economical to install, easy to clean and maintain . . . *permanent* because they are wear-resistant — can't warp, rot, shrink, or crack . . . and *firesafe* because they are made of steel!

The complete Milcor Window Stool line gives you an attractive selection, too—in a full range of styles, types and sizes to suit your specific interior design.

These handsome window stools may be used separately or together with Milcor Metal Window Trim, corner fittings, and other accessories. Look for full details in Sweet's, or write for a copy of the latest Milcor Manual.

*Reg. U. S. Pat. Off.

F-376

INLAND STEEL PRODUCTS COMPANY

Formerly Milcor Steel Company

4035 WEST BURNHAM STREET

MILWAUKEE 1, WISCONSIN

BALTIMORE 24, MD. — 5300 Pulaski Highway • BUFFALO 11, N. Y. — 64 Rapin St. • CHICAGO 9, ILL. — 4301 S. Western Avenue Blvd. • CINCINNATI 25, OHIO — 3240 Spring Grove Ave. • CLEVELAND 14, OHIO — 1541 E. 38th St. • DETROIT 2, MICH. — 690 Amsterdam Ave. • KANSAS CITY 8, MO. — S. W. Boulevard and State Line • LOS ANGELES 58, CALIF. — 4807 E. 49th St. • NEW YORK 22, N. Y. — 230 Park Ave. • ST. LOUIS 10, MO. — 4215 Clayton Ave.

RADIANT HEATING SYSTEMS FOR HOUSES: 3—Hot Water Systems

By William J. McGuinness Professor of Architecture, Pratt Institute

faces imbedded in the plaster. Fig. 2 shows three types of houses and two choices for panel locations in each case. Either (a) or (b) is possible for the basementless, one-story house. The one-story house with basement is served by either (c) or (d). The two-story basementless house can use (e) or (f). For concrete slabs directly on the earth, floor coils in the concrete are preferred. If, however, large heat loss or the need for fast response indicates a ceiling panel, the problem of the cold slab-on-ground may be solved by carpet or auxiliary perimeter floor coils.

Coils and Grids

Sinuuous coils (Fig. 3b) offer more resistance to the flow of water than grids but are easier to fabricate. They are almost universally chosen for residential work where coil lengths are not great enough to cause excessive friction. Grids find their largest use in industrial work where friction needs to be minimized in extensive piping.

Ferrous and Non-Ferrous Piping

The ruggedness of steel and wrought iron pipe recommends them for use in industrial jobs and for floor installation in residences. All connections within the panel must be welded. Copper tube, by its lightness and ease of bending, is well suited to ceiling installations. Solder consisting of 95 per cent tin and 5 per cent antimony should be used in sweat-fitting connections within the panel.

All of the materials mentioned will resist the corrosion commonly encountered. Since water is added in very small quantities, its corrosive action, if any, is quickly spent with little damage, and thereafter it is harmless. Corrosive action on the outside of pipes is a hazard which can be avoided by imbedment of pipes in weather-protected ceilings or in the concrete of slabs on dry, well-drained ground. Floor pipes must be kept out of the acid reaction of cinder fill.

While $\frac{3}{8}$ in. copper tube is often set below metal lath and buried in the plaster and larger ferrous piping cast in concrete slabs, the order can be reversed. It is entirely possible to use

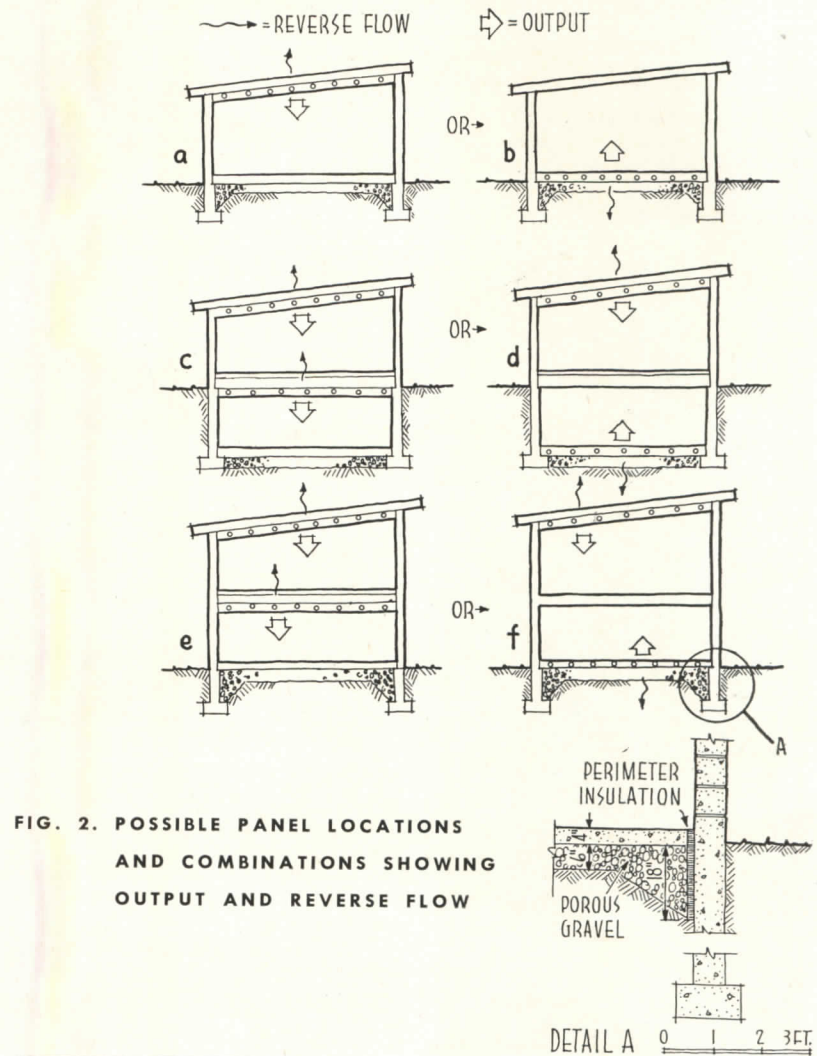
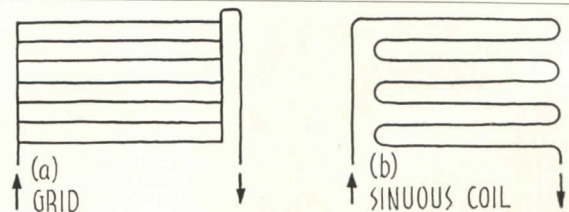

FIG. 2. POSSIBLE PANEL LOCATIONS AND COMBINATIONS SHOWING OUTPUT AND REVERSE FLOW

FIG. 3.

GRIDS AND COILS



ferrous pipe (usually $\frac{1}{2}$ -in. dia or larger) connected to the soffit of joists with metal lath and plaster below, the plaster being forced through to partially imbed the pipes (one-half perimeter is enough). Likewise, copper tube may be used in floors if care is exercised in protecting it until the concrete floor is set. The heat-emitting qualities of the several pipe materials when imbedded in the panel are comparable.

Layout and Circuits

Radiant heating, more than any

other system, must conform to the architectural and heating needs of the house. In layout work the following guides may be helpful.

(a) It is generally best when the warm ends of coils where the water starts are placed near glass or the perimeter of the house, and the cool ends toward the interior.

(b) Equalize as much as possible the length of all coils served by the same header. Short bathroom coils may be valved down later to avoid short-circuiting of the water.

"Factory-Traffic" Elevatoring

CIBA STATES LIMITED

Toms River, N. J.

Dyestuffs and other chemicals

Ciba Engineering Staff

Architects and Engineers

Turner Construction Company

General Contractors, Philadelphia

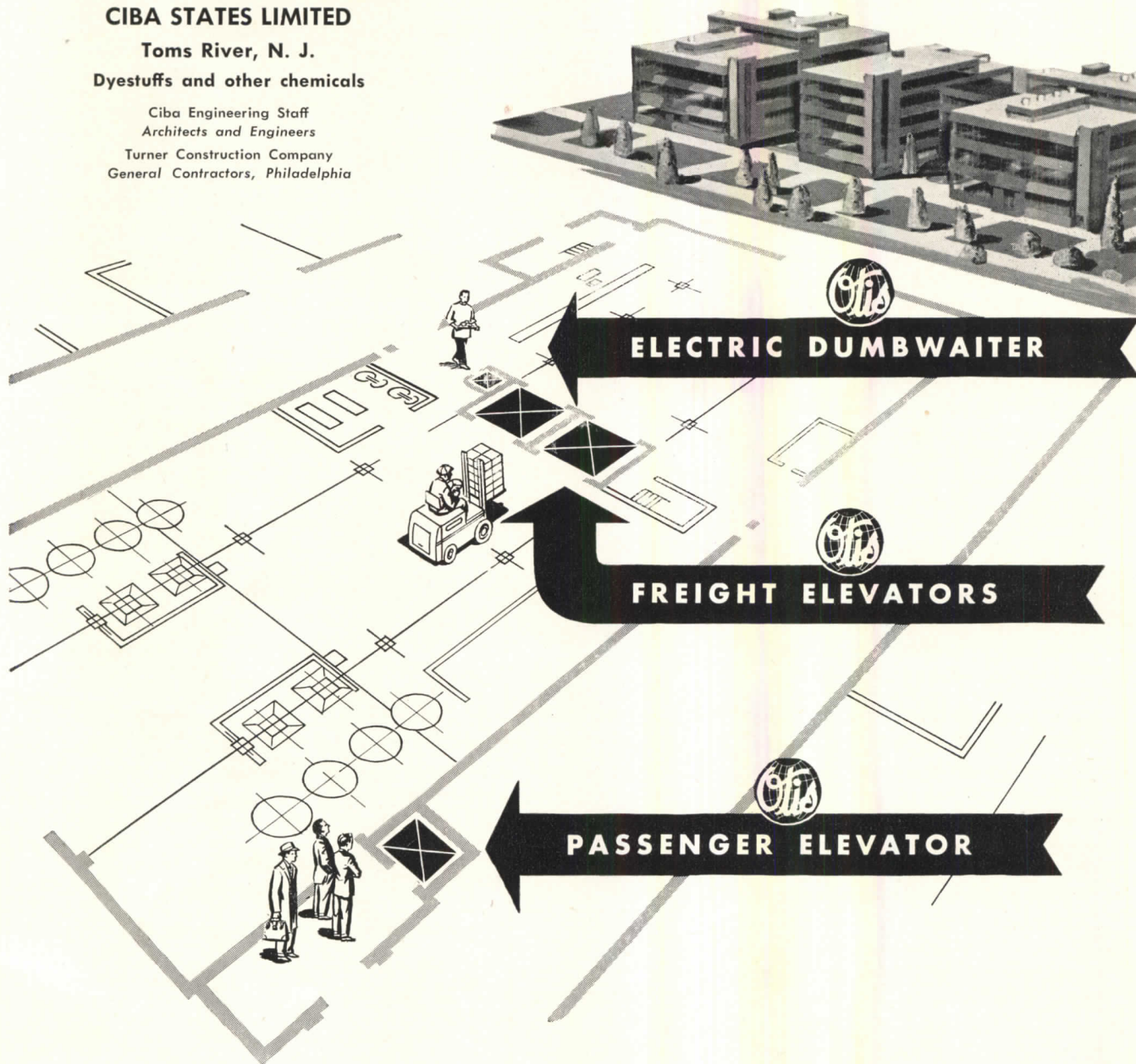

**Better elevatoring
is the business of**



This floor plan of the central building at CIBA's new Toms River Plant is typical of all three buildings. "Factory-traffic" ranges from industrial-truck freight handling to light-duty laboratory service.

OTIS elevatoring at Ciba includes 4 GENERAL-DUTY FREIGHT ELEVATORS (one with explosion-proof features), 1 FREIGHT ELEVATOR for industrial truck loading, 1 ELECTRIC DUMBWAITER and 1 PASSENGER ELEVATOR.

WHY DID CIBA BUY OTIS? Excellent 20-year service record of OTIS elevators in other Ciba plants . . . the ability of OTIS to assist on all problems of vertical transportation . . . the fact that all the equipment is OTIS designed, manufactured, installed . . . that OTIS assumes responsibility for the entire installation.

For further details of OTIS equipment, see SWEET'S Architectural File. Or, call your local OTIS office. Otis Elevator Company, 260 11th Avenue, New York 1, N. Y.

RADIANT HEATING SYSTEMS FOR HOUSES: 4—Hot Water Systems

By *William J. McGuinness* *Professor of Architecture, Pratt Institute*

(c) Keep the coil lengths within the recommended approximate friction limits.

Nominal Diameter	Coil Length	
	Tube	Pipe
3/8 in.	120 ft	—
1/2 in.	150 ft	250 ft
3/4 in.	250 ft	350 ft
1 in.	500 ft	500 ft

(d) The coils should be in a plane. Pipes must not cross within the panel. Maintain the spacing in all supply and return runs within the panel.

(e) Generally, the entire ceiling or floor is used instead of a small portion of those areas. Pipes may be spaced closely near the glass areas and wider near the interior.

(f) Place all balancing and vent valves in accessible places. They may be at the ends of coils, near headers.

(g) Effective insulation between ceiling coils and roofs is necessary to minimize reverse flow. The reverse flow to other heated space is credited to that space in designing other panels. This condition is illustrated in Fig. 2 (c) and (e). In both of these cases, the under-the-roof panels can have a reduced output. Fig. 1 (c) shows insulation used to diminish this flow if separate zoning and control of the upper story is desired. In this case, 1 in. of rockwool is enough; 4 in. are not needed.

(h) Ease of fastening ceiling coils is accomplished if the pipes run at right angles to the joists.

(i) In floor slabs, wire mesh is of some advantage in preventing cracks but is not essential if the earth is properly compacted.

(j) Avoid when possible, placing warm coil supply lines directly adjacent to cool return lines, particularly in plaster. Cracking may result if the temperature difference is large.

Basic Assumptions

It will be noted that this presentation is briefer than most of the texts and handbooks of design on this subject. It is well to state the limitations in its use and the assumptions upon which it is based.

1. **Occupancy.** Radiant systems may

be used in a variety of structures. The design conditions in such varied occupancy as airplane hangars, gymnasiums, factories and houses differ widely. It is intended to present information for use in houses only. Large residences and 2 or 3 family houses may be included, but not enough data are given to design the heating for apartment houses.

2. Panel Type and Location. A great many different panel types are possible. For simplicity, two ceiling types and one floor type are suggested and the data given apply to them only. The ceiling panel output varies according to the insulation and the floor output according to the floor covering. For some additional cost, the response of floor panels may be improved and the reverse flow reduced slightly by the use of an insulating layer under the whole slab.

3. Perimeter Insulation. In all floor slab installations, it is assumed that 18 in. deep of 1 in. water-proof fibre board or cellular glass separates the slab from the concrete foundation wall and that the 6-in. gravel fill thickens to 18 in. at the perimeter. This, or its equivalent, is mandatory in good practice. See Detail A, Fig. 2.

4. Panel Surface Temperatures. Many systems of design establish

first a required panel temperature and then select the conditions to assure it. Since there is much difference of opinion about desirable limits of temperature and indeed even about the probable output for any given temperature, *outputs* only are discussed and they are kept within safe limits.

5. Pipe or Tube Spacing. For fixed water temperatures and pipe or tube diameters, the output varies depending upon the linear ft of pipe or tube per sq ft of panel. Actual efficiency improves with wider spacings and decreases with closer spacings. Except in refined calculations, this may be neglected.

6. Units for Expressing Output. Design tables often read in output per sq ft of panel surface. Others read in output per linear ft of pipe. The latter system is chosen here but it is necessary that an arithmetic check be made on the output per sq ft of panel, so that it is kept within the stated limits.

7. Effect of Metal Surface Area on Output. For the same nominal diameter, ferrous pipes have a larger outside perimeter than copper tubing. Theoretically, a different output might be expected. An average output is stated in Table 1 which can apply to either material.

TABLE 1. Gross Output (including reverse flow)

Btu/hr/lin ft of pipe or tubing at avg. water temp. (135 F)
For other temps., apply correction factors shown below

Nominal tube or pipe Diam. -in.	PLASTER CEILINGS			CONCRETE FLOORS	
	Coil Location	Output Btu/hr/lin ft	Suggested limits tube or pipe spacing in. o.c.	Output Btu/hr/ft	Suggested limits tube or pipe spacing in. o.c.
3/8	Coils Below Lath	24	4 1/2 to 9*	36	4 1/2 to 12
1/2	Coils	30	4 1/2 to 9	43	6 to 16
3/4	Above	41	6 to 9	57	9 to 20
1	Lath	51	6 to 9	72	9 to 24

Important Note: The NET output, Btu/hr/sq ft of panel surface, must not exceed 75 for ceilings or 55 for floors unless special conditions justify it.

* Space in ceilings in excess of 9 in. may cause surface discoloration

CORRECTION FACTORS. For avg. water temps. other than 135 F, correct gross outputs as shown

Avg Water Temp (F)	100	105	110	115	120	125	130	135	140	145	150
Multiply gross output by:	.46	.54	.62	.69	.77	.85	.93	no change	1.08	1.16	1.22

**POMONOK HOUSES
QUEENS, N. Y.**

Jarcho Bros. Inc., Heating Contractors, Long Island City, N. Y.; Voorhees Walker Foley & Smith, Architects and Engineers, New York City; Meyer Strong & Jones, Mechanical & Electrical Engineers, N. Y. C.

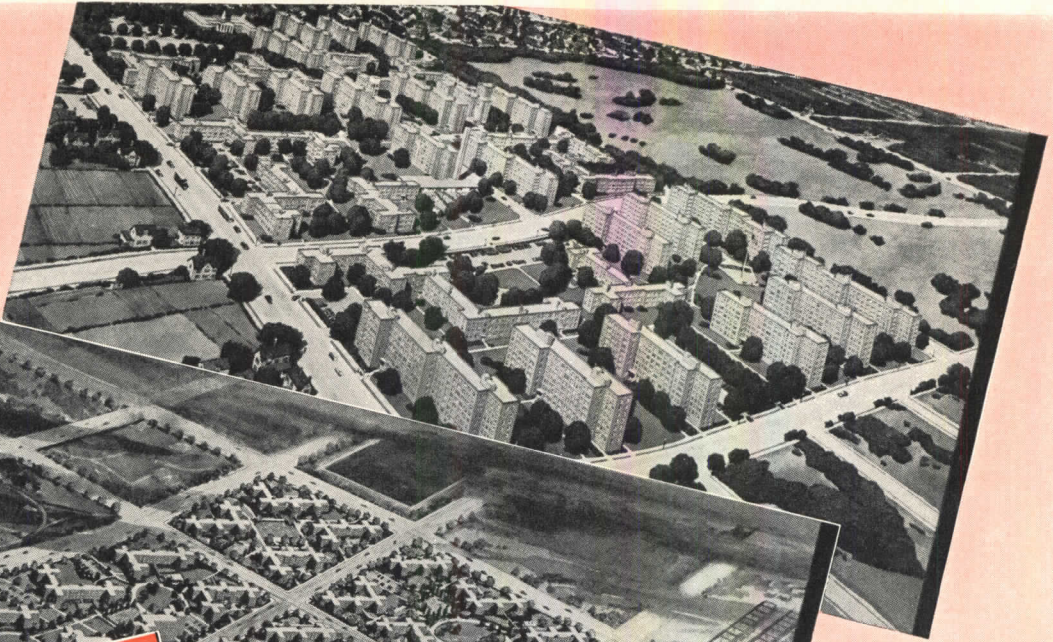

31,756 radiator traps and valves as shown below will control the steam to radiators and convectors. Other Sarco specialties include 605 float-thermostatic traps with strainers for risers and main drips.

**BREUKELN HOUSES
BROOKLYN, N. Y.**
Afgo Engineering Corp., Heating Contractors, Brooklyn, N. Y.; William I. Hohausler, Architect & Engineer, New York City; Sullivan A. S. Paterno, Consulting Engineers, New York City.

SARCO heating specialties to be used in 3 NEW YORK CITY HOUSING PROJECTS

Seventy-two apartment buildings to house 4,074 families are being equipped with SARCO HEATING SPECIALTIES to insure trouble-free operation.

Two of the three projects are illustrated above. The third is James A. Bland Houses, Flushing, for which the architects are Chapman, Evans and Delehanty of N. Y. C. Syska and Hennessy, Inc. of N. Y. C. are the consulting engineers. H. Sand & Company, Inc., also of N. Y. C., are the heating and ventilating contractors.

For dependable, efficient service over the years, specify SARCO. Write for new Catalog 202, on the complete line.

SARCO COMPANY, INC.

EMPIRE STATE BUILDING, NEW YORK 1, N. Y.

SARCO CANADA LTD., TORONTO 5, ONTARIO

REPRESENTED IN PRINCIPAL CITIES

SARCO Radiator Trap
Type H

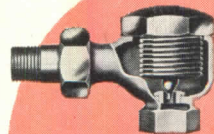

SARCO Radiator Valve
No. 1141

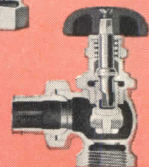

RADIANT HEATING SYSTEMS FOR HOUSES: 5—Hot Water Systems

By William J. McGuinness Professor of Architecture, Pratt Institute

FIG. 4. DESIGN ITEMS AND THEIR DETERMINING FACTORS

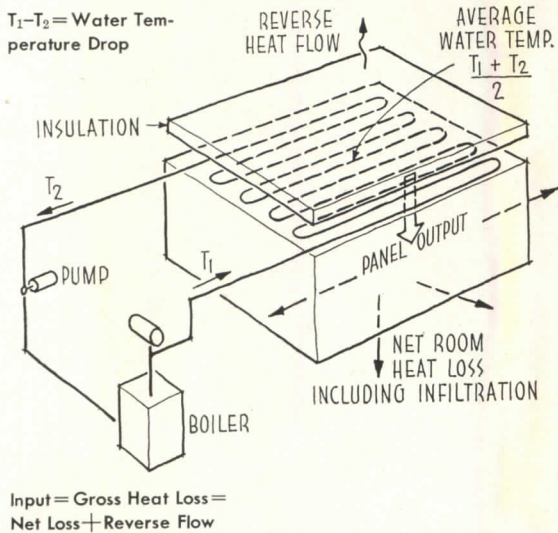
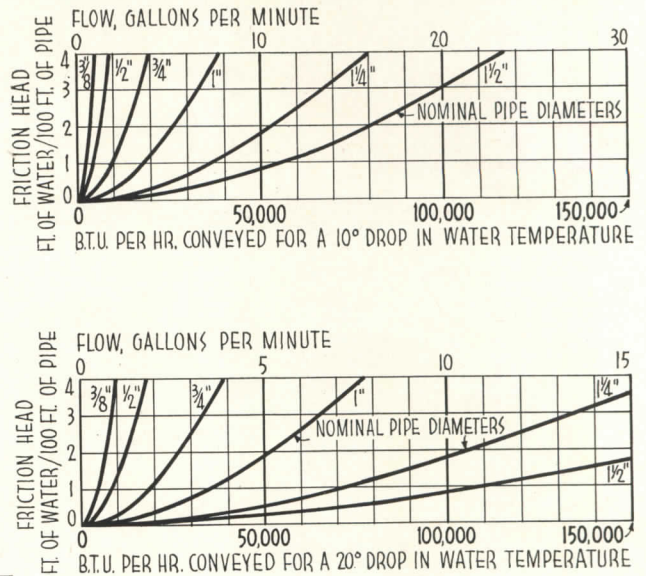

FIG. 5. HEAT CAPACITY, FLOW AND FRICTION



ITEM	FIXED BY
Required Panel output Btu/sq ft/hr	Net room heat loss ÷ panel area High Limits (Btu/sq ft/hr) Ceilings 75 Floors 55
Actual Panel Output Btu/sq ft/hr	Avg water temp, pipe size, lin ft of pipe per sq ft of panel (Must not exceed above limits)
Reverse Flow	Kind of panel and insulation behind it
Gross Output (Entire Panel)	Net room heat loss (total panel output) plus reverse flow
Choice of Temp Drop	Size of piping (ceilings 20 deg, floors 10 deg)
Water Flow (gallons per minute)	Gross output and temp drop
Pipe Friction	Total equivalent length of pipe, water flow and pipe size
Pump Rating	Water flow (gal per min) and total friction in longest run (ft of head)
Boiler Rating	Gross output
Compression Tank Capacity	Water volume and temperature rise

8. Water Temperatures. Curves and tables are frequently issued for each of the possible average water temperatures with outputs varying accordingly. For brevity, Table 1 is based on 135 deg only. This temperature is chosen quite arbitrarily. The correction factors must be applied for all other temperatures.

9. Limitations on Table 1. It is apparent that the scope of Table 1 is such that conditions of temperature, size and spacing may be selected resulting in sq ft outputs above the ideal limits. It is understood that adjustments must be made to maintain these limits. The spacings are suggested only and can be varied except

for the upper limit of 9 in. for ceilings. Greater spacing is inadvisable in plaster.

10. Mean Radiant Temperature. This is an important item in many design manuals intended for use in a wide variety of structures. However, since this article is limited to residential design in which the MRT (average temperature of room surfaces) does not vary greatly, detailed calculations are not necessary. Table 1 is based upon an MRT of 70 deg which is on the safe side and usually results in a slight overdesign.

11. Heat Carrying Capacity of Pipes. The differing surface and inside dimensions of steel, wrought iron and copper affect somewhat their heat carrying capacities for the same nominal size. While Fig. 5 is based on the qualities of black iron pipe it can be applied without appreciable error to other materials.

Note. The effect of the above standardizations and short cuts have been well considered and they are in accord with acceptable practice. They may be used with confidence. Slight variations in performance can be adjusted by a change in water temperature or adjustment of flow by balancing valves.

PRODUCTS

(Continued from page 159)

**A NEW LINE
OF
PACKAGED
POWERSTAT
LIGHT DIMMING EQUIPMENT**

Yours

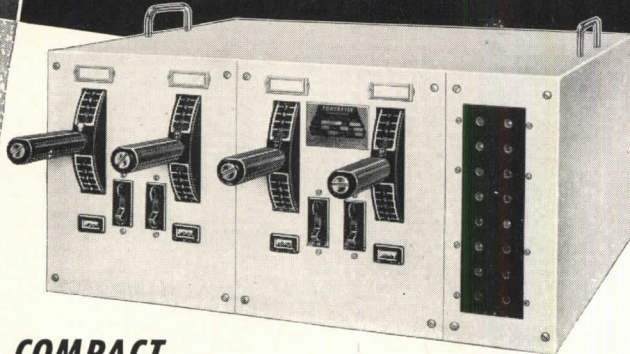

**COMPACT
PACKAGED ASSEMBLIES WITH COMPLETE
FACILITIES FOR DIMMING, BRIGHTENING,
BLENDING LIGHT**

The popular economy line of **PACKAGED POWERSTAT** light dimming equipment has been redesigned and a variety of new models offered. Assemblies of the 2000 watt series are now available in packages of 3, 4, 5 and 6 unit dimmers.

Each packaged assembly is housed in an attractive smooth grey finished cabinet. Individual dimmers are operated by vertical hand levers with graduated drums. The levers can be interlocked for master control and when required a separate master handle can be provided. Each dimmer has its own on-off switch and circuit-breaker, card holder for circuit identifications and pilot light. These dimmers can be operated from a two wire — one phase, a three wire — one phase or a four wire — three phase a-c power source. Standard output connectors include a terminal board for solid connection, pin-jacks, parallel-blade receptacles and twist-lock receptacles. Send for Bulletin D651P to learn more about **PACKAGED POWERSTAT** light dimming equipment.

**PACKAGED POWERSTAT DIMMERS IDEAL
FOR SCHOOLS, CHURCHES, LODGES, HOTELS,
RESTAURANTS, STORES, LOUNGES & CLUBS.
WRITE FOR DESCRIPTIVE BULLETIN TODAY**

THE SUPERIOR ELECTRIC CO.
BRISTOL, CONNECTICUT



9081 DEMERS AVE., BRISTOL, CONNECTICUT

Please send me Bulletin D651P

NAME _____

COMPANY _____

CO. ADDRESS _____

CITY _____ ZONE _____ STATE _____



this unit purifies water at the rate of 400 gal. per hour. Installation procedure consists of connection to the main water inlet, and connection to a standard electrical source. Sepco Corp., Pottstown, Pa.

Compact Range

A compact electric range, measuring 30 in. wide is claimed to introduce completely automatic cooking. Two ranges, gas and electric, display the same features: automatic oven, glass bottom broiler, four burners and divided cook top. It is stated by the manufacturer that "broiling over glass" will give better broiling results. The unit is finished with porcelain enamel. Aluminum reflector bowls are situated under the burners to utilize the maximum of

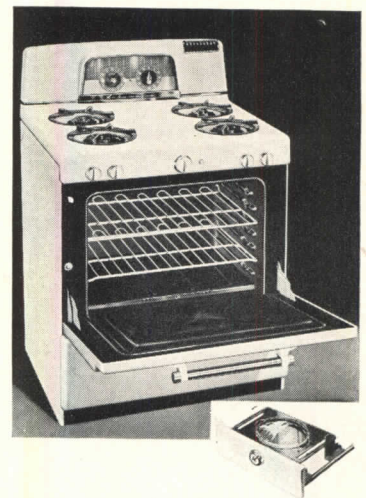

New ranges feature glass broiler (inset), automatic operation. Gas model is shown

heat. The oven is insulated with Fiberglas, and is 23 in. wide. A storage drawer is provided for cooking utensils. Overall size 30 in. wide, 25 in. deep, 36 in. to cooking top. Oven 23 in. wide, 16 in. deep, 16 in. high. Storage drawer 19 in. deep, 23 in. wide, 6 in. high. Shipping weight approx 200 lb. Kalamazoo Stove and Furnace Co., Rochester Ave., Kalamazoo 6-D, Mich.

(Continued on page 174)

*The Right Combination
for Perfect Flooring Jobs!*

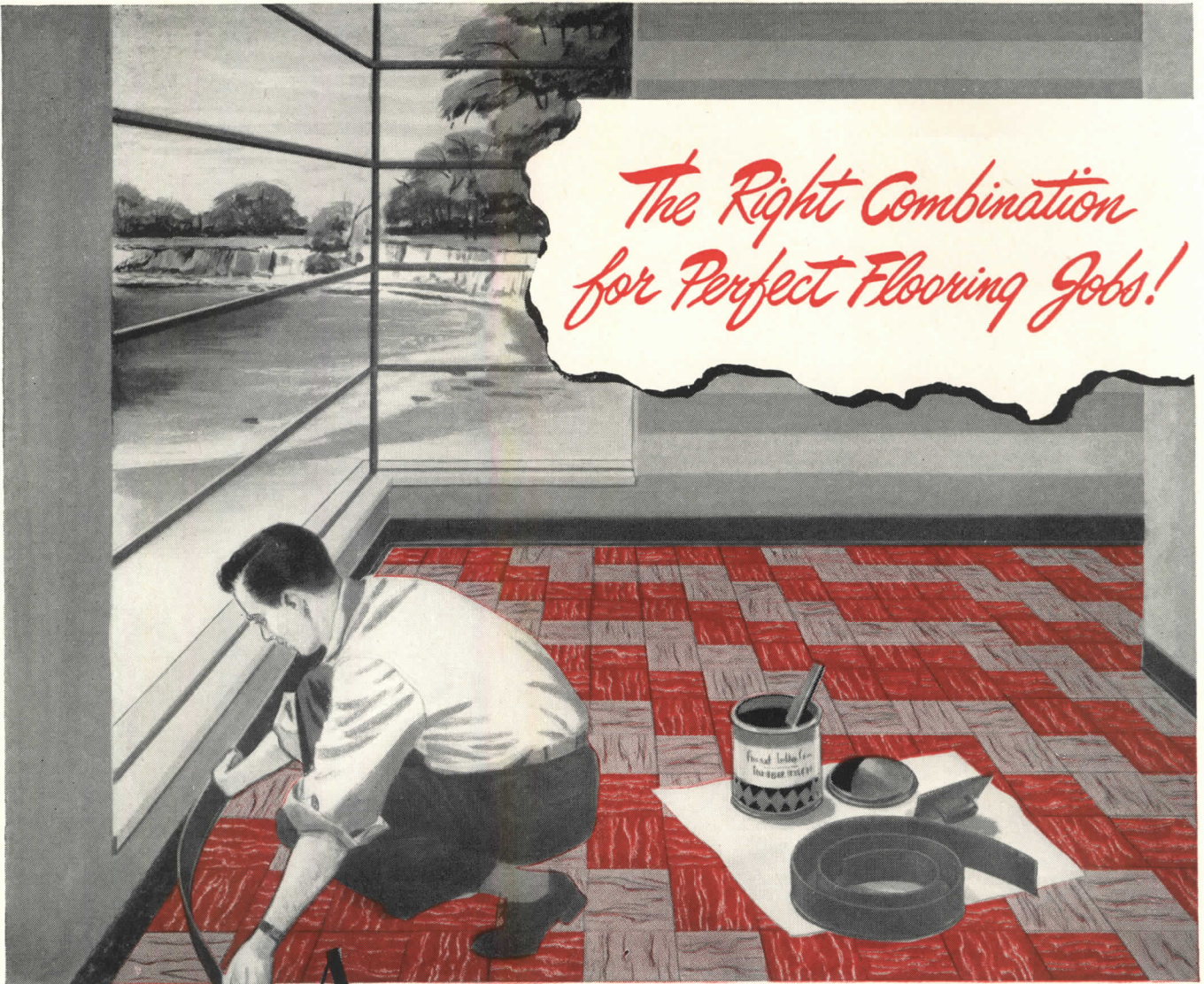

Rubber Tile Patterns: 401 (SA), 800 (XZA)

A *FREMONT "Package" of
Rubber Tile... Adhesive... Colorful Cove Base Trim!*

Color harmony... ease of installation... durable, fade-resistant flooring jobs, plan the Fremont Package. Cove Base Trim in continuous lengths and nine new colors, rubber tile and the finest adhesive obtainable give you the best resilient flooring job there is. Complete it next time... with Fremont Products that look and work well together.

Fremont Rubber Company

309 McPherson Highway, FREMONT, OHIO

WATCH FOR NEW
FREMONT PRODUCTS



Sponge Rubber
Rug Cushion



Vinyl Plastic
Cove Base



Plastics

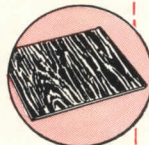

Rubber Tile

GENTLEMEN:

Please send me without obligation your newest literature on Fremont products.

NAME _____

FIRM NAME _____

ST. ADDRESS _____

CITY _____ STATE _____

PRODUCTS
(Continued from page 172)

Measure
ALUMINUM
by these yardsticks

- ✓ UTILITY
- ✓ APPEARANCE
- ✓ INVESTMENT VALUE

You can get these advantages plus specialized help from the Reynolds Architectural Service

When planning your next design, stop and ask yourself what other metal offers the advantages that you find in aluminum. Unlimited design flexibility... widest range of finishes... light weight... great strength... rust and corrosion resistance. All these factors mean aluminum is the ideal material for your specifications.

Even though the supply of aluminum for building is limited now, the assistance of Reynolds Architectural Service is still yours for the asking. This service is an efficient and economical solution to your design problems. For complete information, call the Reynolds office listed under "Aluminum" in your classified telephone directory.

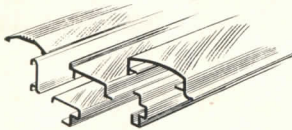

EXTRUDED SHAPES

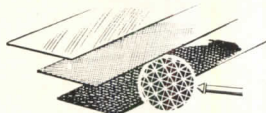

SHEET

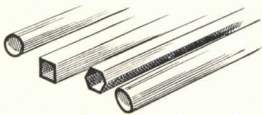

TUBULAR PRODUCTS

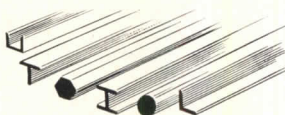

STRUCTURALS

FREE BOOKLET!

Send for your copy of Reynolds Architectural Folio today! A complete, up-to-date kit on architectural aluminum. In loose leaf form. Free when requested on business letterhead. Write to Reynolds Metals Company, 2572 South Third Street, Louisville 1, Ky.

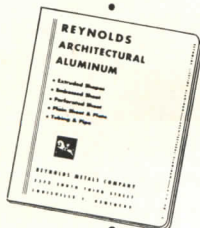

ORNAMENTAL CASTINGS
produced to your specifications by independent foundries from Reynolds Aluminum ingot.

Hydraulic Lift

Specially designed for speed, a 20,000 lb capacity hydraulic lift is used by the Cincinnati Fire Department to "launch" an amphibious jeep, normally stored 13 ft below street level.

An electric pump provides oil pressure to a hydraulic cylinder, 15 3/4 in. diameter. In addition to lifting the jeep, the elevator opens two steel shaftway doors weighing 7500 lb. Globe Hoist Co., Mermaid Lane at Queen St., Philadelphia 18, Pa.

High Frequency AC Generator

Capable of developing 75 KVA and generating 400 cycles at 1714 rpm, this generator offers applications in many situations where electrical supply by other means is impractical or where electricity is not as yet provided.

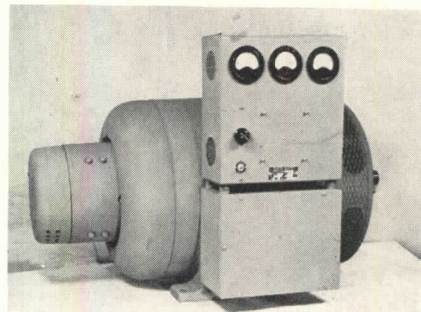

New generator is compactly designed, has self-cooled operation

To combat overheating, the unit is equipped with a fan which is claimed to hold the temperature rise to less than 40 deg C. The net weight of the unit is 1325 lb; overall length is 49 in.; height 21 1/2 in.; width 21 in. This generator is available in both single and three-phase models, the most common voltage being 110/220 volts, single phase, or on the three phase model, higher frequencies are available by changing the operating speed of the winding. These generators are available with both "engine-drive" and "motor-drive". Kato Engineering Co, 1415 First Ave, Mankato, Minn.

(Continued on page 176)



REYNOLDS ALUMINUM

MODERN DESIGN HAS ALUMINUM IN MIND



Do you specify

TACK MARKS?

YOU DO if your clients' carpets are installed by the old fashioned turn-and-tack method.

FOR FLAWLESS CARPET BEAUTY SPECIFY

Smoothedge

TACKLESS INSTALLATION



NO TACK MARKS HERE

Smooth flowing beauty at carpet edges, even at doorways and hearths. No ugly tack marks, scallops, dirt-catching indentations or ridges.

Specify *SMOOTHEDGE Tackless Installation.*

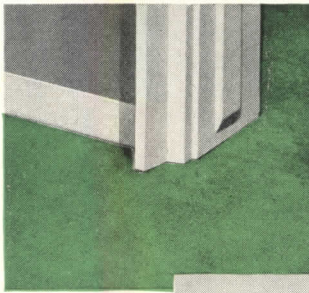

AVOID THIS

Tack marks never improved the appearance of lovely wall-to-wall carpet. Even the best turn-and-tack job can't hide these hard-to-clean indentations.

Specify *SMOOTHEDGE Tackless Installation.*



HOW SMOOTHEDGE WORKS

SMOOTHEDGE gripper holds the carpet firmly and *invisibly* from beneath. Carpet is securely hooked at one wall, then stretched and hooked at the opposite wall.

Tack marks, ripples and lumps are eliminated — you see nothing but beautiful carpet.

And when you want the carpet up it's as easy as opening a zipper.

No special provisions are required in plans for either wood or concrete floors.

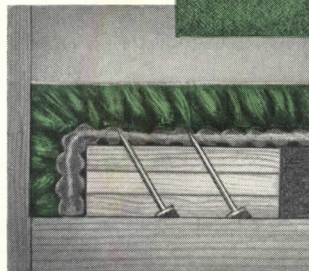

EASY TO SPECIFY — AVAILABLE NATIONALLY

Handled by over 4,000 carpet retailers and by 68 carpet distributors. Recommended by leading carpet mills for wall-to-wall carpet installation.

THE ROBERTS CO. Dept. AS-8

1536 N. Indiana St., Los Angeles 63, Calif.

Please send me Smoothedge A.I.A. file

Installation Manual Names of nearest contractors

Name _____

Address _____

City _____ Zone _____ State _____

SEND FOR FULL DETAILS, A. I. A. FILE AND NAMES OF INSTALLATION CONTRACTORS NEAREST YOU

Here's Why
Smart Owners Say:

LET'S USE
CORRUFORM!



...the ONLY engineered form for light concrete floor and roof slabs, with reliable strength and adequate safety margin for normal construction loads!



ATTRACTIVE, permanent Corruform is furnished galvanized and/or vinyl-primed (ready to paint) for exposed joist construction—or in natural, black sheets for unexposed joist construction.



DURABLE Corruform is nearly twice as strong as ordinary steel of equal weight. It's an ideal vapor seal, too! With coated Corruform, insulating slabs serve better, last longer.

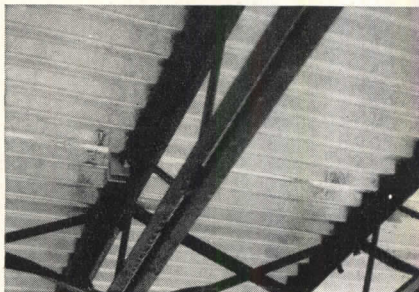
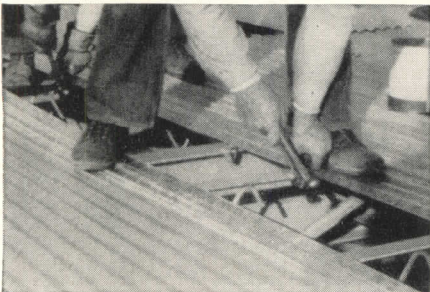
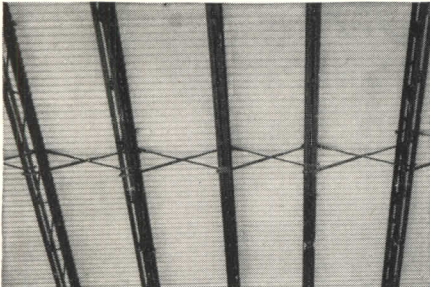

ECONOMICAL Corruform eliminates waste. Light rigid sheets quickly placed won't bend, sag, stretch, or leak. The concrete you save actually pays for CORRUFORM. Clean-up time and expense are minimized, too!



SAFE Corruform provides an extra-tough, secure steel base for trades and concrete... a form which maintains structural principles and integrity, with no side pull on joists, beams or walls.

For Good-Looking Exposed Joist Construction, Always Specify
CORRUFORM Tough-Tempered Steel

SPECIFICATION

Guaranteed average strength over 100,000 psi and certified minimum strength for single test over 95,000 psi. Weight .72 lbs. per square inch.

GRANCO STEEL PRODUCTS CO.
(Subsidiary of GRANITE CITY STEEL CO.)
GRANITE CITY, ILLINOIS

SEND FOR
FREE AIA
FILE TODAY!



Architectural Engineering

PRODUCTS
(Continued from page 174)

Wall Coverings

• An easily applied, flexible wall covering backed by a neoprene impregnated felt is offered in a ceramic tile pattern. The use of three shades of the same basic color upon *Neo-Felt* aids the simulation of ceramic tile. An item of interest is the alkali resistant paint that is applied to the neoprene backing. The product is flexible enough, the producer states, so that assembly, handling, and cutting are simplified. A choice of six colors in 54 in. widths is given. Sloane-Blabon Corp., 295 5th Ave., New York 16, N. Y.

• A wood product, *Novoply*, introduces a novel veneer method. The outer surface of this panel consists of 1/16 in. wood chips applied upon an inner core of medium wood chips; the panel is faced on both sides with this material. The entire

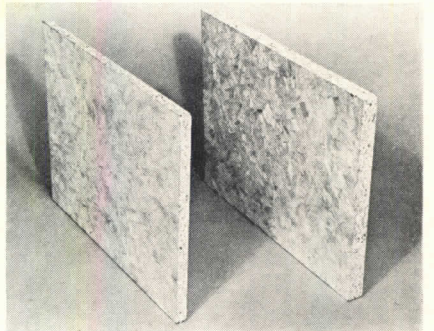

Compressed wood chips are used in new interior wallboard panels

panel is fused together by heat and pressure. The dimensional stability of the product leads the producer to suggest its application as sliding doors, wall panels, or as a base for the application of other materials.

The material's strength is sufficient for all applications other than those that are not structurally supported. It is waterproofed but is not intended for exterior applications. It is available in sizes 48 by 96 in. and 72 by 144 in. and in two thicknesses — 3/8 and 3/4 in. United States Plywood Corp., 55 West 44th St., New York 18, N. Y.

(Continued on page 180)

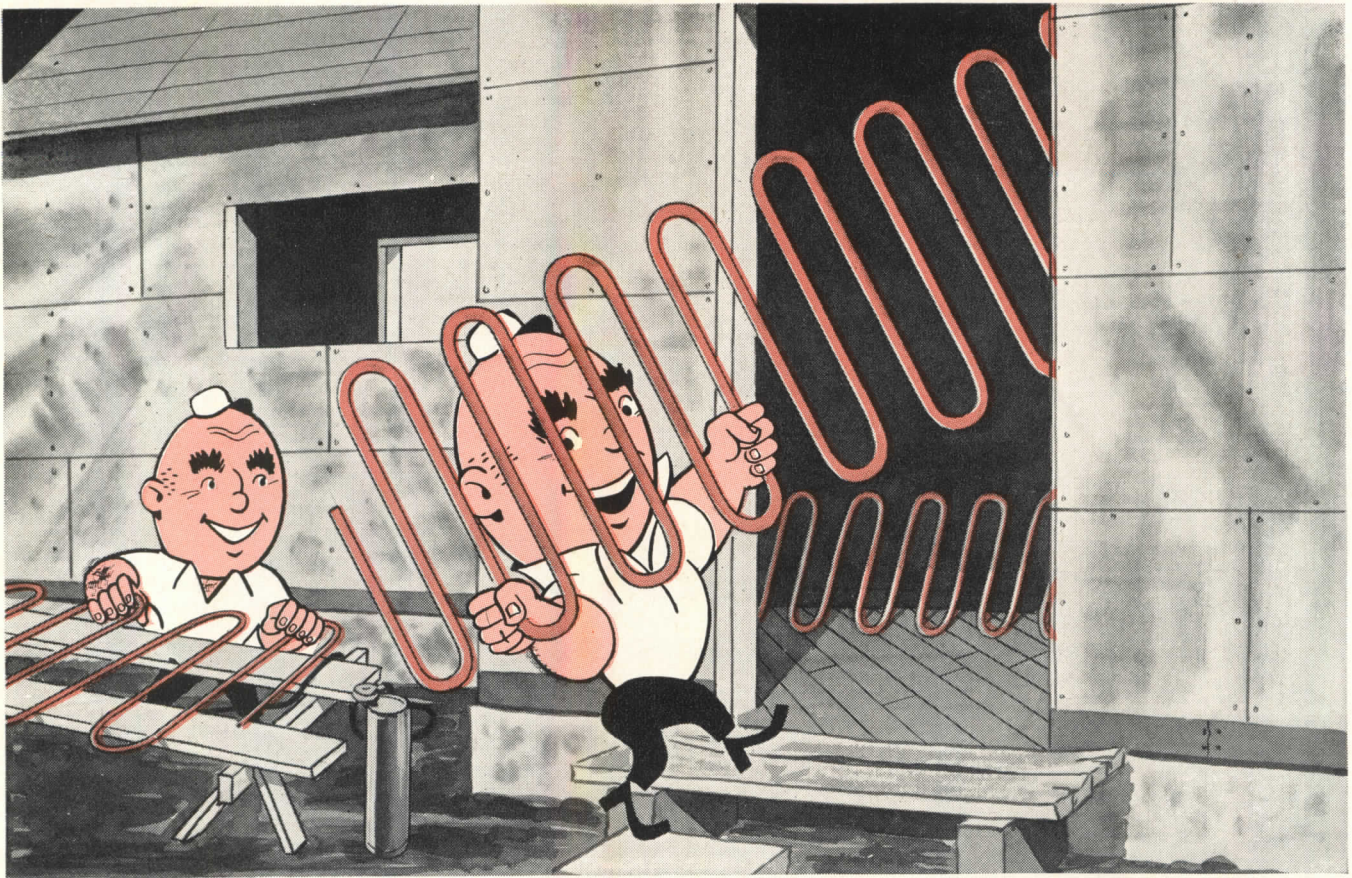

Bundyweld . . . right in your homes for better radiant heating

Unique construction, unique advantages—that's why!

Bundyweld is the only tubing double-walled from a single strip. It's extra-strong. Copper-brazed through 360° of wall contact, it's leakproof. It's double-walled, yet thinner-walled . . . *right* for faster-heating, more effective systems in your houses.

It's *right* for easier handling, too, on your building site. From its arrival in twenty-foot lengths (one end expanded when specified) to final installation in your ceilings, walls,

or floors, tough Bundyweld rides over jolts, knocks, and jars. On a simple fixture, one man easily bends ductile Bundyweld to short radii, with no danger of structural collapse. Formed grids are easily joined, joined grids quickly positioned.

Briefly, when Bundyweld goes to work on your job, time, labor, materials savings, and better all 'round radiant heating go with it. Check Bundyweld today. For details, see *Sweet's Architectural File*. Or write: **Bundy Tubing Company, Detroit 14, Michigan.**

Bundyweld Tubing

DOUBLE-WALLED FROM A SINGLE STRIP

WHY BUNDYWELD IS BETTER TUBING



Bundyweld starts as a single strip of basic metal, coated with a bonding metal. Then it's . . .



continuously rolled twice around laterally into a tube of uniform thickness, and

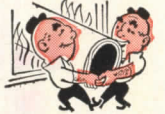

passed through a furnace. Bonding metal fuses with basic metal, presto—

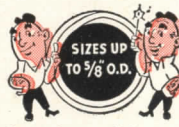

Bundyweld . . . double-walled and brazed through 360° of wall contact.

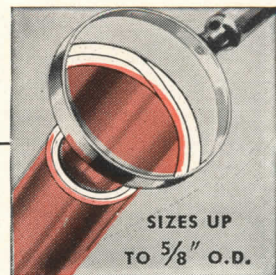

SIZES UP
TO 5/8" O.D.

NOTE the exclusive patented Bundyweld beveled edge, which affords a smoother joint, absence of bead and less chance for any leakage.

PRODUCTS

(Continued from page 176)

Area Light Source

Utilizing an "area" light source in contrast to the line of point sources of present methods of lighting, *Panelite* offers many architectural applications. The manufacturer suggests its use in illuminated ceilings, cocktail lounges, elevators, and theaters. While panels

have been developed in yellow, blue, and white, the only color commercially available at this time is green.

Instead of a bulb or a filament this unit is related to the condenser. A sheet of glass is coated with an invisible conducting coat, then a coat of phosphor-dielectric, finally a coat of vaporized aluminum is sprayed upon the dielectric coat. Separate leads are connected to the conductive layer on the glass and to the conductive aluminum layer. The unit is then connected to a standard a-c line. Light is produced by the electrical

"excitation" of phosphorus particles in the dielectric.

The unit develops sufficient brightness for decorative applications. Greater applications of voltage develop greater intensities. This stage is still under exploration and is not commercially available at this time, the manufacturer states.

The intensity of the unit varies directly with the voltage applied, the amount of voltage applicable is, of course, dependent upon the strength of the dielectric-phosphor used. At present



AMWELD

▶ **INTERIOR STEEL
DOORS, FRAMES
and
▶ SLIDING CLOSET
DOOR UNITS ★**

**ARCHITECTS
SPECIFY THEM**

**BUILDERS
PREFER THEM**

**OWNERS
ENJOY THEM**

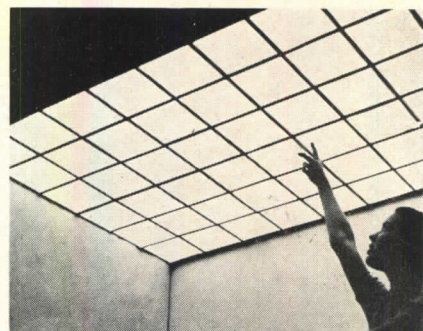

Recently developed area lighting source gives cool, economical operation. Above: ceiling application. Below: stair lights



AMWELD BUILDING PRODUCTS are designed and built to blend with all types of construction, provide lasting beauty, and cut building costs. May we send our catalog describing styles, sizes and complete specifications for your consideration?



★ Sliding closet door units are available in two styles. (1) Frames are 1-piece welded assembly or (2) with header, jambs and track in knocked-down form. Door panels are identical. Both are complete with all hardware.

BUILDING PRODUCTS DIVISION

THE AMERICAN WELDING & MANUFACTURING CO.
340 DIETZ ROAD • • WARREN, OHIO

two types are being manufactured, 120 and 500 volt panels. The unit is provided with a small step-up transformer where a greater voltage is desired. The temperature of the unit is unnoticeable to the hand; a slight increase of temperature is anticipated with the future development of greater intensities.

The expense of operation of a 4 ft by 6 ft panel is comparable to that of a 25 watt bulb the manufacturer claims. A 120 volt panel operates at 8 milliamperes per sq ft, while a 500 volt panel operates at 15 milliamperes per sq ft, it is claimed. Sylvania Electric Products Inc., 500 Fifth Ave., New York 18, N. Y.

(Continued on page 182)

**A NEW KIND
OF FIRE-INSURANCE
saved this church**

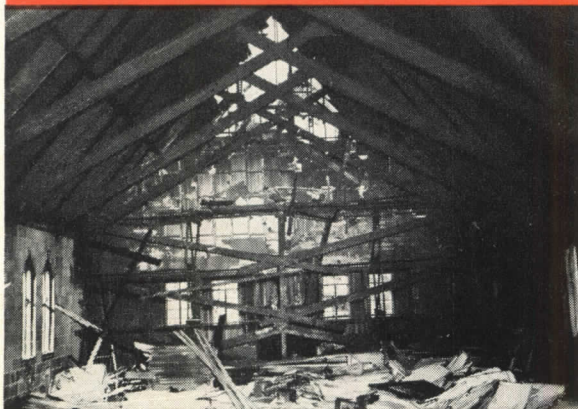
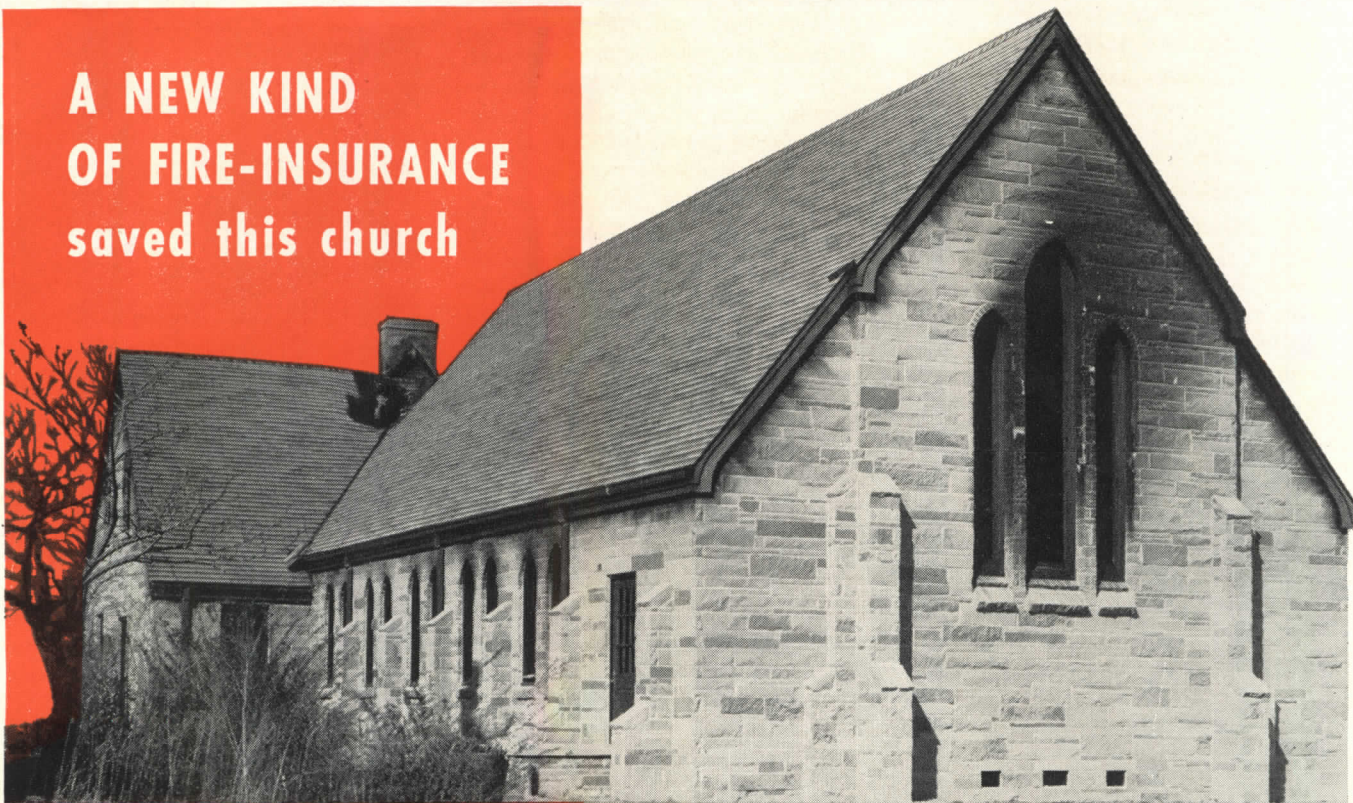

CAREY FIRE-CHEX SHINGLES

With interior gutted by fire, this church at Rose Hill, N. C. still stands — a tribute to the amazing fire-resistance of Carey Fire-Chex Shingles!

Despite intense heat and flames which gutted the interior of the Mt. Zion Presbyterian Church at Rose Hill, N. C., the Carey Fire-Chex roof remained virtually intact! Even when a section of the roof collapsed after supporting members burned through, Carey Fire-Chex shingles *prevented spread* of fire to adjacent roof areas and certain destruction of the entire building!

Carey Fire-Chex, made of a new, patented asbestos-plastic, are the first and only shingles ever to win Underwriters' Laboratories, Inc. highest fire-protective rating—CLASS A*. And, in addition to unequalled fire safety, Fire-Chex also offer longer life, greater beauty. Made extra-thick (weight 325# per sq.) for extra wind and weather protection, Fire-Chex feature new shadow-blend beauty—create roof designs copyrighted as works of art.

Give your clients the priceless fire protection, rich beauty and long, maintenance-free performance of Carey Fire-Chex Shingles. See your Carey dealer—or write *now* for illustrated literature!

*Without asbestos underlayment

Rose Hill, N. C. Officials

Praise Carey Fire-Chex Shingles!

Excerpts from sworn statements by Chairman of Mt. Zion Building Committee and Rose Hill, N. C. Fire Chief—

"Owing to the fire-resistant quality of the (Carey) shingles, the fire was held in check for three hours. I have no hesitancy in saying quite frankly that all of us attribute the saving of our buildings . . . to your very fine shingle."

M. D. Corning

Chm., Bldg. Comm.
Mt. Zion Presb. Church

"It is a pleasure for me to recommend your shingle, from the standpoint of fire-resistance, without any reservation. The evidence in this particular fire speaks for itself."

A. B. Lussell, Chief

Rose Hill Volunteer F.D.

FROM THE HOUSE OF CAREY

Bathroom Cabinets and Accessories • Ventilating Fans • Ceramo Asbestos Siding • Corrugated Asbestos Cement Siding • Fire-Guard Rock Wool Insulation • Fire-Chex Asbestos-Plastic Shingles • Other famous products for home, farm and industry.

Carey

The Philip Carey Mfg. Company, Lockland, Cincinnati 15, Ohio

PRODUCTS

(Continued from page 180)

Factory-Made Houses

The National Homes Corp. announces 27 new designs for their 1952 line of *Super-Thrift Homes*. The new models, available with 2-, 3- or 4-bedroom plans, are said to feature lower roof lines with overhanging eaves, and a choice of three exterior finishes. Several of the larger

models are available with hip roofs.

Exterior finishes include standard siding, cedar shingle shakes and plastic marine plywood which may be used singly or in combination. Designs are mostly of Ranch Type or Cape Cod Styles. Rock wool insulation is used in exterior walls; the inside panels have a built-in vapor barrier. A water-repellent wood preservative is applied to gable siding, floor plates, and tops and bottoms of doors.

Sizes of all windows are said to have been increased over previous models.



Prefab houses feature horizontal lines

Beauty **plus STRENGTH**
with **LACLEDE STEEL JOISTS**

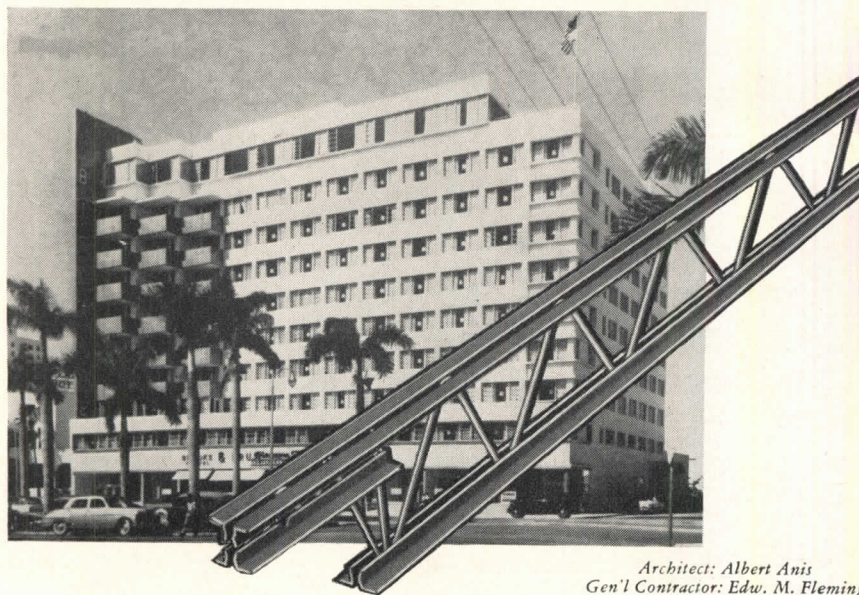

*Architect: Albert Anis
Gen'l Contractor: Edw. M. Fleming
Construction Co., Inc.*

Combining structural strength with design flexibility, Laclede steel joists played an important role in the construction of this modern new Biscayne Terrace Hotel in Miami, Florida.

Careful control of quality from open hearth to finished product in the modern Laclede mills is your assurance of dependable quality when you specify these Laclede construction steels:

- Steel Joists • Welded Wire Fabric • Corrugated Centering • Multi-Rib Round Reinforcing Bars • Accessories
- Spirals • Pipe and Conduit



LACLEDE STEEL COMPANY

Producers of Steel
for Industry and Construction

St. Louis, Mo.

Many designs have picture windows on the facade, other windows equipped with shutters. Interior ceilings are sand-finished, closets have slat-type folding doors. Kitchens are equipped with steel cabinets, shelves and double sink. Larger models have a separate utility room. National Homes Corp., Lafayette, Ind.

Window Type Air Conditioner

Featuring a high operating efficiency and a low noise level, this window exhaust has been redesigned and re-engineered by the manufacturer. Available in two capacities, the 1/2 HP unit is recommended for rooms between 200 to 300 sq ft floor space, while the 3/4 HP unit is suggested for use in rooms of 300 to 450 sq ft of floor space. Adjustable louvers provide four-way directional control of air flow. In addition to the standard 1 year warranty on the unit, the

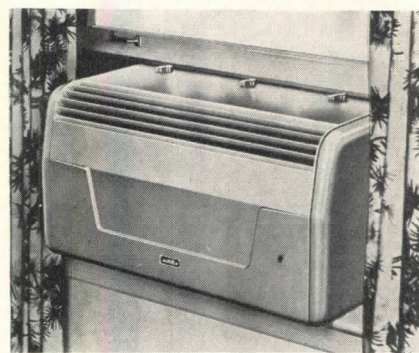

Window unit gives directional air control

compressor has a five year warranty. U. S. Air Conditioning Corp., 3300 Como Ave., S. E., Minneapolis 14, Minn.

Self-Locking Jack Plug

Claimed to be vibration-, impact-, and crackle-free, *Hubbel-Interlock* connectors are said to be suitable for all wiring connections. Featuring straight, bayonet

(Continued on page 184)

*Stainless must go
a long way, too!*



To meet the demands of national defense and civilian needs, stainless must go a long way. That's why, now, more than ever—if you use stainless—use it wisely and efficiently.

Stainless is a name given to a broad list of grades and finishes—therefore, careful selection of the best available materials for your job is of prime importance. Here Crucible, a pioneer in the development of stainless steels, can help you get the most out of your share of stainless stocks through the unparalleled experience of our metallurgists and stainless fabricating specialists.

And when you can't get the grade of stainless you need, Crucible technical personnel can give you sound advice on the best available materials.

Until the time when stainless is more freely available . . . stretch your supplies of stainless. To do this . . . make use of Crucible's wealth of stainless steel experience.

CRUCIBLE

first name in special purpose steels

51 years of *Fine* steelmaking

STAINLESS STEELS

CRUCIBLE STEEL COMPANY OF AMERICA, GENERAL SALES OFFICES, OLIVER BUILDING, PITTSBURGH, PA.
STAINLESS • REX HIGH SPEED • TOOL • ALLOY • MACHINERY • SPECIAL PURPOSE STEELS

PRODUCTS

(Continued from page 182)

insertion, the plug keeps constant terminal contact pressure by means of a spring within a sleeve. To disengage, the sleeve, rather than the terminal, is pulled. The automatic locking action simplifies wiring assembly. The plug provides frictional as well as knife edge contact. Rated at 10 amps, 110 volts, the pressure contact is aid to insure constant low

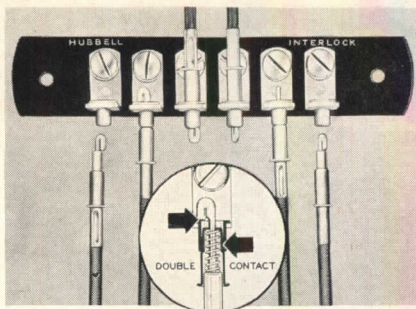

Pull-out jack plugs are designed for easy connection, positive contact

contact resistance. Pull-out of the plug occurs, the manufacturer estimates, when 25 lb is applied. Harvey Hubbel, Inc., State and Bostwick Ave., Bridgeport 2, Conn.

New Developments in Plastic

Among recent uses of plastic is the inclusion of resin impregnated paper as an element in the lamination of hollow core doors, and the molding of furniture parts. Wood residues are also utilized in the molding process, made possible by use of phenolic and urea resins.

Desk tops are included in the list of furniture products that are produced. The tops are molded by the Insulation Manufacturing Company, 11-19 New York Ave., Brooklyn, N. Y. Sawdust is compressed to 1/4 of its original bulk, between ten sheets of plastic impregnated paper, to form a desk top 18 by 24 in., 3/4 in. thick. It is claimed to be impervious to moisture, and resistant to impact, surface abrasion, flame and most acids. It can be cleaned with a damp cloth.

Famous Architects Obtain Maximum Fire Safety and Sound Absorption in Ultra-Modern Building!



Zonolite® Acoustical Plastic

Eliel Saarinen and Robert F. Swanson—John Brooks and Elmer Borg, architects who drew the plans for the modern, beautiful Des Moines Art Center specified Zonolite Acoustical Plastic—as the modern material best fitted for this magnificent modern building.

They wanted soundproofing to make it possible to enjoy fine art. But more than that—they wanted maximum fire protection to guard art treasures and protect students and visitors. Zonolite Acoustical Plastic on the ceilings, and Zonolite base coat plaster throughout, best combined these desired properties.

Firesafe Zonolite vermiculite was also employed for insulating concrete roofs and floors on this renowned Art Center.

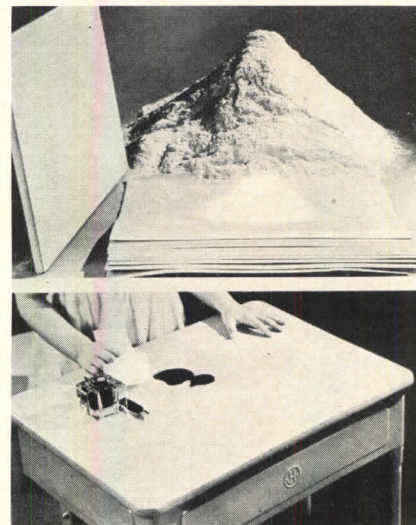

Compressed sawdust and plastic-impregnated paper (top) form desk tops (bottom)

Wherever noise is a nuisance, where harsh sounds cut down office efficiency, factory production or home comfort, Zonolite Acoustical Plastic is the low cost answer for the problem. It will stick to any clean, firm, water-resistant surface—even cracked walls and ceilings can be covered smoothly. Trowels on as easily as plaster. Ideal for hotels or restaurants, shops or theaters. Sound co-efficient, 0.65.

Send today for latest circular on Zonolite Acoustical Plastic, or other Zonolite vermiculite products.

ZONOLITE COMPANY
135 S. La Salle St. • Chicago 3, Illinois
Member of Vermiculite Institute



Zonolite Company
Dept. AR-81
135 S. La Salle St.
Chicago 3, Ill.

- Please send me FREE Booklet PA-5 on Zonolite Acoustical Plastic.
- Send catalog G-24 on other Zonolite products.

Name.....

Address.....

City.....Zone.....State.....

Plastic impregnated paper is also used in hollow core door construction. An intermediate layer of paper is pressed between two plies of wood. The strength of this intermediate veneer allows the use of surface-checked wood that would have otherwise been impractical for a base. Since the paper layer cannot be deformed under pressure it insures the masking of the surface variations of the base and also provides rigidity. Bakelite Co., 122 East 42 St., New York 17, N. Y.

(Continued on page 186)

OUT GOES THE CLASSROOM "COAT ZONE"



...when **DRAFT STOP** is brought in!

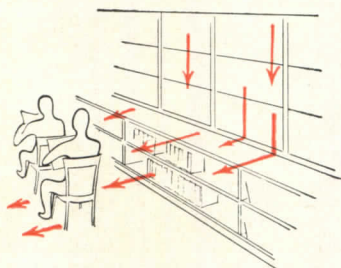

YESTERDAY'S PROBLEM of drafts is shown in this classroom. Above you see how cold air travels unhindered, presents a cold front problem of discomfort and possible illness.

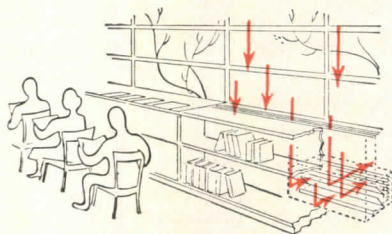

TODAY'S SOLUTION with the new DRAFT|STOP System ends draft threats. See how drafts and cold air are controlled. DRAFT|STOP will stop the draft before it can start trouble.

TEACHERS KNOW that too many classrooms have a comfort problem. It can seriously affect the health and study habits of students. A day in school offers *ample proof*. Chilling down-drafts from today's large window areas require additional clothing in certain parts of the classroom.

That's why Herman Nelson DRAFT|STOP is being hailed by architects and school officials as the only modern method of protecting pupils against drafts. Over-heating is prevented because the system is controlled automatically. Fresh air supply always available . . . drafts and cold rushes of air never have a chance.

Be certain the school you're interested in has DRAFT|STOP. There's nothing in modern classroom heating and ventilating that can take its place. For complete information, write Dept. AR-8.

© AAF



HERMAN NELSON

Division of AMERICAN AIR FILTER COMPANY, INC.
MOLINE, ILLINOIS

PRODUCTS

(Continued from page 184)

Tempestini Furniture

Employing wrought iron, wicker and glass, Maurizio Tempesti has created a number of interesting new pieces of furniture. Extreme simplicity and conservation of materials mark the designs. Included in this group are a living room set, a small table group, a



Simple dinette set has wrought iron frames and glass top for table

headboard and night table, a dinette, and a small bar.

Of particular interest is the dinette set. The table is of 7/16 in. glass, 32 in. by 48 in., and is supported upon wrought iron legs. The chairs of the set are constructed of thin wrought iron rods. Slip seat upholstery is filled with kapok. This group is available in 10 colors. The set is protected by a Neva-Rust process against corrosion due to rust. John B. Salterini Co., Inc., 510 East 72nd St., New York, N. Y.

Stacking Chairs

Designed by Swanson Associates, a neatly designed new chair displays economy of materials as well as full utilization of storage space. The chairs are in limited production at this time.



Architect-designed chairs permit easy stacking to conserve storage space

Pella
**LITE-PROOF
 SHADES**
 The practical way
 to darken rooms

VIEWING slides or motion pictures in an inadequately darkened room induces eyestrain. Pella Lite-Proof shades come with specially designed side guides and sill locking bar that hold the plastic coated shade fabric in place and seal out light.

FIT ANY TYPE WINDOW
 Pella Lite-Proof Shades are made-to-measure for any size or kind of window. They are permanently installed in classroom, laboratory or auditorium.

DURABLE SHADE FABRIC
 Tough, plastic-coated fabric of 100% opaqueness will not crack or become brittle.

NEAT APPEARANCE
 When not in use, Pella shades roll up into a neat metal headpiece, out of the way and protected from dust or dirt.

WRITE TODAY for literature and name of nearest dealer.

ROLSCREEN COMPANY
 DEPT. C-39, PELLA, IOWA

A simple back and seat of molded plywood, and tubular metal legs comprise the materials used. The saddle seat is attached to the frame by metal studs, as is the back. American Seating Company, 901 Broadway, Grand Rapids 2, Mich.

Aluminum Supply

The Aluminum Window Manufacturers Association announces that, with the Government CPM regulation in effect, a reasonable amount of aluminum is available for production of windows, and may be safely specified for future buildings. Residential aluminum windows are said to be available in stock for immediate use. Manufacturers of custom-built windows for hospitals, schools, apartments, institutional and commercial buildings assure reasonable deliveries when normal lead time is allowed.



dows: Low first cost . . . volume production. Low installation cost . . . modular sizes. Low maintenance cost . . . steel *lasts*.

FENESTRA HOT-DIP GALVANIZING SLASHES WINDOW MAINTENANCE COSTS

Check on Fenestra Hot-Dip Galvanized Windows. The combination of the strength of

steel and super-protection of the special galvanizing done in Fenestra's automatically controlled new galvanizing plant puts new meaning in the term "maintenance-free." No painting, period!

For further information, call the Fenestra Representative (listed in your Yellow Phone Book), or send the coupon. *®

Free Authoritative Books

BETTER CLASSROOM DAYLIGHTING—Well-illustrated, simply-written, 16-page guide based on two years of research by well-known Lighting Expert R. L. Biesele.

FENESTRA HOT-DIP GALVANIZING—Illustrated booklet showing how Fenestra Hot-Dip Galvanizing makes Fenestra Steel Windows stay new.

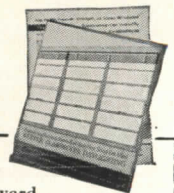

Detroit Steel Products Company
Dept. AR-8, 2252 E. Grand Boulevard
Detroit 11, Michigan

Please send me:

- Better Classroom Daylighting
- Fenestra Hot-Dip Galvanizing

Name _____

Address _____

engineered to cut the waste out of building

Another Globe Elevator!

America's Most
Economical Elevator
to Install, Operate
and Maintain for
✓ APARTMENTS
✓ FACTORIES
HOSPITALS
HOTELS
STORES
WAREHOUSES



This Globe Elevator carries 15,000 lb. loads between 3 floors in a Philadelphia factory. It is a perfect illustration of the simplicity of design that makes Globe America's most economical elevator.

We feel safe in saying that the Globe Oilift Elevator is the last word in simplicity and economy.

Ascent is powered by an oil operated cylinder. Descent is by gravity and regulated by a controlled flow of oil. The Globe has eliminated expensive penthouse construction, elaborate mechanisms and heavy weight-bearing shaft walls.

Installation, operating and maintenance costs are kept at a minimum. In fact, Globe's maintenance cost is so low, as compared with many other types of elevators, that over a period of 20 to 25 years, the owner of a Globe will more than save the original cost of his elevator.

Globe Elevators are custom-assembled to your specifications. Write today for our informative Bulletin AR-317 on freight and passenger elevators. It belongs in your files.

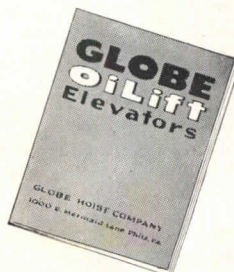

GLOBE

Oilifts



BY THE WORLD'S LARGEST
MAKERS OF HYDRAULIC
LIFTS, ELEVATORS AND
AUTOMOTIVE HOISTS

GLOBE HOIST COMPANY, 1000 E. Mermaid Lane, Philadelphia 18, Pa.
(Factories at Des Moines, Iowa & Philadelphia, Pa.)

Architectural Engineering

LITERATURE

(Continued from page 160)

Suspended Ceiling

Alumi-Coustic Grid System for Suspended Ceilings. Brochure describes installation details with step-by-step photographs. Information pertaining to joining, splicing, layout, procedure, and sample specifications are given. Cupples Products Corp., 2650 South Hanley Road, Maplewood, Saint Louis 17, Mo.*

Corrosion Control

Synthetic Rubber Based Corrosion Control Coatings. Descriptive pamphlet describes the various uses of synthetic rubber based compounds for use on machinery, walls, cement floors, and stucco-masonry walls. Information on methods of application and surface preparation is given. 8 pp., illus. Casey and Case Coating Co. P. O. Box 151, Maywood, Calif.

Federal Color Card for Paint

Federal Specification TT-C-595, Colors for Ready Mixed Paint. By the elimination of unimportant color variations this specification reduces the number of government classified shades from 600 to 187. Published in loose-leaf form, the manual includes color samples for each shade, which measure 2 $\frac{5}{8}$ in. by 1 $\frac{3}{4}$ in. Three surface values are provided for each color, glossy, semi-glossy, and flat. Color specifications and classifications are based upon the ISCC-NBS (Inter-Society Council—National Bureau of Standards) system. A master chart based upon the Munsell system allows an additional method of classification. Price \$4.50. Superintendent of Documents U. S. Government Printing Office, Washington 25, D. C.

Brick Workmanship

Dry Brick Walls. This well illustrated pamphlet demonstrates in step-by-step photographs the quality of workmanship necessary to insure dry brick walls. This pamphlet was awarded a Certificate of Merit in the Third Annual Building Products Literature Competition sponsored by the A.I.A. and the Producers' Council. 14 pp., illus. Louisville Cement Co., Inc., Louisville, Ky.*

(Continued on page 192)

STOP



RUST



WITH

RUST-OLEUM

Effective, long-range *rust control* must start in the plans and specifications for any structure — particularly when iron and steel are important structural materials. Architects and builders find that RUST-OLEUM offers excellent protection — particularly in hidden or inaccessible areas where damaging rust conditions can breed unchecked.

It's particularly essential to safeguard the strength and usefulness of structural columns and beams, metal deck ceilings, crawl spaces and many other details of construction. These are readily damaged over the years where fumes, manufacturing processes and condensation due to limited ventilation cause serious rust damage that may threaten the safety and life of the entire structure.

RUST-OLEUM'S capacity to stop rust has been proved in industrial applications for many nationally-known companies, and leading railroads

for the past 25 years. Its tough, pliable, rust inhibiting film resists the basic causes of rust — dampness, brine, salt air, and general weathering — indoors and outdoors.

Discuss effective *rust control* with your clients. To solve your rust-in-construction problems, recommend RUST-OLEUM. Specify RUST-OLEUM as the primary or shop coat on all steel, metal sash, structural beams and bar-joists, fire escapes, etc. Your clients will readily recognize that future protection of sealed-in steel begins with the primer coat.

We're ready at all times to consult with you on rust problems and offer specific recommendations. See the complete RUST-OLEUM catalog in *Sweet's Architectural File*, or write for a copy. Industrial Distributors in principal cities of the United States and Canada carry large stocks of RUST-OLEUM for immediate delivery.



Available in many
COLORS
aluminum and white

Beautifies as
it Protects

"RIGID ECONOMY, MON!"

RUST-OLEUM CORPORATION
2513 Oakton Street, Evanston, Illinois

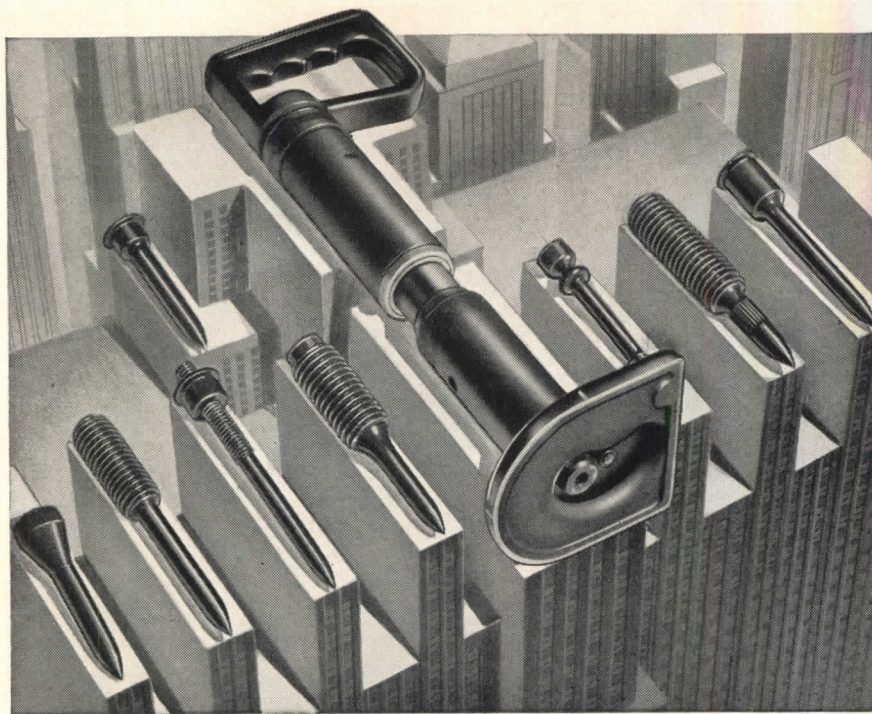

ESSENTIAL FOR EVERY BUILDING . . .

Ramset "tops" all other methods

To finish the work sooner, on new construction, alterations or building maintenance, see that RAMSET® SYSTEM is utilized for every possible fastening job.

For most of the thousands of fasteners needed to install services, facilities and equipment, RAMSET reduces to short minutes the long hours required by conventional methods. Actually about 10 times as fast, RAMSET saves vitally needed man power, drastically reduces costs . . . and enables

you to occupy buildings and put machines and facilities to work, sooner.

No other fastening system sets like RAMSET . . . no other method matches RAMSET's combination of speed, economy and versatility. RAMSET is foremost in powder-actuated fastenings—and is the *only integrated system*.

Send for details on how RAMSET can save man power, time and money on almost any construction or maintenance job. Use the handy coupon.

Ramset Fasteners, Inc.

12125 BEREA ROAD • CLEVELAND 11, OHIO

Please send details on RAMSET FASTENING SYSTEM and give us name of nearest RAMSET Dealer.

Name _____
 Company _____
 Street _____
 City _____ State _____

Architectural Engineering

LITERATURE

(Continued from page 190)

Aerial Surveys

Aerial Surveys Save Time and Money. Reprint from the Public Works Magazine gives information regarding the practicability of aerial survey. Included are estimates of time saved and estimated costs compared with the usual procedure. In addition to the reprinted article a descriptive sheet is included showing various types of maps that may be obtained from aerial surveys. 5 pp., illus. Abrams Aerial Survey Corp., Lansing 1, Mich.

Oil Heaters

New Wa-Tu-Bo Oil Heaters. Pamphlet describes three new multi-pass oil preheaters. Included with the text are capacity tables, dimension tables and typical specifications. Additional information is given for calculating steam requirements. 15 pp., illus. Water Tube Boiler and Tank Co., Inc., 140 West Root St., Chicago 9, Ill.

Electrical Radiant Ceilings

Uskon Electrical Radiant Heat from the Ceiling. Pamphlet includes sample specifications, calculation for heat loss, insulation, amount of power needed, tables and a discussion of the construction and theory of radiant ceiling panels. The pamphlet was designed for reference information. Illustrations include application procedure and typical installations. 30 pp., illus. Uskon Dept., Mechanical Goods Div., United States Rubber Co., 1 Market St., Passaic, N. J.













Lighting Study

The Feasibility of Using Models for Predetermining Natural Lighting. This booklet describes the comparative accuracy of simulated daylight conditions in a model with those actually encountered. The booklet covers the method of predetermining the amount of natural lighting that would be encountered in the final building. Comparative studies are shown graphically. Tables and bibliography are included. 33 pp., illus. Research Reports, Texas Engineering Experiment Station, Texas A. and M. College, College Station, Texas.

(Continued on page 194)

NOW! G-E BALLASTS ARE SOUND RATED*

***SOUND-RATING:** G. E.'s new classification of ballasts to guide you in the correct application of fluorescent fixtures.

HOW G-E SOUND RATING WORKS	
IF THIS IS YOUR APPLICATION AND YOUR AVERAGE AMBIENT NOISE LEVEL IS HERE*...
 Broadcast Studio Church Country Residence	 20-24 decibels
 Evening School City Residence Quiet Office	 26-30 decibels
 Average Residence Public Library Study Hall	 32-36 decibels
 Classroom Professional Office	 38-42 decibels
 Noisy Residence Business Office	 44-48 decibels
 Store Noisy Office Factories	 50-62 decibels

*Average ambient noise levels in decibels, measured with standard 40-decibel weighting network.

A new tool to help you build greater customer satisfaction by minimizing noise complaints

Every fluorescent ballast has a normal, magnetic hum. But now, for the first time, you can know the relative sound level of the ballast before you buy. For G-E engineers have pioneered a system for measuring ballast sound levels accurately. These measurements have led to six classifications: from "A"—extremely quiet, to "F"—quite audible. This means that you know, before installation, which ballasts are right for any given application—whether it be church, school, noisy factory area, or any one of a wide range of other locations.

Take the first step toward eliminating customer complaints about objectionable noise. Write for GEA-5672, a four-page bulletin which explains Sound Rating in detail. A reprint of recent technical information (GER-36) is also available. Write Section 412-93, General Electric Company, Schenectady 5, N. Y.



GENERAL  ELECTRIC

412-93

this booklet gives you
complete information on
VENTING OF GAS APPLIANCES

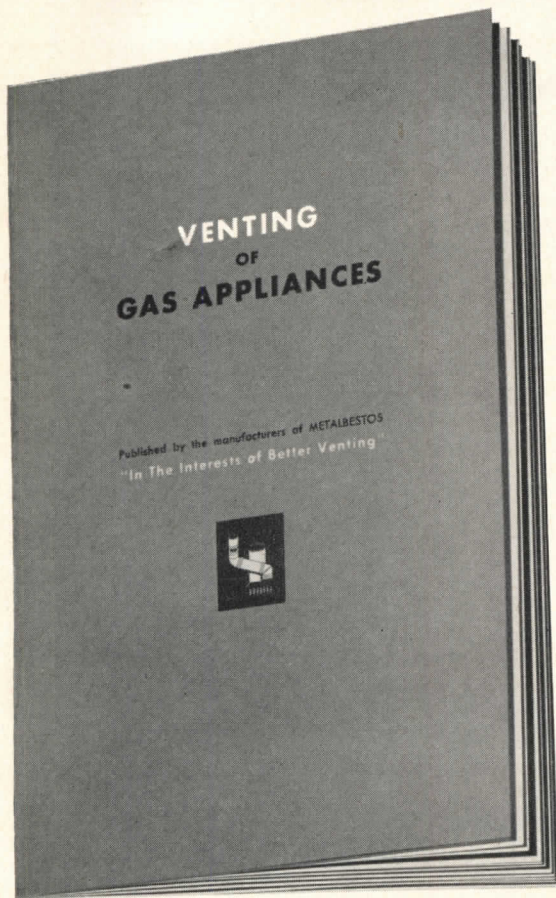

- ★ the venting problem
- ★ 5 basic rules for gravity vents
- ★ do's and don'ts of gas venting
- ★ wall heater installations
- ★ tips on vent installation



Send for your free copy of this valuable booklet today.
No obligation

 METALBESTOS DIVISION <small>WILLIAM WALLACE COMPANY • BELMONT, CALIF.</small>		<i>Use this convenient coupon.</i>	
METALBESTOS DIVISION, Dept. L WILLIAM WALLACE COMPANY, BELMONT, CALIFORNIA			
Please send me, free of charge, _____ copies of your booklet, "VENTING OF GAS APPLIANCES."			
NAME _____		TITLE _____	
COMPANY _____			
ADDRESS _____			
CITY _____		ZONE _____ STATE _____	

Architectural Engineering

LITERATURE

(Continued from page 192)

Baseboard Radiant Heating

(1) Baseboard Heating; (2) Commercial "Fin Pipe" Coils. The first of these pamphlets describes the installation details and pertinent measurements that are required for detailing these units. Step-by-step illustrations are included to show the method of installation that is used with the units.

The second pamphlet illustrates the various types of fin type radiation that are available. Photographs and enclosure measurements are given. A table of ratings is included. 3 pp., 8 pp., illus. Kritzer Radiant Coils, Inc., 2901 W. Lawrence Ave., Chicago 25, Ill.

Hydraulic Lift Bulletin

Lift. Presents in newspaper tabloid form many applications of the hydraulic hoist that have been made to date. Short descriptions of the problems that were encountered are given as well as a brief description of the solution. Provisions are made in the bulletin so that more information can be obtained by those who desire it. Globe Hoist Co., Mermaid Lane at Queen St., Philadelphia 18, Pa.*

Convactor Radiators

Fedders Type F Convactor Radiators. Brochure describes design of units, includes specifications, tables of ratings and capacities. Detailing and installation dimensions are shown also. 6 pp., tables, illus. (This brochure was published as an advertising insert in the July issue of Architectural Record; reprints are available.) Fedders-Quigan Corp., 57 Tonawanda St., Buffalo 7, N. Y.*

LITERATURE REQUESTED

The following individuals and firms request manufacturers' literature:

Robert Cody, Student, 1191 Gladys St., Lakewood 7, Ohio.

Saul Rosenblum, Student, 7666 Austin St., Forest Hills, L. I., N. Y.

Roberto Magtanggol Tenorio, 27 Tupas St., Pasay City, Philippines.

Ullrich and Moore, Architects & Engineers, 1501 E St., San Bernardino, Calif.

"GuthTops in Troffers!"

Our customers have sold us on our troffer line! They say: "It's Number One everywhere — in quality, comprehensiveness, and price. It's great!"

Look how easy it is to install and maintain GUTH Troffers:

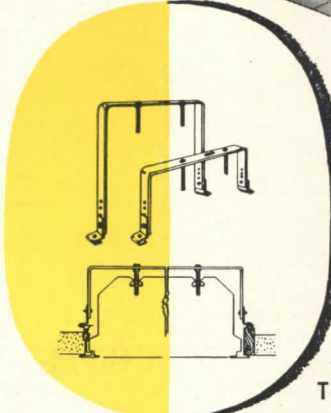
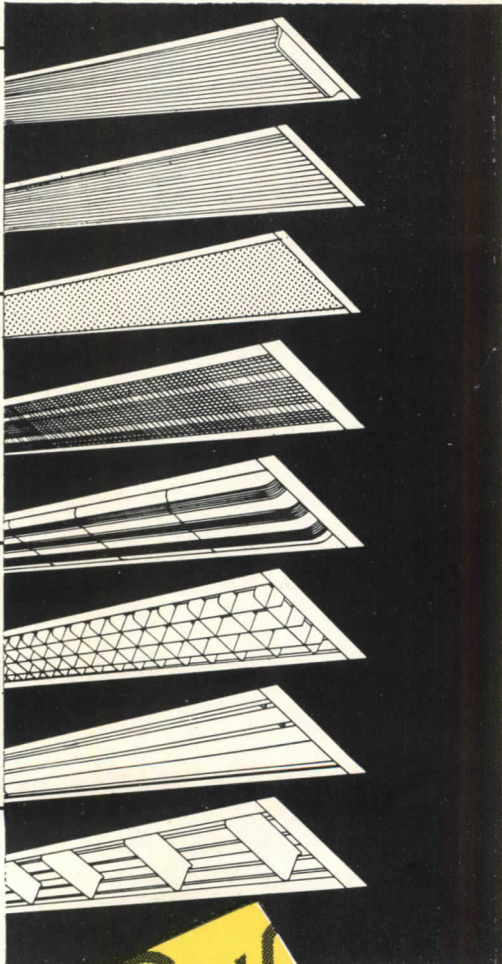

SIMPLE, ONE-MAN INSTALLATION

place the exclusive GUTH QM brackets in the ceiling. Then one man can push the Troffer into place. Brackets grip the Troffer automatically, allowing it to be adjusted for perfect fit and fastened with wing nuts. That's all — simple, isn't it?

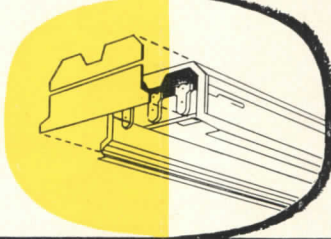

MODULAR LENGTHS WITHOUT TRIMMING

Troffers fit ceiling block openings in lengths of 2', 4', 5', 6', and 8'.

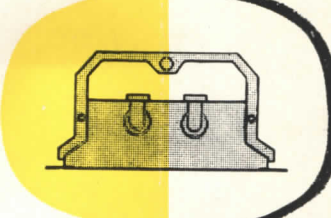

WIDE OPEN WIREWAY

wires are pulled through quickly and easily. How the contractor loves this feature!



MONEY-SAVING MAINTENANCE

glass framed and eggcrate are hinged for easy relamping and cleaning. Slide-in reflectors are easy to remove and replace — no latches or nuts to bother with. Ballast can be replaced without removing fixture.

UNBROKEN RIBBONS OF LIGHT

no metal joints — no divider shadows.

1-, 2-, 3- AND 4-LAMP SIZES

all with the same cross section — may be combined for perfect fit in one "strip".

ALL POPULAR LIGHT SOURCES

top lighting efficiency with Standard, Slimline, and Low Brightness lamps — in a total of 24 wattage sizes.

Write for Bulletin 869-J.

Guth

LIGHTING

THE EDWIN F. GUTH COMPANY / ST. LOUIS 3, MISSOURI

Leaders in Lighting since 1902

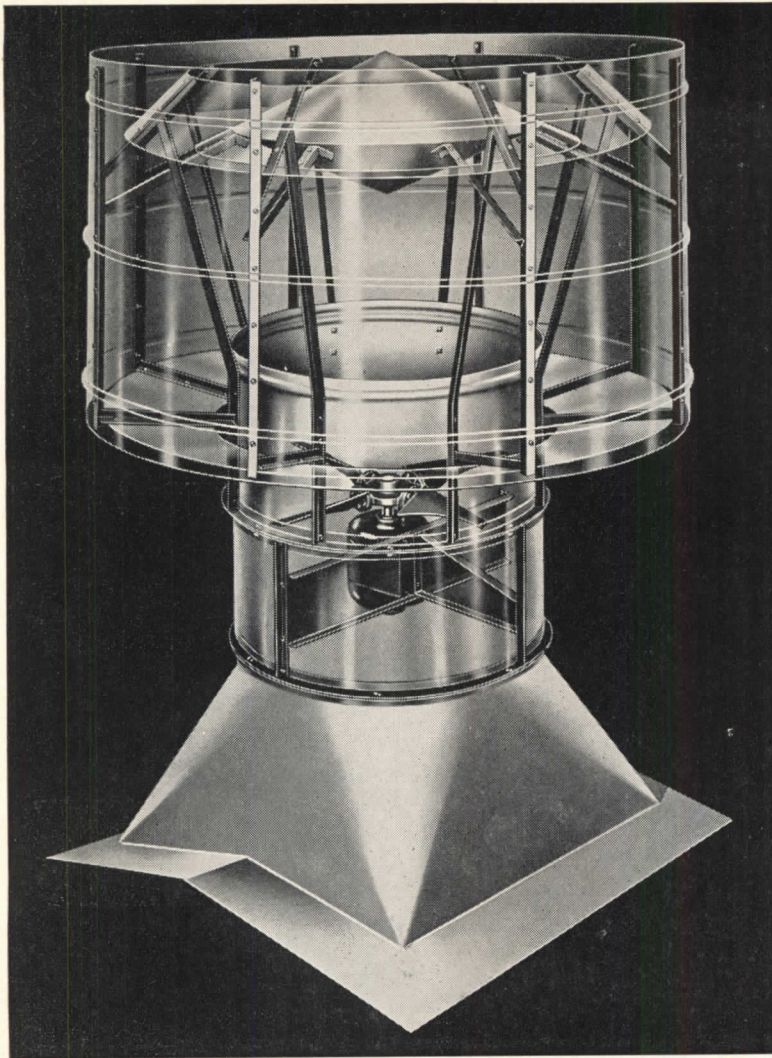

BURT FREE-FLOW FAN VENTILATOR A DUAL-PURPOSE UNIT WITH OUTSTANDING CAPACITY

With power off, the Burt Free-Flow Fan Ventilator, operating as a gravity unit, usually supplies all normal exhaust needs. But when production operations create high temperatures or excessive dust, fumes, etc., its high velocity fan quickly (about six times faster) exhausts the extra heat and impurities. Positive ventilation is assured *always*. Sized from 12" with a rated capacity of 1040 C.F.M. to 84" giants rated at 99050 C.F.M. Discharge is vertically upward to protect roof from corrosive fumes or smoke present in the exhausted air. For more complete details see Sweet's or write for Bulletin SPV-10A.

FAN & GRAVITY VENTILATORS • LOUVERS • SHEET METAL SPECIALTIES

The Burt Manufacturing Company

48 E. South Street • Akron 11, Ohio

THE RECORD REPORTS

WASHINGTON

(Continued from page 26)

where factories are already located.

2. DPA's study referred only to firms receiving federal aid under the tax amortization program. A complete analysis would have to include expansion with government loans and guarantees, and with the use of private capital without any government assistance.

3. The study deals with manufacturing facilities exclusively. It does not take into account the expansion of transportation systems or public utilities which are an integral part of the development of any geographic region.

4. Issuance of a certificate of necessity is no guarantee that the plant actually will be built. There are many reasons why the creation of new plant facilities may be postponed or even cancelled.

Building Programs Announced

Two large future construction programs were announced about a month ago. The \$6.5 billion military public works schedule began a dual course through Congress; hearings on the authorization and the appropriation measures were going on simultaneously. Shortly after the Defense Department took its two-year construction program for the three services to Congress, the Civil Aeronautics Administration brought out its three-year 1951 National Airport Plan. This called for construction of new airports or improvement of old fields in every state at an estimated cost of \$662 million. This would require \$323,700,000 in federal funds and \$338,300,000 in local sponsor contributions.

As the House Armed Services committee received the military public works measure, it called for authorization of \$6,561,262,378. This involved work for the Army, Navy, Air Force and Marines in all states but four, and at overseas locations. Secretary of Defense Marshall said the purpose of the program was to "construct military public works urgently needed by the Department of Defense to meet its requirements under the expanding military program which has been dictated by the current international situation." The committee lost no time in getting to work on the bill, but failed by a wide

(Continued on page 198)

**OPENS WIDEST
CLOSES TIGHTEST**

Auto-Lok
PATENTED

**The only window that successfully
combines the BEST features of ALL
window types.**

In its dual function as a ventilating element and
as an air barrier, *Auto-Lok is unequalled!*

Open, it provides 100% draft-free ventilation! Air is
scooped in and upward. Precision-balanced Auto-Lok
hardware gives you effortless finger-tip operation...
100% ventilation control, even when it's raining...and
you clean the outside from the inside... top vent, too.

Closed, Auto-Lok provides a degree of tight closure
heretofore believed impossible. A perfect, *super seal*
against air infiltration, driving rains, dust storms and
hurricanes that means real economies in fuel and air
conditioning expense.

*This unrivaled tight closure is achieved by patented
Auto-Lok hardware which pulls the vents in tight against
the elastomeric vinyl weatherstripping and automatically
anchor-locks them at all four corners of each vent.*

Appearance-wise, Auto-Lok Windows bring a brisk
smartness to any architectural plan, modern or tradi-
tional. No window possesses greater adaptability for
buildings of all types and sizes. Auto-Lok's surprisingly
competitive cost and simplified installation fits them
readily into the most modest building budget.

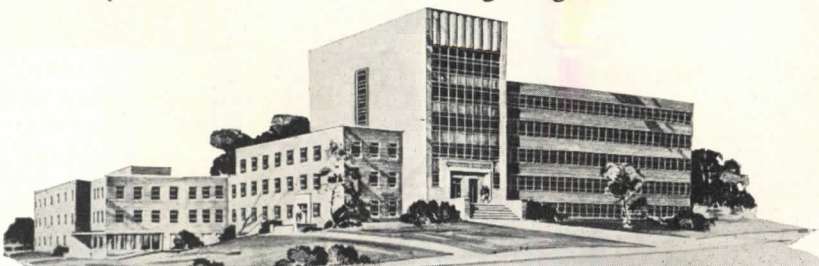

Montgomery County Office Bldg., Rockville, Md. Ronald S. Senseman, Takoma Park, Md., Arch.

Full details in Sweet's. Name of your nearby Auto-Lok distributor on request.

Write for our free booklet, "What is Important in a Window?"

AR-8

Also available — AUTO-LOK in Wood

Auto-Lok
PATENTED

weatherstripped

**ALUMINUM
WINDOWS**

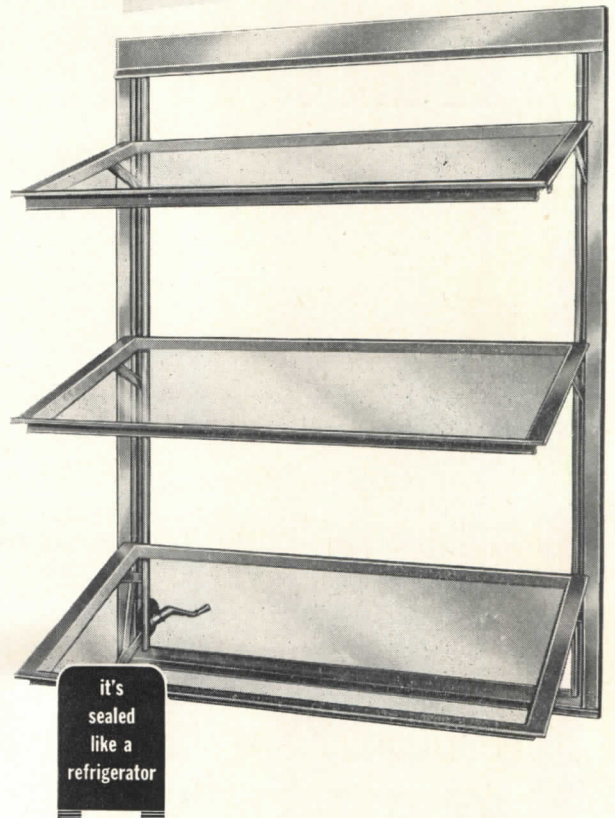

Engineering Service!

Architects everywhere call on
Ludman's engineering staff to
assist in window planning.
Why don't you?

LUDMAN
Corporation

P. O. BOX 4541
MIAMI, FLA.

WASHINGTON

(Continued from page 196)

margin to give the Department what it asked. Chairman Vinson early indicated the committee's intention of authorizing only that amount of work that could be undertaken with fiscal 1952 appropriations, particularly as it pertained to Army and Navy. The group was more inclined to authorize the total Air Force asking, which involved construction of a series of installations ringing Soviet Russia.

About \$4.5 billion were included for construction to get underway in this 1952 fiscal year. The services put their programs on a two-year basis because many of the projects would take more than a single year to construct. In denying authority for some of the construction, the House unit explained it did not mean by its action that the entire program should not be completed. But it said it felt closer contact with progress of the programs could be maintained by authorizing only that amount of building covered by appropriations.

President Truman requested approximately \$4.5 billion in fiscal 1952 funds to cover the start of the gigantic program, largest single construction schedule ever submitted to Congress.

Airport Listing Revised

The CAA program, which was announced on July 4, contemplates construction at 4,945 locations at which airports should be constructed or improved to meet existing and anticipated demands for air service. Charles F. Horne, Administrator of Civil Aeronautics, submitted this, the fifth in the series of such three-year plans drawn up annually to provide a system of airports adequate for the needs of civil aviation.

No funds, federal or local, are assured simply because a project is included in the 1951 plan. On the basis of appropriations to be made by Congress, however, the CAA will include in its coming fiscal year program those locations in the plan which show the greatest need. Of the nearly 5000 locations listed, 4815 are in the continental U. S., 130 in the Territories. Of all projects shown, 2657 are for improvement of existing airports and 2288 for completely new installations.

(Continued on page 200)

HIDE the hardware... says

FRANK LLOYD WRIGHT

"My efforts since I've been practicing for myself, is to get rid of it. The less hardware that is in evidence, the better. The more you get the hardware out of sight, and make less of it, the more you are going to be modern and in line with modern architecture."



IDEAL FOR FLUSH DOORS

The Soss Invisible Hinge was designed to stay out of sight. It is the only all NEW hinge since Noah built his ark.

"The less hardware that is in evidence the better."
The Soss Invisible Hinge is also known as "the hinge that hides itself."

"Hardware is still too ornamental—it isn't sufficiently simple."

What could be less ornamental or more simple than something you can't see—like the Soss Invisible Hinge?

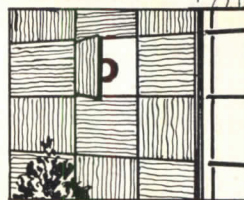

PERFECT FOR WALL PANELS

"Hardware should be something that really works and should be out of sight—"

Soss Hinges "really work" smoothly and quietly on hardened steel roller bearings.

★ All quotes taken from Mr. Wright's address before the Pacific Coast members of the American Society of Architectural Hardware Consultants and the National Contract Hardware Association at the Arizona Biltmore in Phoenix, Arizona.

SOSS  **HINGE**
INVISIBLE HINGES

Write for FREE CATALOG that gives complete details, blueprint templates, and the many uses of this modern hinge to...

SOSS MANUFACTURING COMPANY
21769 HOOVER ROAD • DETROIT 13, MICHIGAN

A.I.A. File No. 27-B-1

Answers the "WALL-OF-ICE" Problem

NESBITT Syncretizer with WIND·O·LINE

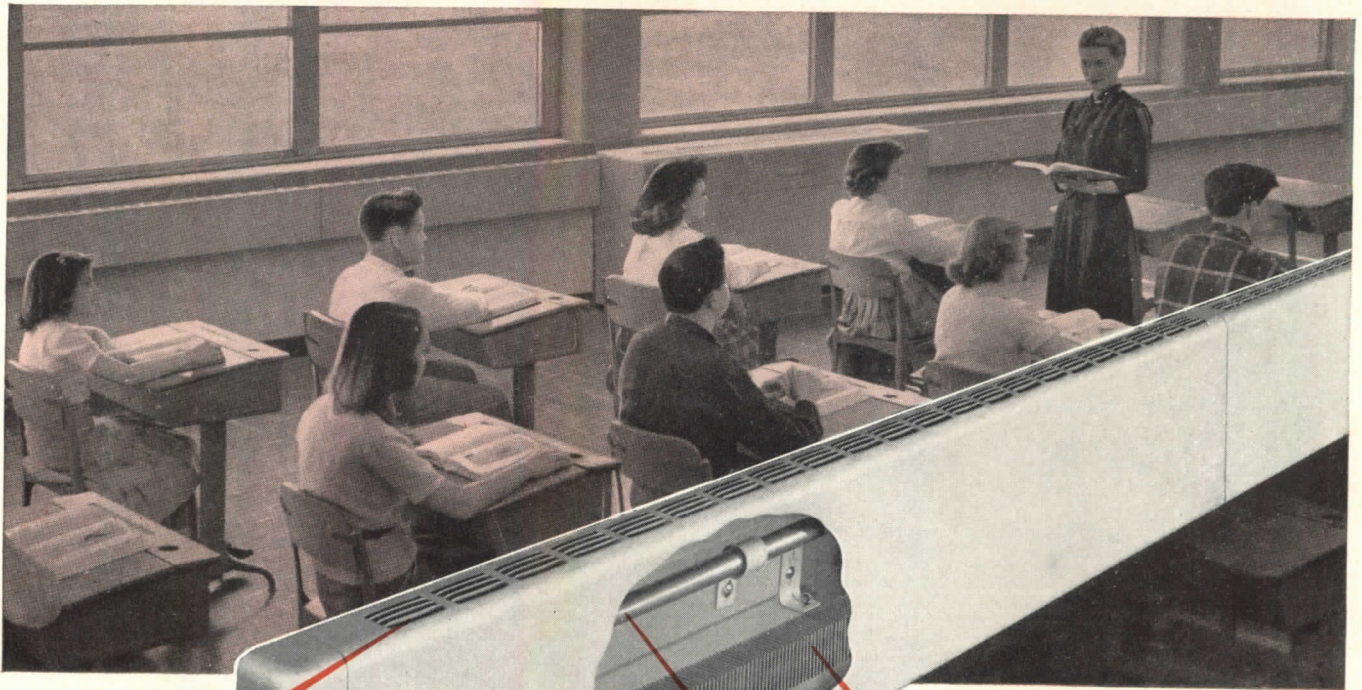

Close-up view shows wall-hung enclosure of WIND·O·LINE radiation. It has intake openings at bottom and discharge louvres of attractive design.

Copper tube, aluminum fins. WIND·O·LINE may be used at either or both ends of the Syncretizer.

Copper supply tube feeds WIND·O·LINE radiation at extreme end. For application with steam or forced hot water systems.

Enclosure front sections fasten to wall panels supporting the radiation. Wall-hung enclosures and storage units are finished to match Syncretizer.

Combinations of standard lengths produce extent of WIND·O·LINE desired (within 6" increments). A round-cornered metal endpiece finishes WIND·O·LINE enclosure.

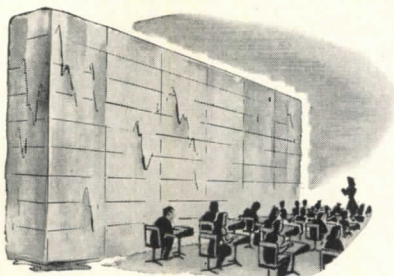

"Wall-of-ice" classrooms are protected by the Nesbitt Syncretizer with WIND·O·LINE.

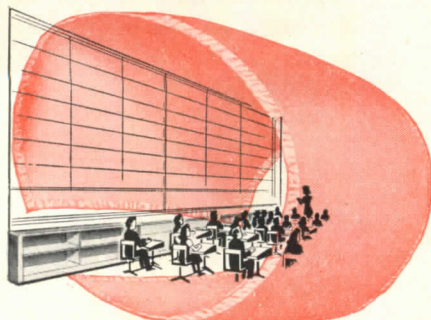

ONLY NESBITT GIVES YOU THIS THERMAL BLANKET

The modern trend toward large classrooms and increased window areas imposes a greater demand upon the heating and ventilating unit to protect room occupants from the exposed wall-of-ice in extremely cold weather while maintaining proper thermal balance throughout the room.

Nesbitt WIND·O·LINE radiation integrated with the Syncretizer provides the extra thermal blanket where it is needed. It is controlled in cycle with the Syncretizer to give heat whenever heat is called for.

WIND·O·LINE is designed for two methods of integration: 1) wall-hung in its own casing; and 2) recessed in the units of The Nesbitt Package.

Wall-hung WIND·O·LINE is used with the free-standing Syncretizer. It is installed just below the windows to extend the full length of the sill.

As a component of The Nesbitt Package, WIND·O·LINE radiation is concealed in a channel at the rear of the storage cabinets which are provided with air-intake openings at the toe-space and attractive grilled outlets at the back of the display board. For further information request Publication 264.

The Nesbitt Syncretizer

MADE AND SOLD BY JOHN J. NESBITT, INC., PHILADELPHIA 36, PA.
SOLD ALSO BY AMERICAN BLOWER CORPORATION

This year's airport plan involves an entirely new scale for listing airports by size. The emphasis now is on service types rather than on numerical classification. For example, the latest plan proposes 2310 personal type airports, 1148 secondary, 656 feeder, 303 trunk, 77 express, 64 continental and 304 seaplane bases and 83 heliports.

Hospital Programs Progress

The May report of the U. S. Public Health Service on Hill-Burton hospital construction showed the total estimated cost of all approved projects fast approaching the \$1150 million mark. The Federal Security Agency constituent disclosed that as of May 31,

it had approved 1552 projects with an estimated construction cost of \$1,148,124,261. The federal share of this cost of building hospitals and health centers was given as \$414,992,513.

A total of 454 of these were shown to be already in operation; 910 others were under construction, and 188 had been only initially approved. In addition, 238 approvals had been given for health centers, and 43 combination general hospitals and health centers had received sanction.

The progress report still indicated the bulk of this program, as it develops, is being located in the southern states. South Carolina leads all other states with 106 project approvals. New projects are being announced at a rate of approximately a score a month.

HHFA Cuts Back

Nearly all the established federal agencies were harassed by anticipated budget cuts during July. Congress had not yet passed the appropriations bills for 1952, but committee work and early action in both branches indicated that most of them would emerge from conference committees considerably reduced from the budget request submitted by the White House.

Housing and Home Finance Agency, as an example, already had begun retrenching in anticipation. Dr. Richard U. Ratcliff, head of the research division, said he feared that cuts on Capitol Hill might reduce his staff to the point of endangering work on research projects now being completed. Data on 65 or 70 of these will be completed and turned in to HHFA during fiscal 1952. When this arrives, it requires much time for analysis and computation, he said, before it can be transformed into usable results.

With a substantial cut in funds in view for this fiscal year, separation notices had gone out to some 30 workers in this division. There were only 120 in all to start with. Dr. Ratcliff said his staff might have to be cut in half.

Earlier, the Public Housing Administration, a HHFA constituent, announced the closing of six field offices as of June 29 because of a necessary reduction in force.

The Boston and Philadelphia field offices were closed. The New York field office will assume responsibility for the

(Continued on page 204)

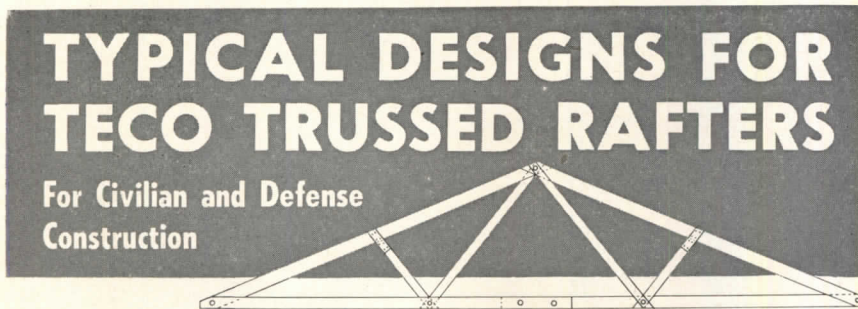

Free TO ARCHITECTS AND ENGINEERS

Over 65,000 residential units and thousands of commercial and industrial buildings have been built with Teco trussed rafters. Architects now have them specified for 17,000 other dwelling units, stores, schools, small warehouses and churches.

By transferring the entire roof and ceiling load to outside walls, clear span Teco rafters eliminate the need for interior bearing walls, thus permitting complete flexibility of floor plans, both during construction and after completion.

Trussed rafters are the key to major savings in both materials and labor—and savings on wall and floor installations also result.

Extra strength and rigidity is insured with Teco Split Ring Connectors in the rafter joints with Tripl-L-Grip Framing Anchors to tie 'em down.

Mail the coupon today for complete, typical designs in spans up to 50'. See for yourself how Teco construction can save on materials and labor.

MAIL COUPON TODAY

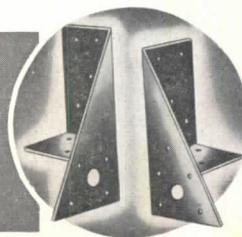

THERE IS PLENTY OF LUMBER FOR ALL NEEDS

Timber Engineering Co., 1319 18th St., N.W., Washington 6, D. C.

Please send me typical Teco Trussed Rafters for a 20' to 50' span as checked:

- 4" in 12" roof slope.....span
- 5" in 12" roof slope.....span
- 6" in 12" roof slope.....span
- 7" in 12" roof slope.....span

Name.....

Address.....

Check here for copy of "Wood Frame Teco Trussed Rafters"

AR

Great Unit Heaters

Another Example of the Completeness of the Trane Heating Line

Not one, not two, but five great Trane Unit Heaters to solve your heating problems exactly. Whether you need a unit for steam, hot water or gas; whether you want vertical discharge or horizontal throw; whether you want to blanket doorways or heat entries—no matter what the unit heater application, there is a Trane product that will fit the project perfectly. Only Trane offers such a complete unit heater line.

Unit Heater Diffusers. Not only is the line complete but it is jam-packed with exclusive Trane features. Outstanding examples are the Trane Louver Cone and Louver Fin Diffusers. With them you put heat exactly where you want it. You can get greater distance of throw. You can change adjustments easily and quickly when job requirements change. You can split the air stream into segments making it possible for one unit to do the work of two. With this greatly increased unit flexibility, you get greater value for your heating dollar.

The Trane Coil. Still another feature is the Trane

Coil—the heart of all steam and hot water units. This is the coil that gives you the solderless mechanical bond for greater heat transfer, the rolled and bushed header joint for leakproof operation, the six-step fin construction for greater sturdiness.

Exclusive features plus five units from which to choose—that's why you'll find the best answer to your unit heater problem in the Trane line.

A Complete Heating Line. You'll also find the right answer to hundreds of other problems in Trane's complete line of heating, ventilating, heat exchange and air conditioning products. Like Trane Unit Heaters, each product offers a wide range of types and sizes from which to select. All are studded with exclusive Trane features. And when you incorporate them into complete systems, you get the added advantages of using products that are designed, tested and built together for service together. Whatever your heating, air conditioning or air handling problem, look for the answer in the complete Trane line.

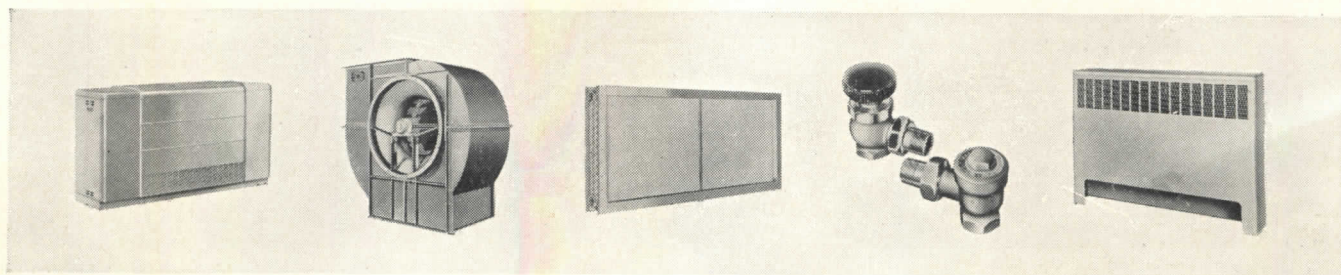

Trane Unit Ventilators—for better schoolroom ventilation

Trane Centrifugal Fans—a complete line with wheels diameter to 109"

Trane Heating Coils—ideal for the central heating system

Trane Steam Specialties—a complete array of traps and valves

Trane Convectors—the room heater that tucks away under the window

THE TRANE COMPANY, LA CROSSE, WISCONSIN

Eastern Mfg. Division, Scranton, Pennsylvania

Trane Company of Canada, Ltd. . . . Toronto

OFFICES IN 80 U.S. AND 14 CANADIAN CITIES

TRANE

HEATING AND AIR CONDITIONING EQUIPMENT

areas formerly covered by Boston and Philadelphia. Director of the New York office is John A. Kervick.

The Detroit field office also was closed, the Chicago office, under William E. Bergeron, taking over jurisdiction. Other PHA offices closed included those at Los Angeles and Seattle, with San Francisco assuming responsibility, and one at Richmond, Va., where the

Atlanta office covered. Director of the San Francisco field office is John G. Melville. M. B. Satterfield heads the Atlanta operation.

Shorts

• A staff report of the Select Committee on Small Business of the House of

Representatives said a number of small businesses have been hurt by NPA's decision to defer consideration of applications for certificates of necessity filed after June 15. NPA said it was not processing these later applications until it had caught up on a backlog of about 7000 cases. Since small business concerns have not been utilized fully in military procurement as yet, the staff report said, not many of them have been in a position to request tax amortization benefits. Now that many large concerns have applied for such benefits, the door has been shut on the little ones, it was argued. Some assurance should be provided that small business firms receive fair and equitable consideration in the granting of these certificates, the staff contended.

• As of July 1, the Housing and Home Finance Agency said it was taking no more applications for interest-free direct loans under the Community Facilities Service program. This ended the Second Advance Planning Program authorized by Congress in 1949. Before the halt, which was in line with the President's budget message earlier in the year, advances had been approved for more than 1200 public works projects; mostly sewer systems, waterworks and schools. Total estimated construction cost of public works so planned was given as \$927,727,157. CFS funds were cut off by Congress in the Independent Appropriations bill for fiscal 1952. HHFA said that applications received prior to June 30 would be considered in the light of holdover funds available, relative urgency of the work contemplated, and relation of the project to defense needs or essential community requirements.

• Producers' stocks of refined copper were the smallest at the end of 1950 of any year since 1906, the Bureau of Mines said in a report on the general copper supply situation last year. During 1950 most segments of the copper producing industry advanced from the lows of the mid-1949 period, however. The latter part of the year saw a continuous rise due to the stimulus of the Korean invasion. During 1950 mine smelter and refinery output from foreign ores was the greatest since 1945, the report showed. Production of copper from old scrap lagged behind other items.

(News continued on page 206)

Architects Specify VAN-PACKER Complete Chimney ...for these 7 reasons

1. There's greater freedom in planning. A Van-Packer installation eliminates the necessity of locating the furnace near the fireplace at one end of the house. Instead the heating plant can be centrally located where it will operate with the greatest efficiency.
 2. The architect knows the exact installed cost of a Van-Packer complete chimney without "guesstimating". He can save up to 50% compared to brick construction and pass these economies on to the buyer.
 3. Van-Packer is easily installed in 3 man-hours or less.
 4. Van-Packer develops sufficient draft for heating plants designed to serve homes of ten rooms or less. Underwriter and F.H.A. accepted for all fuels.
 5. **Maximum Heater Output for Van-Packer 7" I. D. Flue**
- | | | | |
|---------------------|------------------|-----------------------|------------------|
| 20' Floor Suspended | | 10' Ceiling Suspended | |
| Coal | 250,000 B.T.U. | Coal | 150,000 B.T.U. |
| Oil | 300,000 PER HOUR | Oil | 200,000 PER HOUR |
| Gas | 500,000 PER HOUR | Gas | 450,000 PER HOUR |
6. Valuable floor space is saved as a Van-Packer chimney can be hung from the ceiling.
 7. The Van-Packer Chimney is nationally distributed through reliable heating and building material jobbers. Availability and immediate delivery assure you that Van-Packer will be on the job when it's needed.

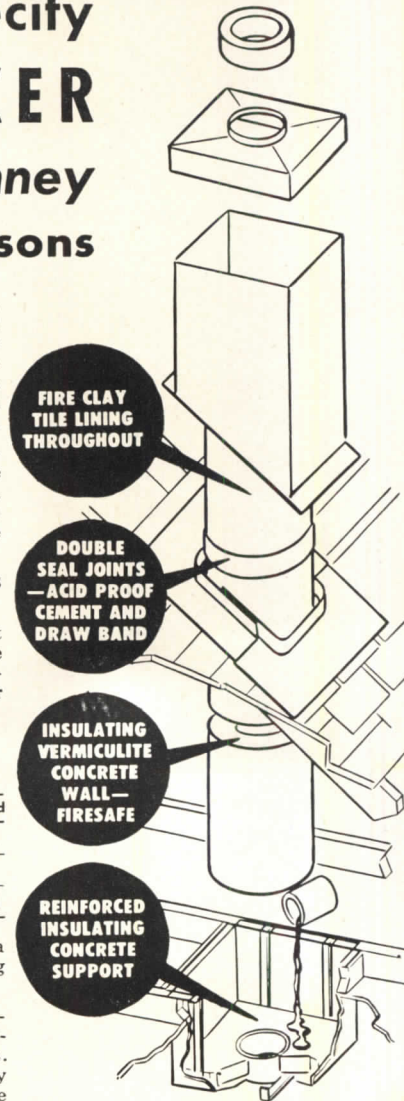

Write for New Architect Sheet!

Van-Packer CORPORATION

209 S. LaSalle St. • Dept. 1408 • Chicago 4, Ill.

Also Manufactured and Distributed in Canada by
C. A. McRobert and Son, Ltd., St. Laurent, Quebec

PORTRAIT OF

Preparedness

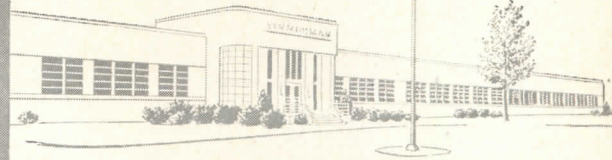

Tinnerman Products, Inc., Cleveland, Ohio
Architects: McGeorge-Hargett & Associates
Builders: The Sam W. Emerson Co.

The new home of SPEED NUT fasteners is a combination of practical planning and architectural artistry, a design-for-efficiency, the last word in modern production and management facilities. But its keynote is an obvious *preparedness* to meet the challenges and opportunities presented by changing economic conditions.



The new Tinnerman building is designed for *flexibility*. Most of its interior space, for offices and factory enclosures, is subdivided by Mills Movable Metal Walls. Pictured at the left is a typical executive office equipped with metal and glass partitions.

Mills Movable Metal Walls are solid, attractive, insulated and sound-proofed. Easily erected, they require practically no maintenance and can be moved—*quickly, conveniently and at very low cost*—to fit any new layout or change in space requirements. Changes can usually be made overnight or during a weekend, without interrupting normal business routine.

This maximum mobility with minimum labor is the result of the *demonstrably superior quality* of Mills Movable Metal Walls, developed through more than 30 years of accepting complete responsibility for their design, construction and installation.

MILLS *Movable* METAL WALLS



Those who look to you for the answers to their space problems will never be the victims of "frozen space"—an obstacle to *preparedness*—if you equip their buildings with Mills Movable Metal Walls. Write for Mills Catalog No. 51. We will be happy to give you further information upon request.

THE MILLS COMPANY • 957 WAYSIDE ROAD • CLEVELAND 10, OHIO



ON THE CALENDAR

Current through Aug. 12: Small exhibition of Le Corbusier architecture, painting and design. A model of the Villa Savoye, two paintings, two chairs and a perspective drawing, all done around 1930 — Museum of Modern Art, 11 W. 53rd St., New York City.

Current through Sept. 8: Exhibition on

“100 Years of British Architecture” — Royal Institute of British Architects, 66 Portland Place, London.

Current through Sept. 30: Festival of Britain, including architectural exposition on main festival grounds, south bank of Thames, London — London and throughout British Isles.

Current throughout 1951: 1951 Good Design, second in the series of well-designed home furnishings exhibitions,

sponsored by the Museum of Modern Art and the Merchandise Mart — The Merchandise Mart, Chicago.

Aug. 2-5: Midsummer Conference, Michigan Society of Architects — Grand Hotel, Mackinac Island, Mich.

Aug. 13-25: Special summer course in Swedish Decorative Arts and Architecture — Swedish Institute, Kungsgatan 34, Stockholm 3, Sweden.

Aug. 14-16: National Conference on prestressed concrete — Massachusetts Institute of Technology, Cambridge.

Aug. 20-23: Pacific General Meeting, American Institute of Electrical Engineers — Multnomah Hotel, Portland, Ore.

Aug. 27-30: National Technical Conference, Illuminating Engineering Society — Hotel Shoreham, Washington.

Aug. 27-Sept. 7: “The Role of Engineering in Nuclear Energy Development,” third annual summer symposium sponsored by Oak Ridge National Laboratory and Oak Ridge Institute of Nuclear Studies — Oak Ridge, Tenn.

Sept. 1-Oct. 6: Architects’ Fall Trek to Europe, under leadership of Clair W. Ditchy, F.A.I.A.

Sept. 4-18: 13th Annual Conference on city and regional planning — Massachusetts Institute of Technology, Cambridge, Mass.

Sept. 11-20: Building Research Congress, with headquarters at Institution of Civil Engineers, London. Details from: The Organizing Secretary, Building Research Station, Bucknalls Lane, Garston, Watford, Herts, England.

Sept. 16-21: National Convention, American Society of Sanitary Engineers — Hotel Statler, Detroit.

Sept. 17-20: 53rd Annual Convention, American Hospital Association — St. Louis, Mo.

Sept. 23-30: Second Annual Congress, Union Internationale des Architectes — Rabat, Morocco.

Sept. 28-29: Fall Meeting, Virginia Chapter, American Institute of Architects — Hotel Natural Bridge, Natural Bridge, Va.

Sept. 29-Oct. 9: Building and Decoration Exhibition, sponsored by N. V. Standard Boekhandel — Antwerp, Belgium.

Oct. 4-6: Annual Convention, California Council of Architects — Coronado, Calif.

Oct. 8-12: 39th National Safety Congress and Exposition, National Safety Council — Chicago, Ill.

Oct. 11-13: Annual Convention, New York State Association of Architects — Buffalo, N. Y. (Continued on page 208)

Premium Quality
Yet Moderately Priced

AZPHLEX

ASPHALT TILE

Gives More Value for Your Flooring Dollar!

If you look at Azphlex Asphalt Tile and see its outstanding beauty . . . learn about its premium-quality, grease-resistant features . . . and then look at the price tag, you have a pleasant surprise in store! This superior tile is priced far lower than its quality and color range would suggest — actually costs just a few cents a square foot more than ordinary asphalt tile. We invite you to compare Azphlex, feature for feature — including price — with any other resilient floor covering.

Highly Resistant

to greases, fats, oils, soaps and compounds

Tough Surfaced

for increased resistance to indentation and abrasion

Wide Color Range

15 clear, permanent colors

Moderate Price

is only a few cents more a square foot than ordinary asphalt tile

For a floor that gives maximum service — look to **AZPHLEX!**

For complete information see or call your flooring dealer or contractor—or write to Dept. C

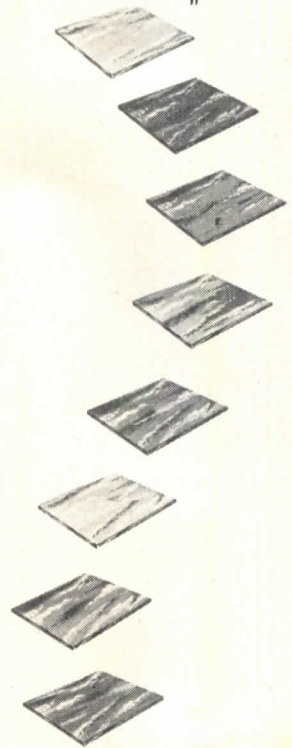

UVALDE ROCK ASPHALT CO.

Makers of AZPHLEX and AZROCK Asphalt Tile
FROST BANK BLDG. • SAN ANTONIO, TEXAS

SEE SWEETS' 1951
CATALOG FOR
COLORS AND SIZES

Above or below ground—CAST IRON SOIL PIPE



WALLS ARE PERMANENT— put permanent piping in them!

Generations of performance tell you that **cast iron soil pipe . . . and fittings**—are the plumbing material that you can specify with complete confidence. You know how expensive and troublesome it is to rip out walls when it becomes necessary to replace pipe—sometimes within a relatively few years from the time the building was put up!

That's the kind of headache that can be eliminated

on the drawing board, when you're advising your client on what material should be used for the lifeline of his building. Your reputation cannot be harmed when you specify soil and waste disposal lines that time has tested, year in, year out—*decade after decade*.

• • • • •

From roof vent to street sewer, you can't beat **cast iron soil pipe . . . and fittings**.

CAST IRON SOIL PIPE INSTITUTE

Heurich Building, 1627 K. St. N.W., Washington 6, D. C.

This advertisement is sponsored by



CAST IRON SOIL PIPE INSTITUTE

Alabama Pipe Company
The American Brass & Iron Foundry
Anniston Foundry Company
Anniston Soil Pipe Company
Attalla Pipe & Foundry Company, Inc.
Buffalo Pipe & Foundry Corporation
The Central Foundry Company
Charlotte Pipe & Foundry Company
Combustion Engineering—Superheater, Inc.
Crown Pipe & Foundry, Inc.
The Eastern Foundry Company
East Penn Foundry Company
Emory Pipe & Foundry Company
Hajoca Corporation

Herco Foundry, Inc.
T. C. King Pipe & Foundry Company
Pacific Cast Iron Pipe & Fitting Company
Peerless Pipe & Foundry Company, Inc.
Reading Foundry Company
Rich Manufacturing Company of California
Rudisill Foundry Company
Sanitary Company of America
Somerville Iron Works
Tyler Pipe & Foundry Company
Walker Machine & Foundry Corporation
Western Foundry Company
Williamstown Foundry Corporation

Oct. 9-12: 18th Annual Conference, National Association of Housing Officials — Hotel Statler, Washington.

Oct. 12-13: Fall Meeting, Alabama Society of Architects — Auburn, Ala.

Oct. 17-19: Annual Convention, Architects Society of Ohio — Hotel Deshler, Columbus, Ohio.

Oct. 22-24: 33rd Annual Meeting, American Standards Association —

Waldorf Astoria Hotel, New York City.

Oct. 22-26: Fall General Meeting, American Institute of Electrical Engineers — Hotel Cleveland, Cleveland, Ohio.

Oct. 26-27: Annual Meeting and design seminar, Gulf States Regional Council, American Institute of Architects, and Annual Convention, Louisiana Architects Assn. — Memphis, Tenn.

New Firms, Firm Changes

• Edward F. Brueggeman, Guy W. Swaim and William S. Allen, practicing architecture formerly as Brueggeman, Swaim & Allen, have announced the dissolution of the partnership.

Mr. Brueggeman will continue the practice of architecture under the firm name of Edward F. Brueggeman, Architect, 808 Pyramid Bldg., Little Rock, Ark.

Mr. Swaim and Mr. Allen will continue to practice architecture as Swaim and Allen, Architects, Gazette Bldg., Suite 331, Little Rock, Ark.

• Geves G. Kenny, A.I.A., and Burt W. Stevens, A.I.A., announce the formation of a partnership for the practice of architecture under the firm name Kenny and Stevens, Architects, with offices at 311 Kenilworth Drive, Akron 3, Ohio.

• Edgar V. Ullrich, Architect, and Patrick J. Moore, Consulting Engineer, have formed an association under the firm name of Ullrich and Moore, Architects and Engineers, with offices at 1501 E St., San Bernardino, Calif.

New Addresses

The following new addresses have been announced:

Abreu & Robeson, Inc., Architects and Engineers, 141 Walton St., N. W., Atlanta, Ga.

Irving Feirtag, Architect and Designer, 104 W. 64th St., New York 23, N. Y.

The Kuljian Corporation, Engineers and Constructors, 1832 K St., N. W., Washington 6, D. C.

Norman Millett, Architect, 20 N. Wacker Dr., Chicago, Ill.

Charles Clark Reynold, Architect, P.O. Box 46, Boulder Junction, Wisc.

Leo L. Sheinfeld, Architect, 7 Water St., Boston, Mass.

W. C. Stohldrier, Architect, 127 Parkway Rd., Bronxville 8, N. Y.

James A. Watson, Architect, 29 Kinross Pl., Yonkers 3, N. Y.

AT THE COLLEGES

M.I.T. Sponsors Meeting on City and Regional Planning

The thirteenth annual conference on city and regional planning will be held

(Continued on page 212)

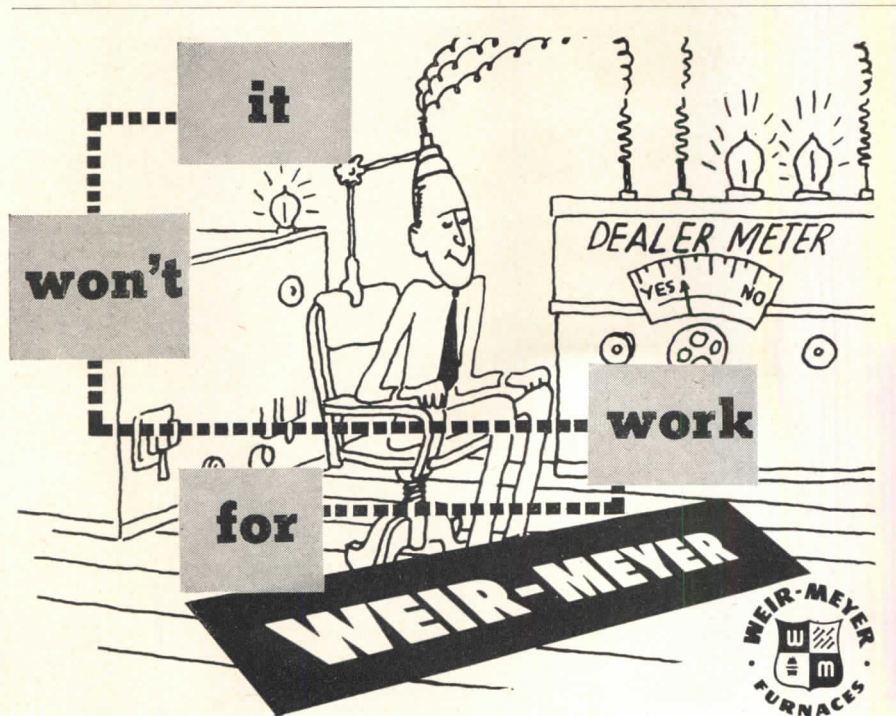

Why is our choice of dealers important to you as an architect or consulting engineer? Because no matter how much quality we build into a furnace—it takes proper installation to turn that quality into owner-satisfying performance!

And there's no "machine method" . . . no "quick, easy way" to pick a dealer. It takes plenty of personal contact and investigation by experienced WEIR-MEYER representatives.

We won't let a dealer sell WEIR-MEYER unless he has adequate personnel, equipment and "know-how." He must be a reliable, recognized heating contractor, capable of providing any servicing a heating system might possibly require.

This way, you're sure of complete customer satisfaction when you specify WEIR-MEYER—because you're "ordering" a top-quality dealer as well as top-quality equipment.

THE MEYER FURNACE CO. • PEORIA 2, ILL.
Manufacturers of Weir & Meyer Furnaces • Air Conditioners
for Gas—Oil—Coal • Factories: Peoria and Peru, Illinois

This coupon brings you the AIA File Catalog on the complete WEIR-MEYER line.

THE MEYER FURNACE CO.
Architects Service Division
Peoria 2, Illinois

Please send AIA File Catalog on the complete WEIR-MEYER steel warm air line.

NAME _____

STREET _____

CITY _____ STATE _____

FILL OUT OR CLIP COUPON TO YOUR LETTERHEAD

WEIR-MEYER FURNACES • AIR CONDITIONERS

ARCHITECTS and BUILDERS

tell how they

use Sweet's File

to select, specify, and buy

Milton Nelson, Chief Architect
Charles A. Maguire and Associates
Providence, Boston, and New York

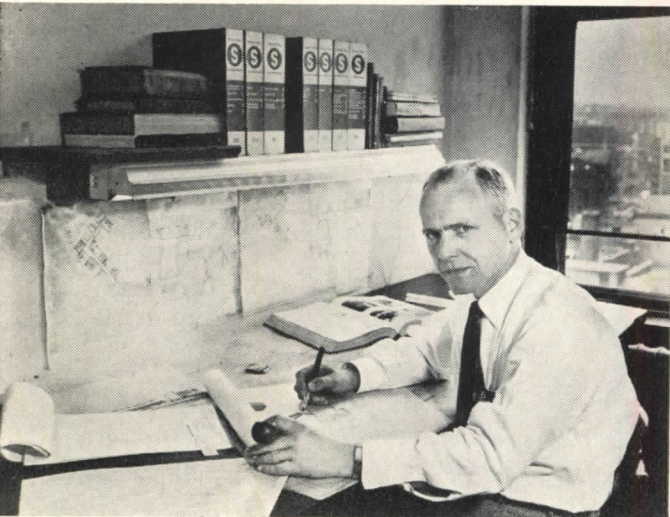

"Our right-hand man"

says Milton Nelson

"On the Mt. St. Mary's job, just as on all others, Sweet's File was our right-hand man. In our office, we're constantly working on all kinds of projects, and consequently, we receive hundreds of pamphlets, booklets and catalogs each year. Seventy-five to eighty per cent of these go into the wastepaper basket—it's just too difficult to keep them in order.

"In Sweet's, we get the information we need to specify or to select a product so that we can contact the manufacturer's local representative for final details. One thing that certainly helps is that Sweet's is brought up to date each year so that we know we have the latest information on new developments and applications.

"Another thing that is helpful is the three-way index which makes finding the catalogs you want so easy. Take the convent job, for example. Several years ago we had used a certain type of pre-cast floor and roof construction, but we didn't know whether the company was still in business. We found their catalog in Sweet's, saw that they could give us what we wanted, got the name of their nearest licensed fabricator from the back of their catalog, and were in touch with him in a matter of minutes. This is typical of what happens in this office every day.

"One thing we would like to see is all manufacturers include the manufacturing specifications on their products—it would help us get a better line on relative advantages."

"A great help"

says Edward P. Turgeon

"I don't think a day goes by that we don't refer to Sweet's File in our office. On the Wrentham job it was a great help.

"We use Sweet's for getting all kinds of information on specified products, and for finding out about other products when a substitution is in order. This is a lot better than floundering around trying to find some local distributor who can give us the data on a product we may need right away. We know that all worth-while products are catalogued in Sweet's, and, therefore, there's no sense in going further—we just don't have the time.

"The indexing system of the File, set up so that we can find exactly what we are looking for with the least trouble, is really a great boon to the busy contractor.

"However, I would like to see more manufacturers show their detail drawings to an architect's scale, with the scale identified. It would help us a great deal. In line with this, some catalogs in Sweet's File are more complete than others, and the information in them is easier to find. The manufacturer who has the better catalog stands a much better chance of having his products used."

Catalog Service

DIVISION OF F. W. DODGE CORPORATION

119 WEST 40th STREET, NEW YORK 18, N. Y.

THE RECORD REPORTS

(Continued from page 208)

at the Massachusetts Institute of Technology for two weeks beginning Tuesday, September 4.

The conference is open to practising professionals, members of planning commissions and housing authorities, and men and women with practical experience in a related field. It has been arranged to meet the need for an intensive course covering both the ad-

ministrative and technical aspects of planning.

Morning and afternoon sessions will be conducted under the direction of Frederick J. Adams, head of the department of city and regional planning at M.I.T., and Flavel Shurtleff, expert in planning legislation. Fee for the two weeks will be \$50.

Requests for further information and

applications should be addressed to: Prof. Burnham Kelly, Room 7-335, Massachusetts Institute of Technology, Cambridge 39, Mass.

Awards

• Bruce E. Gerwig of North Hills, Pa., a graduate of Pennsylvania State College, has been awarded the John Stewardson Memorial Scholarship in Architecture for 1951. The scholarship, which is open to residents of Pennsylvania, provides funds for travel of six months or more in foreign countries. By special arrangement with the committee, Mr. Gerwig has been permitted to postpone his travels until his release from military service. He plans to visit Italy, France, England, Sweden and the Low Countries.

• The College of Architecture and Design of the University of Michigan has announced the second award of the Harley, Ellington and Day Scholarship to Tivadar Balogh of Detroit. The scholarship, which carries a \$1000 stipend, is given to an outstanding student about to enter his senior year of architectural design.

• Eugene Raskin, assistant professor of architecture at Columbia University, has been awarded a Langley Fellowship for 1951-52 by the American Institute of Architects. The award will allow Professor Raskin, who will be on sabbatical leave from Columbia next year, to write a book on the theory of architecture.

• Edward L. Ryerson Traveling Fellows in Architecture and Landscape Architecture have been appointed for the first time by the University of Illinois. The Fellow in Architecture is Raymond C. Ovresat of Chicago and the Fellow in Landscape Architecture is Charles W. Harris of Danville, Ind.

Alternates are: architecture — first alternate, George C. Winterowd of Overland, Mo., and second alternate — James A. Scheeler of Graymont, Ill.; alternate in landscape architecture — Lyle Aten of McComb, Ill.

The Ryerson Fellowships were endowed in 1926 by the late Edward L. Ryerson of Chicago to promote advanced studies in architecture and landscape architecture through European travel. The Fellowships were administered up to 1950 by the Lake Forest Foundation, but no Fellows were appointed after the beginning of World War II. In July of last year, Edward L.

(Continued on page 214)

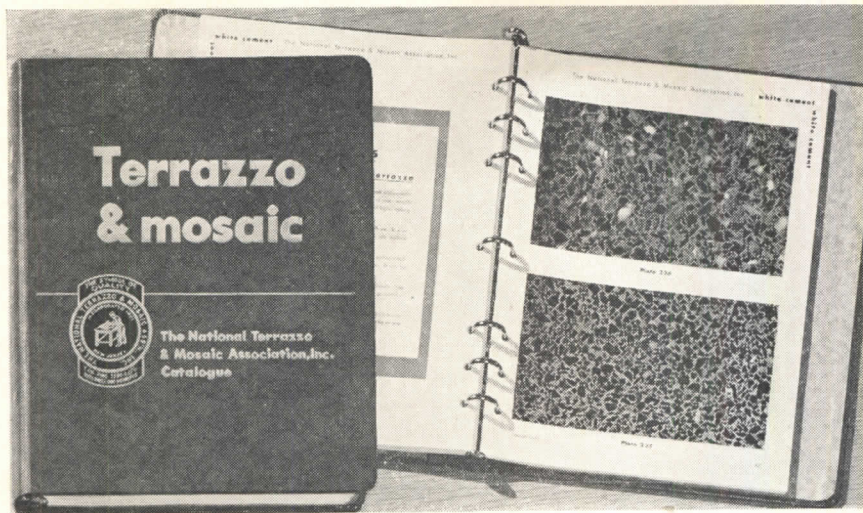

NEW *Terrazzo* CATALOGUE NOW AVAILABLE

Makes Architect's Job Easier By Showing:

- 100 Terrazzo Color Plates
- Typical Installations
- Architectural Details
- Specifications for Grounded Grilles, Radiant Heating, Non-Slip, and Outdoor Installations

NOW YOU CAN HELP your clients visualize the enduring beauty of TERRAZZO. Handsome new 136-page loose-leaf *Catalogue and Design Book* shows color plates of many of the infinite combinations of color and patterns available in marble-hard, concrete-durable TERRAZZO; provides illustrations of typical installations; offers architectural data on tested methods of installation and maintenance; presents in one compact, easy-to-file volume a wealth of material you'll want to keep at your finger-tips. Order your copy at once—directly from the Association, or from your local Association member. Price: \$10.

THE NATIONAL TERRAZZO AND MOSAIC ASSOCIATION, INC.

711 14th Street, N.W.

Dept. R

Washington 5, D. C.



PRIDE in your work

is shared by
this sound conditioning expert

You see a finished structure, translated from your imagination and skill into a building with beauty and usefulness . . . and of course you're proud. This pride is shared by your Distributor of Acousti-Celotex Products because he helped you achieve effective sound conditioning . . . *just as you planned it*, with out tampering or compromise.

Your specifications are a trust to this Sound Conditioning expert. The trust is backed by experience . . . *active* responsibility in solving specific problems of sound conditioning. His service to you is based on professional training, knowledge of job-proved methods, and a complete line of top-quality materials necessary to meet every specification, every requirement, every building code.

Call in your Acousti-Celotex Distributor at the planning stage. His service will continue until the problems are solved and the installation is completed . . . completed *just as you planned it*. To be sure . . . that every solution to sound conditioning problems has the appearance you imagined, the efficiency you demanded, consult your local Distributor of Acousti-Celotex Products, your conveniently located representative of the world's most experienced Sound Conditioning organization.

TOPS IN WASHABILITY

Two coats of tough finish bonded under pressure of a hot knurling iron builds a surface of superior washability right into Celotex Cane Fibre Tile.

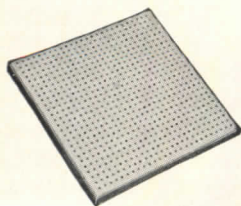

**ACOUSTI-CELOTEX*
CANE FIBRE TILE**

A lightweight, rigid unit, combining acoustical efficiency with a durable, smooth surface. Perforations (to within 1/8" of the back) assure repeated paintability, easy maintenance. Available in a variety of sound-absorbent ratings. Dry rot proofed by exclusive Ferox* process.

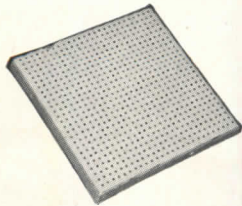

**ACOUSTI-CELOTEX*
MINERAL TILE**

Made of mineral fibre, felted with a binder to form a rigid tile with a universal rating of incombustibility. Perforated with small holes extending almost to the back, this tile provides high acoustical absorption plus unrestricted paintability by either brush or spray method.

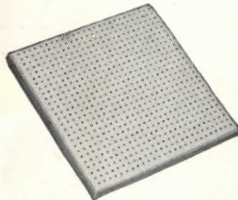

**ACOUSTI-CELOTEX*
FLAME-RESISTANT
SURFACED TILE**

A cane fibre tile with a flame-resistant surface. This tile meets *Slow Burning* rating contained in Federal Specifications SS-A-118a. It may be washed with any commonly used solution, satisfactory for good quality oil-base paint finishes, without impairing its flame-resistant surface characteristics and without loss of sound-absorbing capacity. Repainting with Duo-Tex flame-retarding paint will maintain peak efficiency. Supplied in all sizes and thicknesses of regular cane tile.

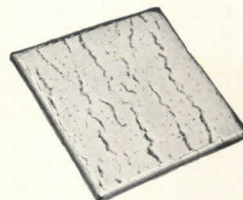

**ACOUSTI-CELOTEX
FISSURETONE***

A totally new mineral fibre acoustical tile. Attractively styled to simulate travertine. It beautifies any interior and effectively controls sound reverberation. Lightweight, rigid and incombustible, it is factory-finished in a soft, flat white of high light-reflection rating.

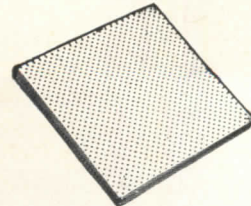

ACOUSTEEL*

Combines a face of perforated steel with a rigid pad of sound-absorbing Rock Wool to provide excellent sound-absorption, together with attractive appearance, durability and incombustibility. The exposed surface of perforated steel is finished in baked-on enamel. Acousteeel is paintable, washable, cleanable.

*Trademarks Reg. U. S. Pat. Off.

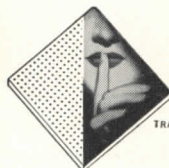

ACOUSTI-CELOTEX
TRADEMARK REGISTERED U. S. PAT. OFF.

Sound Conditioning Products

PRODUCTS FOR EVERY SOUND CONDITIONING PROBLEM

120 S. La Salle St., Chicago 3, Illinois
Dominion Sound Equipments, Ltd., Montreal, Quebec, Canada

THE RECORD REPORTS

(Continued from page 212)

Ryerson Jr., transferred the Foundation's endowment to the University of Illinois.

Each Fellow receives a stipend of \$1600 to be used for at least six months' travel and study in Europe. The interrelationship of architecture and landscape architecture is stressed in the requirement that each pair of Fellows must travel together for at least three of the six months.

Fellows are nominated by the departmental committees on the basis of outstanding ability, personality, and professional promise as demonstrated by the candidate's academic record, evaluation by the faculty, and leadership.

The Fellowship in Architecture is awarded to a graduate in the general option who has received his degree in the calendar year preceding the award. The Fellow in Landscape Architecture

must have received the Bachelor or Master degree in Landscape Architecture, or the Master degree in city planning, during the year.

- The American Institute of Steel Construction has announced the winners for 1951 of the 10 scholarships in civil engineering awarded annually by the Institute. The winners, who will each receive a \$1000 scholarship, were selected from a group of 52 high school seniors nominated by steel fabricating companies for the nationwide competition. The scholarship may be used at any engineering school on the approved list of accredited institutions.

Winners, and their sponsoring companies, are: Maurice J. Criswell, Baltimore — Dietrich Brothers, Inc., Baltimore; John Frey, Livingston, N. J. — Schacht Steel Construction, Inc., Hillside, N. J.; Ronald Haase, Milwaukee — Wisconsin Bridge & Iron Co., Milwaukee; Kerry S. Havner, Tulsa — Patterson Steel Co., Tulsa; Twyman Jones, Missouri Valley, Ia. — Gate City Steel Works, Inc., Omaha; Robert Longo, Cranston, R. I. — Providence Steel & Iron Co., Providence; Elliott B. Perrett Jr., Pittsfield, Mass. — Haarmann Steel Co., Holyoke; James H. Rider, Providence, R. I. — James E. Cox Co., Inc., Fall River, Mass.; Richard Robbins, Milwaukee, Wisc. — Milwaukee Bridge Co., Milwaukee.

Scholarships, Fellowships

- Two scholarships for seniors have been established at the Massachusetts Institute of Technology by Harry A. Kuljian, Philadelphia engineer and head of the engineering firm bearing his name.

The scholarships, \$500 each, are intended to help promising engineering students round out their education in world affairs, traditions, economics and humanities and thus "gain a better understanding of human relations in applying their technical training."

The creation of the new School of Humanities and Social Studies at M.I.T. encouraged Mr. Kuljian to establish these scholarships, and at his request candidates for them are to be nominated by Dean John E. Burchard.

- A "Co-ordinated Classroom Fellowship" has been established in the Division of School Planning of the School of Education of Stanford University.

The Fellowship is to be used in con-
(Continued on page 216)

For day in, day out
DEPENDABILITY
you can't beat a

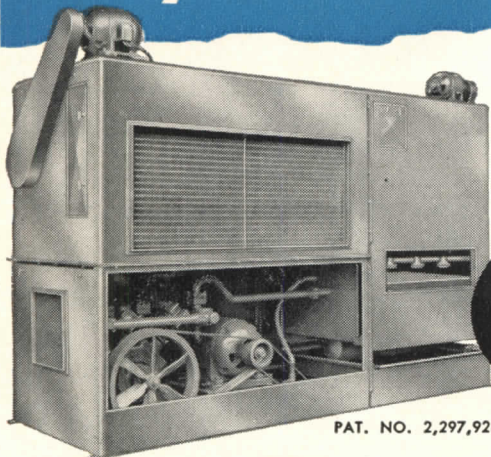

PAT. NO. 2,297,928

GOVERNNAIR
COMPLETELY PACKAGED
AIR CONDITIONER

Name your job . . . any air conditioning job requiring from 3 to 50 tons . . . and you'll find that you can't beat a Governair system for day in, day out dependability.

Governair Packaged Air Conditioners are designed to

operate at peak efficiency— with all parts precision-matched to work together. And they're built to give years and years of low-cost trouble-free service.

Choose Governair . . . and you choose the best!



AIR CONDITIONERS

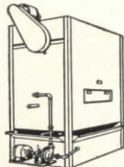

EVAPORATIVE CONDENSERS



COOLING TOWERS



UNIT COOLERS



BLAST COILS FOR HEATING AND COOLING

ORIGINATORS OF COMPLETELY PACKAGED AIR CONDITIONERS

GOVERNNAIR

GOVERNNAIR CORPORATION • 513 N. BLACKWELDER • OKLAHOMA CITY, OKLA.

Flexible lighting system that can be easily changed without rewiring

Move or add lights
anytime, anywhere with
BullDog Universal Trol-E-Duct

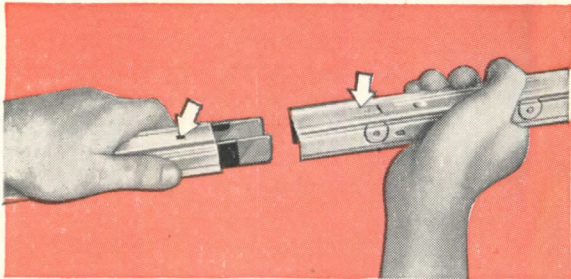

Duct sections are joined without tools, nuts or screws. Prefabricated and standardized in lengths from one to ten feet, they can be dismantled and reinstalled anytime, anywhere without scrapping a single part.

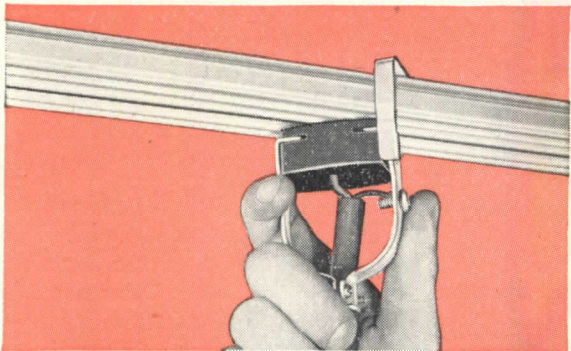

To tap off power at any point along the slot, simply insert twist-out plug and give it a 90° turn. Plugs are grounded on steel casing before contacts touch bus bars; narrow-access slot protects operator.

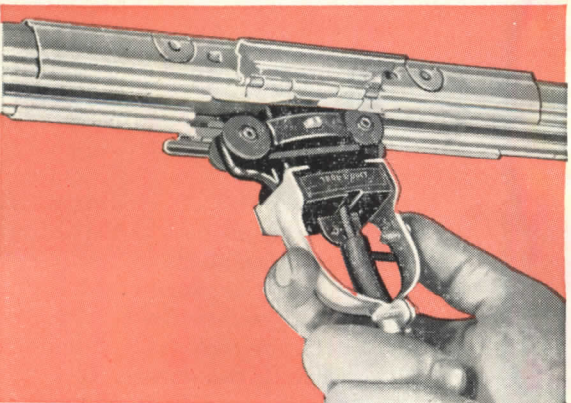

Trolley-type outlets are used where mobility is a prime requisite—such as for small portable tools or for drop-cord lighting in stock bins and inspection areas.



Safe, simple, quick! Tap off power from totally enclosed bus bars at any point along the continuously slotted duct with handy trolleys or twist-out plugs. Universal Trol-E-Duct both supports and supplies current to these fluorescent lighting fixtures.

Meet changing conditions quickly, economically with this truly flexible lighting system.

To move or add lights, simply pick the right spot and insert handy twist-out plug or trolley. Every inch of this money-saving 50-ampere duct system is a tap-off! Prefabricated and standardized in lengths from one to ten feet, it can be dismantled and moved to a new location without scrapping a single part.

Call in your nearby BullDog Field Engineer for more information about this modern lighting system. He will be glad to show you an installation near your own plant. Or write BullDog direct for descriptive literature.

BULLDOG ELECTRIC PRODUCTS COMPANY

DETROIT 32, MICHIGAN — FIELD OFFICES IN ALL PRINCIPAL CITIES

IN CANADA: BULLDOG ELECTRIC PRODUCTS OF CANADA, LTD., TORONTO



BULLDOG

HEADQUARTERS FOR ELECTRICAL DISTRIBUTION

nection with a program which the Division now has under way jointly with Dr. Darell B. Harmon. Holder of the grant will study effects of physical factors in the classroom upon the development, health and learning of school children, with particular emphasis on the study of the effects of classroom lighting, decoration, heating and equip-

ment upon growing children.

The Fellowship was made possible through grants from the American Structural Products Co., the American Seating Co., the Minneapolis-Honeywell Regulator Co., the National Chemical and Manufacturing Co., Pittsburgh Corning Corp., the F. W. Wakefield Brass Co., and the Weber Costello Co.

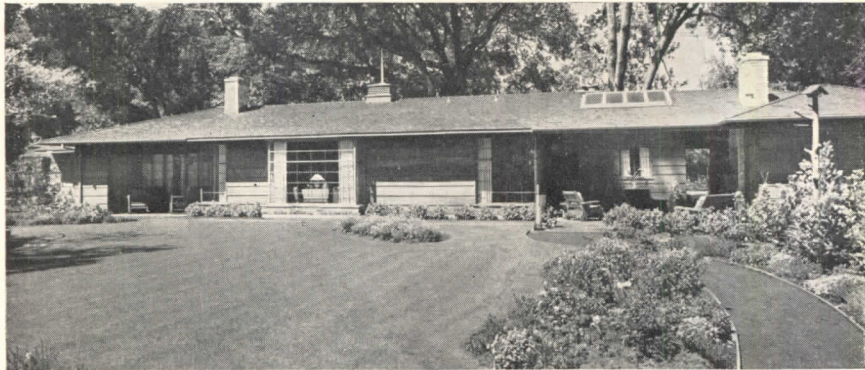

Angus McSweeney, Architect
San Francisco, Calif.

NOW YOU CAN GIVE INTERESTING VARIETY TO REDWOOD

Cabot's finishes for exterior redwood produce new and attractive effects. Whether your problem is to preserve the native color, give uniformity of color or bleach to the unique beauty of driftwood grey, you'll find pleasing results with Cabot's Finishes for Exterior Redwood.

INVESTIGATE THESE 5 EFFECTS

- **Cabot's 325 California Redwood Stain** — specially blended pigments compounded in creosote oil to capture and preserve the natural color of new Redwood.
- **Cabot's 3625 Sequoia Red Stain** — same color as Cabot's California Redwood Stain but with heavier pigmentation and greater hiding power.
- **Cabot's 351 Eucalyptus Grey Creosote Stain** — a delicate greenish grey color that brings out the grain.
- **Cabot's 241 Creosote Bleaching Oil** — bleaches wood to weather-beaten driftwood grey, developing gradually during 6 months' exposure.

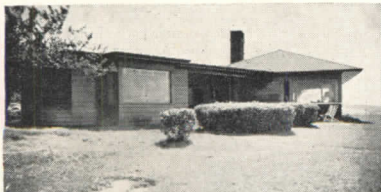

Gordon B. Wyland, Architect
Oneida, N. Y.

- **Cabot's 800 Clear Gloss Finish** — a transparent waterproof finish producing a lustrous gloss . . . particularly designed for Redwood. For flat effect use Cabot's 230 Colorless Creosote Stain.

Write Today for folder "Redwood Staining," and color card showing Cabot's finishes for Redwood.

SAMUEL CABOT, INC.

829 Oliver Building, Boston 9, Massachusetts

Faculty Appointments

• Gano Dunn, chief executive officer of the Cooper Union, has been given the title of chairman of the trustees of the Cooper Union. Edwin Sharp Burdell, chief educational executive, exchanges his former title of director for that of president.

• Dr. Boris A. Bakhmeteff, professor of civil engineering at Columbia University since 1931, has recently been made an Honorary Professor of Civil Engineering as well.

Doctor Bakhmeteff, known for his work in the field of modern fluid mechanics and hydraulics, is the fourth person in Columbia history to receive an appointment as Honorary Professor. Dr. Theodore von Karman, director of the Guggenheim Aeronautical Laboratory at the California Institute of Technology, is Columbia's only other living Honorary Professor.

• Two appointments at the Institute of Design of Illinois Institute of Technology have recently been announced. Charles L. Forberg, 31, of Minneapolis has been named an assistant professor and Albert Szabo, 25, has been named an instructor.

ELECTIONS APPOINTMENTS

• Eugene F. Magenau of Concord has been elected president of the New Hampshire Chapter of the American Institute of Architects. Other new officers are: Nicholas Isaak, Manchester — vice president; William L. White, Exeter — secretary; Stewart Lyford, Concord — treasurer; Malcolm D. Hildreth, Nashua, Richard Koehler, Manchester and Stephen P. Tracy, Nashua — directors.

• Eero Saarinen has succeeded the late Andrew R. Morison as president of the Detroit Chapter of the American Institute of Architects.

• L. Morgan Yost of Kenilworth, Ill., was reelected president of the Chicago Chapter of the American Institute of Architects at its annual meeting in June. Other officers, reelected without opposition, are Albert F. Heino, first vice president; and Edward L. Burch, treasurer. Philip Will Jr. was elected second vice president; Lee C. Mielke,

(Continued on page 218)

EASIEST TO INSTALL!

Because H. B. Smith cast iron boilers are assembled from precision-machined sections and parts, they are easily erected at the installation with a minimum of labor.

EASIEST TO EXPAND!

When increasing the capacity of an H. B. Smith boiler to meet additional heating requirements, or when replacing it, it is not necessary to tear out a wall, part of a foundation, or both.

EASIEST TO CONVERT!

H. B. Smith boilers are easiest to convert to different fuels, should the one in use become in critical supply. All operate with great efficiency with solid fuel, oil or gas. In low-cost natural gas areas, H. B. Smith boiler conversions are bringing clean, trouble-free, inexpensive heat to hundreds of users.

Give Your Customers the Benefit
of the World's Broadest Line!

H. B. *Smith*
**CAST IRON BOILERS
FOR HEATING AND
DOMESTIC HOT WATER**

100 Boiler-Burner Unit Means More Home Sales ▶

Compact, easy to install! Designed to give fast heat and plenty of hot water for the average home. Furnished with built-in tank type or

"tankless" water heater; available with flush jacket as shown, or with jacket expanded to conceal the oil burner.

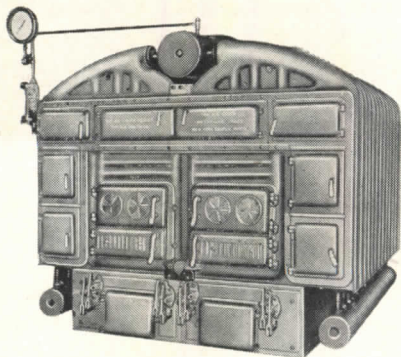

◀ 60 Smith Boiler For Largest Installations

May be used singly, or in batteries for heating loads up to and over 100,000 sq. ft. steam radiation. Many of these large units installed in industrial plants furnish steam for process requirements as well as for heating and domestic hot water.

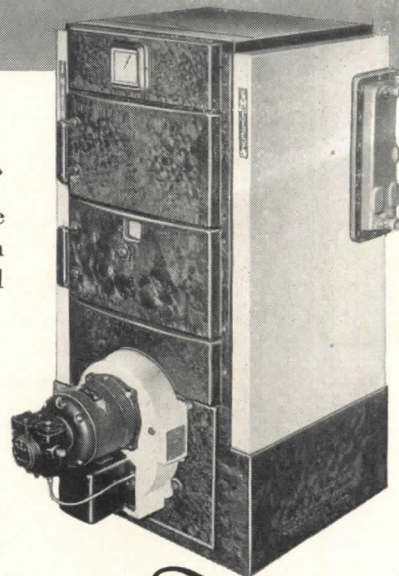

H. B. *Smith*
THE H. B. SMITH CO., INC.
Westfield, Mass.

THE RECORD REPORTS

(Continued from page 216)

secretary; and Samuel A. Lichtmann, a director for four years.

• Samuel G. Hibben, director of applied lighting for Westinghouse Electric Corp., has been elected president of the Illuminating Engineering Society.

Other officers elected are: A. H. Manwaring, Philadelphia Electrical & Mfg. Co., Philadelphia — vice president; R. F. Hartenstein, Ohio Edison Co.,

Akron — treasurer; C. C. Keller, Holophane Co., Inc., New York — general secretary; C. W. Beals, The Miller Co., Meriden, Conn., and J. S. Schuchert, Duquesne Light Co., Pittsburgh — directors.

Vice President E. M. Strong of Cornell University, Ithaca, continues in the second year of his two-year term.

Regional vice presidents starting two-year terms October 1 are: Canadian

region — F. P. Labey, Northern Electric Co., Ltd., Montreal; East Central Region — Paul H. Hildebrand, Pennsylvania Power & Light Co., Allentown, Pa.; Southern Region — R. Cecil Paslay, Louisiana Power & Light Co., New Orleans, La.; Southwestern Region — W. E. Folsom, Dallas Power & Light Co., Dallas, Tex.

• John & Drew Ebersson, architects-engineers, have been engaged by the United States Air Force as technical consultants for the newly-formed Air Pictorial Service. The firm will assist the Air Force in formulating operation plans for the pictorial project, particularly in reference to facilities, equipment and procedure. The program includes production of all documentary, training, public relations and combat films.



SOUND planning

for defense and civilian needs

RCA Sound Systems save time . . . speed production efficiency . . . improve employee morale . . . expedite shipping . . . provide instant communication with anyone and everyone in emergencies.

You can get practical and time-saving help from RCA in planning communications systems for every type of building. Whatever your

buildings need in engineered sound systems you can get the finest from RCA. Call on RCA Sound System engineers while your plans are still in the formative stage.

For complete information, contact your nearest RCA Sound Products distributor, or write to: Sound Products, Department T-3, RCA Camden, New Jersey.



SOUND PRODUCTS
RADIO CORPORATION of AMERICA
ENGINEERING PRODUCTS DEPARTMENT, CAMDEN, N. J.

In Canada: RCA VICTOR Company Limited, Montreal

COMPÉTITIONS

• For the first time a special architectural citation will be given as a feature of the 16th Ceramic National at the Syracuse Museum of Fine Arts, Syracuse, N. Y., from November 4 through December 2.

The citation will be awarded for "the best example of the use of ceramic sculpture as an integral part of an architectural plan."

Entries, which must be photographs of actual installations, are due September 13, 14 and 15 at one of several regional centers throughout the country. Prize works and other selected pieces from the initial showing will be circulated by the Syracuse Museum on a 14-month tour.

Entry blanks and full information may be obtained from: The 16th Ceramic National, Syracuse Museum of Fine Arts, Syracuse 3, N. Y.

• American sculptors have been invited by the Metropolitan Museum of Art to enter a nationwide competitive exhibition, "American Sculpture 1951," to open at the Metropolitan Museum on December 7. Entry blanks, accompanied by photographs of the proposed submission, must be submitted not later than September 15.

Entries will be judged for admission to the exhibition from the photographs. Sculpture done prior to 1942 will not be considered, and preference will be given to sculpture executed in a final medium, such as stone, wood, marble, bronze, or other permanent material.

(Continued on page 220)



**ZION
LUTHERAN CHURCH**
HOPKINS, MINNESOTA

39'-2" wide, 118'-4" long.

Arches 34'-10³/₈" high,
spaced 16'-6" O.C.

★

Architect: Lang & Raugland
Minneapolis, Minnesota

Contractor: Dean L. Wither, Inc.

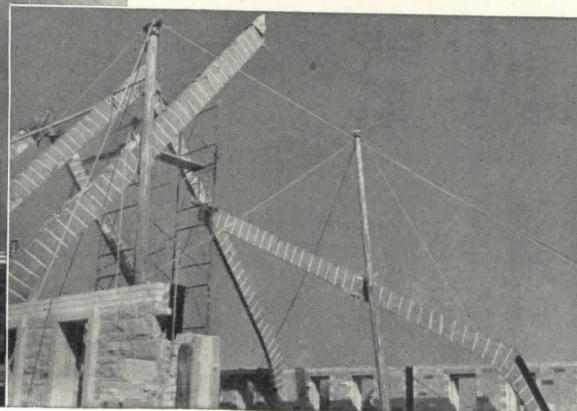

Dignified Beauty is Inexpensive

WHEN RILCO ARCHES ARE SPECIFIED

By COMBINING the natural beauty and versatility of wood with reliable engineering, Rilco produces arches that are architecturally and esthetically satisfying. These efficient arches are glue-laminated from clear grade, kiln dried West Coast Douglas Fir and bonded with the finest glues obtainable.

Because they arrive on the job site ready for rapid erection, construction is remarkably simple and economical. Hardware for engineered connections furnished with arches provides a perfect joint at the ridge, and solid anchorage at the base of the arch.

Wrapping protects the smooth surfaces of the arches during shipment to job site. This protec-

tive wrapping is left on the arches during construction and not removed until roof decking is applied.

Rilco arches are dependably designed and manufactured for each individual job. Our experienced engineering staff is at your service! See our 12-page catalog in Sweet's or write us for more information.

RILCO

WORKS WONDERS
WITH WOOD

Laminated PRODUCTS, INC.

1670 FIRST NATIONAL BANK BUILDING, ST. PAUL, MINNESOTA

Four of the sculptures accepted for the exhibition will be chosen to receive awards totaling \$8500 offered by the Museum trustees. The first prize is \$3500; second prize, \$2500; third prize, \$1500; fourth prize, \$1000.

This is the second of three large competitive exhibitions planned in accordance with the policy announced

by the Museum in January 1949 of increasing its activity in the contemporary American field. An exhibition of American painting has recently been held and an exhibition of water colors, drawings and prints is planned for 1952.

Entry blanks and complete information are available from the Museum, Fifth Ave. at 82nd St., New York City.

AWARDS

• Awards of Merit were presented to the architects of four outstanding buildings by the Chicago Chapter of the American Institute of Architects at its annual meeting.

The design of an entire residential town brought an Award of Merit to Loeb, Schlossman and Bennett, architects for Park Forest (ARCHITECTURAL RECORD, May 1951, pages 94-110).

In the industrial classification, Carr and Wright, architects, were honored for their research laboratory for the Portland Cement Association at Skokie, Ill.

The Merit Award in the hospital classification went to Loeb, Schlossman and Bennett for design of the Psychiatric and Psychosomatic Institute at Michael Reese Hospital.

In the field of urban multiple housing the jury chose for the award the Sherman Garden Apartments in Evanston, by Holsman, Holsman, Klekamp and Taylor, architects.

The juries chose from all the buildings in each classification erected in the Chicago area since 1946. The chapter plans annual awards in different classifications. Bronze plaques will be placed on buildings receiving the awards.

Also honored at the chapter's annual meeting was the architectural photography firm of Hedrich Blessing Studios, which received the Award in the Allied Arts.



U. S. Elastic Naugahyde is unbelievably tough—yet soft and luxurious. It stretches in all directions.

Now! a strong, stretchable "U. S." fabric backing gives greater durability, greater comfort, better tailoring to U. S. E-L-A-S-T-I-C Naugahyde

From its super-strong, stretchable fabric backing to its soft, supple finish, U. S. Elastic Naugahyde is made and quality-controlled by "U. S."

It's so tough it *can't* split or crack, rip at seams, or allow tacks or buttons to pull through. It's so luxuriously pliant, it tailors smoothly to inside curves and difficult contours.

And, like *all* Naugahyde, it's not affected by heat, sun, cold, rain, fog or salt spray. It will not scuff, discolor or fade. It's impervious to oils, greases, most acids, alkali and perspiration. Washes clean with a whisk.

PROVE TO YOURSELF:
U. S. Elastic Naugahyde
even under severe strain

1. will not split or crack
2. will not rip at seams
3. will not let tacks or buttons pull through

It's the S-T-R-E-T-C-H-A-B-L-E, strong, knitted fabric backing that makes U. S. E-L-A-S-T-I-C Naugahyde so much better, so much easier to tailor.

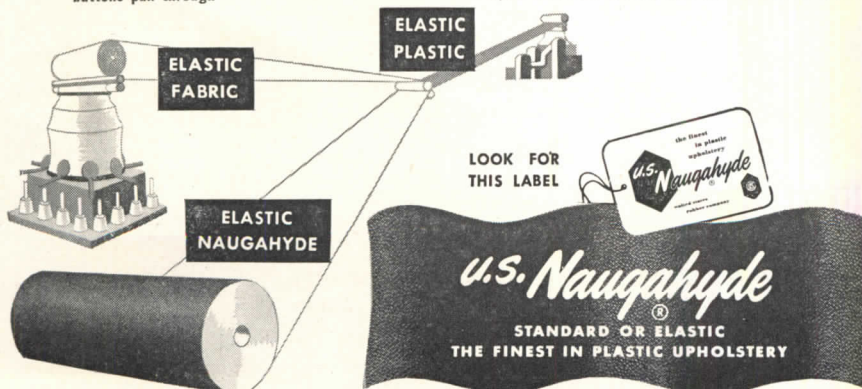

Write us for sample and complete information



UNITED STATES RUBBER COMPANY

Coated Fabrics Department, Mishawaka, Indiana

HOLD EXAMS SEPTEMBER 8 TO FILL ARCHITECT JOBS

Examinations for more than 40 architects' positions will be held September 8 by the New York State Department of Civil Service.

The positions to be filled include: senior architect, at \$5774; assistant architect, at \$4710; and junior architect, at \$3846. Most of the vacancies are in the Department of Public Works at Albany, but there are also vacancies in the Division of Housing in New York City.

Application blanks and information on the duties and requirements can be obtained from the Department of Civil Service, 39 Columbia St., Albany, N. Y., or Room 2301, 270 Broadway, New York City.

ANNOUNCING

Three New Additions To Corning Engineered Lightingware

As a result of a continuing effort to give you new and better lightingware, Corning research has developed three new additions to the Corning line. Like all Corning Engineered Lightingware, they provide maximum efficiency, effective light control, and design flexibility. The coupon below will bring you complete information on these important new products. Mail it today.

CORNING CRYSTA-LITE

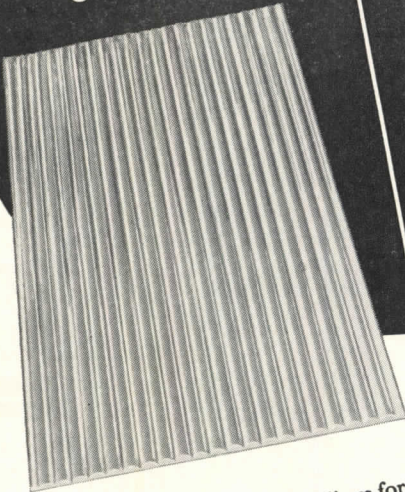

Here is an entirely new medium for prismatic control of fluorescent light. Utilizing linear prisms, it controls the distribution of light by bending high angle rays downward into zones where they are useful for illumination—gives you higher intensities with fewer fixtures and accurate brightness control. Efficiency is high. Made of water-white crystal, Corning Crysta-Lite is light in weight and non-color selective. Available in widths up to 24", lengths up to 100".

CORNING ALBA-LITE PATTERN 99

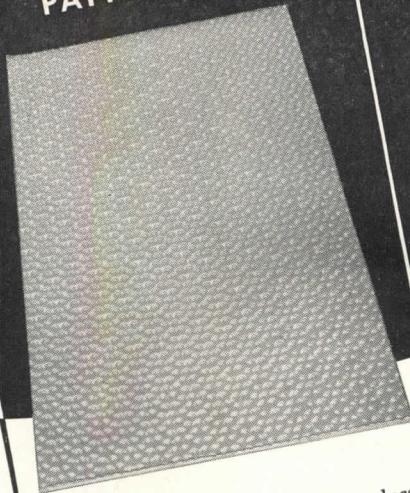

Corning Alba-Lite is an opal glass long recognized for its even light transmission, low panel brightness and high efficiency. The new pattern 99 is uniformly pebbled on one side to give greater "hiding power"—outline of light source is completely diffused. It makes for pleasing fixture appearance, is easy to clean. Available in (1/8" thick), widths up to 24" and lengths up to 100", Alba-Lite Pattern 99 is easily cut to special shapes or made into bends as required.

PYREX BRAND DIFFUSING GLASS PATTERN 12

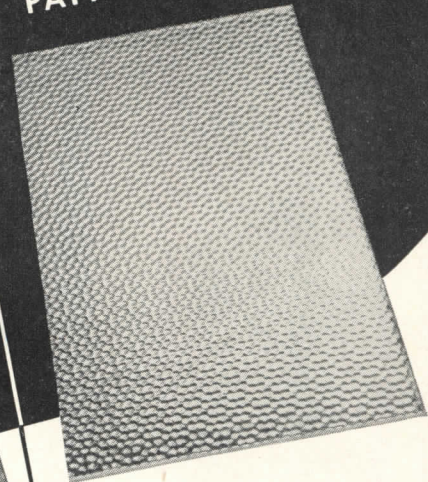

Offers the ideal solution for incandescent lighting applications where special qualities of heat resistance are required. Made of PYREX brand glass No. 7740, it is highly resistant to thermal shock—is especially suitable for use with high wattage lamps or in outdoor installations. The uniformly pebbled surface provides excellent diffusion and even illumination. Available in widths up to 24" and lengths up to 60" (1/8" thick), it can be cut to any required shape.



CORNING GLASS WORKS
CORNING, NEW YORK

1851 *Corning means research in Glass* 1951

CORNING GLASS WORKS, Dept. AR-8, Corning, N. Y.

Please send information on:

- Corning Crysta-Lite Alba-Lite Pattern 99
 PYREX brand Diffusing Glass Pattern 12

Name _____ Title _____

Firm _____

Address _____

City _____ Zone _____ State _____

THE RECORD REPORTS

CANADA

(Continued from page 18)

First units in Oshawa, Ont., civic center: police headquarters (right), city hall (below right). The former is under construction, the latter at bid stage. Architects: Hanks & Irwin; George Tonks, Oshawa manager

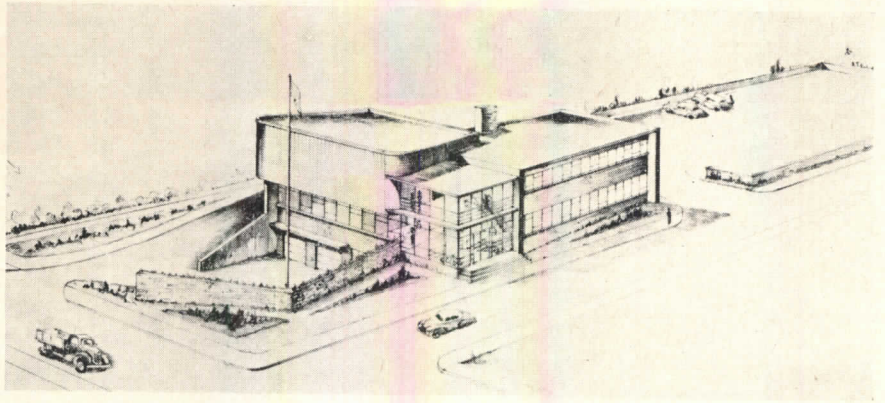

City Hall (below) will provide space for several city departments. Library and auditorium will be added to center later



SHOPPING FOR EXHIBIT CASES ?

BUYERS of exhibit cases everywhere are choosing Michaels "Time-Tight" Cases because they are tops in design, quality, structural features, appearance and usefulness.

Michaels cases offer Innerlocking Frames, an exclusive feature; fully mitered intersections; no screws exposed on face of frames, and other structural advantages.

These cases are designed for maximum visibility; to enhance the appearance of exhibits; to eliminate handling and theft as well as the ingress of dust, vermin and moisture. They are made in a wide variety of styles (table, aisle, wall, corner, suspended and recessed) and in any practical size to take care of virtually all exhibit requirements. If it is necessary to meet specific needs, Michaels will design and build special cases to your specifications. "Time-Tight" Cases are used extensively in museums, art galleries, libraries, universities, colleges, schools, clubs, banks, federal, state and municipal buildings, laboratories, institutions and various industrial and related types of display rooms.

Write for literature.

MUSEUM CASE DIVISION OF

The MICHAELS ART BRONZE CO., Inc., 234 Scott St., Covington, Ky.

Manufacturers since 1870 of many products in Bronze, Aluminum and other Metals



1951 House Production Shows 9 Per Cent Rise Over 1950's

Starts and completions of new dwelling units both ran about nine per cent higher in the first quarter of 1951 than in the corresponding period last year. Dominion Bureau of Statistics figures show an estimated 9801 started — an increase of 786 — and 19,251 units completed — an increase of 1648.

The rise in building activity was greatest in Ontario, where starts were up 40 per cent and completions 37 per cent. British Columbia also showed substantial increases of 21 per cent in starts and 31 per cent in completions. In the Prairie and Atlantic provinces, both starts and completions were lower in the first three months of 1951 than in the corresponding period of 1950. Completions in Quebec were only slightly higher than a year ago, while a decrease of 18 per cent was reported in starts for that province.

Dwelling units completed in March required an average 8.1 months to build. This was about a month longer than the

(Continued on page 224)

"maintenance time cut 50%"

with Westinghouse MERCURY lighting

A typical customer's problem: "To reduce the time spent on lighting maintenance."

Westinghouse recommendation: "To install Westinghouse Mercury Lighting."

Result: "Less than half as many fixtures to maintain and fewer lamps to replace, because mercury vapor produces more light per luminaire than any other lighting system."

This is only one case out of hundreds of "time-tested" installations. All show evidence that Westinghouse Mercury Lighting is a fast growing industry favorite. Investigate the complete line: 400, 1,000 and 3,000-watt units for either low or high-bay areas . . . open or closed fixtures for clean or dirty locations . . . high or low-voltage ballasts for any distribution system. Send for B-4727, "Westinghouse Lighting at Work" in every industrial area. Westinghouse Electric Corporation, P. O. Box 868, Pittsburgh 30, Pa.

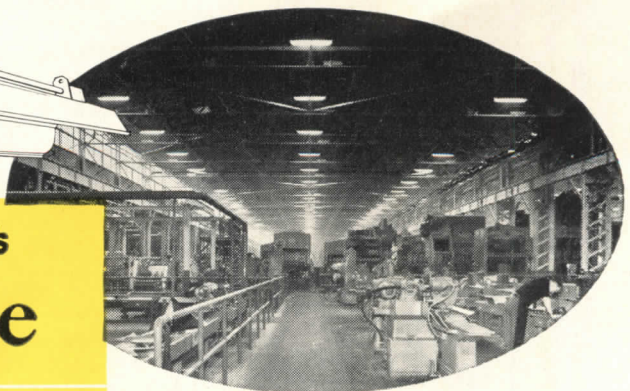
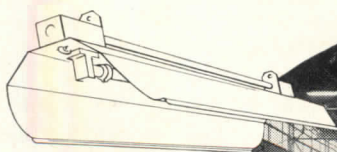

YOU CAN BE SURE.. IF IT'S
Westinghouse

LIGHTING DIVISION
Edgewater Park, Cleveland



Modern Office Building —not a Monument

The new \$1,700,000 headquarters and office building for the New Jersey State Highway Department, sponsored by Governor Alfred E. Driscoll, is marked by three innovations: (1) for economy, streamlined modern design in place of usual monumental architecture; (2) for efficiency and parking ease, location outside of city; (3) streamlined, space-saving heating with Webster Walvectors.

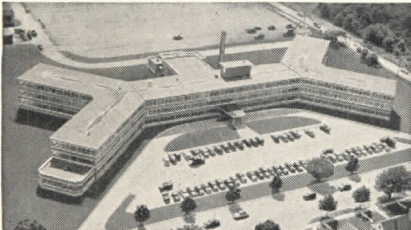

New Jersey State Highway Office Building, Trenton, N. J. Micklewright & Mountford, Trenton, Architects; Runyon and Carey, Newark, Consulting Engineers; Philip S. Slack & Co., Trenton, Heating Contractors.

A Webster Moderator System provides "Controlled-by-the-Weather" heating for this modern building with Webster Walvectors equipped with integral tube orifices to spread the heat along exposed walls. Webster Convectors are used in stairways and Webster-Nesbitt Unit Heaters provide supplemental heating in corridors.

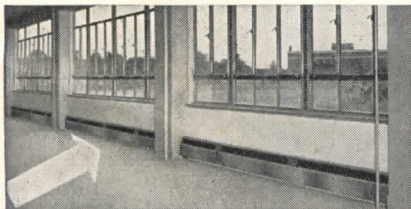

Webster Walvector spreads the heat . . . no cold spots.

Call the authorized Webster Factory Representative or write us for his name.

Address Dept. AR-8

WARREN WEBSTER & CO.
Camden 5, N.J. Representatives in Principal Cities
In Canada, Darling Brothers, Limited, Montreal

Webster
WALVECTOR
RADIATION
For Steam or Hot Water Heating

THE RECORD REPORTS

CANADA

(Continued from page 222)

time reported for March 1950. About 28 per cent of the units being constructed in the first quarter were for rent, the same proportion as a year ago.

May Defense Building Awards Total More Than \$15 Million

Contracts amounting to more than \$15 million were awarded by Defense Construction Ltd. during May.

Three of the biggest jobs yet undertaken accounted for nearly one half of this sum. Buildings at Moosejaw, Sask., were awarded to Pigott Construction of Saskatoon for \$2,780,000 and a supply depot and building at Narao, Alta., went to Marwell Construction for \$2,575,000. Buildings at Saskatoon were contracted for by W. C. Wells Construction of that city for \$1,330,000.

All three projects are located in prairie provinces, which according to President R. G. Johnson of Defense Construction Ltd. are getting the bulk of Canada's preparedness building. Credit for the boom goes to the R.C.A.F. program sparked by the North Atlantic Pact. With defense contracts being awarded at the rate of about \$5 million per week, Mr. Johnson says the prairies are getting 40 per cent, Ontario-Quebec 37 per cent, the Maritimes 12 per cent, and British Columbia 11 per cent.

By coincidence, at the very time the latest D.C.L. awards were being announced, the importance of western building was being emphasized at the Western Regional Meeting of the Canadian Construction Association at Jasper, Alta.

President Robert Drummond, pointing to the ability of the construction industry to expand its capacity under trying conditions, declared: "A good example exists here in the four western provinces, where the volume of construction rose from \$73.2 million in 1939 to \$772.5 million in 1950. Even after taking into consideration the rise in construction costs, this represents nearly a 500 per cent increase in physical volume. Not only have the overall totals risen but the size and construction difficulties of many of the projects have likewise substantially increased."

(Continued on page 226)

HILLYARD



trained
this
man

(and
hundreds
like him...)

to Help Architects
WITH FLOOR PROBLEMS

He is a specialist in planning and engineering practical floor treatments. Will show you how cost-saving Hillyard products fit in with ANY architectural plans you have on your drawing board—for schools, hospitals, hotels, factories, offices, churches, stores, airports, gymnasiums, stadiums. No obligation, of course.

Hillyard has located a trained Maintainer in your vicinity. He's ready to give you practical help, before and during construction.

**He's . . . on your staff
but not on your payroll.**

**SEND FOR HILLYARD A.I.A.
SPECIFICATION FOLDER**

Free to Architects on request.

HILLYARD CHEMICAL COMPANY
Dept. J-6

St. Joseph, Missouri
Warehouse Stocks in Principal Cities



PAINE REZO DOORS

T. M. REGISTERED

are Unconditionally Guaranteed
and here's what makes that guarantee good



**the interlocking,
ventilated all wood core that provides
unduplicated strength and stability**

On the surface, flush hollow core doors may look much alike, but it's what's beneath the face that determines the service and satisfaction that you can expect. Here's where the superiority of Paine Rezo doors is most pronounced; for nowhere else will you find equal dimensional stability, nor such lightness in weight combined with great structural strength.

For these reasons architects and contractors everywhere have installed more than four million Paine Rezo doors in

buildings of every type. No other hollow core door has been so widely endorsed, so thoroughly time-proved. Remember, when you specify Paine Rezo doors your satisfaction, now and in the future, is *unconditionally guaranteed*.

See SWEET'S catalog — or write for an illustrated data bulletin.

Manufactured by the

PAINE LUMBER CO., LTD. *Oshkosh
Wisconsin*

ESTABLISHED 1853

MOST ECONOMICAL

Heavy-Duty Freight Elevators

FOR 2, 3 OR 4 STORIES

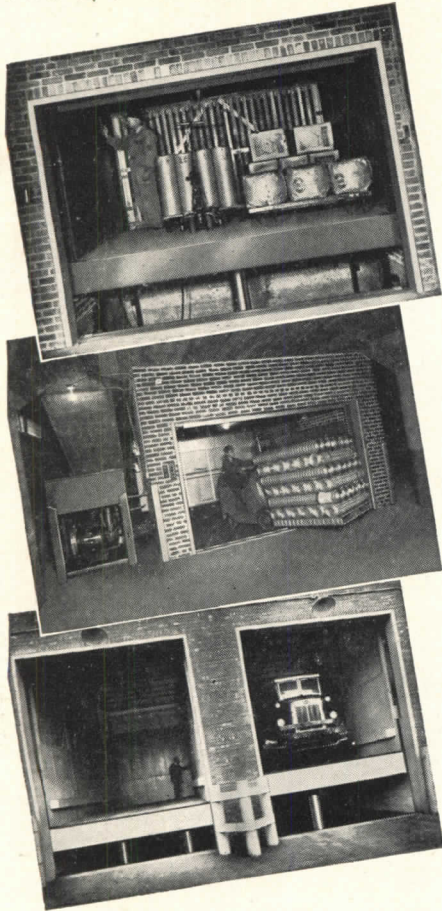

■ Oilraulic Elevators are designed for low-cost installation and economical, trouble-free operation. No penthouse or heavy load-bearing shaftway structure needed . . . powerful hydraulic jack supports car and load. Rugged car construction to withstand shocks and jolts of power truck loading. Automatic floor leveling within 1/4" guaranteed, regardless of load size or rate of speed. Car sizes, capacities and controls as required.

Over 55,000 Oilraulic Elevators and Lifts are now in use . . . backed by Rotary's coast-to-coast service organization.

For catalog, write Rotary Lift Co., 1005 Kentucky, Memphis 2, Tennessee.



Oilraulic Elevators

THE RECORD REPORTS

CANADA

(Continued from page 224)

June Construction Costs Reach An All-Time Peak

After a steady six-year climb, construction costs reached an all-time high in June. They show no sign of faltering, let alone declining.

The following table shows cost figures for the month of June in the years since 1946, from MacLean Building Reports records.

	Building Materials	Wage Rates	Construction Cost
1946	139.9	151.1	145.2
1947	165.1	173.8	169.4
1948	186.8	189.5	188.4
1949	193.1	205.2	198.6
1950	212.3	218.3	215.1
1951	247.2	238.6	243.2

Construction Employment Tops 1950 by 10 Per Cent

Construction employment is running about 10 per cent above the level established last year, Minister of Labor Milton F. Gregg has announced.

The rise appears in spite of the fact that weather conditions in many parts of the country prevented the early start of large-scale building operations.

"More rigid mortgage credit requirements and restrictions on uses of materials have not affected construction employment to any great extent," Mr. Gregg said, "although a reduction in new houses started may be anticipated. The heavy program of resources, development and defense projects scheduled is expected to take up any slack due to the fall-off in residential building."

Third N.H.A. Rental Project Announced for St. John, N. B.

The third low-rental housing project undertaken under Section 35 of the National Housing Act is to be located in St. John, N. B. Cost will be borne 75 per cent by the federal government, with the balance of 25 per cent met jointly by the province and the city.

Other Section 35 housing projects are in St. John's Nfld., and the Little Mountain area of Vancouver, B. C.

(Continued on page 230)

FLUORESCENT
FIXTURE PERFORMANCE
DEPENDS ON
BALLAST QUALITY

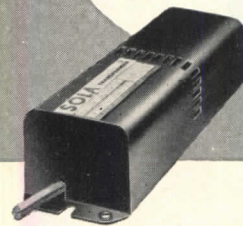

SOLA Sequenstart
CONSTANT VOLTAGE BALLASTS
operate with
minimum ballast maintenance

They are designed to last the life of the fixture.

SOLA Ballasts are designed to be installed in a fluorescent fixture and then forgotten. Capacitor heat failure (principle cause of ballast malfunctions) is virtually eliminated with the patented SOLA ventilated capacitor compartment. Special core and coil construction, high vacuum impregnation and baking and low operating temperatures all contribute to the long trouble-free life of SOLA Ballasts. So, if you are looking for a fluorescent light ballast that you can specify with peace of mind make it a SOLA. You'll find that when it's a SOLA Ballast . . . "You can install and forget it."

Compare SOLA Sequenstart* with any other ballast.

Here are the significant advantages.

- Positive starting regardless of line condition with patented SOLA Constant Voltage design
- Cooler operation because of ventilated capacitor compartment
- Less wattage loss, lighter in weight and more compact

We welcome any questions you have about ballast design and application. Write for technical bulletin T-PFL-144.

Compare ballast performance — then specify the outstanding performer.

SOLA
Sequenstart
TRADE MARK

CONSTANT VOLTAGE BALLASTS

SOLA ELECTRIC CO.
4633 W. 16th St., Chicago 50, Ill.



Faster Government Approvals?

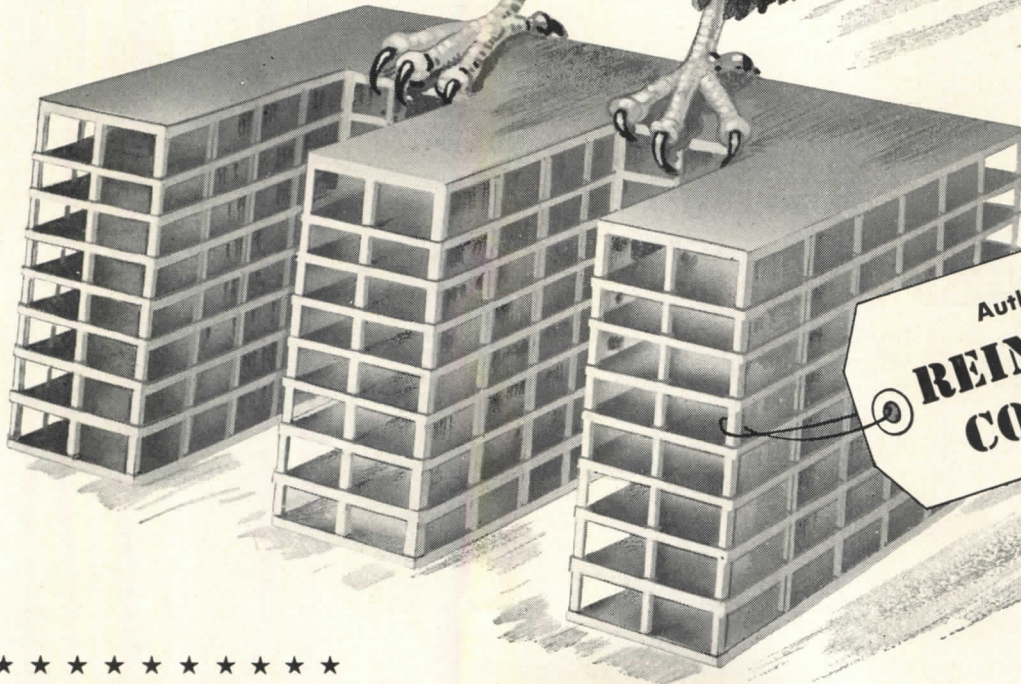

Authorized for
**REINFORCED
CONCRETE**

★ ★ ★ ★ ★ ★ ★ ★ ★ ★ ★ ★ ★ ★ ★ ★

★ **REINFORCED CONCRETE SAVES STEEL** ★

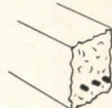
★  **IN BEAMS** ★

★ **IN COLUMNS**  ★

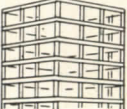
★  **IN TOTAL TONNAGE SAVES 60 to 65%** ★

★ ★ ★ ★ ★ ★ ★ ★ ★ ★ ★ ★ ★ ★ ★ ★

...because **REINFORCED CONCRETE** uses less steel

Your application for new construction under current NPA regulations will have a better chance of getting approval if you design for reinforced concrete. That's because reinforced concrete construction requires less steel—60 to 65% less on the average structure! Furthermore, reinforced concrete is a wise choice in these days of steel shortages, since reinforcing bars—classed as a "B" product—will probably be easier to obtain.

Reinforced concrete is rugged, durable, inherently firesafe, and highly resistant to wind, shock, and quakes. On your next job, it will pay you to design for reinforced concrete!

CONCRETE REINFORCING STEEL INSTITUTE
38 S. Dearborn St., Chicago 3, Ill.

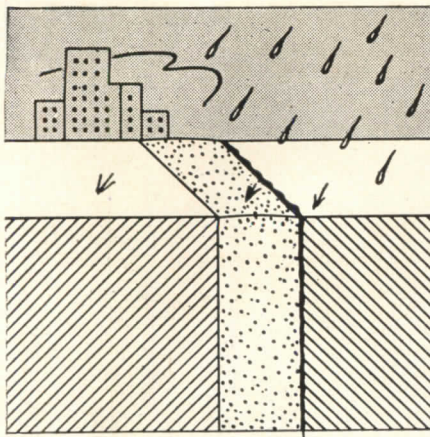

**To Prevent
Leaks in
Masonry Joints—
specify**



WEATHERCAP

set in
MINWAX CAULKING COMPOUND

• Good for the life of the building. For free sample and specification data, mail coupon.

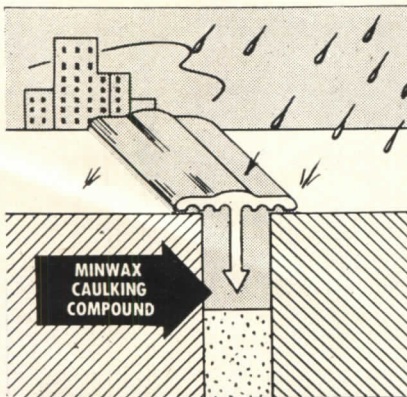

SEND FOR YOUR SAMPLE

Minwax Company, Inc.
11 W. 42nd St., New York 18, N. Y.

Please send me free sample of Weathercap with descriptive folder and specification data.

Name

Address

City

State

AR-8-51

THE RECORD REPORTS

CANADA

(Continued from page 226)

**Frost Rental Housing Plan
Meets With Cool Reception**

The Ontario government may have to offer more than it does at present if it expects to interest municipalities in its rental housing plan. Larger educational grants are one form that assistance might take.

In addressing the recent convention of the Canadian Federation of Mayors and Municipalities, Premier Frost set a "pilot" objective of 5000 dwelling units, to be erected under Section 35 of the National Housing Act. This legislation provides for cooperation by the three levels of government. The municipalities initiate and manage their own housing projects, and the cost is shared on a federal (75 per cent)-provincial (25 per cent) basis. Premier Frost reduces the province's share to 17½ per cent by making the municipality responsible for seven and a half per cent of the cost.

Part of Section 35, providing for the servicing of raw land for residential development, has been in effect in Ontario for some time. It has been little used. Indications are that the rental scheme may be given an equally cool reception for the same reason. Municipalities, generally speaking, simply do not want more housing.

Explanation for this attitude is found in the fact that residential property does not produce the tax revenues required to meet the cost of additional investment in schools and services. A new school necessitates the expenditure of \$1000 per pupil to build and \$200 per pupil a year to maintain. And while Section 35 covers the servicing of land by extending water and sewer mains, this does not include the cost of a major expansion in municipal plant, necessary in many places because present facilities are overburdened.

The situation is serious. Ontario municipalities have no cushion for additional debt charges, and investors are demanding higher yields on municipal bonds. There are political implications as well: property owners resist rising tax rates and, in fact, every increase makes prospects for home ownership less eligible for mortgage financing, thereby boosting the demand for rental housing.

**USE THE
WORLD'S BEST
at
NO EXTRA COST**

1. CASTELL DRAWING 9000
2. CASTELL LOCKTITE REFILL HOLDERS 9400—Black or Colored
3. CASTELL IMPORTED REFILL LEADS 9030

These encompass every mood of genius for drawing, drafting, tracing, sketching, blueprinting, etc.



• Premium products at regular prices. See your dealer today.

AW FABER-CASTELL
PENCIL COMPANY INC NEWARK N.J.

KAYLO[®] INSULATING ROOF TILE

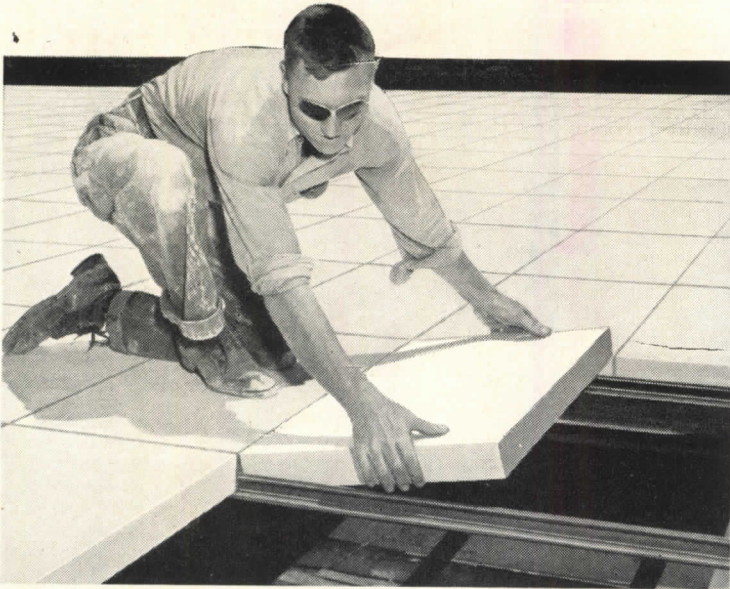

Kaylo Insulating Roof Tile provide simple fast construction of flat or pitched roofs. The lightweight tile are laid quickly and easily on steel sub-purlins or standard structural shapes, or may be nailed to wood joists. Standard roofing materials are used over a Kaylo roof deck.



The smooth under-surface of Kaylo Insulating Roof Tile has a light reflection factor of approximately 80 per cent. Note the lightweight supporting structure, with its economy of steel, made possible by the Kaylo roof deck.

A Better Roof Deck

Fast Erection...Lightweight Fire-safe Roof Construction

Kaylo Roof Tile is a structural load-bearing unit which insulates. It provides a better and longer-lasting roof deck for almost every kind of building.

Kaylo Insulating Roof Tile is made of calcium silicate (not glass), an inorganic chemical composition with a remarkable combination of advantages. It won't burn or rot, is lightweight, yet strong.

The non-combustible Kaylo Tile withstand building fire temperatures up to three hours and are still strong enough to be walked on. Their *effective* insulating value eliminates the need for additional insulation in usual installations. Being inorganic, the tile have high resistance to moisture, vapor and other destructive elements.

The structural strength of Kaylo Insulating Roof Tile is more than adequate for typical roof loads. And, the lightweight tile (only 5 pounds per square foot) permits the use of lighter, more economical supporting members and foundations.

For complete details on Kaylo Insulating Roof Tile, write Dept. N-128, Owens-Illinois Glass Company, Kaylo Division, Toledo 1, Ohio.



KAYLO[®] ... first in calcium silicate

...pioneered by OWENS  ILLINOIS Glass Company

MAIN OFFICE: TOLEDO 1, OHIO—KAYLO SALES OFFICES: ATLANTA • BOSTON • BUFFALO • CHICAGO • CINCINNATI • CLEVELAND
DETROIT • HOUSTON • MINNEAPOLIS • NEW YORK • OKLAHOMA CITY • PHILADELPHIA • PITTSBURGH • ST. LOUIS • WASHINGTON

TRADE-WIND CLIPPER VENTILATORS

ADVANCED MODELS
FOR EVERY KITCHEN
AND ALL SMALL ROOMS

TRADE-WIND
SUPER
CLIPPER
model 3501

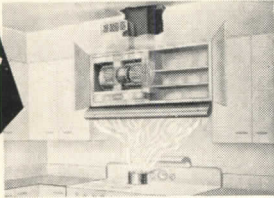

for Kitchen Cabinet Installation

Two inlets at stove and ceiling level each with washable filters. Two centrifugal blowers, delivery 550 CFM CERTIFIED. 2-speed switch. Hood optional.

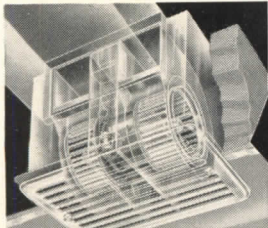

TRADE-WIND
CLIPPER
model 2501

for Large Kitchens,
Laundries, Game Rooms

Two centrifugal blowers with motor isolated from greasy air stream. Dripless grille. 2-speed switch. Interchangeable discharge. 425 CFM CERTIFIED.

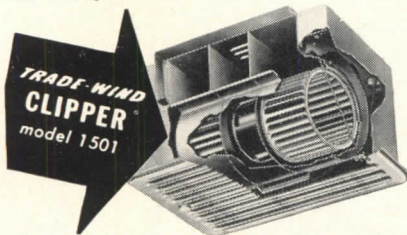

for Average Kitchens, Laundries, Dens

This is the sensational new double centrifugal blower model. Interchangeable discharge. 300 CFM CERTIFIED. Motor entirely outside air stream. Dripless grille. 2-speed switch available.

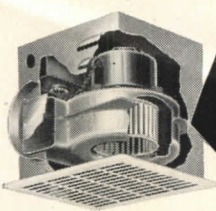

TRADE-WIND
CLIPPER
model 1201

with Automatic Switch
for Bathrooms

Single centrifugal blower. 100 CFM CERTIFIED. Built-in backdraft damper. Available with automatic time switch which turns off unit after 30 minutes or less.

TRADE-WIND MOTORFANS, INC.

5707 So. Main St., Los Angeles 37, Calif.

Please send complete information on all Trade-Wind Clipper Models.

Name _____

Address _____

MAIL COUPON TODAY

REQUIRED READING

(Continued from page 32)

pared originally from notes used in a course given to students in business administration and public administration at Virginia Polytechnic Institute. The investment aspects of the various building types are examined in detail. In addition, Chapter One, "The Owner," and Chapter Two, "What May Be Expected from the Architect," are written to give a clear understanding of what the architect does on a building project and also his professional and business relationships with the owner. Although directed primarily to persons in the field of investment, appraising, banking and real estate, it should prove invaluable to the young architect as a means of seeing how his profession fits into the broader picture of building activity.

NEW EDITIONS

ILLUSTRATED STANDARDS

Architectural Graphic Standards. By Charles G. Ramsey and Harold R. Sleeper. John Wiley & Sons, Inc. (440 Fourth Ave., New York 16, N. Y.) 4th ed., 1951. 9 by 11 $\frac{3}{8}$ in. xv + 614 pp., illus. \$10.00.

The latest edition of the familiar "Ramsey and Sleeper" still gives the facts and data for nearly every phase of building, but this time it appears as a considerably fattened-up volume. The content, arranged in the usual sequence of building, includes a presentation of materials, fixtures, fittings, furnishings, equipment, apparatus, etc. There are 566 plates, each thoroughly cross-index, and a 50-page index which contains 12,000 entries. — Of inestimable value for the architect, engineer, builder, decorator and draftsman.

BOOKS RECEIVED

The Homes of America . . . as they have expressed the lives of our people for three centuries. By Ernest Pickering. Thomas Y. Crowell Co., New York — A well illustrated biography of the American home: through Colonial and Post-Colonial periods, the eras of Greek Revival, Romanticism, Gothic Revival, etc., to the present.

(Continued on page 234)

For Quality SLIDING DOOR HARDWARE

Specify

SPECIFICATIONS

COMPANY	DESCRIPTION
ASCO CO.	Masonry
HEWLET	Lumber
FORD	Electrical Work
NEWCOMB	Casements
	Drapery Hardware
GRANT	Sliding Door Hardware
	Slides

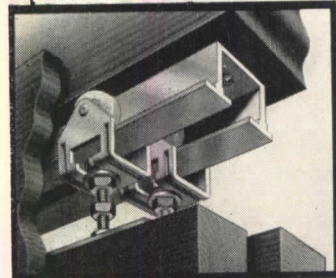
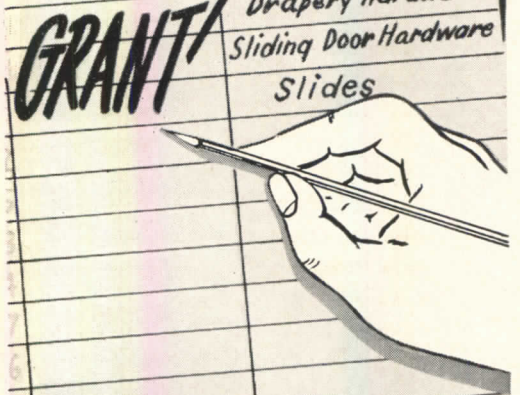

The GRANT No. 17 Double track sliding door hanger allows for simplified installation of multiple unit doors, as well as ease of operation. GRANT No. 17 hangers are the only hangers featuring Nylon outer race ball bearing wheels for silent operation, three adjustments, automatic alignment of doors, center hung feature, doors can never jump the track. For single doors, the GRANT No. 16 sliding door hanger is recommended, which contains all the advantages of the No. 17 hanger on a single track. (Load capacity: 50 lbs. per door)

Write Dept. F2 for complete illustrated literature.

GRANT PULLEY & HARDWARE CO.

31-85 WHITESTONE PKY., FLUSHING, N. Y.

FLUSHING 9-1900

Representatives in all major cities.

Versatile MARLITE fits into every REMODELING PICTURE

For both residential and non-residential remodeling, there's no end to the many practical uses of modern, versatile Marlite plastic-finished wall and ceiling panels. What's more, your remodeling programs will be completed on time—as planned—because Marlite is quickly and easily installed.

Exclusive baked plastic finish preserves Marlite's sparkling beauty. Dirt, grease, stains, moisture can't mar the lustrous finish. Periodic painting and redecorating is never necessary. Maintenance costs are *extremely low*.

Modernize with Marlite—used and approved by architects and builders for more than 21 years. See for yourself how Marlite fits into your remodeling picture. Write today for full color literature showing typical Marlite installations. Marsh Wall Products, Inc., Dept. 805 Dover, Ohio. Subsidiary of Masonite Corporation.

- a. Plain-Color
- b. Horizontal-line
- c. Tile Pattern
- d. Wood Pattern
- e. Marble Pattern

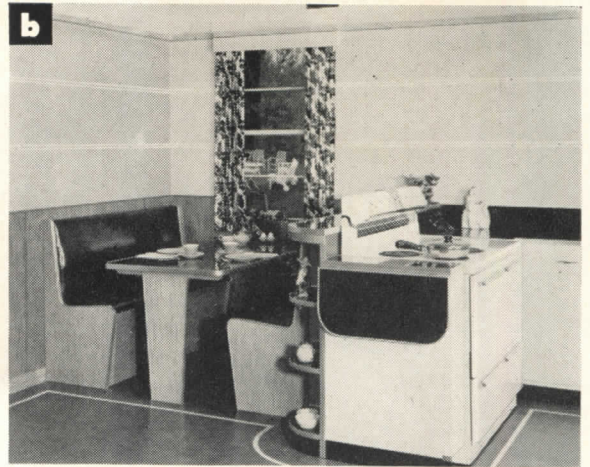

**No home
is modern**

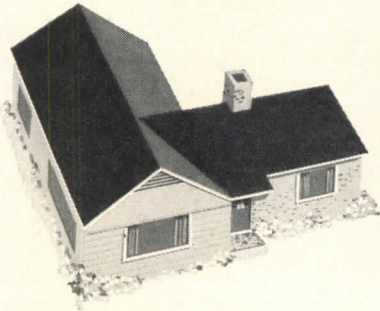

**... unless it's cool
in hot weather!**

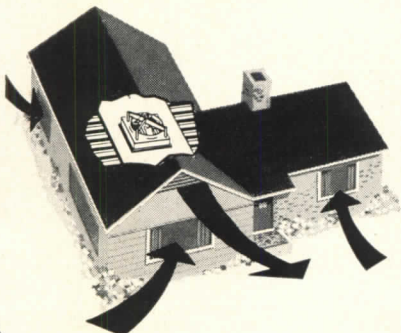

**Hunter Package Fan gives cool
comfort on hottest nights**

■ Throughout the nation, home owners are finding that no modern convenience gives them as much comfort as a Hunter Attic Fan. It drives out stale, humid air and fills every room in the home with cool, invigorating breezes.

Installation of Hunter's new, compact Package Attic Fan is simple and inexpensive. Fan, motor, suction box and shutter furnished complete—requiring only a ceiling opening and less than 18" clearance in attic. Four models, ranging from 4750 CFM to 9700 CFM, to fit any home size and climate. Quiet, powerful, dependable. Manufactured by Hunter, exclusive fan makers for over 64 years.

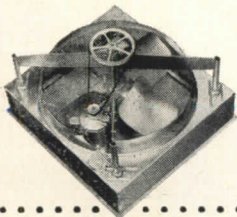

Write for complete installation manual, "How to Cool for Comfort." Hunter Fan and Ventilating Co., 396 S. Front St., Memphis, Tenn.

**Hunter
PACKAGE ATTIC FANS**

REQUIRED READING

(Continued from page 232)

Nineteenth Century Architecture in Britain. By Reginald Turnor. B. T. Batsford, Ltd. (Domestic agent: The British Book Centre, New York) — British architecture from the Regency to the beginning of the 20th century, with attention to the application of Victorian moral standards to esthetic and practical questions.

Prefabrication of Houses, The. By Burnham Kelly. John Wiley & Sons, Inc., New York — A study of prefabrication in the United States by the Albert Farwell Bemis Foundation.

Route Surveys. By Harry Rubey. The Macmillan Co., New York) — "A pocket book for the survey, design, and construction of railways, highways, tramways, beltways, canals, flumes, levees, pipe lines, transmission lines and other route constructions."

Preliminary Report for the Schuylkill Expressway. City Planning Commission, Philadelphia — A system of related arteries: Schuylkill Expressway, Vine Street Extension, Roosevelt Boulevard Extension, in a very readable presentation.

Conference on Ground Facilities For Air Transportation. Sept. 12-14, 1950, Massachusetts Institute of Technology — Proceedings of conference sponsored by M.I.T., the Port of New York Authority, CAA, and the Massachusetts Aeronautics Commission.

National Fire Codes. Vol. III, Building Construction and Equipment; Vol. IV, Extinguishing and Alarm Equipment. National Fire Protection Association, Boston — Thorough compilation of N.F.P.A. advisory standards, revised and brought up to date.

How to Build Your Own Furniture. By Paul Bry. The Macmillan Co., New York — Detailed working drawings, perspectives, dimensions, general instruction, etc., for constructing over 20 units for the home.

Roman Sources of Christian Art. By Emerson H. Swift. Columbia University Press, New York — The contention that the art of the Western Roman Empire, as an outgrowth of pagan Rome, was more influential in the formation of style in Medieval Christian art, architecture and decoration, than were aspects of Oriental art.

*Yours FREE
for the asking*



A GUIDE TO QUICK HEATING

*How to Select the Right
HEETAIRE for Every Purpose*

Here's the first and only complete GUIDE to the selection of electrical wall-insert and wall-attachable space heaters!

It gives all the information about QUICK HEATING you've always wanted—types, sizes, heating principles, thermostatic heat controls, recommended wattages—plus an exclusive chart based on the four factors that determine the selection of the correct HEETAIRE.

It's yours for the asking—just drop us a card.

*Look at this
Table of Contents*

The Principles of HEETAIRE Types and Sizes

- ★ THERMOSTATIC CONTROLLED Operation
- ★ Series 230 HEETAIRE . . . Fan-Forced Radiant Heat 1250 to 3000 Watts
- ★ Series 250 HEETAIRE . . . Fan-Forced Black Heat 1500 to 3000 Watts
- ★ Series 210 HEETAIRE . . . Fan-Forced Black Heat 3000 to 5000 Watts
- ★ Series 200 HEETAIRE . . . Radiant Heat 1000 to 2000 Watts
- ★ Series 240 HEETAIRE . . . Radiant Heat 1000 to 1500 Watts

**MARKEL
ELECTRIC PRODUCTS, INC.
LA SALLE
PRODUCTS, INC.**
157 SENECA ST. • BUFFALO 3, N. Y.



Better for structural concrete

Duraplastic is so often *specified* for structural work because it gives a more plastic, more cohesive mix that is more workable and easy to place. Duraplastic air-entraining portland cement needs less mixing water for any given slump.

Makes more durable concrete

Water-gain and segregation are minimized by the air-entraining feature of Duraplastic. The finished concrete is thus fortified against the effects of freezing-thawing weather and the surface appearance is improved.

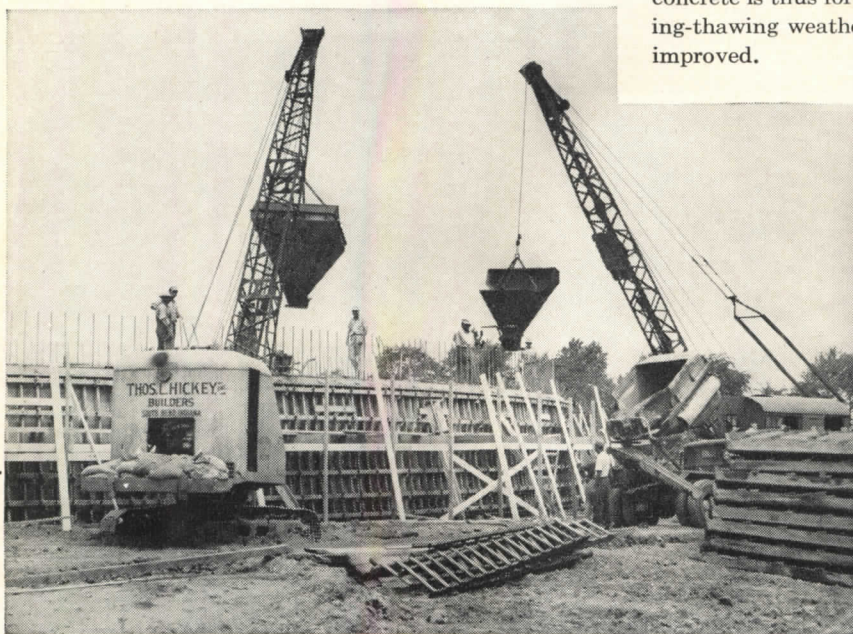

YET DURAPLASTIC* COSTS NO MORE

It sells at the same price as regular cement and requires no unusual changes in procedure. Complies with ASTM and Federal Specifications. For descriptive booklet, write Universal Atlas Cement Company (United States Steel Corporation Subsidiary), 100 Park Avenue, New York 17, N. Y.

*"Duraplastic" is the registered trade mark of the air-entraining portland cement manufactured by Universal Atlas Cement Company.

ATLAS®

DURAPLASTIC

AIR-ENTRAINING PORTLAND CEMENT



Makes Better Concrete at No Extra Cost

OFFICES:

Albany, Birmingham,
Boston, Chicago, Dayton, Kansas City,
Minneapolis, New York, Philadelphia,
Pittsburgh, St. Louis, Waco.

NBC SUMMER SYMPHONY CONCERTS—Sponsored by U. S. Steel Subsidiaries—Sunday Evenings—June to September

AR-D-125



Mt. Olivet Lutheran Church, Minneapolis, Minnesota. Architect: H. C. Hauser

At your service, Architects:

AMERICAN SEATING COMPANY CONSULTATION SERVICE

EXTENSIVE files of case histories, exhaustive data on every type of installation, and more than 60 years of successful experience are available to you—without obligation—through our Church Furniture Designers.

They know all the intricacies of this highly specialized field. They know current trends in church-interior styling. They are thoroughly versed in all the technical aspects of planning and installation.

Feel free to use this Consultation Service whenever it can conserve your time and energy. It may save you hours or days of research. Many of America's most distinguished churches bear testimony to the beauty, dignity, and liturgical correctness of American Seating Company furnishings. Write to us!



WORLD'S LEADER IN PUBLIC SEATING

American Seating Company

Grand Rapids 2, Michigan

Branch Offices and Distributors in Principal Cities
Manufacturers of Church, School, Auditorium, Theatre, Transportation,
Stadium Seating, and Folding Chairs

POSITIONS OPEN

SEVERAL INSTRUCTORS — in Architectural Design, Structural Design, Building Materials and Equipment and related courses will be needed at schools of architecture for the fall term. Those interested in a career in the teaching profession should apply to Professor Paul Weigel, Chairman of the Committee on Employment for the Association of Collegiate Schools of Architecture, Kansas State College, Manhattan, Kansas.

ARCHITECT-DESIGNER — Experienced man for key position in well established Chicago firm serving a clientele of nationally known private industries. Furnish full education and experience record, salary required and availability. Box 532, *Architectural Record*, 119 W. 40th St., New York 18.

MIDWEST ENGINEERING FIRM — needs Consulting Architect. Prefer over 40 years of age, graduate, qualified for registration several states, varied experience. Either salary or fee basis. Permanent position or association. Furnish complete qualifications. Address Box 533, *Architectural Record*, 119 W. 40th St., New York 18.

SIZES TO MEET EVERY HEATING NEED



Cast Iron National Heat Extractor boilers in sizes ranging in Net I-B-R Ratings from 170 to 10,300 sq. ft. of steam and from 270 to 16,480 sq. ft. of water.



National Steel Boilers in sizes ranging in SBI Net Ratings from 275 to 35,000 sq. ft. of steam and from 440 to 56,000 sq. ft. of water.



National Gas Boilers ranging in net ratings from 105 to 9,690 sq. ft. of steam and from 195 to 15,505 sq. ft. of water. A.G.A. approved for use with all gases.

NATIONAL Complete and Modern Hot Water and Steam HEATING SYSTEMS

The distinguished family of National Heating Products includes a complete line of modernly designed cast iron and steel boilers convertible to any fuel and method of firing to meet all requirements—from smallest home to largest commercial building.

Big boiler performance within compact over-all dimensions; uniform water circulation; tankless water heater for domestic hot water supply . . . are among many National features that assure efficient, long-life, economical performance.

Write for detailed information on the complete line of National Heating Products.



National Art & Aero Convectors



National Art Radiators

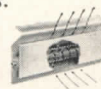

National Art Baseboard



National Unit Heaters



THE NATIONAL RADIATOR COMPANY
JOHNSTOWN, PENNSYLVANIA