

# CECO is first in Service

As a building method, concrete joist construction leads the field in the Veteran Hospital Building program. Here, as in other buildings, strength and durability are of prime importance. Concrete joist construction meets the need in supplying rigid, strong floor constructions which are fire resistive and sound proof. Construction costs are low since steelform jobs require less concrete, less lumber, less labor. Steelforms are used over and over again at a nominal rental charge.

As the originator of the removable steelform method of concrete joist construction, Ceco is first in the field. So, for concrete joist construction, call on Ceco, the leader over all.

## CECO STEEL PRODUCTS CORPORATION

General Offices: 5601 West 26th Street, Chicago 50, Illinois

Offices, warehouses and fabricating plants in principal cities

A Partial List of Veteran Hospitals Where  
Ceco Supplied Concrete Joist Construction.

Little Rock, Arkansas  
Livermore, California  
Alexandria, Louisiana  
Saginaw, Michigan  
Miles City, Montana  
Grand Island, Nebraska  
Omaha, Nebraska  
Bonham, Texas  
Roanoke, Virginia  
Beckley, West Virginia  
Clarksburg, West Virginia

**CECO  
STEEL**®

*makes the big difference*

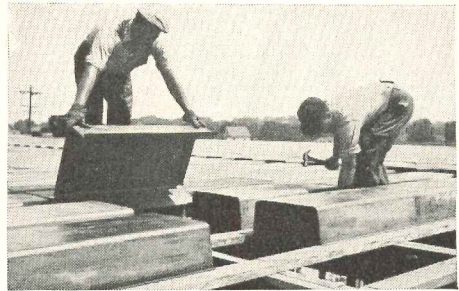

Erecting steelforms on open wood centering preparatory to placing reinforcing steel. Use of steelforms mean a saving in lumber.

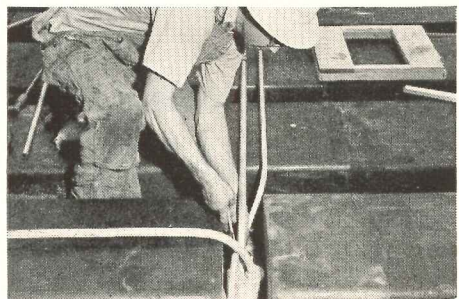

Placing electrical conduits in a bridging joist. All conduits are thus placed, eliminating necessity of extra space for service ducts.

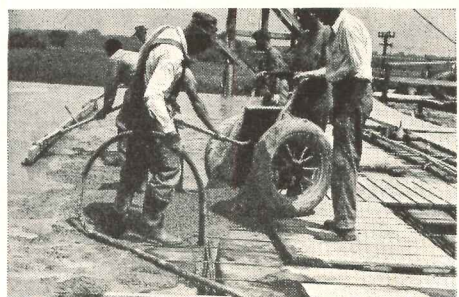

Concrete is being poured here over the steelforms and around the reinforcing steel. The final step is removal of steelforms and lumber after concrete sets.

### Partial List of Ceco Products

METAL RESIDENCE CASEMENTS • INDUSTRIAL WINDOWS AND DOORS • METAL FRAME SCREENS  
ALUMINUM FRAME STORM WINDOWS • ALUMINUM COMBINATION STORM WINDOW AND SCREEN UNITS  
• METAL LATH AND ACCESSORIES • STEELFORMS  
• REINFORCING BARS • STEEL JOISTS AND ROOF DECK • HIGHWAY PRODUCTS

MEDICAL AND SURGICAL BUILDING—NORRISTOWN, PA. STATE HOSPITAL  
 Department of Welfare, Commonwealth of Pennsylvania  
 HOWELL LEWIS SHAY, AIA—Architects  
 STEWART A. JELLETT CO.—Engineers  
 HERMAN GOLDNER CO.—Heating and Ventilating Contractor  
 LANDAU PLUMBING & HEATING CO.—Plumbing Contractor

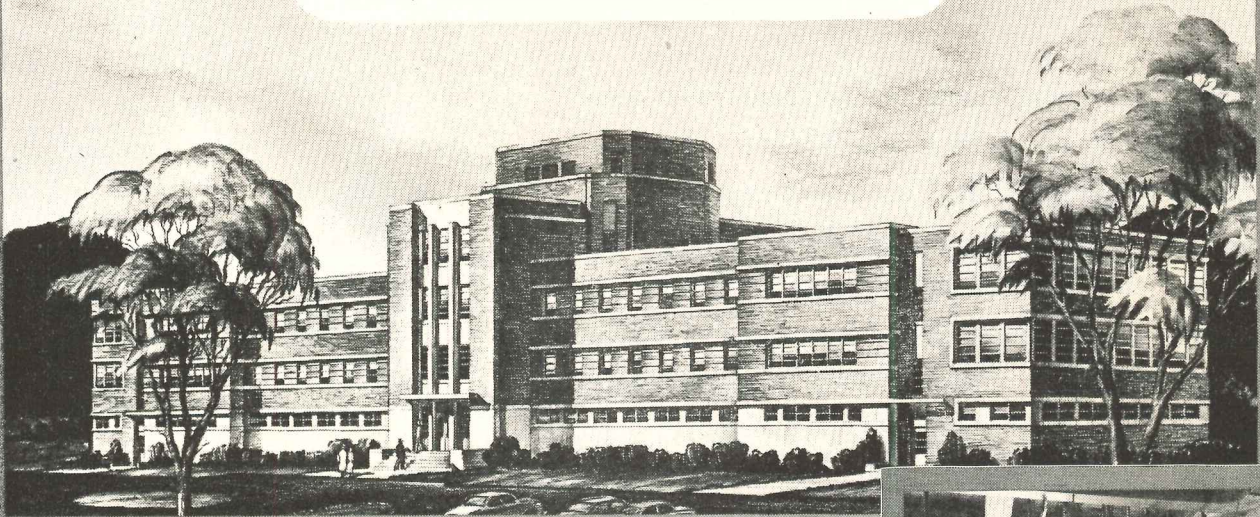

To assure pipe health . . .  
**RADIANT HEATING** and  
**5 OTHER SERVICES** here

are **BYERS WROUGHT IRON**

In this new hospital, the designers not only gave careful thought to the welfare of the patients—but also to the welfare of the piping on which so many services and facilities depend. Byers Wrought Iron pipe was installed in the modern radiant heating system, which utilizes both floor and ceiling coils to warm all four floors, and in steam return lines, rain water conductors, rain water drainage above basement, refrigeration water, and refrigeration drainage lines. The small illustration shows radiant heating coils with balancing valves and also some plumbing risers in a bathroom in the nurses' quarters.

With so many new hospitals now being constructed throughout the country, it is vital to assure that these aids to community health do not bring financial headaches through excessive upkeep charges. In corrosive piping services, where

premature failures would entail a continuing burden of maintenance, engineering experience recommends wrought iron for protection. The tiny fibers of glass-like silicate slag that are threaded through the high-purity iron body of the material halt and disperse corrosive attack, and so discourage pitting and penetration. The fibers also anchor the initial protective film, which shields the underlying metal.

A knowledge of the nature, characteristics and methods of manufacture of wrought iron is an excellent guide to its proper applica-

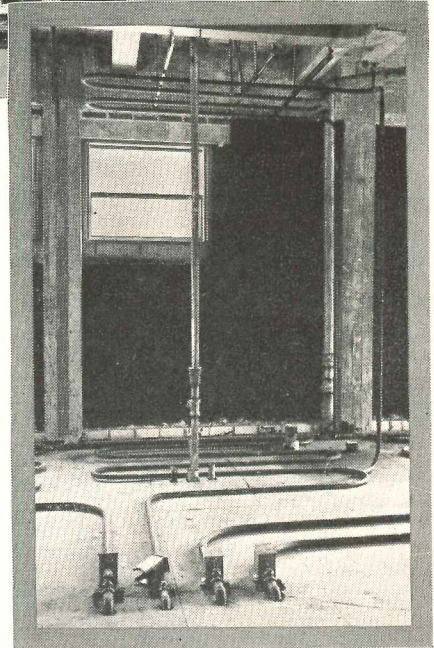

tion. Our booklet, **THE A B C's OF WROUGHT IRON**, gives the complete story. Ask for a copy.

A. M. Byers Company, Pittsburgh, Pa. Established 1864. Boston, New York, Philadelphia, Washington, Atlanta, Chicago, St. Louis, Houston, Salt Lake City, San Francisco. Export Division: New York, N. Y.

**CORROSION COSTS YOU MORE THAN WROUGHT IRON**

**BYERS**  
**GENUINE WROUGHT IRON**  
**TUBULAR AND HOT ROLLED PRODUCTS**  
 ELECTRIC FURNACE QUALITY ALLOY AND STAINLESS STEEL PRODUCTS

# ARCHITECTURAL RECORD



Copyright 1950 by F. W. DODGE CORPORATION, with all rights reserved • Publishing Director, Magazine Division, H. Judd Payne • **EDITORS:** Editor-in-Chief: Harold D. Hauf, A.I.A., A.S.C.E.; Managing Editor, Emerson Goble; Associate Editors, Robert E. Fischer, Frank G. Lopez, A.I.A., Florence A. van Wyck; Wash-

ington News, Ernest Mickel; Contributing Editor, Frederic A. Pawley; Western Editor, Elisabeth Kendall Thompson; Special Editorial Representative, Western Section, William C. Rodd; Associate in South America, Edmund J. Whiting, A.I.A.; Editorial Assistant, Jeanne Davern • **ART DEPARTMENT:** Myron S. Hall, 3rd, Director; Frances Torbert, Assistant; Sigman-Ward, Drafting • **CONSULTANTS:** Chairman, Editorial Board, Kenneth Kingsley Stowell, A.I.A.; Industry Relations Consultant, Thomas S. Holden; Statistical Consultant, Clyde Shute; Building Economics Consultant, Norbert Brown; Field Research Consultant, Clifford Dannels, Jr.

Architectural Record (combined with American Architect and Architectural) is published monthly by F. W. Dodge Corporation, 10 Ferry St., Concord, N. H., with Editorial and Executive Offices at 119 West 40th Street, New York, N. Y. Western Editorial Office, 2813 Channing Way, Berkeley, Calif. Thomas S. Holden, Pres.; Howard J. Barringer, Vice-Pres. and Treas.; Irving W. Hadsell, Vice-Pres.; Chauncy L. Williams, Vice-Pres.; Sanford D. Stockton, Jr., Secy.; Walter F. De Saix, Asst. Treas.; Edwin H. Freed, Asst. Treas. Member Audit Bureau of Circulation and Associated Business Papers, Inc. Architectural Record is indexed in Reader's Guide, Art Index, Industrial Arts Index and Engineering Index. Subscription rates: United States and Possessions, Canada, Cuba, Mexico, Central and South America, and Spain, \$4.50 the year, \$7.50 for two years, \$9 for three years; elsewhere, \$6.50 the year, \$11.50 for two years, \$15 for three years. Single copy \$1. Circulation Manager: Marshall T. Ginn. Every effort will be made to return material submitted for possible publication (if accompanied by stamped, addressed envelope), but the editors and the corporation will not be responsible for loss or damage. Other Dodge Services: Real Estate Record & Builders' Guide, Sweet's Files, Home Owners' Catalogs, Dodge Reports & Dodge Statistical Research Service.

**COVER:**

Russell House, Sarasota, Fla. Ralph S. Twitchell and Paul M. Rudolph, Architects. Color photograph by Joseph Janney Steinmetz

**THE RECORD REPORTS** . . . . . 9

News from the Field . . . . . 9

News from Washington. By Ernest Mickel . . . . . 15

Construction Cost Indexes . . . . . 26

Required Reading . . . . . 28

News from Canada. By John Caulfield Smith . . . . . 136

**SPACE AND PEOPLE** . . . . . 69

By Garrett Eckbo. Condensation of part of a new ARCHITECTURAL RECORD book, *Landscape for Living*, scheduled for publication early in 1950

**FOR JOYOUS LIVING AND FIVE CHILDREN** . . . . . 76

Residence for Mr. and Mrs. Maynard E. Russell, Sarasota, Fla. Ralph S. Twitchell and Paul M. Rudolph, Architects

**DESIGNED FOR VACATIONS** . . . . . 85

Hunting Lodge and Summer Cottage for Mrs. William P. Palmer, Jr., Blue Hill, Maine. Louis Gelders, Architect

**PLANNED FOR RESEARCH** . . . . . 88

Laboratories and Offices for the National Research Corp., Cambridge, Mass. Perry, Shaw and Heppburn, Architects

**BUILDING TYPES STUDY NO. 157**

**SMALL BUSINESS BUILDINGS** By Frederic Arden Pawley, Architect

Introduction . . . . . 94

Finance and Real Estate Viewpoint . . . . . 96

Location Factors: Decentralization, Zoning, Parking . . . . . 103

Planning . . . . . 106

Features, Equipment, Materials . . . . . 110

Fire Insurance . . . . . 110

**ARCHITECTURAL ENGINEERING**  
Technical News and Research

**AIR CONDITIONING WORKS WITH DESIGN** . . . . . 112

For Space Utilization, Flexibility, Economy. George L. Dahl, Architects and Engineers

**PREVENTING CONDENSATION IN DWELLINGS** . . . . . 115

**MOUNTAIN INN BUILT WITH PLASTICS** . . . . . 119

**TIME-SAVER STANDARDS** . . . Heating Systems for Houses 120

Part IV: Cast Iron Baseboard Heating Systems. By William J. McGuinness

**PRODUCTS** . . . for Better Building . . . . . 124

**MANUFACTURERS' LITERATURE** . . . . . 132

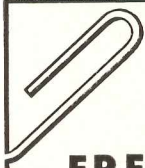
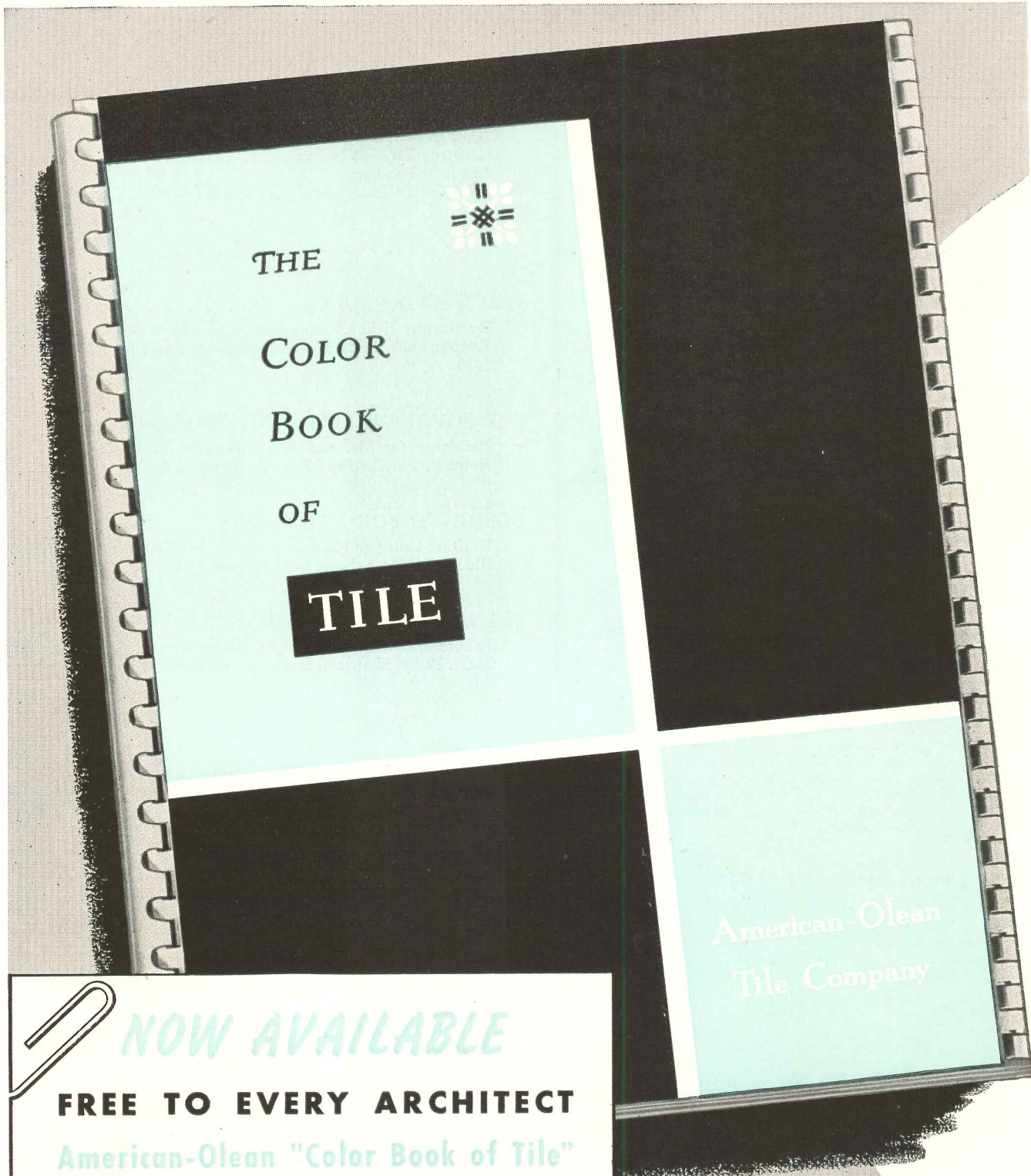

*NOW AVAILABLE*

**FREE TO EVERY ARCHITECT**



*American-Olean "Color Book of Tile"*

The most complete, most helpful tile book ever produced. One hundred pages, including thirty full color pages of typical installations, plus color charts of wall and floor tile, trim and hand decorated inserts. Full architectural data and ready-to-use specifications.

**YOUR COPY WILL BE MAILED TO YOU SOON  
BE ON THE LOOKOUT FOR IT**

# THE COLOR BOOK OF **TILE**

*makes it easy*

 **To Specify Tile**  **To Select Colors**

If you've ever searched through a catalog for tile specifications—or puzzled over a client's "description" of desired colors—you'll find relief in American-Olean's new "Color Book of Tile".

Specifying tile becomes easy. You'll like the color selections and the complete 42-word specifications which are given for each installation—ready for you to copy.

Your clients will like "The Color Book of Tile", too. With it, they can select colors and visualize the installations just as they will be in the homes you are planning.

All installations are shown in full color, with alternate treatments to choose from.

There's no other book like "The Color Book of Tile"—no other book so complete and easy to use.

A file-size copy is on the way to each architectural office on our list. Be sure to watch for it.

See our catalogue in Sweet's Architectural File for 1950, Sec. 13b.

Twenty pages, largely in color.

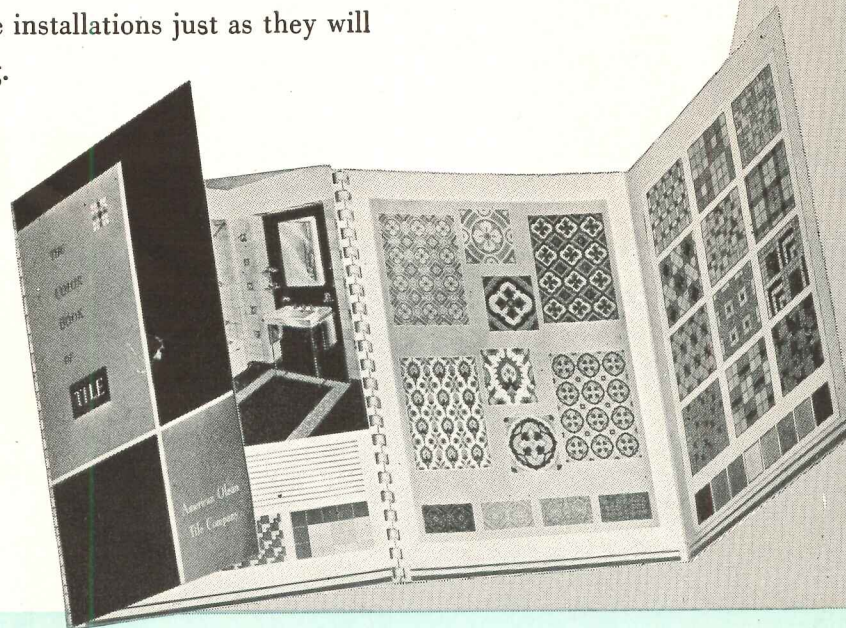

## American-Olean Tile Company

Executive Offices

925 Kenilworth Avenue, Lansdale, Pennsylvania

*4 years ago there were no*

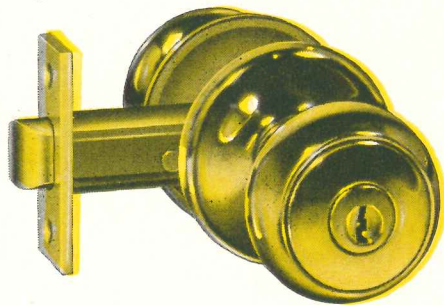

*NOW there are over 5 million in use*

**WHY?**

The answer is simple. No product can achieve such phenomenal success unless it fills a genuine need. KWIKSET locksets do. They provide a high quality, low priced lock of clean modern design and handsome finish, simple to install.

There's a KWIKSET lockset for every door in the house. Each is engineered to do perfectly the job for which it is intended. Each is designed with simple beauty to enhance the appearance of the home. Each is built to stand up under hard usage. And, best of all, KWIKSET locksets are priced to SELL!

Every one of the more than 5 million KWIKSET locksets now in use is its own best testimonial. Their quality, beauty and simple installation has found favor with architects, builders and home owners.

★ *Materials and Workmanship Unconditionally Guaranteed*

KWIKSET working parts of brass stamping or pressure moulded Zamak No. 5, and trim parts of wrought brass, wrought bronze or Zamak No. 5 are all precision engineered.

*Write for file size catalogue.*

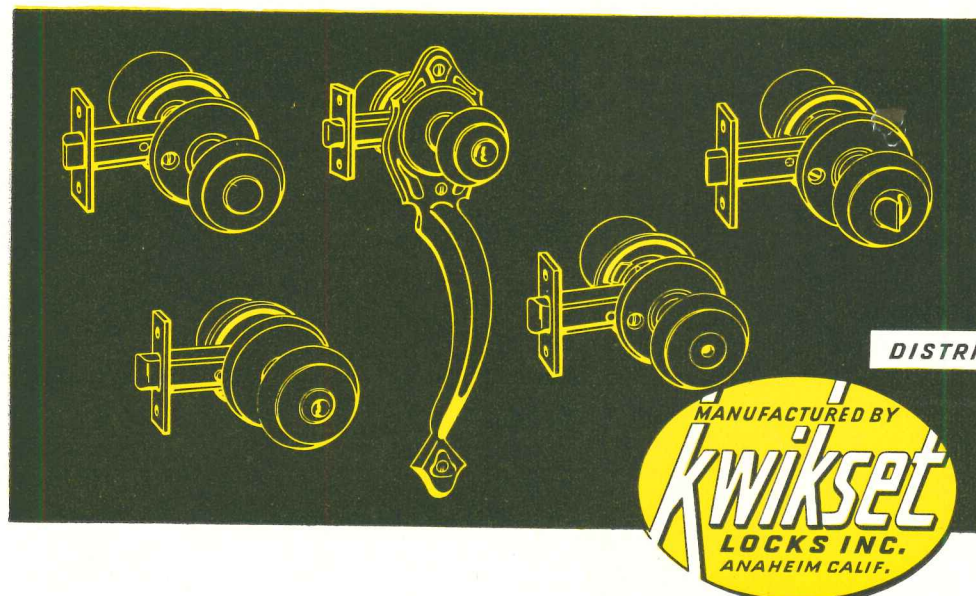

DISTRIBUTORS

**Petko**  
INDUSTRIES, INC.

1107 East Eighth Street  
Los Angeles 21, California

# THE RECORD REPORTS

## ARCHITECTS GATHER FOR A.I.A. REGIONAL CONFERENCES

### New England Hospital Seminar and two St. Louis meetings highlight increased Institute activity at chapter and regional level

#### *New England Seminar on Hospitals*

In Boston, about 125 architects who design hospitals and an equal number of hospital administrators, trustees and doctors discussed common problems from their different viewpoints in four sessions Dec. 2 and 3.

The Hospital Seminar, first regional meeting ever held by the six New England Chapters, was occasioned by current interest in hospital planning, and received a not-unexpected fillip from the new Hill-Burton Act, under which Congress has just doubled the amount of Federal funds for hospital construction.

The Seminar also was the first opportunity for open discussion of relations between architects and hospital consultants. Slocum Kingsbury, for the A.I.A., and Dr. Allen Craig, for the newly organized American Association of Hospital Consultants, exposed early liaison efforts of the two groups and traced out the two lines of responsibility in planning hospitals.

Basil C. MacLean, M.D., director of Strong Memorial Hospital, University of Rochester, was moderator at the first morning's session, when speakers were Henry N. Pratt, M.D.; William A. Riley, A.I.A.; Slocum Kingsbury, A.I.A.; Allan Craig, M.D.; Marshall Shaffer, A.I.A. Otis Anderson, M.D., addressed the luncheon meeting. At the afternoon session, with Douglas Orr, A.I.A., as moderator, the conference heard Herman Smith, M.D.; Alice C. MacKinnon; Victor A. Frid, A.I.A.; James H. Ritchie, A.I.A. Albert Snoke, M.D., was the dinner speaker.

In the absence of Walter I. Taylor, A.I.A. education and research director, Harold D. Hauf was moderator at the Saturday morning session, which featured Justin M. Kearney, C.E.; Lester E. Richwagen; Carl Walter, M.D.; Robert W. Cutler, A.I.A.; Roy Huden-

burg. At the luncheon round table on "Hospitals of the Future," speakers were: A. Daniel Rubenstein, M.D.; Henry R. Shepley, A.I.A.; Arthur G. Stephenson, F.R.I.B.A. (Melbourne, Australia); Isadore Rosenfeld; Nathaniel W. Faxon, M.D.; Robert Cutler.

#### *Educational and Regional Meetings at St. Louis*

There were two meetings in St. Louis. The first was an educational meeting on Thursday, November 17, held at Washington University. This was attended by representatives from all architectural schools in the Central States District. The morning session was devoted to discussion of the architectural design program as an instrument of architectural education. In the afternoon, Alfred Roth presented a paper on "In Search of a Theory of the New Architecture." Mr. Roth, prominent architect and author from Switzerland, is visiting professor of architecture at Washington University.

The second day's meeting, at St. Louis' Sheraton Hotel, was opened by Lorentz Schmidt, Director of the A.I.A. Central States District. Speakers included Philip Will, Jr., pinch hitting for Ernest Kump on the subject of school design. James M. Fitch, Jr., spoke on "Residences: Control of the Elements through Planting and Structure." Nathaniel A. Owings discussed design of large buildings and groups of buildings.

At the dinner that evening Ralph Walker, national president of the A.I.A., spoke on the necessity of integrating architectural education and practice. At the Saturday morning session on November 19, Kenneth Welch presented the subject of "Design of Stores, Planning and Lighting"; and Edmund Purves, executive director of the A.I.A., spoke on "The Institute, Legislation and You."



Photos: top, Charles McCormick; center, Peter Ferman

Pictured at conferences described on this page: (top, at Boston) Kenneth Reid, executive committee chairman; Dr. Basil C. MacLean; Charles D. Maginnis, F.A.I.A., general chairman; Charles D. Maginnis, Jr.; (center, at St. Louis) Alfred Roth, Swiss architect; Kenneth Wischmeyer, A.I.A. 2nd vice president; Lorentz Schmidt, A.I.A. regional director; Ralph Walker, A.I.A. president; (pointing) St. Louis A.I.A. Chapter President Arthur Kelly; above, again St. Louis, Dean Joseph Murphy with Mr. Roth

## THE RECORD REPORTS

### "BEST LOW COST HOUSING" IN MASSACHUSETTS

Hampshire Heights Housing Project  
Northampton, Massachusetts

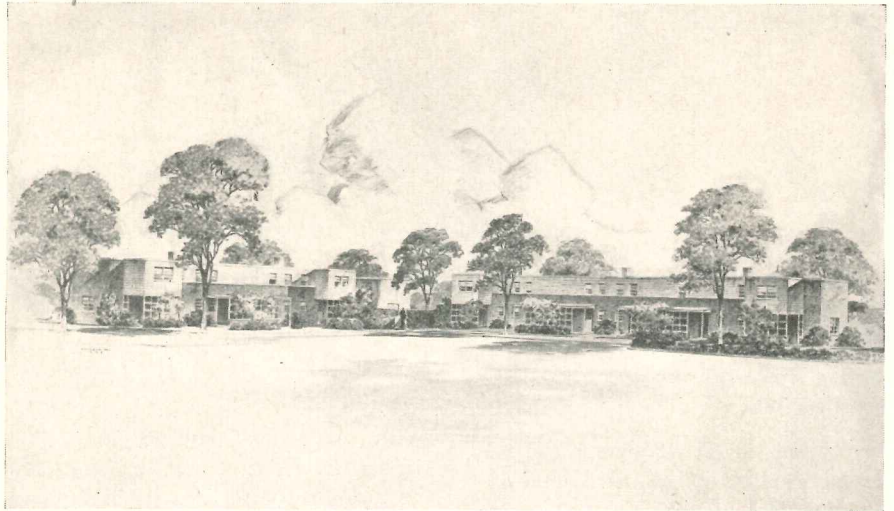

*James A. Britton, Architect*

*Jo Ray, Site Planner*

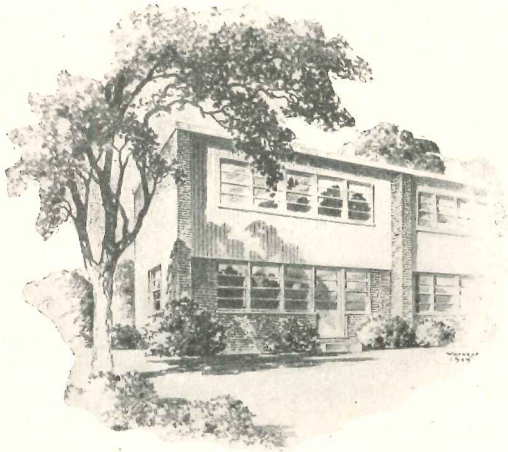

*Apartments were built at an amazingly low cost per unit. They are self contained, with individual equipment. Each has great privacy and views of gardens and mountains*

The Northampton Housing Authority, developer of this pleasant low-rent Veterans Housing Project now being completed, requested the architect to provide buildings modern in design and use materials requiring little upkeep. Units were to take advantage of views of two neighboring mountain ranges and have living rooms open on gardens.

The project comprises 17 four-apartment buildings and two six-apartment buildings, irregularly placed to avoid regimentation and give privacy. Buildings cover only 10.63 per cent of the sloping 9.61 acre tract, leaving space for

gardens, inclosed laundry yards and 100 per cent off-street parking.

Apartment units cost \$10,725.00 each, with basement and two floors in a row-house type of arrangement. On the first floor each unit has an entry, kitchen, living room and dining alcove. Either two or three bedrooms and a bath are on the second floor. Exteriors are of brick veneer and western cedar, and interiors have hard plaster walls and asphalt tile floors. Equipment provided includes individual forced warm air heating plants, hot water heaters, electric ranges, incinerators and laundry facilities.

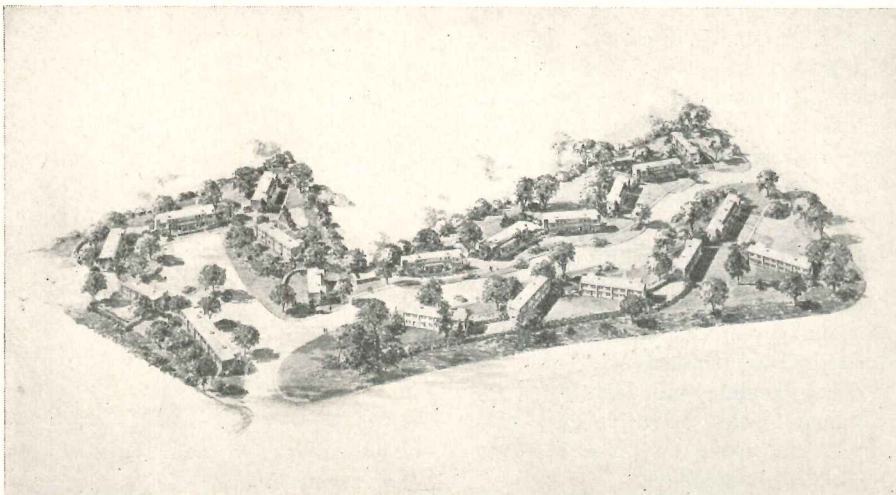

*The Massachusetts State Housing Board and other housers and planners have cited this project as the best example of low cost housing and site planning in the state*



## QUALITY HOUSES SPECULATIVELY BUILT IN SALT LAKE CITY

*Integrated indoor-outdoor living areas add space to compact houses. The frank, simple units are designed for repetition.*

Joern Gerds Photo

*Fred Markham, Architect  
W. Rowe Smith, Designer*

These forthright, well designed houses are part of the nation-wide program of the Revere Quality House Division, Southwest Research Institute, to promote better residential building. The houses were exhibited to show quality of construction and design obtained in moderate priced structures by close architect-builder teamwork.

The problem set was the design of a salable unit which could be repeated to produce a harmonious grouping, flexible enough to retain individuality. A balance was struck between low first cost and low maintenance expense. All construction difficulties were carefully studied to help formulate new standards.

Two basic schemes were evolved, as shown here in plan and photograph. Plans were designed to give a sense of openness, yet maintain good circulation and privacy. South walls are mostly glass and face enclosed outdoor living areas. To further the sense of space, ceiling lines were sloped with the roof, the vertical redwood siding was used on some interior walls, and windows run to the ceiling where possible. The developer states he would build more of the frame houses on any lot in Salt Lake City for about \$12,000, including landscaping, electric dishwasher, disposer, heating, washer, and carpets in living and dining rooms.

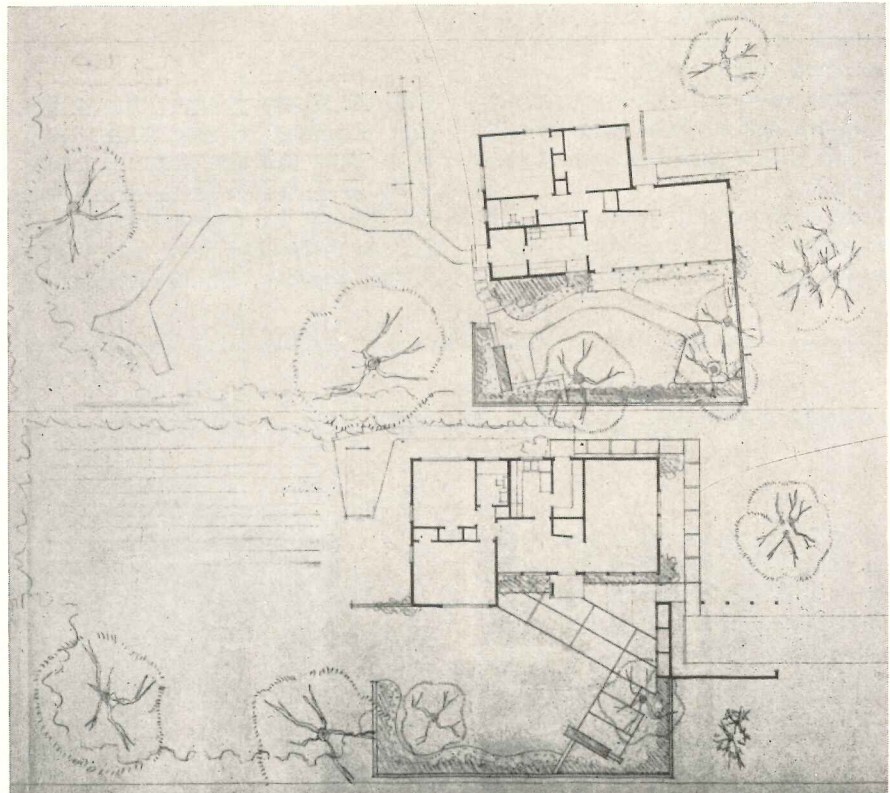
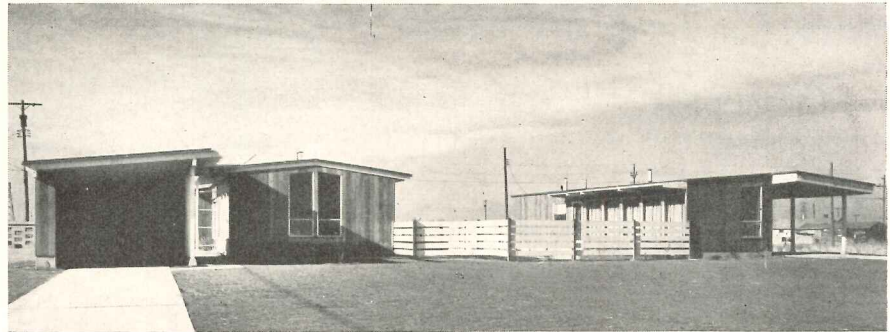

## INDUSTRIAL ADMINISTRATION SCHOOL AT CARNEGIE

Ground will be broken next spring for the nation's first graduate school of industrial administration on the Carnegie Institute of Technology campus, Dr. Robert E. Doherty, Carnegie's president, has announced. Architects for the building are Raymond M. Marlier and B. Kenneth Johnstone of Pittsburgh.

Mr. Johnstone is head of the Department of Architecture at Carnegie.

The million-dollar building, financed under a six-million-dollar gift to Carnegie for foundation of the school by the W. L. and May T. Mellon Foundation, will include, besides offices and classrooms, a 6000-volume library, a lecture hall to hold 150 students, laboratories, and a student lounge for informal discussion groups and relaxation.

Opened on an experimental basis this year, the school will begin full-scale operation next September.

*Architects Marlier (right) and Johnstone of Pittsburgh discuss their model for building*

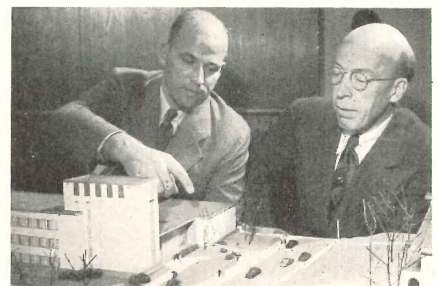

## THE RECORD REPORTS

### \$4000 HOUSE DESIGN OFFERED TO RAISE LOW-COST STANDARDS

*The Design Office of*

*J. Bennett Smith, Designer*

Three rooms plus bath and entry and a one-car garage were achieved for \$4000 in this California house built under war-time restrictions in 1945.

With overall floor space of 624 sq ft, the house, which was recently sold for \$9500 with an \$8500 FHA guarantee, contains living-dining room with fireplace and storage wall; kitchen with breakfast space and laundry area; bedroom with 10-ft wardrobe including mirror and drawer; and bath with shower over tub.

The designer frankly offers this job as a challenge to such current "low-cost" housing projects as Housing Expediter



Garber-Sturges Photo

Tighe E. Woods' Housing, Inc., which plans to market two-room houses 14 by 36 ft with half-acre plots for about \$6750 in a 42-acre development near Fort Belvoir, Va. (See ARCHITECTURAL RECORD, September 1949, page 10.)

"This dwelling," Mr. Bennett says of

the house designed by his office, "gave the client more than a makeshift kind of living." The Housing, Inc., plan, Mr. Bennett writes, "leaves so much to be desired I believe a trailer would offer more. The people of America want homes, not housing."

### DANISH ARCHITECT HERE TO STUDY U. S. SCHOOLS

Eric Stengade, 35-year-old Danish architect who was in charge of designing the Danish exhibition hall for the New York World's Fair, is in this country to study contemporary school buildings before undertaking a commission to design a permanent home for the new Bernadotte International School in Copenhagen.

The school, which was officially opened last August with some 240 students from many countries, now occupies an old building (decorated by the children themselves) which is far from adequate. Parents of the children, who range in age from 4 to 11, are raising money for the new building, with a promise from the Danish government to match any sum they can raise, although the school is independent of the state system.

Mr. Stengade's recent work includes the three-room house (photos at right) which was built two years ago for the equivalent of \$1200.

A former assistant to Tyge Hvass, leading Danish architect, Mr. Stengade was recently awarded the Gold Medal of the Royal Academy of Fine Arts in Copenhagen for his design of a newspaper plant.

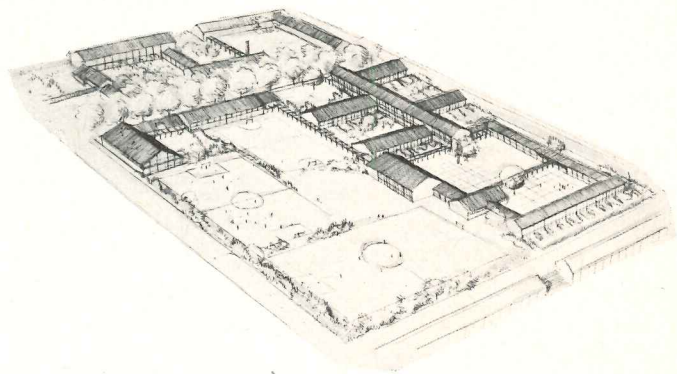

Rendering (above right) shows architect's preliminary drawing for projected building for Bernadotte School. Photos (right and below) show exterior and interior views of house built at cost of \$1200



**TO BE TRULY MODERN A BUILDING MUST BE AIR CONDITIONED**

# *Year 'Round Comfort by Chrysler Airtemp*



The Berkshire Apartments, 4201 Massachusetts Avenue, Washington, D. C. Builder: Standard Construction Company, Washington, D. C., Wm. Magazine, President, Charles Kaplan, Secretary. Architects: Corning & Moore. Consultants to Builder: Wm. Bornstein & Son, Inc., Chrysler Airtemp Dealer. Mechanical & Electrical Engineers: General Engineering Associates.

## **Chrysler Airtemp Individual Room Air Conditioners Selected for Washington's Largest and Finest Apartment Building**

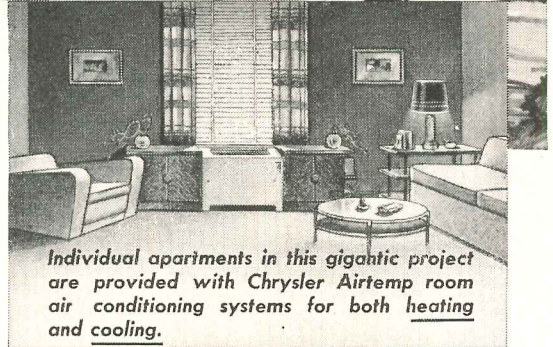

*Individual apartments in this gigantic project are provided with Chrysler Airtemp room air conditioning systems for both heating and cooling.*

In Washington's new Berkshire Apartments—believed to be the largest single apartment building in the United States—Chrysler Airtemp Air Conditioning units were selected due to their attractive and compact design; their quiet, automatic and dependable operation. Here over 1000 tons of Chrysler Airtemp refrigeration and water cooling equipment—using 1350 individual room units—is now being installed.

Perhaps you, too, are planning new construction or the modernization of an existing building. If you are,

Chrysler Airtemp offers through its nationwide dealer organization or regional offices in principal cities the services of highly-trained field engineers to help select the most efficient air conditioning systems for your specific job. And when desired, Airtemp Construction Corporation—wholly owned subsidiary of Chrysler Corporation—will see the entire job through to completion, including supervision of field operations.

For additional information relative to Chrysler Airtemp's engineering services, send coupon today.

### **3 BASIC SYSTEMS TO MEET EVERY BUILDING NEED**

**CENTRAL SYSTEMS**

**"UNITEMP" SYSTEMS**

**INDIVIDUAL ROOM UNIT SYSTEMS**

# *Chrysler Airtemp*

**AIR CONDITIONING • HEATING  
COMMERCIAL REFRIGERATION**

AIRTEMP DIVISION OF CHRYSLER CORPORATION, DAYTON 1, OHIO

**AIRTEMP DIVISION OF CHRYSLER CORPORATION**

Dayton 1, Ohio

A-1-50

We would like to consult one of your field engineers regarding our air conditioning problems.

Name \_\_\_\_\_

Address \_\_\_\_\_

City \_\_\_\_\_ Zone \_\_\_\_\_ State \_\_\_\_\_

# Fine Flush Valves for Fine Buildings

For complete information on Watrous Flush Valves see our catalog 449.

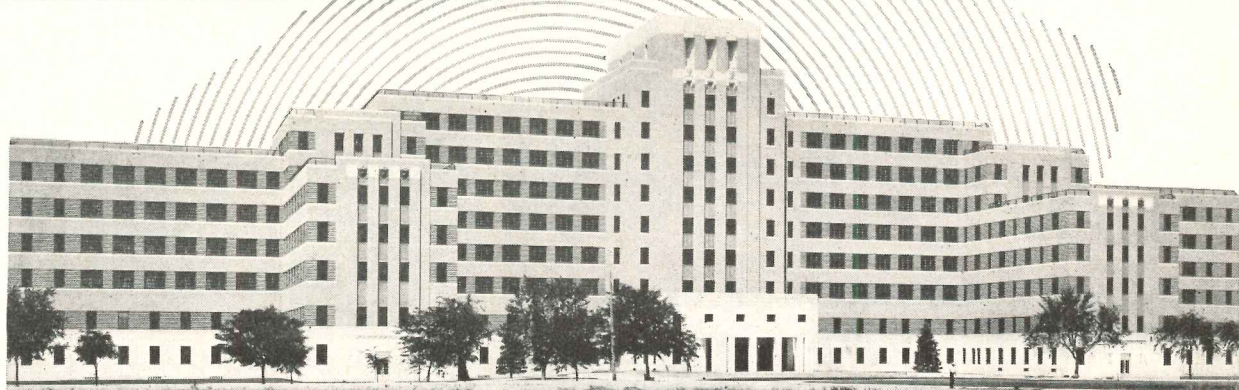

## FITZSIMONS GENERAL HOSPITAL

Denver, Colorado, one of the many  
fine buildings equipped with  
Watrous Flush Valves.

L. M. LEISENRING  
Architect

THOS. F. SHEA CO.  
Plumbing Contractor

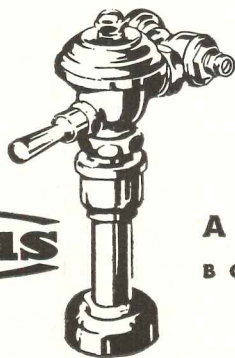

**Watrous**

**ADJUSTABLE FLUSH VALVES  
BOTH DIAPHRAGM AND PISTON TYPES**

**THE IMPERIAL BRASS MANUFACTURING COMPANY  
1240 W. Harrison Street, Chicago 7, Illinois**

WASHINGTON NEWS by Ernest Mickel

High on the federal government's list for priority planning are the more than 500 post office and other federal building projects authorized by a new act of Congress in 1949.

Just a month ago the General Services Administration and the Post Office Department made a selection of 313 federal building projects for which sites will be acquired where needed and for which plans and specifications will be prepared for future construction.

This action sets in motion the plan to resume construction of buildings of this type after a virtual lapse for the past 14 years.

The bill passed during the last session of Congress (now Public Law 105) authorized \$40 million for site acquisition and the preparation of plans and specifications for approximately 575 projects estimated to cost \$377 million when completed. Later the Congress made \$12 million of this \$40 million available. Public Buildings Administration, a GSA constituent agency, now is  
(Continued on page 16)

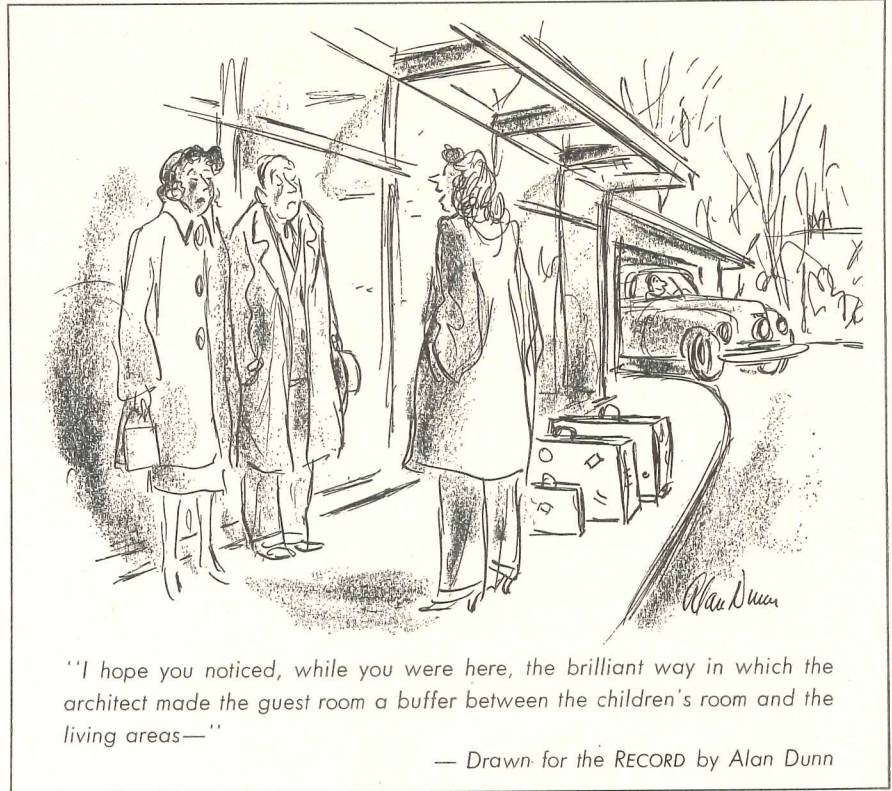

"I hope you noticed, while you were here, the brilliant way in which the architect made the guest room a buffer between the children's room and the living areas—"

— Drawn for the RECORD by Alan Dunn

TRANSFIGURATION SCHOOL, Tarrytown, New York Robert A. Green, Architect

Among the most widely visited schools built in this area within recent years, this school for a Carmelite parish was the outcome of an intensive postwar investigation by the Archdiocese of New York of low-cost construction in the school field. Built at a cost of 84 cents

per cu ft, it was developed as a prototype for the projected school building program of the Archdiocese.

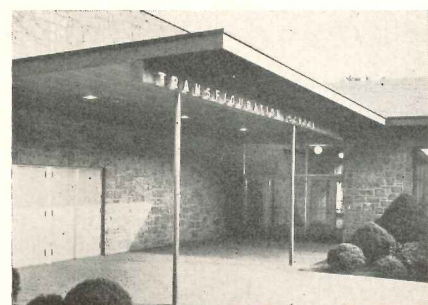

Center of interest on the school's north side is sheltered main entrance (below)  
Photo by James Vincent

per cu ft, it was developed as a prototype for the projected school building program of the Archdiocese.

Before Archdiocesan officials brought the problem to Mr. Green for his solution, they had canvassed the possibilities of the prefabrication field, and of other current types of "low-cost" construction, and had come to the conclusion that, as they express it, use of "standard methods of construction, simplified, was the direct answer."

As finally evolved, the plans called for a one-story structure of native stone, backed by hollow textured concrete blocks, with interior face exposed to become classroom wall surface, unplastered and unpainted. Corridor walls were built of the same blocks, with glass block "borrowed lights."

Each room has a large projected-type window, with upper and lower sections

movable and center section fixed to give the appearance of a picture window. Lighting fixtures for all classrooms are of the concentric ring incandescent type, an inexpensive fixture with maximum lumen output and minimum maintenance.

Expenditure of \$282,261 completed a school containing eight classrooms, for 350 children; a kindergarten; a combination meetingroom-lunchroom for 75; administrative offices; an auditorium-gymnasium seating 500 and fully equipped for both its functions. The figure covered cost of equipment, including the radiant heating installation, furnishings and draperies.

Opened for classes this Fall, the school has been described by the parish Fathers as "a proper jewel to crown 50 years of growth in the Parish of the Transfiguration in Tarrytown."

## THE RECORD REPORTS

WASHINGTON  
(Continued from page 15)

launching the planning and site program with this initial appropriation.

The remaining selections from an original listing of some 4000 eligible projects will be announced by PBA and the Post Office Department in a few weeks.

The law as now in operation provides no construction funds for any of these buildings. Appropriations for the start of the site work would have to come in new legislation after the funds were authorized. But until this construction does start, sometime in the next few years, a portion of the planning activity will be assigned by PHA to private architects.

In announcing the first selection of projects, GSA said it was the expressed intent of Congress that each Congressional district participate "in the benefits that will accrue from the future construction of one or more of the selected programs."

### Planning for Non-Federal Projects

Architects have as vital an interest in another GSA program moving forward, the advance planning of non-federal public works.

A little over a month ago GSA Administrator Jess Larson announced allotment of the initial \$25 million to states and possessions—the first portion of a \$100 million outlay authorized by Congress last year to reactivate the Bureau's loans.

In practice, the advance loaning program works this way: states, counties, cities and towns borrow a sum from the Bureau to cover the cost of preparing plans and specifications on non-federal public works such as schools, hospitals, sewers, waterworks, streets, municipal buildings and like projects. The loans are interest-free and repayment to the U. S. Treasury begins whenever construction starts.

### Architects and Housing

The nation's private architects were in the throes of argument with public housing personnel over what constitutes an adequate fee schedule, fair payment for services rendered on public housing projects.

(Continued on page 18)

# THE H & H WIRING DEVICE *Line* HAS EVERYTHING

## FOR RESIDENTIAL WIRING



## FOR INDUSTRIAL WIRING

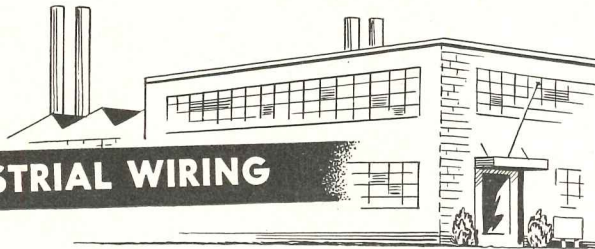

The wiring devices shown above represent just a few of the hundreds in our complete line. And it's your line! In it, you have everything you need to meet the most complex specifications—quickly and easily. More than 35 different classifications of wiring devices to choose from! In all, more than 1800 individual, cataloged units—everything you need for the ultimate in convenience, utility and dependability.

See our listing in Sweet's Architectural File.

Branch Offices: Boston, Chicago, Dallas, Denver, Detroit, Los Angeles, New York, Philadelphia, San Francisco, Syracuse

In Canada: Arrow-Hart & Hegeman (Canada) Ltd., Mt. Dennis, Toronto

For more information, write today to:  
1901 Laurel Street  
Hartford 6, Conn.

ARCHITECTS  
WHO KNOW BEST  
SPECIFY

WIRING  
DEVICES



ENCLOSED  
SWITCHES

THE ARROW-HART & HEGEMAN ELECTRIC COMPANY  
HARTFORD, CONNECTICUT

**R.H. WHITE'S**  
 WASHINGTON AT BEDFORD STREET  
 BOSTON 12

November 18, 1949

EXECUTIVE OFFICES

Mr. Martin A. North  
 Director of Merchandising  
 Southbridge Plastics, Inc.  
 470 Fourth Avenue  
 New York 16, N. Y.

Dear Mr. North:

Thank you for your letter stating that R. H. White's is one of the principal stores using Vinatred.

We have six departments now covered with Vinatred, and it not only improves the appearance of the store, but has been received with pleasure by our customers and sales force.

We are pleased with its performance and attractiveness.

Yours sincerely,

R. H. WHITE'S

John B. Knox  
 President

JBK:ENG

**R. H. WHITE'S**  
 in its beautiful remodeled store  
 has installed the new  
**Vinatred**<sup>®</sup> vinyl carpeting



**IN THE TODDLER SHOP,** Vinatred keeps the floor clinically clean and safe for young footsteps.

**Vinatred** is a clear vinyl carpeting with embossed surface, fabric-backed.

It comes in 8 decorator colors, and prints.

Results of rigid tests by the United States Testing Co. prove that Vinatred has a non-porous, cleanable, sanitary surface; superior wear resistance; skid-resistance; resilience when laid as recommended with Vinatred cushion.

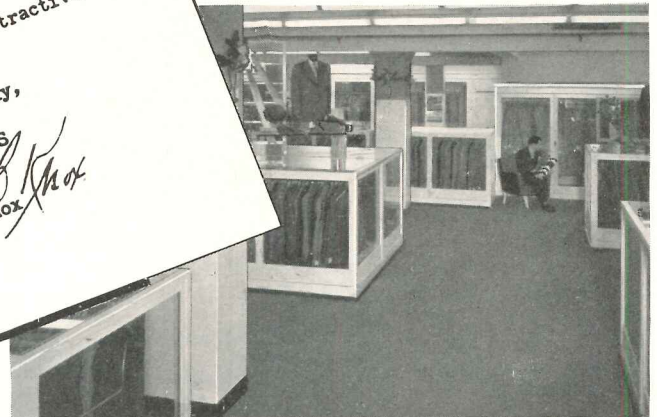

**IN THE MEN'S SHOP,** Vinatred provides a business-like impersonal character plus long-time durability.



**IN THE CHINA SHOP,** Vinatred creates a colorful setting that is quiet, too, under customer traffic.

Write for the name of the distributor in your vicinity.

**Southbridge Plastics Inc.**

470 FOURTH AVENUE · NEW YORK 16, NEW YORK

## THE RECORD REPORTS

### WASHINGTON

(Continued from page 16)

A.I.A. President Ralph Walker told delegates to the 16th annual convention of the National Association of Housing Officials in Boston that he considered the present fee schedule on PHA projects woefully inadequate. The Institute has advised its members that they accept the fees "at your own risk."

PHA has contended that private architects have been receiving more than six times the amount of their payroll expense on public housing projects, while Mr. Walker has told the public housers: "You are not dealing with a capitalist class. The net take-home pay of three-fourths of the country's architects is \$5000 or less a year."

Operating procedures for the vast slum clearance and urban redevelopment phase are being promulgated now and will be issued to local authorities soon. Here again, architectural and engineering services will be of vital concern to those charged with clearing sites and projecting new developments. Congress authorizes the government to pay up to two-thirds of the net write-off of clearing these slum areas and has provided \$1 billion in loans to help cities clear and prepare slum sites for redevelopment.

### Shorts

- Atomic Energy Commission stepped up the pace of its huge construction program. At Oak Ridge, Tenn., with building well started on Unit K-29, AEC said the contractor, Maxon Construction Co., Inc., Dayton, Ohio, had been approved as construction contractor for a fourth gaseous diffusion unit, K-31, costing about \$162 million. Giffels and Vallet, Inc., L. Rosetti, Detroit, Mich., having designed the \$66 million K-29 project, also have been approved as architect-engineer for K-31.

- First research correlation conference of the new Building Research Advisory Board will be held in Washington, D. C., January 11 and 12. Under the title "Weather and the Building Industry," this conference will consider climatological research and its effects on building design, construction, materials and equipment. Exhibits of new climate research results will be shown. This meeting will be conducted informally.

(News continued on page 20)

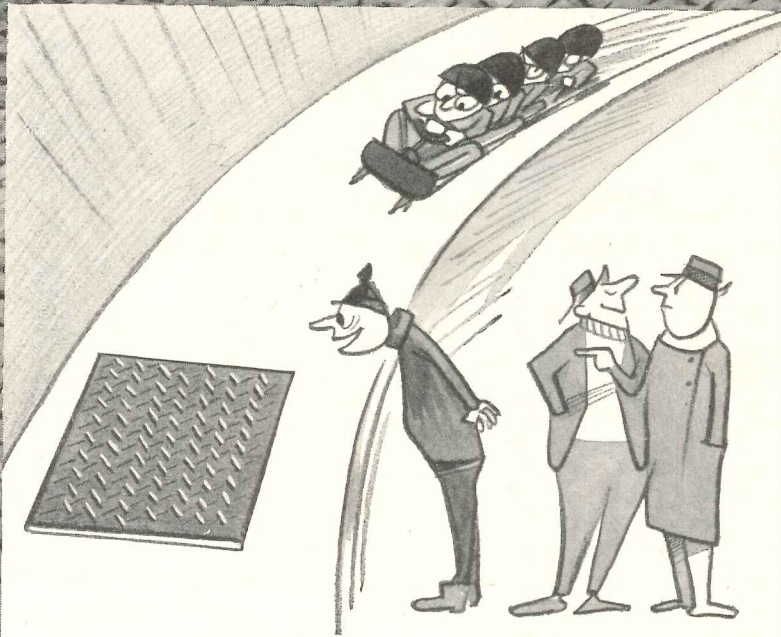

"Johnson wants to see the fun when they hit that slip-resistant 4-WAY Safety Plate."

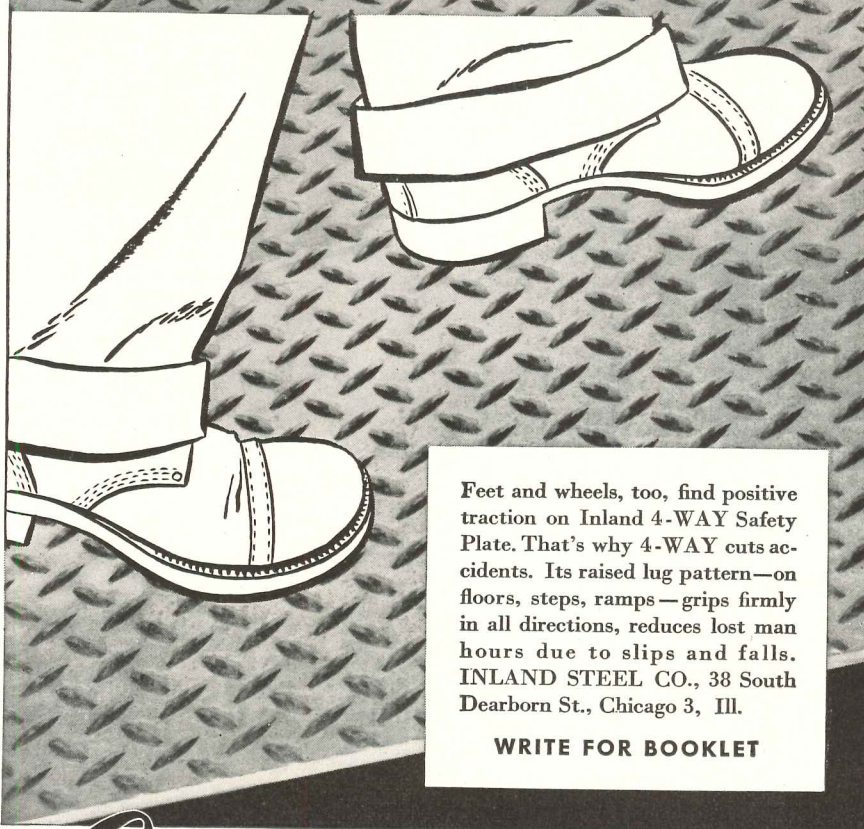

Feet and wheels, too, find positive traction on Inland 4-WAY Safety Plate. That's why 4-WAY cuts accidents. Its raised lug pattern—on floors, steps, ramps—grips firmly in all directions, reduces lost man hours due to slips and falls. INLAND STEEL CO., 38 South Dearborn St., Chicago 3, Ill.

WRITE FOR BOOKLET

Inland  
**4-WAY SAFETY PLATE**

Reg. U. S. Pat. Off.

STOCKED BY LEADING  
STEEL WAREHOUSES



# Build Smokeless FIREPLACES without costly supervision!

## Compact Heatilator\* Unit insures correct construction

With the growing shortage of skilled masons, are you spending too much time supervising fireplace construction?

Use a Heatilator Fireplace Unit, and insure a fireplace that draws properly and will not smoke.

The Heatilator Unit is a complete fireplace from hearth to flue, around which the decorative masonry is built. It consists of:

1. A scientifically designed firebox
2. A properly proportioned throat to insure proper draft
3. A removable damper with adjustable poker control
4. Extra wide down-draft shelf made of heavy steel
5. Complete metal smoke dome to speed passage of smoke into chimney

By providing these parts in one compact form, with no extra parts to buy or build, the Heatilator Unit permits unsupervised construction. It eliminates guesswork and other causes of failure.

## Costs little, if any, more than ordinary fireplace

Because the Heatilator Unit is ready to install, it saves mason time and labor. It saves on expensive firebrick. Thus, a completed Heatilator Fireplace costs little, if any, more than an ordinary fireplace! In addition to this original economy, your client can count the dollars-and-cents savings of smokeless, trouble-free operation.

## Heatilator Unit ups fireplace efficiency

The Heatilator Fireplace draws in cool air from floor level, heats it, and circulates it to every corner of the room, and to other rooms as well. On cool Spring and Fall days, this use of heat ordinarily wasted makes furnace operation unnecessary. In mild climates, it is the only heating equipment needed. It saves the cost of expensive heating plants that are used only a short time each year.

Heatilator Fireplaces are ideal for summer camps and cabins, making them usable weeks longer in Spring and Autumn. It solves the heating problem in basement recreation rooms without unsightly pipes

\*Heatilator is the reg. trademark of Heatilator, Inc.



## HEATILATOR UNITS ADAPT THEMSELVES TO ANY DESIGN



A Colonial Fireplace built around a Heatilator Unit. Warm-air grilles are located in the bookshelf sides.



Classic design, with the modern advantages of a Heatilator Fireplace Unit. Grilles are located at sides.



A Heatilator Fireplace is the only heating equipment needed for many Florida homes, like this one.

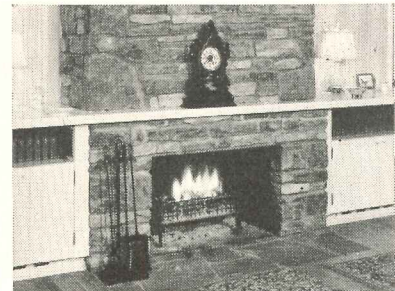

The grilles in this Northern field-stone fireplace are hard to find. An example of ingenious design.

and radiators. Heatilator Units, made of boiler plate steel, are built for a lifetime.

A Heatilator Fireplace permits any architectural style and the use of any material. The air intake and outlet grilles are easily placed to blend with the general design. When the mantel projects, the grilles are out of sight. If the mantel is flush, the intakes can be placed in baseboards on either side of the hearth . . . outlets high above mantel, in ceiling, or in an upstairs or adjacent room.

Give clients the advantages of a Heatilator Unit.

Write today for complete information and illustrations showing the variety of architectural styles possible with Heatilator Fireplace Units. Heatilator, Inc., 611 E. Brighton Avenue, Syracuse 5, N. Y.

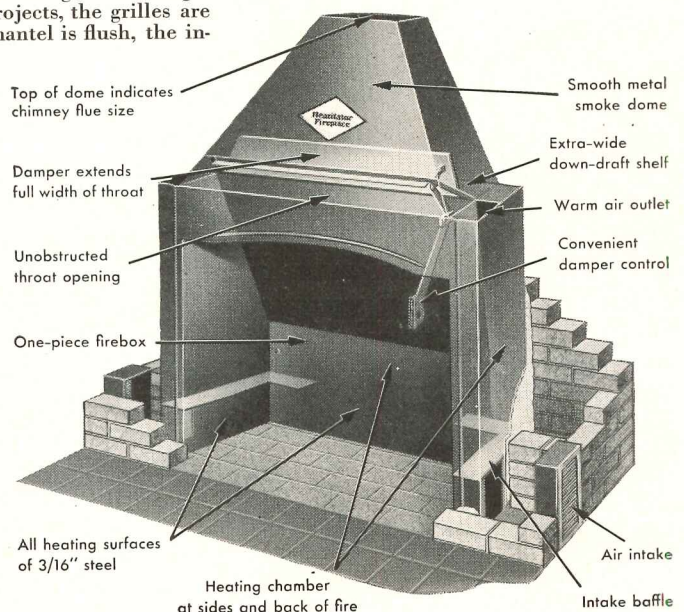

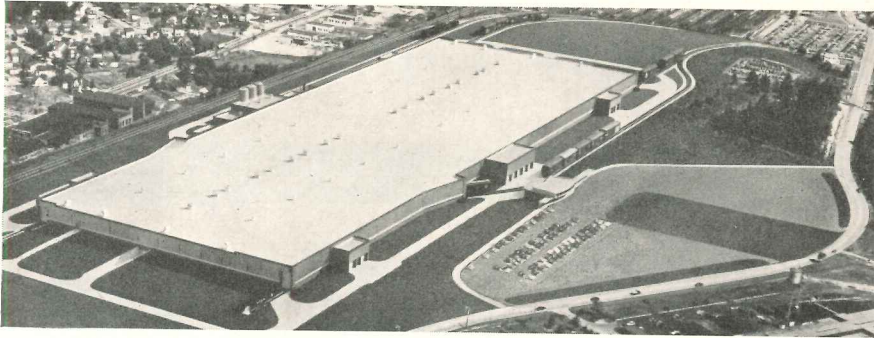

**NEW PLANT FOR LINCOLN ELECTRIC COMPANY**

*The Austin Company,  
Engineers and Builders*

With a basic floor plan and functional layout which are expected to reduce cost of materials handling to a minimum, this Euclid, Ohio plant for manufacturing welding equipment (model photo at left) is essentially a one-story structure, 1400 by 500 ft, with a centrally-located 60-ft-wide service floor the full length of the building (east to west) below ground.

The building, to be erected at an approximate cost of \$8,500,000 for 850,00 sq ft of floor space, has a framework of shop and field welded structural steel and a flat roof. Aluminum facing sheets, specially rolled to form 3½-in.-deep box sections 15 in. wide and 25 ft deep, are being used for the exterior facing. The inner wall consists of 1¾ in. steel panels of comparable height are welded to framing.

The strength of the lightweight, deep-drawn aluminum facing units makes it possible to span a distance of nearly 20 ft vertically without any intermediate girts. They are being supported entirely by three rows of specially-designed composite aluminum-and-steel stud-welded fasteners.

**PRODUCT LITERATURE COMPETITION**

Awards to three classes of technical and promotional literature prepared for architects by manufacturers of building products will be made in a competition being sponsored by the Producers' Council and the American Institute of Architects.

All manufacturers of building materials and equipment may submit entries, and architects are also invited to make nominations for the awards. All entries and nominations must be made by Mar. 15, 1950.

Awards in the three classes — technical and design data, data on use and application of products, and promotional literature — will be announced next May.

Manufacturers should submit entries to the Producers' Council, 815 15th St., N. W., Washington, D. C.; architects or A.I.A. chapters should send their nominations to the American Institute of Architects, 1741 New York Avenue, Washington, D. C.

(Continued on page 22)

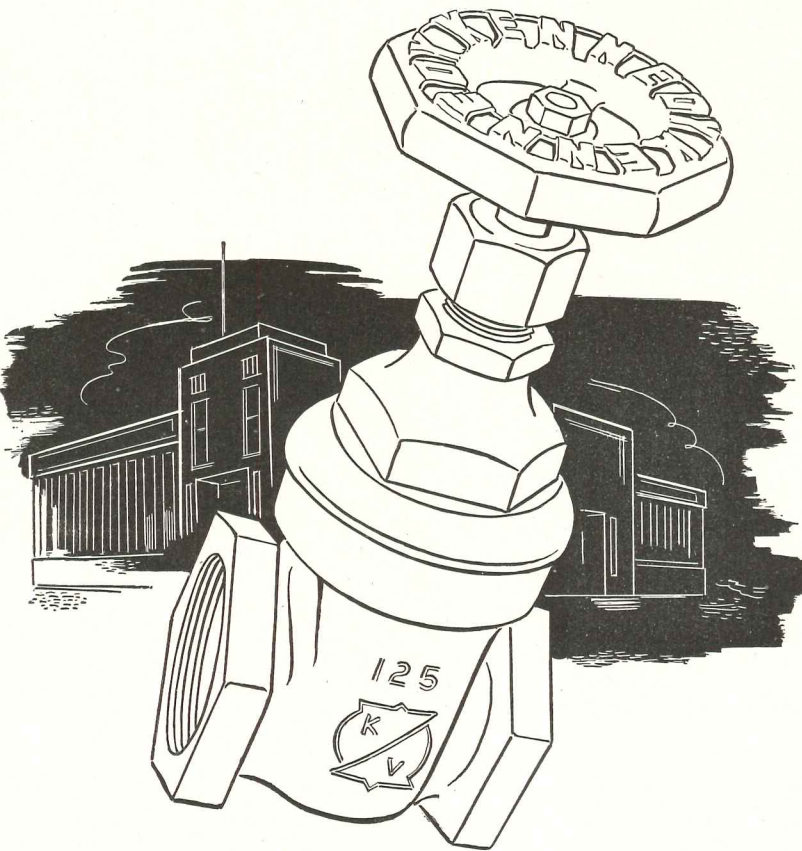

*Beneath the Beauty you create...*

and a part of it, is function. Underlying the function, and contributing to it is the quality and the performance of the equipment and materials you specify. That is why, for assurance of complete reliability and of the utmost dependability you will want to specify KENNEDY Valves. KENNEDY offers a complete line of iron and bronze valves in all sizes and for all purposes, backed by seventy-three years of valve making experience. Write for the complete catalog.

Established 1877

**The KENNEDY VALVE MFG. CO.**  
ELMIRA, NEW YORK

VALVES • PIPE FITTINGS • FIRE HYDRANTS



Unistrut steel channel and fittings, roller pipe supports and concrete inserts at work in a tunnel installation at G. D. Searle & Co., Skokie, Illinois, manufacturers of ethical pharmaceuticals.

# FOR TUNNEL PIPING and EQUIPMENT SUPPORTS use **UNISTRUT METAL FRAMING**

Completely adjustable Unistrut provides flexibility you need for right pitch or slope... You make adjustments, changes, additions at any time... reduce costs, too!

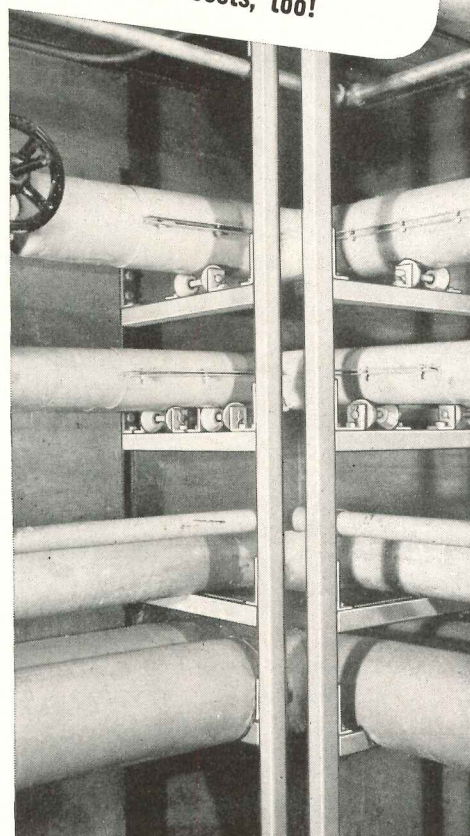

● Unistrut consists of patented metal framing, spring nuts, standard parts and fittings, which in combination provide the world's most flexible method of support or suspension.

With completely adjustable and reusable Unistrut, normally difficult and complex piping runs may be installed with extreme accuracy, quickly and easily with just a hacksaw and a wrench. No drilling—no welding—no special tools or equipment!

Piping runs can be installed to exactly the right pitch or slope. Adjustments and changes are easily made by the mere loosening of a nut. Additional framing may be added at any time when more piping runs are needed.

Unistrut is trim framework, providing great strength without bulk. It's easy to work with, lasts indefinitely, and the finished structure assures neat and orderly appearance.

Unistrut cuts costs too. You save time in your engineering department and you eliminate the need for trained erection crews—anyone can build with Unistrut.

A trial of Unistrut on your next piping job will show you how much quicker, better and more economically the work can be done.

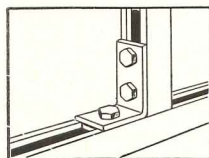

Close-up of patented Unistrut channel members, spring nuts and fittings of a type used in the Searle installation.

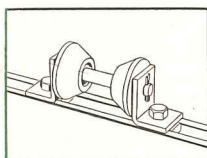

Unistrut single axle 2-roller pipe supports as seen in the accompanying photographs. Types available to support from 1" to 36" O.D. pipe.

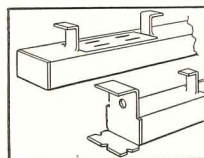

This Unistrut concrete insert is the type used on the Searle job. 1600 lbs. per foot load capacity. Other sizes and styles available.

WRITE TODAY FOR FREE SAMPLE OF UNISTRUT AND THE FOLLOWING CATALOGS:

Prompt delivery from Warehouse Stocks in Principal Cities. Consult your Classified Directory.

U. S. Patent Numbers  
2327587 2329815 2345650  
2363382 2380379 2405631  
Other patents pending.

**CATALOG 500—**  
24 pages on how to build frames, hangers and supports for electrical, plumbing, heating and air conditioning equipment—right on the job.

**CATALOG 600—**  
24 pages on how to build racks of all kinds—pallet, bar stock, pipe, tube, conduit, automotive parts, hardware, furniture, floor covering, stock bin racks, and many others.



The World's Most Flexible All-Purpose Metal Framing

**UNISTRUT PRODUCTS COMPANY**  
1013 W. Washington Blvd. • Chicago 7, Illinois

## UNISTRUT PRODUCTS COMPANY

Dept. R1, 1013 W. Washington Blvd.  
Chicago 7, Illinois

Please send sample of Unistrut and catalogs checked below without obligation.

Catalog 500       Catalog 600

Name \_\_\_\_\_

Company \_\_\_\_\_

Address \_\_\_\_\_

City \_\_\_\_\_ Zone \_\_\_\_\_ State \_\_\_\_\_

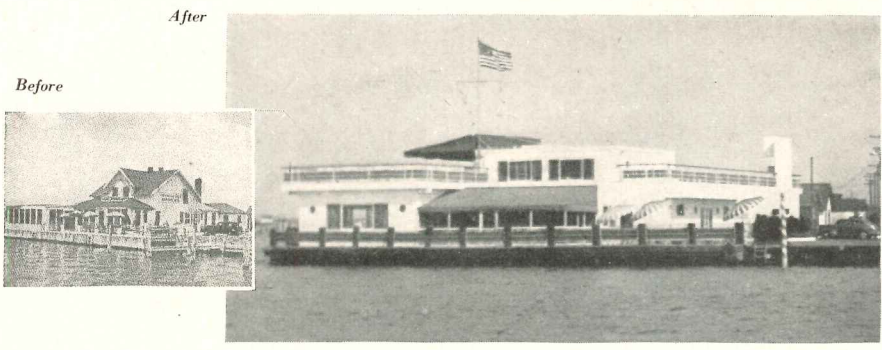

REMODELLED RESTAURANT

Edmund Lumley, Jr., A.I.A., Architect

Less than five months from the day Orchestra Leader Guy Lombardo gave the go-ahead signal for the alterations and addition to his restaurant at Freeport, L. I., the transformation illustrated by the photographs (left) had been effected.

Lobby, cocktail lounge and bar, with offices above, are in the two-story portion shown in the "before" photograph, with the new flat roof as one of the most striking exterior changes. The dining room and kitchen were entirely rebuilt, using pile foundations, steel frame and plywood exterior and interior.

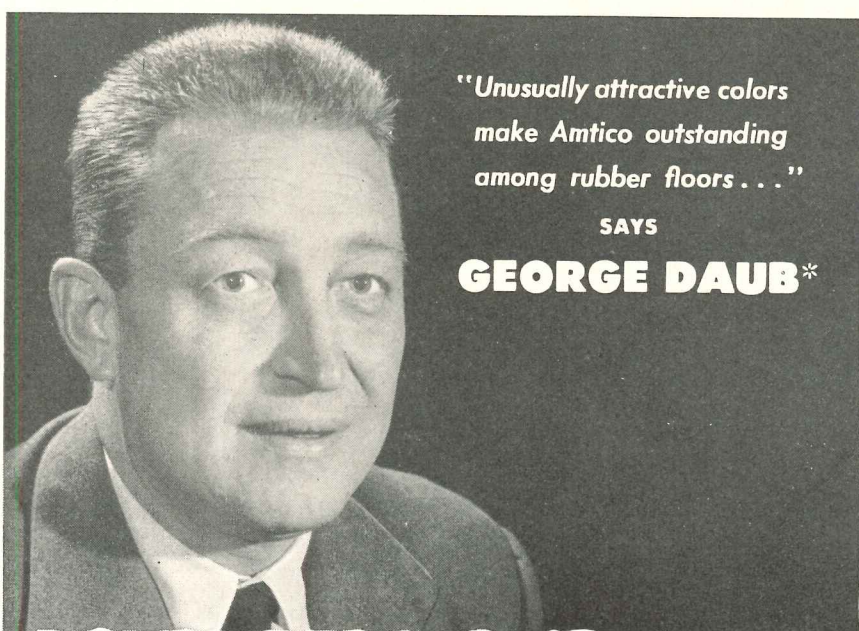

"Unusually attractive colors make Amtico outstanding among rubber floors..."

SAYS

GEORGE DAUB\*

\*Noted Architect

AMTICO offers the architect 22 stock colors, many of them unique. Color matching and unusual sizes on special orders, too. When you have a resilient flooring installation that requires the maximum in looks, easy maintenance, comfort, quiet, fire resistance and the ability to stand punishing traffic for a lifetime, specify AMTICO—product of specialists in rubber flooring exclusively for 30 years.

SAMPLES ON REQUEST

A free box of 4" x 4" samples of Amtico in standard 1/8" gauge and all 22 colors sent, with illustrated literature, on request. (Write Dept. AR-1)

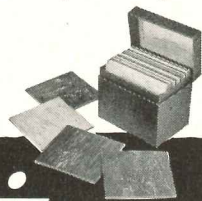

AMERICAN TILE & RUBBER COMPANY, TRENTON 2, N. J.

In Canada: American Tile & Rubber Co., Ltd., Sherbrooke, Quebec

HOOVER MEDAL AWARD

Dr. Frank B. Jewett, of Short Hills, N. J., former president of the National Academy of Sciences, was awarded the Hoover Medal for 1949, one of the highest honors of the engineering profession, it was announced by Scott Turner, chairman of the Board of Awards, only a short time before Dr. Jewett's death on November 18.

The medal is awarded by the American Society of Chemical Engineers, the American Society of Mechanical Engineers, the American Institute of Mining Engineers and the American Institute of Electrical Engineers.

TWO ARCHITECTS ON CODE COMMISSION

The newly-appointed New York State Building Code Commission, which held its first meeting December 6, in Buffalo, includes two architects among its five members: George Bain Cummings of Binghamton and William Lescaze of New York City. Other members are Edward J. McGrew, Jr., engineer, chairman; Walker S. Lee, of the Rochester Building Commission; and Ralph A. Lehr, lawyer.

The commission was appointed, in accordance with a legislative act passed last spring, to formulate a building code in terms of performance rather than explicit specifications, to encourage modern techniques and lower costs. Use of the code will be left to the discretion of the various municipalities

(Continued on page 24)

# ONE MATERIAL INSULATES A 200°F.-1200°F. TEMPERATURE RANGE

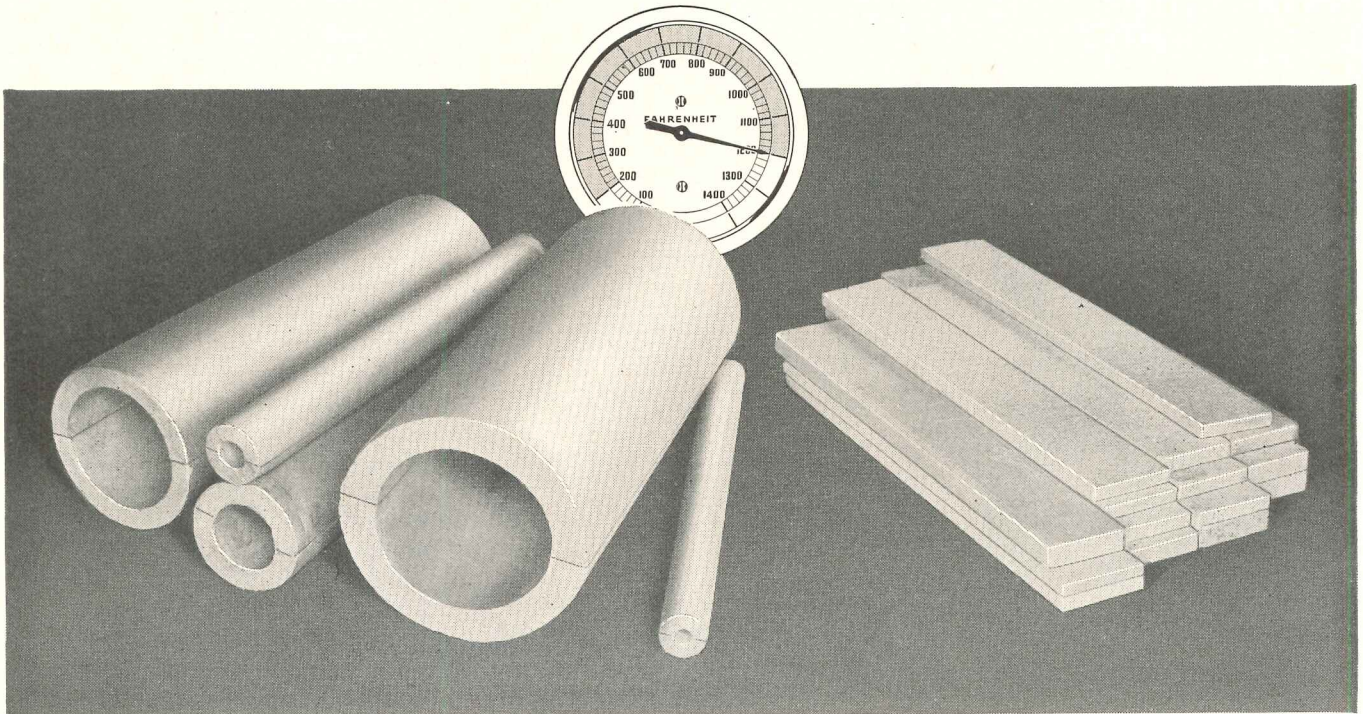

**KAYLO HEAT INSULATING BLOCK** can be easily sawed, cut and scored with standard tools. Cement, canvas or other outer finishes can be applied with minimum effort. Finished jobs have a neat, clean appearance.

**KAYLO PIPE INSULATION** is produced in Simplified Dimensional Standards of thicknesses and diameters for snug nesting, when necessary. Available in thicknesses from 1 to 3 inches in 36-in. sections for pipe sizes from ½ inch to 12 inches.

Every architect ever confronted with insulation problems should know about Kaylo Heat Insulating Block and Pipe Insulation. No other insulation provides such a combination of advantages.

Available in block or pipe covering form, this material is remarkably efficient throughout a wide 200°-1200°F. temperature range. It is strong and resistant to effects of moisture for long service. It is lightweight, easy to handle and apply.

Many types of industries have found this material ideal for their insulating needs. Get the facts now about Kaylo Heat Insulating Block and Kaylo Pipe Insulation.

# KAYLO®

## HEAT INSULATING BLOCK and PIPE COVERING

**OWENS-ILLINOIS GLASS COMPANY**  
Kaylo Division Toledo 1, Ohio

SALES OFFICES AT:

Atlanta  
Boston  
Buffalo

Chicago  
Cincinnati  
Dallas

Minneapolis  
New York  
Philadelphia

St. Louis  
Toledo  
Washington

**MAIL COUPON  
FOR KAYLO INSULATION  
SAMPLES AND LITERATURE**



**Owens-Illinois Glass Company**  
— Kaylo Division Dept. N-18, Toledo 1, Ohio

Gentlemen: Please send me Kaylo heat insulation samples and descriptive literature.

NAME.....

FIRM.....

ADDRESS.....

CITY..... STATE.....

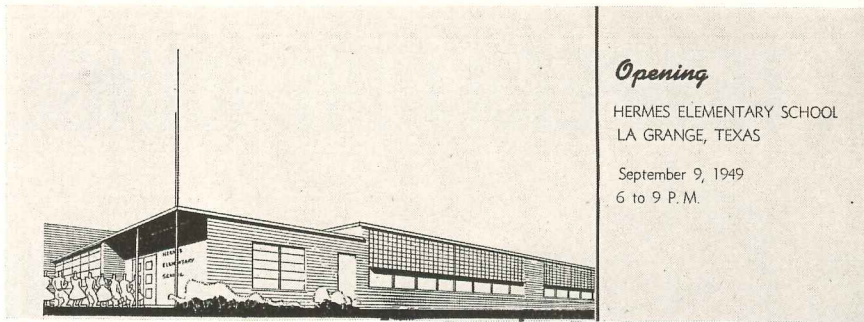

*Opening*

HERMES ELEMENTARY SCHOOL  
LA GRANGE, TEXAS

September 9, 1949  
6 to 9 P.M.

TAXPAYERS PREVIEW  
A MODERN SCHOOL

Architect-engineers Page, Southerland & Page of Austin, Texas, report an unusual plan used in the town of La Grange to introduce a new school building of modern design. When the Hermes Elementary School was completed recently, all the taxpayers of the community were invited to "come see" at an open house where parents and teachers played host.

About 60 miles from Austin, La Grange is the center of a farming community of some 10,000 people, including many of foreign extraction. Use of a modern design was the decision of the progressive young superintendent of schools, Charles O. Lemmons. It was believed that the public would support his decision if its advantages could be pointed out to them and the celebration was planned to encourage a large audience.

As a result, some 500 taxpayers came to see how their money had been spent — many of them driving in from miles around. It was felt that the occasion was a real success in encouraging neighborhood pride and enthusiasm for the school.

Members of the PTA had prepared all the refreshments, which they served in the school cafeteria. Teachers showed the visitors through the building, having been briefed beforehand on details of its construction. One of the architects reports the guide service was so effective that he himself was taken on a thorough tour by an unsuspecting teacher who capably answered all his questions.

Guests were given program leaflets illustrated with a rendering of the building (see above, left) and listing these outstanding features:

1. Visual education areas in classrooms marked by asphalt tile to show correct areas for seating.
2. Cafeteria doubling as assembly room by use of small speaker's stage.
3. Toilets for boys and girls for each two classrooms.
4. Harmon Natural Daylighting for even distribution of natural light.
5. Mechanical ventilation of classrooms in warm weather through heating duct and roof fans.
6. Allowance for future additions.

(Continued on page 136)



**THIS MAN IS  
PAID TO HELP  
ARCHITECTS AND  
THEIR ENGINEERS!**

He is a specialist in planning and engineering RCA Sound Systems for every type of building: Schools . . . Hospitals . . . Hotels . . . Factories and Offices . . . Churches . . . Department Stores . . . Airports and Terminals . . . Warehouses and Garages . . . Auditoriums . . . Recreational Centers . . . Institutions . . . Stadiums . . .

No matter what size or type of job you have on your drawing boards, you can get practical help from RCA in fitting RCA Sound Systems to your architectural plans. No obligation, of course.

Contact your nearest RCA Sound System distributor or write: Sound Products, Department 3A, Radio Corporation of America, Camden, New Jersey.



**SOUND PRODUCTS**  
**RADIO CORPORATION of AMERICA**  
ENGINEERING-PRODUCTS-DEPARTMENT-CAMDEN, N. J.

In Canada: RCA VICTOR Company Limited, Montreal

THE MASTERMIND OF THE  
NEW ERA FOR ELEVATORS



# Selectomatic

Selectomatic is an ingenious electrical intelligence with a nervous system that is alert to every floor in a building. It automatically registers all service calls . . . it instantly reacts to answer those calls . . . it continuously regulates the entire elevator bank and automatically matches elevator service to the varying traffic patterns.

Controlling a bank of elevators is no longer a fumbling hand proposition—an operation involving a “starter” who stands in the lobby of a building and makes frantic guesses at when to send which cars where.

This old method, known as signal control, was once adequate, but it hasn't a chance against quick-changing traffic demands in a modern multi-floor building. Solving today's elevator problems calls for a mastermind—and that calls for Westinghouse Selectomatic.

See how you and your tenants can enjoy the benefits in this new era of elevator control. Send for Book B-3597 for the complete story of Selectomatic—Science's Greatest Achievement in Elevator Transportation. Write Dept. D1, Elevator Division, Westinghouse Electric Corporation, Jersey City, N. J.

J-98555

YOU CAN BE SURE...IF IT'S

# Westinghouse

CONSTRUCTION COST INDEXES

Labor and Materials

United States average 1926-1929 = 100

Presented by Clyde Shute, manager, Statistical and Research Division, F. W. Dodge Corp., from data compiled by E. H. Boeckh & Assocs., Inc.

NEW YORK

ST. LOUIS

ATLANTA

SAN FRANCISCO

Period	Residential		Apts., Hotels Office Bldgs. Brick and Concr.	Commercial and Factory Bldgs. Brick Brick and Concr. Steel		Residential		Apts., Hotels Office Bldgs. Brick and Concr.	Commercial and Factory Bldgs. Brick and Steel	
	Brick	Frame		Concr.	Steel	Brick	Frame		Concr.	Steel
1925	121.5	122.8	111.4	113.3	110.3	86.4	85.0	88.6	92.5	83.4
1930	127.0	126.7	124.1	128.0	123.6	82.1	80.9	84.5	86.1	83.6
1935	93.8	91.3	104.7	108.5	105.5	72.3	67.9	84.0	87.1	85.1
1939	123.5	122.4	130.7	133.4	130.1	86.3	83.1	95.1	97.4	94.7
1940	126.3	125.1	132.2	135.1	131.4	91.0	89.0	96.9	98.5	97.5
1941	134.5	135.1	135.1	137.2	134.5	97.5	96.1	99.9	101.4	100.8
1942	139.1	140.7	137.9	139.3	137.1	102.8	102.5	104.4	104.9	105.1
1943	142.5	144.5	140.2	141.7	139.0	109.2	109.8	108.5	108.1	108.7
1944	153.1	154.3	149.6	152.6	149.6	123.2	124.5	117.3	117.2	118.2
1945	160.5	161.7	156.3	158.0	155.4	132.1	133.9	123.2	122.8	123.3
1946	181.8	182.4	177.2	179.0	174.8	148.1	149.2	136.8	136.4	135.1
1947	219.3	222.0	207.6	207.5	203.8	180.4	184.0	158.1	157.1	158.0
Aug. 1949	237.3	233.8	240.5	244.0	237.2	182.6	182.2	177.3	177.9	174.1
Sept. 1949	239.2	236.3	240.6	244.0	237.5	183.7	183.7	178.4	178.4	174.8
Oct. 1949	242.7	239.4	241.0	244.2	237.6	184.3	184.7	177.9	177.6	174.7
<b>Oct. 1949</b>	<b>96.5</b>	<b>95.6</b>	<b>84.4</b>	<b>83.1</b>	<b>82.6</b>	<b>113.6</b>	<b>122.3</b>	<b>87.1</b>	<b>82.3</b>	<b>84.5</b>
	% increase over 1939					% increase over 1939				
1925	118.6	118.4	116.3	118.1	114.4	91.0	86.5	99.5	102.1	98.0
1930	108.9	108.3	112.4	115.3	111.3	90.8	86.8	100.4	104.9	100.4
1935	95.1	90.1	104.1	108.3	105.4	89.5	84.5	96.4	103.7	99.7
1939	110.2	107.0	118.7	119.8	119.0	105.6	99.3	117.4	121.9	116.5
1940	112.6	110.1	119.3	120.3	119.4	106.4	101.2	116.3	120.1	115.5
1941	118.8	118.0	121.2	121.7	122.2	116.3	112.9	120.5	123.4	124.3
1942	124.5	123.3	126.9	128.6	126.9	123.6	120.1	127.5	129.3	130.8
1943	128.2	126.4	131.2	133.3	130.3	131.3	127.7	133.2	136.6	136.3
1944	138.4	138.4	135.7	136.7	136.6	139.4	137.1	139.4	142.0	142.4
1945	152.8	152.3	146.2	148.5	145.6	146.2	144.3	144.5	146.8	147.9
1946	167.1	167.4	159.1	161.1	158.1	159.7	157.5	157.9	159.3	160.0
1947	202.4	203.8	183.9	184.2	184.0	193.1	191.6	183.7	186.8	186.9
Aug. 1949	215.9	214.5	210.3	212.3	211.2	207.1	199.5	212.0	219.3	214.8
Sept. 1949	218.2	216.2	212.9	216.2	214.4	208.4	200.8	213.6	218.9	214.4
Oct. 1949	218.9	217.1	213.1	216.2	214.5	212.2	205.8	214.9	219.8	215.0
<b>Oct. 1949</b>	<b>98.6</b>	<b>102.9</b>	<b>79.5</b>	<b>80.5</b>	<b>80.3</b>	<b>100.9</b>	<b>107.3</b>	<b>83.3</b>	<b>80.3</b>	<b>84.5</b>
	% increase over 1939					% increase over 1939				

The index numbers shown are for combined material and labor costs. The indexes for each separate type of construction relate to the United States average for 1926-29 for that particular type — considered 100.

Cost comparisons, as percentage differences for any particular type of construction, are possible between localities, or periods of time within the same city, by dividing the difference between the two index numbers by one of them; i.e.:

index for city A = 110  
 index for city B = 95  
 (both indexes must be for the same type of construction).  
 Then: costs in A are approximately 16 per cent higher than in B.

$$\frac{110-95}{95} = 0.158$$

Conversely: costs in B are approximately 14 per cent lower than in A.

$$\frac{110-95}{110} = 0.136$$

Cost comparisons cannot be made between different types of construction because the index numbers for each type relate to a different U. S. average for 1926-29.

Material prices and wage rates used in the current indexes make no allowance for payments in excess of published list prices, thus indexes reflect minimum costs and not necessarily actual costs.

These index numbers will appear whenever changes are significant.





# Of 10,400 School Superintendents 78.4% Would Specify Individual Room Temperature Control!

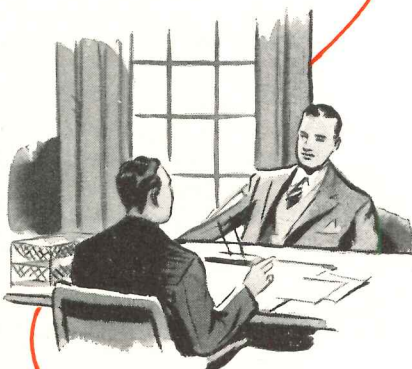
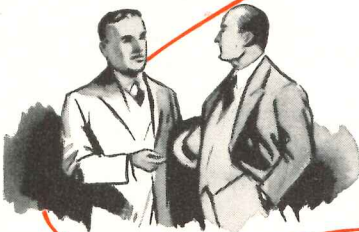
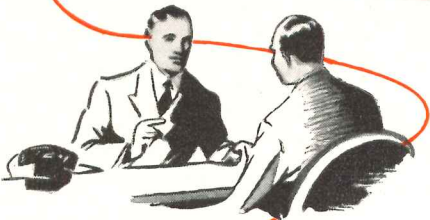

"THE Ideal School — How Would You Build It?" That's the question *School Management Magazine* asked more than 10,000 school superintendents across the nation. And more than three of every four responses specified individual room temperature control. When asked which features would be eliminated for reasons of economy, individual room temperature control was the last to be mentioned!

Yet these facts are not surprising, for educators have long recognized their responsibility in molding the health habits of our country. And here is evidence that school authorities are fully aware of the need for controlled atmosphere — healthful temperatures, correct humidity and adequate ventilation. When you specify individual room temperature control for schools, educators will be quick to recognize the benefits.

If you would like to see the complete *School Management* survey, Minneapolis-Honeywell, 60-year leader in automatic control, will arrange for the publisher to send you a copy. Minneapolis-Honeywell, Minneapolis 8, Minnesota. In Canada: Leaside, Toronto 17, Ontario.

MINNEAPOLIS  
**Honeywell**  
CONTROL SYSTEMS

*"Guarding America's Health with Controlled Atmosphere"*

REQUIRED READING

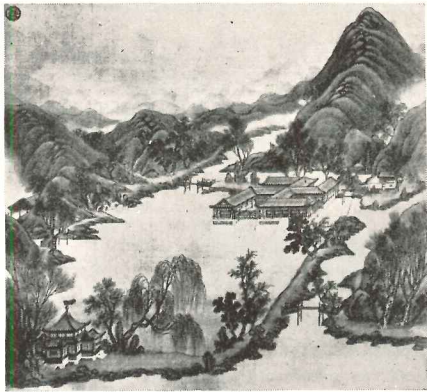

Manchu palace in a setting of lakes and islets. Painting in the Bibliotheque Nationale, Paris, reproduced in "Gardens of China"

WORK OF ART

*Gardens of China.* By Oswald Siren. The Ronald Press Co. (15 E. 26th St., New York 10, N. Y.), 1949. 9¼ by 12 in. 141 pp. of text + 208 pp. of plates. \$30.00.

The ancient gardens of China illustrated in this sumptuous volume should interest the modern reader on many levels of appreciation. Even a glance will reveal their timeless beauty. But with our own contemporary landscape design in a period of changing concepts, it is also most timely to examine the theories which have produced such obvious and satisfying beauties for another culture.

The essence of these gardens, the author believes, lies in a peculiarly intimate kinship with nature. Thus the aim has always been to create a blending of natural and man-made elements rather than to effect a rational organization of pattern. Stemming from an imaginative appeal, the Chinese garden can truly be described as "a work of art in the forms of nature."

In two major sections, this book considers the creative elements which have made such works of art, first from a theoretical viewpoint and then as portrayed in examples from existing gardens. The author has drawn a wealth of material both from his own travels and from Chinese texts, and the entire volume has a richness suggesting the

vast extent and varied culture of the land itself.

Viewing the forms of nature in the widest terms, the elements from which the Chinese created their gardens extend far beyond the flowers and trees which have dominated western gardens. Perhaps the most unique and specifically Chinese features are the so-called "mountains," or fantastic garden stones, which fulfill somewhat the same function as statues in an occidental garden, while at the same time merging more naturally with their surroundings. The frequent appearance of ponds and canals emphasizes a use of water for its evocation of mood and motion.

Since the Chinese made no sharp distinction between indoors and out-of-doors, gardens were seen as natural extensions of their dwellings and architectural elements are another essential in the composition. In the fusion of picturesque elements which was so highly prized, a free use of pavilions, walls and galleries served to accent, contain and link the individual units.

This philosophy takes on a concrete meaning in the second major portion of the book. After discussing the significance of Chinese gardens in literature and in their adaptation by Japan, there are detailed descriptions of some of the palace and private gardens of China. To western eyes the relative importance of town gardens is perhaps surprising. And yet, as a Chinese treatise asks, "If one can find stillness in the midst of the city turmoil, why should one then forego such an easily accessible spot and seek a more distant one?"

In format this book beautifully supports the beauty with which it deals. Color reproductions from eleven Chinese woodcuts remind one of the close relationship between Chinese art and gardens. Photographs, plans and drawings are included throughout the book and there is a magnificent selection of plates with which to close.

Like the Chinese garden itself, this is a book to revisit many times. Whether one dwells at length on the informative text or merely browses through the many delights, it should prove equally rewarding.

HISTORIC HOUSES IN COLOR

*A Treasury of Early American Homes.* By Richard Pratt. Whittlesey House (330 W. 42nd Street, N. Y. 18, N. Y.), 1949. 13½ by 10½ in. 136 pp. illus. \$12.50.

Since adults are seldom vouchsafed a book in full color, the brilliant koda-chrome photography — not just in one special section but on virtually every page — is the most newsworthy feature of this fine collection of Early American houses. Fortunately the author's text and editing are worthy of his illustrations.

A commission from the Curtis Publishing Company for a series of magazine articles made it possible for Mr. Pratt to undertake the job of locating, selecting, and photographing the houses which best represent American building tradition before 1850. Some are familiar buildings now open to the public as museums, and others are private homes photographed by permission of sympathetic occupants. George Washington and other notables really slept in some, and John Doe and Richard Rowe in others, but each is included because it represents one particular way Americans have lived.

From Woodstock to Natchez and even Monterey, we are shown houses built with gracious details copied from European builders' handbooks, but planned by imaginative owners to suit their colonial needs, and to use their own materials: native Pennsylvania stone in Bucks County; oyster shell stucco in Charleston; ships' timbers on Cape Cod.

Their survival alone shows that these are good houses — well constructed and well cherished. Houses which copy them lack, as the author notes, "the impulse of the originals . . . along with yesterday's necessities." But the beauty of their details, and the rightness of their plans, provide standards of achievement and make them, to quote again from Mr. Pratt, "among the things to keep in mind while planning for the future." This spectacular presentation in color should bring them to the attention of a great many laymen as well as architects who are interested in such planning.

(Continued on page 30)

Whether Ventilation is by Central or Unit System...

**POWERS**

**GIVES EXTRA FEATURES**

*—where it is important!*

**UNIT VENTILATOR CONTROL—Requires Low Limit Thermostat with advantages listed below—**

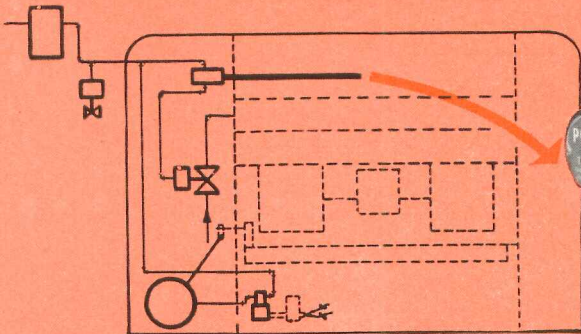

Unit Ventilators operate on low limit thermostat a large portion of the time.



**POWERS NO. 356  
AIRSTREAM THERMOSTAT**

- ★ Non Waste Type
- ★ Adjustable Sensitivity
- ★ More Gradual Acting
- ★ Easy to Change Temperature Setting  
Has Graduated Dial
- ★ No Restriction Valve to Set

**CENTRAL FAN SYSTEM CONTROL—Requires Proper Valves**

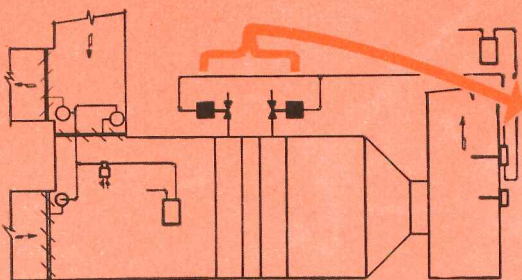

**When You Need Help** with your problems of temperature and humidity control take advantage of our 58 years of experience in this field. There's no obligation... Contact our nearest office.

CHICAGO 14, ILL., 2752 Greenview Ave. • NEW YORK 17, N. Y., 231 East 46th Street • LOS ANGELES 5, CAL., 1808 West Eighth Street • TORONTO, ONT., 195 Spadina Ave.

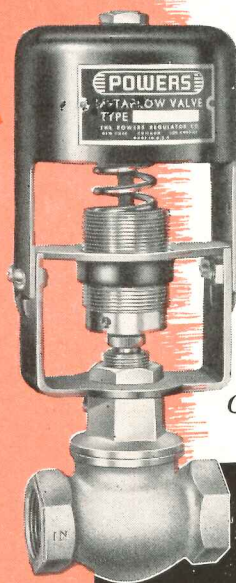

**POWERS  
METAFLOW VALVE**

- ★ Low Hysteresis
- ★ Large Power Factor—opposed by heavy spring for smoother operation
- ★ Exposed Adjustable Spring to Insure Proper Sequence Operation
- ★ Exposed Valve Stem Packing Adjustment
- ★ Valve Stem Lubricator Optional

*Only one of the many types of POWERS valves.*

**THE POWERS  
REGULATOR CO.**

OFFICES IN 50 CITIES • SEE YOUR PHONE BOOK

RC2

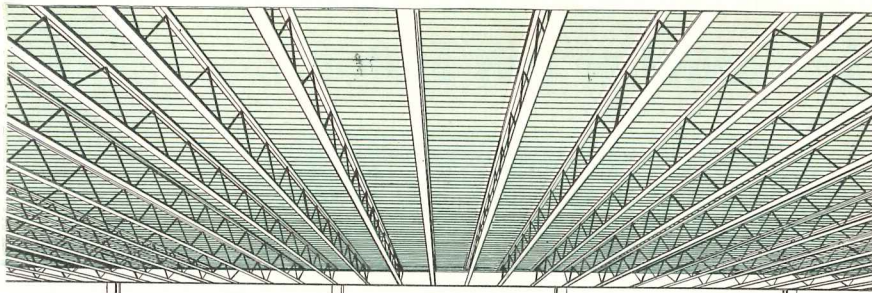

the concrete you save pays for...

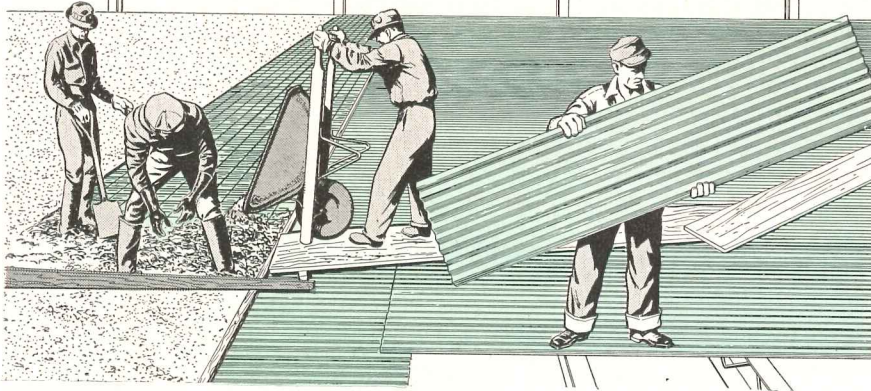

# Corruform

100,000 pounds per square inch.

Tough-tempered. High-strength.

Steel base for concrete in joist construction.

Corruform pays for itself with the concrete it saves. That's because Corruform is tough-tempered to spring back under construction abuse and carries concrete over joists without sag, stretch, bend or leakage. Tough-temper, high strength Corruform, made by processes patented by Granite City Steel Company, is nearly twice as strong as conventional steel of the same shape and weight.

Furnished uncoated, mill-primed for painted exposed

joist construction, or galvanized... with clips to fit all standard joists. Send for AIA file today.

Specify CORRUFORM by name

**Guarantee**

Standard tough-temper Corruform is made to one specified strength and thickness with guaranteed average strength over 100,000 p. s. i. and certified minimum strength for single test over 95,000 p. s. i.

**GRANITE CITY  
STEEL COMPANY**



Granite City Steel Co., Granite City, Ill.  
Please send me your Corruform booklet.

Name \_\_\_\_\_

Street \_\_\_\_\_

City \_\_\_\_\_ Zone \_\_\_\_\_ State \_\_\_\_\_

## THE RECORD REPORTS

### BOOKS

(Continued from page 28)

#### BETTER NATURAL LIGHT

*Building for Daylight.* By Richard Shepard, F.R.I.B.A., and Hilton Wright, A.R.I.B.A. Macmillan Co. (60 Fifth Avenue, New York 11, N. Y.), 1949. 8½ by 10⅞ in. 91 pp. illus. \$5.50.

Getting natural light into buildings erected for shelter and safety is an age-old problem of architectural design. To its contemporary solution this British book contributes methods for calculating available daylight, studies of orientation and window design for various types of buildings and sites, and a discussion of the uses of various forms of glass. The authors' findings should prove useful in projects where maximum daylight is desired, but little mention is made of the supplementary importance of artificial lighting.

An introductory historical note by John Gloag traces the development of windows in Britain, from Roman times down to the present.

Wash drawings of typical period window treatments illustrate the historical section, and the contemporary section contains useful diagrams for the orientation and grouping of buildings.

#### SHADOWPLAY

*Profile Art.* By R. L. Megroz. Philosophical Library (15 E. 40th St., New York 16, N. Y.), 1949. 7¼ by 9½ in. 131 pp., illus. \$7.50.

Ever since the earliest known works of prehistoric art, the silhouette has appealed to the creative artist and craftsman. With this volume the general reader can survey some manifestations of the method, from cave art through the art of Egypt and Greece down to present times.

Although the emphasis is primarily on the past, a section illustrating decorative uses of the silhouette in such diverse forms as marquetry, tiles, wrought iron and textiles has direct contemporary interest. As fillip there are side excursions into such fields as phrenology and comic art. With perhaps a certain British detachment, there is a bare mention of American cartoons and films, but the subject matter chosen is nicely illustrated and varied in scope.

# NO PROJECT TOO LARGE —

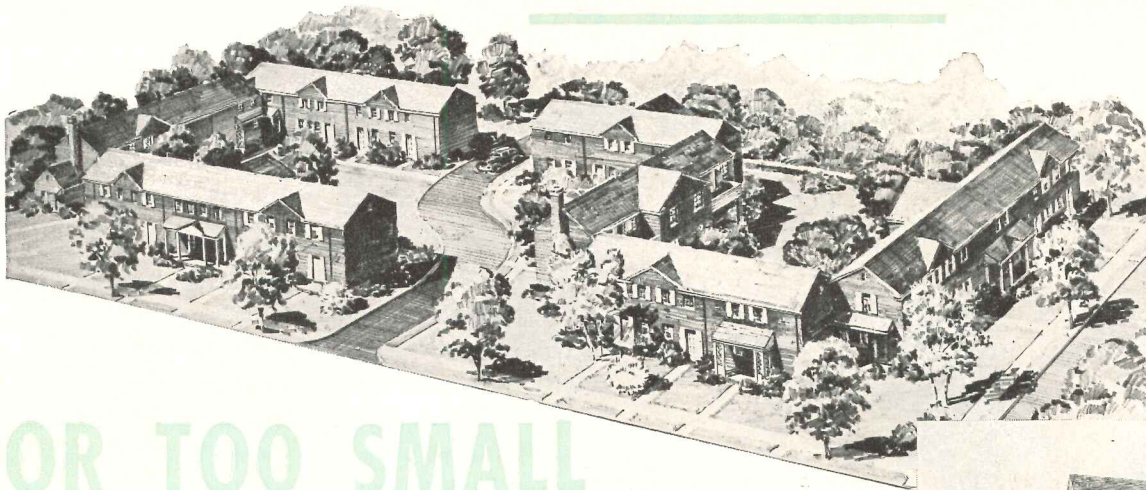

APARTMENTS

# OR TOO SMALL FOR SARCOTHERM

Because large conventional hot water projects and deluxe radiant heating jobs have given Sarcotherm more than ordinary publicity lately, is no reason to overlook stores, offices, factories and individual homes.

For Sarcotherm is the delight of any heating man who is in competition, either as to the over-all price of the heating job or the luxurious comfort and convenience that various hook-ups with Sarcotherm can provide.

## *Control by the Weather*

Sarcotherm is a simple mixing valve, actuated by two liquid filled thermostats, inside and outside the building. Warm return water is mixed with hot boiler water, and delivered at the temperature needed at that particular hour. It is all mechanical—no electricity, or compressed air. No mysteries to explain to the owner.

And Sarcotherm is extremely flexible. Multiple zone control, split systems, automatic set-backs and double switch lines can be incorporated with ease.

THE NEW SARCOTHERM CATALOG and TECHNICAL BULLETINS ARE AVAILABLE FOR YOUR FILES

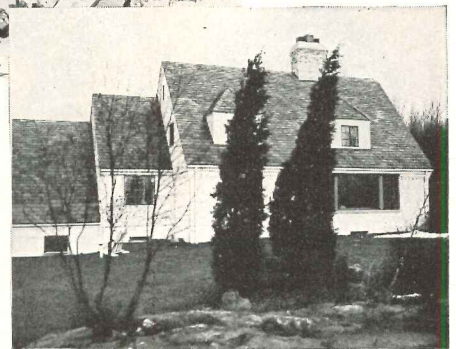

HOMES

FACTORIES

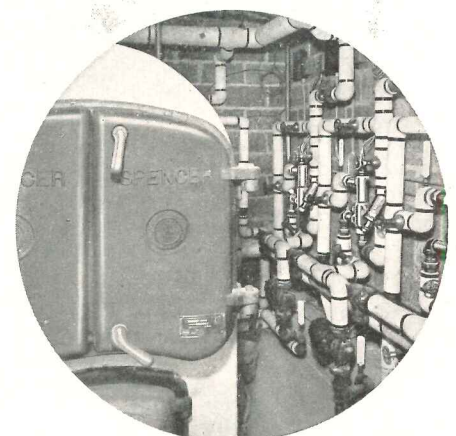

Three Sarcotherms on zone control in motel.

# Sarcotherm

SARCOTHERM CONTROLS, INC. • Empire State Bldg. • NEW YORK 1, N. Y.

“We’ve found **Carrara Glass** a versatile medium  
— adaptable to almost any design”

THAT’S one of the reasons why so many of the country’s leading architects specify this quality structural glass. For Carrara Glass offers infinite possibilities for original effects. It has distinctive beauty. It’s a finely-machined product—flawless and with a closely-knit structure. There’s no lippage, so joints are true and even. It cannot warp. It’s easily handled. Carrara Glass can be decorated by sand-blasting, fluting, shading, or painting for ornamental purposes. It comes in ten attractive colors, affording innumerable color combinations. It is impervious to weather, moisture, chemicals, acids, water, grease, and pencil marks. It will not check, craze, fade or stain. Another example of Pittsburgh research, and the infinite pains taken to assure you of products which will not only look well but also perform well under field conditions, Carrara Glass is indeed an invaluable aid to the creative designer.

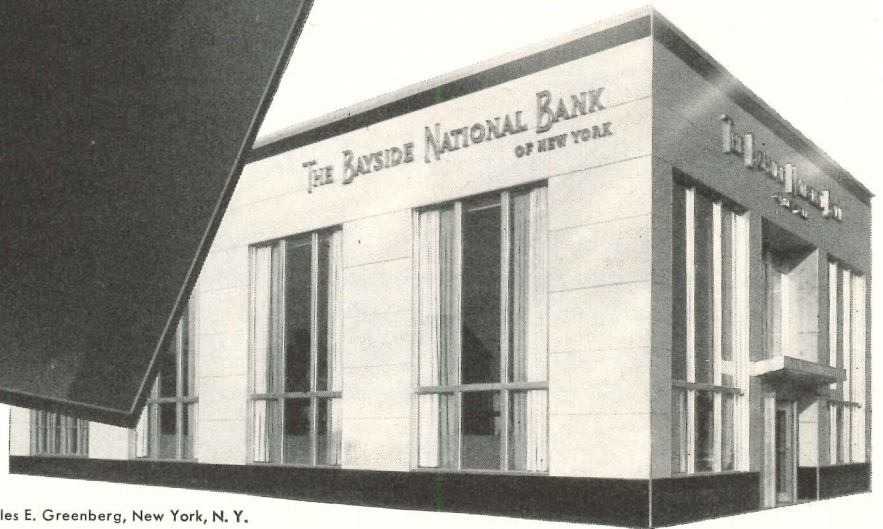

Architect: Charles E. Greenberg, New York, N. Y.

**Carrara** *the quality structural glass*



PAINTS • GLASS • CHEMICALS • BRUSHES • PLASTICS

**PITTSBURGH PLATE GLASS COMPANY**



**This floor is Armstrong's Linoleum.** It combines beauty, long service, and easy maintenance at moderate cost. New developments have made colors brighter, increased wearing qualities, and have made Armstrong's Linoleum a better value than ever. Six types—Plain, Jaspé, Marbelle®, Spatter, Embossed Inlaid, and Straight Line Inlaid. Wide choice of colors and patterns gives great freedom for custom designing. Produced in rolls six feet wide and up to ninety feet long, this floor can be installed with a minimum of seams. Three gauges: Heavy (1/8"), Standard (3/32"), Light (5/64"). Furniture loads up to 75 lbs. per sq. in. will not permanently indent this floor. Can be specified for both conventional and radiant heated suspended subfloors that are in good condition.

*They're both  
Armstrong's Floors*



**This floor is Armstrong's Asphalt Tile.** Recommended particularly for concrete floors in direct contact with the ground, Armstrong's Asphalt Tile also fills the need for an attractive floor at low cost. Its tough composition is not affected by alkaline moisture, gives good service even under heavy traffic. Performs satisfactorily over radiant heated concrete floor slabs. Wide choice of plain and marbled colors can be combined in countless variety of designs. Five types: Standard, Greaseproof, Industrial, Conductive, and Greaseproof Conductive. Available in 9" x 9" and 18" x 24" tiles, and in feature strips. Two gauges, 1/8" and 3/16". Either gauge can be installed over wood as well as concrete subfloors.

**For additional data** on Armstrong's Resilient Floors—Linoleum, Asphalt Tile, Arlon Tile, Lino-tile®, Rubber Tile, and Cork Tile—consult Sweet's Architectural File, section 13e, catalog 2. For samples and specifications, as well as help in solving unusual flooring problems, architects are invited to write to any Armstrong District Office or directly to the Armstrong Cork Company, Floor Division, 2401 State Street, Lancaster, Penna.



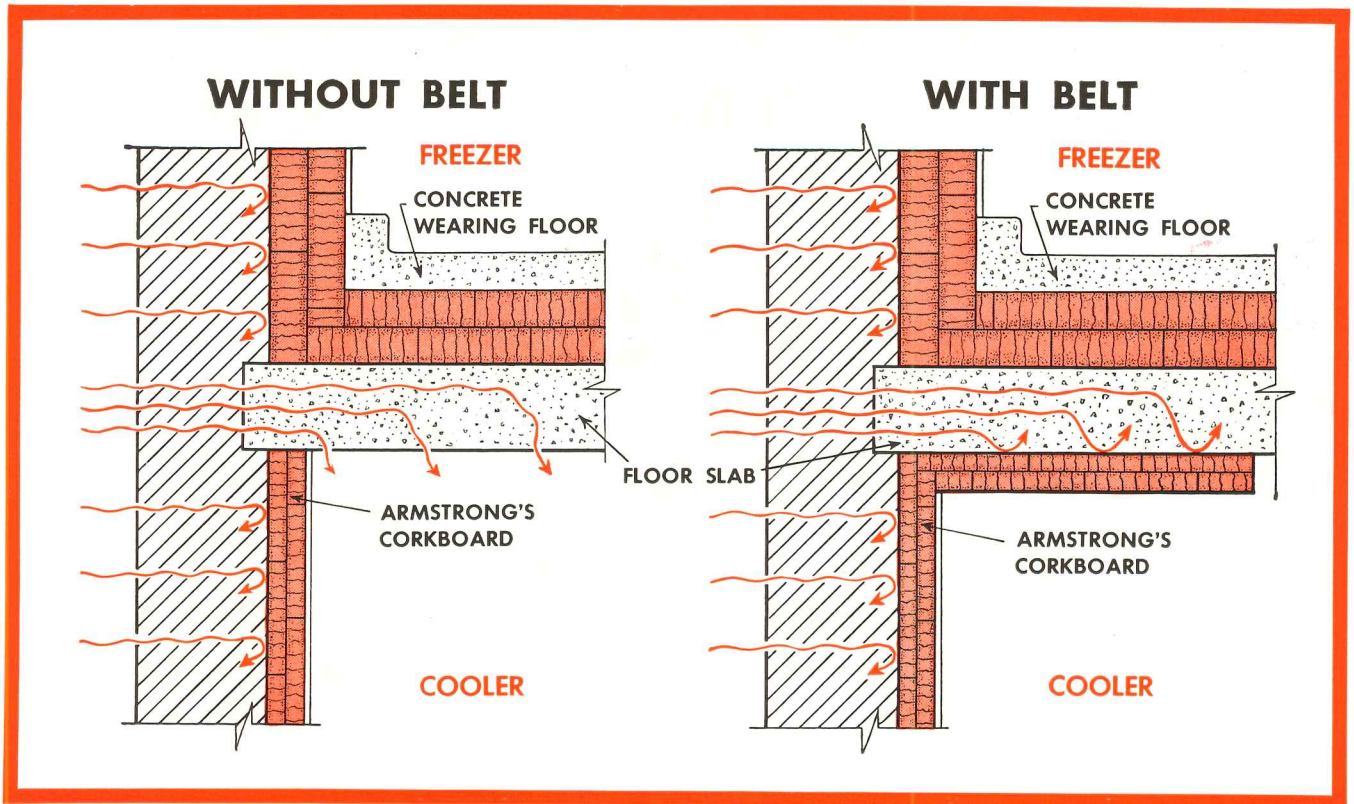

## How a belt of insulation prevents trouble

When the floor slab between refrigerated spaces is supported by the walls, heat travels along the slab into the room. This flow of heat not only increases refrigeration loads but also results in moisture condensation under the slab.

Extra insulation on the wall doesn't improve this situation. Even insulation on the floor between cold rooms won't eliminate it. But a belt of Armstrong's Corkboard on the underside of the slab, extending about three feet into the room, corrects it—and at low cost.

No such belt is required if the slab is supported by columns within the building and stands free of the outside walls. This permits an unbroken envelope of corkboard insulation to completely surround the entire refrigerated space.

The specification shown here, solving a common insulation problem in a practical and low-cost manner, is typical of the thinking of the men who plan Armstrong insulation jobs.

For more than 40 years these Armstrong engineers have been finding the right answers to all kinds of insulation problems. When you have any questions about low-temperature insulation, call on Armstrong's Contract Service. In addition to Armstrong's long experience and time-tested engineering practices, this complete service furnishes top-quality insulating materials and skilled mechanics to apply them. For complete information, write today to Armstrong Cork Company, Building Materials Division, 2401 Concord Street, Lancaster, Pennsylvania.

**ARMSTRONG'S INDUSTRIAL INSULATIONS**

MATERIALS



INSTALLATION

FOR ALL TEMPERATURES FROM 300° F. BELOW ZERO TO 2800° F.



# Get it on paper **FIRST!**

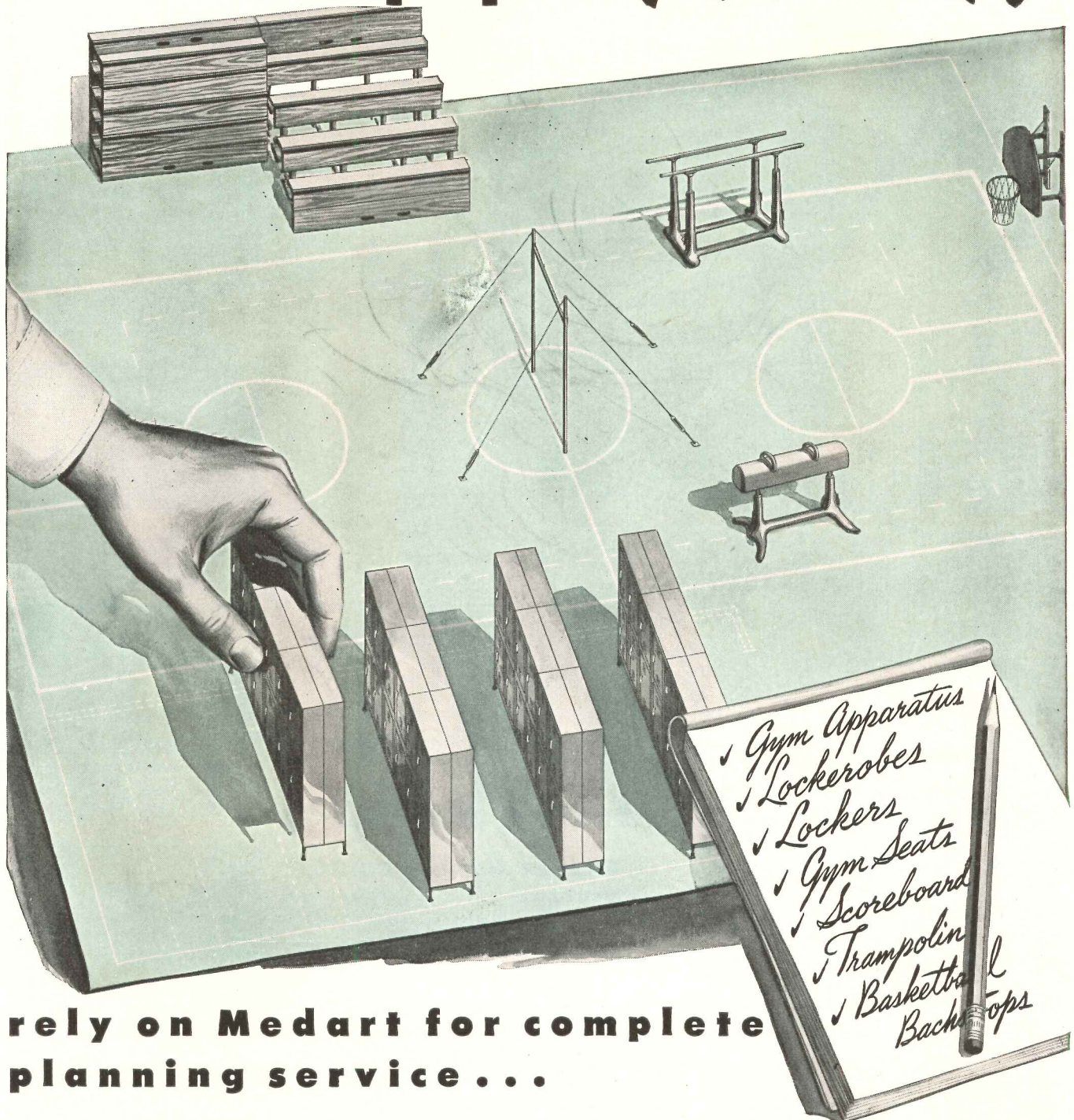

## rely on Medart for complete planning service . . .

Whatever type installation you are considering, consult Medart engineers first . . . for honest, unbiased analysis of your installation problems. The use of Medart planning and engineering facilities entails no cost or obligation on your part. Yet the savings . . . in actual installation costs . . . and in arriving at the proper kind of

installation based on your architectural requirements . . . are apt to be considerable! Yes . . . it costs no more . . . and results are sure, if you put it on paper, *first!* And remember! Over 75 years of serving the nation's schools has given Medart unquestioned leadership in the field of locker room, gym and physical educational equipment.

**FRED MEDART PRODUCTS, INC.**

3535 DEKALB STREET

• ST. LOUIS 18, MISSOURI

LEADERS FOR OVER 75 YEARS IN THE MANUFACTURE OF SCHOOL EQUIPMENT

# LOOK BEYOND BTUs

## when selecting Unit Heaters

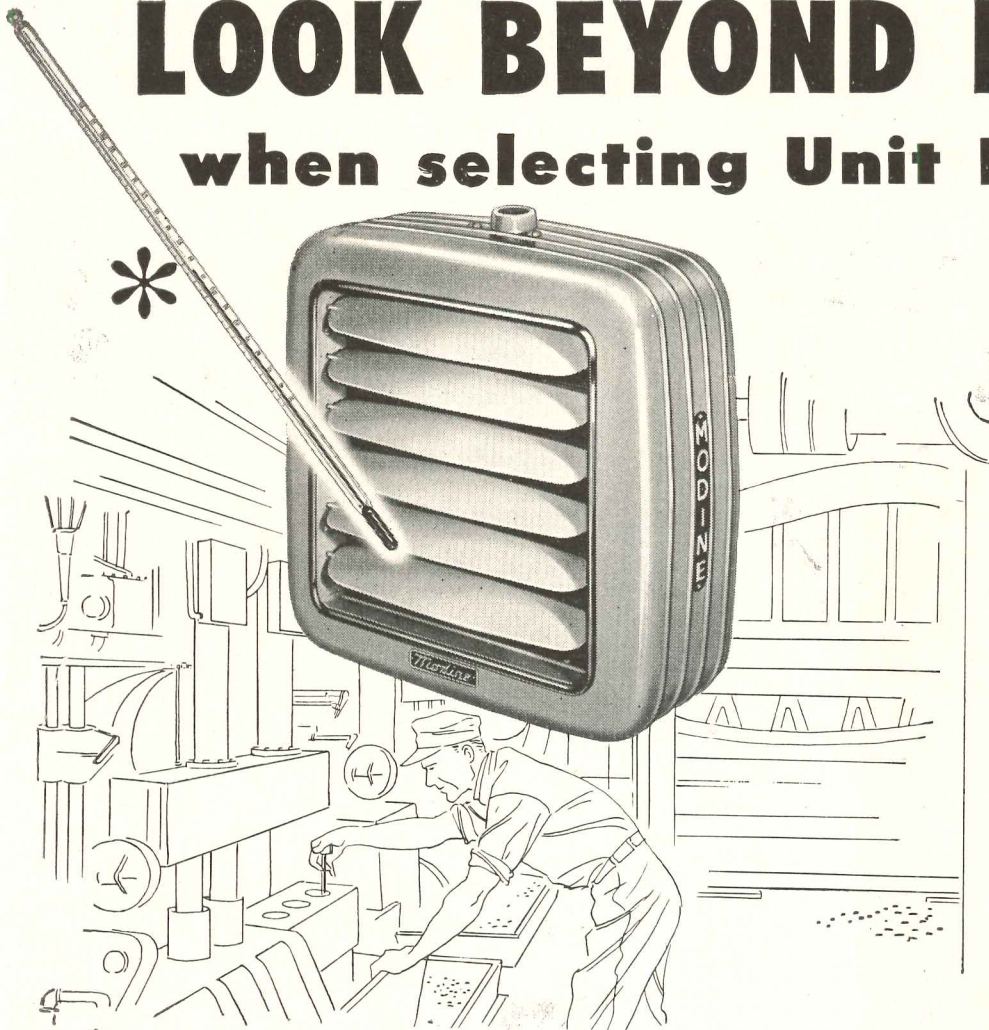

\* For maximum comfort and lowest operating cost, temperature of air leaving unit heater should be between 110°-120° F. at standard conditions.



Modine quieter operation is a result of scientifically sound-silencing air rush noises. Motor vibrations are effectively absorbed and dissipated by rubber mountings and resilient motor suspension.

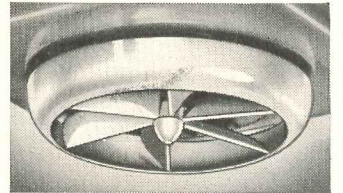

Control of heat distribution on vertical models is provided by a built-in adjustable radial deflector assembly, furnished at no extra cost. You can beam, flood or gently diffuse heat as required.

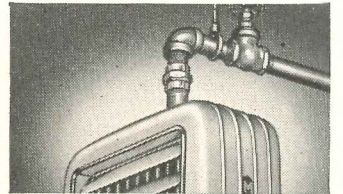

Direct-from-pipe suspension without other supports is safe and practical with Modine Horizontal models. This cuts installation costs and permits easy redirection of heat over a 360° range.

## Here's what you get with Modines!

### • LOWER OPERATING COSTS

Modine Unit Heaters deliver heat down into comfort zones where heat is needed instead of wasting it on ceilings or above the heads of room occupants. *This means lower fuel costs!* Only unit heaters with sufficient air velocity and correctly related outlet temperatures can give you this performance.

High quality split-phase or capacitor motors (instead of less expensive shaded-pole motors) are used on all but the smallest Modine Unit Heaters. *This means lower power and motor maintenance costs!*

### • UNIFORM HEATING COMFORT

Overheated outlet air is buoyant and rises quickly. Underheated air feels "chilly." Similarly, excessive air velocity causes drafts, while air delivered with insufficient velocity fails to reach the floor.

Because Modine outlet temperatures and velocities are *right*, and correctly related to each other, hot blasts and cold drafts are avoided. Floors are kept comfortably warm. Heating is uniform in all parts of the room even in coldest weather.

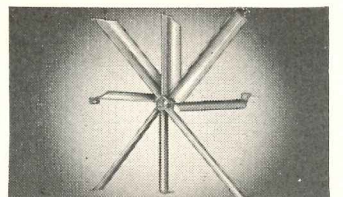

Built-in Velocity generator effectively increases heat throw without increasing power requirements. Outlet air retains a large share of its initial velocity to penetrate cold air strata near floor.



Get new Modine Unit Heater Bulletin today! Also available — "How To Evaluate Unit Heater Performance Characteristics." Your Modine Representative listed in Classified section of phone book. Or write Modine Mfg. Co., 1510 Dekoven Ave., Racine, Wis.

### WHY MODINES LAST LONGER



Entire condenser is pure copper and copper alloy . . . for maximum resistance to electrolysis and corrosion. Tubes are red brass; fins and headers, copper.



Differential expansion stresses are safely absorbed by bends in individual tubes and are not transmitted to tube-header joints to cause condenser fracture.



Fins are permanently bonded to tubes with metal. All condenser joints are brazed. There are no screwed or expanded joints to weaken condenser structure.



Parker-Bonderizing protects castings and sheet metal parts against formation and spread of rust. Anchors paint to steel. Prolongs original attractive finish.

# Modine UNIT HEATERS

U-103

# Rolling Steel DOORS

## *Manually, Mechanically, or Power Operated*

For openings in industrial and commercial buildings, the quick opening, quick closing, vertically acting rolling steel door embodies more desirable features than any other type of door. Open or closed, it occupies no useable space inside or outside the opening . . . its coiling action requires a minimum of headroom above the opening . . . its all steel construction assures permanence and a lifetime of trouble-free service—and, most important, it provides a maximum of protection against intrusion and fire. If you select Mahon Rolling Steel Doors, whether it be for a railroad opening, truck opening, or a firewall opening, you can count on the latest developments in doors of this type . . . more compact and more practical operating devices, curtain slats of Aluminum, Stainless Steel, or Galvanized Steel which has been scientifically cleaned, phosphated, and coated with high temperature oven baked rust inhibiting enamel prior to roll-forming. These, and many other desirable features that characterize Mahon Rolling Steel Doors, merit your consideration. See Sweet's Files for complete information, or write for Catalog No. G-49.

## THE R. C. MAHON COMPANY

Detroit 11, Michigan • Western Sales Division, Chicago 4, Illinois

Representatives in All Principal Cities

Manufacturers of Rolling Steel Doors, Grilles, and Automatic Closing Underwriters' Labeled Rolling Steel Doors and Fire Shutters; Insulated Steel Walls; Steel Deck for Roofs, Partitions, Acoustical Ceilings, and Permanent Concrete Floor Forms.

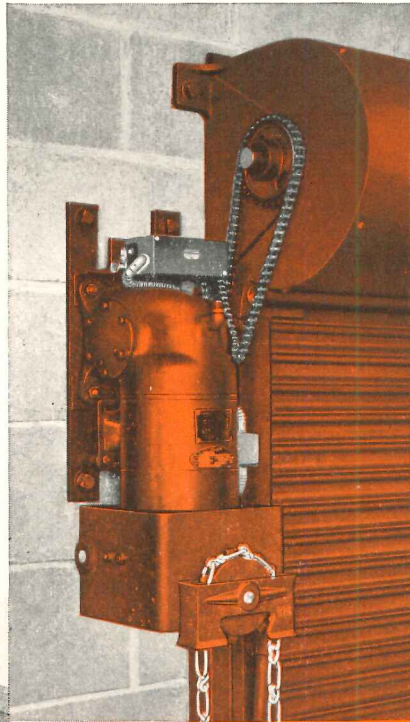

**MAHON STANDARD  
POWER OPERATOR 920-P**

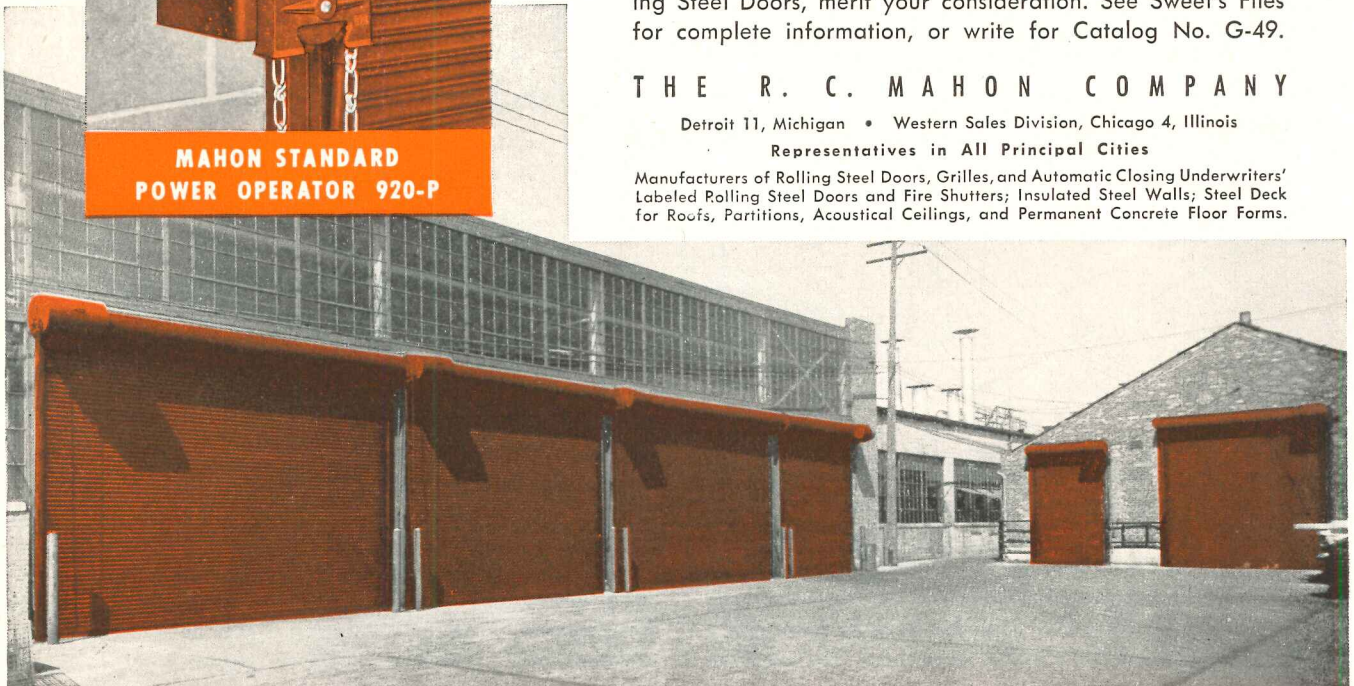

**ROLLING STEEL DOORS, SHUTTERS AND GRILLES TO MEET EVERY REQUIREMENT**

Mahon Power Operated Rolling Steel Doors installed in six openings in the American Metal Products Company's plant, Detroit, Michigan.

# MAHON

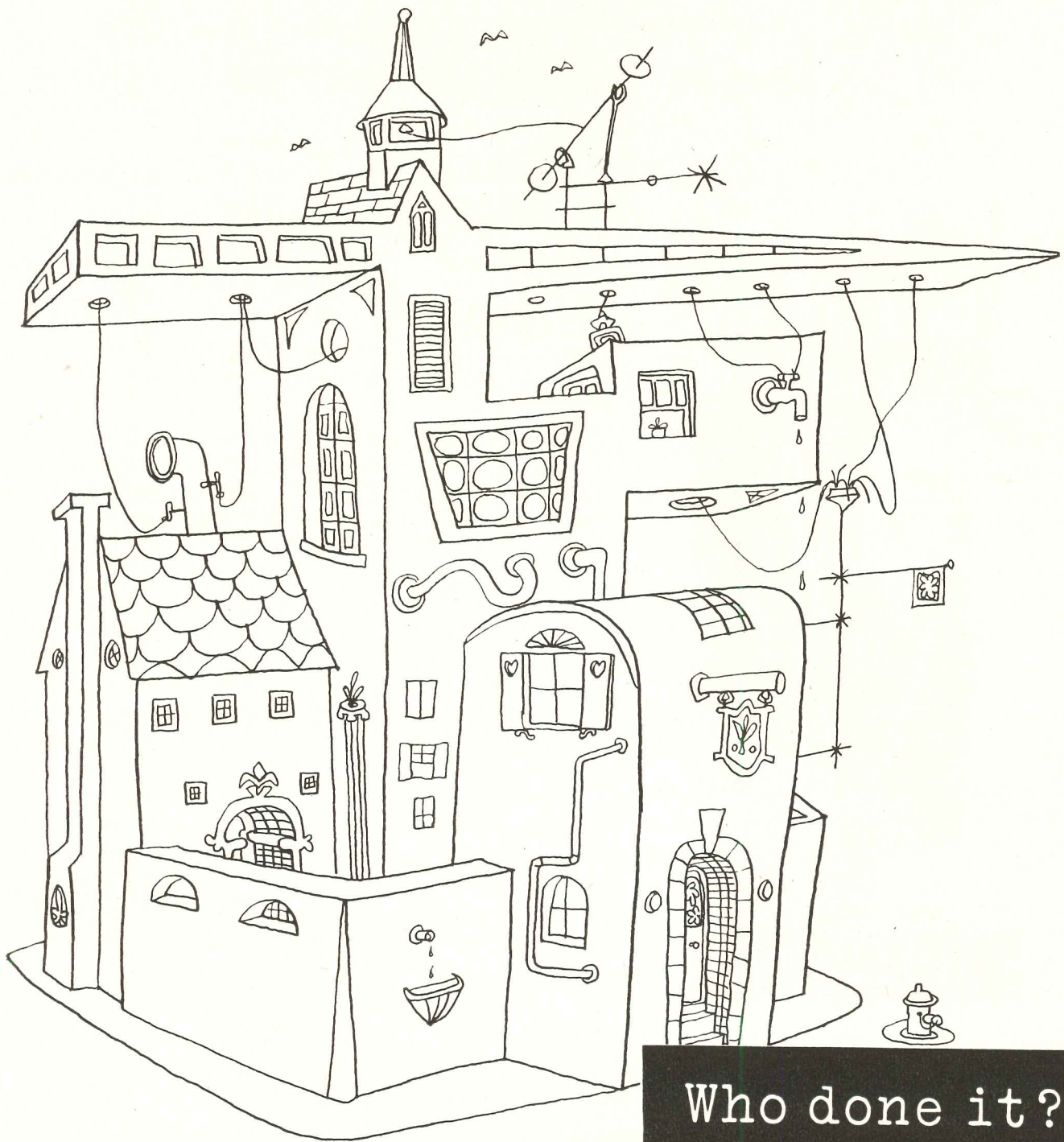

Who done it?

**No ONE MAN**, we'd bet. There's a look of "divided responsibility" about that job. And that's our point.

When you want a good air conditioning system, specify a Carrier installation throughout. It stands to reason that your client will get a better job. Carrier components are designed to go together. They're all built to exacting standards. There's no "weak link" in a Carrier installation.

That's why we say specify Carrier throughout. If you do, there's no chance of anybody saying, "Who done it?"

To satisfy customers, just remember that every significant advance in air conditioning in the last half century has come from Carrier. These are a few of the Carrier products available: Conduit and Duct-type Weathermaster systems for the multi-room building; Evaporative Condensers; Central Air Conditioners; Dehumidifiers; Self-contained Air Conditioners; Reciprocating, Centrifugal and Absorption Refrigeration Machines; Cold Diffusers and Heat Diffusers. Carrier Corporation, Syracuse, New York.



**AIR CONDITIONING • REFRIGERATION • INDUSTRIAL HEATING**

# Sanymetal<sup>®</sup> "PORCENA"

*\*Trade Mark Reg. U.S. Pat. Off.* (Porcelain on Steel)

## TOILET COMPARTMENTS

### Why the Bare Functional Type of Toilet Room Is No Longer Suitable

The ascendancy of good taste combined with new concepts of sanitation and convenience in toilet room environments makes the bare functional type of toilet room inadequate according to today's standards.

Toilet compartments usually dominate a toilet room, influence the toilet room environment and help to fulfill modern concepts of sanitation and convenience.

Sanymetal "PORCENA" Toilet Compartments are fabricated of ageless and fadeless material, porcelain on steel, which is a glass-hard, stainless material that always looks new, does not absorb odors, is moisture- and rust-proof, and resists the corroding of ordinary acids. The glistening "PORCENA" finish, which can be wiped clean as easily as a porcelain table top, requires no painting or refinishing.

Sanymetal "PORCENA" Toilet Compartments combine the results of over 35 years of specialized skill and experience in making over 100,000 toilet room installations. Ask the Sanymetal Representative in your vicinity (see "Partitions" in your phone book for local representative) for further information about planning suitable toilet room environments. Refer to Sanymetal Catalog  $\frac{21b}{6}$  in Sweet's Architectural File for 1949.

**THE SANYMETAL PRODUCTS CO., INC.**  
1689 URBANA ROAD • CLEVELAND 12, OHIO



Sanymetal "PORCENA" ACADEMY Type Shower Stalls and Dressing Room Compartments provide the utmost in sanitation for tourist camps, gymnasiums, clubs, Y.M.C.A.'s, etc.

Write for Sanymetal Catalog 86 which illustrates modern toilet room environments suitable for all types of buildings. Several attractive designs in a wide range of colors available. This catalog is also contained in Sweet's  $\frac{21b}{6}$  Architectural File for 1949.



Sanymetal "PORCENA" ACADEMY Type Toilet Compartments are suitable for conservative but modern toilet room environments.

Sanymetal "PORCENA" NORMANDIE Type Toilet Compartments endow a toilet environment with dignity and good taste.

Sanymetal "PORCENA" CENTURY Type Ceiling Hung Toilet Compartments offer the utmost in sanitation and provide modern, distinctive toilet room environments for schools, institutions, terminals and other public buildings.

# Sanymetal<sup>®</sup> TOILET COMPARTMENTS, SHOWER STALLS AND DRESSING ROOMS

*\*Trade Mark Reg. U.S. Pat. Off.*



**New School Building in Wisconsin Has Open-Web Steel Joists**—This attractive three-story, buff-brick structure is a recent addition to St. Catherine's High School, Racine, Wisconsin. It contains 12 classrooms, 5 staff rooms, a soundproof band room, a cafeteria and a gymnasium. Bethlehem Open-Web Steel Joists were used throughout, in combination with concrete floor slab and plaster ceilings. This type of construction is economical and non-combustible. It reduces the need for fire-wall subdivisions, and provides floors which are shrink-proof, and immune to attack by vermin. Installation of pipes and wiring is simplified, as they can be run through the webs of the joists. See Sweet's for full information about Bethlehem Joists. *Architect:* Al J. Seitz, Racine. *Contractor:* Nelson & Co., Inc., Racine.



IT'S *New*  
 AND IT'S  
*Yours*  
 FOR THE ASKING

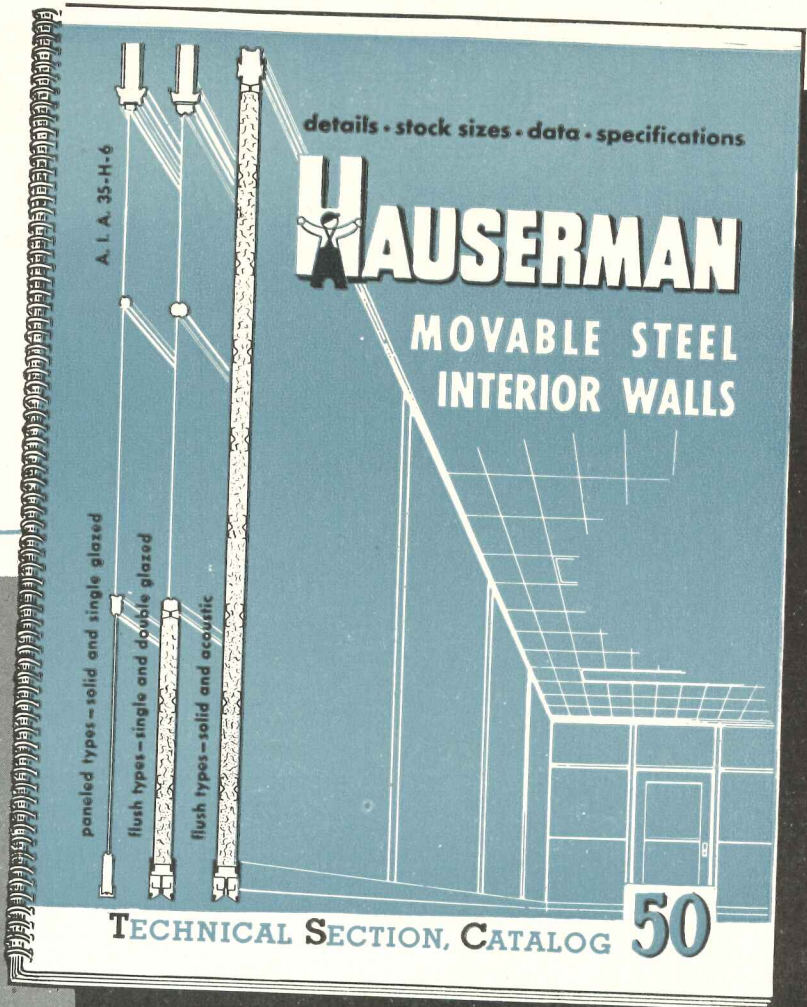

**Y**OUR copy of Hauserman Catalog 50 is now ready. It's a fully illustrated, 60 page catalog that thoroughly describes all the *proved* advantages of Hauserman *Movable Steel Interiors*. It also contains all the latest technical developments and specifications.

You'll find that this new catalog is a handy, easy-to-use reference. It shows and explains all the Hauserman types for commercial, industrial and institutional buildings.

Hauserman Catalog 50 and the services of trained Hauserman engineers are yours for the asking. Just call the Hauserman office or representative nearby, or contact *The E. F. Hauserman Company, 6775 Grant Ave., Cleveland 5, Ohio.*

Organized for  
 Service Nationally  
 Since 1913



Partitions • Wainscot  
 Railings • Acoustical Ceilings  
 Complete Accessories

# SERVEL'S Lower

# is a

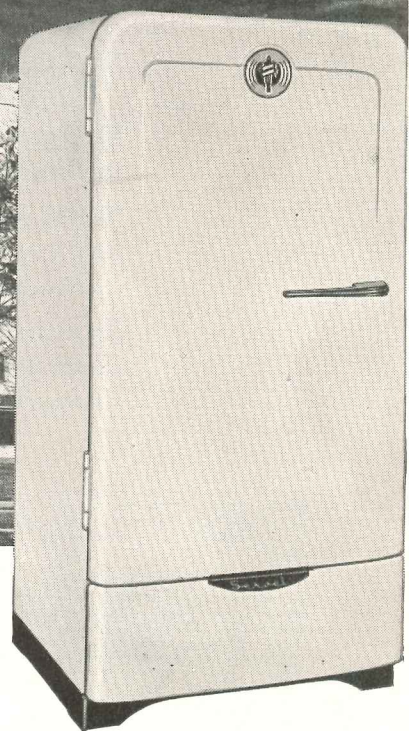
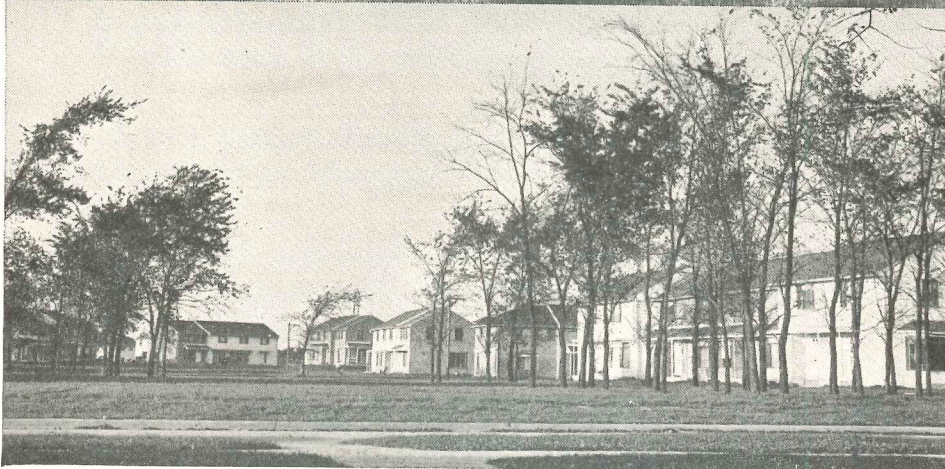

**3,010 GAS REFRIGERATORS** were chosen for Park Forest — Chicago's most modern community, now under construction by American Community Builders, Inc., Loebel, Schlossman & Bennett are the designers.



# Maintenance Cost

# Matter of Record\*

**Y**OU'RE not guessing when you choose Servel Gas Refrigerators. Experience with multiple installations has shown that Servel's upkeep cost is only a small fraction of the cost required to maintain other types of refrigerators . . . thanks to Servel's *basically different* principle of operation.

By having a tiny gas flame do all the work (instead of a motor), the Servel freezing system does away with all moving parts. Thus there's no machinery to grow noisy . . . to wear and need repairs. That's why *only Servel stays silent, lasts longer . . . gives you and your tenants dependable, worry-free service year after year with no loss in efficiency.*

Consult your Sweet's catalogue for full details, or write to Servel, Inc., Evansville 20, Indiana.

**Servel**  
The GAS Refrigerator

## \* Just Look At The Record

"After nine years our 398 Servels cost only 1¢ a month per unit for upkeep." MOBILE, ALA.

"In 12 years our Servels have cost us nothing for repairs." LOS ANGELES, CALIF.

"Our 750 Gas Refrigerators are 4 years old and cost less than 50¢ a year per unit to maintain." CORPUS CHRISTI, TEX.

"In the six years we have had our Servels, we've had no maintenance costs or service calls." CHICAGO, ILL.

*Nature made Asbestos... Keasbey & Mattison has made it serve mankind since 1873*

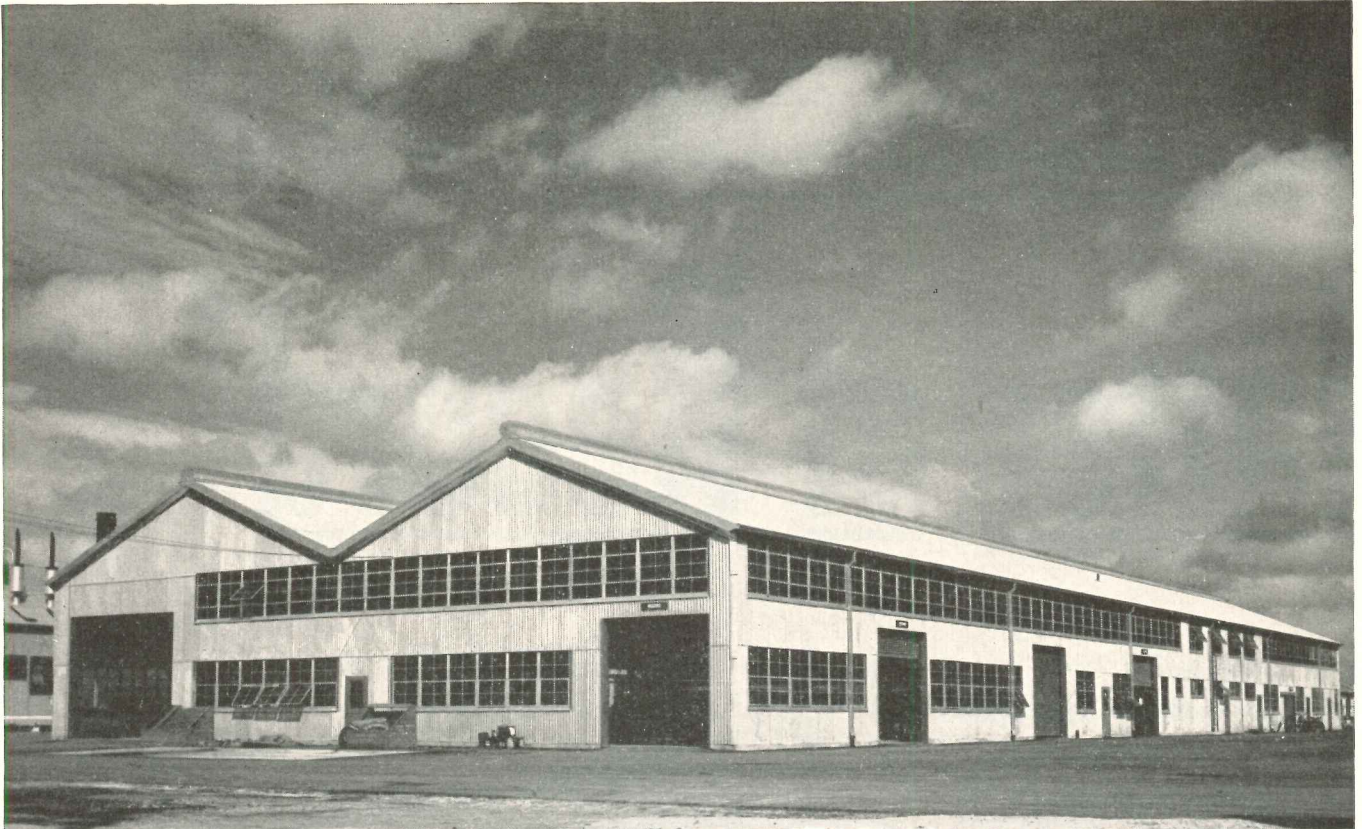

Owner: Celanese Corporation of America

Roofing and Siding Applicator: Arthur Brothers, General Contractors, Kingsville, Texas

# The weather can't do anything about **K&M "Century" ASBESTOS CORRUGATED** — on the job for Celanese

Looks like some Texas weather coming up. But it is sure to be licked—and will stay licked—by the roofing and siding on this Mechanical Shop Building of Celanese Corporation of America's Chemcel Plant at Bishop, Texas. This job won't invite fire loss either. It won't rot or rust; won't permit galvanic action and won't feed termites.

The favorable economics of K&M "Century" Asbestos Corrugated begins with its ample

structural strength. Ease of application, including ready workability and adaptability, makes for fast, shipshape erection. That multiplies savings.

Exterior and interior architectural effects which would be too costly otherwise, are now being carried out successfully by architects who capitalize on the structural, shelter and cost advantages of K&M "Century" Asbestos Corrugated.

*No scaffolds...no workmen beneath...when the roof is applied with "TOP-SIDE"\* Fasteners. Available only with K&M "Century" Asbestos Corrugated, they do a better job at lower cost. Details on request.  
\*© H. & B. Enterprise Corp.*

**KEASBEY & MATTISON**  
COMPANY • AMBLER • PENNSYLVANIA



FOR FLEXIBLE DIVISION OF FLOOR SPACE

IN OFFICES  
FACTORIES  
EVERY TYPE OF  
COMMERCIAL AND  
INSTITUTIONAL  
BUILDING

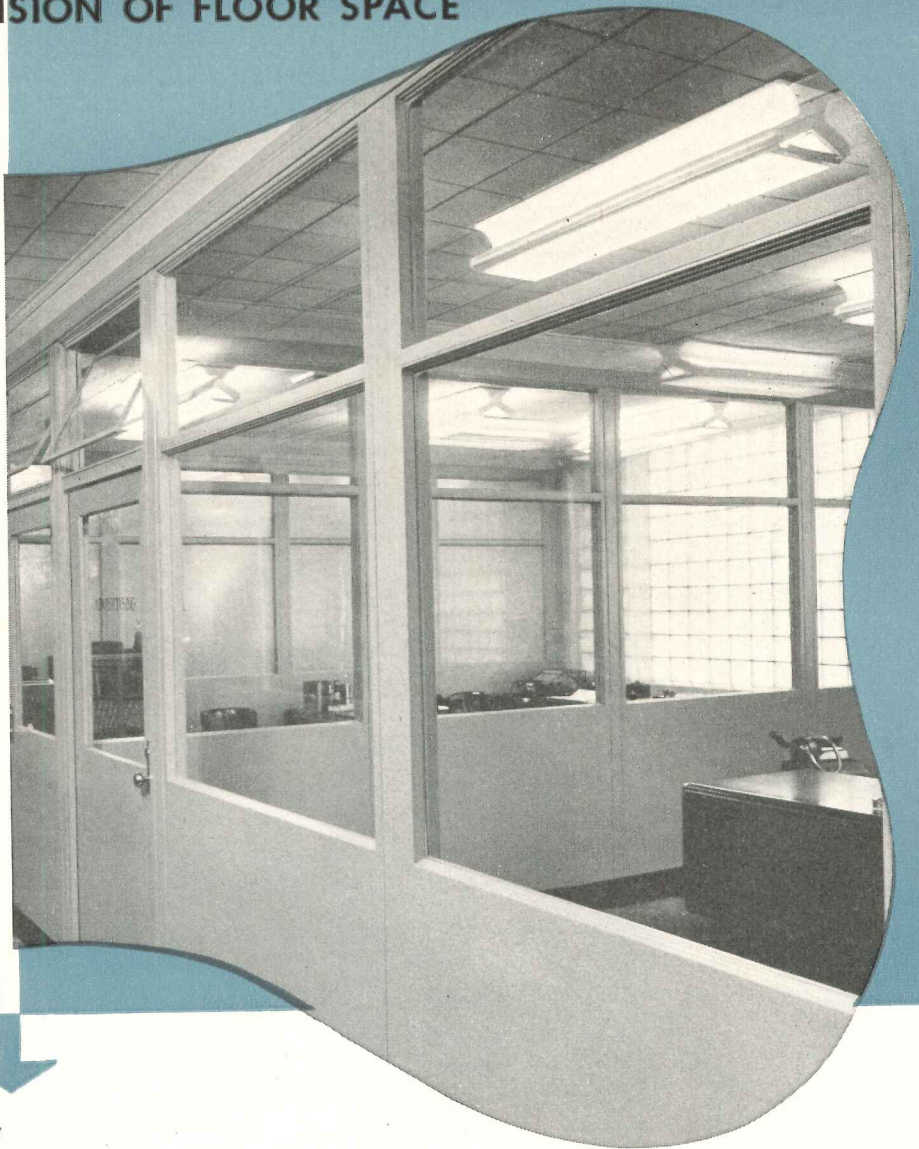

MILLS *Movable* METAL WALLS



FOR nearly thirty years The Mills Company has devoted itself exclusively to the design and manufacture of movable walls. The unexcelled quality of Mills Metal Walls in thousands of buildings of every type throughout America reflects the concentration of engineering, craftsmanship and production facilities upon this single purpose.

The new Mills Movable Metal Walls Catalog No. 50 represents, in printed form, the knowledge and experience gained during these thirty years of work in this field. It was designed as a practical, convenient "working tool" for architects and all who deal with the problems of flexible space divisions in commercial, industrial and institutional buildings.

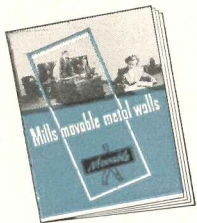

You'll find this new 48-page Mills Catalog bound into Sweet's File, Architectural, for 1950—or we'll be glad to send you an easy-to-handle copy for your individual use. Just ask for Catalog No. 50.

**THE MILLS COMPANY**  
961 WAYSIDE ROAD • CLEVELAND 10, OHIO

©The Mills Company

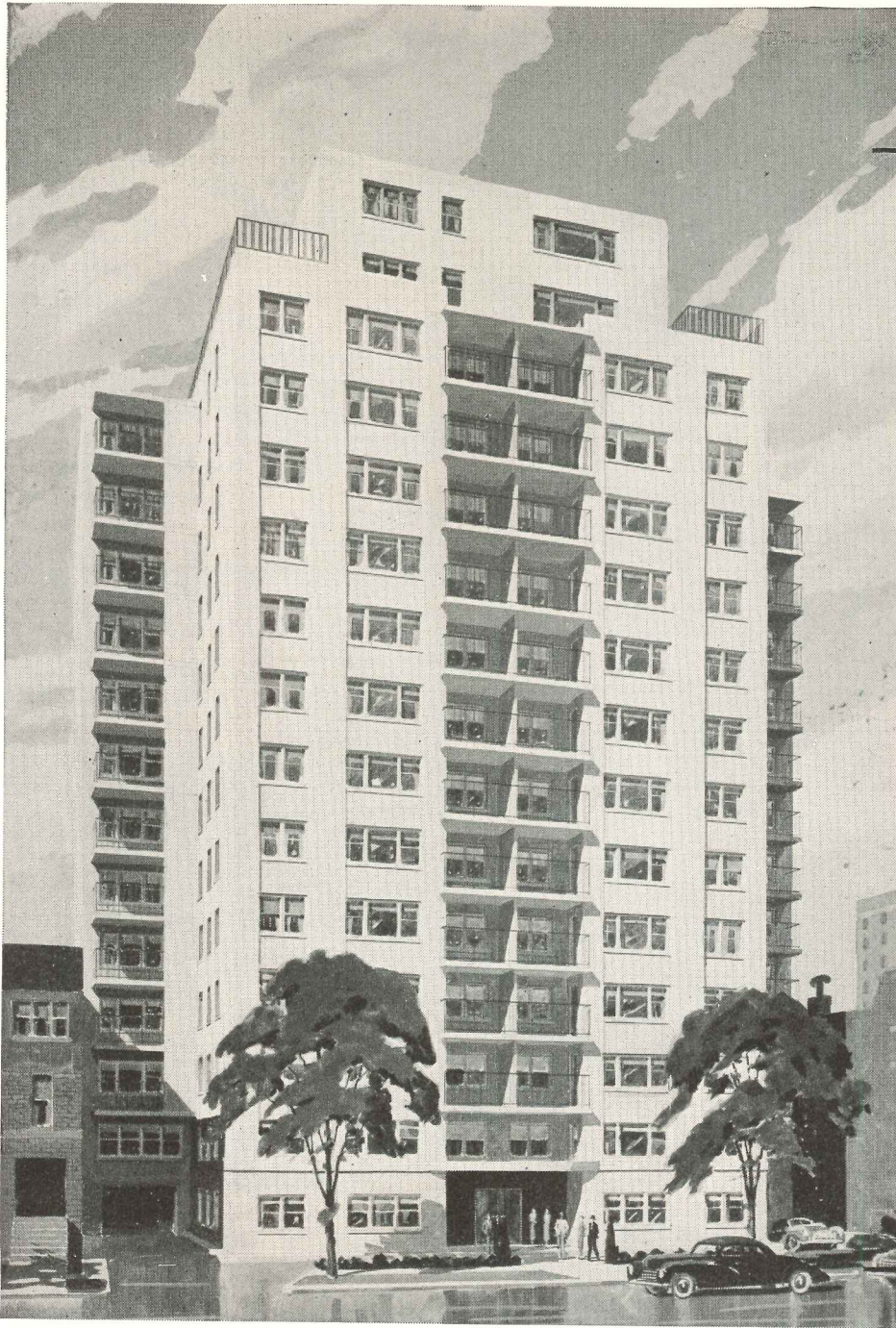

## 15-STORY APARTMENT BUILDING HEATED BY REVERE COPPER RADIANT HEATING COILS EMBEDDED IN CONCRETE FLOORS

1350 Astor Street, Chicago.  
Ralph C. Harris, Architect;  
Buetter & Wolff, Engineering  
Consultants; Gallaber & Speck,  
Inc., Heating Contractors; The  
Davies Supply Company, Revere  
Distributor.

ACCORDING to recent building reports, the "Gold Coast" in Chicago has been chosen for the location of several very fine, new apartment buildings. Among them is 1350 Astor Street.

One of the interesting features of this outstanding building is that apartments on all fifteen floors will have the comfort and convenience of radiant panel heating. The heating coils are imbedded in the concrete floors. They utilize over 52,000 feet of Revere Copper Water Tube . . . nearly two-thirds of a mile of tube per floor.

From the beginning of the installation throughout a lifetime of service, Revere Copper Water Tube is ideal for radiant panel heating. Long lengths of this lightweight, easy-to-bend tube—the joints made with solder-type fittings—reduce the time and cost of installation. And experience has clearly proven that you can rely on this tube for long years of trouble-free service.

All Revere Copper Water Tube is stamped at regular

intervals with the Revere name and the type as your assurance of top quality.

Revere building materials—which include Sheet Copper, Revere-Keystone Thru-Wall Flashing and Reglet and Reglet Insert Flashing, Red-Brass and Copper Pipe—are available through leading distributors in all parts of the country. The Revere Technical Advisory Service is always ready to serve you. Call your Revere Distributor.

# REVERE

**COPPER AND BRASS INCORPORATED**

*Founded by Paul Revere in 1801*

230 Park Avenue, New York 17, New York

*Mills: Baltimore, Md.; Chicago, Ill.; Detroit, Mich.; Los Angeles and  
Riverside, Calif.; New Bedford, Mass.; Rome, N. Y.  
Sales Offices in Principal Cities, Distributors Everywhere.*

# Now Available! the Perfect Combination



## THE RICHMOND

*Claremont*

vitreous china, two-piece,  
quality closet combination  
Plate G-210

Now you can get the perfect closet combination — Richmond's Claremont — a compact close-coupled unit with a reverse trap bowl. Just look at this combination:

- **Richmond Quality.** Really built for satisfaction. Choice of 4 pastel colors or the famous Richmond "whiter-white."
- **Richmond Performance.** Large water area, deep seal, self-draining jet.
- **Richmond Appearance.** Smooth modern lines and a finish fit to grace the finest bathroom.
- **And Richmond Reputation.** The name Richmond is assurance of sound design, long trouble-free operation.

The Claremont's the perfect combination — a combination you'll want to specify and install.



# RICHMOND

RICHMOND RADIATOR CO. — AFFILIATE OF REYNOLDS METALS CO.



See your wholesaler or Mail Coupon Today:

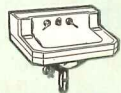

Vitreous China



Gas Boilers

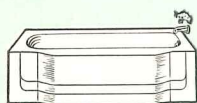

Enameled Cast Iron Ware

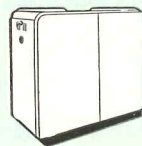

Winter Air Conditioners  
Gas—Cast iron or steel  
Oil—Steel

Richmond Radiator Company AR-1  
19 East 47th St.  
New York 17, N. Y.

Please send me the latest literature and information on the Richmond line of fine plumbing fixtures. No obligation, of course.

Name.....

Company.....

Address.....

# Check the specifications on these WELDWOOD FLUSH DOORS

You'll find many applications where one of these types is just what the client ordered

## WELDWOOD FIRE DOORS

are the only wood-faced doors that carry the Underwriters' Label for Class "B" openings. Special construction with fire-proofed edge-banding and mineral composition core gives you absolute fire protection in approved installations. Cross

bandings and facings are bonded with waterproof phenolic glue that enables this door to withstand moisture indefinitely.

Standard faces are selected Birch veneers. However, the Fire Door can be supplied with a wide variety of other handsome hardwood faces on special order. Thickness 1¾". Standard sizes.

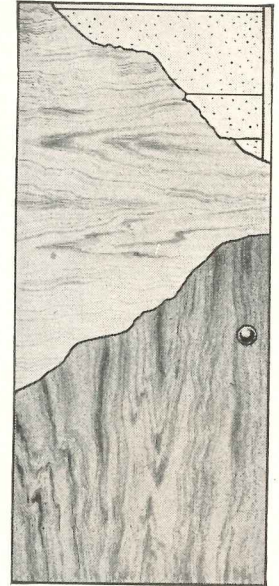

And only WELDWOOD FIRE DOORS can give you all these important advantages:

1. Increased Safety.
2. Striking Beauty.
3. Durability.
4. Dimensional Stability.
5. Lightweight.
6. Vermin and Decay Proof.
7. Moderate Cost.

### THE STANDARD WELDWOOD MINERAL CORE DOOR

Utilizes the same core material as the Weldwood Fire Door but edge bandings are not fireproofed. Recommended for locations where a labeled door is not required. Standard thickness: 1¾". Also available in 2¼", 2" and 1¾".

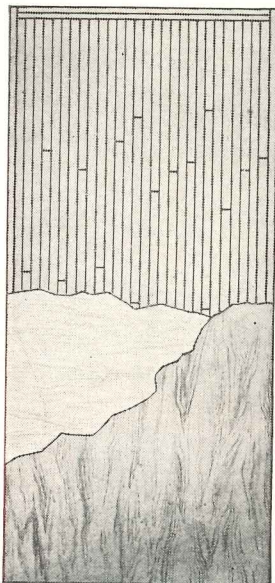

## THIS ATTRACTIVE WELDWOOD DOOR HAS A SOLID LUMBER CORE!

For convenience, ease of working and durable, trouble-free beauty, clients will appreciate your specification of this new all hardwood flush veneer door.

The specially designed lumber staved core gives exceptional dimensional stability, enables you to hang the door from either side and makes it especially adaptable to custom-cut lights or louvres. Hardware goes in quickly, easily and permanently.

The waterproof phenolic bonds means

you can specify this door for interior or exterior use.

The Weldwood Lumber Staved Core Door is made with richly figured veneer faces in all the popular hardwoods. Standard sizes in 1¾" and 1½" thicknesses. Also available in 2" and 2¼".

Check the complete specifications and data on *all* these popular Weldwood Doors. Your nearest Weldwood dealer can supply you with literature. Or, write us today. We'll rush complete information.

## UNITED STATES PLYWOOD CORPORATION

55 West 44th Street, New York 18, N. Y.

Distributing units in Albany, Baltimore, Boston, Brooklyn, Buffalo, Chicago, Cincinnati, Cleveland, Detroit, Fresno, Glendale, Hartford, High Point, Indianapolis, New Hyde Park (L. I., N. Y.), Los Angeles, Milwaukee, Newark, New York, Oakland, Philadelphia, Pittsburgh, Portland, Ore., Richmond, Rochester, San Francisco, Seattle, Spokane, St. Paul,

Washington, D.C. Also U.S.-Mengle Plywoods, Inc., distributing units in Atlanta, Birmingham, Dallas, Houston, Jacksonville, Kansas City, Kans., Louisville, Memphis, New Orleans, San Antonio, St. Louis, Tampa. In Canada: United States Plywood of Canada, Limited, Toronto. Send inquiries to nearest point.

the modern  
"fuse box"  
is now...

**FUSELESS!  
SHOCKPROOF!  
AUTOMATIC!**

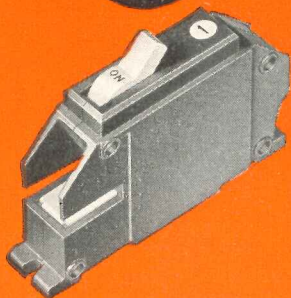
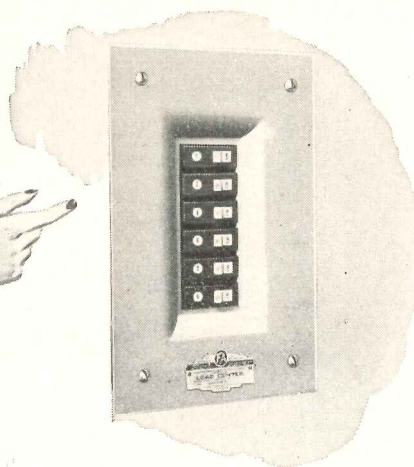

**Ⓢ THERMAL-MAGNETIC CIRCUIT BREAKER**  
For use in load centers up to 16 single poles or a combination of single and double poles totaling 16 poles maximum. Capacities: 15-20-30-40-50 amps.; for 120 and 120/240 volts AC service only.

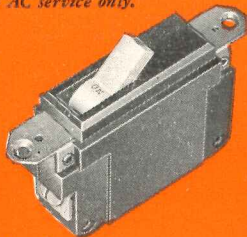

**Ⓢ TYPE A C JUNIOR CIRCUIT BREAKER**  
Automatic thermal trip for use in load centers, 6 circuits or less. Also for oil burner or stoker protection . . . or where smaller capacity circuit breakers are desired. Capacities: 10-15-20-30 amps.; 120 volts, AC service only, single pole.

**THAT'S RIGHT!** When short circuits or *dangerous* overloads occur, the Thermal-Magnetic action of the Ⓢ THERMAG Circuit Breaker Load Center instantly and *automatically* opens the circuit and trips the circuit breaker handle to "off" position. Then, safely and conveniently, a simple flip of the handle to "on" position restores the circuit to normal operation. And there is nothing to replace!

On harmless momentary overload, the *thermal* action of the individual circuit breaker maintains the circuit without needless interruption of service.

In cases of smaller capacity requirements, the new Ⓢ JUNIOR Circuit Breaker Load Center provides *automatic* protection for small residences, garages, stores, etc.

For more information, consult your Ⓢ Representative (he's listed in Sweet's) or write for Bulletins No. 202 and 203.



**Frank Adam Electric Co.**

ST. LOUIS 13, MISSOURI

Makers of BUSDUCT • PANELBOARDS • SWITCHBOARDS • SERVICE EQUIPMENT • SAFETY SWITCHES • LOAD CENTERS • QUIKHETER

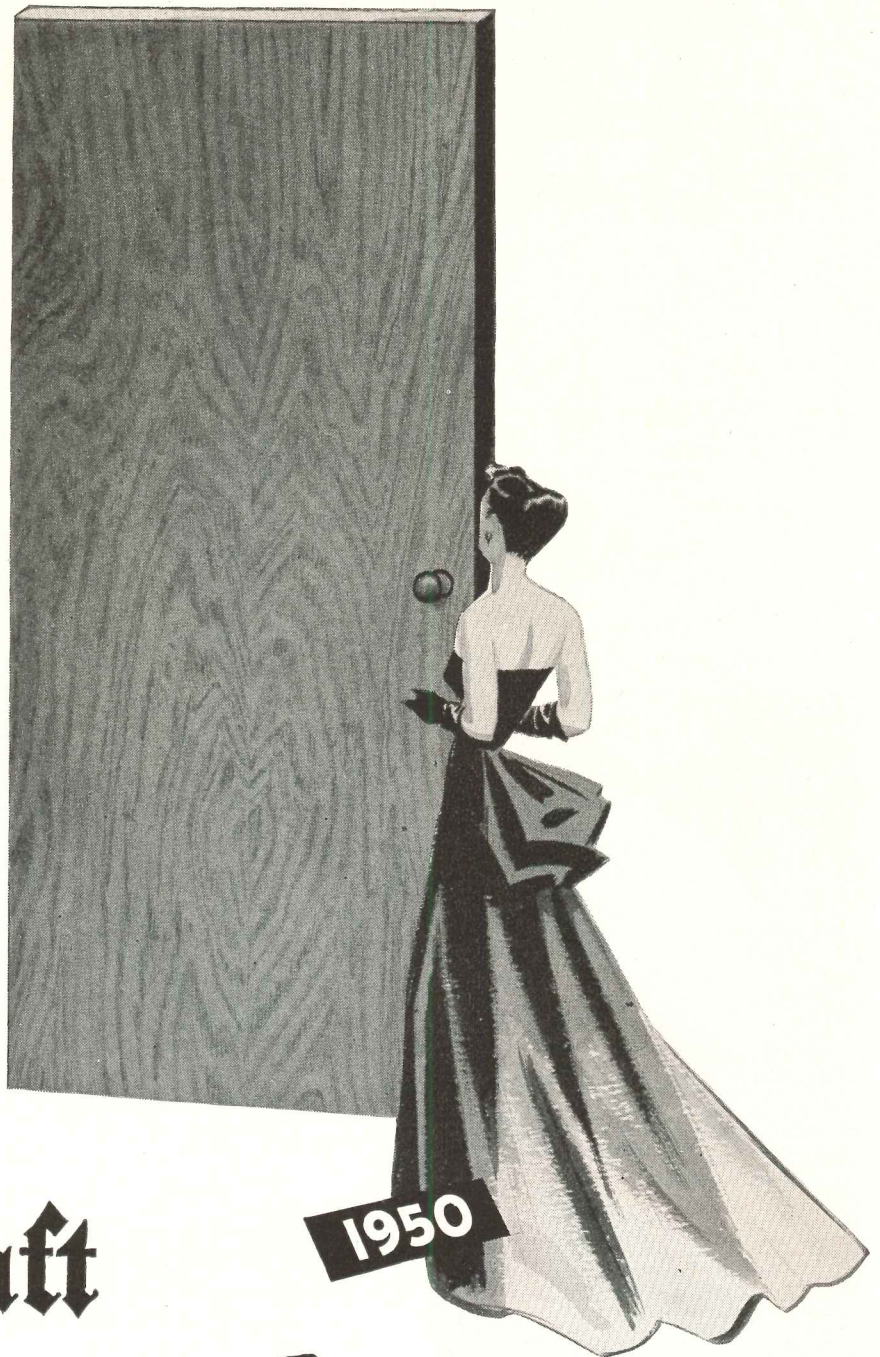

# Roddiscraft

*Quality for 50 years*

FOR 50 years Roddiscraft doors have been known as the architects' door. Roddis has worked closely with architects in the production of doors in keeping with new architectural trends and developments.

From "turn of the century" ornate inlaid doors to the simple beauty of the modern Roddiscraft flush door, Roddis has been a leader in door design and construction.

#### **Roddiscraft Firsts —**

In the interests of better construction, Roddis pioneered the hot plate press method of bonding—so essential to economical waterproof construction.

Roddis has pioneered and insisted on the use of standard thickness face veneers as opposed to thicker veneers as a proved method of improving the quality of flush doors.

Roddis developed specialized machinery which permitted quantity production of the Housemart Door with accordion type veneer core which gives solid core strength with 50% less wood content.

In Roddiscraft's past performance is the promise of the future. Architects can look to Roddiscraft with confidence for continued quality and pioneering in the interests of better products.

# Roddiscraft

QUALITY FOR 50 YEARS

**RODDIS PLYWOOD CORPORATION**

Marshfield, Wisconsin

**Nationwide Warehouse Service**



# Johns-Manville Announces

## A NEW DEVELOPMENT IN MOVABLE WALLS

### Asbestos Panels "INTEGRALLY COLORED" at the Factory

Cutaway of typical J-M Movable Wall construction. The 7/16"-thick asbestos panels, on patented steel studding, are available in a light green and light tan. NOTE HOW THE COLOR GOES ALL THE WAY THROUGH EACH PANEL!

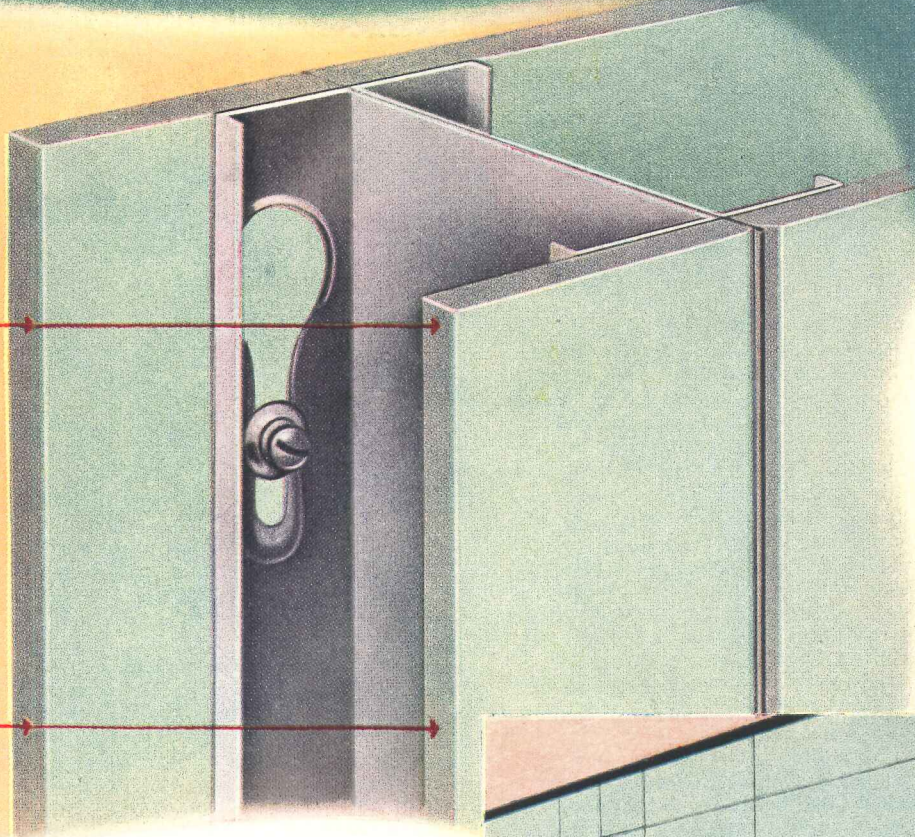

### No more painting. No more redecorating maintenance.

In the world's largest laboratory devoted to the improvement of building materials, Johns-Manville scientists have perfected a process for introducing inorganic pigments as an integral part of the asbestos panels used in J-M Movable Walls.

As a result, these beautifully-textured, fireproof panels now come pre-colored.

What's more, you'll have the advantage of "integral coloring," with the color going *all the way through*

*each panel*, so that it will never wear off. Your walls will have that "first-day newness" *every day* for years and years to come!

By eliminating painting and decorating expense, these new Transitone\* Movable Walls will help you to meet your wall and partition requirements *economically*.

Transitone panels are hung on steel studs, forming a 4" double-faced partition. Also used as interior finish for the outside walls. Lighter than ever, they are readily installed or re-located. For details or an estimate, write Johns-Manville, Box 290, New York 16, New York. \*Reg. U. S. Pat. Off.

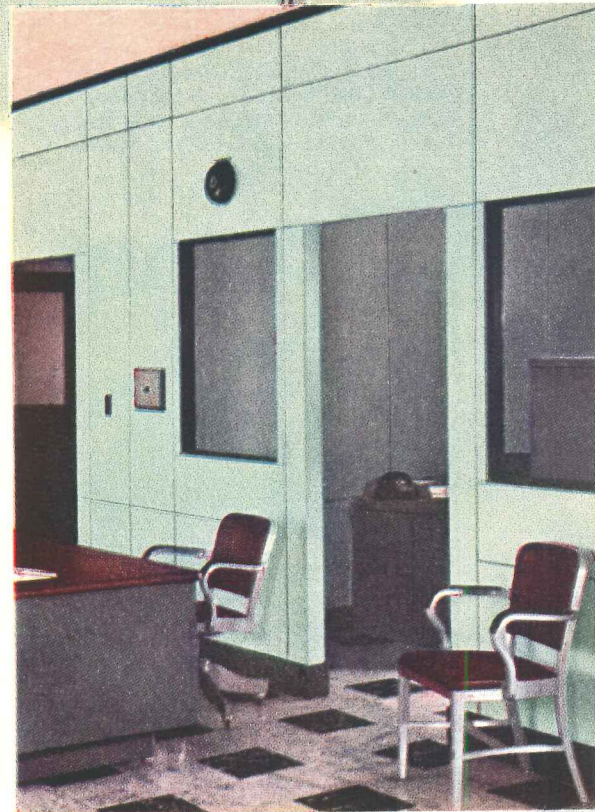

**Johns-Manville**



# Transitone

**MOVABLE WALLS** with asbestos panels colored all the way through

# WORTHINGTON

WORTHINGTON PUMP AND MACHINERY CORPORATION  
HARRISON, NEW JERSEY

## AIR CONDITIONING REPORT

Specialists in air conditioning  
and refrigeration  
for more than 50 years

### New Weather-Making Plant Has Finger-Tip Control

Thermostats Each 14 Feet, Four Fan Rooms  
On Each Floor, Assure Flexibility

A weather factory huge enough to turn out a ton of ice every day for every office in the new General Petroleum building, but sensitive enough to supply a different temperature every fourteen feet throughout the entire half-million square foot structure . . . that's the heating and air conditioning plant in General Petroleum Corp.'s new building in Los Angeles.

Basic approach in design of the equipment, which was done by the office of Ralph E. Phillips, consulting mechanical and electrical engineers, was determined by Southern California weather which may require the building to be heated and cooled simultaneously. One duct brings cooled air and the other heated air to all portions of the building.

The outlets are spaced to fit the modular design of the building which is on a 14 and 7 foot plan. Outlets are located each 14 feet on most floors; a few floors, where smaller offices

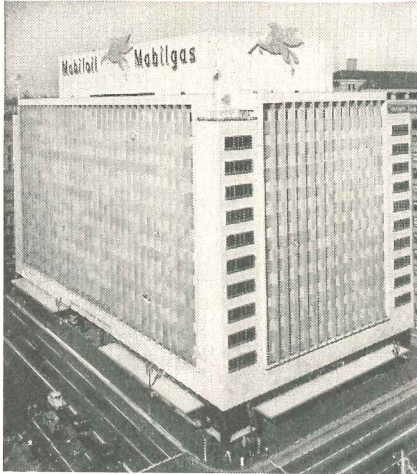

may be used, have outlets every 7 feet.

Each outlet has its own thermostatic control—more than a thousand controls altogether. Since most offices are 14 feet in width, that means each office can choose its own weather.

The controls operate dampers

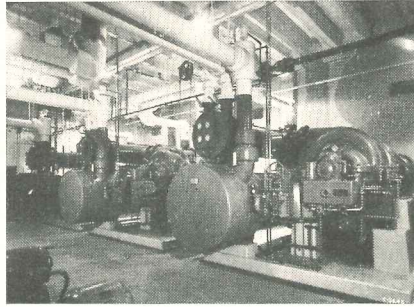

which automatically mix the hot and cold air to provide the desired temperature. A minimum of six and an average of eight complete air changes hourly are provided.

Feeding the air to the twin-duct system are 48 fan rooms. Four are located on each floor from the second to the top floor of the 13-story building. Each fan room contains heating and cooling coils and a 3 horsepower electrically driven fan flowing 7500 cfm.

The refrigeration plant consists of three Worthington 300-hp centrifugal compressors, using "Freon 11", with a capacity of 333 tons each. Chilled water from the refrigeration plant is circulated to the cooling coils in the fan rooms, from where the cooled and conditioned air is distributed throughout the building. Cooling towers are located on the roof.

W. S. Kilpatrick & Company, Los Angeles, contractors. Wurdeman & Becket, Los Angeles, Architects.

### Hot News Gets Cooled Off

The Nashville Tennessean and the Nashville Banner are published in Newspaper Printing Corp.'s air conditioned building.

The entire building, with the exception of the press room with its large printing roll presses, is air conditioned with Worthington equipment. Executive offices have individual temperature control. Multiple zone control for the building is provided by using face and by-pass dampers plus hot water reheat.

Air conditioning is provided by a Worthington centrifugal refrigeration system with a 150 ton refrigeration capacity. Chilled water is distributed to nine AVY and AHY type central plant air conditioning units which have chilled water cooling coils. A Worthington chilled water pump and two tower pumps complete the equipment for the system.

Architects and Engineers: Marr & Holman, Nashville. Contractors: J. M. Gallagher Co., Nashville.

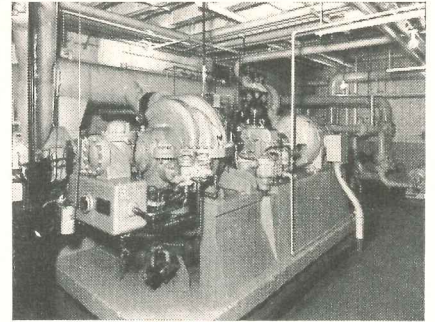

### Looks . . . and Feels Different

The Kaufman Department Store in Colorado Springs, Colorado, starts its 54th year in business with a new look and a different climate. All three floors of the store are air conditioned with Worthington equipment, which includes a 6HF4 Freon-12 condensing unit and a 4HF4 Freon-12 condensing unit. The latter controls temperature of basement and first floor, the 6HF4 unit controls second floor. Zone control is used by both. Consulting engineer: Douglas Jardine, Colorado Springs, Colorado.



## WORTHINGTON



AIR CONDITIONING AND REFRIGERATION

A complete line . . . in which *all* the vital components are *made*, not just assembled by Worthington. For more worth with Worthington, see your nearby Worthington distributor (consult Classified Telephone Directory).

# Look in your new Sweet's File

## Bruce Ranch Plank Floors

A NEW, POPULAR ADAPTATION OF RANDOM-WIDTH OAK FLOORS  
BEAUTIFUL . . . DISTINCTIVE . . . ECONOMICAL . . . EASILY INSTALLED

The beautiful new oak floor has been developed by Bruce to meet the need for a distinctive hardwood floor at moderate cost. It has features heretofore found only in very expensive floors. Installation of a Ranch Plank Floor is so simple that it can be handled by any floor layer. Prefinishing (see page 2 and 3) makes unnecessary any sanding and finishing on the job.

**Alternate widths and walnut plugs** are the two most prominent characteristics of this floor. The alternate 2 1/4 in. and 3 1/4 in. widths give an interesting, unusual effect and accentuate the beautiful grain of the wood. The walnut plugs throughout the rich appearance of a custom-built floor laid by expert craftsmen. A Ranch Plank Floor looks very much like the expensive random-width plank floor found in many fine homes designed by leading architects. The cost, however, is far less and installation is much less complicated. It is laid like regular prefinished strip flooring, except that 2 1/4 in. and 3 1/4 in. strips are alternated.

**Beautiful "Decorative" Finish**—This flooring is completely prefinished, including the walnut plugs which are inserted at the factory and made a permanent part of the floor. The finish on Ranch Plank Floors is a new, stylish "Decorative" finish, which has been created by interior decorators. This stylish maximum dark finish forms a perfect background for either the light colors of modern furniture or the darker shades of traditional.

Prefinished

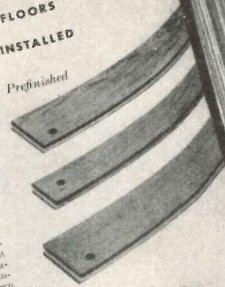

**For Modern Homes**  
The modern emphasis on design and texture is met by the distinctive pattern of the wide, alternate widths of the new strip of Ranch Plank Floors.

**For Ranch Homes**  
Low, simple ranch-type homes call for the casual, informal treatment provided by the random-width floor with its stylish "Decorative" finish.

**For Traditional Types**  
With its resemblance to random-width plank floors of olden times, Ranch Plank Floor is ideal for Colonial and other traditional architecture.

**For Apartments**  
A Ranch Plank Floor gives a luxurious, homelike touch to any apartment. It is out of the ordinary. It is the very popular with tenants.

### TECHNICAL DATA (BRUCE RANCH PLANK FLOORS)

Strip flooring is made of 2 1/4 in. and 3 1/4 in. strips. Edges of strips are finished. Walnut plugs are inserted at the factory and made a permanent part of the floor. The finish on Ranch Plank Floors is a new, stylish "Decorative" finish, which has been created by interior decorators. This stylish maximum dark finish forms a perfect background for either the light colors of modern furniture or the darker shades of traditional.

Plants by the famous "Scratch Test" method (see pages 7 and 8). Shade of finish: DECORATIVE (medium dark).  
**Installation**—In general, this flooring is laid exactly like regular strip flooring, except that 2 1/4 in. and 3 1/4 in. pieces are alternated. No sanding or finishing required on the job, no finishing is permitted. Ranch Plank Flooring is packed in corrugated metal cases for protection and easy handling. Each package contains 100 sq. ft. of 2 1/4 in. and 3 1/4 in. strips. Complete laying instructions on reverse.

SECTION  $\frac{13g}{2}$  IN ARCHITECTURAL FILE

SECTION  $\frac{2i}{1}$  IN BUILDERS FILE

AND YOU'LL FIND THE MOST HELPFUL DATA  
EVER PUBLISHED ON HARDWOOD FLOORS

# Bruce Hardwood Floors

PRODUCT OF E. L. BRUCE CO., MEMPHIS, TENN.  
WORLD'S LARGEST MAKER OF HARDWOOD FLOORS



Mail coupon  
for an extra copy  
for your files



E. L. Bruce Co.  
Memphis 1, Tenn.

Send us a copy of your new 4-color data file on Bruce Hardwood Floors.

Name \_\_\_\_\_

Firm \_\_\_\_\_

Address \_\_\_\_\_

# ELECTRIC HEAT

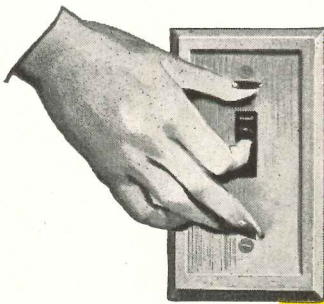

**USKON**  
ELECTRIC CEILING PANELS OF  
CONDUCTIVE RUBBER PROVIDE  
RADIANT HEATING FROM ABOVE  
...LIKE THE SUN



Originated and perfected solely by United States Rubber Company scientists, Uskon has changed America's heating standards almost overnight.

Uskon heats by radiation, as does the sun. The heating units are electrically conductive rubber sheets, four feet square, sandwiched between insulating layers. Installed in the ceiling, these panels warm any person or object receiving its rays. The conventional boiler, radiator, pipes, fuel storage, chimney and cellar are eliminated.

Uskon is invisible. The panels become part of the structure and blend into the decorative scheme of the room.

Each room can be controlled and heated separately, eliminating heat in rooms where it is not required. All installation of Uskon panels is done quickly and easily by local electrical contractors.

Uskon is already in use in homes all over the country. Each week sees more and more home-planners specifying this amazing heating system. Let us tell you more about it. Write Uskon, Graybar Electric Company, 420 Lexington Avenue, New York 17, N. Y. or direct to Wire and Cable Department, United States Rubber Company, 1230 Avenue of the Americas, New York 20, New York.

# USKON®

The  
Sunshine  
Heat

# FROM THE CEILING



HERE IS YOUR "FURNACE"



NO FURNACE, NO PIPES, NO FUEL STORAGE • NO ASHES, DIRT OR DUST  
NO RADIATORS. USKON IS "INVISIBLE."

A PRODUCT OF

**U.S. RUBBER**  
SERVING THROUGH SCIENCE

UNITED STATES  
RUBBER COMPANY

NATIONALLY

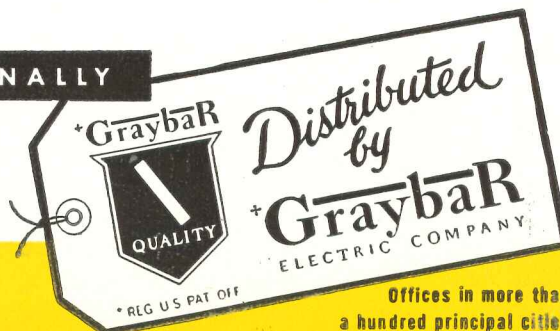

Offices in more than  
a hundred principal cities

# IN THE LARGEST, FINEST AIRPORT BUILDING



**MACOMBER NAILABLE STEEL BAR JOISTS  
SUPPORT ACRES OF CONCRETE FLOORS**

And Provide Fast, Secure Nailing For Metal Lath To Speed Up The Entire Floor Assembly And Pouring Operations.

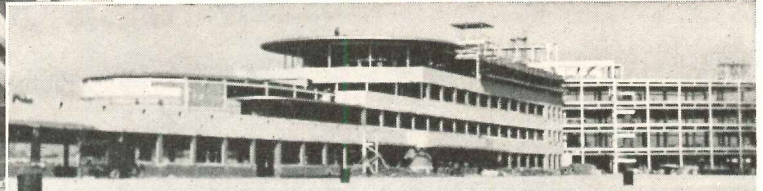

**JOSEPH HOOVER, ARCHITECT, PITTSBURGH, PA.**

To Get This Outstanding  
Structural Advantage Specify  
**MACOMBER NAILABLE STEEL JOISTS**  
PATENTED

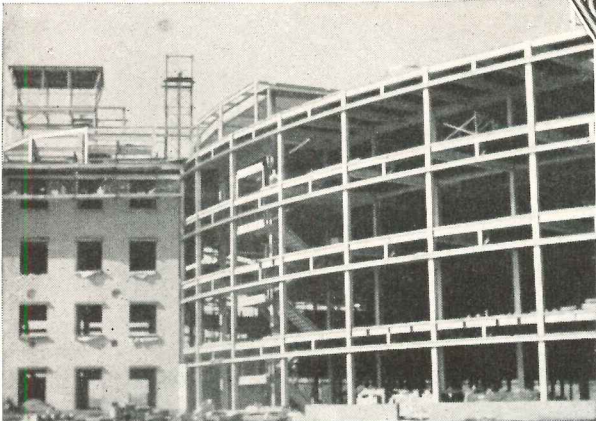
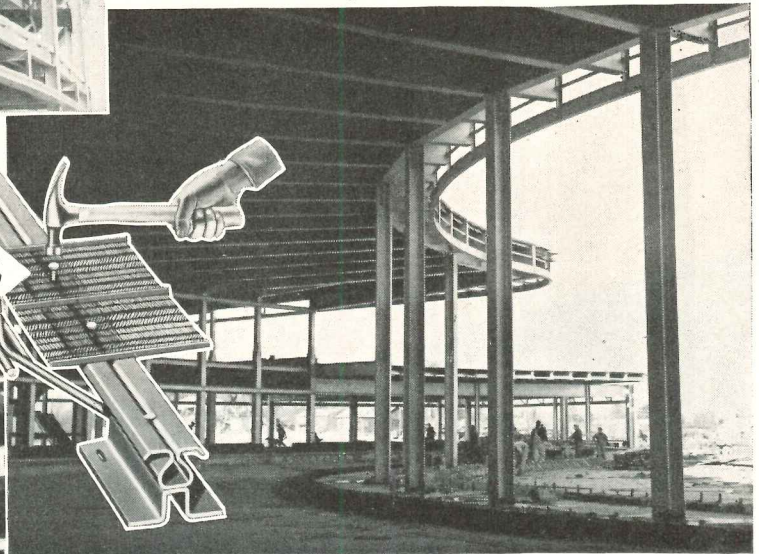

**DICK CONSTRUCTION CO., PITTSBURGH, PA.  
GENERAL CONTRACTOR**

**THE MACOMBER  
V BAR JOIST WAS  
APPROVED BY THE  
STEEL JOIST INSTI-  
TUTE ON OCT. 23, 1946**



These pictures of the Greater Pittsburgh Airport Building give some idea of the magnitude of this structure, unique in the entire world in its vision of airport facilities. Shown also are Macomber Nailable Steel Bar Joists as used in floor and roof construction—a product just as unique in the entire construction world—NAILABLE Steel Joists. Joists made entirely of steel with 2½ times the holding power of wood. Here at last is a BUILDER'S unit! Think of the difference in NAILING slab centering materials as compared to wiring or clipping each one. Yet, Macomber Nailable Bar Joists cost no more. Write for catalog and immediate quotation.

**HOME, SCHOOL, COMMERCIAL AND INDUSTRIAL FLOOR AND ROOF SYSTEMS  
STANDARDIZED STEEL BUILDING PRODUCTS**

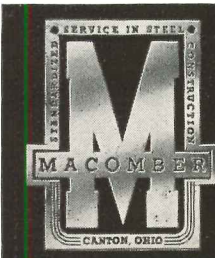

**MACOMBER • INCORPORATED  
CANTON, OHIO**

**IN CANADA, SARNIA BRIDGE CO., LIMITED, SARNIA, ONT.  
IN MEXICO D. F.—MACOMBER DE MEXICO S. A. CEDRO 500**

**V BAR JOISTS • LONGSPANS • BOWSTRING TRUSSES • STEEL DECK**

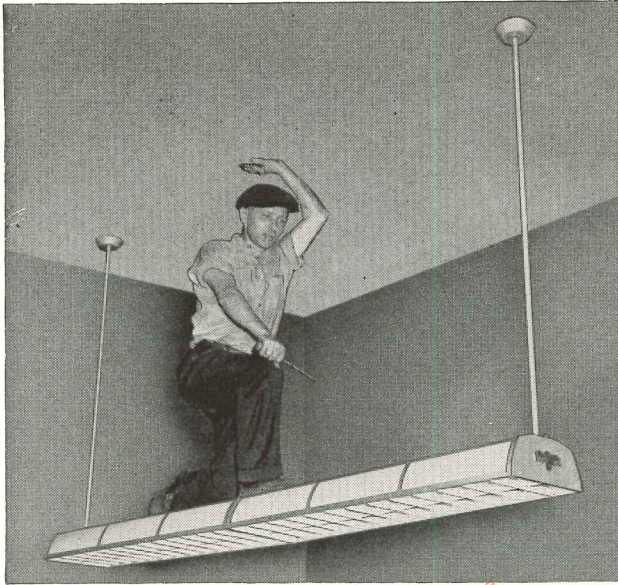

**built like a bridge**



*“The Monroe”*  
**96" T-12 SLIMLINE and  
 STANDARD 40-WATT  
 LUMINAIRE**

Framed-plastic, aluminum or steel side-panels; designed for quick and easy surface or pendant mounting, individually or in continuous row.



**“LIGHT BEAMS” for  
 BUILDING FOOT-CANDLE LEVELS**

This actual photograph of a pendant mounted “Monroe” Slimline Luminaire proves our point that it’s “built like a bridge.” The “Monroe” is not recommended for heavy foot-traffic, but its bridge-like construction provides for perfect alignment on continuous runs with hangers spaced only at every 8 feet. This minimum of hangers and the unit’s rugged construction mean reduced installation costs and improved appearance.

In design, in construction, in flexibility of use—the new “Monroe” is the ideal fluorescent unit. Its efficiencies of up to 83% with 25/35° shielding; its low initial cost; its long service life add up to *good lighting at economical cost.*

**WRITE TODAY** for complete information on the “Monroe” and other Fluorescent Luminaires in the Pittsburgh Permaflex Presidential Series.

**PITTSBURGH REFLECTOR COMPANY**

402 OLIVER BUILDING • PITTSBURGH 22, PENNSYLVANIA

*Permaflex Lighting Engineers in All Principal Cities*

**PITTSBURGH PERMAFLECTORS ARE DISTRIBUTED BY BETTER ELECTRICAL WHOLESALERS EVERYWHERE**



This classroom in the new Gratiot High School is properly sound conditioned with Acousti-Celotex ceiling tile.

**The model  
Gratiot High  
School has  
BUILT-IN  
QUIET**

Teachers and pupils alike will benefit from the quiet which was built into the new Gratiot High School in Wayne County, Michigan. Noise will not hamper instruction or study because Acousti-Celotex ceiling tile soaks up unwanted sounds. Each sturdy, light-weight tile checks sound reverberation *before it starts!* Quiet is maintained in hallways, lunch rooms, gymnasiums and study halls as well as classrooms.

Modern Sound Conditioning is just as important for offices, stores, hotels, hospitals and banks—wherever people congregate for work, play or rest. And over 200,000 Acousti-Celotex installations already provide lasting, built-in quiet for buildings from coast-to-coast.

Easily and quickly installed, Acousti-Celotex requires no special maintenance. Can be painted and washed repeatedly without reducing its sound absorbing efficiency. *No wonder more and more architects specify Acousti-Celotex products for tested and proved acoustical materials to meet every building code, specification and sound conditioning requirement!*



**ACOUSTI-CELOTEX**

*Sound Conditioning Products*

PRODUCTS FOR EVERY SOUND CONDITIONING PROBLEM

The Celotex Corporation, 120 S. La Salle St., Chicago 3, Illinois • Sound Equipments, Ltd., Montreal, Quebec, Canada



**fedders**  
A Great Name Since 1896

OFFERS  
AMERICA'S MOST COMPLETE LINE OF

# CONVECTOR-RADIATORS

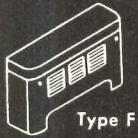

Type F

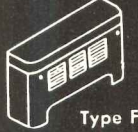

Type FE

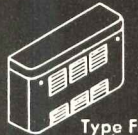

Type FB



Type SF

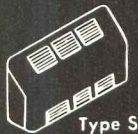

Type SFB



Type W

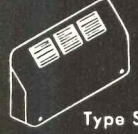

Type S

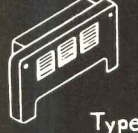

Type R

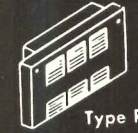

Type RB

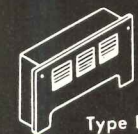

Type RC



Type RCB

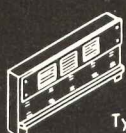

Type P



Type PB

● Fedders Convector-Radiators are made in sizes and types to fit every installation requirement.

They are made in standard Type F free-standing and semi-recessed models available from stock and also a wide range of models for special applications.

Men who design, sell and install heating equipment can take advantage of Fedders wide range of models including flat and sloping top, wall hung and free-standing models with and without base grilles. Other models include semi and completely recessed Convector-Radiators with overlapping and plaster fronts to conform to any decorative scheme.

Fedders heating elements also available for use with individually designed concealed systems. Heating elements provide quick response to manual and thermostatic control. Write for data sheets. Consult yellow section of phone book for your local Fedders representative.

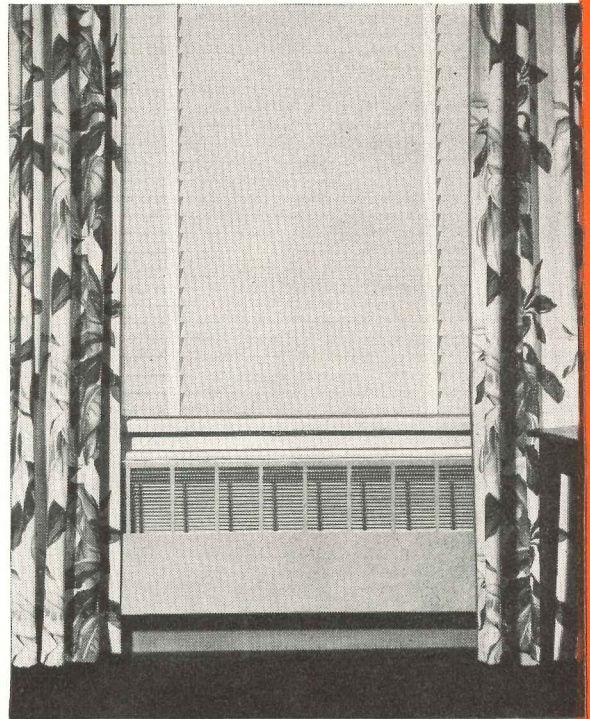

*Also manufacturers of Fedders Unit Heaters, Wall Radiation, Unit Coolers, Air Cooled Refrigeration Condensers, Room Air Conditioners, Automotive Radiators and Car Heater Cores.*

**FEDDERS-QUIGAN  
CORPORATION  
BUFFALO 7, N. Y.**



**THE GREAT WHITE WAY**  
**LIGHTS UP** with  
**NEO-RAY**  
 America's Smartest Louvred Ceiling

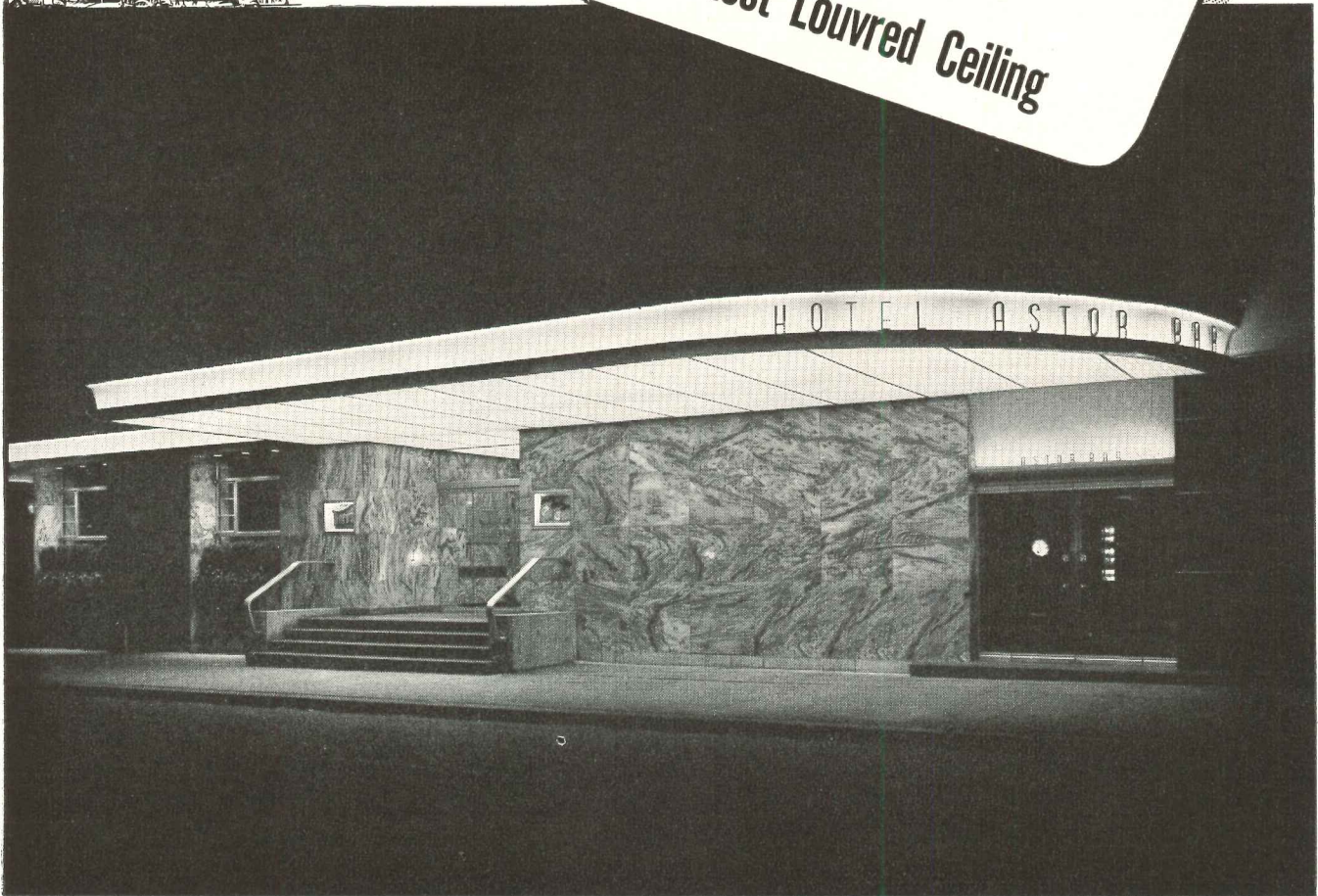

Neo-Ray Louvred Ceiling in marquee of Hotel Astor, Times Square, New York. Selected because it maintains perfect alignment under all climatic conditions . . . never a wavy or corkscrew effect.

Designers: The Walter M. Ballard Corp.

More and more specifications call for Neo-Ray. And no wonder! It's the louvred ceiling that maintains perfect alignment under all conditions . . . that's adaptable to every type of ceiling . . . that's so easy and simple to install. On that next louvred ceiling job — can you afford to overlook the many exclusive and patented features of Neo-Ray?

SEND FOR NEW 64 PAGE CATALOG

Gives complete engineering data and lighting tables for each item in our complete line of fluorescent, slimline, and incandescent fixtures. *Plus* New simplified spot lamp tables for computing light intensities in show windows and all high-lighted areas.

## NEO-RAY PRODUCTS, INC.

315 East 22nd Street • New York 10, N. Y.

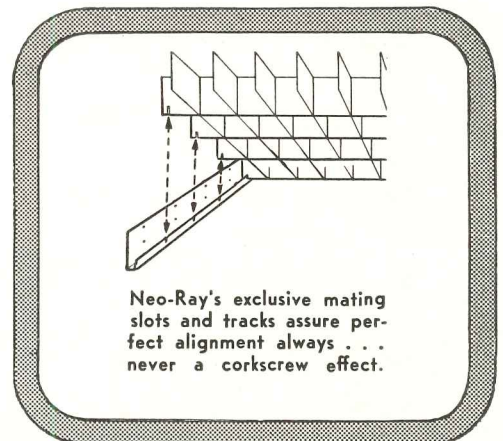

Neo-Ray's exclusive mating slots and tracks assure perfect alignment always . . . never a corkscrew effect.

**IT'S EASY  
ALL THE WAY**

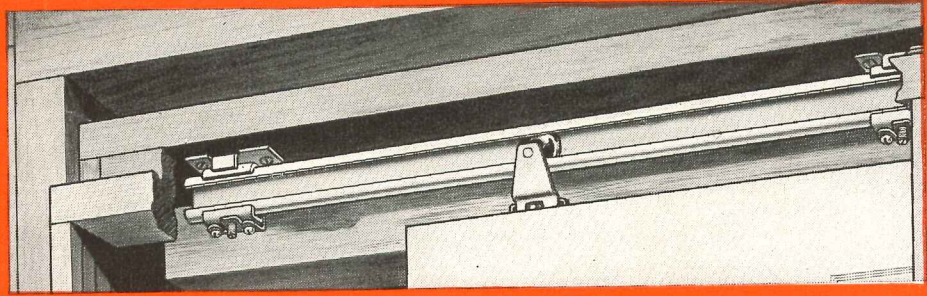

... when homes  
are planned  
and built  
with

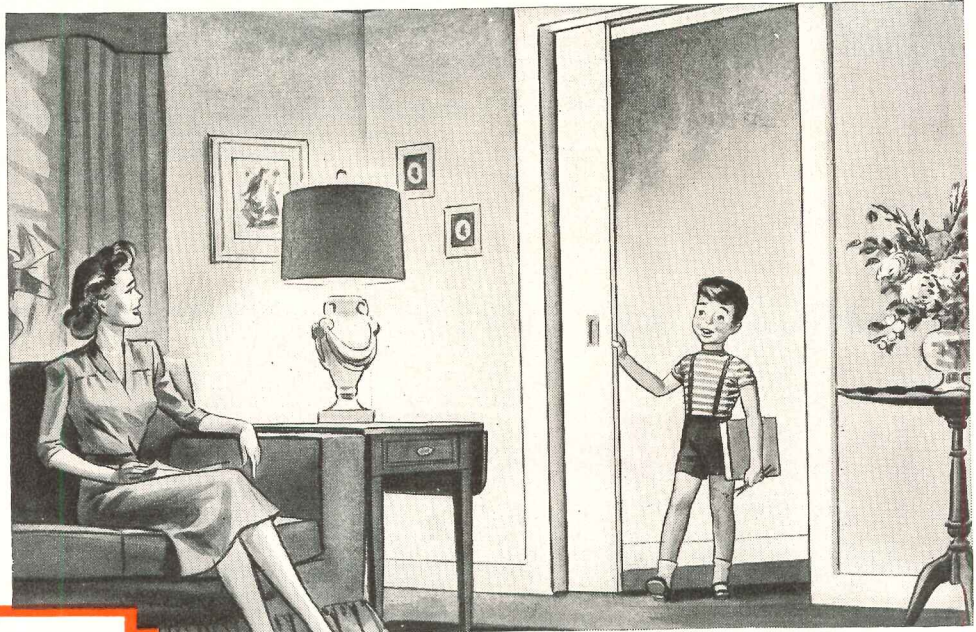

**STANLEY**

Reg. U.S. Pat. Off.

*Residential*

**SLIDING DOOR HARDWARE**

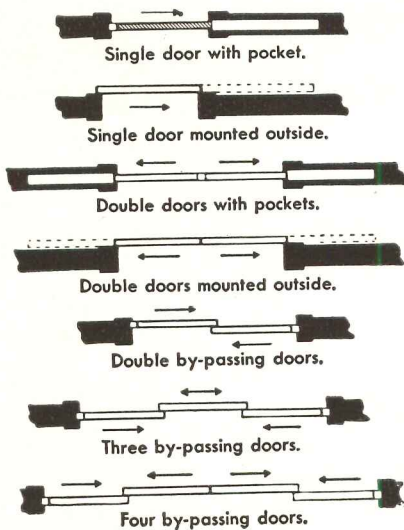

Sliding Doors Pay Extra Dividends in smart appearance, easy, effortless operation, and more freedom for furnishings. Leading architects, builders and suppliers are emphasizing these advantages in the trend to lightweight interior doors where compactness and convenience are important.

Wide Range of Applications (*several shown here*) is matched by modern Stanley design . . . V-shaped track for minimum friction . . . quick and easy adjustment with a screw driver without removing trim. Complete plans are packed with each set. The Stanley Works, New Britain, Connecticut.

➔ Send for this special folder that illustrates and describes complete line, with door plans, header construction and installation details.



**STANLEY**

Reg. U.S. Pat. Off.

**HARDWARE • HAND TOOLS • ELECTRIC TOOLS • STEEL STRAPPING**



Partial view of Meadowbrook Apartments, Indianapolis, Indiana. Owners: Meadowbrook Sponsors. Architects and Engineers: Allen and Kelley. General Contractor: Mars Engineering, Inc. Heating and Plumbing: Freyn Brothers, Inc. Electrical Contractor: Hatfield Electric Co. All of Indianapolis, Indiana.

GARDEN APARTMENT COMMUNITY USES 5½ MILES OF

## *Webster Baseboard Heating*

Heating for the \$5,500,000 Meadowbrook Apartments, Indianapolis, Indiana, is Webster Baseboard Heating—5½ miles of it.

“The sponsors were convinced after a thorough investigation, that Webster Baseboard Heating would provide the best type of heating system at a reasonable cost for Meadowbrook tenants.” So says Alvin Jones, president of Meadowbrook Corporation.

Financing for Meadowbrook Apartments was provided by a \$4,792,500 loan from the John Hancock Life Insurance Company of Boston, and

insured under Federal Housing Administration 608. Rentals under FHA procedure for such a program average \$90 per month, including refrigerator, range, heat and water.

Many families are already occupying some of the 648 one and two-bedroom apartments and are enjoying the complete heating comfort and benefits of Webster Baseboard Heating. Each of the 37 two-story buildings has its own oil-fired heating unit, and every tenant has individual control of his own heating system.

With floors, walls and ceilings evenly



Living area in a living-dining room of one of the apartments. Door at right leads to compact kitchen. Apartments contain one or two bedrooms.

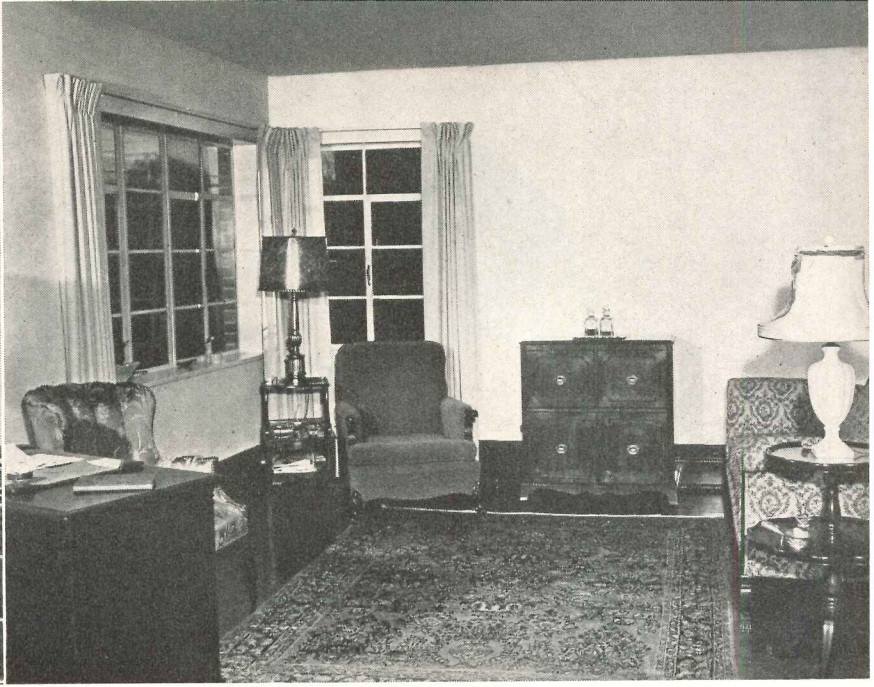

Living room shows how baseboards painted to harmonize with decorative scheme are practically invisible. Webster Baseboard Heating gives complete freedom in arranging room interiors. There's nothing to interfere with drapes or furniture.

warmed by genuine, perfected Webster Baseboard Heating, Meadowbrook Apartments heating costs are kept to a minimum. 72° room temperatures are maintained easily even in the coldest weather. Webster Baseboard Heating is *clean heat, convected heat . . . radiant heat* in its most practical form. Owners of

Meadowbrook are looking forward to minimum fuel costs this heating season.

If you haven't already included Webster Baseboard Heating in your 1950 plans, then do so now. The Webster Representative in your locality will furnish complete details — let us give you his name.

Address Dept. AR-1

## WARREN WEBSTER & CO.

Camden 5, N. J. : : Representatives in Principal U. S. Cities : : *In Canada, Darling Brothers, Limited, Montreal*

# Webster

# BASEBOARD HEATING

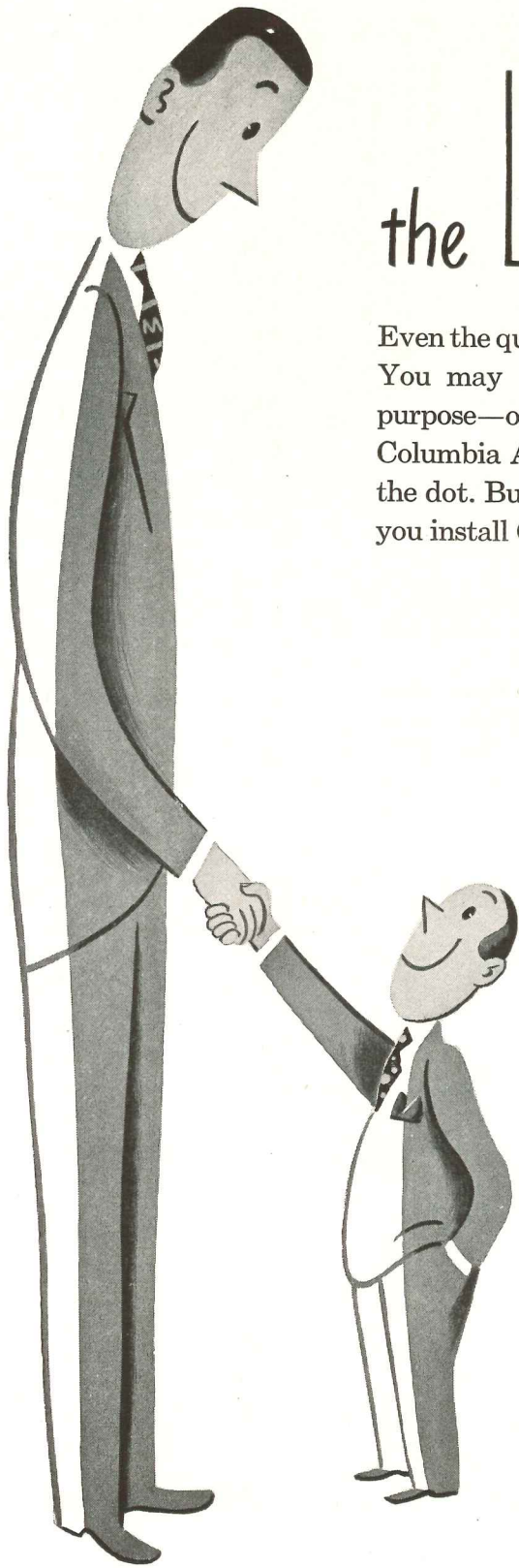

# the LONG and the SHORT of it

Even the queerest window shade requirements don't baffle Columbia! You may want extra long, skinny shades for some mysterious purpose—or jumbo shades that sound impossibly large. Just see your Columbia Authorized Dealer and he'll follow your specifications to the dot. But versatility is only one of the big benefits you get when you install Columbia Window Shades. Some others are:

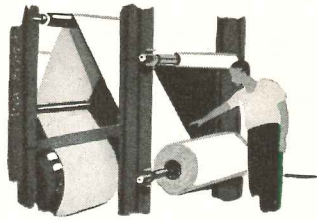

**Long Life**—Columbia Shades are built for hard wear . . . woven to resist pinholes and cracks. Maintenance costs are kept way down because Columbia Shades are really tough.

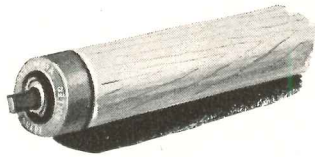

**Perfect Service**—Quiet and dependable operation is assured. Columbia Shades and rollers pass rigid tests before they leave the factory.

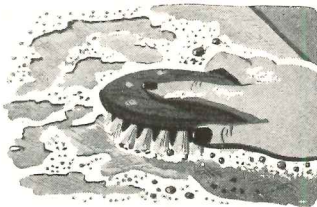

**Washability**—The firm fabric in Columbia washable shades comes smiling through repeated scrubblings. Colors stay fresh as new.



**Weather-proof** — Columbia Shades are impervious to weather. Stand up boldly to wind, rain, scorching sun. Columbia Cloth surpasses U.S. Govt. Specifications in quality.

*Columbia Shades and Venetian Blinds are sold only through Columbia Authorized Dealers in leading department stores, furniture stores and shade shops.*

**Columbia**  
WINDOW SHADES  
AND VENETIAN BLINDS

We will gladly submit *specifications* for shades that can become a part of the General Contractors bid. This includes a recommendation for correct type of fabric, mechanism and color; method of manufacture and proper installation. Let us call on you and discuss your particular problems.

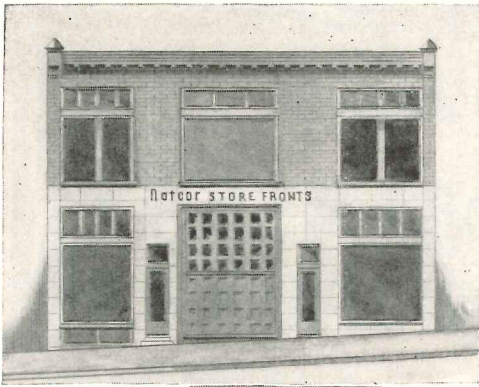

## MEETS YOUR DEMAND WITH EXPANDED FACILITIES

**YOUR CONFIDENCE . . .** and trust in **NATCOR STORE FRONTS** made this new plant possible. Architects specifying **N.S.F. Mouldings** in ever increasing quantity have led to this expansion move.

**NATCOR PROGRESS . . .** with sales-service and now manufacturing facilities expanded to keep pace with growing demand — our *fully extruded Alumilited Aluminum Store Front Mouldings* will flow in increased volume to dealers throughout the United States, Canada and foreign countries.

**NOW MANUFACTURING . . .** in our new plant at **TAUNTON, MASSACHUSETTS** we will be of even greater assistance in solving your store front problems. Inquire about our planning service and ask for our full size details.

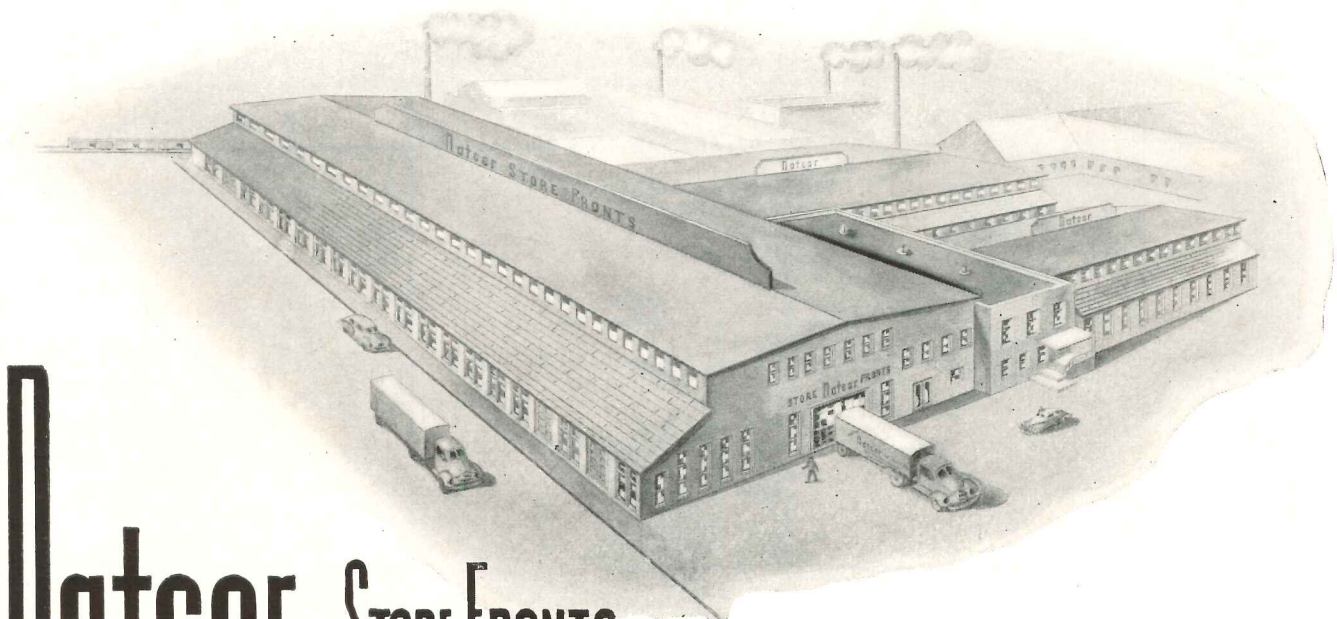

# NATCOR STORE FRONTS

TAUNTON, MASSACHUSETTS, U.S.A.

Use these handy

# GUIDE CHARTS

## for SPECIFYING RESILIENT FLOORS

With these three Kennedy Floors you can satisfy every flooring need—carry out your own or your clients' wishes. Information below gives you a quick picture of the general characteristics of each floor. The charts show its suitability for specific areas and its approximate cost range.

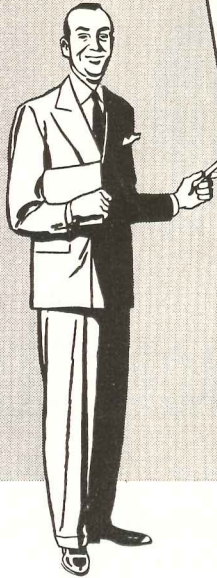

**Kentile Asphalt Tile**—colorful, long-wearing, inexpensive to install and maintain. Has been called “the nearest approach to a universal, all-purpose flooring.” The only type of flooring which can be successfully installed over concrete in direct contact with the earth.

**Rubber Tile** by the makers of Kentile—a leading choice for its brighter colors... offers many exclusive colors created by CARL FOSS. Highly resilient, it cushions footsteps... is

resistant to chipping, cracking, marring.

**NOTE:** This rubber tile contains no oils—no ingredients to dry out and leave the tile brittle.

**Kencork Cork Tile (Floors and Walls)**—When a truly distinctive floor is desired, Kencork is a first choice. Its natural cork tones are unsurpassed for beauty...bring elegance to any interior. Cork floors made by Kennedy are unusually durable—Kencork floors laid over 35 years ago are still in A-1 condition.

### APPROXIMATE COST RANGE CHART

Where two or more groups appear in a price bracket, the least expensive is on top.  
Cost based on installing a minimum area of 1000 square feet over cement underfloor.

Cents Per Square Foot	KENTILE	KENCORK	RUBBER TILE
20¢	1/8" GROUP A		
25¢	1/8" GROUP B 3/16" GROUP A		
30¢	1/8" GROUP C 3/16" GROUP B		
35¢	1/8" GROUP D		
40¢	1/8" SPECIAL* 3/16" GROUP C 3/16" GROUP D		
45¢	3/16" SPECIAL*		
55¢			1/8" THICKNESS
65¢		5/16" NATURAL FINISH	
70¢		5/16" FACTORY FINISH	
75¢			3/16" THICKNESS

\*Special Kentile for Industry (Greaseproof)



## RESIDENTIAL INSTALLATIONS

	KITCHENS	BATHROOMS	BEDROOMS	NURSERIES	LIVING ROOMS	FOYERS	BASEMENT PLAYROOMS UTILITY ROOMS
<b>KENTILE</b> Asphalt Tile	✓	✓	✓	✓	✓	✓	✓
<b>KENCORK</b> Cork Tile	NO	✓	✓	✓	✓	NO	NO
<b>RUBBER TILE</b> by the makers of Kentile	✓	✓	✓	✓	✓	✓	NO

## COMMERCIAL INSTALLATIONS

	RECEPTION ROOMS AND OFFICE WORKING AREAS	PRIVATE OFFICES	HOSPITAL WARDS AND CORRIDORS	SCHOOLS PUBLIC BUILDINGS	LIBRARIES	STORES GROCERIES ... DRUG CHAINS... DEPT. STORES	RESTAURANTS	FACTORY AREAS
<b>KENTILE</b> Asphalt Tile	✓	✓	✓	✓	✓	✓	USE SPECIAL KENTILE FOR INDUSTRY (GREASEPROOF)	USE SPECIAL KENTILE FOR INDUSTRY (GREASEPROOF)
<b>KENCORK</b> Cork Tile	✓*	✓	✓	✓*	✓	NO	NO	NO
<b>RUBBER TILE</b> by the makers of Kentile	✓	✓	✓	✓	✓	✓	✓ BUT NOT IN OR NEAR KITCHEN AREAS	NO

*\*When properly maintained*

If you would like to have additional copies of these guide charts, please write the office nearest to you

**DAVID E. KENNEDY, INC.** • 58 2nd Avenue, Brooklyn 15, N. Y.

350 Fifth Ave., New York 1, N. Y. • 705 Architects Bldg., 17th and Sansom St., Philadelphia, Pa. • 1211 N.B.C. Bldg., Cleveland 14, Ohio • 225 Moore St. S.E., Atlanta 2, Ga. • Kansas City Merchandise Mart Inc., 2201-5 Grand Ave., Kansas City 8, Mo. • 1440 11th St., Denver 4, Colo. • 4532 South Kolin Ave., Chicago 32, Ill. • 4501 Santa Fe Ave., Los Angeles 11, Calif. • 452 Statler Bldg., Boston 16, Mass.

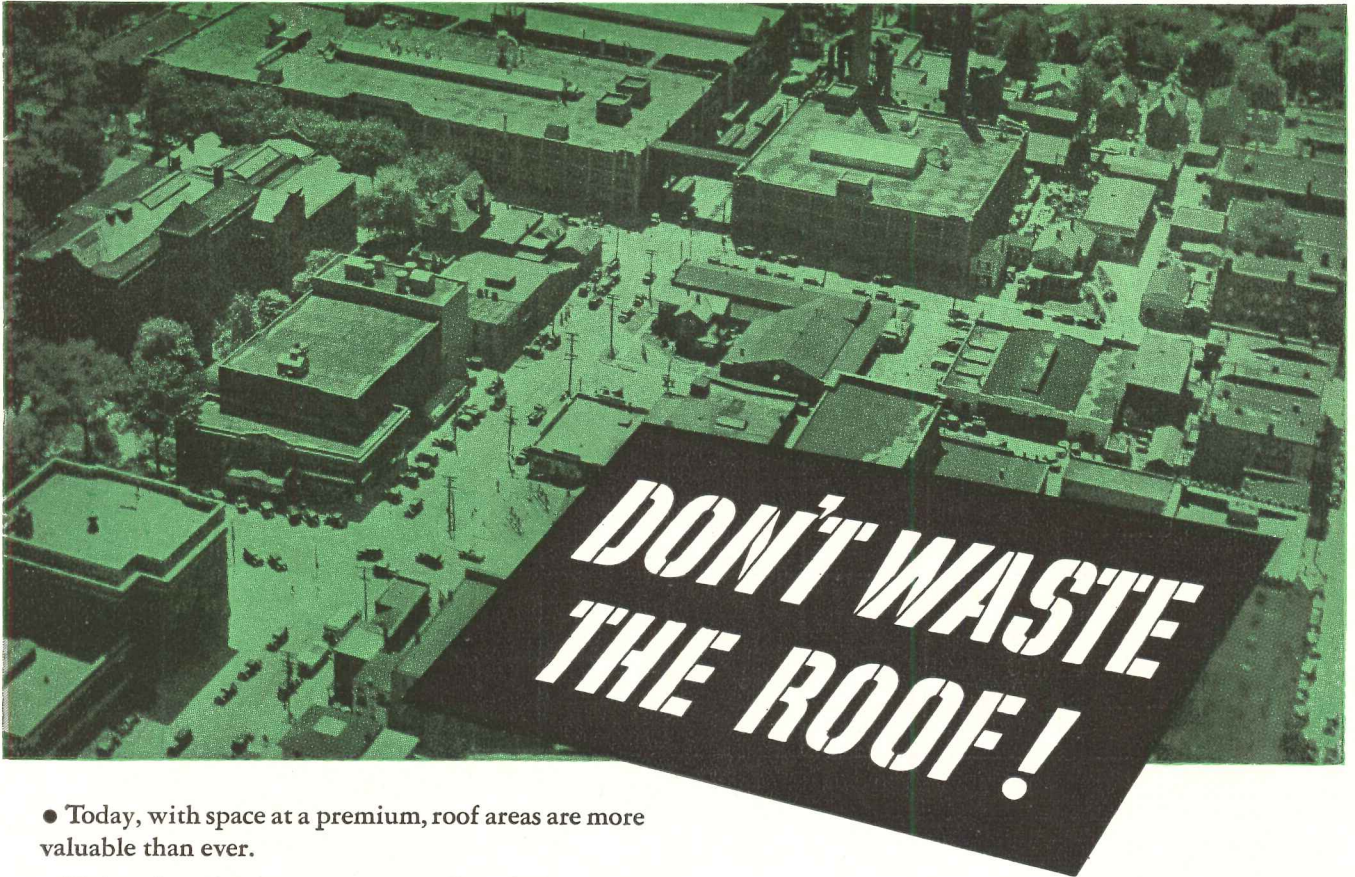

● Today, with space at a premium, roof areas are more valuable than ever.

Today, imagination is paying off in dollars... as hospital, school, office-building roofs are being turned into recreational areas... as factory and warehouse roofs are being converted to heavy-traffic use... as apartment and hotel roofs are blossoming into garden paradises!

Whatever type of building you plan, Ruberoid can help you make full and better use of the roof area. Complete specifications, soundly engineered in design, thoroughly tested in construction, are available at your nearest Ruberoid office—or from your Ruberoid Approved Roofer.

#### HEAVY TRAFFIC ROOF

Modern use of this roofing area gives extra shipping and storage space, adds to plant efficiency. Surface is concrete. Tough and wear-resistant for years of trouble-free service.

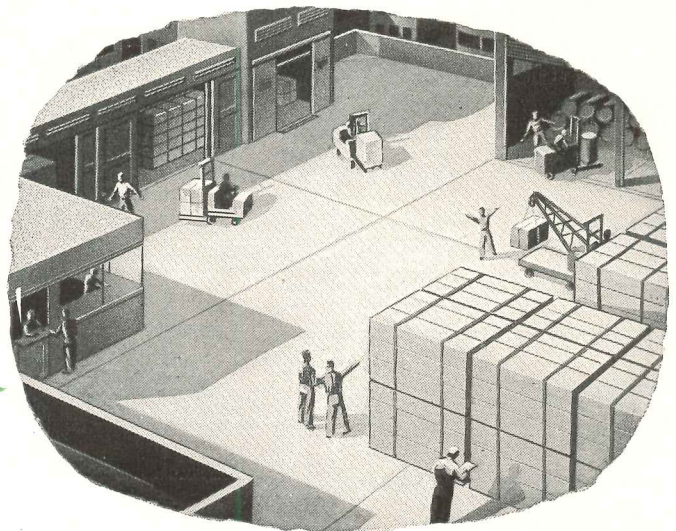

## The RUBEROID Co. built-up roofings

Building Materials for Industry, Home and Farm • Executive Offices: 500 Fifth Ave., New York 18, N. Y.

*The right roof  
for any job -  
from ONE source!*

Ruberoid makes every type of built-up roof—smooth-surfaced asbestos, coal tar pitch with gravel or slag surfacing, or smooth or gravel-and-slag surfaced asphalt... in specifications to meet any need.

Ruberoid Approved Roofers are not prejudiced in favor of any one type. You are assured of one source for all materials, centralized responsibility, smoother operation, uniform quality!

#### Sales Offices:

BALTIMORE, MD.  
CHICAGO, ILL.  
DALLAS, TEXAS  
ERIE, PENN.  
MILLIS, MASS.  
MINNEAPOLIS, MINN.  
MOBILE, ALA.  
NEW YORK, N. Y.

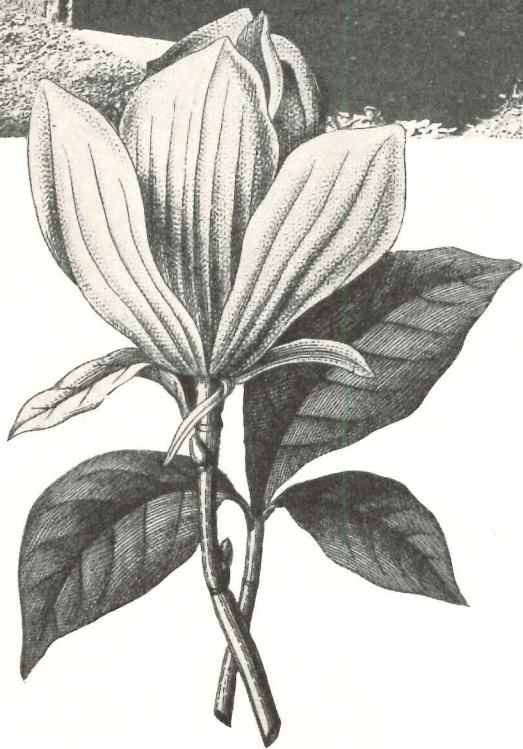
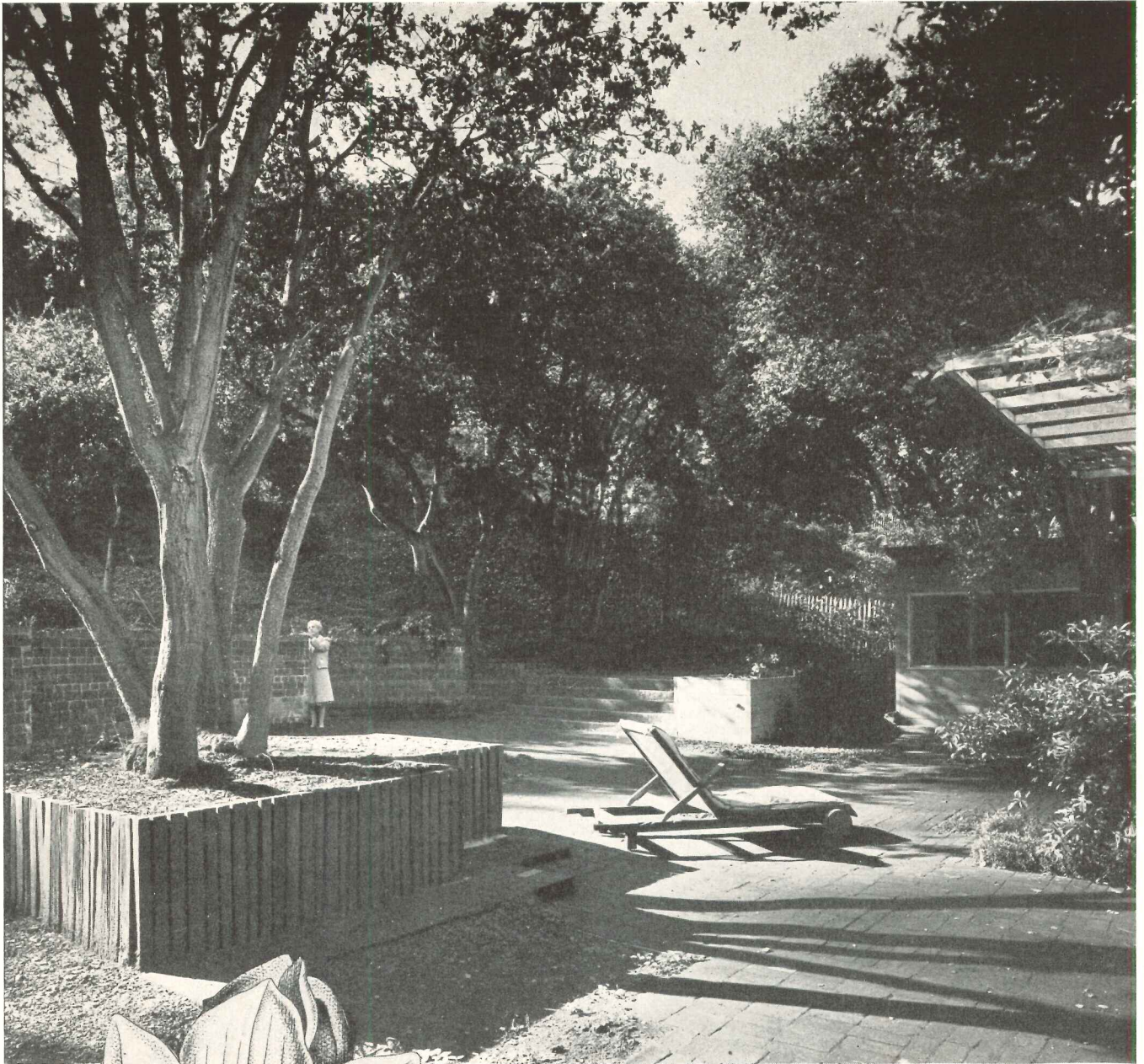

## SPACE AND PEOPLE

*by Garrett Eckbo*

The Editors present in these pages a condensation of part of an important book, "Landscape for Living," which will be published early in 1950 by ARCHITECTURAL RECORD in collaboration with Duell, Sloan & Pearce. The author, of the California firm of Eckbo, Royston and Williams, planning consultants and landscape architects, is interested and experienced, not alone in organizing outdoor space to fulfill definite functions, but also in positively, humanly relating it to people.

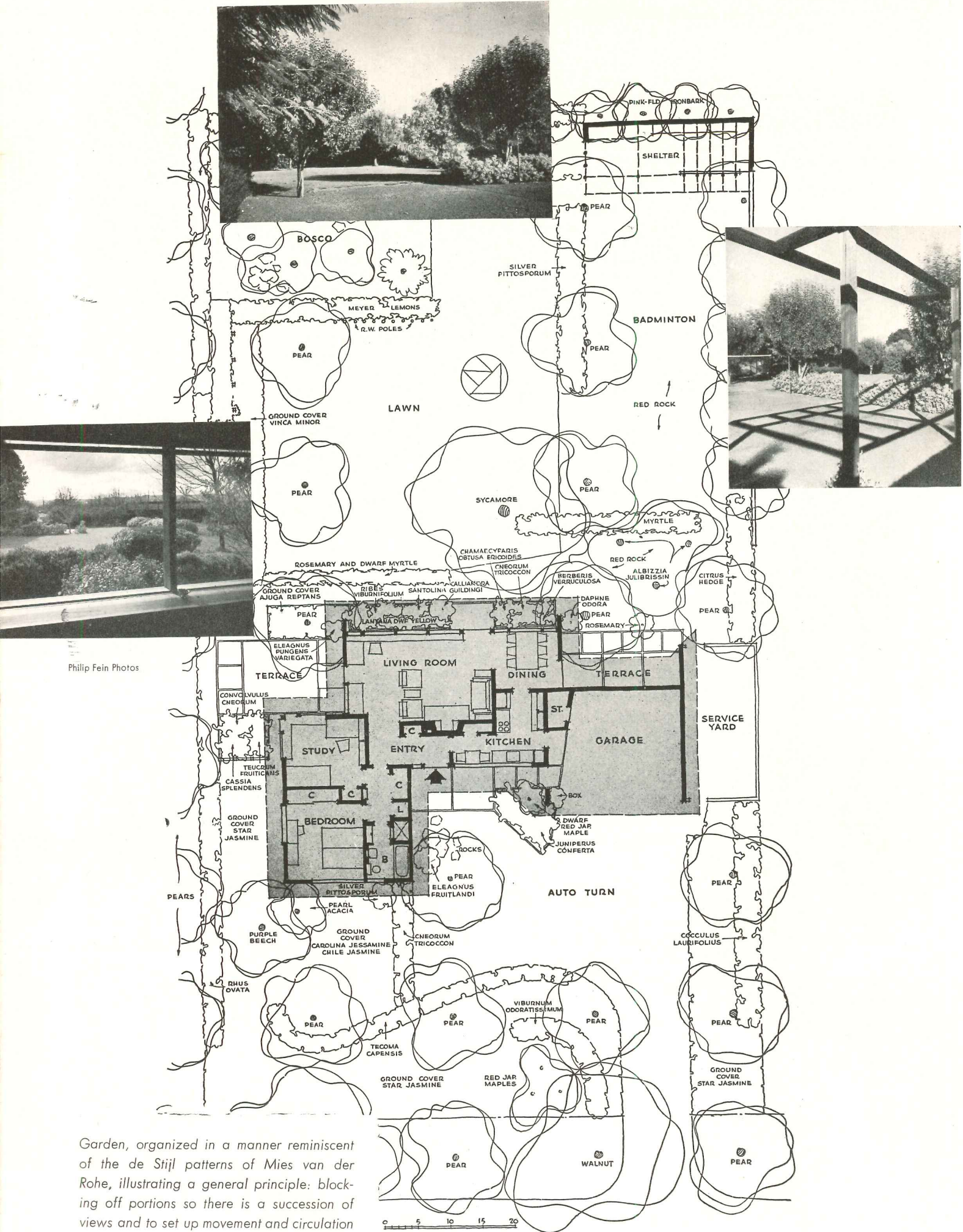

Philip Fein Photos

Garden, organized in a manner reminiscent of the de Stijl patterns of Mies van der Rohe, illustrating a general principle: blocking off portions so there is a succession of views and to set up movement and circulation

"Gardens, like houses, are built of space. Gardens are fragments of space set aside by the planes of terraces and walls and disciplined foliage. Until now we have defined too nicely the differences between that space which is roofed and within the house and that which is left outside and round the house. We did not see, until the architect threw down his walls, that the space of house and that of garden are parts of a single organism: that the secret of unity lies in a unity of spatial sequences. The new vision has dissolved the ancient boundary between architecture and landscape architecture. The garden flows into and over the house: through loggias and courts and wide areas of clear glass and over roofs and sun rooms and canopied terraces. The house reaches out into the garden with walls and terraced enclosures that continue its rhythms and share its grace. The concordant factor is the new quality given to space." — *Joseph Hudnut*

PEOPLE live ON the earth, ON the land, but IN the three-dimensional air-space, the atmospheric volume, immediately above this land surface. Plans and land-use maps may be measured diagrammatically and abstractly in square footage and acreage, but space for living is measured in cubage, in volumes of air-space enclosed or organized with tangible physical elements. The term "space" may be used scientifically by astronomers, demagogically by reactionary politicians, and abstrusely by artistic intellectuals, but to ordinary people it has an ordinary practical meaning — room to live in, to work in, to play in, to relax in.

Every piece of land which is set aside by legal property lines as being within the private ownership of some individual or organization is really a block of space, a volume of atmosphere, bounded by vertical planes projected from the property lines, with a third dimension adequate to include the development programmed for that land, whether it be a one-story house or a sixty-story skyscraper. The real estate, the land, is only the floor, the bottom side of this space for living. It provides a foundation for structures, a root medium for plants, a source of raw materials, but the volume above it is the primary element.

If the land has some irregularity or slope it has to that extent a third dimension which produces some sense of volume, determined by the vertical pull of gravity. Beyond that, every element, every rock, every hole or gully, every bush or tree, every wall or pole, every object alive or dead, moving or stable, produces a physical organization and definition of space, gives it tangible comprehensive form, encloses it, puts it under control, or puts it in motion around focal elements, all with tremendous variations in intensity, precision, strength or subtlety, and sensations resulting in the person or persons within that space. The land, the air-space, and the physical elements and materials on the land are all mutually interdependent — land and super-surface elements give form to space; space displays the form of land and elements. Space sensation very simply is the aggregate of all the physical sensations one experiences in a given place at a given time.

We live continuously subjected to spatial sensation, wherever we go, indoors and out, from birth to death. The experience of space is a common and vital human

experience, comparable to those of food, sleep, clothing, or sex. We all remember childhood and youthful experiences of pleasant and unpleasant spaces — backyards, sheds, attics, playgrounds, railroad yards, beaches, streets and alleys, basements — and their effect upon our growing awareness of, and attitude toward, the world around us. This sensitivity seems to get dulled, or submerged to the subconscious, as we grow older. Perhaps this happens because the spatial experiences of the majority of the population are quite poverty-stricken. The American scene — Main Street, urban housing, the standard residential suburb — has a general commercialized sterility which is far below the technical and esthetic potential of our culture. This is the richest country in the world, yet most of our buildings are badly proportioned, skimpily planned, and of a monotonous and deadly similarity. Even our architects tend to insufficient concern with spatial experience, and to dull, stereotyped, monotonous work. Our outdoor experiences are somewhat more varied, but there is the same tendency toward repetition of a dull and tired formula in streets, and in gardens and parks where they exist. Speculation in land and its chain of shoddy and miserly land use and space conceptions have produced the poverty of space for most American people, and the poverty of people for most American space, which is the basic contradiction of our environment. This is expressed statistically in terms of housing, slums, juvenile delinquency, fire risk, etc., and without statistics in a general neurosis, a general worry and hostility, jangled nerves, and the constant urge to get away from whatever place we happen to be in.

Space, beginning as necessity and ending as luxury, is one of the primary conditioners of human development. Measured in square or cubic feet per person, qualified by the character of its organization, it is one of the basic gauges of the quality of our living environ-



Extending space organization on a steep lot by projecting a trellis to increase security and heighten relationship of house to view

ment. A future science of the space we live in will establish standards for full American living which will be optimums rather than minimums (which quickly become maximums) — as, hypothetically, 1000 square feet for a two-bedroom house. The relation of such standards to the health of the nation has yet to be measured. Families with one or two children can be found living in any size unit from 500 to 15,000 square feet; most are probably living in less than 1000. How can we explain this spread in accommodation, save in terms of luxury and scarcity? — this conspicuous consumption of space by a few; the conspicuous consumption of the many by the inadequate space left over?

Artists and architects cannot escape the impact of such contradictions. The architect is led to concern with the contradiction between our advanced building technology and our advanced housing crisis, between the potential richness and the actual poverty of our general physical habitat, in his specific struggles with the contradictions between space and structure expressed as needs vs. restrictions, biology vs. cost, and so on. Thus we encounter rationalizations of the reduction, by economic pressure, of the \$10,000 house from 2000 square feet in 1928 to 700 square feet in 1948; houses have grown as they have become smaller; in them, many areas must serve several different functions.

While space concepts vary among modern buildings, they agree in general in being more open in plan and in exterior walls than traditional buildings. That is, they have moved from the concept of a building as a mass or block, with holes punched in the sides for light, air, and access, toward the concept of buildings as free and flexible arrangements of wall planes, some solid and some open, between floor and roof planes. The early work of Mies van der Rohe is perhaps the best example of this latter concept; it eliminated more preoccupation with facade and sculptural or plastic qualities than that of other leaders. Gardens and landscapes in general are apprehended only from within themselves; they do not have the outside walls or facades which still make it possible to walk around most buildings, however modern, and view them as objects, more or less sculptural, in the landscape. Only from an airplane or a high place can one view gardens or landscapes from outside themselves, and their scale changes radically in the process of getting so far above them.

### *Space Formation*

We are not here to advance rules or formulae for the new concept of space-form in the landscape. However, we can suggest the direction. The practical will become esthetic and the esthetic practical. The practical solution of almost any landscape problem will take the following steps: surfacing, enclosure, enrichment. Instead of concentrating on enrichment elements — pictures, "compositions," patterns, flower borders — we will tend to concentrate more on sensitive and imaginative selection and arrangement of enclosure and surfacing elements. Such concentration, while it establishes a framework or shell within which any amount of further en-

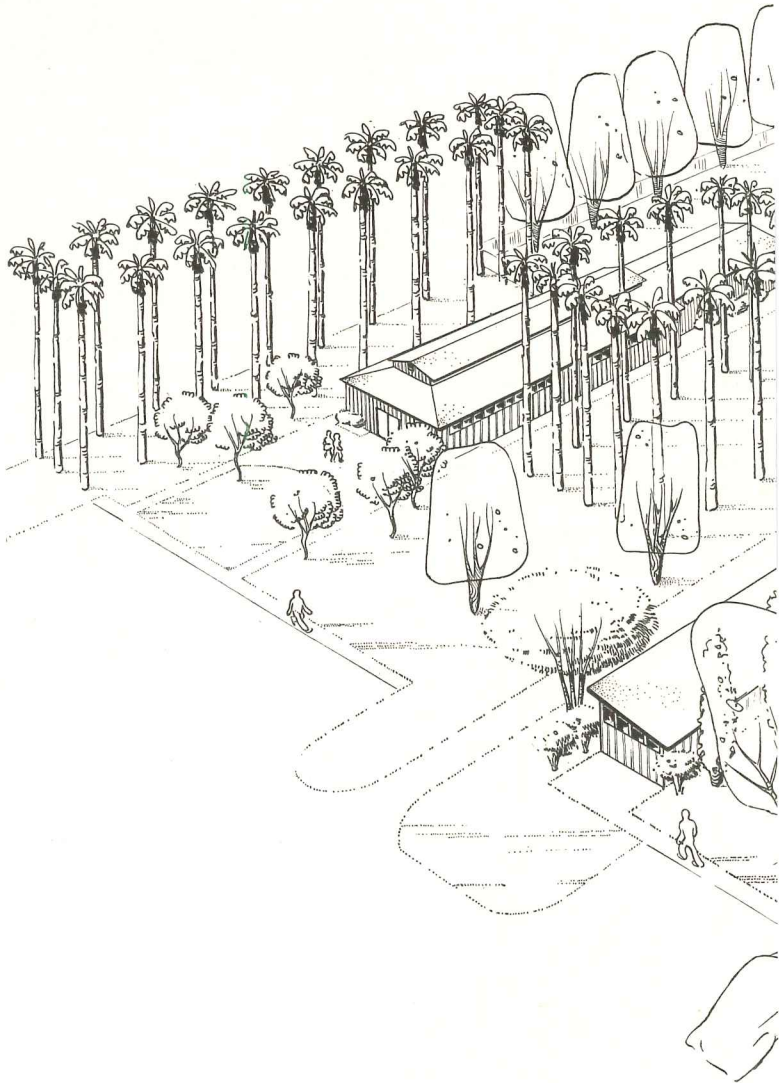

Top right: composition integrating a functional swimming pool with surrounding countryside by continuity of structural and planting patterns. Center: development for a community center, more complex than the standard open-meadow park, indicating potential variation in grass-shrub-tree relationships. Bottom: space organization for a small, level park; compare with garden, p. 70

M. Halberstadt Photo

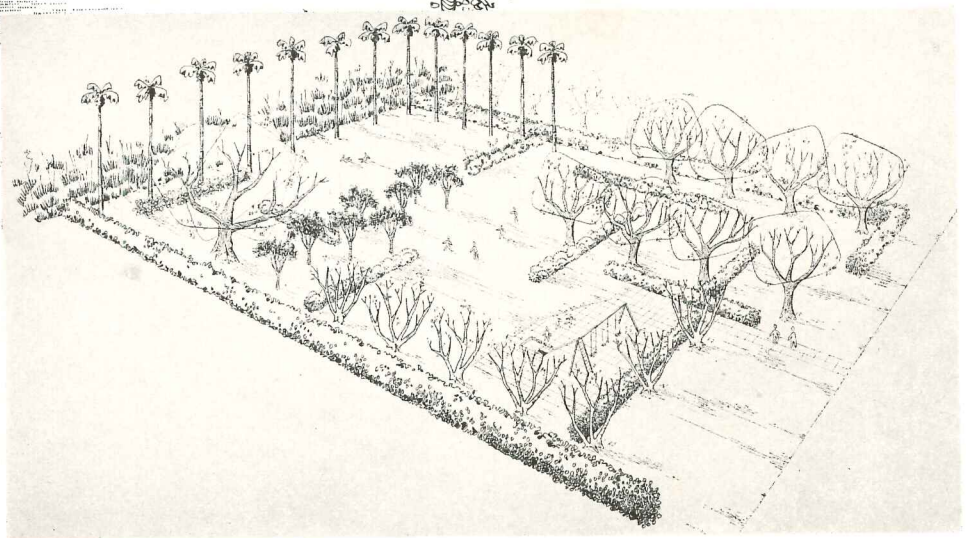
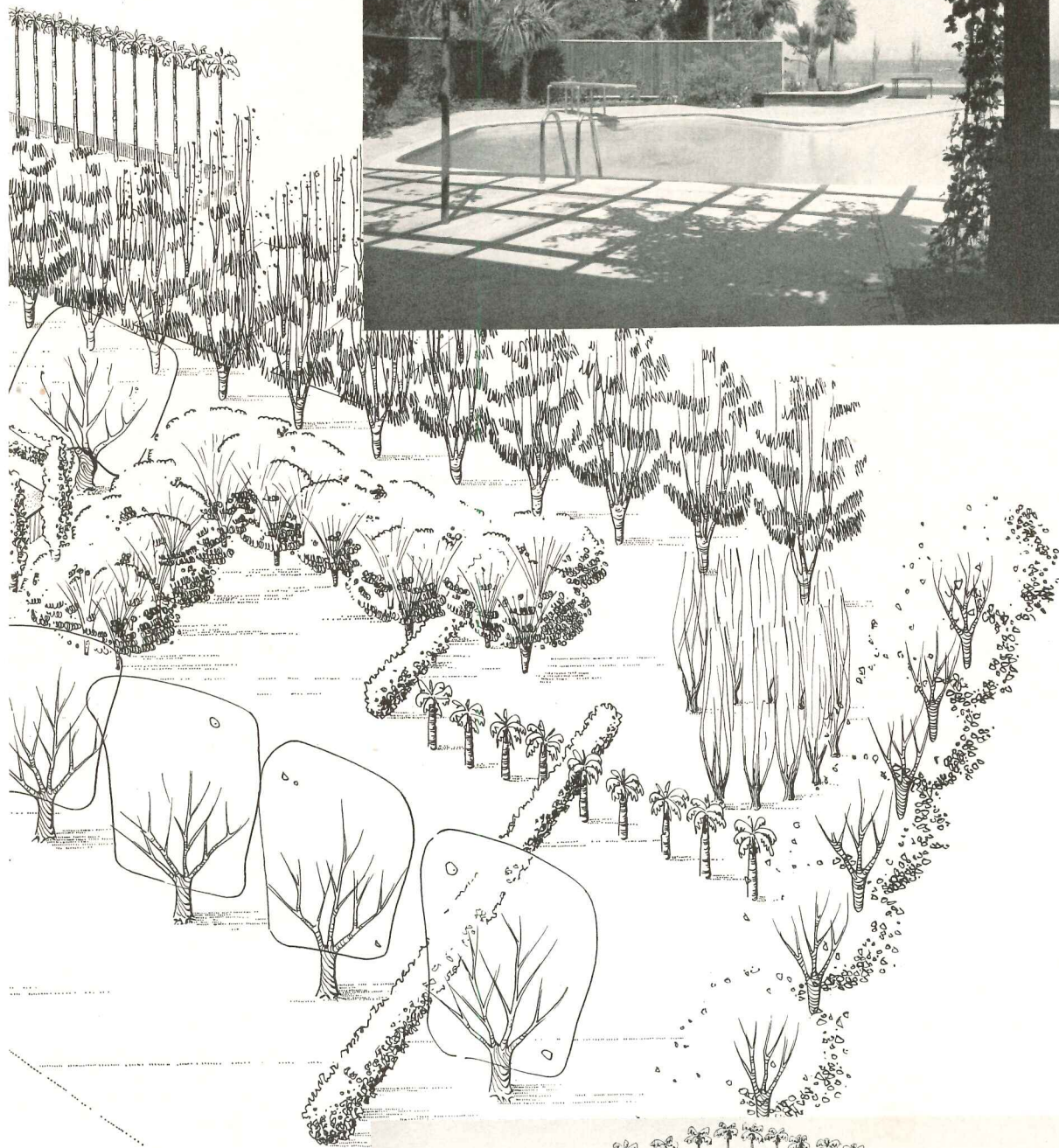
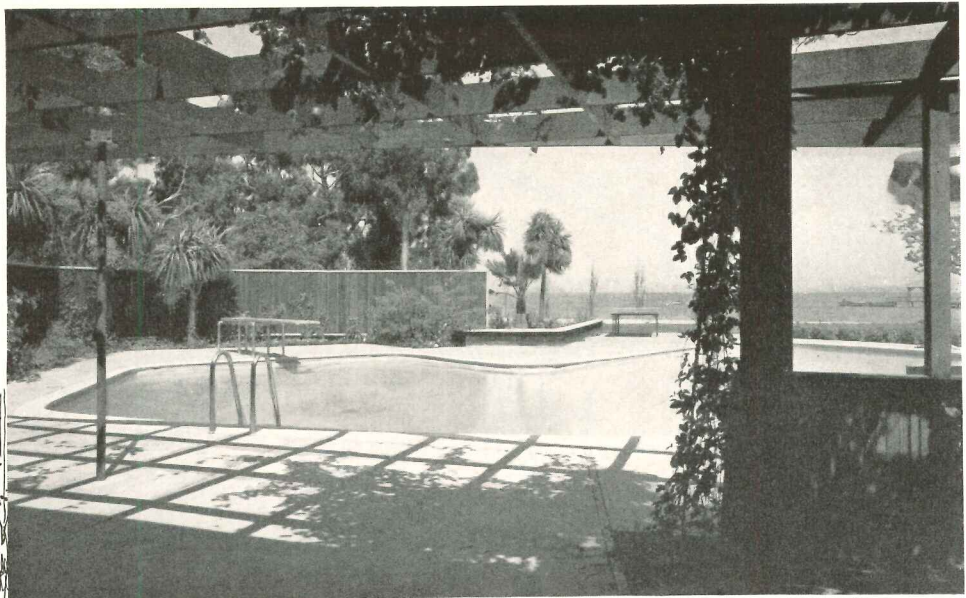

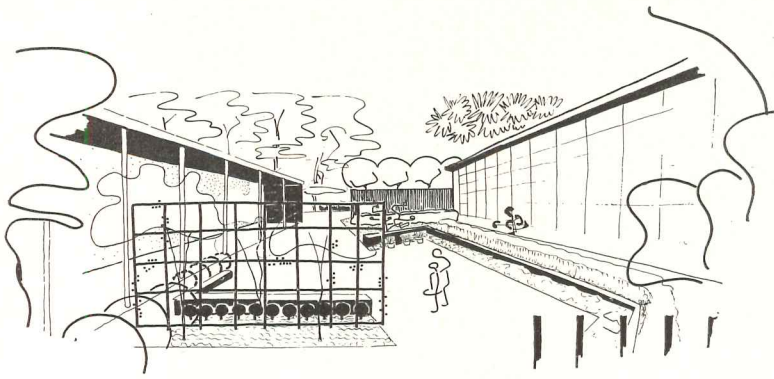

Left: refinement of long, narrow courts (here, in a college science building) by means of simple structural elements, improving three-dimensional proportions. Bottom of page: providing maximum visual satisfaction for patients confined in a long ward wing which has a continuous glazed wall. Typical of many contemporary buildings, this seems to demand a pleasant outlook from windows rather than a building setting to be viewed from the street

richment can be woven into the overall harmony, is equally satisfying with no more than the greatest enrichment of all — human life and activity. For a really full and well-rounded scientific art of space organization, outdoors as well as in, will proceed always with two primary ideas in mind. These can be contradictory or complementary as they are interpreted by specific designers in specific situations. One is the objective of giving the richest, most plastic, and satisfying form to the space which is being organized; the other is to concentrate always on that space as an arena, volume, background, and shelter for human life and activity. People

are its primary content; without them it becomes an empty abstraction, exterior decoration, excess gilding, as so many great historical gardens were. People are the focal points, the terminal features, the final vitality of any spatial enclosure we may create. That is why the open center may almost be called a principle of modern design.

#### *People*

People are seldom discussed, realistically and sympathetically rather than mechanically, as essential components or elements of theories of planning and design.

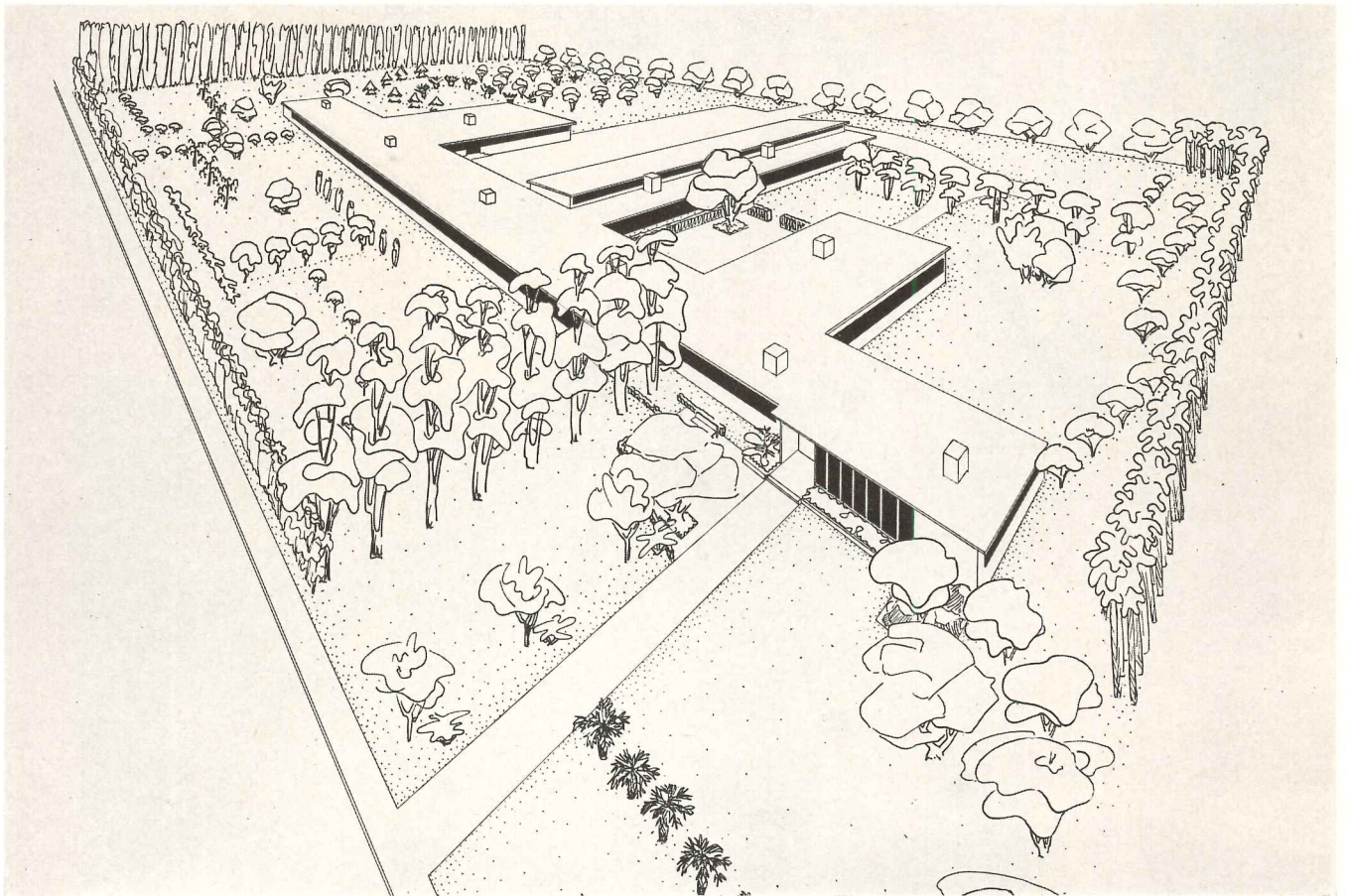



Yet it is useless to project a science and an art of fine and handsome space organization unless we project also fine and handsome people within that space. Nor can we project the expansion of this fine and handsome space organization throughout the greater part of the physical environment unless we can also project the majority of the population of that environment as being equally fine and handsome. If our concept of design is held on a higher plane than our concept of people, we introduce a basic contradiction into our work which will make it impossible to continuously broaden and enrich it.

Is art for art's sake, or for people? If the latter, is it for a majority or a minority? If the latter, which minority? If it is true that "landscape design can be truly appreciated only through the eye and mind which are trained to see and understand," \* how and by whom is appropriate training provided for our clientele? Is it only the individual private clients who get this training? How about the majority who experience our park designs? Do they require a course of training before they can enjoy them? Or do we reserve the finer concepts for the more understanding private clientele, and design down to the broad masses? And so on — each question begets another. Our work is done for people, to provide settings and surroundings for their life and activities. Therefore all its forms must relate definitely to the forms of people: to their size, their shape, the way they move about and relax, their requirements as to air, sun, shade, the way in which they perceive their surroundings, and so on. This observation may seem simple and elementary to the point of naïvete, until one looks about with open eyes and sees how seldom our environment is really formed to fit the simple and fundamental needs of the people who must live in it. If human life on an individual and dignified scale had been considered of primary importance by the most responsible citizens, our cities would never have become as congested, filthy, and sordid as they are.

Knowledge of such mechanical factors as eye-height, stride-length, and adaptability to sun and shade is not enough. People are not robots or sheep. They are all alike and yet they are all different. That is a remarkable thing when you consider that there are some two billion of them in the world. We must also understand their subjectivity, inconsistency, and contrariness, and the forces that make them greedy, intolerant, confused, mean, belligerent, irresponsible, cynical, or vulgar. We must realize that those qualities in adults are environmental rather than hereditary. We must be scientists as well as artists of the environment. From this will come a firm conviction of the basic decency, dignity, friendliness, and creativity of the vast majority. As we said in 1942, at the beginning of the great production of American war housing, every technician involved in developing environments for people is responsible not just for providing shelter, but also for developing their fundamental potential dignity.

\* *Landscape Architecture Quarterly*, July 1937



*Positive structural space formation, relatively large scale, bordering a wooded site. Curved solid screen gives a sense of enclosure; the "volumes of air space (are) enclosed or organized with tangible physical elements"*

FOR JOYOUS LIVING  
AND FIVE CHILDREN

*Ralph S. Twitchell and Paul M. Rudolph, Architects*



Ezra Stoller Photos



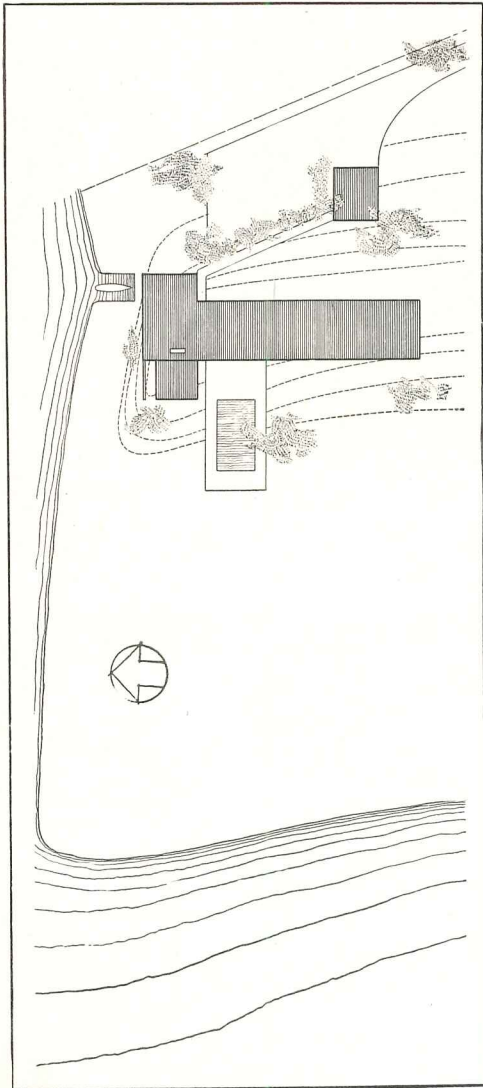
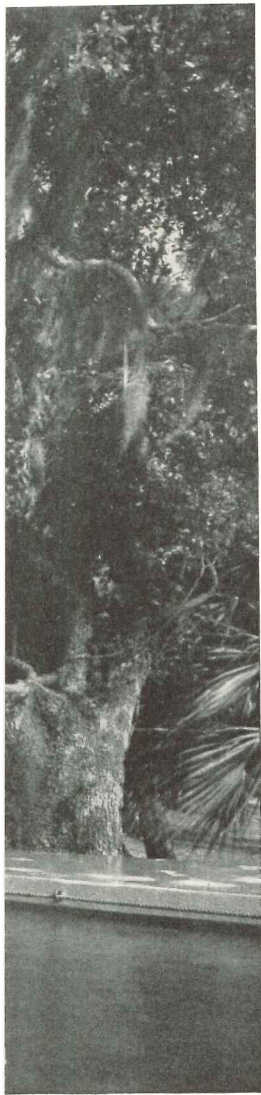

ONE could use all of the familiar words of modern architecture to describe this house, but they all seem too cold. Something like "functional design for living" is too flat a phrase to describe the bubbling joy of five small children in this house, or the cordial family harmony so positively fostered by this plan.

Take for example the site development (at the left). The combination of pool, house and boat landing proclaims a scheme of living in which fun and sports take precedence over formal pretentiousness. And the house settles under the trees comfortably and without self-consciousness.

Or take the family living areas shown on the next two pages. This is as thoughtful an arrangement of space as has been seen in many a year. Here again the planning vocabulary is too cold. The kitchen-dining space combination bespeaks not only utility and informality, but a hearty family gathering at mealtime. The living room, though not at all stiff in itself, nevertheless carries a suggestion of more orderly gatherings. One of the architects casually referred to the dining room as the "winter living room," and explained that the more open living room might seem chilly in cold weather, but the subtle differences between the two rooms are not mere matters of climatic temperature. And one ventures the opinion that as the children grow older these temperamental aspects of the two rooms will be more and more appreciated. Also, when the parents tire of the record-player they may either banish the children to the lanai, or retire themselves to the quiet of the study, which is just behind the dining room fireplace.

The lanai (photo, page 80; plan, page 81) is an open, screened, widened bedroom corridor which is really a children's activity pavilion with scope for indoor rolling stock. There is, incidentally, a true children's garage on the lower level just under the kitchen, the real parking place for outdoor rolling stock (it may be seen in the photo on the front cover).

As an example of architectural design the house is quite deserving of all of the words, too — it uses materials appropriately, it has an interesting structural system, it is free and honest and expressive. But surely all these things pale beside the success of the house as a parti for family life. This is no "machine for living"; it is functional architecture, but you must drive the word pretty hard to make "functional" mean as much as it does here.

Residence for Mr. and Mrs. Maynard E. Russell

Sarasota, Florida

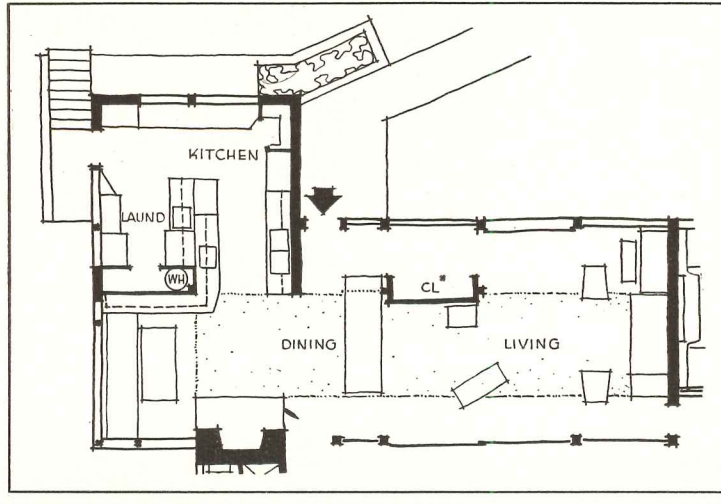

*The laundry and kitchen combination is quite good, but its success in efficiency is nothing to the success of the dining room as an invitation at mealtime. Here a father and five children have room, and welcome, for a gathering before, during and after meals, where mother may win help as well as friends. After meals the activity can flow easily into the living room, or beyond to the lanai, or it can burst right on outdoors. The wall (extreme right in the photo strip) is merely screening; living room and bedrooms can be closed against chilly weather with sliding glass doors*

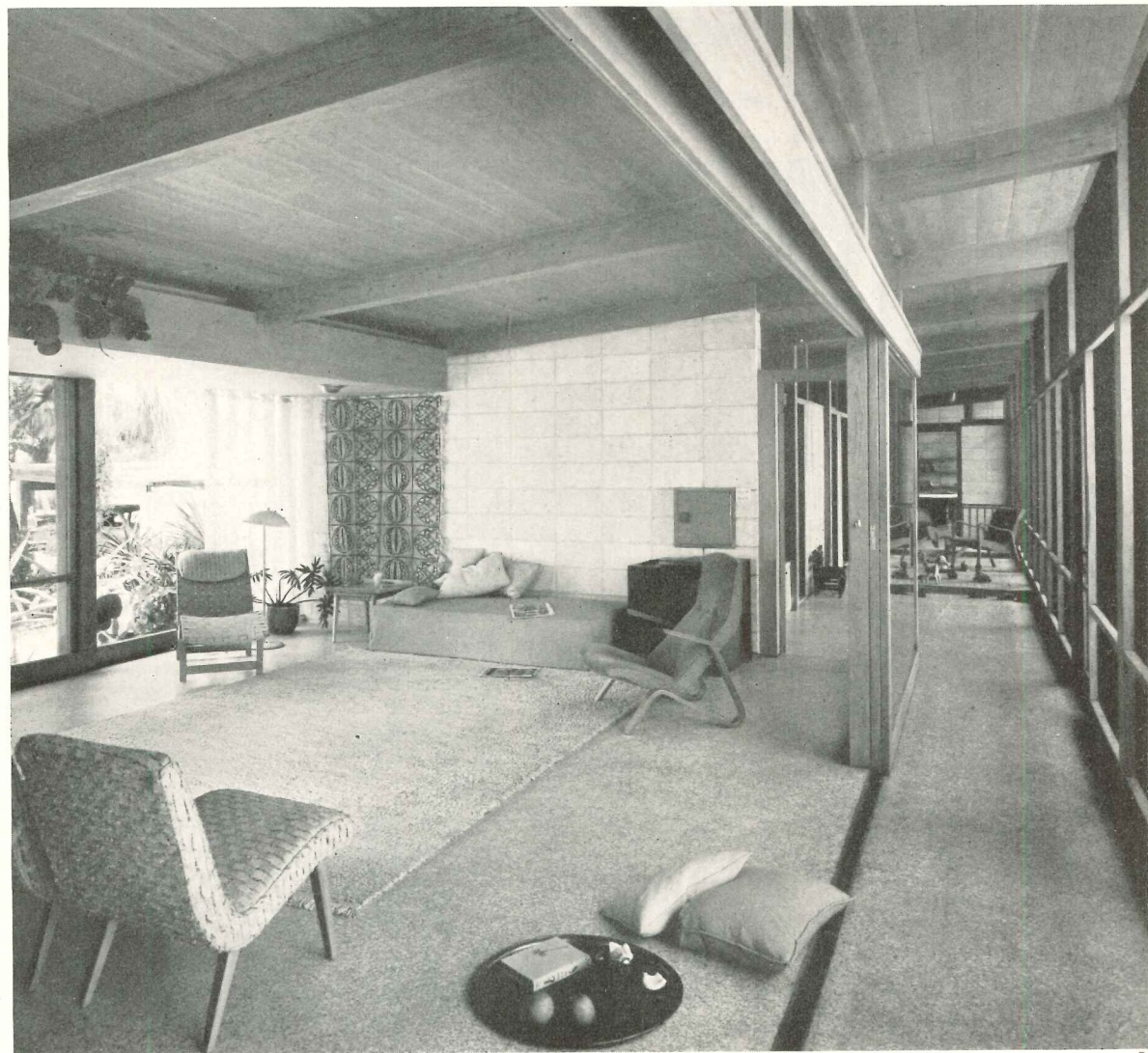
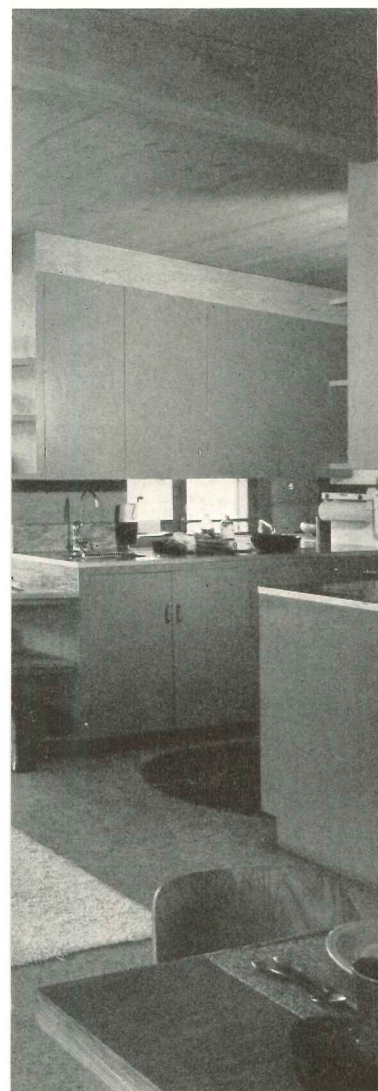

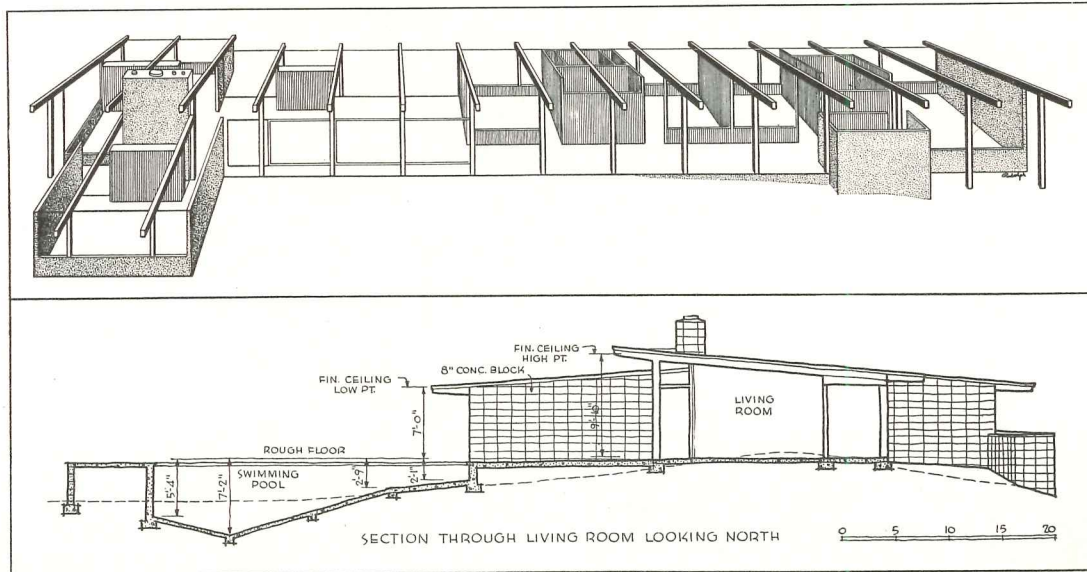

Structural system (upper drawing) is essentially mill construction with 6 by 8 posts and beams, and 2-in. planking roof covered with 1 in. insulation and built-up roofing. Interior columns, also 6 by 8's, run in the line of the bedroom walls; at the living room the system changes to 4 by 6 posts at the glass wall, with other interior posts at the closet. Though the site is an old Indian mound (see section) the land is low and ground water level high; thus house and pool were set at highest point. Not shown on the plan is a play yard for small children under the kitchen window, near boat landing. Under the kitchen at this point is a true garage, not for family cars, but for children's rolling stock. East wall of house is mostly glass, west wall is just insect screening. Masonry walls are all exposed concrete block

Ezra Stoller Photos

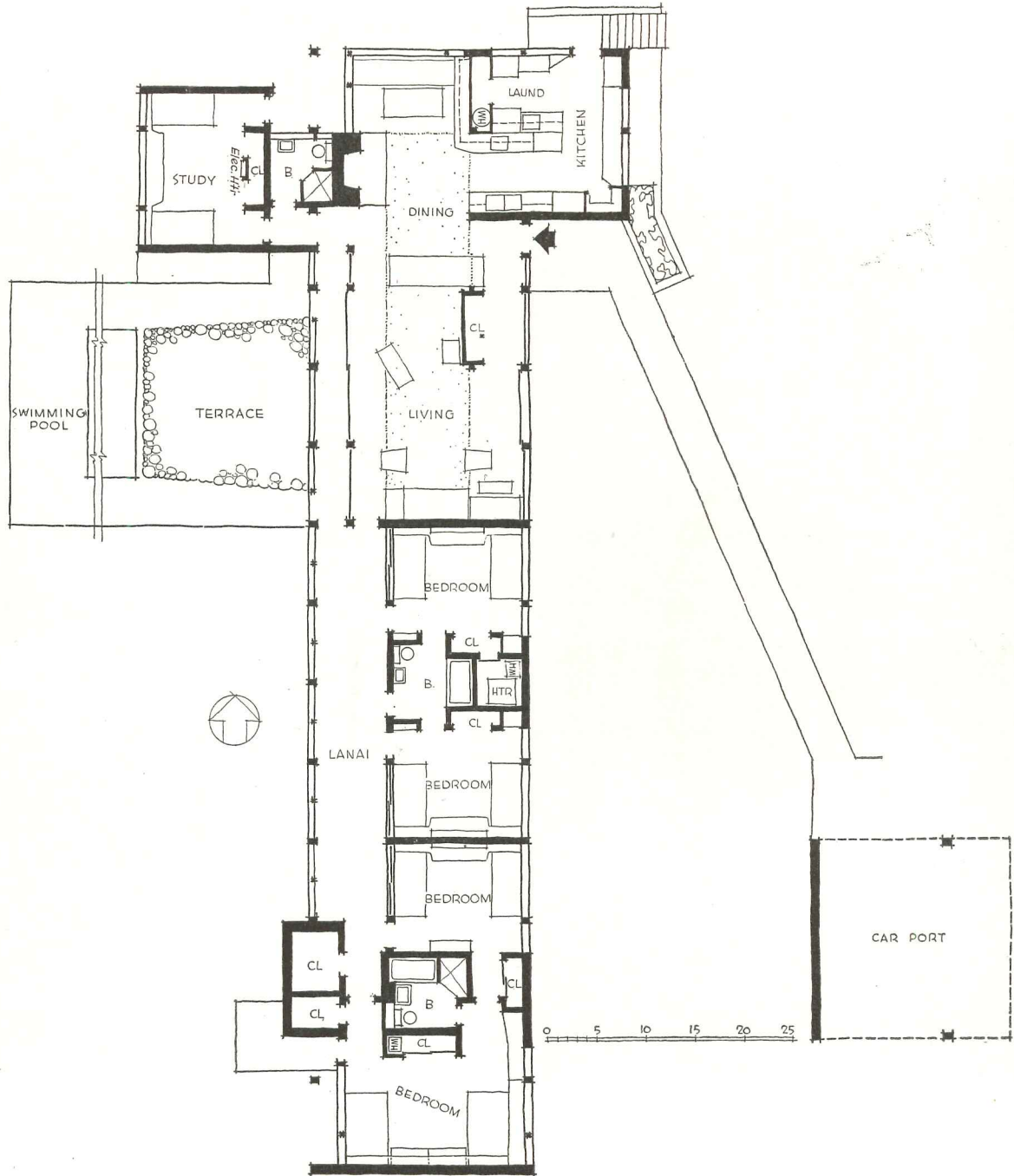
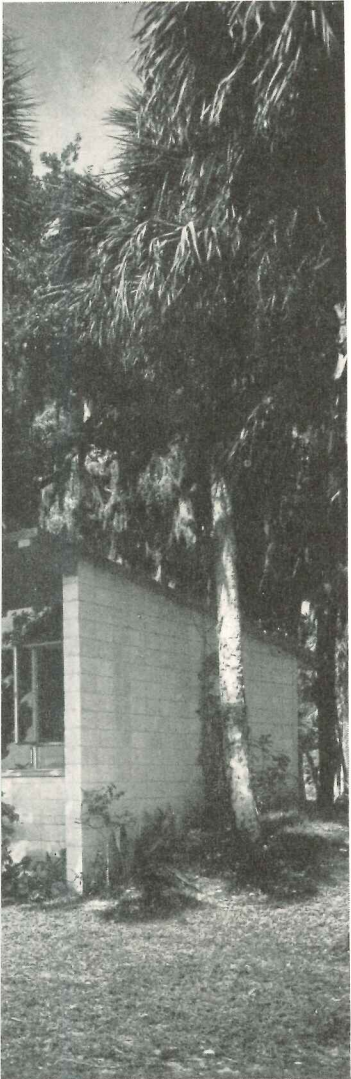

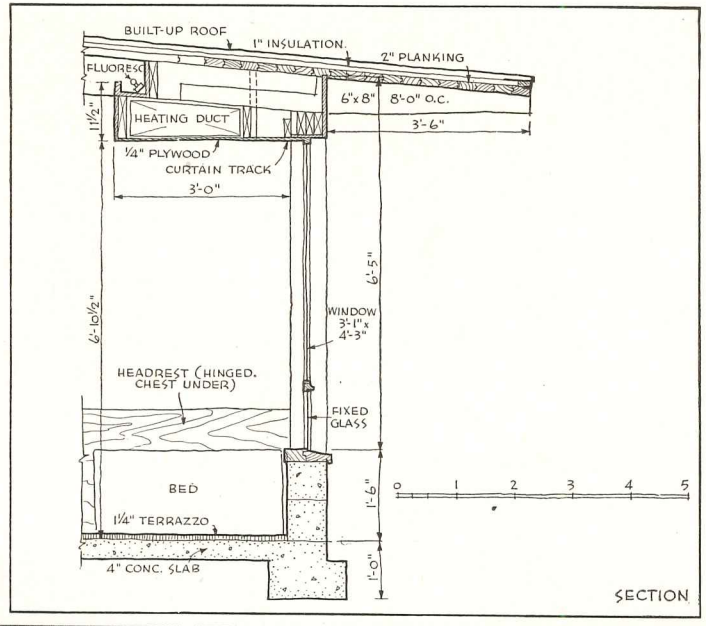

Joseph Janney Steinmetz Photos

Ezra Stoller Photos

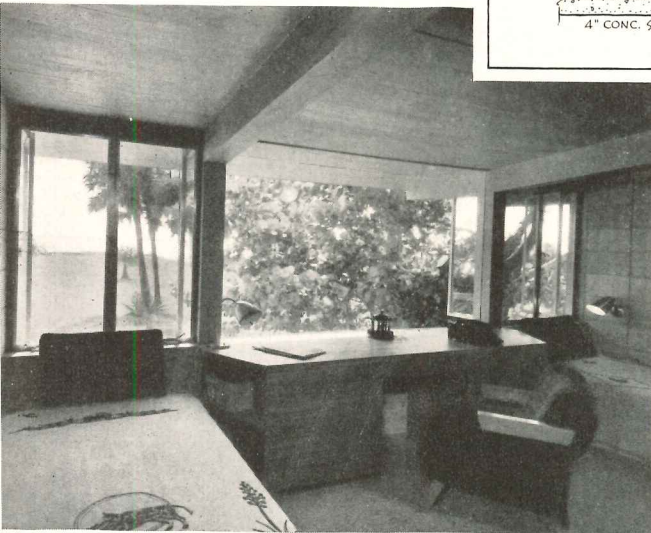

Heating is by forced warm air (see section above) with ducts in an enclosure at the ceiling which is also used for fluorescent lighting cove. Section is at study wall; note in section and in photo just below it the hinged headrest for beds, with chest for covers under headrest. Photo below, left, shows one of children's bedrooms; each child has built-in desk beside his bed. Center view shows east side of house, carport in foreground. Photo on opposite page shows same side, as seen from front entrance



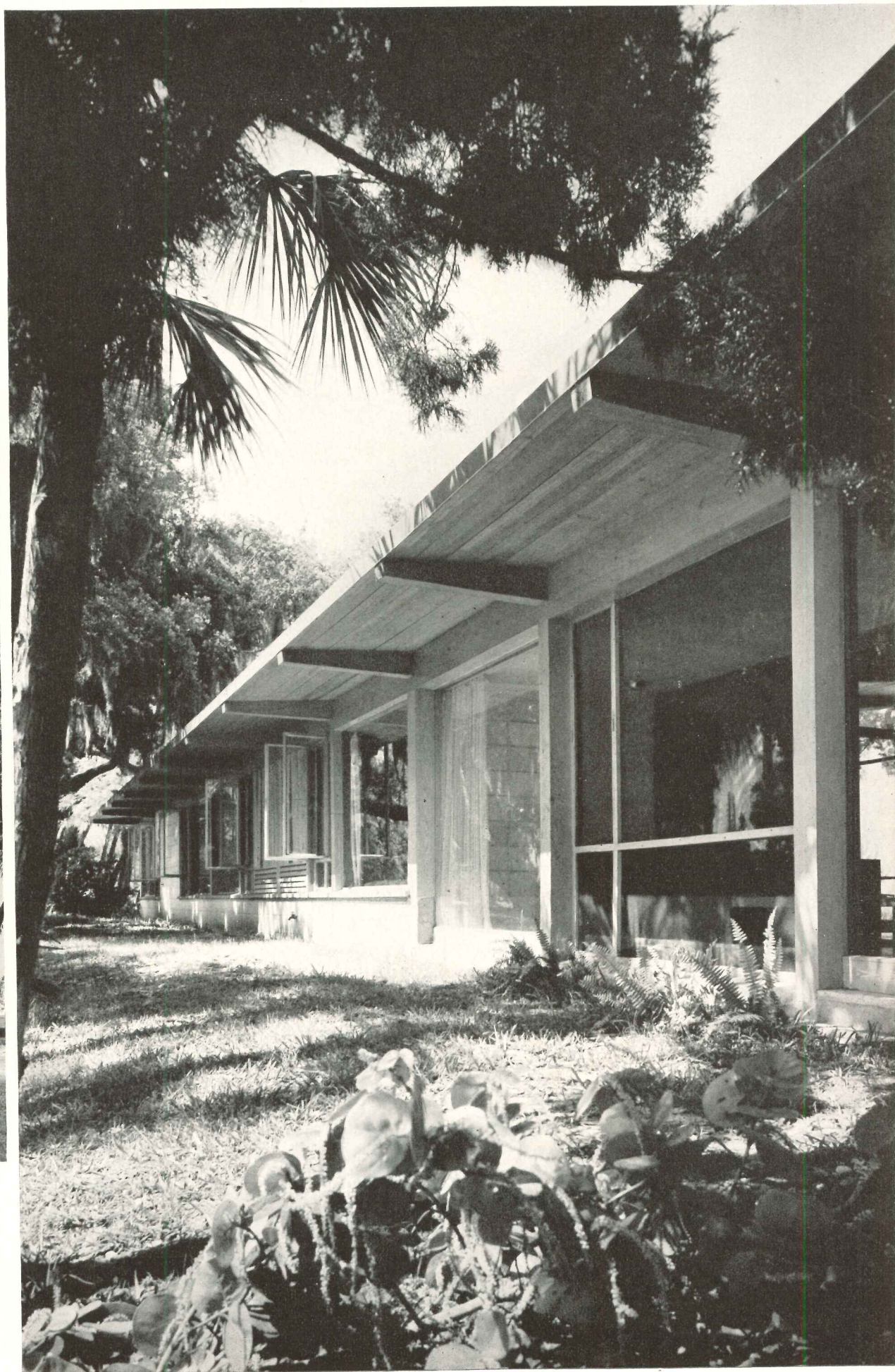

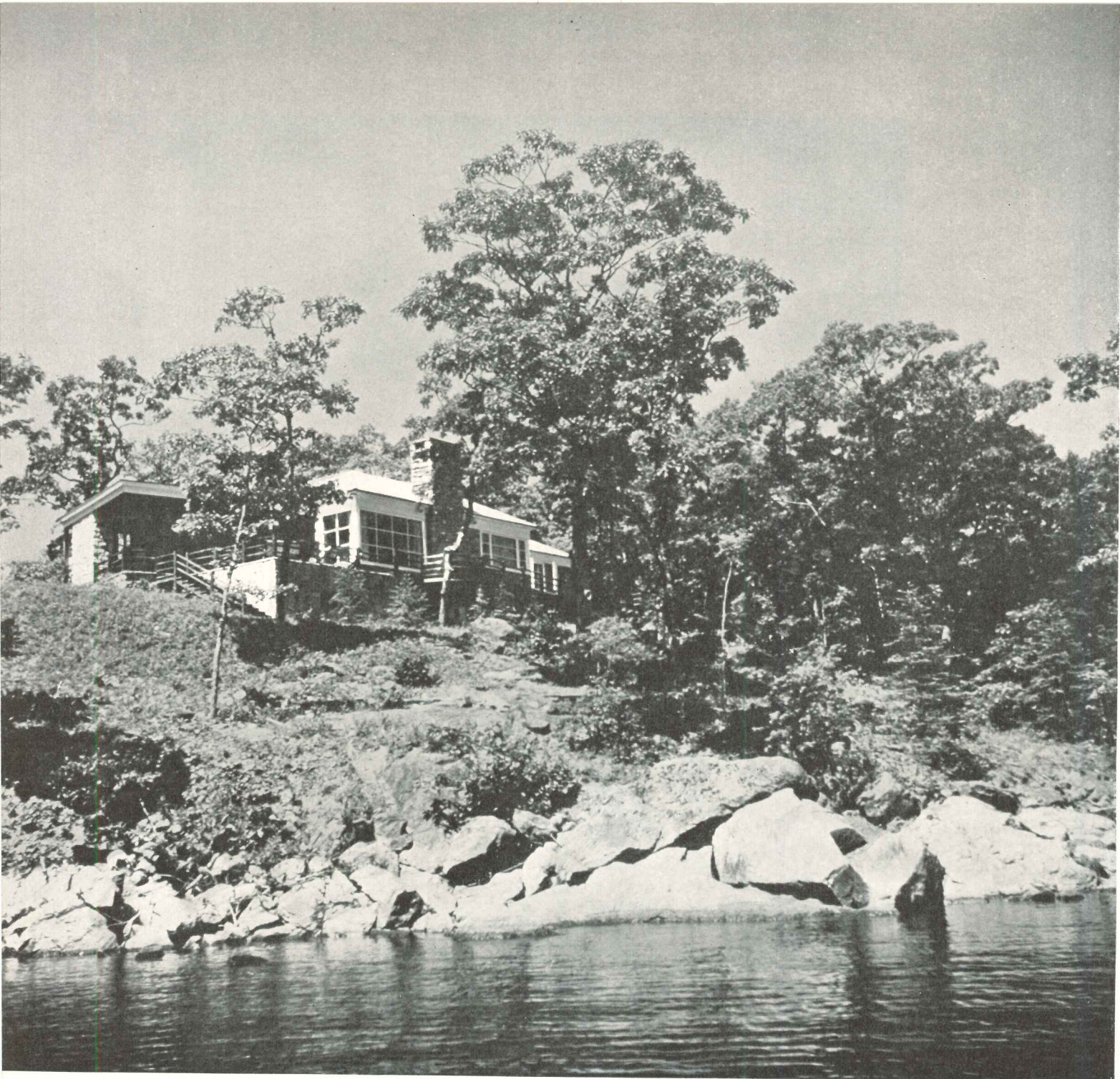

Geoffrey Baker Photos

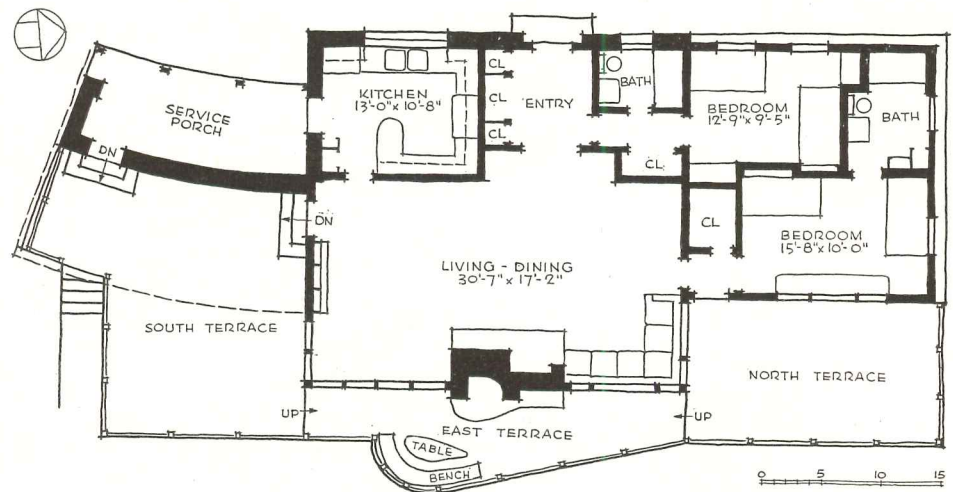

# DESIGNED FOR VACATIONS

Hunting Lodge and Summer Cottage for Mrs. William P. Palmer, Jr.

Blue Hill, Maine

*Louis Gelders, Architect*

*Rosemary Dudley, Inc., Decorator*

**A**LTHOUGH intended primarily for vacation use, this Maine hunting lodge and summer home is a far cry from the casual rustic cabin of former years. Sturdily built, fully insulated and heated, it could serve equally well as a year-round residence. Rocky terrain, a magnificent view, a cool climate and the owner's requirement of ample provision for outdoor living were the chief factors influencing its design.

The site, as the photograph on the opposite page shows, is rocky and drops sharply to the water. The view is a wide one (see next page) across Blue Hill Bay to Mt. Desert. To blend in with the former, the house

was given an exterior of native granite veneer of selected pink and beige, white pine flush siding stained a warm rose, white trim and a red cedar shingle roof. To take advantage of the latter and to fulfill the owner's outdoor living requirement, orientation toward the east was chosen, and three separate but connected terraces were ranged along the entire east side. The cool Maine climate dictated a sheltered south terrace and a plan which would make full use of the summer sun. In accordance with the owner's request, the combination living and dining room was made unusually spacious and the two bedrooms were held to an absolute minimum.

*Although the house turns its back to the land (opposite page), its main entrance (right) is perforce on the land side. An unusually large service porch not only gives direct access to kitchen but also links road with south terrace and shore*





Geoffrey Baker Photos

The huge living-dining room (right and across-page) has built-in book shelves and storage cabinets and windows on three sides as well as direct access to both north and south terraces. Each of the two bedrooms has its own bath, and closet space is unusually generous for a summer home.

Since the house is used in spring and fall as well as in summer, it is insulated with rock wool and has a forced warm air heating system. Floors throughout are cork tile; walls are plywood; ceilings, plaster. Terrace flagging is stone. The kitchen is all-electric.



**Opposite**

The large south terrace is well sheltered and offers direct access to the water

**Right, above**

The master bedroom faces the morning sun and has a superb view across Blue Hill Bay

**Right, below**

As befits a hunting lodge, build-in gun cabinets flank the archway between entry hall and living room

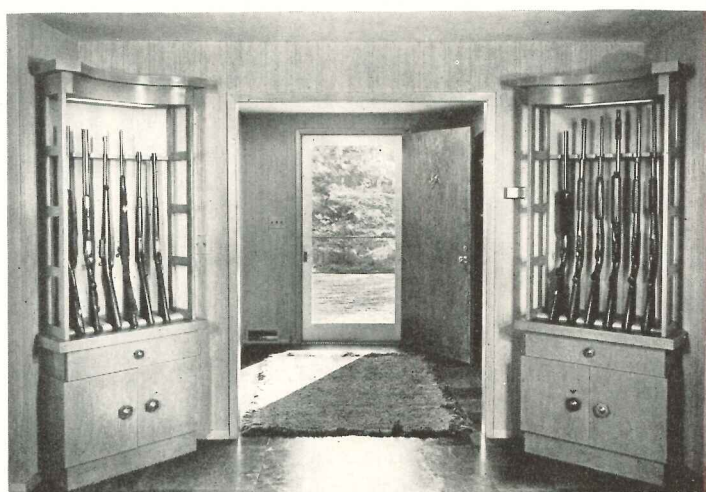
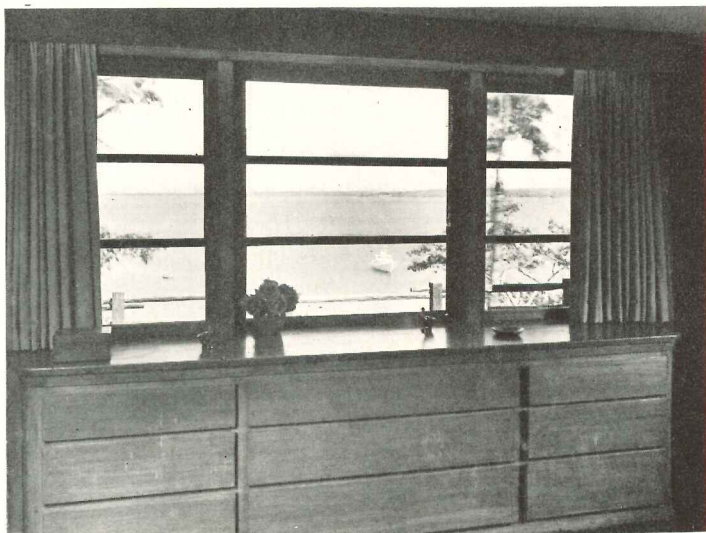



Haskell Photo

# PLANNED FOR RESEARCH

Laboratories and Offices, National Research Corp., Cambridge, Mass.

*Perry, Shaw and Hepburn, Architects*



Haskell Photo

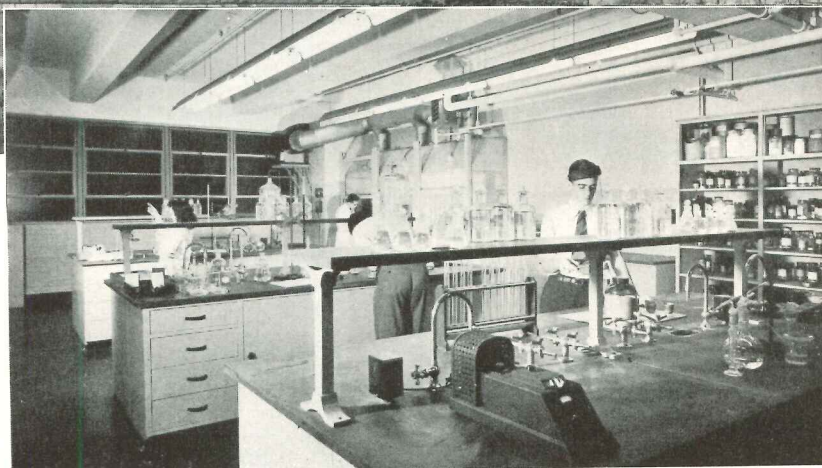

Paul Davis Photo

*Analytical section of Chemistry Laboratory*

**A** BUILDING designed specifically for industrial research can be expected to reflect certain intrinsically complex functional requirements. This laboratory building for the National Research Corporation, however, reflects certain other requirements as well.

The site of the building, in the first place, on Memorial Drive be-

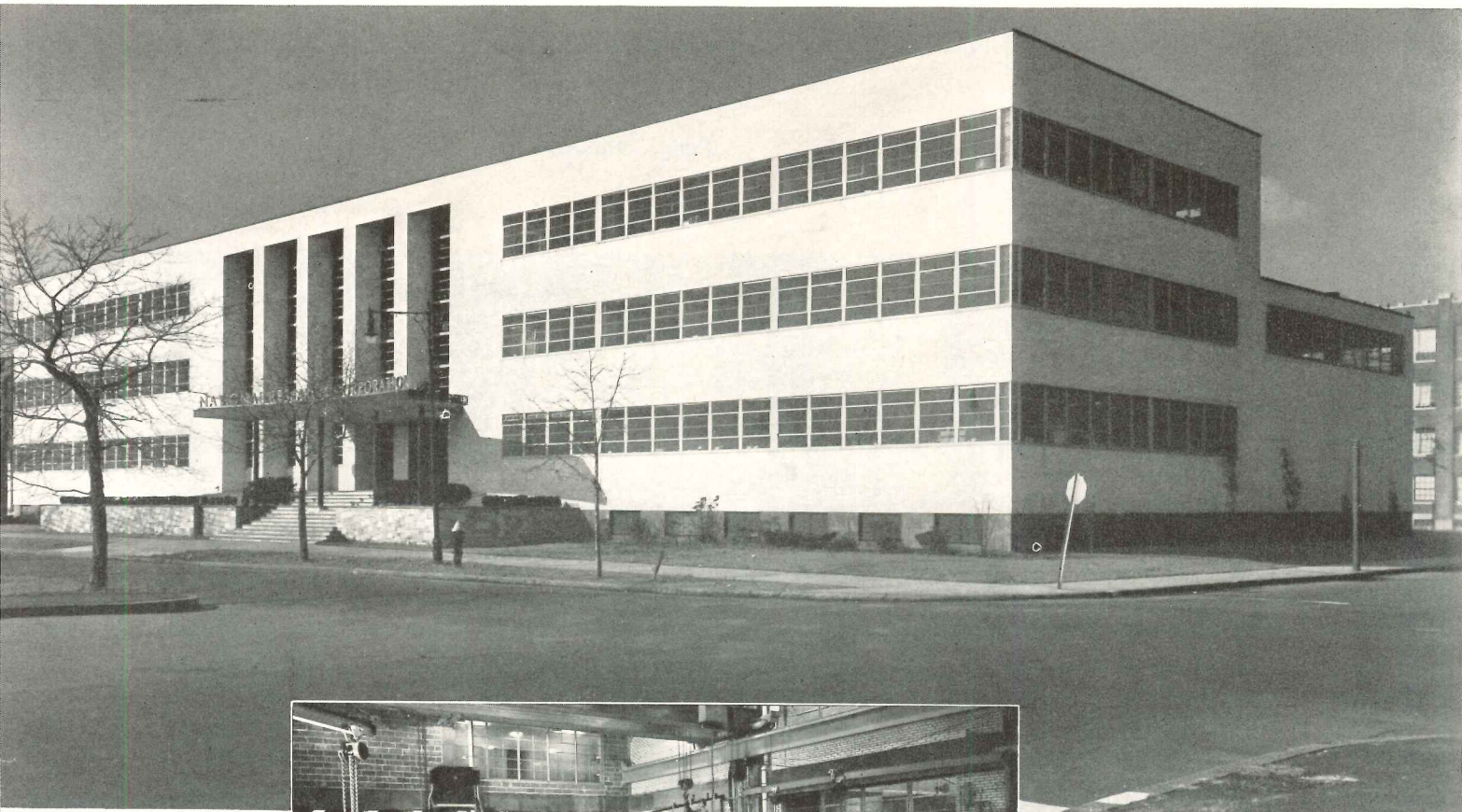

Haskell Photo

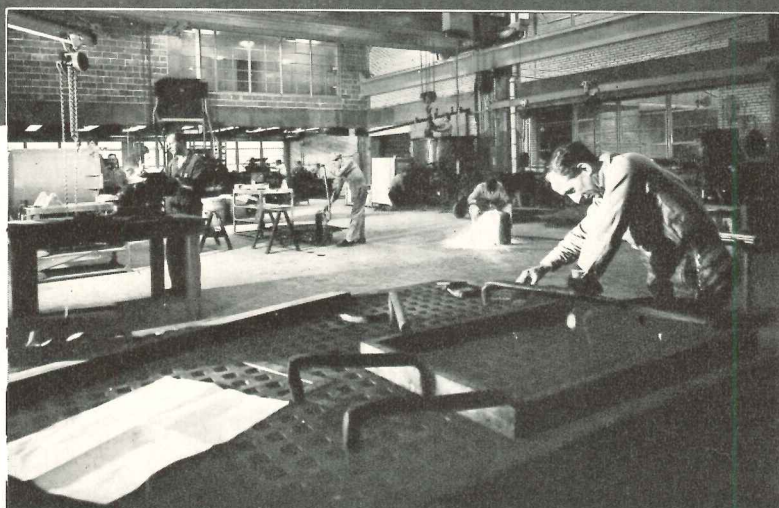

*Welding and heavy assembly*



*Machine shop*

Paul Davis Photo



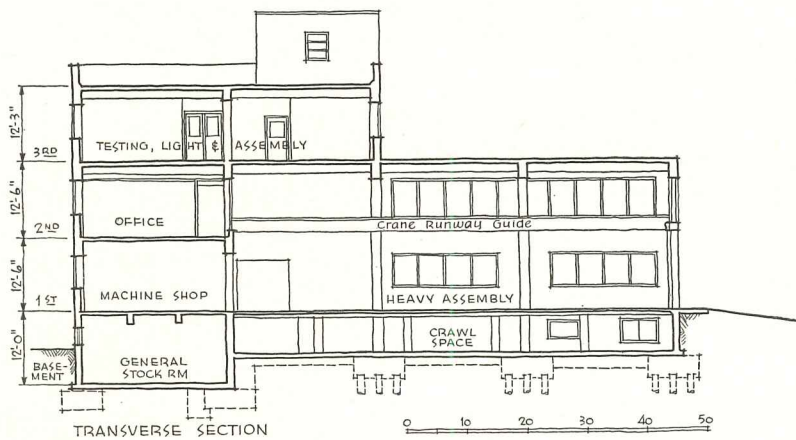

Framing of the building is steel, with exterior walls of brick. Offices in central portion are marked on front facade by broad pylons (opposite page). Building is planned for future expansion into a hollow square, completely enclosing the present lot

tween Massachusetts Institute of Technology and the Lever Brothers offices, was selected, the architects explain, because that portion of the Drive is known "as Research Row, on which is located one of the largest concentrations of research laboratories in the world." The appearance of the building, furthermore, was planned — again in the architects' words — so that it "would add prestige to the company and live up to the quality of the near-by buildings." Location and surrounding structures, therefore, had a definite influence on the form with which the function was to be clothed.

The work of the National Research Corporation called for three main types of accommodation: research laboratories; administration and engineering offices;

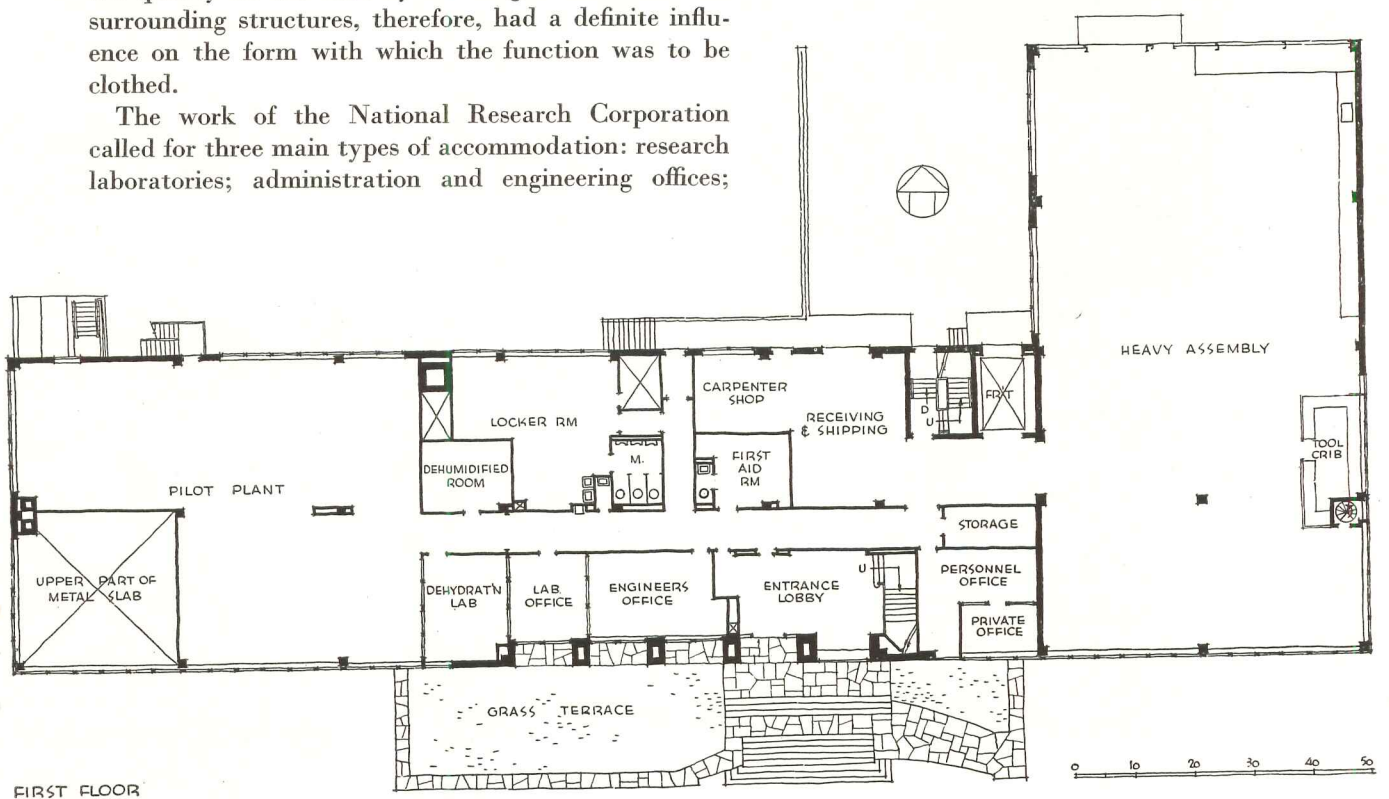

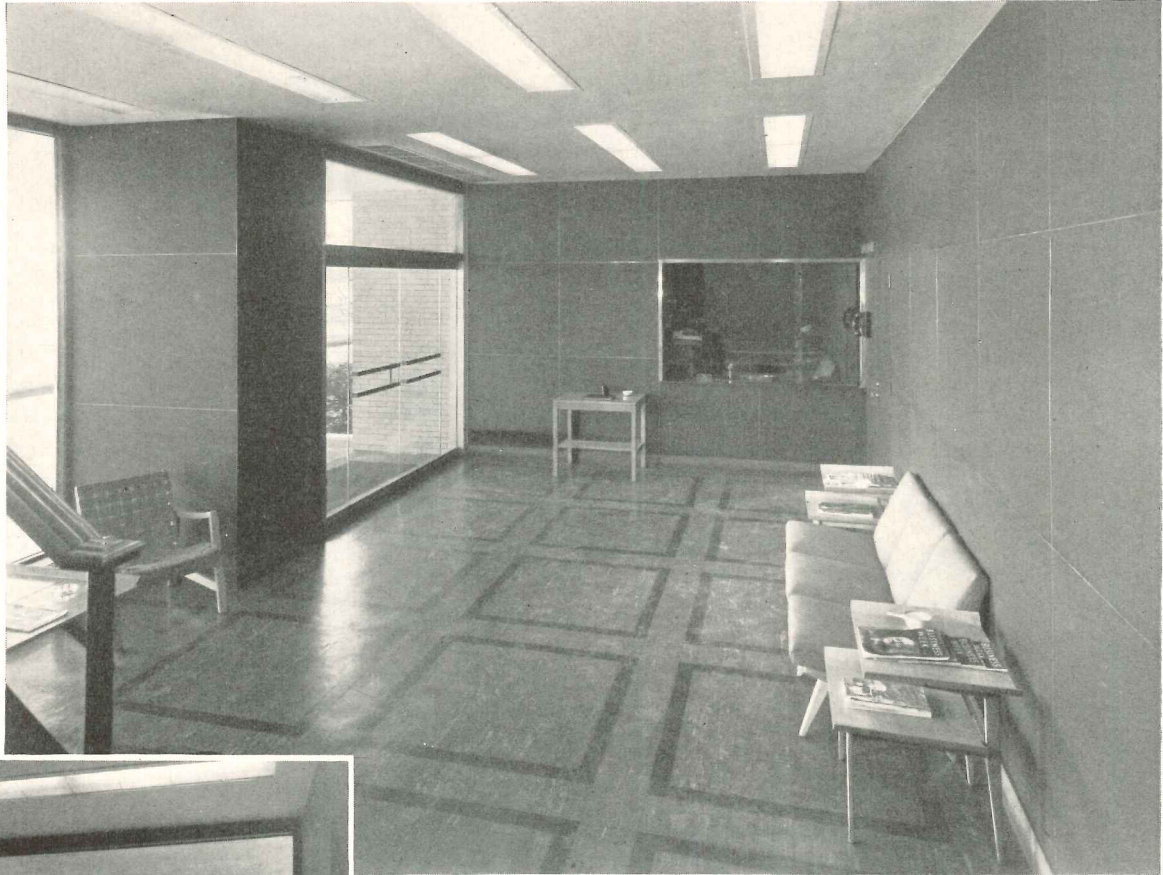

Lobby above, left and opposite is spacious and centrally placed; walls are linoleum-covered; lighting is fluorescent. Stairs lead directly to main offices on second and third floors

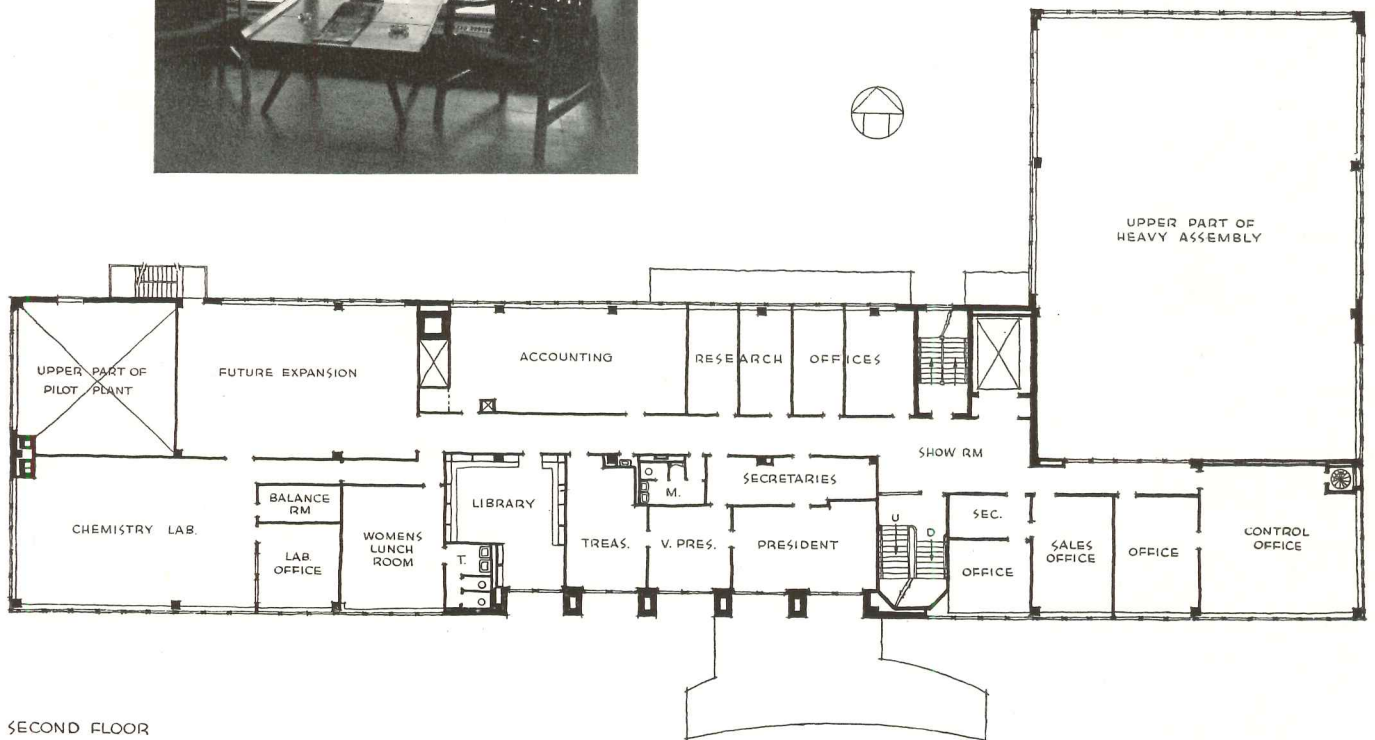

SECOND FLOOR



pilot plant and assembly manufacturing. Each of these specific but interdependent functions was allocated a separate portion of the building. Research laboratories, starting with heat treatment and metal furnaces in the basement and progressing upward through physics and chemistry laboratories, occupy the west wing. Accommodations for personnel executives, executive and designing engineers' offices, library, drafting and accounting departments are provided in the center. The heavy assembly plant and machine shop combined take up the first two floors of the east wing, topped off by the supervisors' offices and the light assembly area on the third floor.

*Beacon Piping Co., Heating and Process Piping*

*P. J. Riley & Co., Plumbing*

*Lord Electric Co., Inc., Electric Work*

*Jackson & Moreland,  
Structural and Mechanical Engineers*

*Thomas O'Connor Co., Builders*

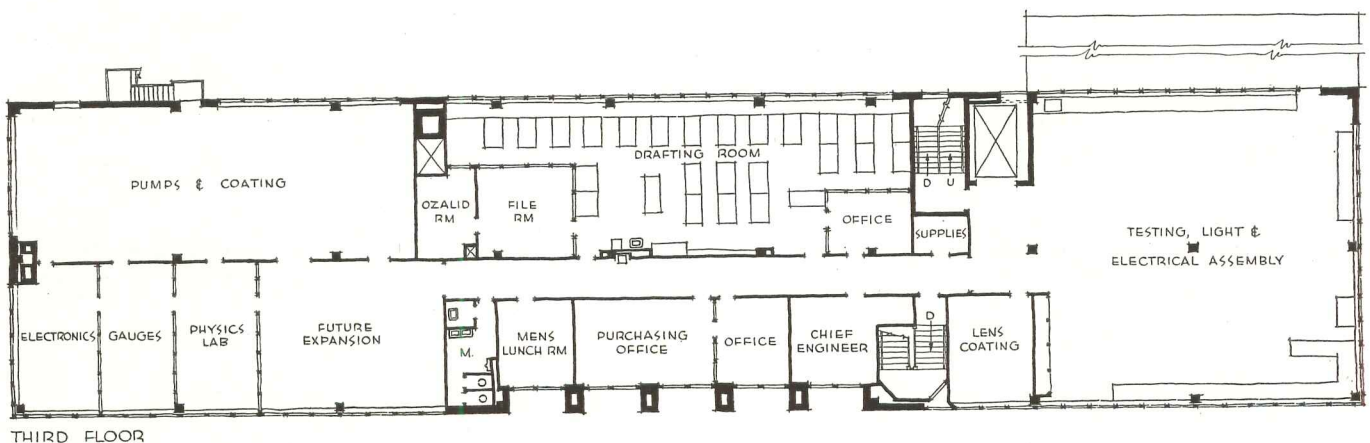

THIRD FLOOR

# SMALL BUSINESS BUILDINGS

Frederic Arden Pawley, Architect

The RECORD has published annually many studies of tall office buildings.\* This year we decided to examine smaller types of more general interest to architectural offices located outside major metropolitan areas. Potential volume of new buildings for the country as a whole will be greater in this class of structure in the multi-story class. Six stories, through an arbitrary limit, seem appropriate and the range downward includes the one-story taxpayer.

OCCUPANCY types vary enormously in general-purpose buildings. There are few design and planning factors common to them all. The appended bibliography shows an extensive literature on office-planning space standards which will be reviewed briefly herein. Perhaps this intrinsic variety suggests a primary design principle — flexibility is mandatory. Ground floor space will usually house retail, showroom or other occupancies requiring easy public access. Rear areas may possibly provide public commercial recreation or entertainment facilities. Each of these is regularly treated as a sub-

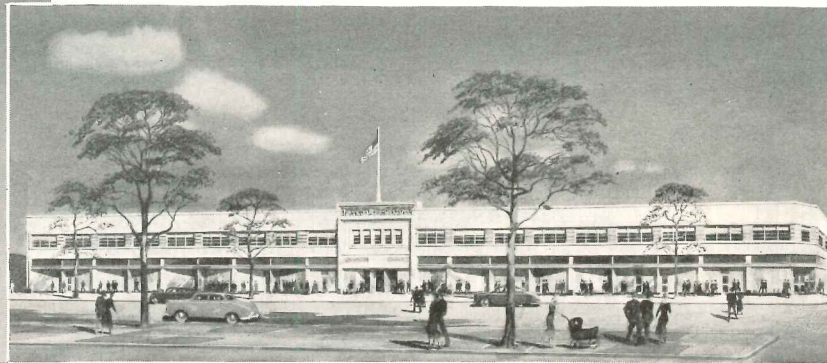

Left, Remington-Rand Bldg., Philadelphia; Thalheimer & Weitz, Archts.; C. V. D. Hubbard photo. Above, American Home Bldg., Queens, N. Y. (S. Minskoff, owner-builder), Boak & Raad, Archts. Facing page, Technical Instrument Co., Houston, Tex.; Mackie & Kamrath, Archts.; Mears Studio photo. Interiors, top to bottom: office, Remington-Rand, Dallas, Tex., G. L. Dahl, Archt.; own drafting room, Page, Southerland & Page, Archts., Austin, Tex.; board room, Merrill Lynch, Pierce, Fenner & Beane, Orlando, Fla., James Gamble Rogers III, Archt.



(\*See Bibliography references: 44-51)

ject for a Building Types Study in itself. Consequently, in this article, emphasis will be on the building as a whole.

The architect must coordinate, in a commercial building project, many correlative and often divergent points of view. To sell his own services he must be acquainted with preliminary and operating procedures. To this end we have consulted experienced real estate men, lenders of construction and permanent funds, building managers, maintenance experts and corporations who are tenants with national experience in leas-

ing office space. They have generously contributed data for the following pages.

It is equally important for these factors in the building industry to understand the architect's point of view and to recognize the financial as well as esthetic benefits of his function of comprehensive coordination. The essential fact is that commercial buildings are not well designed unless they are continuously profitable.

This ideal result, a continuously profitable building, is a complex product of intelligence applied to the following problems:

PROBLEMS:

location  
climate  
orientation  
local conditions  
& regulations  
site selection  
parking  
plot size & shape  
height  
structure

rentable areas

(including shapes)  
flexibility  
services & equipment  
fenestration  
materials & workmanship  
types of occupancy  
construction costs  
management, personnel  
& operating costs  
financing

STUDIED  
BY

ARCHITECT PLUS

owner  
financier  
realtor  
consultants  
contractors & labor  
code officials  
insurance organizations  
tenants  
operating staff

A successful commercial building project, perhaps more than any other building type, implies the solution of a giant equation including all the above-tabulated known, unknown and variable factors. Accurate resolution of all these contributory forces into a structure meeting the needs of its population, owners and

community — including esthetic needs — is the especial function of the architect. To perform this function properly he must be retained at the beginning of the project and to be of most use at this stage he must know a few fundamentals of real estate, finance and insurance practice.

## SMALL BUSINESS BUILDINGS

### *Finance and Real Estate Viewpoint*

Rental return or income from a proposed building, usually measured in dollars per square foot of rental space, is naturally a primary concern of lenders and real estate managers. Type, area and cube of building are studied by them in preliminary financial set-ups devised to show a profit above an adequate income to defray costs of financing, construction, taxes, depreciation and operation and to arrive at a reasonable rent per square foot. Decision on whether a project goes ahead must be based on such "adequacy of improvement."

Preservation of income in bad times is more difficult in some types of buildings than in others. Experience has shown need for flexibility of space arrangement (and for ease of re-subdivision, particularly into smaller units) to provide for changes in tenancy. Low operation and maintenance costs are essential. It is second nature (or perhaps first) for a building manager to consider "eventual tenants" more than original or current occupants. This influences managerial attitudes toward tenant alteration practices, approvals and expenditures, even in the cases where alterations are paid for by the tenant.

Kind of occupancy for specific buildings affects lenders' viewpoint. Even a 20 to 25 ft retail frontage can secure an adequate institutional loan provided the tenant can develop the required income from the property. It would be impossible space for a variety chain store but quite acceptable for a specialty shop with concentrated selling of high-margin-of-profit goods. A 50 ft six-story building may be an unsound investment in bad times. Major tenants may move out leaving larger spaces which are expensive to alter for small tenants. Rents will be lower due to competition, particularly those paid by such smaller tenants because they can move easily. Increased partitioning reduces rentable area (additional non-revenue corridor, etc., required). Operating costs increase with number of tenants and even if parts of building are closed off there may be spotty tenancy requiring uneconomic service for partly vacant areas. Under depressed conditions managers often cannot afford to maintain premises as well as in normal times; and a building which, because of poor plan, materials or equipment, is difficult (i.e. expensive) to maintain, will be neglected. Rents obtainable from a shabby building are depressed and the situation becomes a pernicious downward spiral of blight.

Multi-occupancy is by some authorities considered not as desirable as larger unit leases. Professional offices, doctors, dentists, etc., although traffic producers

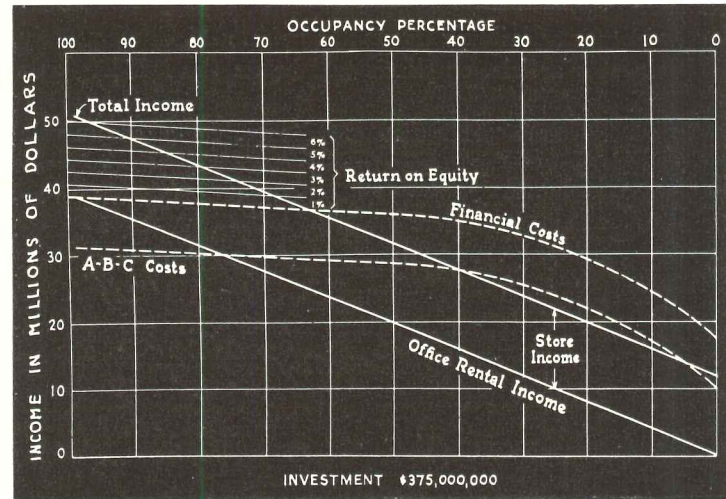

This graph illustrates how quickly most buildings would begin to lose money at present rental rates were their occupancy to drop sharply. It was prepared by the National Association of Building Owners and Managers (11), and is based upon a spotcheck survey of rental incomes and operating expenses for more than 100 buildings at the end of the year 1947. Net income disappears at about 65% occupancy, and is only about 5% at 90% occupancy. "A-B-C costs" are three categories of operating and fixed costs periodically reported to the N. A. B. O. M. by members throughout the country

profitable for some locations, create special problems such as increased operating expenses and maintenance (special utilities) and baby-carriage parking!

On the other hand, a New York City savings bank president, whose mortgage department made more loans in August 1949 than any other lender reported for that month, points out that higher rents can be obtained from small offices. They may be priced on a unit basis rather than on the square-foot basis used for larger space. As an example he compared one floor bringing \$10,000, rented as a whole, with another floor of same area in same building which brought \$14,000, rented as many small offices.

The architect may be in the position of establishing floor development plans for buildings before rental and he must balance such differing viewpoints against local demand.

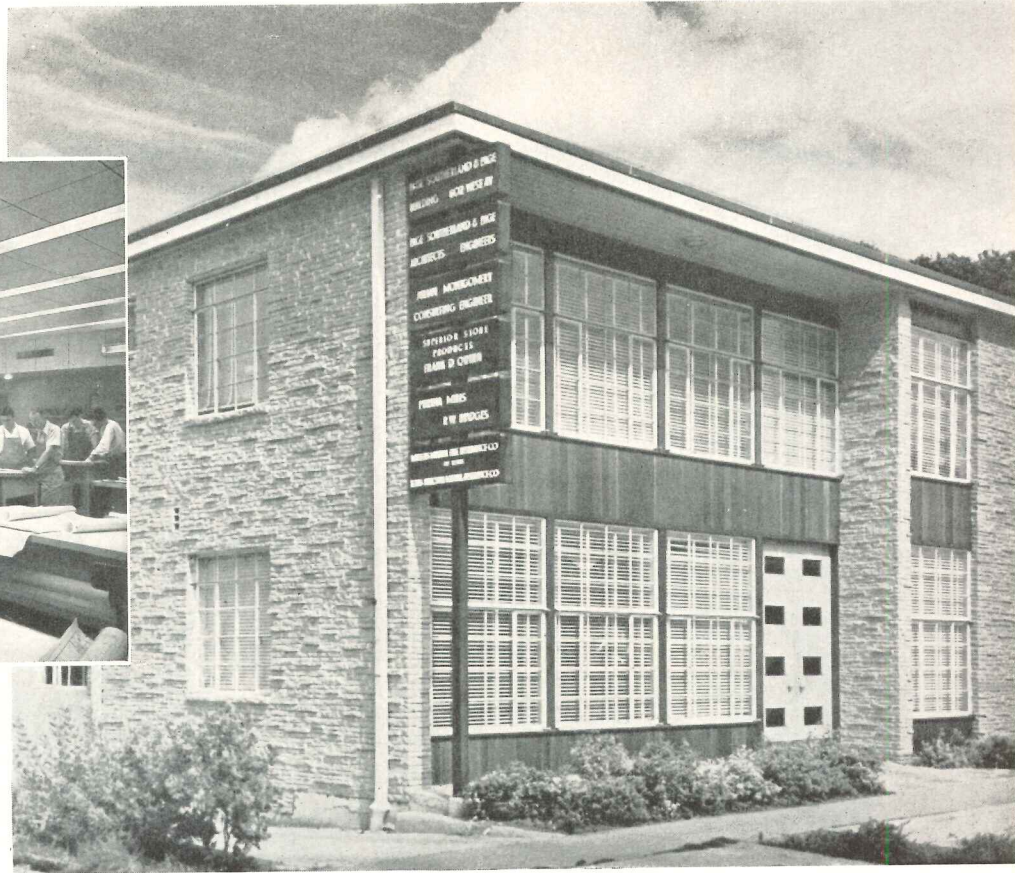
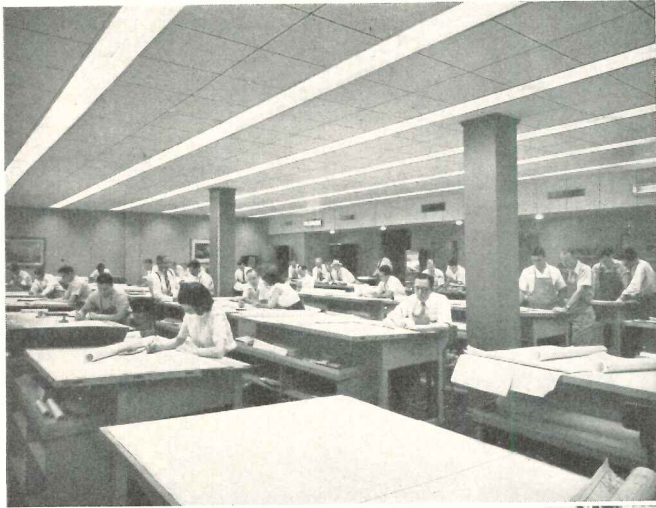

Left: Deep space—controlled conditions: air, light, sound, for efficient operation. George L. Dahl, Architects & Engineers, Dallas, Texas  
 Right: Multi-occupancy: Architects, consulting engineers, manufacturers' sales offices, insurance agency. Page, Southerland & Page, Architects & Engineers, Austin, Texas.  
 Photo: Studtman Photo Service

The usability of upper-floor rental space for a variety of occupancies is often a matter of depth of space from window walls to corridors. Some tenants, such as insurance offices or others with large clerical, filing and storage requirements, may need deep space. Lathrop Douglas, A.I.A., has pointed out in an excellent article (45) a number of office-planning fallacies and showed the actual economies of furnishing air conditioning, superior lighting, acoustic treatment, etc., to provide Class A space anywhere in a building. The old rule of no space deeper than 27 ft from a window wall and the real estate aphorism that "people want to buy windows" is less true from a technological viewpoint in such conditioned space. It still holds from a psychological viewpoint, however, especially where large-area leases are not concerned. This will be referred to again under planning.

There are other amenities which increase the desirability of a building for tenants and which will act to preserve income in competitive periods. Adequate nearby parking facilities are extremely important. A decentralized location, if appropriate for proposed occupancy, may bring other attractive advantages of light, air, space, landscaping and less expensive land.

Certain tenants will welcome provision of facilities for joint use: conference rooms, telephone answering service and low-cost storage areas in basement. The latter recommendation is based on current policies of record retention. There is no reason why a tenant should pay premium rents for inactive file and storage space and in competitive times the smaller tenant cannot afford to do so.

An attractive, convenient entrance, lobby and public spaces will also help to hold tenants. Tortuous access

## SMALL BUSINESS BUILDINGS

### *Finance and Real Estate Viewpoint*



#### ***Decentralized offices***

*Thornhill-Craver Co., Houston, Texas, Mackie & Kamrath, Architects. Photo: Mears Studio*

#### ***Lobbies and public spaces***

*Left: Citizens' National Trust & Savings Bank, Los Angeles, Stiles Clements Associates, Architects. Photo: Shulman. Right: Costello Bldg., Los Angeles, McFarland & Bonsall, Architects. Photo: Knowles*

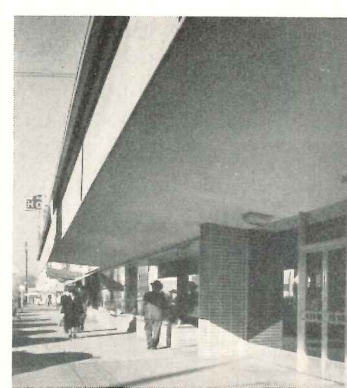



### Conference rooms

Top photo: Own offices. Page, Southerland & Page, Architects. Photo: Studtman Photo Service  
Lower two photos: Esso Headquarters, Richmond, Va. Carneal & Johnston, Architects. Photo: Dements' Studio

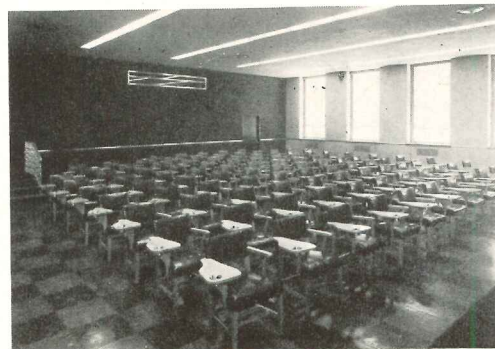
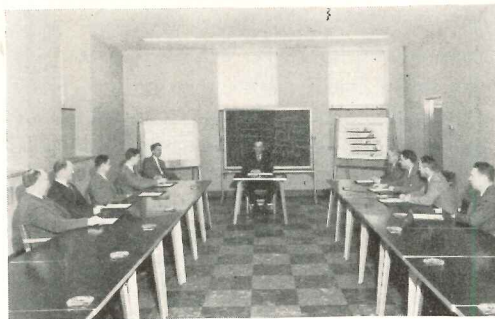

to offices makes a poor impression and often indicates wasteful use of space. The ratio of rentable area to total building area possible to develop on the plot, particularly on high-cost land, must be watched in planning a building for profit. If a building develops vacancies when exit, elevator and service area is excessive this factor alone may alter financial relationships sufficiently to cause distress.

Some operative builders and experienced building owners develop tenants and secure commitments from them before breaking ground for a new building. Lenders naturally prefer this situation; money is more easily available if at least one strong tenant is signed up. Favorable terms of financing will depend largely on the location of the project in relation to the business district and the demand for its proposed occupancy. No hesitation is usually found on loans for projects in a 100% business district since resale is rarely difficult. One insurance company making "building and permanent" loans currently quotes 3½% to 4% interest on one or two-story buildings in 100% districts with short term leases. In an 80% district the interest rate would be 4¼% to 4½% and longer term leases would be required (10 to 20 years maximum, permitting determination of and adjustment to district trends). To these rates must be added amortization of 1% to 3% per year. A popular method is the constant payment plan whereby the proportions of payments on principal and interest vary as the principal is reduced.

### Determination of rental rates

In office building financial analyses a vacancy allowance is now normally set at 10%. A postwar article on Philadelphia conditions (11) pointed out that that city had had an average vacancy of 18% for 25 years previous to the war. Averaging this with 5 years of 100% occupancy the author recommended use of a 15% allowance. Actual 1949 Manhattan vacancy is about 2%. These figures are given to show that local conditions must govern such estimating allowances.

### Entrance establishes character

Left: Sill Bldg., Bakersfield, Calif., Kump & Falk, Architects. Photo: Roger Sturtevant. Center: Costello Bldg., Los Angeles, McFarland & Bonsall, Architects. Photo: Ralph E. Knowles. Right: Remington-Rand Bldg., Phila., Thalheimer & Weitz, Architects. Photo: Hubbard

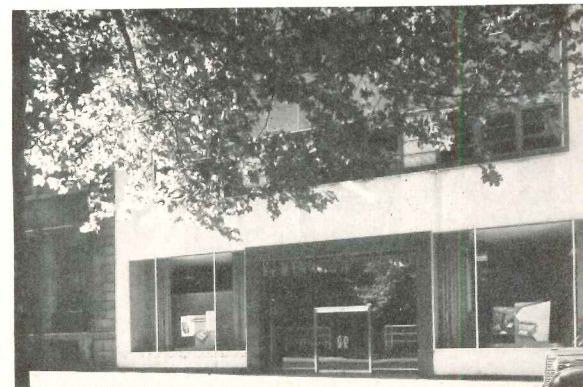
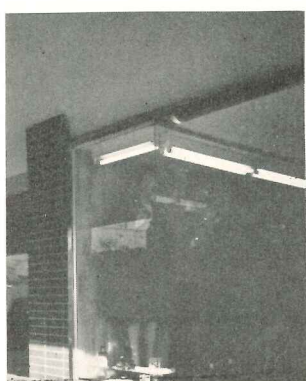

## SMALL BUSINESS BUILDINGS

### *Finance and Real Estate Viewpoint*

Sixty per cent is the normal operating ratio for tall office buildings (based on total rental areas — operating ratios based on rentable office areas were 75% for 1947 and 72.7% for 1948) (7). This means that 60% of total income is normally required for operating expenses. Sixty per cent of operating expenses is required for labor, not including management, with little hope of reduction. It is concluded, therefore, that any substantial improvements in operating ratio must come through increases in rental rates.

An editorial by Charles A. McCaleb of *Buildings & Building Management* (15) says in part: "Devised originally as a measuring stick to aid building operators in comparing operating costs, the square-foot unit soon found its way into renting, when renting men discovered that it provided a quick and easy means of obscuring physical differences between good offices and bad in comparing competitive offerings."

The Sheridan-Karkow rental rate formula (explained on page 102) is derived by reference to a standard unit office 18 x 25 ft (deep) facing street frontage of building on the 8th floor. Since its formulation a number of refinements have been proposed. These are reviewed by B. L. Lefler (17) who points out that there are difficulties in applying such criteria rigidly because space variables are not fixed. Technological changes with increased use of air conditioning and better lighting have improved deep space. Tenants with more than 5000 sf may need considerable deep space. The variety of tenant installations makes great differences in maintenance and service. Doctors and dentists cost more than large fire insurance agencies. Small tenants generally cost more than large ones and shallow space more than deep. A plan with many private offices increases costs. Small law firms cost more than average business tenants.

*Firms with 100–200 branch offices throughout the country vary in leasing and location requirements. One prefers 10-year maximum leases near but not in the 100% districts. A competitor wants 5-year maximum leases, preserving more mobility for offices similarly located, and may move to get into a better market area or away from an expensive location or to provide for expansion. One insurance company insists on 5-year maximum leases although its average tenancy has been about 20 years for hundreds of offices. Length of lease has direct effect on extent of alterations and make-ready expenses tenant is willing to assume.*

*An architect may become vitally interested in such details of loans and leases if he is retained at the outset of a project or if he becomes architect or consultant for a company with a multi-branch office organization*

## COMPANY BRANCH OFFICES IN

26	Acme Steel Co.	48	Automatic Sprinkler Corp. of America
14	Ahlberg Bearing Co.	18	Automatic Temperature Control Co., Inc.
27	Airetool Mfg. Co.	39	Babcock & Wilcox Co.
62	Air Reduction Sales Co.	18	Bailey Meter Co.
27	Ajax Flexible Coupling Co.	15	Bemis Bros. Bag Co.
23	Aldrich Pump Co.	13	Bentley-Harris Mfg. Co.
20	Allegheny Ludlum Steel Corp.	37	Bethlehem Steel Corp.
16	Allen-Bradley Co.	17	Binks Mfg. Co.
59	Allied Chemical & Dye Corp.	15	Black Mfg. Co.
99	Allis-Chalmers Mfg. Co.	41	Black, Sivalls & Bryson, Inc.
54	Aluminum Company of America	32	Blackmer Pump Co.
14	Aluminum Cooking Utensil Co.	22	Bowser, Inc.
27	American Brass Co.	14	Bridgeport Brass Co.
26	American Cabinet Hardware Co.	15	Brockway Glass Co., Inc.
65	American Chain & Cable Co., Inc.	14	Brown-Brockmeyer Co.
25	American Cyanamid Co.	29	Brown Instrument Co.
13	American Emblem Co.	15	Charles Bruning Co., Inc.
21	American La-France Foamite Corp.	22	Buckeye Tools Corp.
15	American Manganese Steel Div.	26	Bull Co.
	American Brake Shoe	9	Carboloy Co., Inc.
19	American Mineral Spirits Co.	14	Philip Carey Mfg. Co.
15	American Nickeloid Co.	34	Carnegie-Illinois Steel Co.
264	American Optical Company	19	Carrier Corp.
21	American Phenolic Corp.	15	Celotex Corp.
10	American Tobacco Co.	25	Chain Belt Co.
32	Anchor-Hocking Glass Corp.	16	Chapman Valve Mfg. Co.
41	Anchor Post Fence Div., Anchor Post Products Co.	24	Chicago Pneumatic Tool Co.
26	Armco Steel Corp.	18	Cincinnati Electric Tool Co.
39	Armstrong Cork Co.	20	Clark Equipment Co.
26	Atlas Powder Corp.	18	Clary Multiplier Corp.

Another formula approach (18) to pricing office space, which can be applied also to modernization projects, is more arithmetic than criteria:

$$\text{Average rental psf} = \frac{\text{Capital investment} \times \text{Interest return desired}}{\text{Total rental area} \times \text{Retainable profit from rental dollar} (= \% \text{ oper. profit})}$$

EXAMPLE:

Assume:

Capital investment	\$1,000,000.
Interest return desired	.06
Total rentable area	50,000 sf
Retainable profit (from each dollar of rent)	.03

$$\text{Avg Rental rate} = \frac{1,000,000 \times .06}{50,000 \times .03} = \frac{60,000}{15,000} = \$4.00 \text{ psf}$$

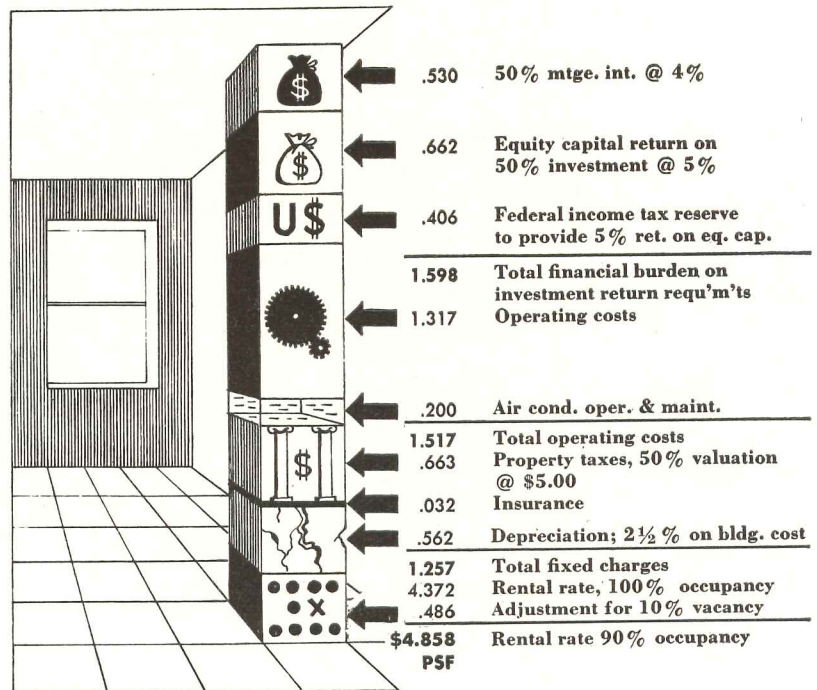

Wayne Colvin

THE UNITED STATES

Approximate totals including major subsidiaries and divisions. Agents, sales representatives, etc., omitted.

38	Cochrane Corp.	28	Foxboro Corp.	35	Oliver Corp.
28	Colson Corp.	223	General Electric	20	Oliver Iron & Steel Corp.
15	Commercial Solvents Corp.	29	B. F. Goodrich Co.	268	Otis Elevator Co.
54	Continental Can Co., Inc.	98	Graybar Electric Co., Inc.	26	Owens-Corning Fiberglas Corp.
22	Continental-Diamond Fibre Co.	24	Hercules Powder Co., Inc.	22	Permanente Metals Corp.
17	Continental Electric Co.	31	Homelite Corp.	11	Pittsburgh Plate Glass Co.
25	Continental Rubber Works	24	A. C. Horn Co., Inc.	1200	Prudential Insurance Co.
126	Crane Co.	18	Howe Scale Co.	200	Remington Rand
31	Cutler-Hammer, Inc.	34	Ingersoll-Rand Co.	48	Republic Steel Corp.
43	Cyclone Fence Div. American Steel & Wire Co.	46	Inland Steel	37	Revere Copper & Brass Co.
16	Deere & Co.	70	Interchemical Corp.	42	Reynolds Metals Co.
44	Diamond Alkali Co.	200	International Business Machines	19	Rheem Mfg. Co.
19	Diamond Mfg. Co.	84	International Harvester Co.	16	Scovill Mfg. Co.
21	Dings Magnetic Separator Co.	18	Bryon Jackson Co.	37	Signode Steel Strapping Co.
18	Dodge Mfg. Corp.	28	D. O. James Gear Mfg. Co.	74	Simplex Time Recorder Co.
12	Dow Chemical Co.	55	Johns-Manville Corp.	46	Square D Co.
134	E. I. Du Pont de Nemours & Co., Inc.	23	Kelley-Koett Mfg. Co.	21	Sterling Electric Motors, Inc.
16	Economy Fuse & Mfg. Co.	28	Kennametal, Inc.	37	Sun Chemical Corp.
19	Electric Storage Battery Co.	22	Libbey-Owens-Ford Glass Co.	18	Sylvania Electric Products, Inc.
21	Elliott Co.	40	Link-Belt Co.	26	Syntron Co.
28	Erie City Iron Works	48	Liquid Carbonic Corp.	42	Timken Roller Bearing Co.
20	Exact Weight Scale Co.	100	Merrill Lynch, Pierce, Fenner & Beane	82	Union Carbide & Carbon Corp.
18	Fafnir Bearing Co.	1000	Metropolitan Life Insurance Co.	30	Union Iron Works
38	Fairbanks-Morse & Co.	64	Minneapolis-Honeywell Regulator Co.	36	United States Rubber Co.
30	Federal Electric Products Co.	20	Monsanto Chemical Co.	135	United States Steel Corp.
18	Federal Products Co.	28	Mueller Brass Co.	48	West Disinfecting Co.
25	Federated Metals Div. American Smelting & Refining Co.	51	National Cylinder Gas Co.	263	Westinghouse Electric Corp.
28	Fibre Specialty Mfg. Co.	28	National Steel Corp.	28	Wheelco Instruments Co.
14	Flintkote Co.	28	National Vulcanized Fibre Co.	42	Worthington Pump & Machinery Corp.
		19	Okonite Co.	22	Wyckoff Steel Co.
		21		41	York Corp.

# SMALL BUSINESS BUILDINGS

## Finance and Real Estate Viewpoint

One rather elaborate attempt to arrive at fair rent for office space is known as the Sheridan-Karkow formula. Its interest to architects is not in results for any particular case but in the criteria it sets up to define good space from user's point of view. Diagrams and photos compare criteria of this nature.

### FACTORS WHICH AFFECT REAL ESTATE VALUE

**MORE DESIRABLE**



**CORNER OFFICE**

**LESS DESIRABLE**



**ONE-WALL**

**MORE DESIRABLE**



**SUN CONTROL**

**LESS DESIRABLE**

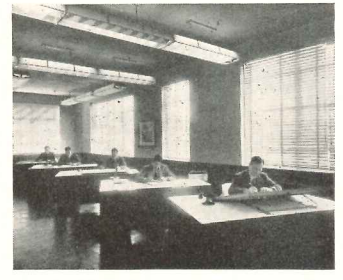

**GLARE**

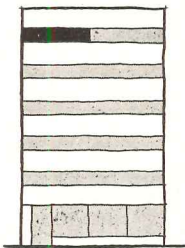

**UPPER FLOOR**

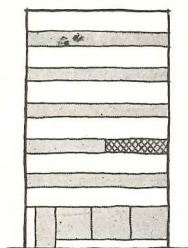

**LOWER**

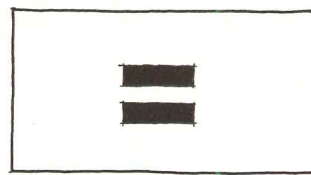

**REGULAR SPACE**

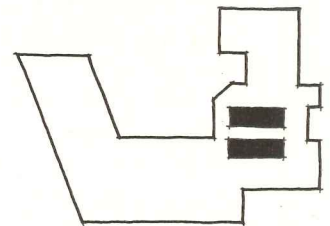

**IRREGULAR**



**SHALLOW SPACE**

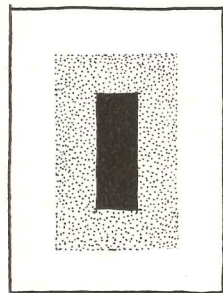

**DEEP**

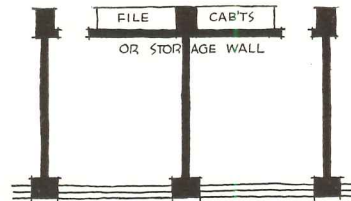

**GOOD COL. LOCATION**

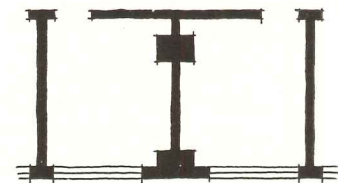

**AWKWARD**

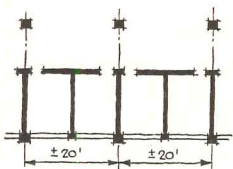

**STANDARD SPAN**

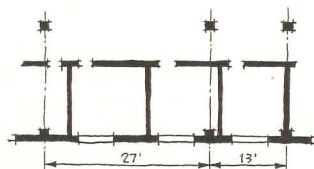

**NON-STANDARD**

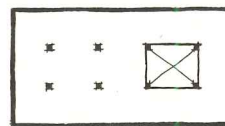

**FREE SPACE**

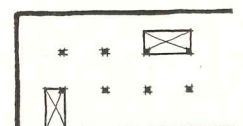

**CROWDED**



**CLEAR VIEW OUT**

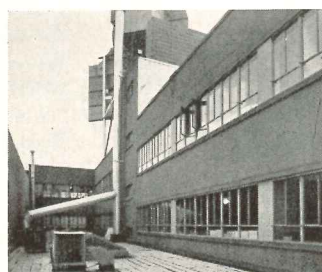

**ROOF OR OBSTRUCTED VIEW**



**BIG WINDOWS**



**SMALL**

## LOCATION FACTORS:

### DECENTRALIZATION, ZONING, PARKING

*Decentralization* has resulted in an increase of office building construction in smaller cities. Reasons are various; defensive dispersal is only one. The financial advantage which may determine whether manufacturing administrative offices should be located at a plant or in an office building is only the difference between the capitalization of the two projects. The operating expenses and taxes will be approximately the same and contemporary communication facilities avoid most inconveniences due to separation. A recent article by a life insurance official (9) points out several reasons for reduction of new general office building construction in central areas:

- (1) Industrial office space (at plants)
- (2) "Home of their own" tendency
- (3) Medical arts buildings
- (4) Decentralization of merchandising

Lower interest rates are available to large organizations with national credit such as telephone and oil companies. This permits them to pay off on new construction years before private owners and consequently "high building costs alone will not stop new office building where large space users feel they need it." (9) An insurance or other sales branch office should be located to serve its territory with least travel by salesmen. This results in a two-sided location concept — *decentralization* of company as a whole and *centralization* of branch in its territory. Often no particular survey methods are used. Variety and food chains and other public-access services are usually established first and define a neighborhood or suburban shopping center based on their own careful surveys. "Many large companies make and keep current such studies on communities in a number of cities in which the location of a store might be desirable in the future. . . . No population center remains constant. Whatever type of area is selected for a store, it is important to select one that is not declining — and it is preferable to select one that is growing now and will continue to do so. . . . A market area is a dynamic thing, constantly adjusting to the economic and social forces which determine its pattern. . . . A good location of today may, in a few years, become a poor one." (33)

Real estate analysis or appraisal techniques for retail or office building sites include preparation of occupancy or strip maps showing location of all business and other occupancies in a city district. Realtors who specialize in chain-store locations prepare these for many cities as a basis for site selection in that highly competitive market.

Cities with "pin-wheel" or radial access highways

often lack adequate circumferential connections. For satisfactory office building sites, a city plan should have what one location executive calls "criss-cross" transportation. The usual unplanned suburban development lacks these crossways and building locations remote from main intersections or "hubs" will not properly serve the area. Insurance offices must consider ease of access to parking, transit, post office and banks. Security and commodity brokerage offices must be in financial districts, near banks, unless they are local branches decentralized for some special area near a concentration of customers. "It is preferable to be situated as closely as possible to organizations with which the greatest volume of business is done." (38)

"It has become evident that there is no dependable relationship between the quantity of pedestrian traffic and the value of a site as measured by retail sales. The Bureau of Foreign & Domestic Commerce made a study of traffic-trade relationships for drug stores and concluded that traffic volume when unrelated to character of the traffic is an unreliable measure of potential business of a site. . . . Corners having the heaviest traffic are not always the best business addresses . . . frequently traffic is too congested. . . ." (33) "The value of an office location from the standpoint of advertisement cannot be overlooked. It may be financially impossible to secure comparable advertising value through other mediums." (38)

"Vacant buildings are regarded as bad neighbors, thus vacancies nearby should be carefully investigated. It is possible that the buildings are old and untenable. On the other hand, perhaps a small amount of face-lifting on several old buildings for which the rent is relatively low would improve the entire block. One store might be able to start a low-cost but very effective renovating program, to the advantage of a group of stores. . . . A great deal can be learned from studying the occupancy history of the site under consideration." (33)

**Zoning:** A review of existing and proposed zoning regulations throughout the country indicates a definite trend toward mixed use. A number of cities for years have permitted retail and service shops on ground floors of multi-family dwellings. Progressive zoning proposals indicate still more intimate relationships between residence and employment. These may be effected by increased residential use of space above commercial occupancies in closely-built districts and by offices and very light or precision manufacturing in residential areas, with attractive lawns and landscaping. Offices and laboratories are already found in some low-

## SMALL BUSINESS BUILDINGS

### *Location Factors*

*Below left: Brokerage office attached to bank building. Merrill Lynch, Pierce, Fenner & Beane; Phoenix, Arizona; Lescher & Mahoney, Architects*  
*Below: Good design is best advertising. Sill Bldg., Bakersfield, Cal.; Kump & Falk, Architects*



Left: Great Southwest Photography (Olchvary). Above: Roger Sturtevant

density residential areas and offices in high-density residential districts.

"One side or end of the (best retail) block is usually better than the other . . . normally, the better side or end is in the direction of the town's growth. Usually such growth is towards the town's best residential area. . . . In many of the larger cities, a majority of the volume of a city's retail business is conducted outside the central shopping district." (33)

Clinics or medical arts buildings belong near the centers of their tributary populations. If a small city develops an industrial area residential sections will grow elsewhere and groups of doctors' offices belong nearer the homes. Retail store "proximity to offices of professional men is desirable especially in outlying shopping centers. People having appointments with doctors, dentists, lawyers, etc., quite often will become shoppers if stores are conveniently accessible." (33)

Office buildings or office space to accommodate any sizable office organization, according to the Urban Land Institute, however, are "not desirable as a rule in outlying centers, increase trade very little, and unless rigidly controlled, will usurp all day parking space which should be reserved for shoppers. . . . Professional offices, particularly doctors and dentists where

they occur in any number, are in the same category. They are expensive tenants, janitor service alone running about two times that of other tenants. Where they cannot be accommodated in second floor locations, the provision of a semi-residential type of building located to act as a buffer between the center and adjacent residential development is a satisfactory solution." (30)

The general purpose buildings with which we are mainly concerned, therefore, belong still nearer the business centers or in local retail districts. Cleveland has a regulation limiting to five persons the number of employees in business offices in such local retail business districts.

A buffer area is provided by transition zoning regulations in some cities to avoid undesirable use-district relationships. These may occur between residential and local retail or residential and industrial districts.

There are a number of zoning techniques for controlling bulk of buildings and density of population. Height, cubage and lot coverage limits are familiar to most urban architects. A more recently developed measure which has somewhat more critical value is the so-called "Floor Area Ratio" (ratio between total floor space — out-to-out dimensions all floors except ground floor — and total area of lot measured to street lines).

Left: Precision work in low-density zone. Technical Instrument Company, Houston, Texas. MacKie & Kamrath, Architects  
 Right: Semi-residential transition. Thornhill-Craver Co., Houston, Texas. MacKie & Kamrath, Architects

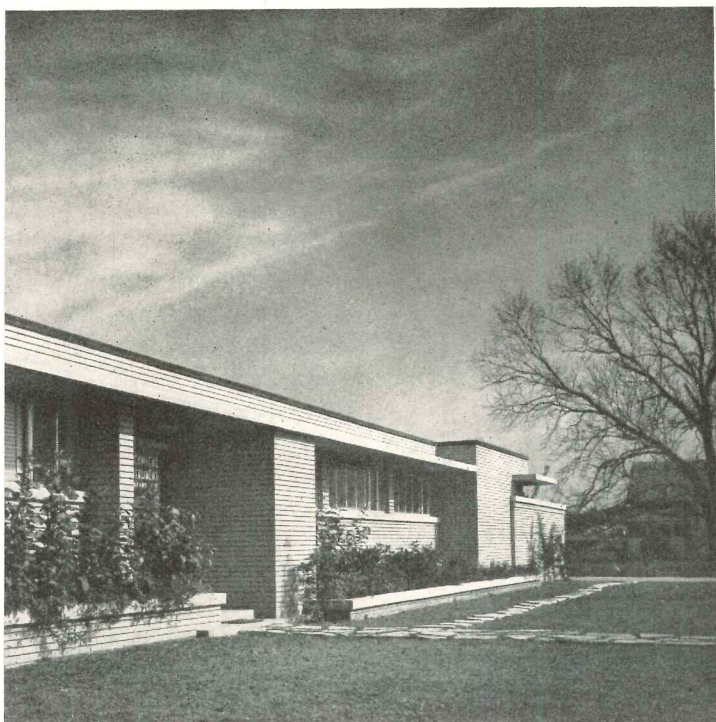

Mears Studio Photos

Application of this to a tall building may result in a ratio of 25 to 30. A two-story taxpayer will show a ratio of less than unity. Between such limits zoning classifications may be established in any city to regulate building bulk and population much more satisfactorily than cubage and height, for instance; these because of variation in story heights, have less relation to occupancy.

Complete zoning control, of course, must also include regulations to assure light and air and amortization of non-conforming uses.

**Parking:** There is considerable national variety in existing zoning controls of parking facilities. A 1947 study (36) of 70 cities from 50,000–100,000 population showed 21% required parking for office buildings and, of 22 cities reporting loading, 24% required loading areas for office buildings. Some other larger city rules and proposals are tabulated below:

Detroit . . . . .	1 space/400sf for office buildings
Los Angeles . . . . .	1 space/100sf business & commercial over 7500sf
Minneapolis . . . . .	1 space/100sf business & commercial over 500sf (proposed)

San Francisco . . . . .	1 space/450sf banks, business (proposed) or professional offices
South Central Connecticut regional zoning . . . . .	1 space/250sf ground floor (proposed) 1 space/500sf upper floors less than 500 ft. distant

The Urban Land Institute reports favorably on a parking solution for large cities consisting of fringe or marginal parking areas served by shuttle buses traveling from one parking area to another across a city.

One of the best studies of all phases of the parking problem is the 181-page Parking Manual issued in 1946 by the American Automobile Association's Traffic Engineering & Safety Department. "The trend for parking to be considered as a public use is reflected in the fact that 33 states have passed legislation permitting municipalities to undertake the provision of off-street parking . . . as a municipal function." (35)

The Urban Land Institute further recommends that "All leases should prohibit employers or employees from parking their cars in 100% business parking stations. . . . Employees' parking should be in the (more remote) locations even if a walk of two to three blocks is required." (30)

# SMALL BUSINESS BUILDINGS

## Planning (See Bibliography references 38-63)

### Branch Office Procedure

Large organizations with many branch offices often have their own locations, field office planning, or branch office layout departments. These establish planning, equipment, materials and finish standards, make surveys of existing space being considered, prepare layouts, schedule and supervise the work. Local architects are retained when the alteration is of sufficient size, or for new buildings. The accompanying data indicate the approach of such company planning departments which is largely concerned, as far as appearances go, with identification of the branch office as a unit of the parent company. There are also obvious advantages of mass purchasing and standardized planning.

Such organizations usually have Branch Office Manuals or Inspection Checklists for selection of location and assembly of data on proposed offices in new or existing structures.

Stockbrokers are another desirable tenant for a small business building. Merrill Lynch, Pierce, Fenner & Beane, securities and commodities brokers, for example, have approximately 100 branch offices which are usually in ground or second floor locations for the convenience of clients. Their essential policies are clear identification as a Merrill Lynch operation and insistence on privacy of the customer's business.

Identification is effected by simple standardized equipment, uniform arrangement, decoration and services. Privacy is assured by a plan arrangement which always permits a customer to go to the Manager's office, to the cashier and to visit the investment department without passing through the crowded boardroom. The wire operators are also placed in a private location adjacent to the cage.

Standard partitions of two heights have been carefully designed for company use. Private offices and cages are enclosed by 66 in. walnut and glass partitions. Account-executive booths, which must permit vision of the board and yet give privacy to conversation and papers, are 36 in. walnut plus 9 in. glass. The booths are approximately 6 x 6 ft (single) and 6 x 12 ft (double).

Branch offices of this organization range from about 1000 sf to 5000 sf in area. The standardized quotation board of silicate slate sections has approximately 36 lf of arc set on varying radii (22-35 ft) and requires considerable ingenuity in planning for vision. Where Tele-register automatic quotation service is available it is replacing these chalkboards.

Each account-executive must have quick access to the wire operator. In larger installations message conveyor-belts are provided; in most cases an ample and direct passage is essential.

It is company policy to provide complete air conditioning, acoustic treatment and usually fluorescent lighting. The Locations Executive sums up this policy as follows: "Our design of offices is intended to provide the maximum convenience, efficiency and comfort for the account-executives who are the producers and also for the operating employees, the cashier and his staff and the wire operators. Although all our customers visit the offices at some time or other, taken by and large, over 90% of our business originates over the telephone and we must be set up to handle it rapidly and above all things, accurately."

### Problem Space

Some characteristics of undesirable space are shown on page 102. Branch office experience in renting offices all over the country yields some additional items.



Standard equipment, brokerage office, Merrill Lynch, Pierce, Fenner & Beane; left, office in Orlando, Fla.; James Gamble Rogers III, Archt. Below, office, Phoenix, Ariz.

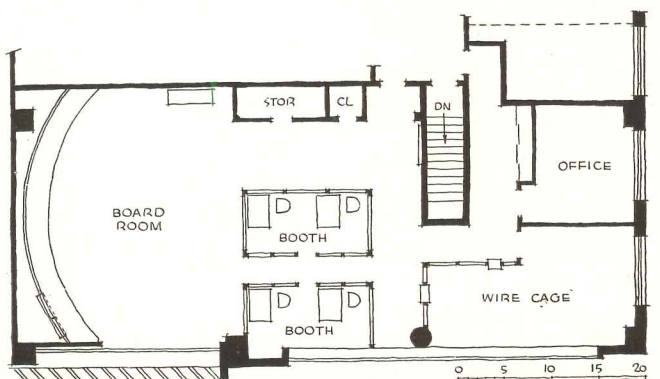



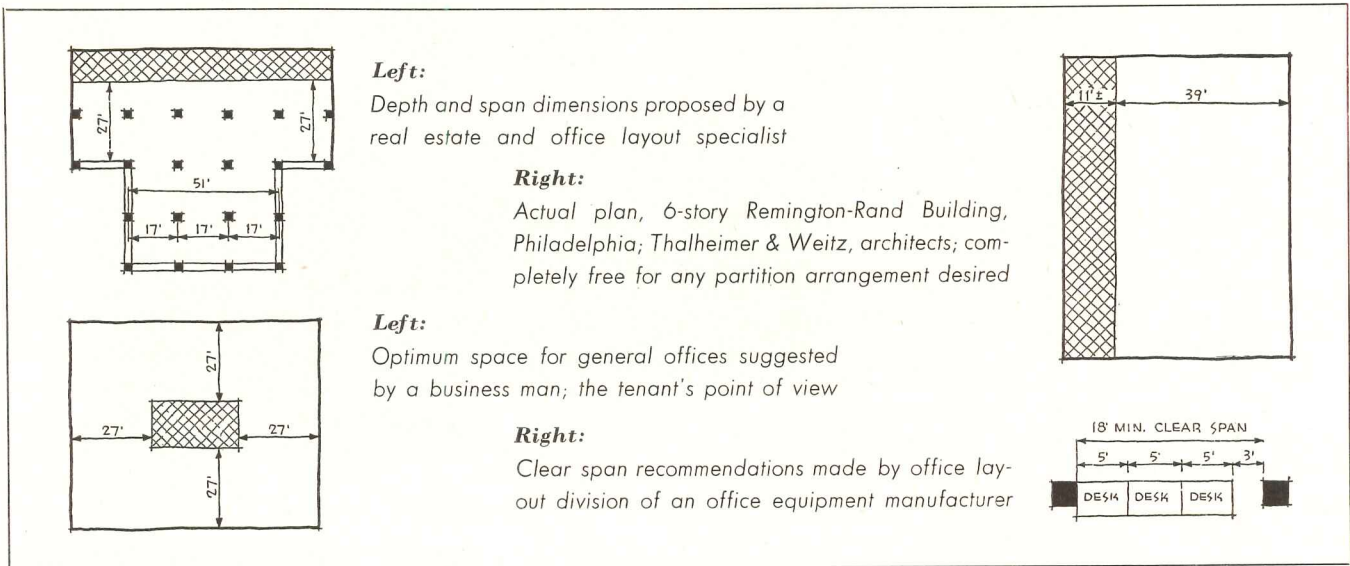

### Shape of space and location of services

A major insurance company finds a tendency for the type of building they occupy as second floor tenants to be designed primarily for the first floor. Public stairs located at one side of a wide building and similar locations of toilets increase travel distances and complicate office planning. Long narrow space is equally bad since it is impossible to plan for group meetings. They favor a plan which permits rental of an end of a floor or a wing incorporating corridor space. This occasionally involves access to a fire exit but some codes permit locking such access if the office doors have large glazed areas. Elevators and utility stacks should be located so as not to crowd or make rentable space irregular.

### Space planning and flexibility

The architect must reconcile many points of view on office space. Each project will have its own special conditions but the accompanying diagrams indicate some

span and depth recommendations by various authorities.

Flexibility of office arrangements is important for the commercial office building because of changing requirements of both present and new tenants. For office purposes flexibility is often measured by spacing of window mullions which permits subdivision into various office widths. Mullions spacing recommendations vary from 3 ft 6 in. to 4 ft and 4 ft 6 in., giving multiples of:

7, 10-6, 14, 17-6, 21

8, 12, 16, 20, 24

9, 12-6, 18, 22-6, 27

(Note: 18 ft clear spans imply approximately 20 ft column center spans which work out for 4 ft 0 in. mullion spacing.)

Use of stock 6 ft linoleum and 9 ft and 12 ft carpet widths for determination of office widths has been considered an economy factor by some planners.

The Sill Building, designed by Kump & Falk, has an arrangement of corridors on top of window sun-screens which results in increased flexibility. A climate in which

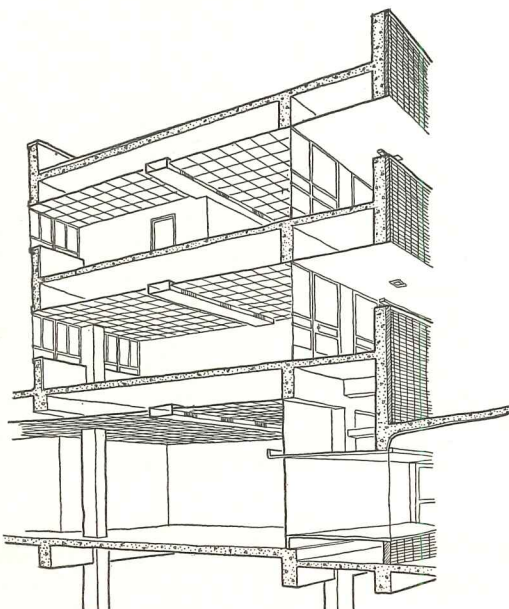

Section and view, exterior corridor, Sill Building, Bakersfield, Calif. (photo: Roger Sturtevant). All services in flush hung ceiling of removable tiles; partitions demountable — an invaluable aid to flexibility



## SMALL BUSINESS BUILDINGS

### *Planning*

Delivery facilities: left, Esso Headquarters, Richmond, Va., Carneal & Johnston, Archts. (Photo: Dementil). Right, Sill Building, Bakersfield, Calif., Kump & Falk, Archts. (Photo: Roger Sturtevant)



exterior gallery-corridors of this type are appropriate gives this opportunity to free the plan of non-revenue space.

### *Facilities*

An architect may help increase the rental values and tenant-holding ability of a commercial building by persuading the owner to consider certain additional equipment and amenities as a part of the basic building. Their cost is insignificant in relation to loss of revenue from vacancies.

Branch office experts all emphasize the importance of knowing who installs and who pays for utilities, lighting fixtures, water heaters, air conditioning, toilet room accessories, various maintenance services and alterations. Many buildings offered for use of companies of national scope are inadequately equipped and leases may provide that tenant-installed items become property of owner when lease expires. The following typical examples of inadequacy have resulted in selection of other buildings: Single and bare toilet rooms instead of separate and properly equipped facilities for men and women, no hot water, lack of freight elevators or hoisting facilities, no loading or large object access, insufficient security of rear windows, inadequate wiring for equipment loads.

### *Expansion and preplanned Growth*

Expansion of a building obviously can be either horizontal or vertical. There are many examples of preplanning both varieties, by plot plan or structural provisions for the future space. Another method is to construct more space than needed for the major occupant and lease the extra area on a temporary basis, planning and earmarking it for expansion needs. A final type is internal — re-study of space for more efficient layout. This also may be preplanned by providing excessive areas for original occupancy, such as conference rooms for later conversion to private offices or loose arrangements of desks and equipment for eventual tighter planning. The private office is declining in favor among management experts and space-saving conversion of private office

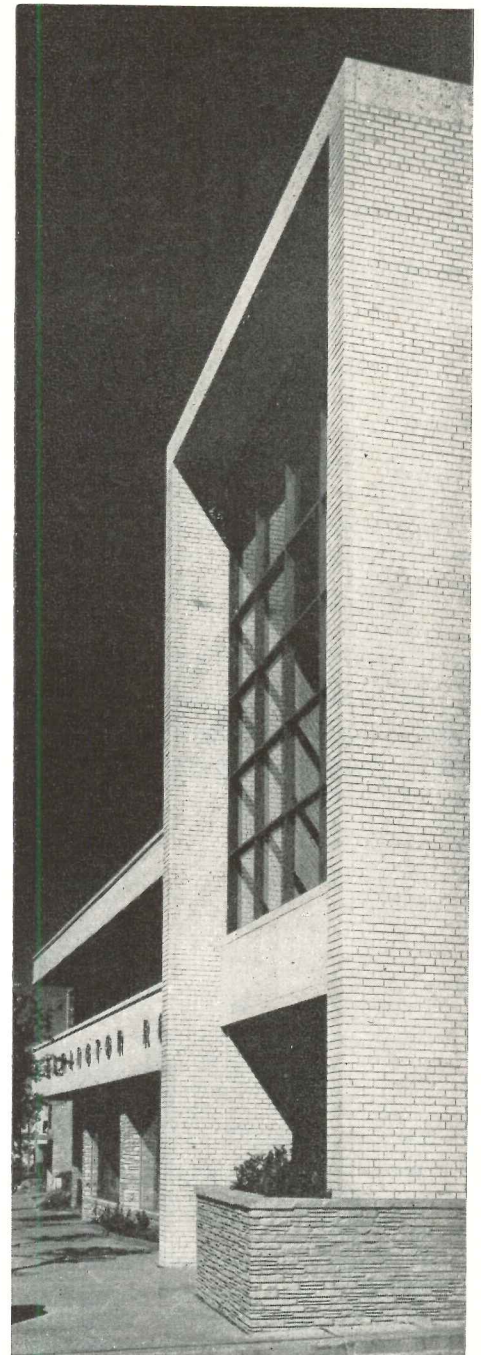

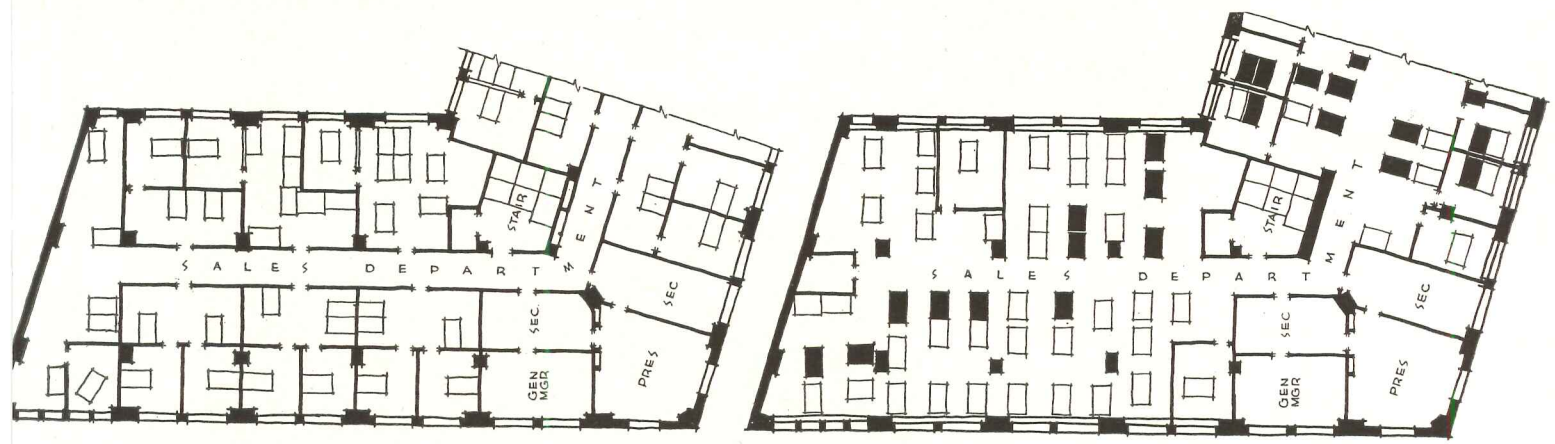

Plans above show economy of open office space; an actual office replanning done by an office equipment company. Black squares are desks added after replanning. Photos (by William Langley) and plans below: office building in Dallas, Texas, takes advantage of sloping site; two story portion occupied by Remington-Rand, some space for other tenants, one-story portion entered from next street, occupied by the building's designers, George L. Dahl, architects and engineers

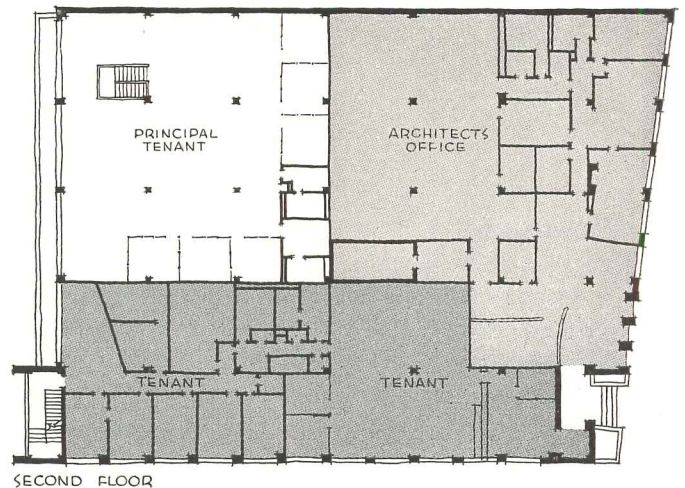
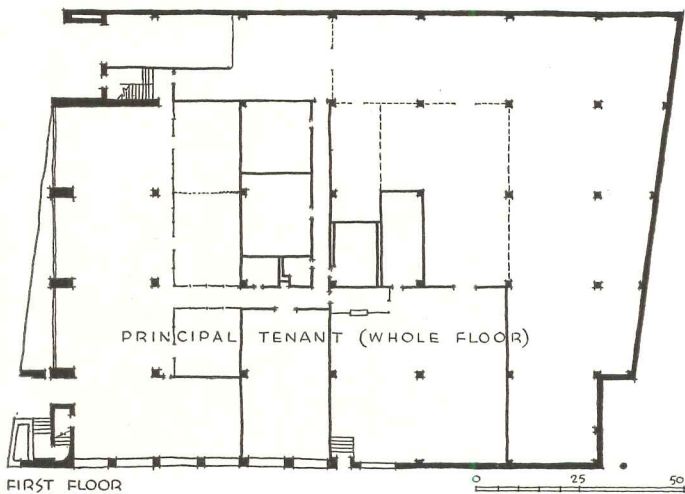

## SMALL BUSINESS BUILDINGS

### Planning

space to pools and general office areas has been accepted by many institutions.

Planning which eliminates the double-circulation of connecting doors between private offices will also save space. Departments which are expected to expand should be placed next to available or easily altered space.

Top, general offices planned for growth; International Business Machines, Portland, Ore. (Photo: Photo-Art). Right, offices divided merely by curtains to permit expansion (can be thrown into one) or to simplify permanent subdivision if that should become necessary; own office, Page, Southerland & Page, Architects, Austin, Tex.



### Features — Equipment — Materials

There has been much written in recent years about "integrated design," perhaps without any full realization of what the words mean and imply. The term involves completeness of parts and relationships, clearly defined functional expression; and is closely related to that other catchword, integrity or honesty. It implies an esthetic and practical marriage of architecture and engineering throughout the job. This so works that it is impossible to draw a line and proclaim: this is architecture, this is engineering. It is design in three-dimensions, completely conditioned for use and appearance. In addition to space and circulation such conditioning includes:

- Atmosphere (air conditioning, etc.)
- Orientation (sun screens)
- Light (natural & artificial)
- Color (bibliography 81-83)
- Sound control (machine areas, general space)
- Finish materials (bibliography 72-80)
- Maintenance facility (including window cleaning, accessibility of mechanical equipment)
- Utility availability (wiring for business machines, telephone ducts)
- Ease of alteration (smooth ceilings for uniform partition heights, re-usable partitions, etc.)
- Structural fitness (appropriate floor load capacities)

### Air Conditioning

"It has long been our opinion that Architects in this locality could not afford to work in a building that was not air conditioned and the improvement in the performance of our force since occupying this building has strengthened this opinion" (Page, Southerland and Page, Texas architects).

A tendency to provide complete air conditioning results in increased floor-to-floor heights often with ducts above removable ceiling installations. This affects relationship between cubage and square feet of space in such manner as to change former valuation standards. In some large buildings air conditioning is available on a rental basis and can be a most profitable business.

Increased use of business machines results in heavier air conditioning loads, particularly where operation requires 100% duty. Typical outputs:

Card-punching machine . . . . .	150 btu/hr
Accounting machine . . . . .	4000 btu/hr

Heavy electronic equipment used in some home office installations may require several tons of refrigeration.

### Fire Insurance (Bibliography references 84-92)

Conformance to local building code is not enough for the commercial building. Construction system, selection of materials, equipment, plan and proposed occupancy must also be reviewed to obtain lower insurance rates. The accompanying hypothetical case comparison illustrates the importance of this factor of operating budgets. Experienced building owners expect architects to submit insurance data along with plans and specifications.

A change in occupancy may cause a greatly increased rate. Rate schedules are further subdivided for contents insurance. Naturally these kinds of insurance are not under the architect's control and we have highlighted only the subject of building insurance rate.

Insurance rate schedules which apply to 90% of the examples of this building type are established in each state by a state-wide fire insurance rating organization

## EXAMPLE OF FIRE INSURANCE COMPARISON FOR TYPICAL SMALL BUSINESS BUILDING

Assume area 20,000 sf		Height floor-to-floor	Occupancy
	Area		
basement	20,000 sf	11 ft	retail storage heating plant retail offices & light occupancy
1st floor	20,000 sf	15 ft	
2nd floor	20,000 sf	12 ft	

CASE A: FIRE-RESISTIVE; rate per \$100 is .035	
basement	20,000 x 11 = 220,000 cf @ \$ .50 = \$110,000.
1st-2nd	20,000 x 27 = 540,000 cf @ 1.12 = 604,000.
Fire-resistive total construction estimate \$714,800.	

CASE B: NON-FIRE-RESISTIVE; rate is .560	
basement	220,000 cf @ \$ .50 = \$110,000.
1st-2nd	540,000 cf @ .94 = 507,600.
Non-fire-resistive total construction est. \$617,600.	
Difference in construction estimates \$ 97,200.	
CASE A: yearly ins. cost = $\frac{\$714,800}{\$100} \times .035 =$ \$ 250.18	
CASE B: $\frac{\$617,600}{\$100} \times .560 =$ \$ 3,458.56	
per year at 100% valuation	
In 20 years on annual renewals (can be bettered on term privileges):	
	CASE B: \$ 69,171.20
	CASE A: \$ 5,003.60
	SAVING \$ 64,167.60
	71% of construction difference

(Note: Interest, taxes, maintenance, etc., disregarded)

(Estimating data from Murphy Brinkworth Construction Corporation)

supported by the fire insurance stock companies (although a few mutual companies participate) under state government supervision. Separate schedules are developed for each class of occupancy (mercantile, manufacturing, etc.) and for fire-resistive and non-fire-resistive construction.

An architect may save his client thousands of dollars over the life of a building by an insurance review and plan revision before construction. The National Building Code recommended by the National Board of Fire Underwriters (84) (which also considers general safety provisions) will serve as a guide to approved practice. The 1949 edition is in form appropriate for adoption as a local municipal building code. Previous editions have been so adopted by over 100 cities. When practical difficulties arise in a specific job a recommendation may be obtained from the nearest office of the state fire insurance rating organization.

Decisions on fire protection and safety features will depend on a comparison of construction costs of alternate plans and corresponding insurance rates. Protection of vertical openings, exposure to and "communications"

with adjacent hazards are important factors in determining rates. The schedules also provide protection credits for the following items:

- automatic fire alarms
- standpipes
- automatic sprinklers
- watchmen, clock and special
- building signals
- fire pumps
- fire pails and extinguishers

It will be found uneconomic to provide elaborate protection for ordinary light occupancies. As in any other analysis such a study can be prepared only for a specific building. In usual projects it need not require a formal or lengthy review.

To sum up, fire insurance rates are predicted on construction, protection, occupancy and exposure. The building valuation to which rates are applied is entirely the responsibility of the insured party. The schedules list items, to be added or deducted in order to arrive at the rate, in cents per \$100 valuation per year.

## ANNOTATED BIBLIOGRAPHY

After each reference one or more code letters indicates the content of the article according to the following key:

- |                       |               |
|-----------------------|---------------|
| b bibliography        | m maps        |
| d details or diagrams | p plans       |
| f forms               | s sketches    |
| g graphs or charts    | t tables      |
|                       | v photo views |

Several specialized periodicals are listed at the end of the main body of references.

### REAL ESTATE, FINANCE & OPERATION

1. Lench, Charles H. *The promotion of commercial buildings*. Architectural Economics Press, N. Y., 1932. 253 pp. Chapter XVI: Financial set-up pp. 141-156. Chapter XXII: Office Buildings pp. 206-211.

2. Holmes, Lawrence G., Editor. *The real estate handbook*. Prentice-Hall, N. Y., 1948. 783 pp. Comprehensive real estate reference data. **dfptv**

3. McMichael, Stanley L. *How to operate a real estate business*. Prentice-Hall, N. Y., 1947. 455 pp., Site selection: (1) Outlying neighborhoods; (2) Satellite towns; (3) Natural traffic intersections. **dftv**

4. *Real estate business* (Basic information sources). U. S. Department of Commerce, Office of Domestic Commerce. GPO 1949. 8 pp. Governmental & non-governmental books, periodicals, bibliographies, lists of associations, directories & services. **b**

5. "How inside space can earn outside rates." By George R. Bailey. *Buildings*, Aug., 49:44. Top grade space throughout building by use of air conditioning, lighting, decoration, acoustic treatment, furnishing. **d**

6. "New buildings may have metal walls." By R. L. Davison. *Buildings*, July 44:45-46. Additions to rentable area & increased total rent due to decreased wall thicknesses now approved.

7. "What is a fair rental rate?" By Le G. Moore. *Buildings*, July 49:30-31 (Part I), Aug. 49:30-31 (Part II). Examples & calculations for existing & new building financial set-ups.

(Continued on page 150)

# ARCHITECTURAL ENGINEERING

## TECHNICAL NEWS AND RESEARCH

Photos: Left, Pollard and Pollard Studio. Right, Wm. Langley

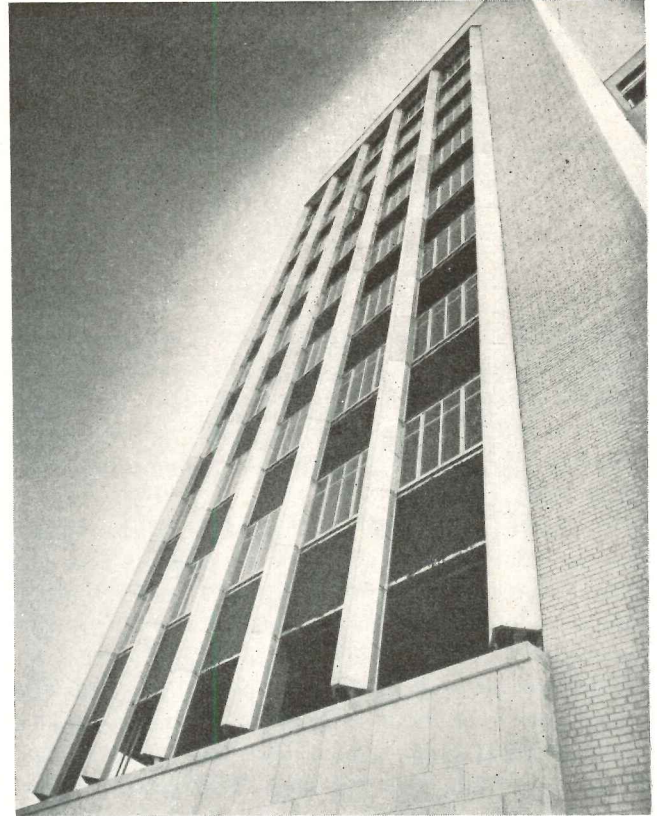
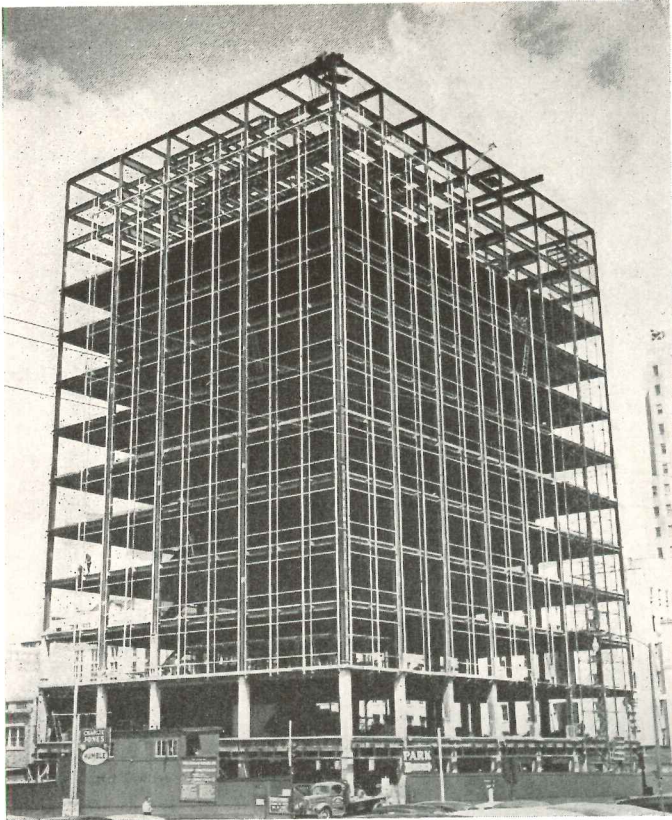

Texas Employers Insurance Association and Employers Casualty Building, Dallas, Texas

## AIR CONDITIONING WORKS WITH DESIGN

for space utilization, flexibility, economy

*George L. Dahl, Architects and Engineers*

**T**HE tall, vertical fins which stretch up three sides of this Dallas office building would hardly be thought of as an essential part of its air conditioning system. But actually they conceal the pipes and ducts which heat or cool areas facing the outside.

This is just one of several ways in

which air conditioning ties in with the design of the structure. In addition, the heavy air conditioning equipment is at the top of the building. Air distribution of the central zones is designed to permit major changes in room partitions without the air conditioning system being disturbed. And in keeping with

these concepts, one of the newest developments in refrigeration equipment is being used.

This fourteen-story office building, with basement, is sheathed in aluminum and glass with the lower store fronts being limestone and granite and the uppermost and rear sections, cream-

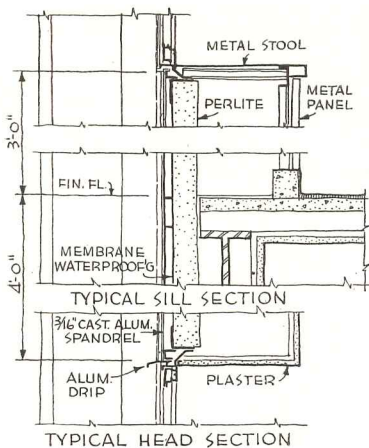

Pipes and air supply riser providing air conditioning for exterior office zones do not take up valuable space, but instead are installed in aluminum fins on the outside of the building. Access panels replace insulating blocks behind fins where pipe lines lead into offices to connect with conditioners. Aluminum spandrel panels indicated on drawings had not been installed in progress photo, (left)

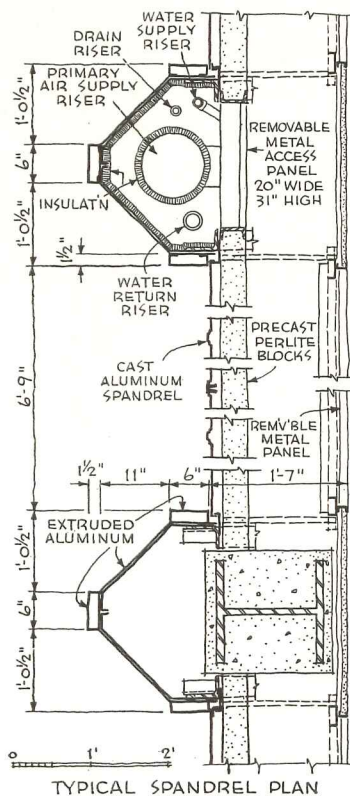

insulation for the aluminum fins and spandrel panels. At each floor there are runouts from the pipes in the fins to window units which air condition the exterior zones.

### Central Heating and Cooling Zones

In order to attain a high degree of flexibility in location of partitions, the conditioned air in the central zones is distributed through a perforated tile ceiling. The use of metal perforated tile and acoustical pads allows the air supply to be shifted from one section of the ceiling to another without changing its appearance.

Air is discharged from ductwork between the suspended ceiling and the floor slab above; wherever an air outlet is needed, the acoustical pads are omitted. It is possible, therefore, to change the air distribution at will simply by moving the acoustical pads from one cell to another. The cells are held in place by friction clamps of a T-bar type of construction. The use of flush troffer fluorescent lights makes it possible for lights and tile to be interchangeable. Partitions can be rearranged without involving extensive time and cost in modifying air conditioning and lighting to suit the new partition pattern.

### Heavy Air Conditioning Equipment on Top Floors

In the early design stages, it was decided that, functionally and economically, it would be feasible to locate major air conditioning equipment on the top floors. The space in the basement was considered too valuable to give up for boiler and machine room space. With the type of heating and cooling planned, this did not impose any difficult engineering problems.

Structurally, the building had to be strengthened somewhat to carry the weight imposed by the air conditioning equipment. This weight, however, is quite minor in comparison to the normal loads the structure has to carry. A small amount of space is gained throughout the building itself because no bulky stacks go up through the building, and there are no condenser water pipes to take up space.

Since the architectural treatment of the building necessitates that the central air handling system be located at the top of the building, there is a large saving in piping because of the proximity of the refrigerating equipment to the major air cooling system. Likewise, sav-

colored brick. It is scheduled for occupancy February 1, 1950.

### Air Conditioning Piping Outside the Building

The air and water used for air conditioning the exterior zones is distributed from the twelfth floor down the outside of the building. Pipe lines encased in the triangular aluminum pilasters or fins run from the third floor to a point halfway between the twelfth and thirteenth floors.

Besides being functional, the placement of these pipes on the exterior of the building structure accomplishes the dream of designers to have straight lines in the building interior. Except for

windows, each interior face of the exterior wall is a flat surface. Each fin carries an air conduit, two water pipes and a drain which, together with window conditioner units, comprise the high pressure conduit type of air conditioning employed. The air conduit, 13 in. in diameter in some places, would make an appreciable encroachment in the occupied space if it were installed in the conventional manner. So to eliminate this, the piping and air conduit were placed in the vertical fins on the outside of the structure. These fins, made of aluminum and insulated on the inside with 1 in. of blanket-type insulation, form the main motif of the building. Precast perlite blocks provide backup

ings are made in steam piping by having the boilers located adjacent to the major steam consuming apparatus.

### **Latest in Refrigeration Units Used**

Contrary to the popular concept, steam, ordinarily used for heating only, is also being used for refrigeration. Steam absorption units, successfully used in several pilot installations, and just recently placed on the active market, were selected to provide the refrigeration. While they are, in this case, a little more expensive than centrifugal machines, it is anticipated that a lower operating cost will effect a worthwhile saving in power costs. The new unit uses plain water as a refrigerant and a simple salt as an absorbent. Water to

be chilled is sprayed into an evaporator maintained at an almost perfect vacuum. Due to this high vacuum, a portion of the water vaporizes, cooling the remaining water which is pumped to the load.

The vaporized water goes into an absorber where it is taken up by the salt solution. The heat liberated by the absorption of the water vapor is transferred to cooling water.

Since the absorption of the water vapor reduces the salt concentration of the solution (reducing its absorbing power) it must be reconcentrated. Steam heats the solution and boils off the water vapor previously absorbed by the salt solution.

The absorption principle is not new. However, it has been in extremely lim-

ited use for heavy duty applications because of the lack of a refrigerant-absorbent combination that was both safe and efficient. Machines of this type using ammonia are not suitable for air conditioning because of the toxic qualities of ammonia.

### **Special Ventilation for Basement Garage**

Most of the basement is for car storage. Mechanical ventilation is provided to safeguard the health of those working in the area. Large quantities of air travel the full length of the garage, and are then exhausted by mechanical means. The exhaust ductwork is arranged so that there are grilles at both the floor and ceiling to insure removal of gases, regardless of where they collect.

Conditioned air for central zones comes through portion of metal perforated ceiling where sound absorbing pads are left out. Use of perforated tile ceiling and the type of fluorescent troffer shown allows rearrangement of partitions for new offices with minimum loss of time and complete salvage of original material

Top: primary air and water lines coming into the room air conditioners from the aluminum fins. Primary air discharged through nozzles in the conditioner causes recirculation of room air over secondary heating-cooling coil (seen at extreme right). Bottom: major air conditioning equipment is on top floors. Shown here are the steam refrigerating units; plain water does the cooling

Wm. Langley Photos

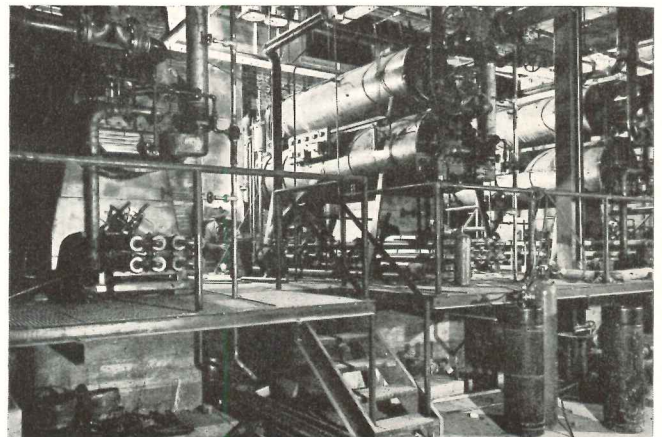
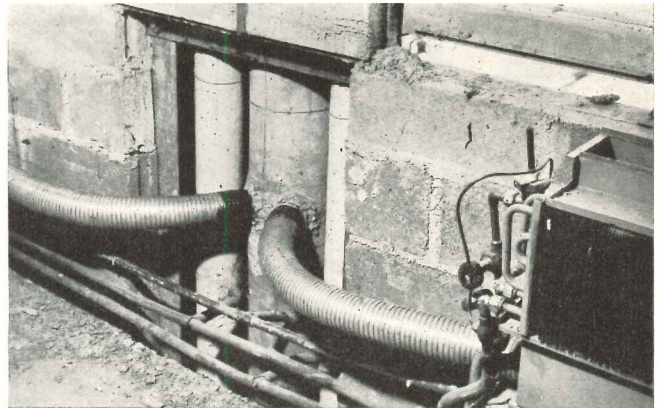



**Fig. 1**

This startling collection of water on the floor joists over a crawl space came from the soil. Without ventilation or soil covering in crawl spaces, structural members frequently become cold enough to condense moisture out of the air

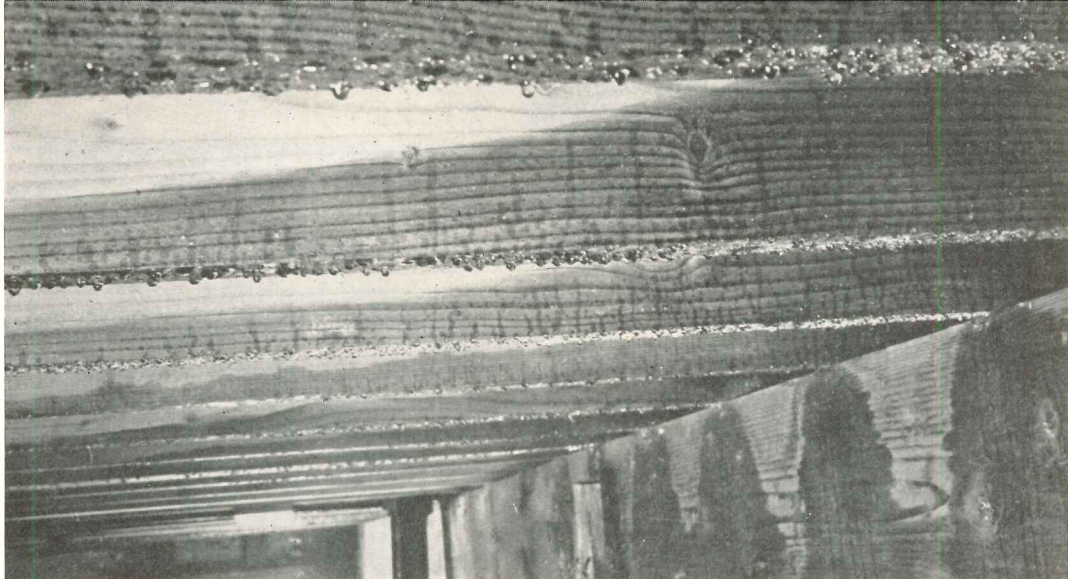

## PREVENTING CONDENSATION IN DWELLINGS

*Based on a new booklet\* published by the Housing and Home Finance Agency, this article explains the causes of condensation troubles in dwellings, tells why they are more prevalent today, and sets down recommended practice to prevent them. Construction details showing vapor barrier installation will be taken up in next month's and subsequent Time-Saver Standards*

A FEW years ago little or no attention was given to condensation in dwellings. Either it did not occur or was so minute that it was not a serious problem. Difficulties resulting from lack of condensation control, such as paint peeling and wood decay, have increased recently, and many troubles little understood heretofore are now attributed to lack of sound condensation control practices. Presented here are recommended methods of condensation control by the use of vapor barriers and ventilation based on engineering tests and practical experience, and applicable mainly to small house construction.

### **Why Condensation Troubles Today?**

Condensation troubles are more prevalent now because dwellings have higher relative humidities than before. High prices, the scarcity of building materials, and other economic conditions favor the building of smaller, more compact houses, with resultant higher humidities. Improvements in the machining of wood parts, new materials, and the use of weather strips and storm windows now make both new and old houses tighter than formerly by restricting air leakage

\*"Condensation Control in Dwelling Construction" by Forest Products Laboratory, Forest Service, U. S. Dept. of Agriculture in collaboration with the technical staff of H.H.F.A. Available from Superintendent of Documents, Government Printing Office, Washington, D. C., 20 cents.

or infiltration. Humidifiers, when used indiscriminately, sometimes add greatly to the condensation problem, especially during extremely cold weather.

Today, people make more extensive use of appliances discharging water vapor into the living space than in the past, thus making condensation control more essential. Basements are frequently omitted in low-cost construction, and instead there is substituted an enclosed crawl space below the building. This crawl space may often be damp and thus contribute large quantities of water vapor which may find its way up into walls, attics, and living areas.

Thermal insulation is also used to a greater extent than formerly and as a consequence, outside wall surfacing materials (sheathing and siding) are somewhat colder than those of uninsulated construction. The use of thermal insulation, however, is not, as is often assumed, the only factor contributing to condensation nor does it attract moisture. It must, however, be properly installed with whatever collateral materials or other means that are necessary to prevent condensation trouble.

### **Common Troubles**

One of the most common and widespread types of damage for which condensation is often responsible is in exterior painting. Condensed water vapor

often collects behind the siding of a building in the form of free water or ice. This excess moisture may absorb extractives from the wood and result in stains as it runs out over the surface of the siding. In some cases the condensate thoroughly soaks the siding, causing paint blisters and early paint peeling. If moist conditions prevail for a long enough time, decay may also result.

Another type of condensation damage may occur in houses having unventilated flat roofs. Sometimes water vapor passes through the ceiling and condenses on the roof sheathing from which it drips back to the ceiling, causing the plaster to crack.

In basementless houses without crawl space ventilation or soil cover, the outside walls, plate, sills, and adjoining joists exposed in the crawl space of the building are often cooled to temperatures below the dew point in the enclosed space. When this happens water often condenses on the surfaces in sufficient quantity to produce conditions favorable to decay. This is illustrated in Figure 1.

Figure 2 shows a house with pitched roof in which water vapor entering the attic space from the occupied area condensed near the eaves where the structural parts were colder than in the occupied area of the building. The arrows indicate where decay started.

## Control Methods

Condensation control in dwellings is possible by the proper use of vapor barriers, ventilation or a combination of both. Vapor barriers are membranes, aluminum or oil paint films, rubber base paints, metallic sheets, or other materials or coatings that prevent objectionable amounts of water vapor from being absorbed or transmitted through walls, floors, and ceilings. Vapor barriers are no better than their quality nor thoroughness of their installation. They should be selected for quality and should be carefully placed. Ventilation is suitable for reducing water vapor concentration in attics and in unheated crawl spaces below living quarters. In some dwellings it is desirable to provide ventilation for the living quarters in order to lower the relative humidity and thereby reduce condensation hazards.

Added roof protection at the eave line to prevent backing up of melted snow and ice is advisable. Trouble from this source is often erroneously blamed on condensation.

Many materials used as interior surfaces of outside walls, ceilings, and roofs will permit water vapor to pass through them slowly when the relative humidity or vapor pressure is different on opposite sides unless a vapor barrier is provided. When the relative humidity or vapor pressure within the house at the

wall surface is greater than that within the wall, water vapor will migrate in the absence of an effective vapor barrier through the plaster or other finish into the wall cavity and will condense if it comes in contact with surfaces below its dew point. This process may continue throughout the heating season at varying rates depending on conditions in and out of the house.

The water vapor generated within a dwelling is first diffused through the space within the building, increasing the relative humidity. Some of it is absorbed by rugs, fabrics, and other house furnishings, and some is condensed on windows. This water may be removed slowly from the living quarters by the opening of outside doors, by diffusion through walls and ceilings into cavities or attic spaces, by leakage around windows and doors, by way of air supplied to burning fuel in heating equipment vented into chimneys, and by air exhausted by kitchen ventilating fans, etc.

*Vapor Barriers.* Adequate, well-installed vapor barriers are an effective means of preventing troublesome deposits of frost or water in walls and attics of houses exposed to low temperatures.\* The vapor

\*A good vapor barrier when installed should not have an average vapor transmission rate greater than 1.25 grains per sq ft, per hr, per in. of mercury differential including joints, fittings around outlet boxes, and the like. It should have sufficient mechanical strength to permit handling during erection without damage. It should also retain its vapor resistance qualities for the life of the building or, if a paint film, until it is renewed.

barrier should form a tight envelope near the warm side of the building element in which it is installed.

A number of satisfactory materials or combinations of materials are available that restrict the movement of water vapor. These include asphalt impregnated and coated papers having a glossy or bright finish. This feature is important since thin, dull-surfaced papers are not generally so effective as is the glossy finish. Duplex papers composed of two sheets of 30-lb kraft paper with a 60-lb per 3000 sq ft asphalt layer between them; aluminum foil mounted on one or two sides of a paper support, or attached to the plaster base; or aluminum paint, oil paint, or rubberbase paint in sufficient coats to result in a smooth glossy finish are types of material that may be expected to give satisfactory service.

Papers used to support insulating materials which have narrow strips of asphalt as an adhesive to join the paper and insulating materials are not usually good vapor barriers and their value for this purpose should be accurately confirmed before purchasing.

*Sheathing.* In contrast to the vapor-tight properties of the warm side of a wall, those of the cold side should be just the opposite—a construction capable of losing moisture that might gain entrance to the wall is highly desirable. On the other hand, the exterior sur-

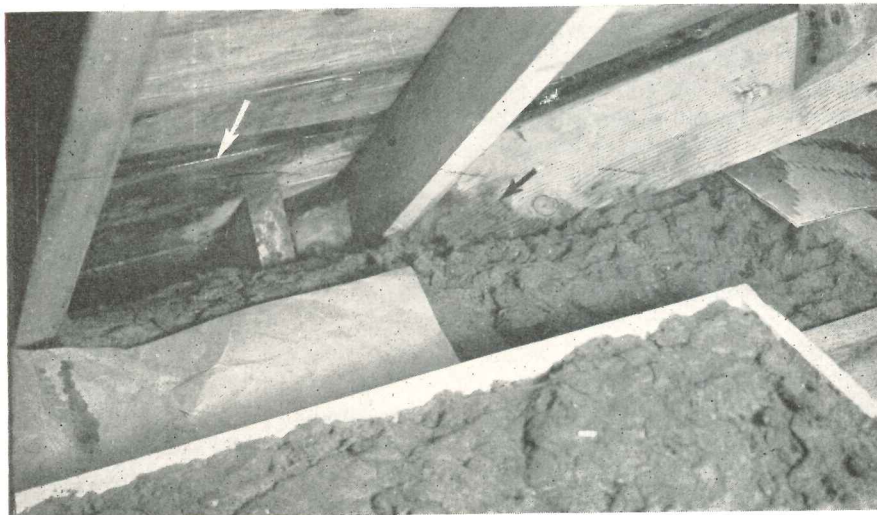

Fig. 2

Condensation near the eaves of this attic is causing wood to decay (arrows). No attic ventilation or vapor barrier was provided. The house, located in Madison, Wis., was occupied in September, and the photo was taken in December

face must resist rain and strong winds. Sheathing paper, sometimes called breathing paper, between the sheathing and the finish siding has been customarily used to reduce infiltration of cold air and to prevent the penetration of wind-driven rain. In order that there be as little restriction as possible to the release of moisture, it is recommended that the sheathing paper and the sheathing be of types that will readily transmit water vapor.†

**Ventilation.** In proper amounts and correctly applied, ventilation is a recognized means of controlling condensation in buildings. By introducing fresh air into living quarters during the winter, some water vapor is forced out of the building, and air containing a low vapor content is introduced. In this way high vapor pressures which are a factor in producing condensation are reduced considerably. Ventilation is effective in preventing condensation in unheated attics, spaces below flat roofs, and crawl spaces in basementless houses. Although much is yet needed in experience and test data to prove the efficiency and effectiveness of ventilation in the cold cavities of walls to prevent condensation, there are some data indicating favorable results with an upward air movement on the cold side of any insulation in the cavity. This air movement should have the intake from the outside and should exhaust to the outside at the top of the wall unless provision is made to disperse the moisture added to other spaces above the wall. The burning of fuels for heating tends to increase the amount of fresh air entering a building and thus provides ventilation in the occupied spaces. No special provision is ordinarily made for it to enter since it usually gets in through infiltration around doors and windows. Where the construction is weather stripped and has tight exteriors, additional openings may be required.

Attic spaces are sometimes a source of trouble because of condensation on roof boards, shingles, or on long nails extending through the roof into the attic. Where the attic floor is well insulated, adequate ventilation in the

attic is a safeguard against such condensation difficulties.

Ventilation in the cold cavities of walls by openings at both top and bottom is considered effective in preventing condensation in the cavity provided they open to the outside. Research to date indicates that 1 in. of opening per running foot of wall at both top and bottom is effective.

During the warmer months of the year a deposit of water or condensation is frequently found on basement walls and floors that are in contact with the soil. This type of water deposit is often confused with or thought to be water seeping through the concrete. In most cases, it does little harm; but where the floor or walls are covered with decorative materials, precautions are necessary to prevent decay or discoloration.

#### Good Practice Recommendations

**Ventilator Size.** There has been some confusion in the past on amounts of ventilation area intended when terms such as "area," "free area," "gross area," "net area," and just plain ventilation are used. The effect of air movement restriction such as (1) louvers, (2) fine mesh insect screen, and (3) grilles containing relatively small holes has not been completely understood.

For specification purposes and as used in the following discussion of amounts of ventilation recommended, the values given will be the "net amount of ventilation." The net area is the approximate unobstructed, clear or free opening through which air may move. The "gross area" is the total area of ventilator, louver, or grille and includes the net area as well as the solid material obstructing the flow of air. The relation between "net" and "gross" area for calculation purposes may be considered to be as set forth below:

Gross Ventilator Area = Net Area × Factor A	
Ventilator Covering	"A"
1. ¼ in. mesh hardware cloth	1
2. screening, 8 mesh to the in.	1¼
3. insect screen, 16 mesh to the in.	2
4. louvers and ¼ in. mesh hardware cloth	2
5. louvers and screening, 8 mesh to the in.	2¼
6. louvers and insect screen, 16 mesh to the in.	3

† A satisfactory sheathing paper or sheathing should be capable of passing 5 or more grains of water vapor per sq ft, per hr, per in. of mercury when tested by a dry method and should be resistant to wetting by free water and have satisfactory strength for handling and service.

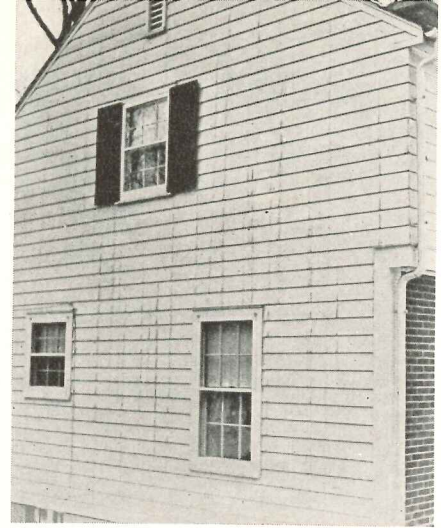

Fig. 3

Moisture condensing behind wood siding carried wood extractives over exterior surface, resulting in unsightly stains

**Crawl Space Ventilation.** If there is no other effective condensation control, and if the soil may be a large supplier of moisture to the crawl space, the total net amount of ventilation should be 2 sq ft per 100 lineal ft of building perimeter plus one-third of 1 per cent of the crawl space ground area.

Good practice in condensation control in crawl spaces includes the following:

1. At least four ventilating openings, with one near each corner of the building.
2. The openings should be placed as high as possible in the walls of the crawl spaces.
3. When the ventilation is the only means of condensation control, the ventilator should not be closed during any time of the year.
4. When ventilation serves as condensation control, insulation may be required in the floor and around exposed mechanical lines for comfort and to prevent deterioration.

**Ground Cover.** Where it is not practical to allow a free sweep of cold air below a dwelling floor, condensation in crawl spaces can be controlled by covering the ground with a vapor-resistant, durable material. A good water-proofed concrete slab or heavy roll roofing has been found effective. A roll roofing, either mineral surfaced or plain, weighing at least 55 lb per 100 sq ft, laid with 2-in. lapped joints over a rough-graded surface, should serve satisfactorily for many years. Generally, the lap joints need no cementing material.

Where a good cover is applied over the entire surface of the ground in the crawl space, very little ventilation is



Fig. 4

Map divides country into three zones so that recommended condensation control practices can be established for different outside design temperatures. Zone I roughly includes temperatures  $-20\text{ F}$  and colder; Zone II,  $0$  to  $-10\text{ F}$ ; Zone III warmer than  $0\text{ F}$

needed. However, to be on the safe side, it is recommended that at least 10 per cent of the ventilation indicated by the two plus one-third formula (See "Ventilation") be provided.

**Walls.** It is recommended that where the walls contain materials adversely affected by moisture or by freezing in the presence of moisture, an effective vapor barrier be provided on the warm side of the wall under the following conditions:

1. When the wall is insulated so that

the overall heat transmission coefficient ("U") is numerically lower than 0.25 Btu per hr, per sq ft, per degree Fahrenheit. This applies to dwelling construction erected in any of the three condensation zones shown on the map.

2. When the wall has siding, sheathing, or sheathing paper or any other material on the cold side of the wall which, as applied, has a water vapor permeability of less than 5 grains per hr, per sq ft, per 1 in. of mercury pressure differ-

ential, and the dwelling is located in Condensation Zones I or II.

**Lofts or Attics.** In many instances, ventilation has been counted on in the past for condensation control in lofts, attics, etc. Ventilation will still perform satisfactorily if effectively installed; this requires (1) an adequate amount, (2) proper location, (3) continuous operation, and (4) circulation through all spaces to be ventilated.

The table on this page sets forth recommended good practice for the usual conditions encountered in dwelling construction.

For flat roofs, ventilation at the eave lines only is not effective in itself. Vapor barriers are definitely recommended in addition to ventilation in all zones.

For roof construction where the ventilation is advantageously placed high in the gable ends, vapor barriers are not absolutely necessary except in the severe Condensation Zone I. A vapor barrier was omitted as a positive recommendation in Condensation Zone II and III because of costs.

Net amounts of ventilation in the table are given in fractions, thus:  $1/300$  or  $1/600$ . They apply to the area of the building or part thereof at the eave line.

Recommended good practice — loft and attic ventilation <sup>1</sup>			
Type of roof and occupancy	Condensation zone		
	I	II	III
(a) Flat roof — Slope less than 3 inches in 12 inches. No occupancy contemplated.	Total net area of ventilation should be $1/300\text{th}^2$ distributed uniformly at the eaves <i>plus</i> a vapor barrier in the top story ceiling. Free circulation must be provided through all spaces.	Same as for zone I.	Same as for zone I.
(b) Gable roof — Slope over 3 inches in 12 inches. No occupancy contemplated.	Total net area of at least 2 louvers on opposite sides located near the ridge to be $1/300\text{th}^2$ <i>plus</i> a vapor barrier in the top story ceiling.	Same ventilation as for zone I. A vapor barrier is not considered necessary.	Same as for zone II.
(c) Hip roof — No occupancy contemplated.	Total net area of ventilation should be $1/300\text{th}^2$ with $1/600\text{th}^2$ distributed uniformly at the eaves <i>and</i> $1/600\text{th}^2$ located at the ridge with all spaces interconnected. A vapor barrier should also be used in the top story ceiling.	Same ventilation as for zone I. A vapor barrier is not considered necessary.	Same as for zone II.
(d) Gable or hip roof — With occupancy contemplated.	Total net area of ventilation should be $1/300\text{th}^2$ with $1/600\text{th}^2$ distributed uniformly at the eaves <i>and</i> $1/600\text{th}^2$ located at the ridge with all spaces interconnected. A vapor barrier should also be used on the warm side of the top full story ceiling, the dwarf walls, the sloping part of the roof, and the attic story ceiling.	Same as for zone I.	Same as for zone I except that a vapor barrier is not considered necessary if insulation is omitted.

<sup>1</sup> It is recognized that in many areas increased ventilation may be desirable for summer comfort.

<sup>2</sup> Refers to area enclosed within the building lines at the eave level.



## MOUNTAIN INN

### BUILT WITH PLASTICS

TERMED the "first truly representative architectural model for plastic materials," the Sky Line Inn atop Mt. Equinox in Vermont was fittingly dedicated at a recent meeting of the Society of the Plastics Industry, New England Section. Built by Dr. J. G. Davidson, an executive of one of the member companies, the inn when complete will consist of some 40 rooms.

Applications of plastics, both apparent and hidden, exist virtually from foundation to roof. The exterior was painted with a synthetic resin base paint. Both interior and exterior walls are phenolic resin-bonded plywood, and, between walls, plastics exist in the form of glass fiber mat insulation bonded with phenolic resins.

All rooms are heated by electric radiant panels consisting of conductive rubber sheets sandwiched between laminate insulating layers.

A remote control wiring system employs vinyl wire insulation for high dielectric and mechanical strength.

Sub-flooring is  $\frac{3}{4}$ -in. plywood bonded with synthetic resins to prevent buckling and warping. All finished flooring except for carpeted bedrooms is vinyl plastic floor tile.

There are wall coverings of plastic sheeting, and vinyl wall tile is featured in the bathrooms. Decorative laminates and sheeting are used for table tops, corner seats and chair upholstery. Draperies woven of glass are impregnated with plastic resins.

The Sky Line Inn presents thorough evidence of how proper use of modern plastic materials can open up new design possibilities along with high standards of economic service.

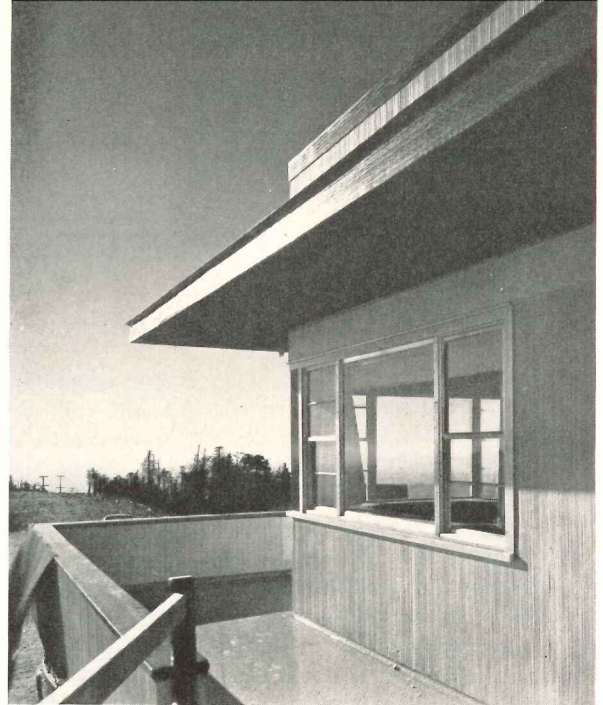

Photos courtesy Bakelite Corp.

*Above: plastic-bonded plywood, finished with synthetic resin paint, covers the exterior of Sky Line Inn. Below: plastics evident in the furnishings of the dining room and bar — table tops, chair and seat coverings, bar counter (bar front is tufted plastic), curtains and vinyl flooring*



### HEATING SYSTEMS FOR HOUSES

#### Cast Iron Baseboard Heating Systems: I

#### Comparison With Other Systems

Baseboards distribute heat better than standing radiators and are less conspicuous. Properly installed, there is less wall streaking because of the top seal strip and non-concentrated convection currents. Lower parts of rooms are warmer, as shown in Charts A and B, making it most adaptable to basementless construction. Response to starting and shutting off is quicker with baseboards than with radiant heating.

#### Heating Medium

Hot water forced circulation is the

most adaptable heat source for baseboards and can be used in any of the three circuits sketched. Operation is like any hot water system using conventional radiation and operation cost is about the same. If there is a minimum wall space for base, heat losses can be cut by further insulation, double glazing, etc.

#### Adaptability to Old Buildings

Baseboards can be used in conversion jobs where gravity hot water systems are in use. Two pipe steam systems in larger buildings can be used with baseboards, but in one-pipe systems, the long run of condensing radiation makes it almost

impossible to get the condensate out the same end as the steam enters.

#### Steps in Design

1. *Determine Heat Loss.* The usual calculations for hourly heat loss in BTU should be completed and recorded for each room in the sketch.

2. *Select Baseboards And/Or Radiators.* The order of preference for baseboard location is a) under windows, b) on outside walls, c) on inside walls. As a trial length, outside walls are measured and recorded in each room. Heat loss of the room per ft of baseboard should be computed. The max required output (515 BTU per ft in the living room) sets the water

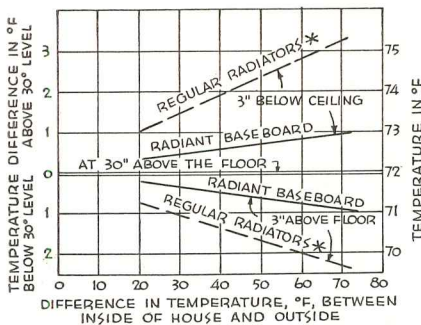

**A Chart A.** Room air temperature at various levels: at 70 deg inside to outside temp., a difference of 2 deg between floor and ceiling is shown for baseboards against almost 6 deg for radiators. \*Small tube recessed radiators

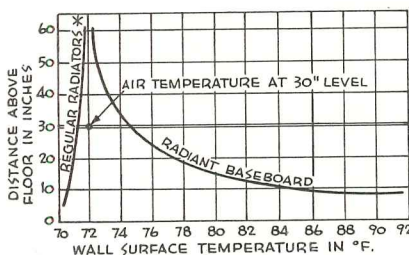

**B Chart B.** Radiant baseboard keeps lower walls warmer, overcomes cold floors. Overall mean radiant temp. is not higher with baseboards because radiators produce a hot ceiling. Studies made when temp. indoors at 30 in. level was 72 deg, outdoors 32 deg

#### Circuits and Piping (Right)

I. Least expensive to install. Adequate heat but no individual control of units. If pipes drop to avoid doorways as at point A, drainage must be provided at point B.

II. Most popular for small and average size installations. Control of individual units by valves.

III. Best for large installations. Each base element controlled separately and receives water at max. temp. directly from supply main

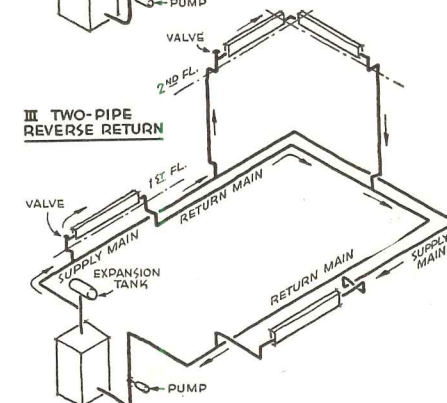
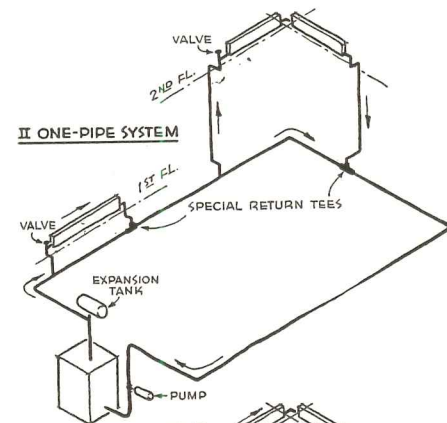
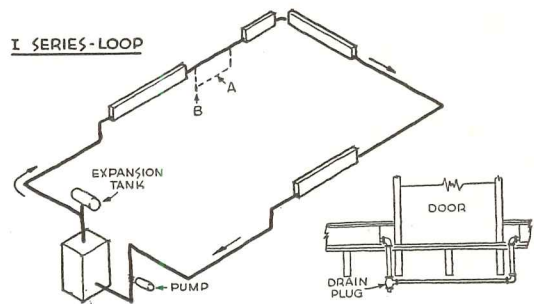

Note: Charts A and B from University of Illinois Bulletin No. 358 — A Study of Radiant Baseboard Heating.

## HEATING SYSTEMS FOR HOUSES

By William J. McGuinness

### Cast Iron Baseboard Heating Systems: 2 — Types of Heaters

temperature which must be used throughout the system. In this case 200 F (the max recommended by some manufacturers) is chosen as the average water temperature and results in base lengths which fit the space. Base of the desired height and type may be selected from Tables 5-8 to make up heat losses. Cast iron radiators may be used with cast iron baseboards. Table 3 gives a heat emission of 210 BTU per hr for 1 sq ft of radiation at 200 F. Dividing the loss in the kitchen and bathroom by this rate (there is not room in these spaces for baseboard) we find that 26.7 and 10.9 sq ft respectively are needed. From Table 4 radiators may be selected to make up this footage. It is necessary in selecting baseboard lengths to leave space for expansion, piping and end cover boxes for valves.

3. *Select Boiler.* A boiler with a net rating of 45,000 BTU per hr will be adequate for this system. Boilers are made large enough to supply the pick up, pipe loss and domestic hot water needs, unless these are unusual.



4. *Select Air Cushion Tank.* To facilitate expansion in the system, allow 1 gal of tank volume for each 30 sq ft of radiation. Dividing 222.9 sq ft by 30, the min volume usable is 7.4 and the next larger stock size tank will be selected.

5. *Select Pump Size.* Tables used are based on a temperature drop in the system of 20 F. Since this is the drop we have chosen, use Table 9 to select a pump size. Since our heat loss is below 50,000 BTU per hr, a 1 in. standard pump is acceptable. The head developed by the pump in supplying water to make up the heat loss at the given temperature drop may be found from Table 10. For a 1 in. pump and nearly 50,000 BTU per hr, the head will be about 5.25 ft.

6. *Determine Main Size.* In determining the length of the system it is usual to allow 12 ft for each heating element in addition to the measured length of the main. The total of these

I-B-R means Institute of Boiler and Radiator Mfrs. Col. 4 in table gives manufacturers' ratings.

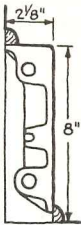
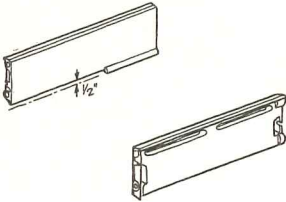
(Continued on page 122)

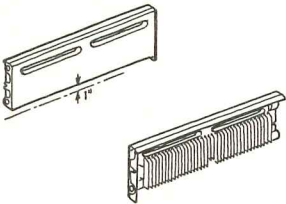
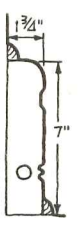
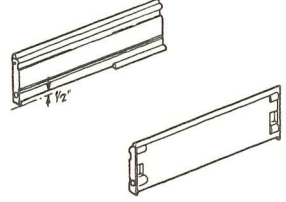
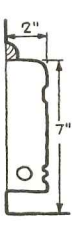
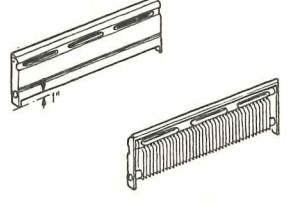
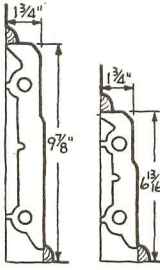
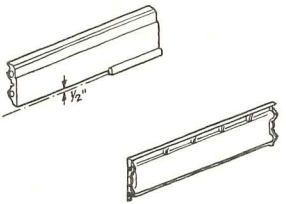
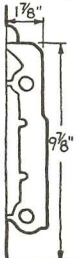
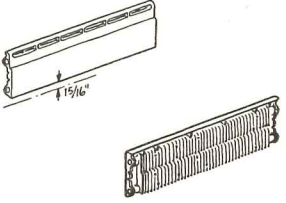
MFR. TYPE & I-B-R RATING	Table I - BASEBOARD HEATER UNITS			SQ. FT./FT. RATING
	DIMENSIONS	FRONT VIEWS	BACK	
AMERICAN RADIATOR  R  LOW 1.25				1.25
AMERICAN RADIATOR  RC  LOW 2.08				2.08
BURNHAM  R  LOW 1.25				1.25
BURNHAM  RC  LOW 2.08				2.08
CRANE  R HIGH 1.77  LOW 1.25				HIGH 1.77  LOW 1.25
CRANE  RC  HIGH 2.92				2.92

### HEATING SYSTEMS FOR HOUSES

(Continued from page 121)

#### Cast Iron Baseboard Heating Systems: 3 — Design

By William J. McGuinness

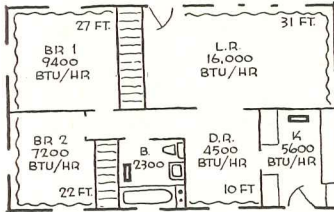

DATA, SKETCH 1

Heat loss and outside wall length

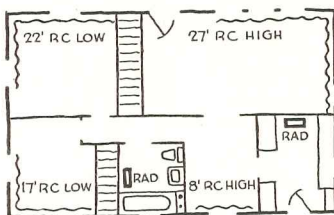

DESIGN, SKETCH 2

Length and type of baseboard

Temp. drop of water in system 20°  
Length of System:

Measured length of main 130  
Radiator allowance  
(6 heating elements x 12) 72  
(Use 200' in Table 11) 202

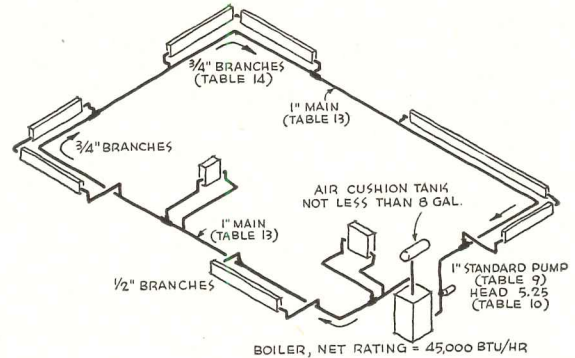

DESIGN OF A RADIANT BASEBOARD HEATING SYSTEM USING ONE-PIPE FORCED HOT WATER

Table 2

DATA, SKETCH 1				DESIGN, SKETCH 2		
1 SPACE	2 BTU/HR HEAT LOSS	3 LINEAR FT. OF EXTERIOR WALL AVAILABLE	4 BTU/LIN. FT. OF EXTERIOR WALL	5 TYPE AND HT. OF BASEB'D SELECTED	6 LENGTH OF BASE TO BE USED	7 SQ. FT. OF RADIATION
L.R.	16,000	31	515	RC HIGH	27'	78.8
D.R.	4,500	10	450	RC HIGH	8'	23.3
K.	5,600	NONE, USE RADIATOR	—	RADIATOR	22'-4T-16SEC	28.8
BR 1	9,400	27	347	RC LOW	22'	45.8
BR 2	7,200	22	327	RC LOW	17'	35.4
BATH	2,300	NONE, USE RADIATOR	—	RADIATOR	22'-4T-6SEC	10.8
TOTALS	45,000					222.9

for the example given is 202 ft. Using this length and the head of 5.25 ft enter Table 11 and find that 1 in. is the right size for a main that will supply the BTU's required.

7. Determine Branch Sizes. Using the lengths of the baseboards in each room, it is found from Table 12 that branches are to be 1/2 and 3/4 in. as recorded on the final piping diagram. Size of branches for small-tube cast iron radiation as used in the kitchen and bath is found from Table I, Sec-

tion B, ARCHITECTURAL RECORD, Nov. 1949, p. 157. Using the total heat loss of 45,000 BTU per hr and main size of 1 in., 1/2 in. branch size is satisfactory for each of the radiators.

#### References

For larger jobs, the reader is referred to: IBR Installation Guide No. 5, *Baseboard Heating Systems* of the Institute of Boiler and Radiator Mfgs. (60 E. 42nd St., New York 17, N. Y.,

50 cents) through whose courtesy the tables have been partially reproduced here; *A Study of Radiant Baseboard Heating in the IBR Research Home* by Alonzo P. Kratz and Warren S. Harris, Engineering Experiment Station Bulletin Series No. 358, Univ. of Illinois, Urbana, Ill., 35 cents; *Heating a Basementless House With Radiant Baseboard* by R. H. Weigel and W. S. Harris, article in *Heating Piping and Air Conditioning*, Nov., 1948.

Table 3 — HEAT EMISSION RATES

AVERAGE RADIATOR TEMPERATURE	BTU/HR PER SQ FT
170.....	150
175.....	160
180.....	170
185.....	180
190.....	190
195.....	200
200.....	210
205.....	220
210.....	230
215.....	240

Table 4 — SMALL TUBE CAST IRON RADIATORS

NO. OF SQ FT OF CAST IRON RADIATION PER SECTION (STANDARD SPACING 1 3/4")		
NO. OF TUBES PER SECTION	HEIGHT	SQ FT OF RADIATION PER SECTION
3	25	1.6
	19	1.6
	22	1.8
4	25	2.0
	22	2.1
5	25	2.4
	19	2.3
6	25	3.0
	32	3.7



## HEATING SYSTEMS FOR HOUSES

(Continued on page 127)

**Cast Iron Baseboard Heating Systems: 4 — Baseboard Rating Tables**

By William J. McGuinness

**Table 5 — TYPE R — LOW HEIGHT**

Length of Assembly Ft	Rating Sq Ft*	Rating, Btu/Hr., at Various Average Water Temperatures									
		215 F	210 F	205 F	200 F	195 F	190 F	185 F	180 F	175 F	170 F
2	2.5	600	570	520	510	490	460	440	410	390	360
3	3.75	900	850	810	770	730	690	660	620	580	550
4	5.0	1200	1140	1080	1030	980	920	870	820	770	730
5	6.25	1500	1420	1360	1290	1220	1160	1090	1030	970	910
6	7.5	1800	1710	1630	1540	1470	1390	1310	1240	1160	1090
7	8.75	2100	1990	1900	1800	1710	1620	1530	1440	1360	1280
8	10.0	2400	2280	2170	2060	1960	1850	1750	1650	1550	1460
9	11.25	2700	2560	2440	2320	2200	2080	1970	1860	1740	1640
10	12.5	3000	2850	2710	2570	2450	2310	2190	2060	1940	1820
11	13.75	3300	3130	2980	2830	2690	2540	2410	2270	2130	2010
12	15.0	3600	3420	3250	3090	2940	2770	2620	2470	2320	2190
13	16.25	3900	3700	3530	3350	3180	3010	2840	2680	2520	2370
14	17.5	4200	3990	3800	3600	3430	3240	3060	2890	2710	2550
15	18.75	4500	4270	4070	3860	3670	3470	3280	3090	2910	2740
16	20.0	4800	4560	4340	4120	3920	3700	3500	3300	3100	2920
17	21.25	5100	4840	4610	4380	4160	3930	3720	3510	3290	3100
18	22.5	5400	5130	4880	4630	4410	4160	3940	3710	3490	3280
19	23.75	5700	5410	5150	4890	4650	4390	4160	3920	3680	3470
20	25.0	6000	5700	5420	5150	4900	4620	4370	4120	3870	3650
21	26.25	6300	5980	5700	5410	5140	4860	4590	4330	4070	3830
22	27.5	6600	6270	5970	5660	5390	5090	4810	4540	4260	4010
23	28.75	6900	6550	6240	5920	5630	5320	5030	4740	4460	4200
24	30.0	7200	6840	6510	6180	5880	5550	5250	4950	4650	4380
25	31.25	7500	7120	6780	6440	6120	5780	5470	5160	4840	4560
26	32.5	7800	7410	7050	6690	6370	6010	5690	5360	5040	4740
27	33.75	8100	7690	7320	6950	6610	6240	5910	5570	5230	4930
28	35.0	8400	7980	7590	7210	6860	6470	6120	5770	5420	5110
29	36.25	8700	8260	7870	7470	7100	6710	6340	5980	5620	5290
30	37.5	9000	8550	8140	7720	7350	6940	6560	6190	5810	5470

**Table 6 — TYPE R — HIGH HEIGHT**

Length of Assembly Ft	Rating Sq Ft*	Rating, Btu/Hr., at Various Average Water Temperatures									
		215 F	210 F	205 F	200 F	195 F	190 F	185 F	180 F	175 F	170 F
2	3.5	850	810	770	730	690	650	620	580	550	520
3	5.3	1270	1210	1150	1090	1040	980	930	870	820	770
4	7.1	1700	1610	1540	1460	1390	1310	1240	1170	1100	1030
5	8.8	2120	2010	1920	1820	1730	1630	1550	1460	1370	1290
6	10.6	2550	2420	2310	2190	2080	1970	1860	1750	1650	1550
7	12.4	2970	2820	2680	2550	2420	2290	2170	2040	1920	1810
8	14.2	3400	3230	3070	2920	2780	2620	2480	2340	2200	2070
9	15.9	3820	3630	3450	3280	3120	2940	2780	2630	2470	2320
10	17.7	4250	4040	3840	3650	3470	3280	3100	2920	2740	2580
11	19.5	4670	4440	4220	4010	3810	3600	3400	3210	3020	2840
12	21.25	5100	4840	4610	4380	4160	3930	3720	3510	3290	3100
13	23.0	5520	5240	4990	4740	4510	4250	4020	3790	3560	3360
14	24.8	5950	5650	5380	5110	4860	4590	4340	4090	3840	3620
15	26.5	6370	6050	5760	5470	5200	4910	4640	4380	4110	3870
16	28.3	6800	6460	6150	5840	5550	5240	4960	4670	4390	4140
17	30.1	7220	6860	6530	6200	5900	5560	5260	4960	4660	4390
18	31.9	7650	7270	6920	6570	6250	5900	5580	5260	4940	4650
19	33.6	8070	7670	7300	6930	6590	6220	5880	5550	5210	4910
20	35.4	8500	8070	7680	7300	6940	6550	6200	5840	5490	5170
21	37.2	8920	8470	8060	7660	7280	6880	6500	6130	5760	5430
22	39.0	9350	8880	8450	8020	7640	7210	6820	6430	6040	5690
23	40.7	9770	9280	8830	8390	8000	7530	7120	6720	6310	5940
24	42.5	10200	9690	9220	8750	8330	7860	7440	7010	6590	6200
25	44.25	10620	10090	9600	9110	8670	8190	7740	7300	6860	6460
26	46.0	11050	10500	9990	9480	9020	8520	8060	7600	7140	6720
27	47.8	11470	10900	10370	9840	9370	8840	8360	7890	7410	6980
28	49.6	11900	11300	10760	10210	9720	9170	8680	8180	7690	7240
29	51.3	12320	11700	11140	10570	10060	9500	8980	8470	7960	7490
30	53.1	12750	12110	11530	10940	10400	9830	9300	8770	8230	7760

\*Based on the common standard emission rate of 240 Btu per hour per sq ft at 215 F.

## PRODUCTS for Better Building

George M. Cushing, Jr., Photos

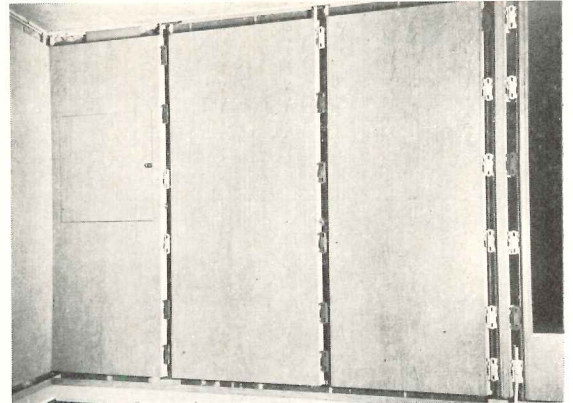
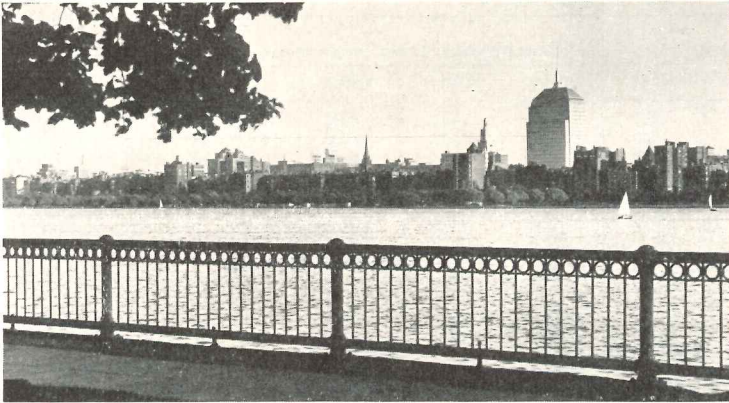

An important design consideration in Boston's new John Hancock Building was the requirement of complete flexibility of office space. Re-usable metal partitioning, along with continuous suspended ceilings, was the solution of Cram & Ferguson, Architects

### MILES OF RE-USABLE METAL PARTITIONING TO REDUCE COSTS IN JOHN HANCOCK

Throughout the John Hancock Building, as stated in the November 1949 ARCHITECTURAL RECORD, full performance and easy maintenance were paramount design criteria. In a building containing, as this one does, over 630,000 sq ft of office space, ease in rearranging office partitions is fundamental. To keep maintenance costs down, even the interior surfacing of exterior walls is preferably easily demounted, so that wiring, controls, and heating and air conditioning ducts can be reached quickly; all interior surfaces have to be easy to clean.

*Hauserman Movable Steel Partitions and Wainscoting* were used in offices, lounges, etc., on 23 floors of the building. Though not brand-new products, their

use on such a scale is noteworthy. Finish of the panels is baked-on enamel designed to withstand commercial cleaning solvents for years, although wiping with a damp cloth is all that is normally expected here. Numerous colors, wood graining, etc., of finish are available. Materials are totally incombustible, and the noise-detering panels contain built-in electrical raceways.

The flush, acoustic-tile ceilings used are essential if full benefits of easy removal and replacement of walls are to be realized: an important adjunct of *Hauserman Movable Steel Interiors* is *Hauserman Acoustical Steel Pan Ceilings*. Flexibility and maintenance are equally important in small business buildings; see this month's Building Types Study.

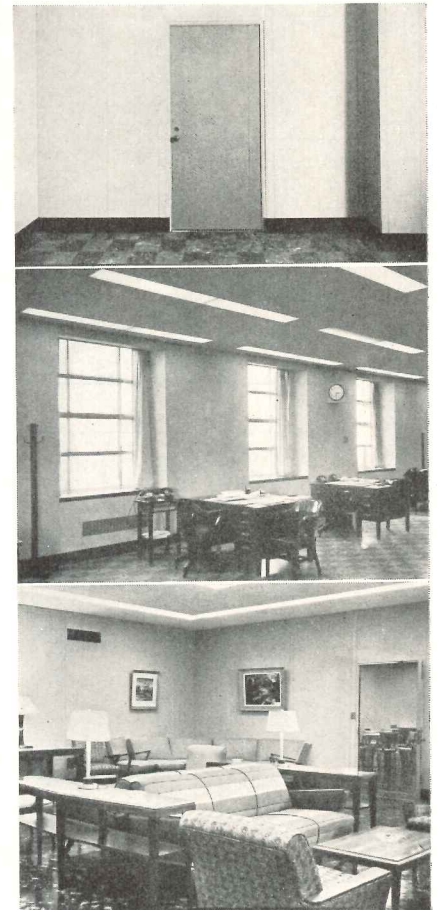

### *Packaged Flooring*

*Laytile* packaged flooring, a new idea in merchandising hardwood flooring, furnishes assorted short lengths of matched hardwood sufficient to cover 10 sq ft. The flooring is put up in sealed cardboard cartons marked with contents, grade, scale and exact cost. Sized for easy handling, the cartons are said to keep the wood clean and dry and the

moisture content more uniform. Labor saving is reported in figuring additions for matching and computing the cost for a given floor area. The Connor Lumber and Land Co., P. O. Box 112X, Marshfield, Wis.

### *Window Shades*

The *Draper X-L Window Shading Unit* incorporates several shades mounted

on a special roller bracket for shading or darkening rooms with wide or multiple windows or glass block areas. It was designed to eliminate the use of extremely wide shades in schools, offices, etc.

The unit is made to order with any number of shades and in any width. The mounting consists of a steel angle

(Continued on page 160)

# Brasco

## STORE FRONTS

IN THE  
**FOREFRONT** *for*  
**OVER 40 YEARS**



"Modern" BRASCO Installation  
*Vintage of 1917*

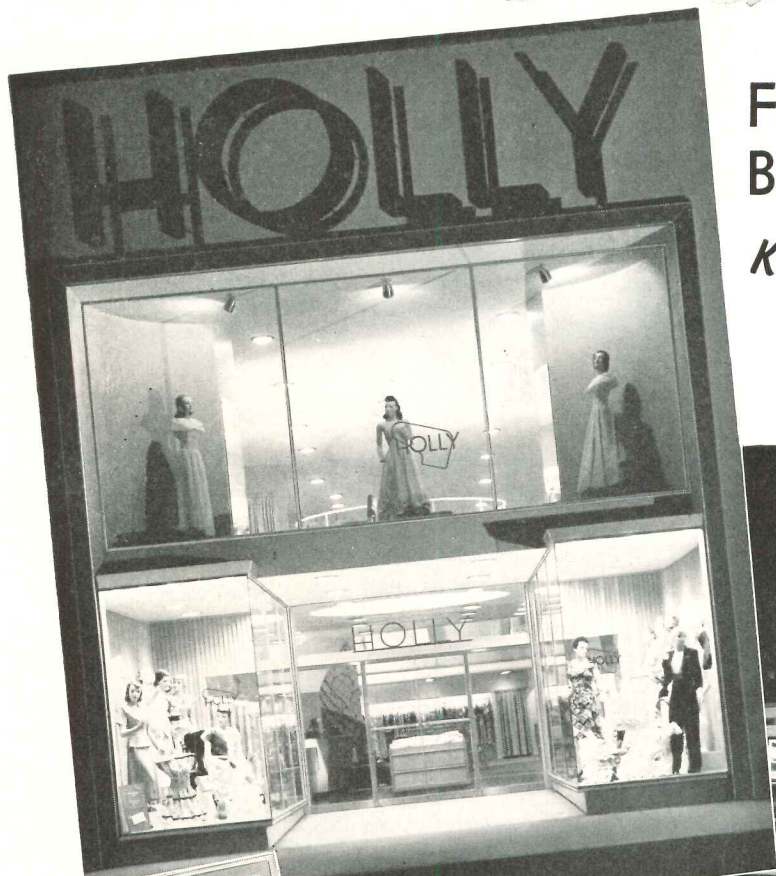

Archts. Sidney H. Morris & Associates, Chicago

FROM THE 1950  
 BRASCO CATALOG

*Keeping pace with the advance  
 of architectural design*



Designed by Philip Rawson, Fort Worth



**NEW . . . MAIL COUPON FOR YOUR FREE COPY . . .**

**BRASCO MANUFACTURING CO., HARVEY, ILLINOIS**

(R10)

Send the NEW BRASCO CATALOG to

Name .....

Firm .....

Address .....

City ..... Zone ..... State .....

For the windows at Bendix Airport it's

Maintenance: Zero!

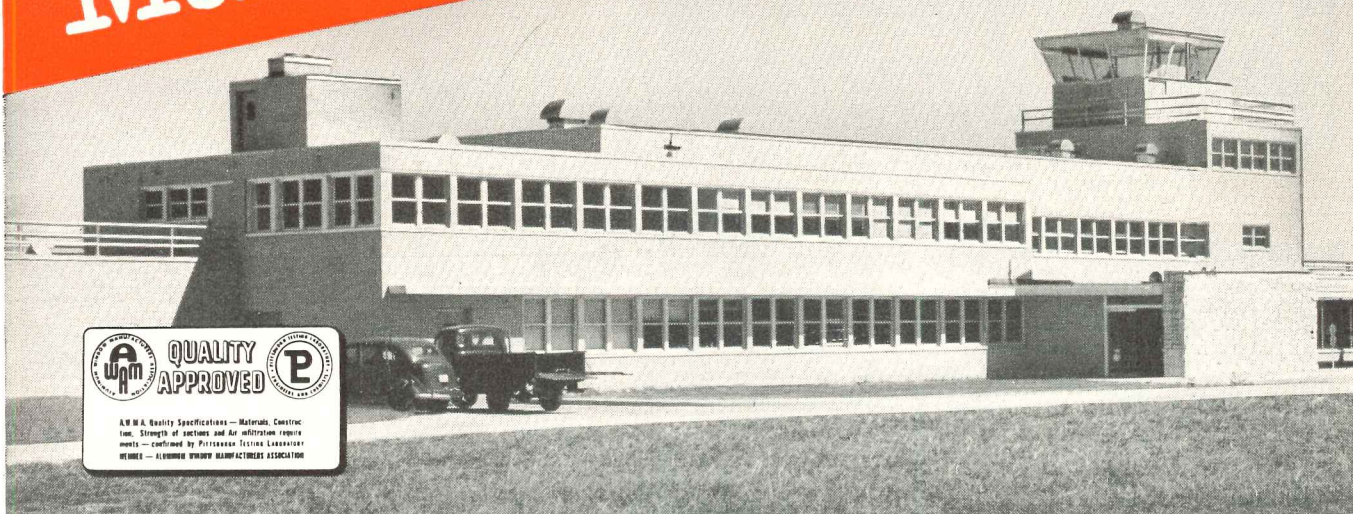

Bendix Airport, South Bend, Indiana.  
Architect: Roy S. Worden. Contractor: S-L-A-B Construction Co., South Bend, Ind.

The **Adlake Aluminum Windows** installed in the new Bendix Airport, South Bend, Indiana, will save plenty of money in coming years because they *eliminate maintenance costs!* In fact, over a period of time, they'll pay for themselves. For Adlake Windows require no painting, no maintenance other than routine washing—and they'll last as long as the building.

**Only Adlake Windows** have the combination of woven-pile weather stripping and patented serrated guides that assure minimum air infiltration and absolute finger-tip control. And Adlake Windows never warp, rot, rattle, stick or swell. They keep their good looks and smooth operation for the life of the building.

For full information on how Adlake Aluminum Windows can give you worry-free, no-maintenance service, drop a post card today to the Adams & Westlake Company, 1101 North Michigan Avenue, Elkhart, Indiana. No obligation, of course.

### ADLAKE ALUMINUM WINDOWS have these "plus" features

- Minimum Air Infiltration
- Finger-tip Control
- No Warp, Rot, Rattle, Stick
- No Painting or Maintenance
- Ease of Installation



THE **Adlake** COMPANY

Established 1857 • ELKHART, INDIANA • New York • Chicago

## HEATING SYSTEMS FOR HOUSES

(Continued on page 129)

Cast Iron Baseboard Heating Systems: 5 — Baseboard Rating Tables Continued

By William J. McGuinness

**Table 7 — TYPE RC — LOW HEIGHT**

Length of Assembly Ft	Rating Sq Ft*	Rating, Btu/Hr, at Various Average Water Temperatures									
		215 F	210 F	205 F	200 F	195 F	190 F	185 F	180 F	175 F	170 F
2	4.2	1000	950	900	860	820	770	730	690	650	610
3	6.25	1500	1420	1360	1290	1220	1160	1090	1030	970	910
4	8.3	2000	1900	1810	1720	1630	1540	1460	1370	1290	1220
5	10.4	2500	2370	2260	2150	2040	1930	1820	1720	1610	1520
6	12.5	3000	2850	2710	2570	2450	2310	2190	2060	1940	1820
7	14.6	3500	3320	3160	3000	2860	2700	2550	2410	2260	2130
8	16.7	4000	3800	3620	3430	3270	3080	2920	2750	2580	2430
9	18.75	4500	4270	4070	3860	3670	3470	3280	3090	2910	2740
10	20.8	5000	4750	4520	4290	4080	3850	3650	3440	3230	3040
11	22.9	5500	5220	4970	4720	4490	4240	4010	3780	3550	3350
12	25.0	6000	5700	5420	5150	4900	4620	4370	4120	3870	3650
13	27.1	6500	6170	5880	5580	5310	5010	4740	4470	4200	3950
14	29.2	7000	6650	6330	6010	5720	5400	5100	4810	4520	4260
15	31.25	7500	7120	6780	6440	6120	5780	5470	5160	4840	4560
16	33.3	8000	7600	7230	6870	6530	6170	5830	5500	5170	4870
17	35.4	8500	8070	7680	7300	6940	6550	6200	5840	5490	5170
18	37.5	9000	8550	8140	7720	7350	6940	6560	6190	5810	5470
19	39.6	9500	9020	8590	8150	7760	7320	6930	6530	6130	5780
20	41.7	10000	9500	9040	8580	8170	7710	7290	6870	6460	6080
21	43.75	10500	9970	9490	9010	8570	8090	7660	7220	6780	6390
22	45.8	11000	10450	9950	9440	8980	8480	8020	7560	7100	6690
23	47.9	11500	10920	10400	9870	9390	8860	8380	7910	7430	7000
24	50.0	12000	11400	10850	10300	9800	9250	8750	8250	7750	7300
25	52.1	12500	11870	11300	10730	10210	9630	9110	8590	8070	7600
26	54.2	13000	12350	11750	11160	10620	10020	9480	8940	8400	7910
27	56.25	13500	12820	12210	11590	11020	10410	9840	9280	8720	8210
28	58.3	14000	13300	12660	12020	11430	10790	10210	9620	9040	8520
29	60.4	14500	13770	13110	12440	11840	11180	10570	9970	9360	8820
30	62.5	15000	14250	13560	12870	12250	11560	10940	10310	9690	9120

**Table 8 — TYPE RC — HIGH HEIGHT**

Length of Assembly Ft	Rating Sq Ft*	Rating, Btu/Hr, at Various Average Water Temperatures									
		215 F	210 F	205 F	200 F	195 F	190 F	185 F	180 F	175 F	170 F
2	5.8	1400	1330	1200	1210	1140	1080	1020	960	900	850
3	8.75	2100	1990	1900	1800	1710	1620	1530	1440	1360	1280
4	11.7	2800	2660	2530	2400	2290	2160	2040	1920	1810	1700
5	14.6	3500	3320	3160	3000	2860	2700	2550	2410	2260	2130
6	17.5	4200	3990	3800	3600	3430	3240	3060	2890	2710	2550
7	20.4	4900	4650	4430	4210	4000	3780	3570	3370	3160	2980
8	23.3	5600	5320	5060	4810	4570	4320	4080	3850	3620	3410
9	26.25	6300	5980	5700	5410	5140	4860	4590	4330	4070	3830
10	29.2	7000	6650	6330	6010	5720	5400	5100	4810	4520	4260
11	32.1	7700	7310	6960	6610	6290	5930	5610	5290	4970	4680
12	35.0	8400	7980	7590	7210	6860	6470	6120	5770	5420	5110
13	37.9	9100	8640	8230	7810	7430	7010	6630	6260	5880	5540
14	40.8	9800	9310	8860	8410	8000	7550	7150	6740	6330	5960
15	43.75	10500	9970	9490	9010	8570	8090	7660	7220	6780	6390
16	46.7	11200	10640	10130	9610	9150	8630	8170	7700	7230	6810
17	49.6	11900	11300	10760	10210	9720	9170	8680	8180	7680	7240
18	52.5	12600	11970	11390	10810	10290	9710	9190	8660	8140	7660
19	55.4	13300	12630	12020	11420	10860	10250	9700	9140	8590	8090
20	58.3	14000	13300	12660	12020	11430	10790	10240	9620	9040	8520
21	61.25	14700	13960	13290	12620	12000	11330	10720	10110	9490	8940
22	64.2	15400	14630	13920	13220	12580	11870	11230	10590	9950	9370
23	67.1	16100	15290	14560	13820	13150	12410	11740	11070	10400	9790
24	70.0	16800	15960	15190	14420	13720	12950	12250	11550	10850	10220
25	72.9	17500	16620	15820	15020	14290	13490	12760	12030	11300	10650
26	75.8	18200	17290	16460	15620	14860	14030	13270	12510	11750	11070
27	78.75	18900	17950	17090	16220	15430	14570	13780	12990	12210	11500
28	81.7	19600	18620	17720	16820	16010	15110	14290	13470	12660	11920
29	84.6	20300	19280	18350	17420	16580	15650	14800	13960	13110	12350
30	87.5	21000	19950	18990	18020	17150	16190	15310	14440	13560	12770

\*Based on the common standard emission rate of 240 Btu/Hr per sq ft at 215 F.

*of course you'll use*

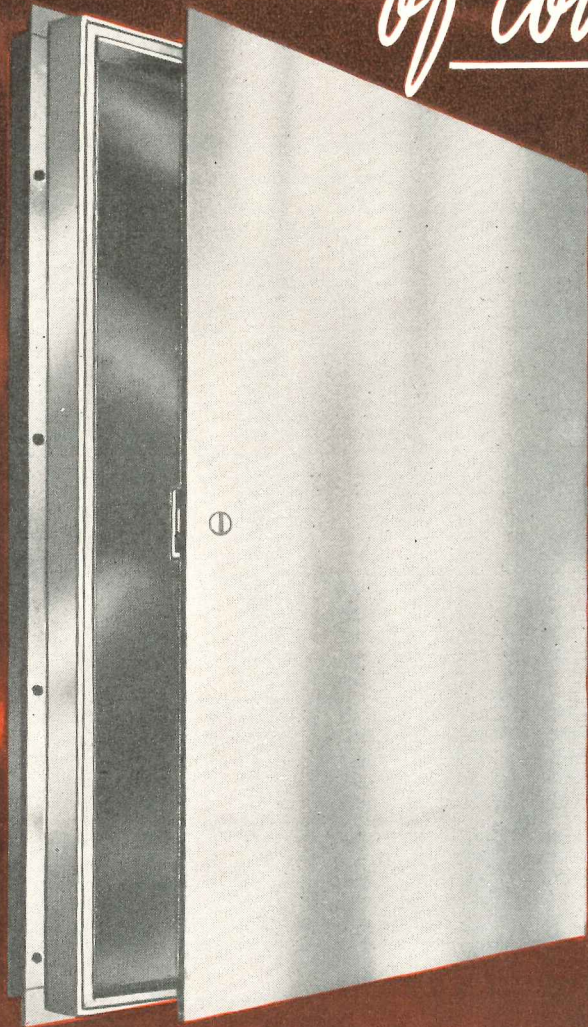

**MILCOR**

**Metal  
Access  
Doors**

*The finest Access Door for every purpose*

**Flush with the wall for durable good looks**

- ▶ **Quick, easy installation:** for plastered or non-plastered walls.
- ▶ **Trim, modern appearance:** no frame or dust-catching projections — paint or paper right over the surface.
- ▶ **Lifetime service:** permanent steel — can't warp, crack, shrink, or rot.

F-334

**INLAND STEEL PRODUCTS COMPANY**

*Formerly Milcor Steel Company*

4035 WEST BURNHAM STREET • MILWAUKEE 1, WISCONSIN

Baltimore 24, Md. • Buffalo 11, N.Y. • Chicago 9, Ill. • Cincinnati 25, Ohio  
Cleveland 14, Ohio • Detroit 2, Mich. • Kansas City 8, Mo. • Los Angeles 23, Calif.  
New York 22, N.Y. • Rochester 9, N.Y. • St. Louis 10, Mo.

## HEATING SYSTEMS FOR HOUSES

### Cast Iron Baseboard Heating Systems: 6 — Design Details

(Continued from page 127)

By William J. McGuinness

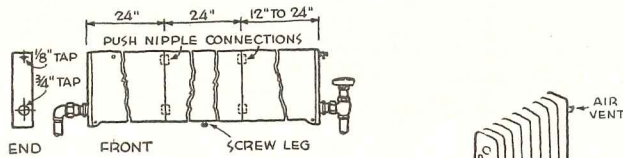

Length of end sections is commonly 12 or 24 in., intermediate sections 24 in. †

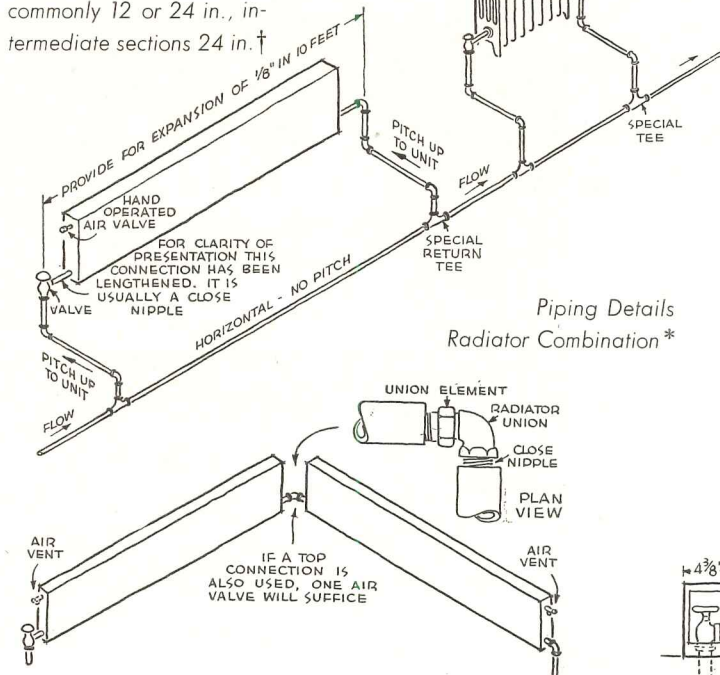

\* American Radiator Co. Details

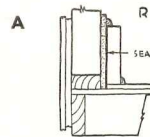

**A. Air Seal.** Building paper, aluminum foil or asbestos paper must be placed behind base heaters to prevent streaks on wall. It is turned down under top moulding

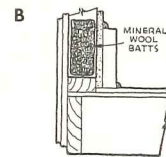

**B. Insulation.** Full insulation is advisable to reduce heat loss and shorten base length. Use of batts behind base is necessary

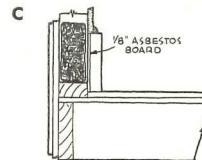

**C. Recessing.** Bulk of base may be reduced by recessing in amount of plaster thickness. Base must be backed by a 1/8 in. board

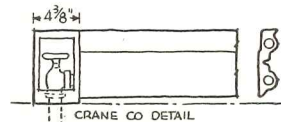

Valve enclosure lengths:

American Radiator—6<sup>3</sup>/<sub>4</sub> in.  
Burnham —5 in.  
Crane —4<sup>3</sup>/<sub>8</sub> in.

Total Load on System Btu/Hr.	Standard Pump
Up to 50,000	1"
50,001 to 100,000	1 <sup>1</sup> / <sub>4</sub> "
100,001 to 150,000	1 <sup>1</sup> / <sub>2</sub> "
Over 150,001	1 <sup>3</sup> / <sub>4</sub> "

Total Load Btu/Hr.	PRESSURE HEAD IN FT. OF WATER		
	Standard Pump		
	1"	1 <sup>1</sup> / <sub>4</sub> "	1 <sup>1</sup> / <sub>2</sub> "
25,000	5.50	6.25	6.75
50,000	5.25	6.00	6.75
75,000	4.75	5.75	6.50
100,000	4.50	5.50	6.50
125,000	4.00	5.25	6.25

Location of Baseboard	If Baseboard is 10 ft. or less in Length	If Baseboard is Longer than 10 ft.*
1st Floor Below Main	3/4"	3/4"
1st Floor Above Main	1/2"	3/4"
2nd Floor Above Main	3/4"	3/4"

Measured Length plus radiator allowance, Ft.	Capacity in Btu/ Hr.			
	3/4" Pipe	1" Pipe	1 <sup>1</sup> / <sub>4</sub> " Pipe	1 <sup>1</sup> / <sub>2</sub> " Pipe
100	34,000	64,000	116,000	176,000
110	33,000	63,000	113,000	172,000
120	32,000	61,000	110,000	168,000
130	31,000	60,000	107,000	164,000
140	30,000	58,000	104,000	160,000
150	30,000	56,000	101,000	156,000
160	29,000	54,000	99,000	153,000
170	28,000	53,000	98,000	150,000
180	27,000	52,000	96,000	147,000
190	27,000	51,000	94,000	144,000
200	26,000	50,000	92,000	141,000
210	25,000	49,000	90,000	139,000
220	25,000	48,000	89,000	136,000
230	24,000	47,000	87,000	134,000
240	24,000	46,000	86,000	132,000
250	24,000	45,000	84,000	130,000
300	21,000	41,000	78,000	120,000
400	19,000	36,000	68,000	105,000
500	16,000	33,000	62,000	95,000
600	15,000	30,000	56,000	88,000

† It is recommended that not more than 40 lin ft. of baseboard be connected to the main with a single supply and return riser.

# ANNOUNCING

# The Lupton "Master"

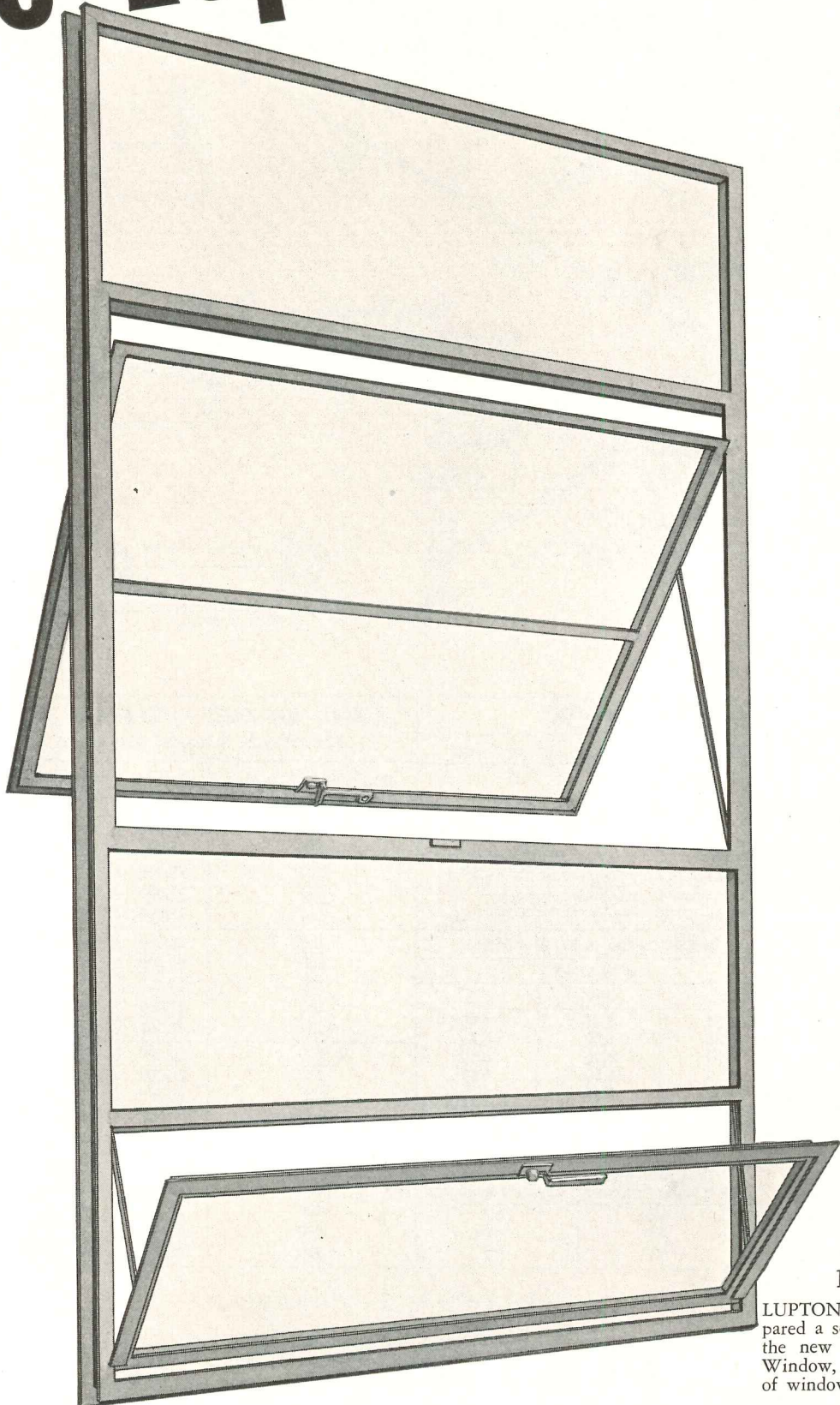

#### DATA SHEETS

LUPTON window engineers have prepared a set of practical Data Sheets for the new Lupton "Master" Aluminum Window, including full size drawings of window sections. Write for your



# Aluminum Window

## Specially Designed for Hospitals, Schools and Office Buildings

A really important development in window design — the new Lupton "Master" Aluminum Window.

From a design standpoint, it opens up great new opportunities in window planning—better appearance, minimum infiltration and a greater adaptability to modern building design.

From a construction standpoint, it sets new standards of high durability and low maintenance costs.

Check these features of the new Lupton "Master" Aluminum Window:

- (1) **NEW DEEP SECTIONS** — both frames and ventilators 1-5/8 inches — sturdier without sacrificing lightness — added strength in this new Lupton Window.
- (2) **PRECISION WEATHERING** — Ventilators fit snug and tight—naturally—without forcing. Full 5/16 inch overlapping contact.
- (3) **SPECIAL HEAT TREATED ALUMINUM ALLOY** used in this new Lupton Window eliminates painting and costly repair and maintenance.
- (4) **STURDY CONSTRUCTION**—welded ventilator corners—strength where strength is needed.

The new Lupton "Master" Aluminum Window is the newest member of a great family of metal windows—Lupton. A family of windows that has grown up through more than forty years, with the constant development of new designs, new materials, and new production techniques to meet the changing demands of the constantly changing building industry. You will find it well worth your serious consideration.

MICHAEL FLYNN MANUFACTURING COMPANY

700 East Godfrey Avenue, Philadelphia 24, Penna.

# LUPTON METAL WINDOWS

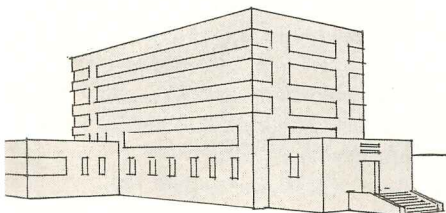
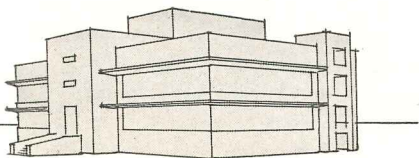
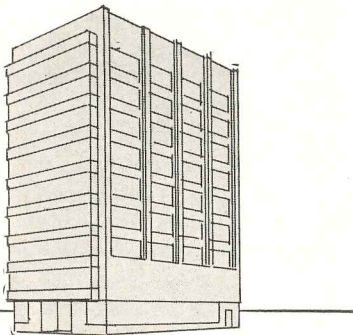

## MANUFACTURERS' LITERATURE

### Plastic Skylights

Save  $\frac{1}{3}$  to  $\frac{1}{2}$  On Cost of Day-Lighting For Your Corrugated Buildings. Pamphlet describes properties and uses of Corrulux — a corrugated, translucent plastic building sheet. Dimensions for

stock flat or curved sizes, and installation notes are included with photographs and sketches of typical installations in corrugated metal and asbestos buildings. 4 pp., illus. Corrulux Corp., P. O. Box 6524, 410 Holmes Rd., Houston, Tex.



*Specify*

## CABOT'S WATERPROOFINGS

to protect exterior masonry surfaces from unsightly efflorescence and the expensive damage caused by water seepage followed by freezing and thawing. Cabot's Waterproofings penetrate deep into voids and pores of masonry walls... provide a long lasting moisture resistant seal. Walls treated as much as twenty years ago with Cabot's Waterproofings are still moisture-proof today.

USE CABOT'S CLEAR CEMENT WATERPROOFING for Cement, Stucco, Cast Stone and all light colored masonry.

USE CABOT'S CLEAR BRICK WATERPROOFING for Red Brick and Dark Colored Masonry.

WRITE TODAY for samples of Cabot's Waterproofings and complete information.

**Samuel Cabot, Inc.** 122 Oliver Building  
Boston 9, Mass.

### Garage Doors

*Crawford Stylist Garage Door Design Sheet.* Gives a number of ruled outlines for sketching personal garage door designs. Sketches suggest possible solutions. An accompanying folder presents construction details and features of Stylist plywood lift doors. 4 pp., 4 pp., illus. Crawford Door Co., 1-401 St. Jean, Detroit 14, Mich.\*

### Air Diffusers

(1) *Pyle-National Multi-Vent Low Velocity Air Diffusion;* (2) *A Multi-Vent Story.* The first folder lists construction qualities, application, selection and notes on use of the perforated metal diffusers. Design and dimension tables are included with cross section details of diffusers concealed in plastered, perforated metal acoustical tile and mineral acoustical tile ceilings. The second folder pictures six interiors employing the vent panels and gives operation features. 4 pp., 6 pp., illus. The Pyle-National Co., Multi-Vent Div., 1334 N. Kostner Ave., Chicago 51, Ill.\*

### Fire Doors

*St. Louis Doors.* Booklet describes metal clad and motor operated freight elevator doors, dumbwaiter doors and Alsteel fire doors. Construction, operation, material and workmanship are explained. Details are included for each of the door types, along with sketches, diagrams and specifications. 12 pp., illus. St. Louis Fire Door Co., 1134 S. 6th St., St. Louis 7, Mo.\*

### Industrial Flooring

*Rulon Industrial Floorings and Acid-proof Construction.* Presents floorings for industrial use including asphalt mastic, Mastipitch, Con-Duct (for use with inflammable processes), dampproof sub-flooring, and acidproof brick. Some waterproofing materials and protective coatings are also covered. Descriptions, details and specifications are given. 8 pp., illus. Ralph V. Rulon, Inc., 3900 N. 2nd St., Philadelphia 40, Pa.

(Continued on page 134)

\*Other product information in Sweet's File, 1949.

# DAYLIGHTING AUTHORITY

tells how to



Get  
Better Classroom  
Daylighting

Page 8 of our 16-page guidebook on better school daylighting, a factual, helpful book based on sound, tested engineering principles.

with economical  
commercially-available materials

Following two years of research at Southern Methodist University, Professor R. L. Biesele, Jr., chairman of the Daylighting Committee of the Illuminating Engineering Society, has reported his findings. Fenestra\* has made them available for all who are interested in better classroom daylighting.

These tests show how every school can afford the kind of lighting needed for better seeing, better attention to work, better health. It's a matter of using clear glass in windows big enough to do the job, of light-reflecting surfaces to redistribute the daylight and avoid annoying bright spots, of proper

seating arrangement, etc. This is all explained in our new book and backed up with scientific proof of the methods recommended.

Standardization of types and sizes, plus the use of solid, rolled-steel casement sections of advanced design, assembled by craftsmen of America's oldest and largest steel window manufacturer, provides windows of outstanding high quality at economical prices . . . windows which provide easy opening, control of fresh-air ventilation, fire-safety, easy cleaning. See your Fenestra representative (listed in your Yellow Telephone Directory)—or mail the coupon—for full details. \*®

*Fenestra*

STANDARDIZED

{ WINDOWS  
PANELS  
DOORS

DETROIT STEEL PRODUCTS COMPANY  
Dept. AR-1,  
2252 E. Grand Blvd.,  
Detroit 11, Michigan

Please send immediately your free new booklet on "Better Classroom Daylighting."

Name \_\_\_\_\_

Company \_\_\_\_\_

Address \_\_\_\_\_

## LITERATURE

(Continued from page 132)

### Fluorescent Fixture Hangers

*Unistrut, the New Better Way to Hang Fluorescent Fixtures.* Bulletin pictures installation steps and the component parts and assemblies of the fixture

hanger. Information is included on the features and uses of the unit. Tables give sizes and recommended hanger rod spacing. 4 pp., illus. Unistrut Products Co., 1013 W. Washington Blvd., Chicago 7, Ill.

### Laminated Fiber Panels

*Directions for Application of Upson Strong-Bilt Panels in New Construction.* Booklet gives instructions and pictures

for the various steps in applying the panels. Separate sections are devoted to planning the job, ceilings, side-walls, moulding application, relief ornaments and decoration by painting or papering. Specifications and photographs of three interiors are included. The Upson Co., Lockport, N. Y.\*

### Termite Proofing

*Guarding Your Property Against Damage Like This (Bulletin T-49).* Tells how to protect wood from insect attack by chemical preservatives. Termite habits and signs of infestation are explained, and directions are given on how to prevent attack and how to save wood already infested. Pictures and drawings illustrate the methods in various types of construction. Powder-post beetles and dry wood termites and their control are also discussed. 6 pp., illus. Chapman Chemical Co., 770 Dermon Bldg., Memphis 3, Tenn.

### Metal Windows

*Lupton Metal Windows and Doors (1950 Catalog).* Incorporates specifications, details and data on steel and aluminum residence casements, casement doors, steel casings, basement and utility windows, architectural projected windows, pivoted and commercial projected windows, security windows, industrial doors, continuous windows and mechanical operators. Screens, window hardware and picture window frames are also included. 33 pp., illus. Michael Flynn Mfg. Co., 700 E. Godfrey Ave., Dept. B, Philadelphia 24, Penn.\*

### Copper Flashing

(1) *Revere-Keystone Interlocking Thru-Wall Flashing;* (2) *Revere-Simplex Reglet System For Flashing Spandrel Beams.* Folders present specifications and details of a new interlocking copper flashing system. Details cover flashing installations in parapets, lintels, water tables, foundation walls, sills, spandrels, columns and party walls. 8 pp., 6 pp., illus. Revere Copper and Brass Inc., 230 Park Ave., New York 17, N. Y.\*

### Heating, Air Conditioning

*Hospital Heating and Air Conditioning Control Systems.* Describes specialized heating and air conditioning control requirements for hospitals. Discusses in non-technical terms the various atmospheric requirements of different hospital rooms and areas. Minneapolis-Honeywell Regulator Co. % John Bergan, Minneapolis, Minn.

(Continued on page 176)



the Balanced Door AT IDLEWILD INTERNATIONAL AIRPORT

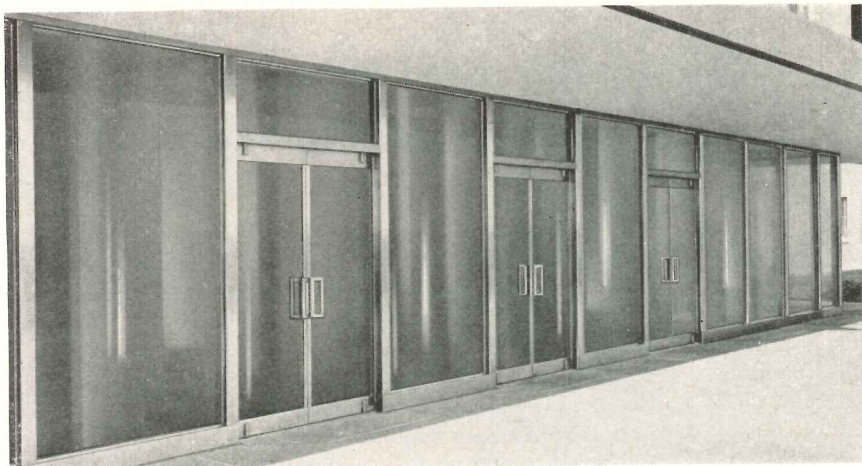

Enduring Beauty • Ease of Operation • Economy of Maintenance

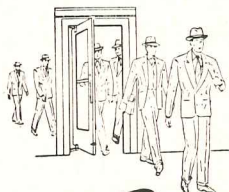

The Door that lets  
TRAFFIC through QUICKLY

**Ellison**  
the BALANCED DOOR

ELLISON BRONZE CO.

Jamestown, New York

representatives in 71 principal cities

Here's the low-cost way to air condition  
existing buildings—large or small—

# Specify Frigidaire Multiple-Unit Air Conditioning!

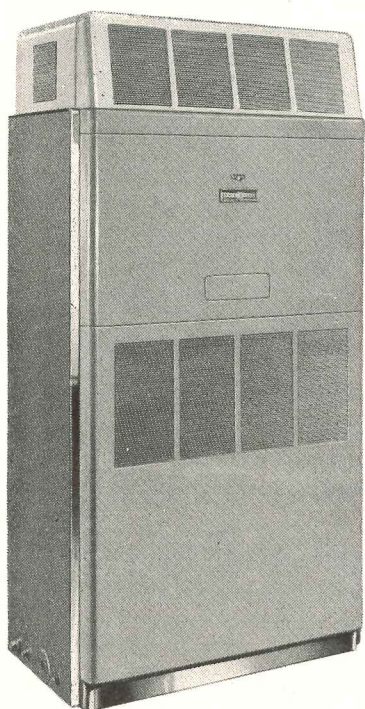
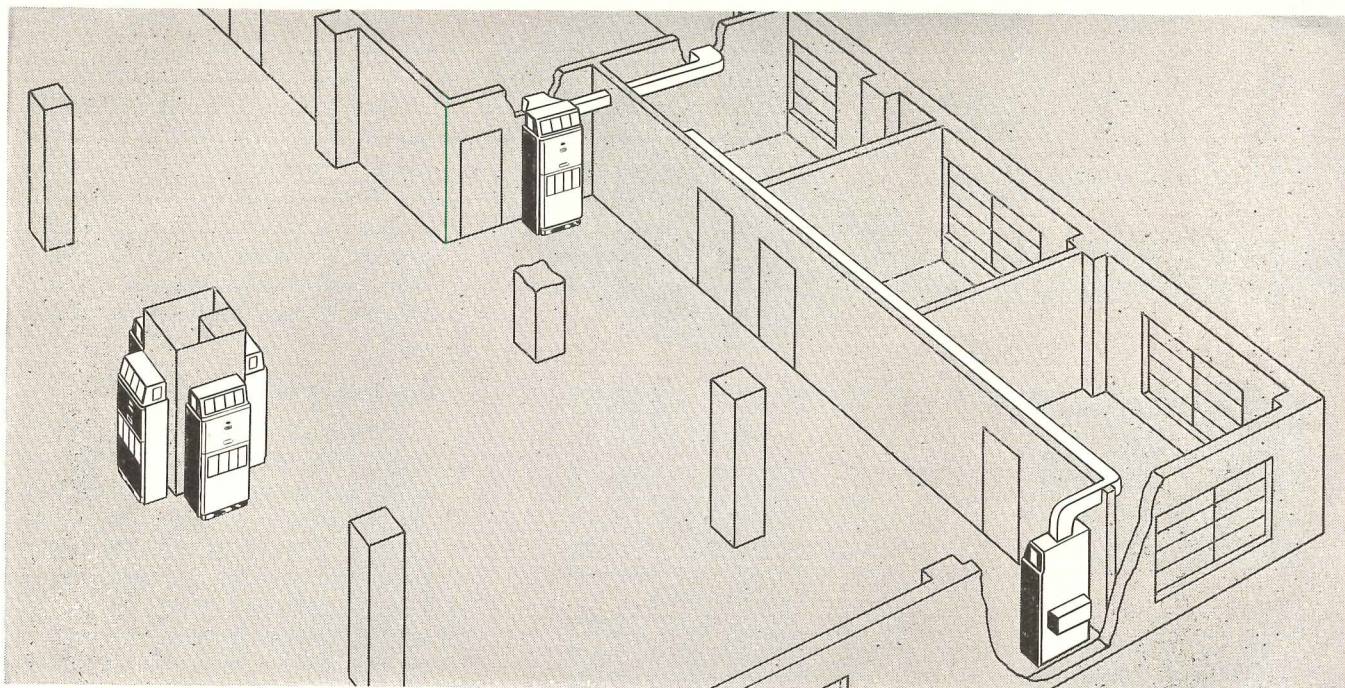

Yes, Frigidaire Multiple-Unit Air Conditioning is the low-cost way to handle existing buildings — and new buildings, too — because it's the fastest, simplest way you can find! *Installation* costs are low, for little duct work is needed — no major building alteration. And *operating* costs are equally low, for individual Frigidaire units automatically turn off or on as needed — can be serviced without affecting other space.

**Compact, good-looking** Frigidaire Self-Contained Air Conditioners are styled by Raymond Loewy, designed and built by Frigidaire in capacities of 3 and 5 tons.

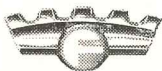

Over 400 Frigidaire commercial refrigeration and air conditioning products — most complete line in the industry.

For further information about Frigidaire Multiple-Unit Air Conditioning, fill out and mail the coupon below. Or call your dependable Frigidaire Dealer. He'll be glad to give you full details about this type of conditioning, as well as Frigidaire Room Conditioners and Frigidaire Central Systems. You'll find his name in your Classified Phone Directory, under "Air Conditioning" or "Refrigeration Equipment."

Frigidaire Division of General Motors  
1416 Amelia Street, Dayton 1, Ohio  
(In Canada, Leaside 12, Ontario)

Please have your representative contact me regarding Frigidaire Multiple-Unit Air Conditioning installations for:

Existing Building       New Construction

Name .....  Architect

Firm Name .....  Builder

Street ..... City .....  Owner

County ..... State .....  .....





Lewis Eugene Wilson, Architect

MODERN DOOR CONTROL BY *LCN* • CLOSERS CONCEALED IN HEAD FRAME

BALDWIN THEATRE, LOS ANGELES, CALIFORNIA

LCN CATALOG 11-E ON REQUEST OR SEE SWEETS • LCN CLOSERS, INC., 466 WEST SUPERIOR STREET, CHICAGO 10

**NOW!** entire ceilings *Glow* with light!

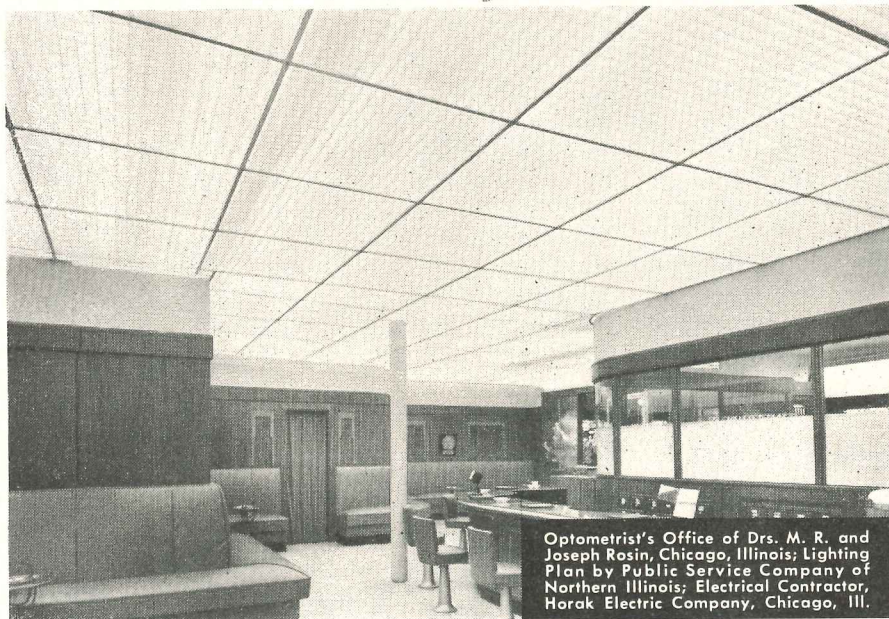

Optometrist's Office of Drs. M. R. and Joseph Rosin, Chicago, Illinois; Lighting Plan by Public Service Company of Northern Illinois; Electrical Contractor, Horak Electric Company, Chicago, Ill.

**INCOMPARABLE**

*"Sky-Glo"*

**CREATES A NEW EXPERIENCE IN SEEING!**

Indescribably wonderful is seeing under the soft, restful and exhilarating "Sky-Glo" luminous ceiling lighting! Now it is possible to obtain much higher levels of illumination without annoying brightness or eye-tiring glare!

**LUMINOUS VINYLITE LOUVERS**  
**MAKE UNBELIEVABLE DIFFERENCE**

You must experience "Sky-Glo" lighting to truly appreciate the great advance it represents in lighting! For here is lighting that achieves high levels of illumination from 50 to 150 footcandles . . . yet is so unobtrusive that one is neither consciously aware of increased light nor its source.

The secret is in the louvers! "Sky-Glo" is the first to use a plastic (Vinylite) that not only reflects light but transmits it, too! The special qualities of this louver diffuse and soften the light to produce a new experience in seeing.

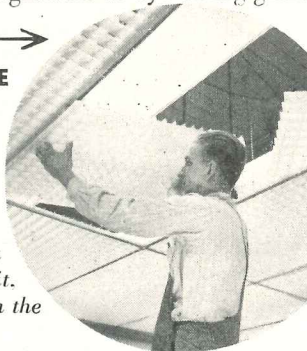

**MOST BEAUTIFUL LIGHTING**

Incomparable, too, is the beauty of "Sky-Glo"! Gone are the forest of fixtures which are now concealed by a new kind of "Ceiling of Light" created by "Sky-Glo". Now, the lighting in new buildings can be as beautiful and modern as the exteriors!

**SAVES ALTERATIONS**

Now, instead of spending for expensive ceiling alterations install a "Sky-Glo" system that converts old ceilings into glowing new ones at lower cost than ever before.

**FREE ILLUSTRATED FOLDER**

Gives complete information on this new, modern lighting system consisting of standardized parts of channels, fittings and translucent Vinylite panels that can be fitted to practically any size and shape of ceiling.



Distributed Exclusively Through Electrical Wholesalers

Benjamin Electric Mfg. Co.  
Dept. Q-1, Des Plaines, Ill.  
Gentlemen: Without cost or obligation please send complete data on "Sky-Glo" to:

Name.....  
Company.....  
Address.....  
City..... State.....

**Ask Your Electrical Contractor to Submit a Specific Proposal**

3115R

**THE RECORD REPORTS**

**CANADA**  
*(Continued from page 136)*



urban Weston, Toronto, Ont., by F. G. Engholm, president of the Macotta Co. of Canada, architect and owner.

Steel studs for exterior walls were made in prefabricated sections 10 ft long, packed with rock wool insulation.

Prefabricated roof trusses are wood, and sheathing is plywood, jointed with mastic and cotton membrane and covered with an asphaltic compound used for undercoating cars. Colored slate granules were blown on the compound, fusing with it to give an entirely unbroken surface.

Radiant heating coils are laid in concrete slab floor; the attic houses an air conditioning unit.

**R. A. I. C. Plans Program**

Two seminars, one technical and one cultural, are among features of the program for the 43rd annual assembly of the Royal Architectural Institute of Canada, scheduled for February 23-25 in the Fort Garry Hotel, Winnipeg, Man.

Also featured will be a report by Robert F. Leggett, head of the Building Research Division of the National Research Council.

St. Andrew's Presbyterian Church (architect unknown), Niagara-on-the-Lake, Ont., is among the subjects of a 22-panel photographic exhibit, "The Pictorial Essay of a Pioneer Town," touring the Dominion

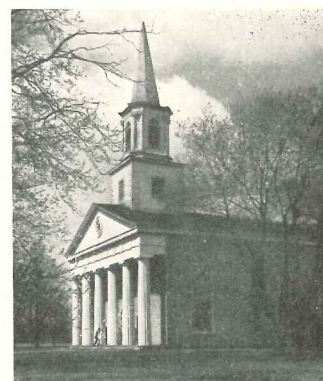

*(Continued on page 140)*



# modern *Personalized* heating for modern apartments

**IN AKRON**

## **PARKVIEW APARTMENTS, South Hawkins Ave.**

**The Hendrich Hall Harter Company, Builders and Operators**

Photograph shows part of Parkview Manor consisting of 17 buildings housing 98 suites. Last

word in modern conveniences, individual Gas-Fired Janitrol Winter Air Conditioners provide personalized heating for each family unit.

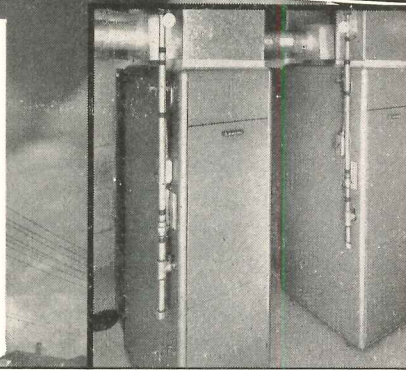

Basement installations of Janitrol units are extremely compact, clean and easily accessible. Same type units are often installed in closets or hallways immediately adjacent to individual apartments.

**IN BUFFALO**

## **HIGHLAND COURT APARTMENTS, Typical of Several Multiple Units built by R. C. Dewey, Inc.**

Janitrol Triple Service Systems are exclusive equipment with this builder. Efficient operation and low maintenance costs influenced Mr. R. C. Dewey's choice of

Janitrol for servicing 200 family units. Providing convector radiation with forced hot water circulation, the Janitrol units also supply hot water for all domestic uses.

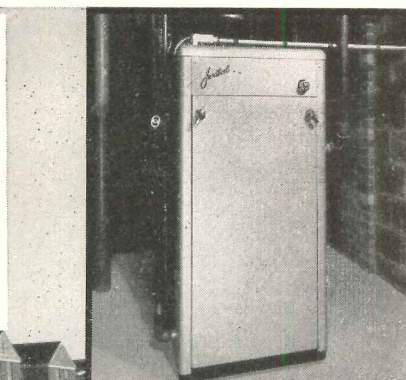

One compact Janitrol Unit supplies hot water for heating as well as for daily household hot water needs. Units are also widely used for radiant panel heating systems, either gas or oil fired.

**IN CHICAGO**

## **27 APARTMENT UNITS, North Cicero Ave. E. L. Anderson and Company, Builders and Contractors**

These ultra modern apartments reflect typical Swedish architecture. Each building containing nine apartments is serviced by a Janitrol boiler providing a forced

flow of 200° hot water. Each apartment is provided with a thermostat control for both the convectors in living quarters and small cast iron radiators in bathroom and kitchen.

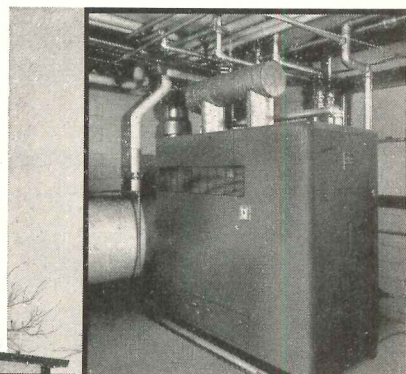

Janitrol Cast Iron Boiler with gross output of 486,000 b.t.u./hr. Forced hot water system is maintained by continuous pump operation.

**WELL-TESTED**

**TIME-PROVEN**

# Janitrol

**GAS FIRED WINTER AIR CONDITIONERS • UNIT HEATERS  
GRAVITY FURNACES • BOILERS • GAS AND OIL FIRED  
TRIPLE SERVICE HOT WATER SYSTEMS**

★ *Write today!*  
Complete specifications on typical Janitrol installations for apartments, industrial and commercial buildings and homes are available in A.I.A. file folders. Send for your copies today, there's no obligation, address—  
Architectural Service  
**SURFACE COMBUSTION CORPORATION,**  
TOLEDO, OHIO.

**Home Builders' Convention**

Practical problems of home builders will occupy the spotlight throughout the sixth annual convention and exposition of the National Association of Home Builders in Chicago, Feb. 19-23.

Executive Vice President Frank W. Cortwright of Washington says the show will be "the most diversified we have ever attempted," and of immediate prac-

tical value to all builders there. E. M. Spiegel of Passaic, N. J. is chairman of the convention committee.

**Competition Winners**

Two students of the School of Architecture at Penn State College won first and second prizes in the Class B Problem I competition for design of a two-bedroom house conducted by the Beaux-Arts Institute of Design for the Archi-

tectural Record Prize awarded annually.

Taylor M. Potter won the first prize of \$50 and Curtis C. Schafer the \$25 award for his second-place design.

The problem, whose author was Sumner Spaulding, F.A.I.A., of Los Angeles, postulated a house for a family of four (maximum of 1200 sq ft floor space) on a site with 75 ft frontage and 100 ft deep. Integration of house and garden was stressed.

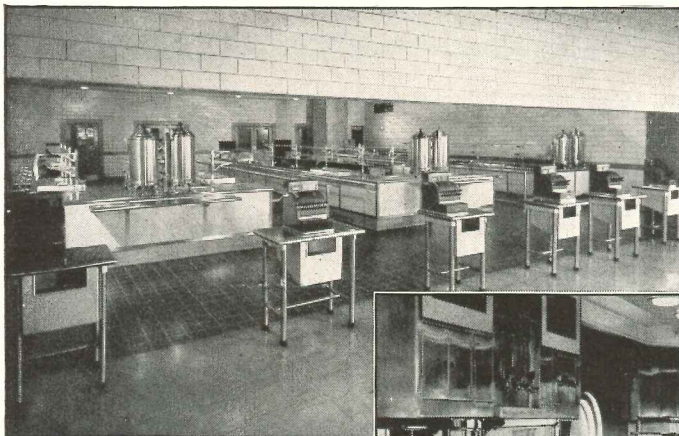

Six-lane cafeteria service in large machine tool plant

cocktails to coffee at counter on Congressional Limited

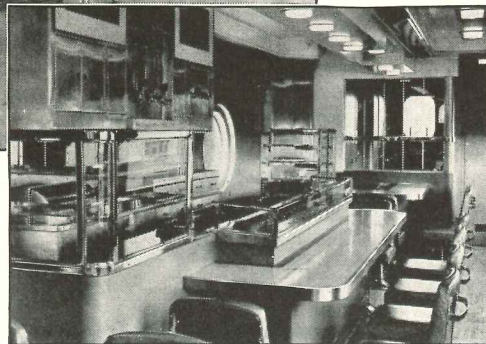

**Why architects rely on Van**

● Institutional architects know that Van has started its second century of conscientious kitchen engineering and fabrication. They know that Van maintains construction standards. They are familiar with Van specifications. They accept Van equipment without question.

● If you are planning food service equipment improvements, make use of Van's experience. Ask for Van's Centennial Book of Installations.

**The John Van Range Co.**

EQUIPMENT FOR THE PREPARATION AND SERVING OF FOOD

DIVISION OF THE EDWARDS MANUFACTURING CO.

Branches in Principal Cities

429 CULVERT STREET

CINCINNATI 2, OHIO

ON THE CALENDAR

Jan. 16-19: Plant Maintenance Show, sponsored by American Society of Mechanical Engineers and Society for Advancement of Management, Auditorium, Cleveland, Ohio.

Jan. 18-20: Annual meeting, American Society of Civil Engineers, Hotel Commodore, New York City.

Jan. 18-Mar. 5: Exhibition of Mies van der Rohe model, Museum of Modern Art, New York City.

Jan. 23-27: Southwest Air Conditioning Exposition of the International Heating and Ventilating Exposition, State Fair Park, Dallas, Texas.

Jan. 30-Feb. 3: 25th semi-annual Los Angeles Furniture Market, Los Angeles, Calif.

Feb. 19-23: Sixth Annual Convention and Exposition, National Assn. of Home Builders, Stevens and Congress Hotels, Chicago, Ill.

Feb. 27-Mar. 3: Committee Week and Spring Meeting, American Society for Testing Materials, Hotel William Penn, Pittsburgh, Pa.

Mar. 28-31: 1950 National Plastics Exposition, Navy Pier, Chicago, Ill.

Jan. 21-22: North American Conference on Church Architecture and Church Architect's Guild, joint meeting, Columbus, Ohio.

AT THE COLLEGES

**Faculty Appointments**

● Dr. Thomas Hall Locraft, a member of the faculty of the Department of Architecture at Catholic University of America since his graduation from the University in 1926, has been appointed head of the Department. He succeeds Dr. Frederick Vernon Murphy, his partner in the Washington, D. C., firm of Murphy & Locraft, who retired from the Department last July.

(Continued on page 142)

all eyes are on the greatest

*Lighting Development* since the fluorescent lamp

**exclusive**

MODULE plastic louver provides 40° transverse and longitudinal cutoff. Lamps are shielded at all normal viewing angles, yet light transmission is maximum.

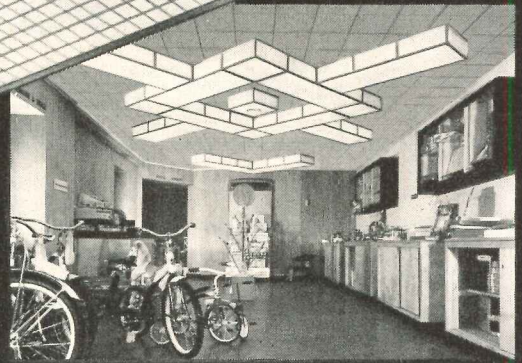
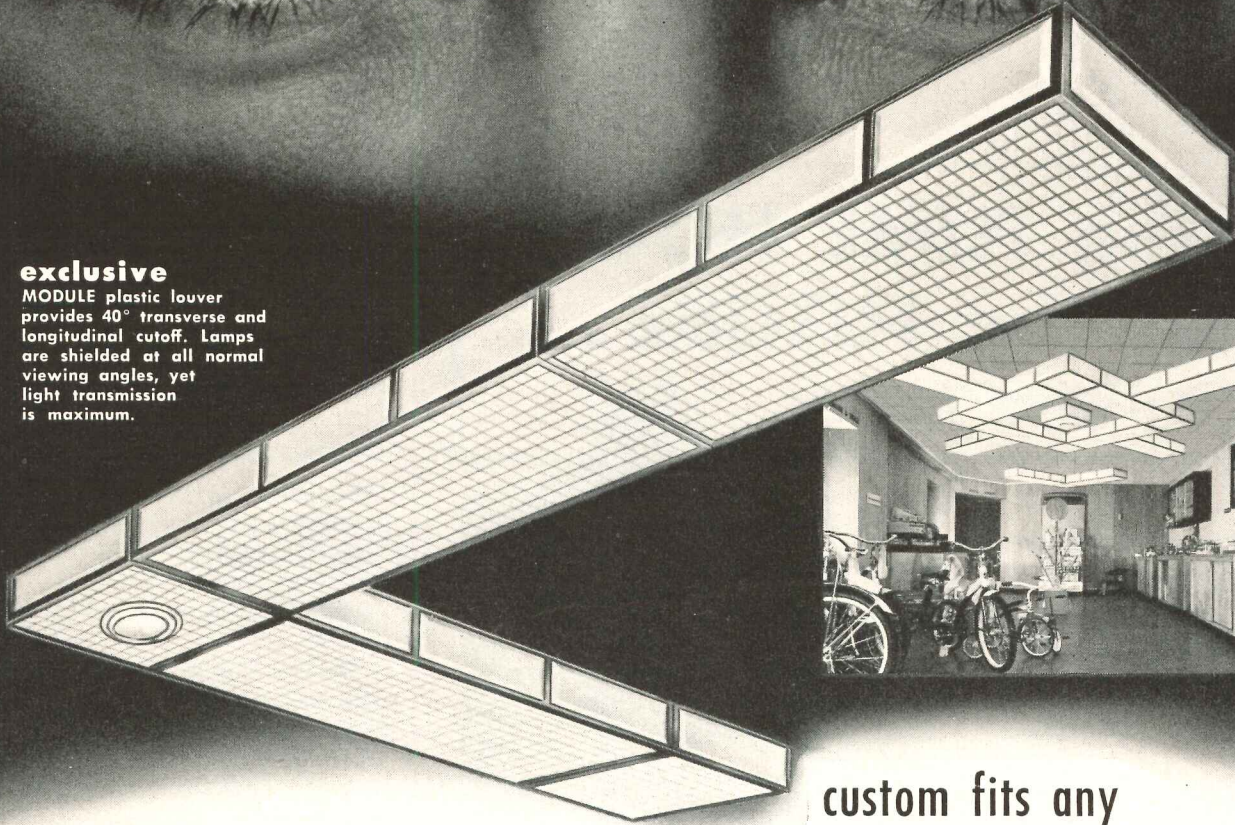

these 4 low-cost modules are the "building blocks" of a perfect custom-fitting lighting installation...

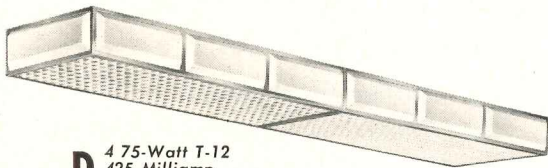

**D** 4 75-Watt T-12  
425 Milliamp  
Slimline Lamps

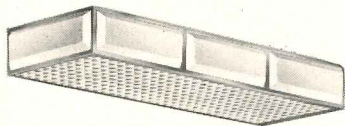

**C** 4 40-Watt T-12  
48" Type F Lamps

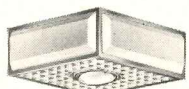

**B** 32-Watt 12" Circline  
Lamp, and 1 PAR Spot  
or Flood Lamp

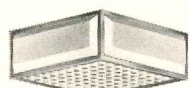

**A** 4 14-Watt T-12  
15" Type F Lamps

modules fit together perfectly end to side, end to end, side to side... to form more than 50,000 different lighting patterns... to fit any ceiling shape or size... mixing all light sources in one harmonious system... with equal brightness throughout (no dark sides or ends)... so you can put the light where it is needed!

custom fits any commercial interior— at no more than the cost of ordinary fixtures!

In just a few months, MITCHELL MODULE has won nation-wide approval and acceptance as an entirely new standard of commercial lighting. It is now being widely specified and installed in every type of commercial establishment—supported universally by lighting distributors, contractors, utility men and architects. The verdict of MODULE users is unanimous: "Here is complete lighting satisfaction!" Yes, here is the *first* and *only* lighting system that provides *all* the advantages of custom-fitted lighting at no more than the cost of ordinary fixtures... If you are not yet specifying MODULE, look into its superior possibilities—write for information today.



Only MITCHELL makes MODULE

MITCHELL MANUFACTURING COMPANY  
2525 N. Clybourn Ave., Chicago 14, Illinois

Send free 20-page brochure describing MODULE.

Firm Name \_\_\_\_\_

Address \_\_\_\_\_

City \_\_\_\_\_ Zone \_\_\_\_\_ State \_\_\_\_\_

Attention: \_\_\_\_\_

• Lewis Mumford has returned as visiting professor of architecture for the second year at the North Carolina State College School of Design, which has also announced the appointment of Fred N. Severud as a visiting professor of architecture for 1949-50. Visiting lecturers for the current year whose appointments have been announced include Leo Katz, Eero Saarinen, William W. Caudill, Alonzo J. Harriman, Thomas Church,

Buckminster Fuller, Richard J. Neutra and Frank Lloyd Wright.

• Reginald F. Malcolmson of Chicago, a graduate of the College of Technology, Belfast, Ireland, has been appointed instructor in architecture at Illinois Institute of Technology.

**Award Announced**

John H. VonGunten, a member of the Kansas State College architecture staff,

is the winner of the 1949 John Stewardson \$1400 memorial scholarship in architecture, Paul Weigen, department head, has announced.

Mr. VonGunten plans to travel and study from June through December of this year in France, Switzerland and Italy.

**Product Design Featured**

An engineering institute in industrial product design was held last month at the University of Wisconsin to demonstrate the various skills and techniques needed in the profession of industrial designing.

The institute was one of 18 sponsored by the university's College of Engineering and Extension Division. Prof. H. E. Pulver of the Extension Division is director.

**New Scholarships Offered**

Ten annual competitive scholarships of \$1000 each in American colleges and technical schools have been authorized by the American Institute of Steel Construction. Initial awards will be made in 1950.

Objective of the scholarship plan is to train engineers and administrators for the fabricated structural steel industry, but recipients of scholarships will be under no obligation to continue in the industry after graduation.

Schools where the awards will be made will be announced later.

**The FUME HOOD  
of the FUTURE . .  
is Yours Today**

**Kewaunee's New  
LOW VELOCITY  
FUME HOOD for  
Handling RADIO-  
ACTIVE ISOTOPES**

**Design Approved for Use  
by the OAK RIDGE  
INSTITUTE of  
NUCLEAR STUDIES**

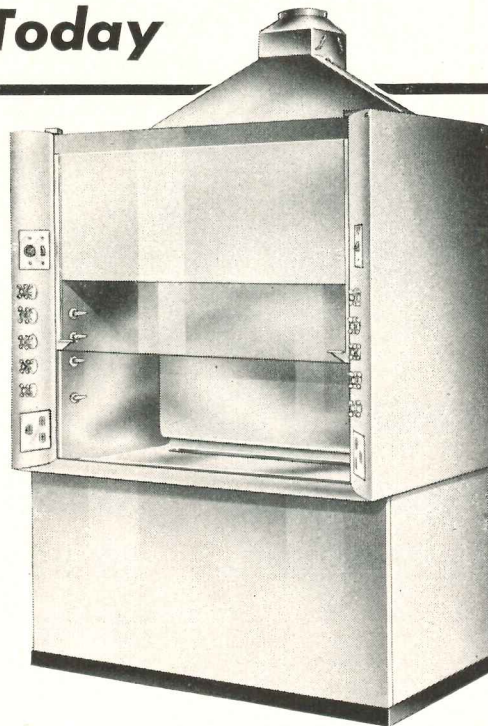

No. 3600—Kewaunee's  
"FUME HOOD of the FUTURE"

The Hood is made with stainless steel interiors and ducts throughout and incorporates a stainless steel working surface and trough. The working surface will support a load of 4,000 pounds. The Hood incorporates a new system of airfoils, baffles and ducts which provides a uniform flow of air over the entire face of the Hood, thus assuring evacuation of gases at extremely low velocities without interference from reverse eddies or turbulence. No auxiliary duplicate duct system for incoming air is required.

**Write for Descriptive Literature and Drawings available now on  
Kewaunee No. 3600—"The Fume Hood of the Future"**



C. G. Campbell, President  
5046 S. Center Street Adrian, Michigan  
Representatives in Principal Cities

**COMPETITIONS**

**International Award**

Closing date for entries for the International Award, 1949, of the Instituto Tecnico de la Construccion y del Cemento has been extended from Nov. 15, 1949 to Mar. 15, 1950.

**Courthouse Design**

Judgment in the competition on design of "A Court House Lobby" sponsored by the Marble Institute of America in conjunction with the Beaux Arts Institute of Design is scheduled for January 14.

Awards will be as follows: first prize, \$100; second prize, \$75; third prize, \$50; fourth prize, \$25.

(Continued on page 144)

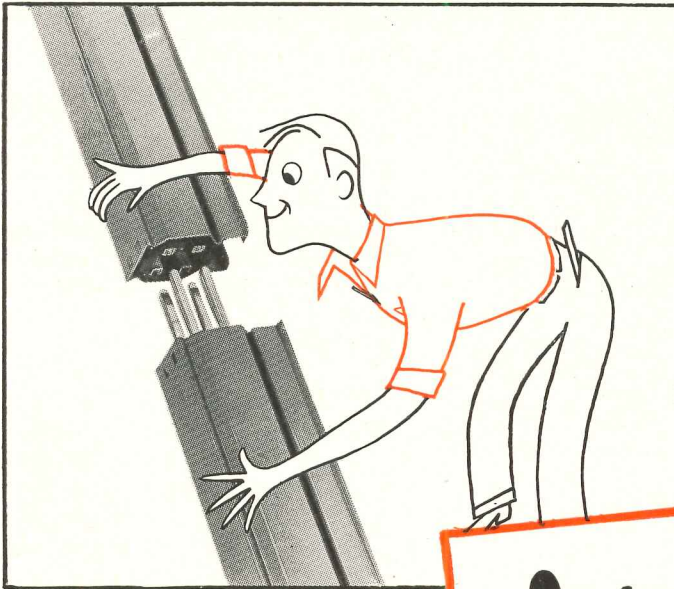

**"Quick-install-ability"**  
saves initial cost

LTG FLEX-A-POWER busways are pre-fabricated housings which are easily coupled in any arrangement and in runs of any required length. Time for installing is much less than for wiring and conduit.

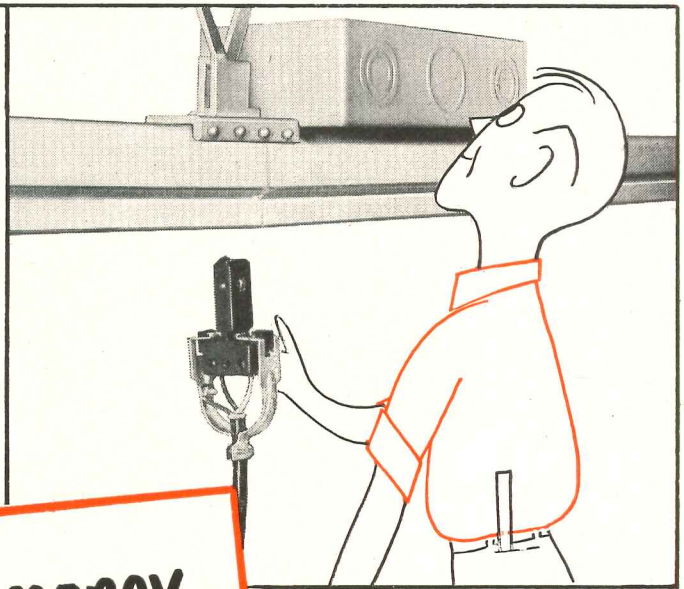

**"Plug-in-ability"**  
saves time relocating machines

Take-off plugs or trolley can be inserted anywhere (no drop-out section needed for trolley). You can add or relocate loads without rewiring expense and without long extensions.

Save money  
these **3** ways  
when distributing power



**"Take-apart-ability"** saves material expense

Whenever a major relocation of outlets is required, the entire FLEX-A-POWER system can be dismantled, removed to another location and re-installed with practically 100% re-use of materials.



Sealed Power Corp.  
saves with **Flex-a-Power**

LTG FLEX-A-POWER, one of six forms of FLEX-A-POWER for various services from main breakers to individual loads, is designed for light-duty lighting, small tools, appliances. Write for Bulletin TEC-3, THE TRUMBULL ELECTRIC MANUFACTURING COMPANY, Plainville, Conn.



TRUMBULL  ELECTRIC

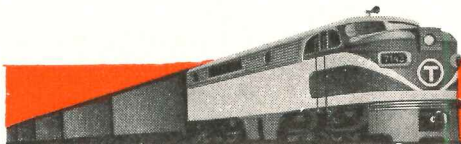

TRUMBULL'S TRAIN OF NEW PRODUCTS

**You can specify . . .**

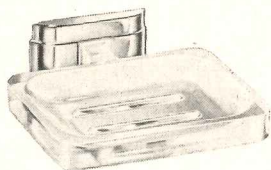

...new Hall-Mack Crystalcrome — jewel-like beauty — brilliant solid chromed brass combined with crystal-clear Lucite — accessories of the finest quality.

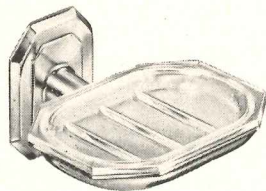

... Aristocrome Accessories — classic styling—heavy, rich construction and appearance — chromium plated solid brass—there's no finer accessory line.

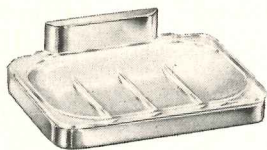

...popular Coronado — distinctive modern styling and luxurious looks—for bathroom requirements in the "medium" price range.

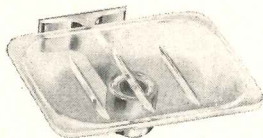

... and Tempo Accessories — solid quality at low cost — simple, functional beauty and long life—for modest budgets.

You can put long-established Hall-Mack quality in every bathroom you build, regardless of the budget at hand. Include this recognized, wanted extra quality in the homes you design and build!

Hall-Mack also makes a complete selection of fine Medicine Cabinets . . . and a number of exclusive Bathroom Specialties which are unique in convenience features.

*Bathroom Accessories are Important . . .*

You build a bathroom for a lifetime of use — make sure that the accessories you select have lasting Hall-Mack Quality in style and construction.

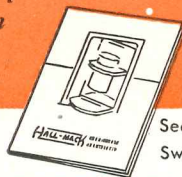

See our complete catalog in Sweet's Architectural File.

**HALL-MACK COMPANY**

1344 W. Washington Blvd., Los Angeles 7, California  
7455 Exchange Avenue, Chicago 49, Illinois

**THE RECORD REPORTS**

(Continued from page 142)

**For Better Rooms**

One hundred forty-five cash awards totaling \$25,000 will be made in the Fourth Annual Better Rooms Competition of the Chicago Tribune, which closes Feb. 20, 1950.

Prizes of \$100 to \$1000 each will be awarded for the best ideas for furnishing and decorating seven types of rooms. The competition is open to all interested persons, except employees of the Chicago Tribune and its subsidiaries and their families and members of the Jury of Awards.

Details and rules of the competition may be obtained from: Better Rooms Competition, Chicago Tribune, Tribune Tower, 435 N. Michigan Ave., Chicago 11, Ill.

**Sanitarium; Flower Shop**

Two competitions open to students of architecture throughout the United States have been announced by the Tile Council of America in cooperation with the Beaux Arts Institute of Design.

Four awards will be made for a design of a children's tuberculosis sanitarium and two for a nine-hour sketch of an end wall for a flower shop.

The flower shop sketch must be completed between February 13 and April 17 and will be judged May 4. The sanitarium designs are to be completed between March 20 and May 29 and judged about June 17.

Details are obtainable from the Beaux Arts Institute of Design, 115 E. 40th St., New York 16, N. Y.

**ELECTIONS APPOINTMENTS**

• Edward C. Meagher, treasurer of the Texas Gulf Sulphur Co. of New York, has been reelected president of the United Engineering Trustees, Inc. Other officers reelected were: Irving V. A. Huie (A.S.C.E.), president of the Board of Water Supply, New York, and James F. Fairman (A.I.E.E.), vice president of Consolidated Edison Co. of New York, as vice presidents; Kurt W. Jappe (A.S.M.E. treasurer), retired director of Purchases, Hercules Powder Co., Wilmington, Del., treasurer; James L. Head (A.I.M.E.), Dept. of Mines, Chile Exploration Co., New York, assistant treasurer.

(Continued on page 146)

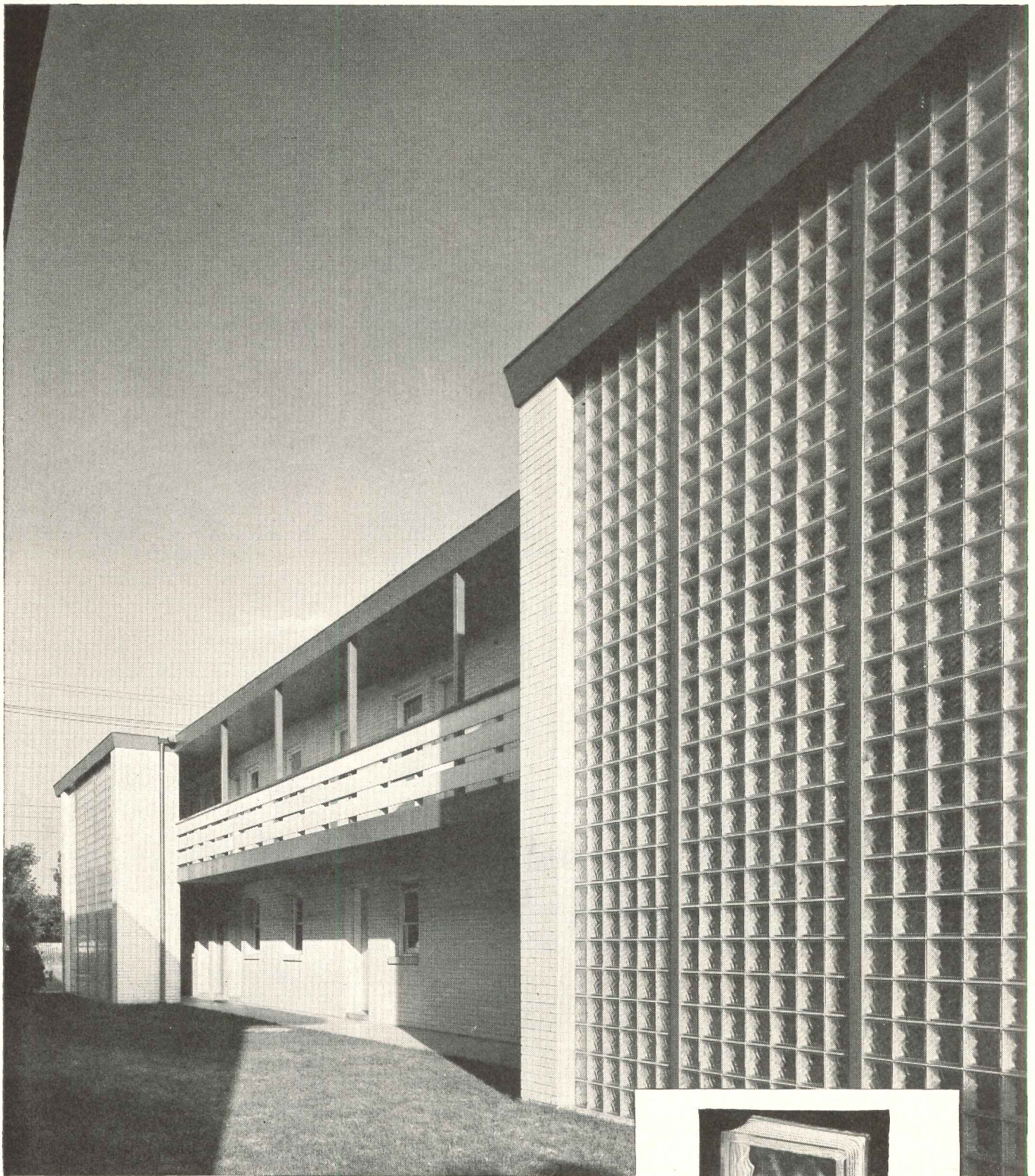

E. L. ANDERSON COMPANY, CHICAGO, DESIGNERS AND BUILDERS

### Another unusual use of Insulux Glass Block:

In this Chicago apartment building, twin screens of Insulux Glass Block effectively conceal the outside service stairway. At the same time, Insulux lets daylight into individual apartments while hiding unwelcome views from the tenants.

There are many, many uses for this remarkable glass block material—bathrooms, entries, living rooms, partitions, and kitchens are but a few possible places for Insulux.

For complete information, write: American Structural Products Company, Dept. G-113, P.O. Box 1035, Toledo 1, Ohio.

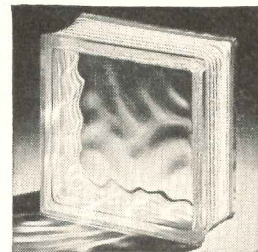

**INSULUX**

**GLASS BLOCK**®

**AMERICAN STRUCTURAL  
PRODUCTS COMPANY**

*Subsidiary of*

**OWENS-ILLINOIS GLASS COMPANY**

# FOR STEEL MILLS FOUNDRIES, FORGE SHOPS (HEAVY INDUSTRY)

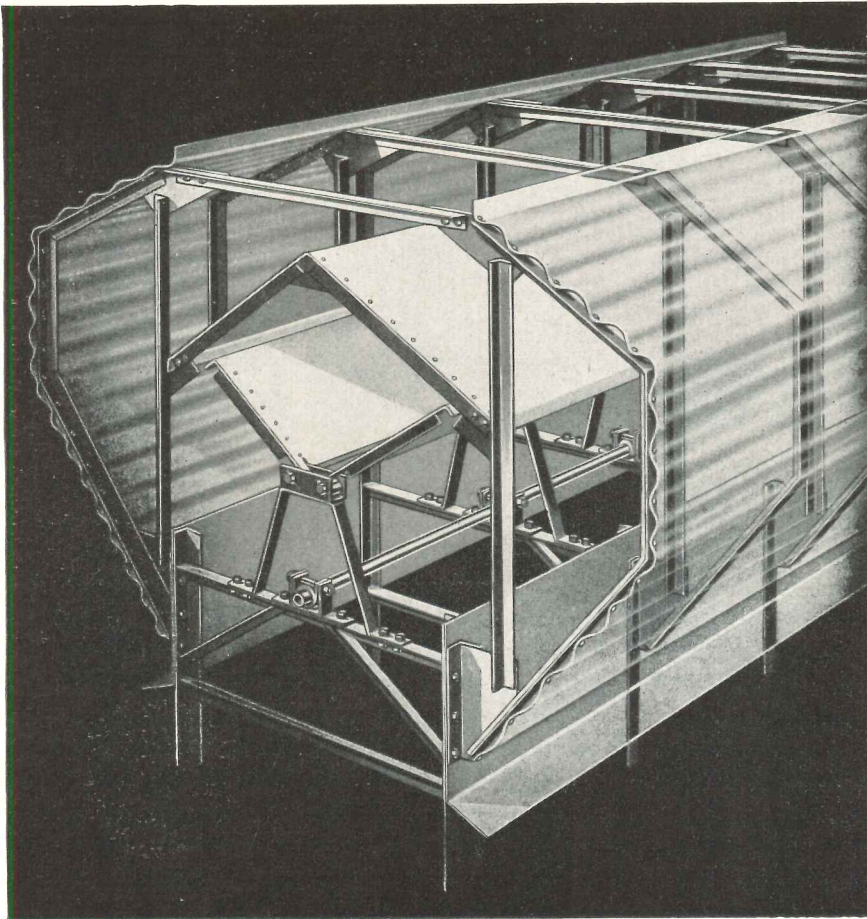

Adaptable to many applications, the Burt Monovent Continuous Ridge Ventilator is particularly efficient in heavy industry. The Monovent may be installed on any type roof. It removes heat, smoke and fumes the entire length of the building—converts the roof line to a giant exhaust valve. And Monovent's simple, sturdy construction assures long, trouble-free life with almost no maintenance.

**The Monovent may be the solution to your ventilating problems. Burt engineers will be glad to help with your plans—without obligation.**

SEE SWEET'S OR WRITE FOR CATALOG AND DATA SHEETS

*The* **BURT MFG. Co.**

48 E. South Street

Akron 11, Ohio, U.S.A.

VENTILATORS • LOUVERS • OIL FILTERS • SHEET METAL SPECIALTIES

## THE RECORD REPORTS

(Continued from page 144)

urer; John H. R. Arms (A.I.M.E., A.S.M.E.), secretary.

- Election of A. T. Waidelich as vice president in charge of research for The Austin Company has been announced in Cleveland by George A. Bryant, president of the national engineering and construction firm. Mr. Waidelich will supervise plant location surveys and economic and engineering reports as well as independent research projects.

- Alexander Knowlton, A.I.A., has been named architectural editor of *Living for Young Homemakers*. Mr. Knowlton had been engaged in private practice, but earlier was associated with such firms as Edward D. Stone (New York), Graham, Anderson, Probst & White (Chicago), Fellheimer & Wagner (New York), Ellerbe & Company (St. Paul) and Dodd & Richards (Los Angeles).

- Miss Katherine Coffey, assistant director of the Newark Museum since 1947, succeeded Miss Alice W. Kendall as director of the museum on November 1.

- Henry L. Logan has been named to the newly-created post of vice president in charge of research for the Holophane Co. A Fellow of the American Institute of Electrical Engineers and of the Illuminating Engineering Society and a member of numerous other scientific and technical groups, Mr. Logan has been manager of the Department of Applied Research for Holophane.

- Appointment of Paul F. Croley as assistant executive director of the Philadelphia City Planning Commission has been announced by Edmund N. Bacon, executive director.

### OFFICE NOTES

#### *Offices Opened*

Alfred Francis Bordeleau, A.I.A., formerly on the design staff of the Denver University School of Architecture and Planning, has opened an office for the practice of architecture at 410 Eighth St. N., Great Falls, Mont.

Anthony S. Ciresi, A.I.A., announces the opening of an office for the practice of architecture at 7113 Euclid Ave., Cleveland 3, Ohio.

Stewart S. Granger, A.I.A., has taken offices for architectural practice at

(Continued on page 148)



# Connor FIRST AGAIN WITH

Selective logging assures your future supply of Connor Northern Hardwoods

## "Laytite"

Maple and Birch

### FLOORING

(LONG LENGTHS WIRE TIED)

### in CARTONS

1. Have retail sales appeal.
2. Keep flooring clean and dry.
3. Keep moisture content more uniform.
4. Make inventory easy—contents are plainly marked for grade and scale.
5. Give buyers exact cost of 10 sq. ft.
6. Save time in laying mixed lengths without breaking several bundles.

MFMA SPECIFICATIONS



Cartons keep flooring dry and clean.

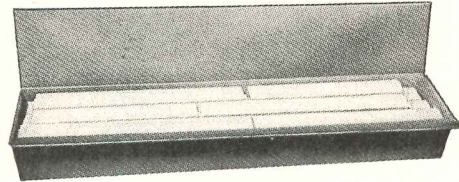

Assorted lengths save time in laying.

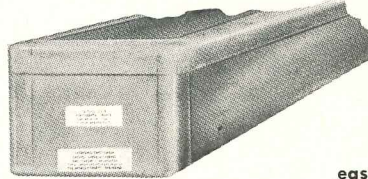

Each carton labeled for easy inventory.

Telephone No. 3 or 418

P. O. Box 112-R

Teletype - Marshfield No. 26

The **CONNOR LUMBER and LAND CO.** Sales Office MARSHFIELD, WISCONSIN

Send for Illustrated 75th Anniversary Book

LO-LEVEL  
COOLERS

BATTERY

WALL

PEDESTAL

## A COMPLETE LINE for every need

For your 1950 requirements you can choose from a wide variety of Halsey Taylor models for school installations. The new Lo-Level cooler for school cafeterias is but another evidence of Halsey Taylor's continuous development in drinking-water equipment design. Thus you can be sure of the ultimate in economy and service, no matter what your needs!

THE HALSEY W. TAYLOR Co., Warren, Ohio

### The Little Cooler for Little People

This ideal cafeteria cooler is the right height for children. Foot-pedal operation means extra convenience for the child and less confusion in the room, and Halsey Taylor engineering means trouble-proof service!

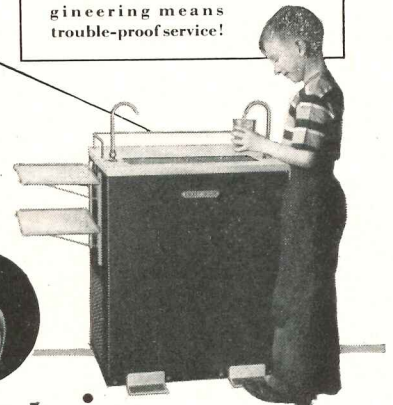
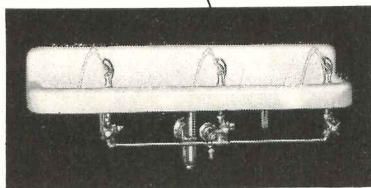
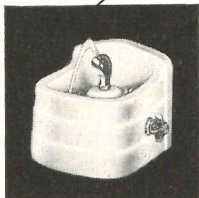
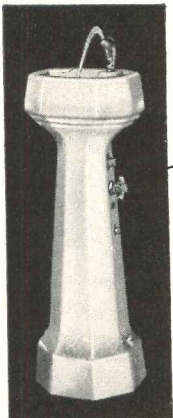

# HALSEY TAYLOR Drinking Fountains

AS-1

# Guth lighting switched our office gripes to grins"

says one of our most  
recent customers



"Our employees were constantly complaining of the poor seeing conditions under our old pre-war lighting system. It was dim and depressing. What a difference when we installed our new GUTH precision-planned "Cadets"! Now the office is stimulating and cheery—no shadows, no glare. Our employees' morale is far higher; now they see their work is an entirely different light."

Wherever you want the ultimate in illumination, GUTH Luminous-Indirect CADETS\* are the answer. They produce high intensities with remarkably uniform distribution and balanced brightness ratios.

• May we send you Bulletin 815-J with full details on

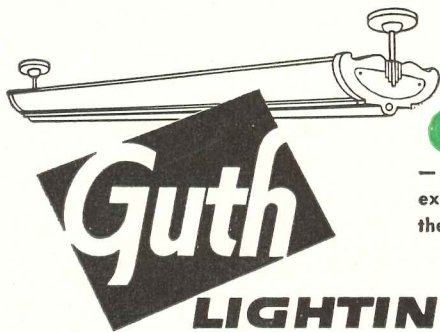

## GUTH CADETS

— the fluorescent fixture chosen by impartial  
experts for America's No. 1 lighting job—  
the relighting of West Point!

### LIGHTING

THE EDWIN F. GUTH COMPANY / ST. LOUIS 3, MISSOURI

\*®

*Leaders in Lighting since 1902*

## THE RECORD REPORTS

(Continued from page 146)

3006 Wilshire Blvd., Los Angeles 5, Calif.

Elmer J. Weis and O. S. Roe have opened the architectural and engineering office of Weis & Roe, 2237 St. Louis Ave., St. Louis, Mo.

Walter Zick, A.I.A., and Harris Sharp, A.I.A., announce the opening of their offices at 1806 South Main St., Las Vegas, Nev. (P.O. Box 1808).

### New Addresses

The following new addresses have been announced:

Laurence P. Johnston, A.I.A., 4105 Wisconsin Ave. N. W., Washington 16, D. C.

Carl Koch, Architect, & Associates, 57 Brattle St., Cambridge, Mass.

Walter Kuetzing, Architect, Stapleton Bldg., Billings, Mont.

Hans G. R. Schickele, Architect, 2220 Bancroft Way, Berkeley 4, Calif.

M. Tony Sherman, Architect and Industrial Designer, 732 N. E. 79th St., Miami 38, Fla.

Technical Planning Associates, 111 Whitney Ave., New Haven 10, Conn.

### New Firms, Firm Changes

Richard B. Benn and Roswell H. Johnson Jr. announce the formation of a partnership for the general practice of architecture under the name of Benn & Johnson, Registered Architects, with offices at 5907 Penn Ave., Pittsburgh 6, Pa.

Vladimir Bobovitch and Ngwai Fook have announced that they are practicing in partnership as Vladimir Bobovitch-Ngwai Fook Associates at 204 East 46th St., New York 17, N. Y.

Joseph B. Diamond, Licensed Professional Engineer and Attorney at Law, has resigned as Deputy Commissioner of Public Works and resumed law practice with Bleakley, Platt, Gilchrist & Walker at 120 Broadway, New York 5, N. Y.

### ERRATUM

Max J. Wolfson, A.I.A., Architect, is now practicing in new offices at 1005 W. Belmont Ave., Chicago, Ill. The RECORD regrets having erroneously indicated in a previous announcement that Mr. Wolfson was opening an office rather than moving to a new location and having misspelled his name.

113

# MODERN BUILDINGS demand MODERN DESIGNED COOLING EQUIPMENT

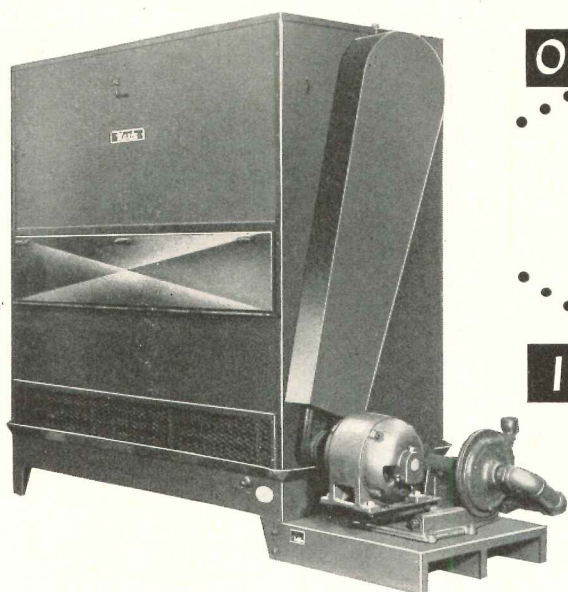

**Outside**

•• a clear  
unbroken  
skyline

**Inside**

•• greater  
functional  
efficiency

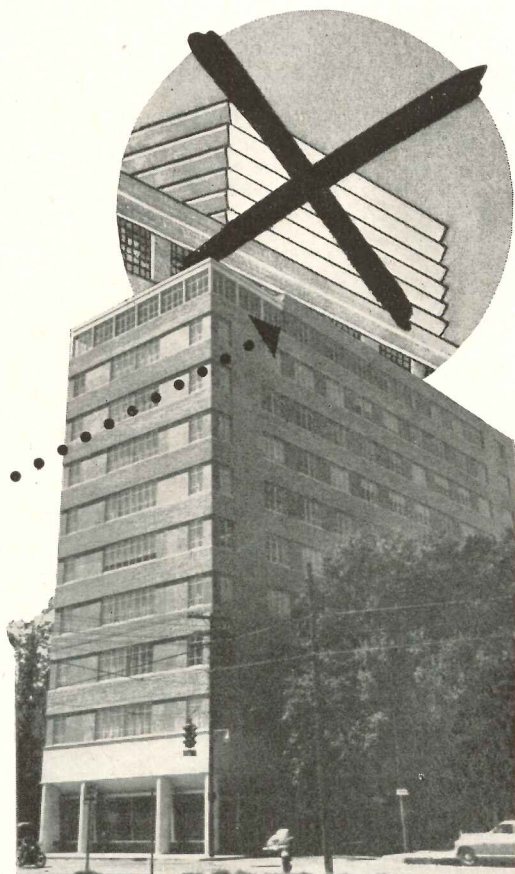

New Pioneer Building in Lake Charles, Louisiana. The Marlo units serving its cooling system are designed to preserve the architectural beauty. Installation was handled by the Air Conduit Co., Lake Charles. Weil and Moses, New Orleans, were the consulting engineers.

## with MARLO COOLING UNITS

Specify Marlo Evaporative Condensers and Cooling Towers for rooftop installation.

● There's no worry about appearance—Marlo Units can be designed to fit *below the parapet* of the building and out of sight.

● And wherever they're installed—inside or out—they operate *silently . . . and economically . . . and save up to 95%* of the normal water demand.



Smart men's club on top floor of building. Dependable Marlo Units play a vital role in providing the controlled comfort that members appreciate.

**MARLO-HEAT TRANSFER**  
Since 1925

WRITE . . . for complete data on Marlo Evaporative Condensers and Cooling Towers.

**Marlo** COIL CO. • 6135 Manchester Rd. • St. Louis 10, Mo.

8. "Three ways to cut your operating costs." By K. A. Wing. *Buildings*, Mar. 49:24. Economies through study of lighting, heating & elevator costs & controls.
9. "Who will build them this time?" By Glenn McHugh, VP Equitable Life. *Skyscraper Management*, Aug. 49:5-7, 31-34. Trend toward reduction of office building construction in central areas.
10. "Commercial real estate market for 1949." By Leo J. Sheridan. *Skyscraper Mgt.*, Mar. 49:3-5, 32-34. Address before Mortgage Bankers Assoc. Dangers of new construction for existing rentals. g
11. "How high can office rentals go?"

- By Sterling H. Bigler. *Buildings*, Mar. 48:38-41. Report to Middle Atlantic Conference of Building Owners & Managers. Opposition to new construction. g Same material in *Skyscraper Mgt.*, Feb. 48:8-9. g
12. "Building construction under present conditions." By Charles M. Chuckrow. *Buildings*, Mar. 48:27-28. Financial analysis: 23-story building built in N.Y.C. in 1946. Same material in *Skyscraper Mgt.*, Mar. 48:3-5, 27-28. g
13. "Case study of present construction costs." By George R. Bailey. *Buildings*, Dec. 47:28-30. Tall building cost & rental income analysis.

14. "Allocation of costs." *Buildings*, Aug. 47:49. Rule of thumb for apportionment of costs to ground & upper floors.
15. "Sell function, not footage." Editorial by Charles A. McCaleb. *Buildings & Building Management*, Mar. 46:23.
16. "Chart aids in analyzing office building operation." By G. M. Lewis. *Buildings & Building Mgt.*, Jan. 46:28-29. g
17. "A critique of fixed formula methods of pricing office space." By B. L. Lefler. *Journal of Property Mgt.*, Dec. 45:97-104. Refinements of Sheridan-Karkow formula.
18. "Planned profit-timing for office buildings." By W. Earl Martin. *Buildings & Building Mgt.*, May 45:31-33. Formula for office space financial analysis.
19. "Occupancy decline less than expected." By Dale R. Cowen. *Skyscraper Mgt.*, June 49:3-6. Semi-annual summary of office building operations. gt
20. "Slight decline again registered in office building occupancy." By Dale R. Cowen. *Skyscraper Mgt.*, Nov. 48:3-6. 2495 buildings, occupancy av. 98.88%. gt
21. "Occupancy trend continuing down." By Roy J. Johnson. *Skyscraper Mgt.*, June 48:3-6. 2445 buildings, occupancy av. 98.99%. gt
22. "Income & operating expenses in office buildings." *Buildings & Building Mgt.*, Feb. 45:20-21. Charts of income, expense & operating ratios for 1924-1943. g

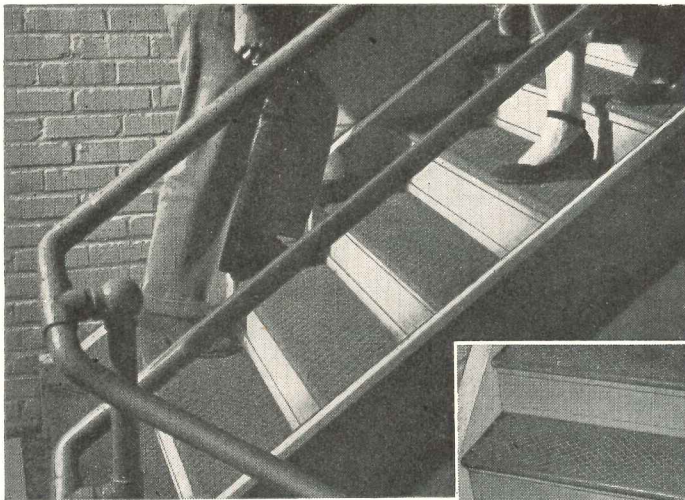

*Feralun Safety Treads installed in 1923, in office of RCA Victor Division, Camden, N. J. (Courtesy Public Relations Department, RCA Victor).*

## FERALUN SAFETY TREADS

"INSTALLED IN 1923... STILL GIVING SATISFACTORY SERVICE TODAY"

They planned well for safety and for durability—those who were responsible for these Feralun\* safety treads—installed when this RCA Victor building was erected in 1923. A quarter century of resistance to wear under the many thousands of feet that have gone up and down them since Calvin Coolidge first entered the White House! A quarter century of underfoot safety, too, on Feralun's non-slip surface! And, as the photograph shows, these same treads can still be counted on for many more years of maintenance-free service—and safety.

Examples like this show why architects, engineers and builders insist on "Feralun" treads, nosings and plates. Made of cast iron with wear-resistant abrasive particles embedded in walking surfaces, "Feralun" provides a sure-footed "grip" that keeps feet from slipping—and wears and wears. The coupon below will bring you full information on "Feralun." Send it today.

\*Also available in Bronze—(Bronzalun),  
Aluminum—(Alumalun), and Nickel Bronze—(Nicalun).®

**AMERICAN ABRASIVE METALS CO.**  
IRVINGTON 11, N. J.

AMERICAN ABRASIVE METALS CO.  
470 COIT STREET  
IRVINGTON 11, N. J.

Gentlemen: Please send me full information on Feralun. (AR 1-50)

NAME ..... TITLE .....

COMPANY .....

ADDRESS .....

CITY ..... STATE .....

Year	Income	Operating ratio
1924	\$2.27 psf	57.9% ("normal")
1934	1.45	(low)
1941		80.7% (high)
1943	1.66	76.9%

23. "1948 operating costs in 96 San Francisco buildings." *Buildings*. Total \$1.8048 psf rental area. gt

24. "1947 operating costs in 93 San Francisco buildings." *Buildings*, Oct. 48:42. Total \$1.6404 psf rental area. gt

25. "1947 operating costs in 35 Philadelphia office buildings." *Buildings*, Aug. 48:30-31. Totals: Over 100,000 sf, \$1.919 psf; under 100,000 sf, \$2.077 psf. gt

26. "1946 operating costs in 37 Philadelphia office buildings." *Buildings*, Nov. 47:38-39. Totals: Over 100,000 sf, \$1.843 psf; under 100,000 sf, \$1.774 psf. gt

27. "1945 operating costs in 35 Philadelphia office buildings." *Buildings & Building Mgt.*, Dec. 46:30-31. Totals: Over 100,000 sf, \$1.255 psf rental area; under 100,000 sf, \$1.345. gt

28. "1945 operating costs in 70 San Francisco buildings." *Buildings & Building Mgt.*, Oct. 46: 30-31. Total: \$1.4939 psf rental area. gt

29. "1940 operating costs in 35 Philadelphia office buildings." *Buildings & Building Mgt.*, Nov. 41:20. Total: \$1.39 psf rental area. gt

### LOCATION, DECENTRALIZATION, ZONING & PARKING

30. Urban Land Institute, Community Builders' Council. *The community builder's handbook*. Urban Land Institute, Washington, D.C., 1947. 205 pp. Preliminary steps, planning, protecting future of development, shopping centers (308 types of business classified in 4 lists for location), statistical appendices. gptv
31. Urban Land Institute. *Technical Bulletins*:
- #1. *Mistakes in community development*. By J. C. Nichols. 1945.
  - #2. *Urban redevelopment enabling acts*.
  - #3. *Trends: Urban development & redevelopment*.
  - #4. *Mistakes in developing shopping centers*. By J. C. Nichols.
- (Continued on page 152)

## This Valuable Guide Helps You Design Easy-to-Sell Houses

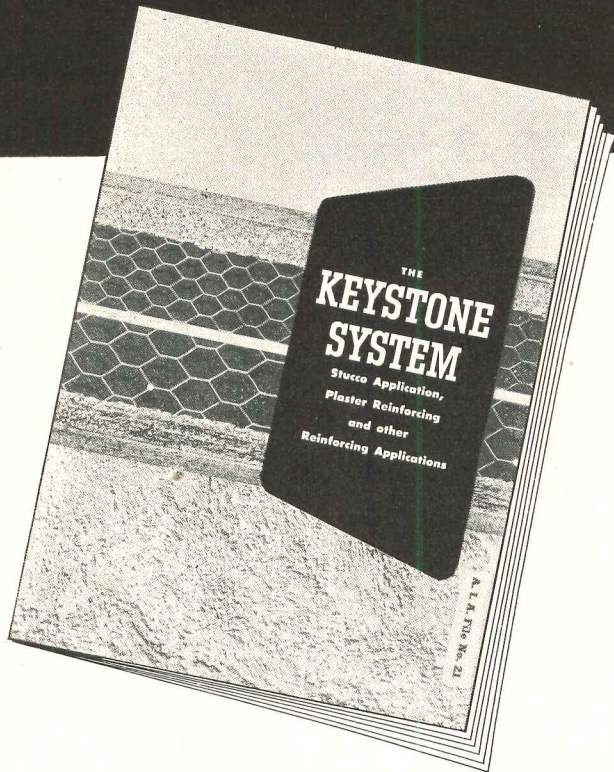

Yes, if you want to design attractive houses at lower cost . . . and still add the extra features that appeal to home buyers . . . let this book help you. It explains the Keystone System of Stucco Application—the answer to the need for durable, attractive, quality homes at lower cost.

Besides, this book gives helpful information on the Keystone System of Plaster Reinforcing and other reinforcing applications. Write for your copy *today!*

### Keystone Steel & Wire Company

PEORIA 7, ILLINOIS

*Manufacturers of Keymesh Reinforcing, Welded Fabric, Tie Wire and Nails*

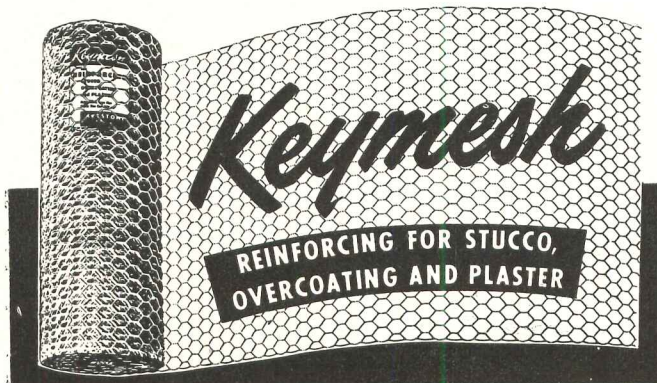

TTTT  
BARBER  
COLMAN  
TTTT

## MOTOR- OPERATED VALVES

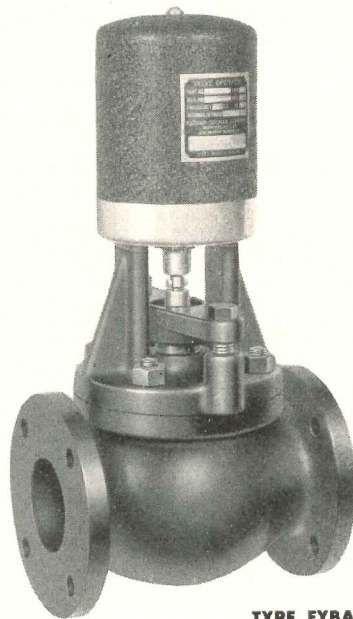

TYPE FYBA  
MOTOR OPERATOR  
ON GLOBE FLANGED  
VALVE BODY

## FOR ZONE CONTROL

Zone control systems on hot water and steam heating installations require good, remotely-controllable valves for efficient operation. Barber-Colman Motor-Operated Valves have proved ideal for this service in thousands of buildings of all types and sizes. Barber-Colman Valves are ruggedly built for *maximum performance with minimum maintenance*. They are made in all standard sizes up to 6", with globe screwed pattern from 3/4" to 4" and globe flanged pattern from 2 1/2" to 6". Three types of motor-operators are available, the choice depending on service requirements. Barber-Colman Motor-Operated Valves are delivered *completely assembled* ready for installation. Motors operate on low voltage and valves may be remotely (and automatically) controlled by any three-wire circuit single-pole double-throw switch or its equivalent, such as a thermostat, pressure switch, or relay. Be sure your files include latest engineering data on these useful, dependable, economical Valves. *Consult your Barber-Colman representative for any advice on applications.*

*Write for Literature*

**BARBER-COLMAN COMPANY**  
1232 ROCK STREET • ROCKFORD, ILLINOIS

- #5. *City planning bibliography*. 1946.
- #6. *Auto parking in central business districts*. 1946.
- #7. *Slums — "Improved land" value*. 1947.
- #8. *Subdivision regulations*. 1947.
- #9. *Commercial parking in residential areas (transitional)*. 1948.
- #10. *Prohibition of residences in industrial districts*.
- #11. *Shopping centers (19 examples)*. 1949.
- 32. Armstrong, Robert H. & Homer Hoyt. *Decentralization in New York City*. A preliminary report to Urban Land In-

- stitute, Jan. 1941. Excellent survey of N.Y.C. population & other statistics. **gt**
- 33. Canoyer, Helen G. *Selecting a store location* (Economic Series #56). U. S. Department of Commerce, Office of Domestic Commerce, Marketing Division GPO 1946. 68 pp. Selection of town, community & site. Practices in seven selected retail lines. Appendices: Distribution & operating expense ratios. Excellent bibliography on location. **bd**
- 34. *Picking a location for a small business* (Small Business Series #3). N. Y. State Department of Commerce. Elementary location techniques. **st**

- 35. *Parking Manual*. American Automobile Association, Traffic Engineering & Safety Department, Washington, D. C. 1946. 181 pp. The parking problem — Causes & effects of parking difficulties — Factual studies — Improving curb parking conditions — Off-street parking facilities — Educating the public — Other community activities affecting parking — Appendices — Review of zoning regulations in 40 cities. **bdgptv**
- 36. *Zoning applied to parking*. Eno Foundation for Highway Traffic Control. Saugatuck, Conn., 1947. Survey (586 returns) of cities of 50,000-100,000 pop.
- 37. "A new solution for parking." By P. M. Rea. *Journal of Property Mgt.* Sept. 47:33-43. Electro-Park, an automatic elevator parking system. **dgm**

**Infra**  
INSULATION, INC.

10 Murray St.  
New York,  
N. Y.

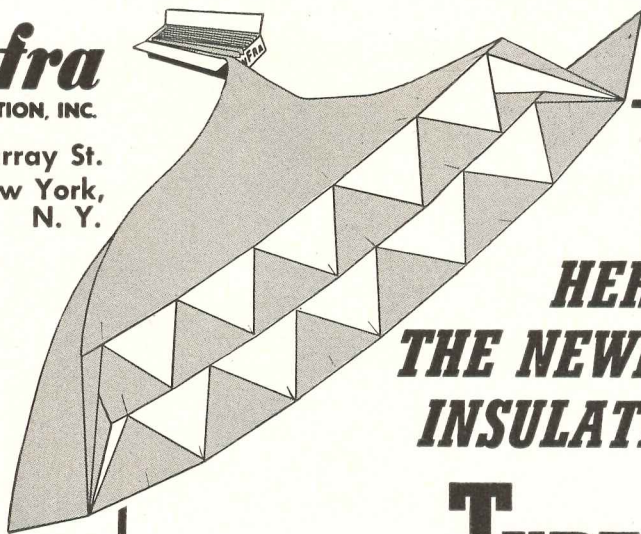

**HERE'S  
THE NEWEST  
INSULATION  
TYPE 6**

**INFRA ACCORDION INSULATION**

Three thick sheets of permanently separated aluminum

**PLEASE LOOK AT THE THERMAL VALUES\***  
4" to 7½" Insulation Value in a 2½" Depth

There are SIX, 97% effective, radiant-heat-repelling surfaces, EACH of ONLY 3% emissivity (against ordinary insulation's 90%). There are SIX non-conductive, reflective air spaces. FIVE barriers to convection consist of THREE EXTRA-THICK aluminum sheets, IMPERVIOUS to warm or cold air, WATER VAPOR, or any gas; and TWO Fiber Separators, flame, mold and vermin-proof, which also block inner convection. For 16" and 24" centers.

**\*THERMAL FACTORS, INFRA TYPE 6**

Down-Heat	C.044, R 22.72 = 7½" dry rockwool
Up-Heat	C.08, R 12.50 = 4" dry rockwool
Wall-Heat	C.073, R 13.69 = 4½" dry rockwool

INFRA  
ACCORDION  
ALUMINUM  
and TRIANGULAR  
REFLECTIVE  
AIR CELLS

Light, Strong  
Easily Installed  
Competitive  
in Price

**WRITE** Infra for details and FREE COPY of "Bulletin No. 38," issued by the National Housing Agency of the Government, reporting tests of Aluminum Insulation made by the U.S. Bureau of Standards, and dealing principally with the problems of condensation and of heat and vapor transfer.

Address Dept.

AR

**PLANNING & GENERAL REFERENCES**

- 38. Maze, Coleman L. (NOMA) *Office management, a handbook*. Ronald Press Co. N. Y., 1947. 870 pp. Chapter 11: *Office environment*: pp. 299-331. Location & setting — Building characteristics — Construction — Maintenance & operation — Appearance. Data on color & insurance (39 types outlined). **dfpv**
- 39. Rippen, Kenneth H. *Office space administration — Streamlining office methods & layouts* (Office Management Series #114). American Management Association, N. Y., 1946. pp. 15-24. Report of lecture & discussion on basic office plans, organization elements, standards, compartmented organization, flexibility, office planning tools, steps, maintenance & control.
- 40. Pennicke, H. C. *Office layout for effective operations — Standards for measuring office efficiency* (Office Management Series #110). American Management Association, N. Y., 1946. pp. 28-47. Report of lecture & discussion on layout, site, private offices, lighting, clerical areas, space standards, layout suggestions, reception space, washrooms & wardrobes. **pt**
- 41. *Cost of industrial moves*. By R. H. McCarthy. American Management Association, N. Y., 1950. Successive moves of large organizations because of inadequate space or poor planning may cost as much as new construction. Urges more careful recording of moving costs.
- 42. *Office planning & layout*. Report issued by Policyholders Service Bureau of Metropolitan Life Insurance Company, N. Y. Rev. 1945. 26 pp. Surveys, area allocation, rough layout, partitions, heating & ventilating, lighting, acoustic treatment, decoration, finished layout, furniture, moving, small office layouts, references. **bp** Reprinted by Remington-Rand and in *The Office*, Feb. 46:70. *Buildings & Building Mgt.* Mar. 46:30-33 p Apr. 46:33-36 **pt**
- 43. *Washroom & locker-room facilities*. Report issued by Policyholders Service Bureau of Metropolitan Life Insurance Company, N. Y. Rev. 1948. 28 pp., Planning, special requirements, materials, fixtures & equipment. **ptv**
- 44. "Office buildings." Building Types Study #145. *Architectural Record*, Jan. 49:97-116. Esso buildings in Caracas & Baton Rouge, office buildings in Mobile and Chicago. Solar & earthquake problems. **dmpv**
- 45. "Office buildings." Building Types Study #130. *Architectural Record*, Oct. 47:119-146. New departures in office building design (Lathrop Douglass): Flexibility, fenestration, columns & framing, modules, economics. Examples. **dpsv** Same material in *Buildings* Jan. 48:36.
- 46. "Modern offices." *Architectural Record* (Continued on page 154)

Figure it at

**100%**  
**FULL RATING**

## AEROFIN RATINGS ARE ACCURATE AND RELIABLE

Aerofin's continued research has developed accurate ratings that are good for the life of the unit. You can always count on Aerofin to deliver full-rated capacity — full efficiency.

Over 25 years' experience, combined with unequalled production facilities, enables Aerofin to select just the right surface and materials for each particular job. Aerofin rigidly controls every phase of the production of its heat-transfer coils and units.

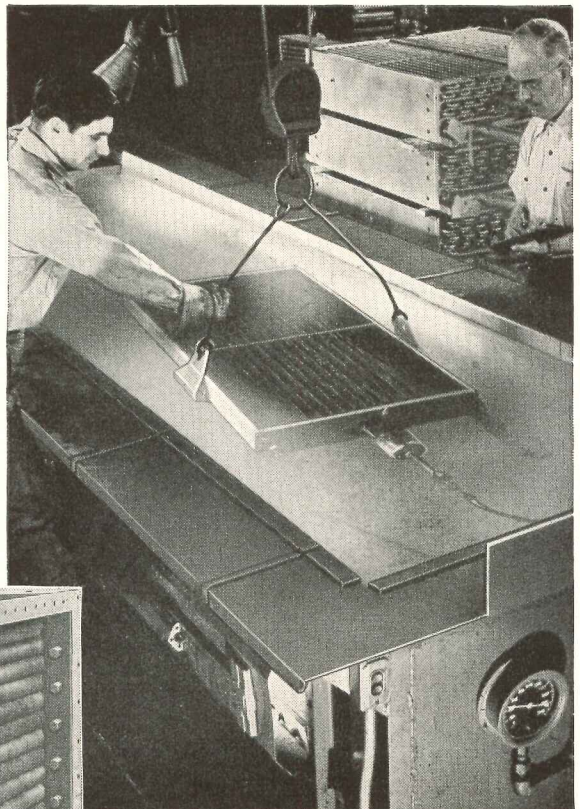

This man is looking for air bubbles — he is testing Aerofin heat-transfer coils with air pressure in a specially illuminated tank. If there are no bubbles, it means the immersed Aerofin unit has withstood the severe strains of steam and hydrostatic pressure tests and is ready to give you long, efficient service.

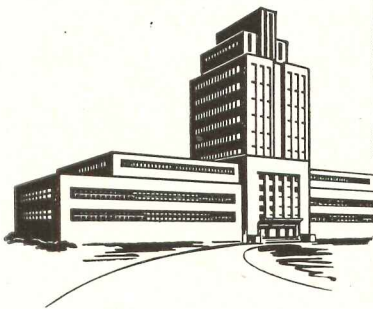

*Throughout the*  
**AIR CONDITIONING**  
*Industry —*

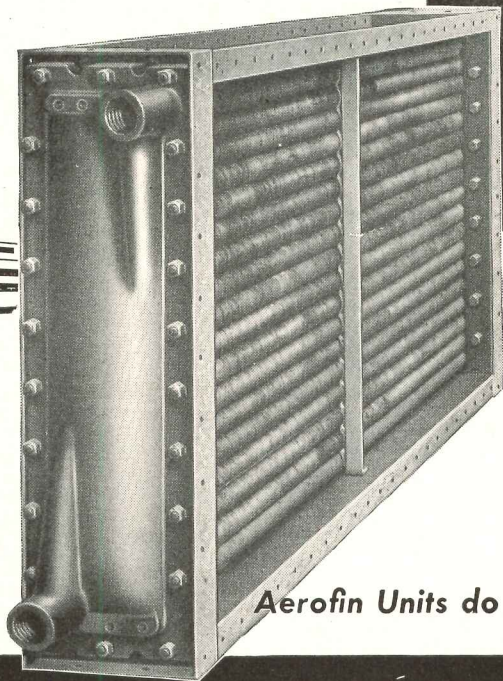

**Aerofin Units do the Job Better, Faster, Cheaper**

# AEROFIN CORPORATION

410 South Geddes St. SYRACUSE 1, N. Y.

NEW YORK • CHICAGO • CLEVELAND • DETROIT • PHILADELPHIA • DALLAS • MONTREAL

## nature and seaporcel\* blend in rugged beauty

For harmony with other materials - for variety and contrast - or alone in simple beauty - turn to Seaporcel Architectural Porcelain Enamel. Here, Bell Telephone Laboratories present an imaginative blending of Seaporcel Architectural Porcelain Enamel and *natural rock*. Over 10,000 sq. ft. - in light brown terra cotta finish - was utilized in the exterior facing of this modern edifice at Murray Hill, N. J. For beauty of appearance - low installation and maintenance cost - permanence - resistance to weather - and the integrity of its manufacturer . . .

Seaporcel Architectural Porcelain Enamel is unsurpassed.

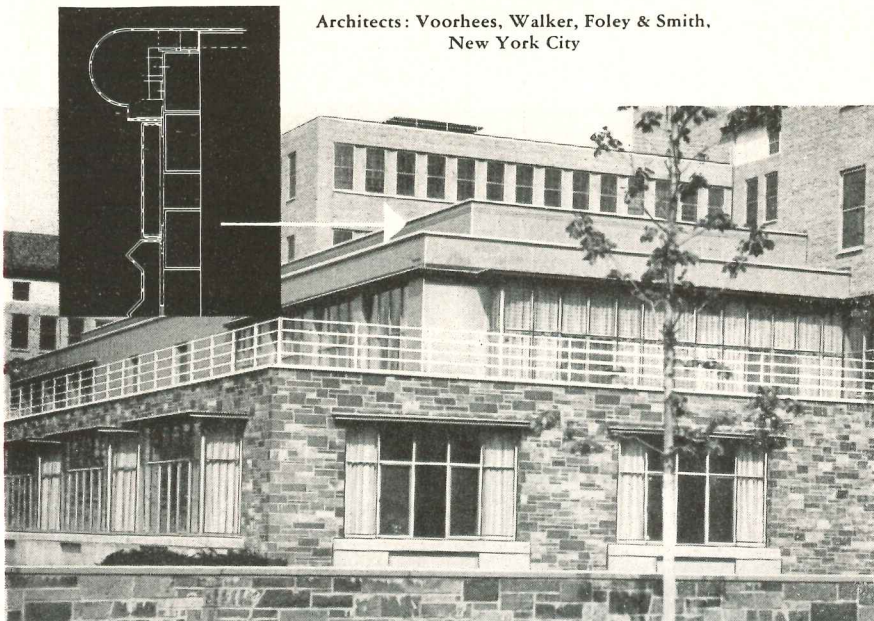

Architects: Voorhees, Walker, Foley & Smith,  
New York City

Like facts? Yours for the asking — a new "Fact Sheet" — giving complete, informative blue print diagrams and specifications of the Bell Telephone Laboratories Dining Room Facilities illustrated above. Just printed. Ask for a copy.

# seaporcel metals inc.

28-02 Borden Avenue, Long Island City 1, N.Y.  
STillwell 6-4900

See our catalog in SWEET'S  $\frac{6d}{3}$

For More  
Information —  
Use This  
Form

Member, Porcelain  
Enamel Institute

\*Reg. U.S. Pat. Off.

SEAPORCEL METALS INC. 28-02 Borden Avenue, Long Island City 1, N.Y.

Please send me Fact Sheet on Bell Laboratories \_\_\_\_\_  
Send me General Catalogue and other information \_\_\_\_\_

NAME \_\_\_\_\_

COMPANY \_\_\_\_\_

ADDRESS \_\_\_\_\_ CITY \_\_\_\_\_ STATE \_\_\_\_\_

## SMALL BUSINESS BUILDINGS

(Continued from page 152)

ord. Mar. 45:99-116. New trends, patterns in office planning, examples. **pstv**

47. "Office & loft buildings." Building Types Study #73. *Architectural Record*, Apr. 43:73-82. Article by Ely J. Kahn. Time-saver Standards on office building flexibility, space distribution, rentable area, construction, utilities. **dmpv**

48. "Office & commercial buildings." Building Types Study. *Architectural Record*, Dec. 41:81-91. Shopping center at Belmont, Mass. & several smaller office buildings. **dpv**

49. "Office buildings 1891-1941." *Architectural Record*, Feb. 41:43-49. Examples. **pv**

50. "Buildings for business." *Architectural Record*, Dec. 40:73-94. Examples & Time-saver Standards for telephone installations & flashings. **dpv**

51. "Design reference on office buildings." *Architectural Record*, Dec. 38:86-118. Planning, layout, clearances, summer air conditioning, acoustic control, lighting, color, rentability, examples. **bdptv**

52. "Physicosocial environment of the office." By A. H. Stricker. *The Office*, Aug. 49:29-44, 110-117. Adequate seeing conditions, noise control, ventilation, checklist for working conditions. **tv**

53. "When you build your own office building." By Harold C. Pennicke. *The Office*, Oct. 49:56-60, 151-161. Comprehensive article. See also "Layout standards for modern offices" by same author published in *The Office* for Mar. & Apr. 45 & to be republished soon. **dv**

54. "Principles of office space planning." By Ralph Tabakin. *The Office*, Sept. 48:48-51, 153-157. **v**

55. "Space allotment & control." By Kenneth H. Rippen. *Office Management & Equipment*, Feb. 48:31-32. Report form for preliminary design projects. **f**

56. "Modern office layout will pave the way for more profitable renting." *Buildings & Building Mgt.*, Aug. 45:27-30; Sept., 45:40-42. Typical offices for accountants, lawyers, insurance & general use. **p**

57. "Planning the new office building." By I. A. Herrmann. *The Office*, May, 45: 37-40. **dpt**

58. "Layout standards for modern offices." By Harold C. Pennicke. *The Office*, Mar. 45:37-42; **dpt**; Apr. 45:38-44, 74, 76. **dv**

59. U. S. Post Office Department. *Leaflets giving regulations for mailing equipment & installations:*

(1) Mailing chute rules, regulations & specifications.

(2) Apartment-house mail receptacles. Regulations & instructions (used also for business flats in residential areas).

(3) Instruction sheets listing approved manufacturers of apartment mail receptacles.

60. Two office buildings (MacKie & Kamrath). *Progressive Architecture*, Dec. 48:50-55. One-story, stone & wood construction. **pv**

61. Two-story office building (Raphael Soriano). *Arts & Architecture*, Nov. 48: 38-39. **v**

62. Office building for 5 business agents (Ain). *Arts & Architecture*, Aug. 48:30-31. One-story project. **ps**

63. Projects: Lawyers' office building (Ain). *Arts & Architecture*, May 47:26; **ps**; Oct. 48:36. **ps**

(Continued on page 156)



# Presenting The New and Beautiful

## Double-Duty INSULITE\*

### INTERIOR FINISH BOARD PRODUCTS

#### A Colorful New Line for Imaginative Design

##### Mr. Faber Birren



— nationally known consultant on color preferences of the buying public, selected these new consumer approved Insulite colors. He is retained by many of the world's largest manufacturers strictly for his experience in the vital field of consumer color preference and its relation to consumer buying habits. You profit by his two decades of research in the color wants and buying motives of the American public.

##### No Guessing Against Human Taste — These are Colors the Public Wants

Why gamble in selecting colors? Since color is vital to the success of your projects, every possible avenue of fact and scientific analysis was assessed and judged for its selling value before these new Insulite colors were chosen.

This was neither guesswork nor private opinion. Choice was based upon market research to accurately measure the desires of today's buying public. You can be *sure* these new Insulite colors are keyed to buying opinion.

##### Exceptional Sales Advantages

Rarely has there been a line of new products as rich in variety and flexible in adaptation as these new Insulite Interior Finish Products! Singly or in combination, they can be employed in a stimulating variety of striking and original effects. The finished result is beautiful . . . attention-getting . . . and exceedingly flattering.

Best of all (from the builder's point of view), these new products can be applied fast and easy . . . without special preparation or the use of special clips. No skill required — anyone can do it. Just use nails or staples direct to framework. Saves time, cuts application costs. This line was designed as a practical material for doing better interior jobs at economical cost.

##### New Insulite Joint

Assures a trim, neat, tight joint that defies dust infiltration and stays securely in position. Concealed fastening without using special clips. Application is fast and easy with nails or staples.

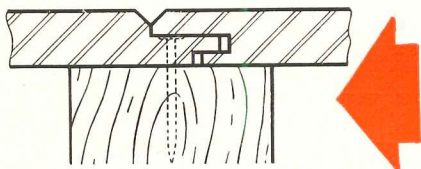

##### LUSTERLITE TileBoard and Interior Board

Colors: White, Ivory White. Texture: Smooth . . . high light-reflecting. Joint: TileBoard employs new Insulite Joint (illustrated below); Interior Board has square edged joint. Sizes: TileBoard, 12"x12", 16"x16", 16"x32"; Interior Board, 4' width by 6', 7', 8', 9', 10', and 12' lengths.

##### DUROLITE Plank and Interior Board

Colors: Ivory, Pale Green, Woodtone Light, Woodtone Dark. (The two Woodtones in the Plank are cartoned, half light and half dark, to provide variegated effect in application.) Texture: Rough . . . highly durable. Joint: Plank employs new Insulite Joint (illustrated below); Interior Board has square edged joint. Sizes: Plank widths are 8", 10", 12" and 16" — Lengths 8', 10', and 12'. Interior Board — 4' width by 6', 7', 8', 9', 10', and 12' lengths.

##### WEVELITE Interior Board

Color: Ivory White. Texture: Rough surface. Joint: Square edged. Sizes: 4' width by 6', 7', 8', 9', 10' and 12' lengths.

##### SMOOTHLITE Interior Board

(Formerly SMOOTHCOTE). Color: Natural. Texture: Smooth. Joint: Square edged. Sizes: 4' width by 6', 7', 8', 9', 10' and 12' lengths.

##### ACOUSTILITE ¾" and FIBERLITE ½"

Colors: White. Texture: Porous, giving a travertine stone effect. Joint: Butt Joint Edges Beveled and Kerfed. Applied with: Cement. Sizes: 12"x12", 16" x16", 16"x32".

\*Reg. U. S. T. M.

Refer to Sweet's File, Architectural Section 10a-9

1-50

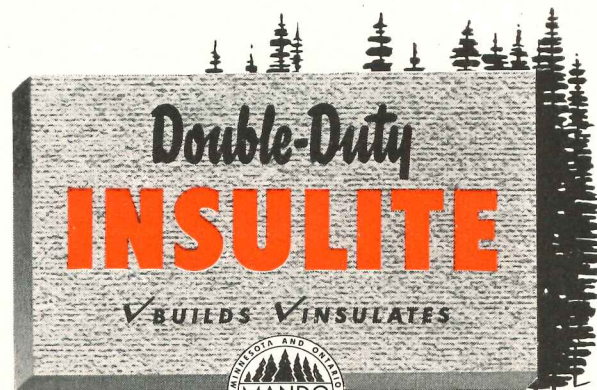

INSULITE DIVISION  
PAPER  
MINNEAPOLIS 2, MINNESOTA  
MINNESOTA AND ONTARIO  
COMPANY

(Continued from page 154)

Put **THIS** spring balance  
in **YOUR** windows for...  
**ECONOMY**  
**SMOOTH OPERATION**  
**PERMANENT SERVICE**  
plus perfect weatherstrip  
protection!

**MASTER**  
NO-DRAFT  
Sash Balance

Nowhere in the building does satisfaction mean so much to home owners than trouble-free windows. **SELL THIS FEATURE** with this combination unit. Equips both new and old sash. Eliminates weights and pulleys and painting. Made of non-corrosive metal and stainless steel for salt air locations or as a distinctive sales feature. Tested and proved in thousands of installations including government buildings.

Write today for complete information and specifications. See **Master No-Draft** demonstration at our Booth in space 117 at the National Association of Home Builders Show at the Stevens in Chicago, Feb. 19-23

mail coupon  
now...

**MASTER METAL STRIP SERVICE**  
1718 N. Kilbourn Ave., Chicago 39, Ill.

Please send me, without obligation, complete information about Master No-Draft Sash Balance.

NAME \_\_\_\_\_  
ADDRESS \_\_\_\_\_  
CITY \_\_\_\_\_ ZONE \_\_\_\_\_ STATE \_\_\_\_\_



**LIGHTING**

64. *Recommended practice of office lighting.* Illuminating Engineering Society, N. Y., 1947. 47 pp. Office tasks, influence of lighting on seeing, environmental factors, office lighting (daylight & artificial), specific areas, brightness ratios, nomenclature, wiring. dtv

65. "Proper maintenance — antidote for light loss." By W. R. Wilson. *Buildings*, May 49:36-39. Wiring, line voltage, access to lighting equipment, painting. gtv

66. "Light, eyesight, environment & their influence on production." *Office Management & Equipment*, Mar. 48:19-22 v; *The Office*, Dec. 47:68-72, 110-114. v Reports of two-year study by Public Buildings Administration in Washington in punchcard subsection of Bureau of Internal Revenue.

67. "Office lighting — a cost study." By R. L. Oetting. *Buildings*, Aug. 47:21-23, 48. Annual costs psf of office space illumination using: enclosing globes; deep bowl indirect; silver-bowl lamp indirect; fluorescent direct-indirect; fluorescent single-lamp troffer. t

68. "Light finishes improve office performance." By R. L. Oetting. *Office Management & Equipment*, July 47:33-36. v

69. "Influence of lighting on office production." By R. L. Oetting. *Office Management & Equipment*, Oct. 47:62-66, 106. tv

70. "Improving office seeing." By W. S. Greenwood. *The Office*, Dec. 46:44-52. tv

71. "Basic standards for good lighting." By LeRoy E. Varner. *Buildings & Building Mgt.*, Mar. 46:38-41. Lighting levels, lamp characteristics, brightness & glare, chart for lighting stores & offices. dt

**MAINTENANCE**

72. *Profitable building operation & maintenance.* Stamats Publishing Co. Cedar Rapids, Iowa. Book of reprints from *Buildings & Building Management* magazine.

73. "Outline of building maintenance." By Boyles & Farquhar. *Buildings & Building Mgt.*, May 46:28-30. I, Structure; II, Elevators; III, Equipment.

74. "A building manager's outline of modern cleaning methods." By Boyles & Farquhar. *Buildings & Building Mgt.*, Apr. 46:46-49. I, Public areas; II, Offices; III, Window washing; IV, Blinds & shades; V, Service calls.

75. "Here's why city air is so dirty." Chicago Association of Commerce, Smoke Abatement Committee. *Buildings & Building Mgt.*, Sept. 46:38. Weather & atmospheric conditions related to smoke, coal consumption & dustfall. Dustfall found to measure weather conditions, not a measure of fuel consumption. g

76. "Background for floor maintenance." By C. A. March. *Buildings*, Sept. 47:48-53. Safety measures, materials & methods for floor maintenance. t

77. "Background for floor selection." By C. A. March. *Buildings*, July 47:38-40. Cement-concrete, cork, asphalt & mastic tile, hard tile & terrazzo. *Buildings*, Aug. 47:39-43. Linoleum, magnesite, marble, travertine, wood.

78. "Longer life for resilient floors." By D. E. Smalley. *Buildings & Building Mgt.*, Jan. 47:13-15. Maintenance for linoleum, cork, rubber, asphalt tile flooring.

79. "How to select floor treatments." By D. E. Smalley. *Buildings & Building*

(Continued on page 158)

# *New Versatile Division Bar*

## **IN PITTCO PREMIER STORE FRONT METAL**

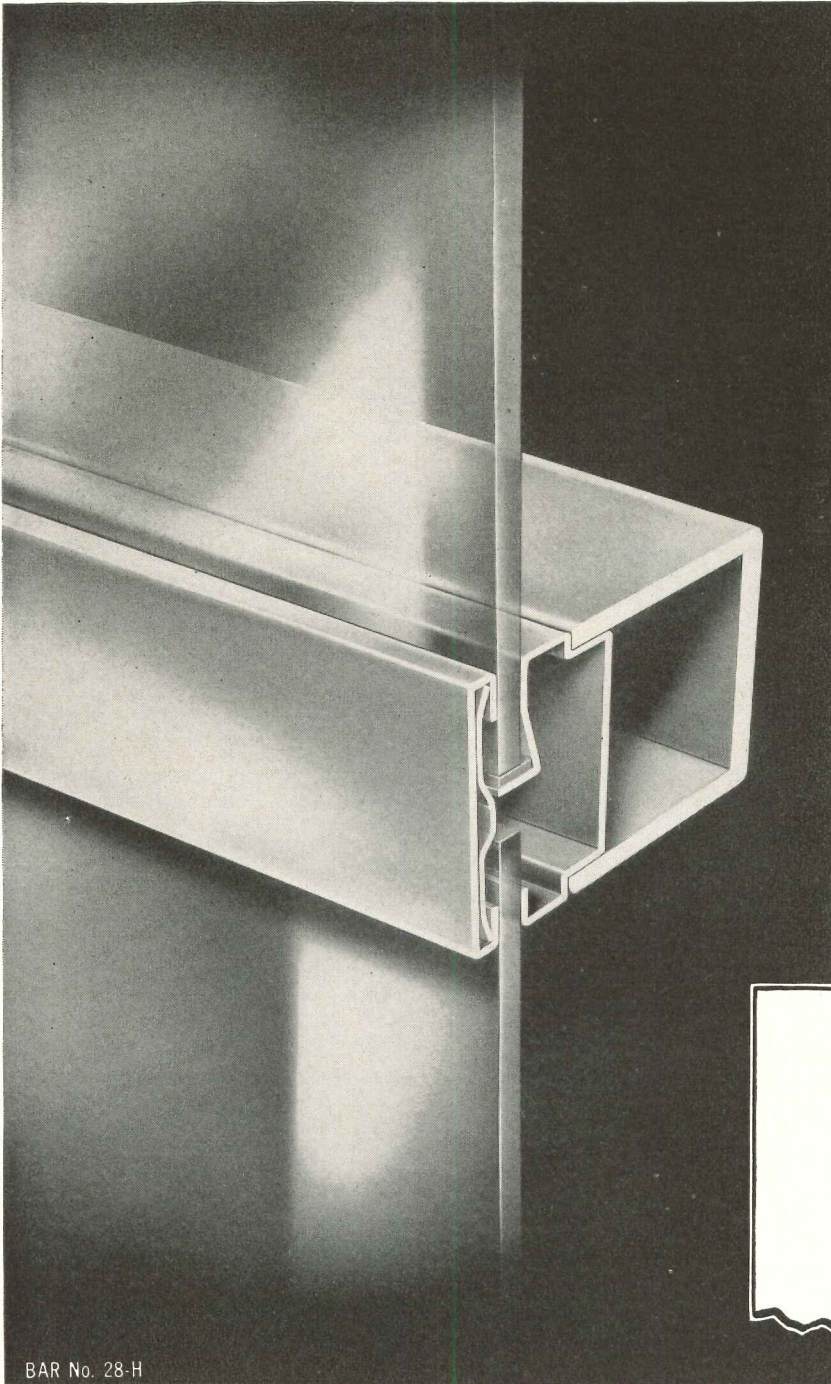

BAR No. 28-H

● This new Pittco Premier Division Bar (No. 28 H or V) will simplify design and construction on jobs where large areas of Plate Glass must be subdivided. Two features make it extremely practical. An interchangeable spring member permits this new bar to be used both horizontally and vertically. And skillful design has achieved unrivalled simplicity of structure and of installation. At intersections, a concealed fastening locks cross members together securely. Because of the bar's construction, mitering is unnecessary.

Division Bar No. 28 has a shallow profile and plain face, making it suitable for use in a wide variety of store front designs. It is extruded to give it maximum strength, yet it is not large and heavy. The extruded method of production assures a finish rich in tone and gloss.

The production of this versatile division bar is a result of Pittsburgh research . . . aimed to help solve architectural and building problems encountered in the field.

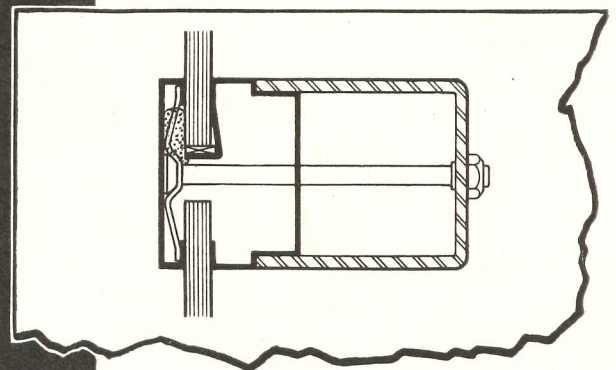

### **PITTCO STORE FRONT METAL**

PAINTS · GLASS · CHEMICALS · BRUSHES · PLASTICS

**PITTSBURGH PLATE GLASS COMPANY**

FOR ENDURING WHITENESS

... STUCCO

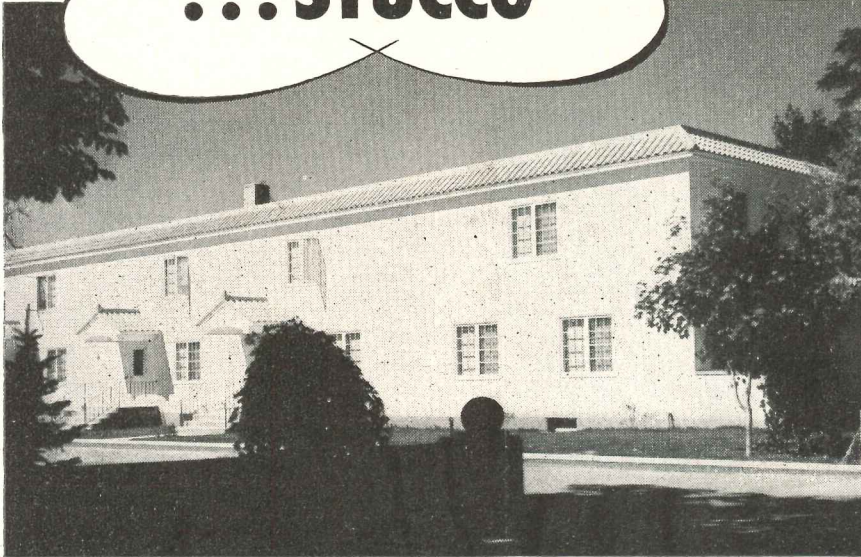

For lasting stucco...  
**ATLAS WHITE CEMENT**

Here's whiteness, appealing brightness that finds and fills the eye... *lasting* beauty that smiles at time and weather. It is clean, crisp, enduring stucco... made with a matrix of Atlas White Cement.

Such a matrix... pure white, or one of an infinite variety of pigment-based colors... brings out the full beauty of stucco. It also sets off, in blend or contrast, the full color of pigments used in portland cement paint or the aggregates used in terrazzo and architectural concrete slabs.

Utility? Durability? Atlas White Cement complies with ASTM and Federal Specifications for portland cement. It has the same advantages when used for concrete. Stucco, cement-paint, terrazzo, architectural slabs... made with Atlas White Cement... all clean easily and maintenance costs stay low.

**ATLAS WHITE  
\*DURAPLASTIC**

air-entraining portland cement adds new advantages to stucco at no extra cost. It provides increased plasticity that makes application easier; insures greater durability; offers stouter resistance to weather. Ask for details.

For further information on the uses of Atlas White Cement, see SWEET'S Catalog, Section 4B/3 and 13C/5, or write to Atlas White Bureau, Universal Atlas Cement Co. (United States Steel Corp. Subsidiary), Chrysler Bldg., New York 17, N. Y.

*\*DURAPLASTIC is the registered trade mark of the air-entraining portland cement made by the Universal Atlas Cement Company.*

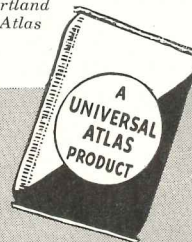

FOR BEAUTY AND UTILITY

**ATLAS WHITE CEMENT**

FOR TERRAZZO, PAINT, SLABS, STUCCO

"THEATRE GUILD ON THE AIR"—Sponsored by U. S. Steel Subsidiaries  
Sunday Evenings—NBC Network

SMALL BUSINESS BUILDINGS

(Continued from page 156)

*Mgt.*, Oct. 46:19-20, 39. Waxes, cleaners, sealers, paints.

80. "What every manager should know about techniques in decorating." *Buildings*, Aug. 48:47-51. Article on painting. *gt*

81. "Color schemes for offices." By C. E. Seghers. *The Office*, Nov. 46:60-66. Talk at National Business Show. Chart showing physical characteristics of spectrum colors, reactions, associations, etc. *g*

82. "Use of color for office painting." By W. W. Krug. *The Office*, Mar. 46:37-41, 54-60. DuPont recommendations. *v*

83. Color under foot. *Buildings*, Oct. 49:35. Benefits of dark, colored sidewalks: reduction of reflections, glare and surface cracking. *v*

**FIRE PROTECTION & SAFETY**

84. *National Building Code*. National Board of Fire Underwriters, N. Y., 1949. 258 pp. *dt*

85. *Building code standards for installation of heat producing appliances, heating, ventilating, air conditioning, blower & exhaust systems*. National Board of Fire Underwriters, N. Y., 1949. 40 pp. *dt*

86. *Standards... for installation of air conditioning, warm air heating, air cooling & ventilating systems*. National Board of Fire Underwriters, N. Y., 1946. (NBFU Pamphlet #90). Includes appendix dated Aug. 1948.

87. *National Board of Fire Underwriters Bulletins*.

#10. Jan. 22 '35: Hazard of combustible lining in airducts.

#35. Apr. 15 '37: Hazard of air conditioning systems.

#68. Dec. 15 '38: Life safety in buildings.

#121. May 15 '41: Automatic devices for heating equipment.

#165. Apr. 2 '43: Acoustic materials.

#168. May 15 '43: Fire-resistant floor & ceiling constructions.

#239. Sept. 2 '46: Oil burner fire causes.

88. *List of inspected fire protection equipment and materials*. Underwriters' Laboratories, Inc., Chicago, N. Y., San Francisco. Jan., 1949. 200 pp.

89. "Tough category — Tough spot — Action needed." By Rex E. Hieronymus. *Skyscraper Mgt.*, Jan. 48:10-11. *g*

90. "Fire causes." *Buildings & Building Mgt.*, Jan. 45:36.

91. "The day our office burned." By Mary J. Scott. *The Office*, Apr. 47:48-52, 72-73. Graphic story of fire salvage. *v*

92. *Office hazards*. Report issued by Safety Bureau of Metropolitan Life Insurance Company, N. Y., 10 pp. Checklist.

**PERIODICALS**

In addition to the regular architectural periodicals the following will be of interest to office building planners:

93. *Buildings* (Monthly). Stamats Publishing Company, 427 Sixth Ave., SE, Cedar Rapids, Iowa. \$3.00/yr. (Formerly Buildings & Building Management).

94. *Skyscraper Management* (Monthly). National Association of Building Owners & Managers, 134 South LaSalle St. Chicago 3, Ill. \$3.00/yr.

95. *Journal of Property Management* (Quarterly). National Association of Real Estate Boards, 72 West Monroe St. Chicago 3, Ill. \$5.00/yr.; \$1.25/copy.

96. *Urban Land* (Monthly). Urban Land Institute, 1727 K St., NW, Washington 6, D.C. \$10.00/yr.

AR-S-15

FOR BEAUTY AND UTILITY  
**ATLAS WHITE CEMENT**  
FOR TERRAZZO, PAINT, SLABS, STUCCO



*Now!* a New Design Freedom for Architects  
**THE SCHLAGE "Long Backset"**

The Schlage "long backset" allows the lock to be installed any distance from the door edge. This means that architects can now place the lock wherever it will produce the best design effect. Large, eye-catching escutcheons can be used for more dramatic treatment of entrances.

*The "long backset" is a feature found only in Schlage cylindrical locks. It embodies proven Schlage design and construction principles.*

A new brochure, illustrating the "long backset" and many Schlage lock designs is now available. A request to your Schlage dealer or to Schlage Lock Company will promptly bring you a copy.

**SCHLAGE**<sup>®</sup>  
**SCHLAGE LOCK COMPANY**

2201 Bayshore Boulevard

•

San Francisco 19, California

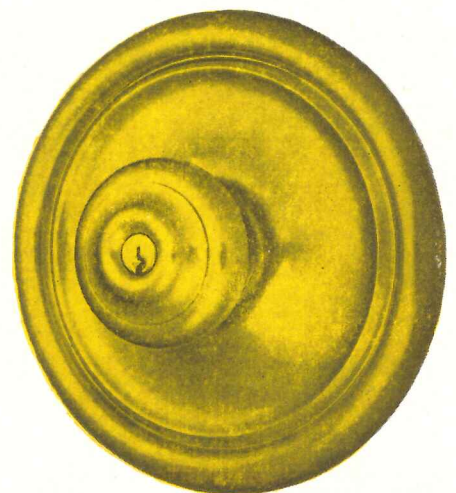

Schlage Pantheon Design  
 (8" escutcheon)

## PRODUCTS

(Continued from page 124)

equipped with offset brackets which provide for 6-in. overlap of the shades. The angle may be mounted to the wall, ceiling or window head. Shades are of the spring roller type and are available to measure in tan or black cloth. Luther

O. Draper Shade Co., Spiceland, Ind.

### Metal Furniture

A new collection of metal and foam rubber furniture, designed by architect William Armbruster, has been introduced by the Edgewood Furniture Co. The simple frames are of square steel tubing with welded joints, matte-finished in lacquered charcoal, off-white, gun-metal, olive or gray. These finishes are said to

be unconditionally guaranteed against chipping and corrosion. The seats and back cushions are of foam rubber, upholstered in a variety of materials, including a new nylon fabric designed for hard wear. Cushions are supported by webbing offered in six standard colors: red, black, green, aqua, lime or beige.



Chairs have sturdy and trim construction

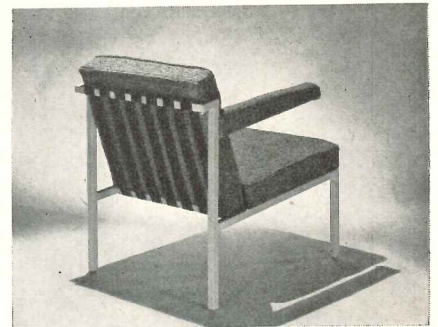

**LOW IN COST • LIGHT IN WEIGHT**

*Enduring Beauty!*

**HASTINGS** AIRCRAFT ALUMINUM **alumitile**

REPLACEMENT OR RETURN OF MONEY  
★  
Guaranteed by  
Good Housekeeping  
IF NOT AS ADVERTISED THEREIN

**INSIDE FINISH**  
Attractive, smooth, lustrous enamel finish permanently bonded to sturdy aircraft aluminum . . . 14 vital colors . . . will not crack, peel or chip. Easy to clean.

**OUTSIDE FINISH**  
A choice of 7 beautiful exterior colors in regular or embossed finish, applied by an exclusive process that insures a maximum of color control, density and uniformity.

**SELF-DECORATING**  
A variety of sizes and colors permits modern decorative designs on interior or exterior walls . . . each job tailored to individual requirements for distinctive, lasting beauty.

### FIREPROOF . . . RUSTPROOF . . . WEATHERPROOF

HASTINGS *alumitile* is impervious to fire, rust and water, and cannot corrode. May be used *anywhere* indoors or outdoors with gratifying results. It has a gleaming bone-hard enamel finish . . . the lifetime colors are baked on. This amazing wall facing is enjoying ever increasing popularity in the construction of new buildings and the modernization of old. It strikes a modern tone which has brought enthusiastic endorsement from leading decorators, architects and contractors. Yet its cost is surprisingly low, its strength and adaptability almost unbelievable.

### SCORES OF USES

The wide versatility of HASTINGS *alumitile* is expressed in its countless uses for homes, institutions, business buildings. It is ideally suited for bathrooms, kitchens, laundries, utility rooms; for dairies, bottling plants, breweries, bakeries, pharmacies, hotels, hospitals, dental offices; for store and theatre fronts, lobbies, service stations.

### METAL TILE PRODUCTS, INC. HASTINGS, MICHIGAN

Makers of Hastings *alumitile*, *alumi-SHIELD* awnings, doorhoods, mouldings and flashings



### EASY TO APPLY— EASY TO SELL

Offers consistent quality, sanitary sealing, insulation value, handling flexibility, scope for design, uniformity of workmanship—all at a marked saving in labor hours.

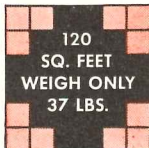

### STRENGTH WITHOUT BULK

Save on bulk; save on shipping and handling costs; save on storage space. Lightweight HASTINGS *alumitile* is packaged compactly for convenience and economy. Well adapted to large wall areas where weight and square-foot costs are important factors.

### METAL TILE PRODUCTS, INC. DEPARTMENT 102, HASTINGS, MICHIGAN

I should like to know more about your products.

I am a  Distributor  Dealer  Architect  Contractor

Name \_\_\_\_\_

Address \_\_\_\_\_

City \_\_\_\_\_ State \_\_\_\_\_

**AN UNUSUAL PROFIT OPPORTUNITY  
FOR LIVE DEALERS AND DISTRIBUTORS  
USE THIS COUPON** ➔

The group was specifically designed for use in public places where durable construction is needed; however, the neat, trim appearance makes the line equally suitable for homes or other uses. The collection consists of 11 pieces: two large side chairs; an occasional arm chair; an armless easy chair; a group consisting of a 24-in.-wide unit chair, an armless love seat and a club chair; a large lounge chair with a head rest; a bench; a slate-top lamp table; and a bronze-based, marble-top cocktail table. Tables are also available with wood plank or formica tops. Edgewood Furniture Co., 208 E. 27th St., New York, N. Y.

### Sun Filter Coating

*Infracote* is a plastic coating for windows, glass block, etc., designed to prevent fading and bleaching by the sun and also to shut out the heat rays. In appearance, the coating is said to be practically colorless, but to turn a faint

(Continued on page 162)

**NOW!**

# LUVEX

**DAY-BRITE'S**

**NEW!**

For two 96" T-12 Slimline lamps, single unit or continuous installations. For suspension mounting, listed with 8" and 28" "A-J" Adjustable hangers.

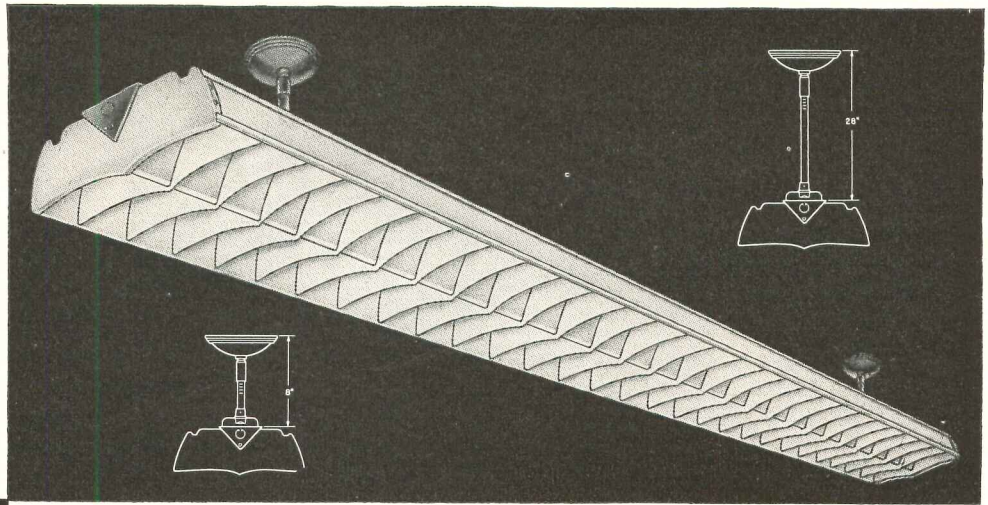

469

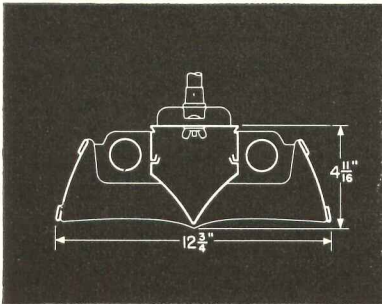

## "DECIDEDLY BETTER" SLIMLINE

Once in a blue moon, a truly great fixture makes its appearance. Now, after years of research and designing, the matchless new Day-Brite "LUVEX" is ready.

All the usual advantages of Slimline, of course — instant starting . . . extremely high efficiency.

But then, add these "LUVEX" extras—sturdy, *no-sag*, heavy gauge steel chassis, *enclosure and louvers completely interlocked into a rigid one-piece unit*, quick, easy installation and smart appearance—and the "LUVEX" is absolutely *everything* you expect of Slimline lighting.

Maintenance? *Simple!* So simple, in fact, that

the "LUVEX" can be relamped and cleaned without disturbing a single part of the fixture—without so much as touching a latch, chain, nut or bolt!

Get the full "LUVEX" story. It will pay you to know all the facts about this remarkable new Day-Brite development. Write today for Bulletin 10-M.

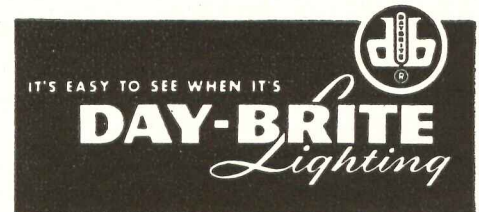

Distributed nationally by leading electrical wholesalers  
Day-Brite Lighting, Inc., 5465 Bulwer Ave., St. Louis 7, Mo.  
In Canada: Amalgamated Elec. Corp., Ltd., Toronto 6, Ontario

## PRODUCTS

(Continued from page 160)

yellow in sunlight. It is claimed to serve as an effective heat protective device, while transmitting approximately 84 per cent of visible light. The coating is said not to be affected by atmospheric conditions or to present a fire hazard.

Its use is recommended by the manufacturer for large window areas. Lite Control Products Co., Nutley 10, N. J.

### Air Distribution Unit

Designed for use with ventilating and air conditioning systems in schools and public buildings, the *Uni-Flo* grill with integral volume control is said to combine draftless air distribution and regulation of air volume in a single unit.

Quantity and direction of air are regulated by adjustments accessible from the grill face. Cores are removable for duct access and cleaning. The rectangular units are supplied in a prime gray coat or in a selection of electroplated metal finishes. Barber-Coleman Co., Rockford, Ill.

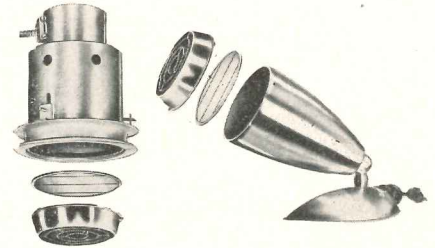

New fixtures with louvers and filters

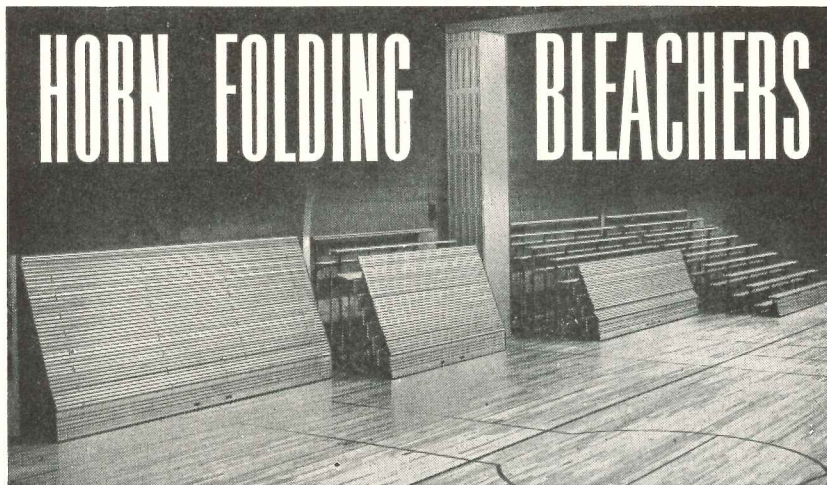

## Horn Folding Bleachers and Horn Folding Partitions for Greater Space Utilization

CHECK  
YOUR  
SPACE  
REQUIRE-  
MENTS

ROWS	FLOOR SPACE		**HEIGHT
	IN USE	*CLOSED	
3	4 Ft. 9 in.	1 Ft. 8 3/4 in.	3 Ft. 0 in.
4	6 Ft. 7 in.	2 Ft. 0 1/8 in.	3 Ft. 9 in.
5	8 Ft. 5 in.	2 Ft. 3 1/2 in.	4 Ft. 6 in.
6	10 Ft. 3 in.	2 Ft. 6 7/8 in.	5 Ft. 3 in.
7	12 Ft. 1 in.	2 Ft. 10 1/4 in.	6 Ft. 0 in.
8	13 Ft. 11 in.	3 Ft. 1 1/2 in.	6 Ft. 9 in.
9	15 Ft. 9 in.	3 Ft. 5 in.	7 Ft. 6 in.
10	17 Ft. 7 in.	3 Ft. 8 3/8 in.	8 Ft. 3 in.
11	19 Ft. 5 in.	3 Ft. 11 3/4 in.	9 Ft. 0 in.
12	21 Ft. 3 in.	4 Ft. 3 3/8 in.	9 Ft. 9 in.
13	23 Ft. 1 in.	4 Ft. 6 1/2 in.	10 Ft. 6 in.
14	24 Ft. 11 in.	4 Ft. 9 7/8 in.	11 Ft. 3 in.
15	26 Ft. 9 in.	5 Ft. 1 1/4 in.	12 Ft. 0 in.
16	28 Ft. 7 in.	5 Ft. 4 5/8 in.	12 Ft. 9 in.
17	30 Ft. 5 in.	5 Ft. 8 in.	13 Ft. 6 in.
18	32 Ft. 3 in.	5 Ft. 11 3/8 in.	14 Ft. 3 in.
19	34 Ft. 1 in.	6 Ft. 2 3/4 in.	15 Ft. 0 in.
20	35 Ft. 11 in.	6 Ft. 6 1/8 in.	15 Ft. 9 in.

\*Dimension includes 4 1/2 in. space between top seat and wall.

\*\*Height in open position same as closed. For Bleachers higher than 20 Rows write for complete details and dimensions.

FOR SEATING CAPACITY FIGURE 16" PER PERSON. WRITE FOR COMPLETE DETAILS ON THE "3 IN 1 HORN GYM PLAN". NO OBLIGATION

# HORN BROTHERS CO.

A DIVISION OF HORN INDUSTRIES

FORT DODGE, IOWA



ESTABLISHED 1909

### Lighting Fixtures

The *Midget-Lite* line of lighting fixtures has been introduced for use with the new 75-watt, R30 lamps or the 100-watt standard lamp. Available in recessed, portable, screw-in, box plate and clamp-on models, the fixtures feature baffled air vents to prevent light spill, a "brushed satin" clear lacquer finish, and universally adjustable spring tension sockets. The sockets are said to have no wing nuts or set screws and to stay put at any angle. A special device is included to prevent wire twisting.

The hoods of most models are 8 by 4 5/8 in., with extension pipes available from 6 to 48 in. in length. Recessed, *Midget-Toplite* fixtures are 6 7/8 in. in depth and 5 or 5 7/8 in. in dia. Louvers and color lenses are available for use with all models. Swivelier Co., Inc., 30 Irving Pl., New York 3, N. Y.

### Electric Water Heaters

The *Milwaukee* line of electric automatic storage water heaters is being offered as a companion-line to A. O. Smith Corp.'s round and table-top heaters. The new heaters were developed for the popular price field and are available in common round sizes. Features include full-blanketed fibrous insulation, sealed immersion units, "rear-vu" connections, and "Anchorloc" assembly of tank to base. A. O. Smith Corp., Kankakee, Ill.

### Plastic Fabric Prints

*Suskana* fabrics, designed for use as upholstery, draperies, etc., are made

(Continued on page 164)



# the HANNA BUILDING

CLEVELAND,  
OHIO

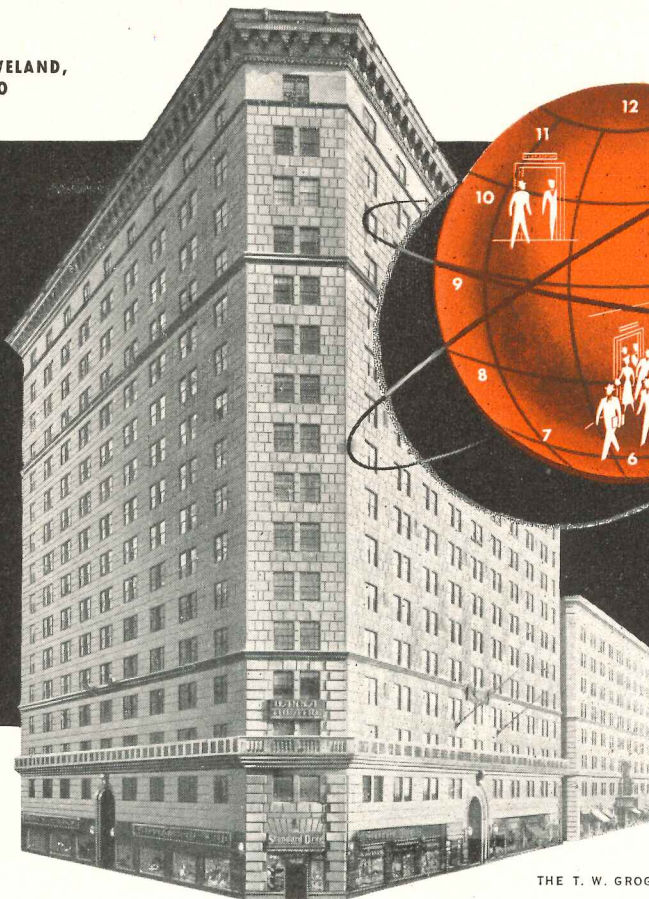
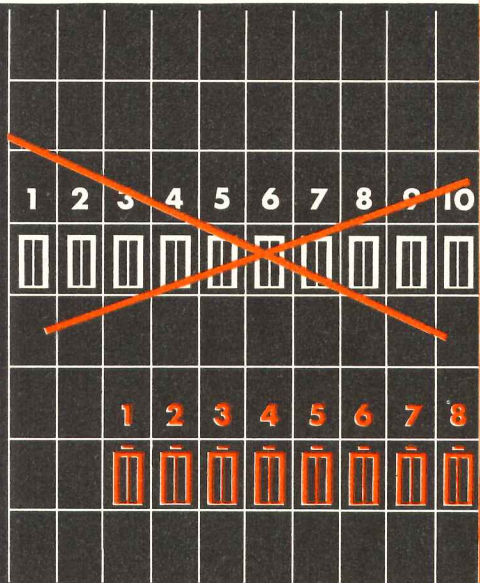

THE T. W. GROGAN COMPANY, MANAGEMENT

replaces **10**  
car-switch elevators with **8 OTIS AUTOTRONIC ELEVATORS**

## Saves The Cost of 2 Cars and Reduces Passenger Waiting Time Throughout The Entire Business Day

Hanna Building tenants and visitors will be delighted with the time-saving convenience of modernized service. For the new Otis AUTOTRONIC Elevators, with their traffic-timed automatic supervision, have been designed to reduce the elevator interval from 50 seconds to less than 25 seconds during the morning peak period. A similar speed-up of service will be applied to the other 5 traffic patterns of the day. So, with the time interval reduced through automatic supervision, 8 AUTOTRONIC elevators will serve all floors—and give far better service than the manually operated 5 Express and 5 Local cars they replace.

From the management viewpoint there's the increased prestige of unexcelled elevator service and the economy of installing and operating 8 instead of 10 elevators. Otis AUTOTRONIC ELEVATORING—already bought by 38 NEW and MODERNIZED office buildings, hotels, banks and department stores—is explained in Otis Booklet B-721-F.

Elevator service in the Hanna Building Annex is also being modernized by replacing 4 Car-Switch Elevators with 2 Otis ELECTRONIC Signal Control Elevators. Here, too, the modernization will be dramatized with Otis electronic "touch" buttons that summon cars as if by magic. Otis Elevator Company, 260 11th Avenue, New York 1, N. Y.



A U T O T R O N I C  
t r a f f i c - t i m e d  
E L E V A T O R I N G

**PRODUCTS**

(Continued from page 162)

of Vinylite plastic film, printed by a multi-color rotogravure process. The method is claimed to allow reproduction of any color photograph and to be low in cost when the fabrics are mass produced.

The plastic film reputedly drapes well, is easily sewn, and wipes clean with a damp cloth. It is also said to resist fading, cracking, stretching, shrinking and staining, and not to support flame.

The material is available in a large variety of stock patterns printed on a choice of several opaque, clear or translucent base colors. Susquehanna Mills, Inc., 404 Fourth Ave., New York 16, N. Y.

**WEATHER STRIPS FOR SLIDING DOORS**



In this splendid Kentucky home, "ACCURATE" metal weather stripping for sliding doors was installed in 1944 in accordance with specifications by Mr. James Kellum Smith, of McKim, Mead & White, Architects. Five years of constant use have demonstrated the truly dependable performance of sliding doors fitted with "ACCURATE" weather stripping. Everywhere, more and more architects and owners are looking to "ACCURATE" for real sliding door weather protection. Consultation invited.

**ACCURATE METAL WEATHER STRIP CO., Inc.**

215 EAST 26th STREET, NEW YORK 10, N. Y.

**Fluorescent Sun Lamp**

A new sun lamp, identical in dimensions and electrical operating characteristics with standard fluorescent lamps, is said to radiate over a large area with an output concentrated in the mid-ultraviolet wavelengths. Reportedly, no elaborate starting and operating controls are necessary, and the device starts immediately without any warm-up period.

A suggested use for the lamp, besides therapeutic treatments, is for low intensity space irradiation for such places as schools, offices, factories, recreational areas and hospitals. The lamp is claimed to have a life of 4000 hr, to be low in price and power consumption, and to be cool to the touch. It is available in 20 and 40-watt units. Westinghouse Lamp Div., Bloomfield, N. J.

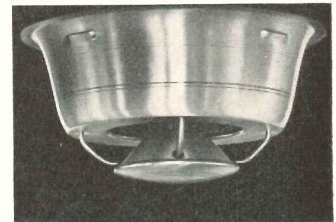

Baffle employs rubber mounted cone

**Speaker Baffles**

Lowell metal speaker baffles are designed for low-level sound control and use with any customary speaker. Made of spun aluminum or spun steel, the baffles may be finished in any colored lacquer desired, and feature light weight and easy installation. Among the 12 models available are: a flanged, directional wall type; a directional, recessed wall type; and models with suspended, flush or recessed mountings for various height or dropped ceilings. Most types are also available in combination with Circline fluorescent light fixtures. All hardware for mounting speaker to housing is furnished, but speakers are not included. Lowell Metal Products Corp., 1531 Branch St., St. Louis 7, Mo.

**Circulating Pump**

Planned for use in the small house field, the B&G 75 booster is said to be light in construction, quiet in operation, compact, easy to install and efficient. The pump uses a 1/15 hp motor, is oil lubricated, and has a precision-ground water-tight seal. Connections consist of

(Continued on page 166)

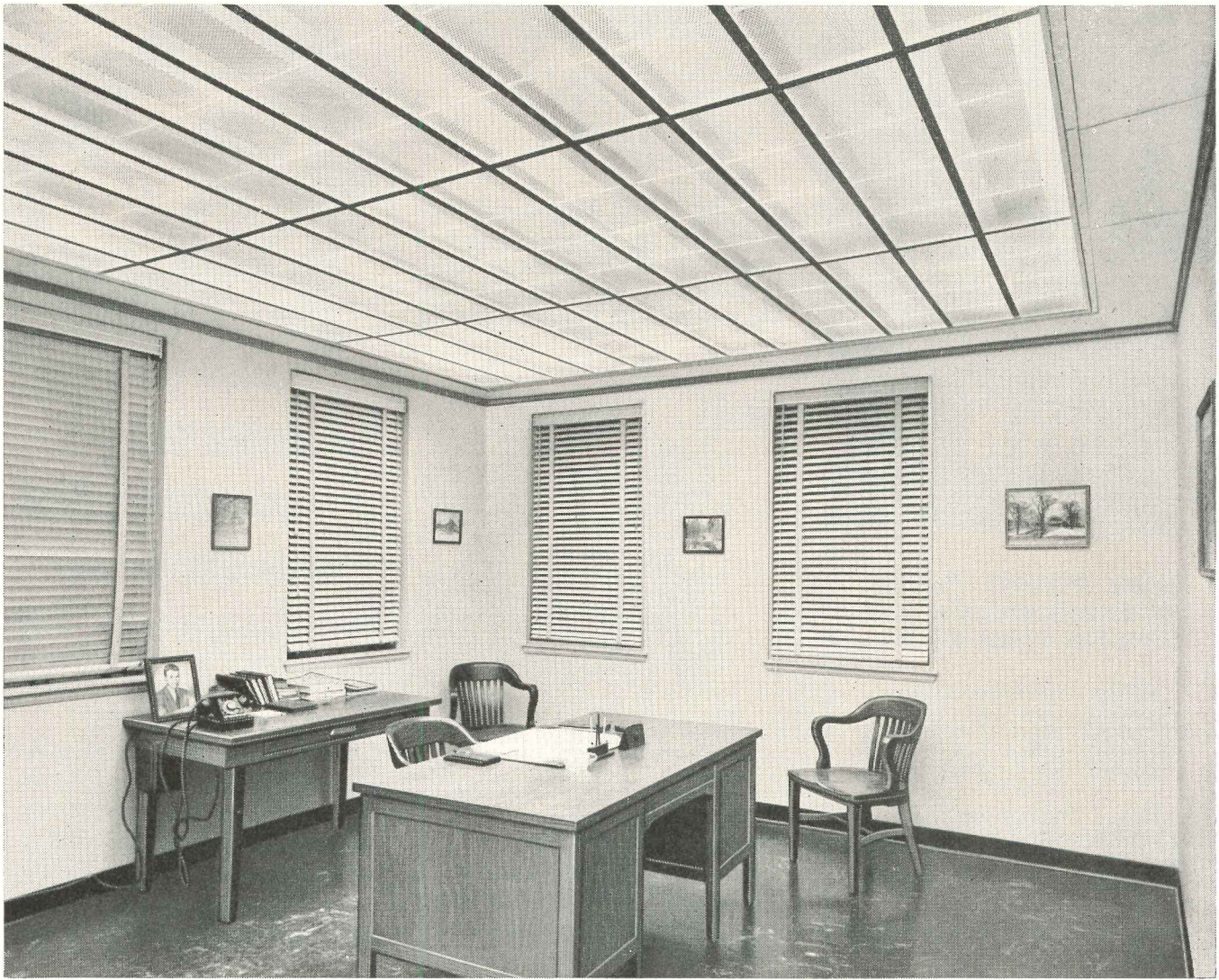

*New!* A Luminous  
Ceiling by LITECONTROL  
Featuring Ultra-New,  
*Low Brightness Lenses*

Here's the newest thing in lighting — an office with a luminous ceiling, featuring exceptional low brightness both lengthwise and crosswise, utilizing ultra-new Holophane No. 9015 Controlenses\*. Construction is simple — installation easy — maintenance minimized — and ceiling costs cut!

Because of the design flexibility of this system, either large or small areas can be lighted attractively with variable intensities by using standard Bipin lamps or T-8 or T-12 Slimline

lamps in various switching arrangements.

We'd like to tell you more about this new lighting triumph — help you with lighting layouts or advice, in applying it to your projects. Why not write today?

Area: Approximately 200 sq. ft.

Ceiling Height: 8'-7"

Lamps: 6 - 96T12 75 Watt Warmtint Slimline  
6 - 48T12 40 Watt Warmtint Slimline

Lenses: 144 - #9015 Holophane Controlenses\*

Wattage: 900.

Watts per square foot: 4.5

Intensity:

Average on desk — 112 Footcandles Initially

Average in entire room — 70 Footcandles Initially

Brightness Readings:

Along lamp axis:

45° - 1.2 Candlepower per sq. inch

60° - 0.14 Candlepower per sq. inch

70° - 0.11 Candlepower per sq. inch

Across lamp axis:

45° - 1.5 Candlepower per sq. inch

60° - 0.3 Candlepower per sq. inch

70° - 0.3 Candlepower per sq. inch

\*©HOLOPHANE CO., INC.

LITECONTROL CORPORATION  
36 Pleasant Street, Watertown 72, Mass.



LITECONTROL *Fixtures*

KEEP UPKEEP DOWN

DESIGNERS, ENGINEERS AND MANUFACTURERS OF FLUORESCENT LIGHTING EQUIPMENT DISTRIBUTED ONLY THROUGH ACCREDITED WHOLESALERS

Efficiency goes

UP

Costs come

DOWN

**Rotary Oildraulic Elevators are the most economical type for 2, 3 or 4 story buildings**



**Smooth, quiet operation**

Smooth starts and stops, accurate floor leveling, and quiet operation are guaranteed by Rotary's precision mechanism.



**No costly penthouse**

Because it's pushed from below, not pulled from above, an Oildraulic Elevator requires no costly, unsightly penthouse.



**Lighter shaftway structure**

Rotary's powerful Oildraulic jack supports the car and load—so there's no need for heavy, load-bearing columns and footings.

**Over 50,000 Rotary Oildraulics in Use**

Rotary, oldest and largest maker of oil hydraulic elevators and lifts, has served major companies and building owners throughout the nation. Our coast-to-coast organization offers the most complete service in this field. Write for Catalog.

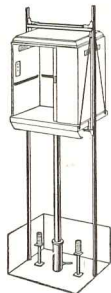

ROTARY LIFT CO.  
1101 Kentucky, Memphis, Tenn.

**Rotary**  
**Oildraulic**  
**Elevators**  
PASSENGER AND FREIGHT

See Section 33a in Sweet's File

10

**ARCHITECTURAL  
ENGINEERING**

TECHNICAL NEWS AND RESEARCH

**PRODUCTS**

(Continued from page 164)

3/4-in. forged-steel, non-breakable, two-bolt flanges, the joint construction of which is claimed to permit tightening with little more than finger pressure. Bell & Gossett Co., Morton Grove, Ill.

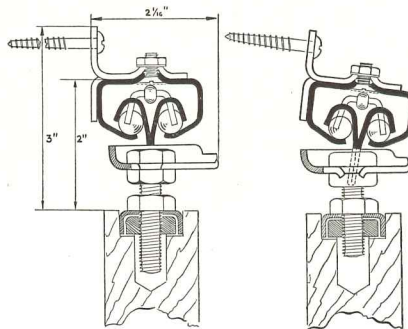

Hardware features roller mounts

**Sliding Door Hardware**

A complete set of residential-type hardware for sliding doors, including track, sidewall brackets, stops, screws, and floor guide, features smooth and silent operation on 4 SKF steel balls. The balls roll free in 14-gage steel tracks, without any sort of encasement in which they might get clogged. Doors from 3/4 to 1 3/4 in. thick and weighing up to 150 lb may be used. The door is centerhung from a patented hinge said to eliminate side pressure or friction, and to cause the door to hang vertically always. The tracks of *Zephyr* hardware are said to be easily installed to the side or overhead, to be dust shielded, and to have vertical and horizontal adjustment. The minimum distance from top of door to top of track is 2 in. Double doors require two single sets of hardware. Sliding Door Equipment Corp., 211 E. 37th St., New York 16, N. Y.

**Water Filter**

The *Fisher* water filter unit is built around a permanent metallic filter element, composed of microscopic bronze spheres. The unit is said to filter up to 10 gal of water per min and to weigh less than 5 lb. A transparent plastic case allows vision of foreign matter collected by the filter. To clean, the filter body is

(Continued on page 168)

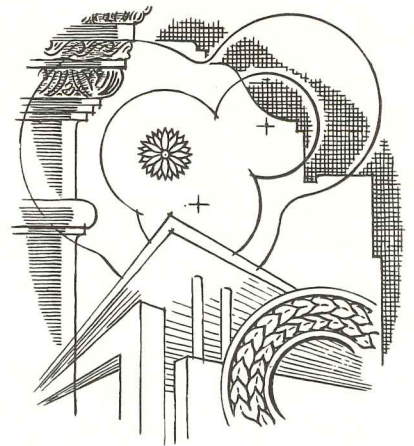

**for forms OLD  
and forms NEW**

**Lime Plaster is the Answer**

No building material lends itself so willingly to the imagery of the architect. To the smooth surfaces, regardless of their contours; the highly ornamented, regardless of their style.

Also, no substitute has matched good plaster for soundness of construction and life-of-the-building durability. It provides an interior finish that is smooth, clean, free of joints, vermin and rodent proof, fire safe and accoustically right. Finishing Lime from Northwestern Ohio has long been the accepted standard.

- OHIO WHITE and HAWK SPREAD are Ohio Hydrate's identical brands of hydrated finishing lime. They are always uniformly right, 99 1/2% pure.
- OHIO WHITE AUTOCLAVED Finishing Lime is equally good quality. It needs no soaking. For fine, white coat plaster, brick mortar and other uses.
- OHIO SANLIME FINISH, a plaster for sand finish interior work, contains all ingredients in dry-mixed form. In white and in colors: ivory, buff, pink, blue, and light green.

The red zigzags on the bags are our trademark, your assurance of quality.

**The OHIO HYDRATE & SUPPLY Co.**  
WOODVILLE, OHIO



Send today for your free copy of the rules of the

# Chicago Tribune's Fourth Annual BETTER ROOMS COMPETITION

**\$25,000.00 in 145 Cash Prizes**

*ranging from \$100.00 to \$1000.00 each*

*for the best ideas for furnishing and decorating seven types of rooms*

**ALL ENTRIES MUST BE RECEIVED BY 5 P. M. OF FEBRUARY 20, 1950**

**I**N order to bring to readers again this year a full range of ideas for furnishing and decorating various types of home interiors, the Chicago Tribune is conducting its Fourth Annual Better Rooms Competition, offering \$25,000.00 in 145 cash awards for the best ideas submitted.

Just as the Chicago Tribune's competitions in 1947, 1948 and 1949 brought out a wealth of fresh and interesting ideas in this field of high popular interest, so the 1950 competition has been designed to set new standards in home interior fashions.

Here is your opportunity to plan one or more typical rooms just the way you would like them to be. And here is your chance to win cash and nation-wide recognition for your efforts.

After the prize winners have been chosen, the Tribune, just as it has in previous years, intends to reproduce the winning ideas, or adaptations of them, in full color in the Chicago Sunday Tribune.

Everyone is eligible to compete, except employes of the Chicago Tribune and subsidiaries, members of

their families, and of the Jury of Awards, which, as in the past, will be composed of recognized authorities of high standing in the field of home furnishing and interior decoration.

For complete information to help you prepare your entry, send today for your free copy of the rules which will be sent to you postpaid. The closing time is February 20, 1950. So don't delay. Fill in the coupon below, paste it on a postcard, and mail today.

**FILL IN AND MAIL TODAY!**

**BETTER ROOMS COMPETITION**

Chicago Tribune,  
Tribune Tower, 435 N. Michigan Ave.  
Chicago 11, Illinois AR

*Without cost or obligation to me, please send by postpaid mail to me at the address below complete details and rules of the \$25,000.00 Chicago Tribune Fourth Annual Better Rooms Competition.*

My Name.....

Address.....

City.....State.....Zone Number (if any).....

(Please PRINT plainly in pencil; ink may blot)

## See this beautiful siding

### at the NAHB show

From February 19 through 23, at the N.A.H.B. Show in Chicago, you'll see the *beauty* of Kaiser Aluminum Siding...how easily it's applied...and all these other advantages:

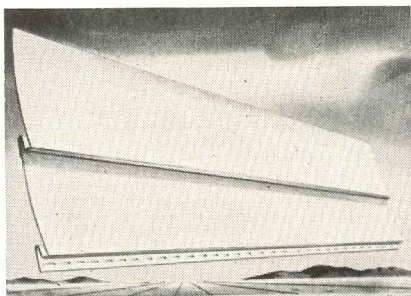

**FLAWLESS BEAUTY** and quality, free of splits, knots or sawing scars. Baked-on paint finish that can't chip, crack or peel. Strong, dent-resistant aluminum that can't rot, warp, crack or rust, that's fire-resistant, that can't be damaged by termites.

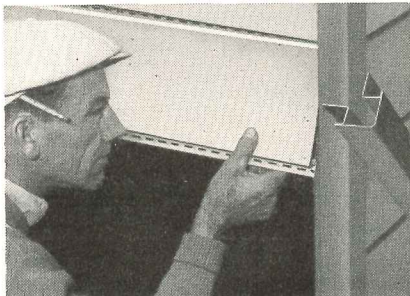

**EXCLUSIVE CURVED SURFACE** installed under tension to make rigid, sound-resistant insulating siding, weather-proof joints, beautiful shadow lines without wrinkles. And construction costs are *low!* Meets FHA requirements for new construction. Write today for free AIA File!

Kaiser Aluminum Siding is produced by Kaiser Aluminum & Chemical Corporation.

# Kaiser Aluminum SIDING

Sold by Kaiser Aluminum & Chemical Sales, Inc.  
Kaiser Building, Oakland 12, California

## PRODUCTS

(Continued from page 166)

removed by turning a single nut, the element is rinsed clean in tap water, and the assembly replaced. Connections are for 1/2-in. standard pipe lines. Oscar Fisher Co., Inc., 109 Worth St., New York 13, N. Y.

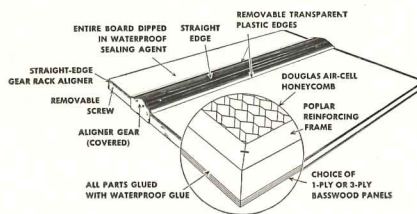

Drawing board has new construction

### Lightweight Drawing Boards

The *Featherweight* drawing board employs a honeycomb or air-cell type of core to produce lightness and ease of handling. The core is held by a poplar reinforcing frame, and covered with top and bottom plywood panels with the grain running in different directions for strength. There is a choice of 1- or 3-ply basswood panels. All parts are joined with waterproof glue, and the entire board is dipped in a waterproofing agent for warp resistance. Boards are made in sizes from 12 by 17 to 31 by 42 in., and are optionally equipped with a straight-edge gear-rack aligner, transparent plastic straight edges or a washable carrying case. Cal-Pan Corp., 1111 S. Fremont Ave., Alhambra, Calif.

### Exhaust Ventilator

The *Gyra-Flo Exhauster* was designed for roof ventilation requiring low operating noise levels. A minimum of noise is reportedly achieved through careful design to control the flow of air, low wheel-tip speeds, rigid reinforcing and wheels balanced to prevent vibration. Rubber is used to float the base.

The exhausters are shipped fully assembled, complete with motor, drive assembly, frame, housing and safety switch. Free air deliveries range from 680 to 38,000 cfm. The steel plate unit is made in 17 throat sizes, from 12 to 68 in. The overall height is from 31 1/4 to

(Continued on page 170)

## See this new kind of screening

### at the NAHB show

From February 19 through 23, at the N.A.H.B. Show in Chicago, you'll see how Kaiser Aluminum Shade Screening keeps sunniest rooms as much as 15° cooler!

You'll see how the thin louvers — set at an angle against the sun — block the sun's rays, *without blocking the view.*

You'll see for yourself why Kaiser Aluminum Shade Screening is one of the fastest selling building supply items ever introduced!

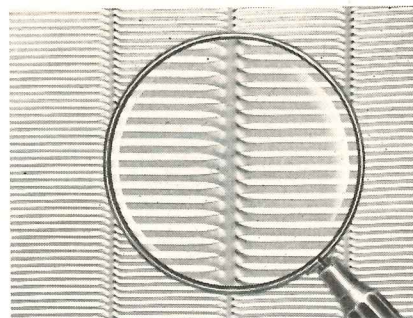

**MADE OF TOUGH**, high grade Kaiser Aluminum. Can't rust or stain. Never needs paint. Adds extra beauty to any window.

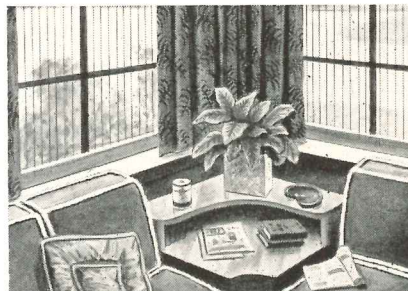

**PROTECTS INTERIORS** against sun. Keeps out insects. Easily installed. Low in cost. Available from sash and screen manufacturers and building materials jobbers. Write today for free AIA File!

Kaiser Aluminum Shade Screening is produced by Kaiser Aluminum & Chemical Corporation.

# Kaiser Aluminum SHADE SCREENING

Sold by Kaiser Aluminum & Chemical Sales, Inc.  
Kaiser Building, Oakland 12, California

"the best seat  
in the

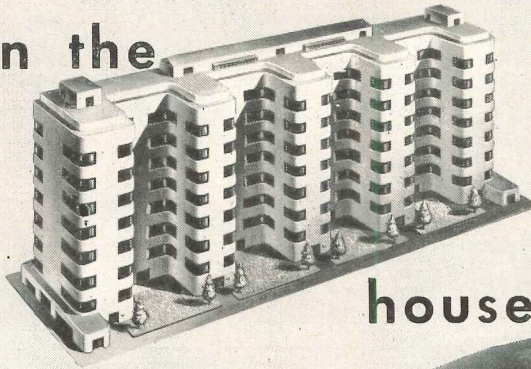

house"

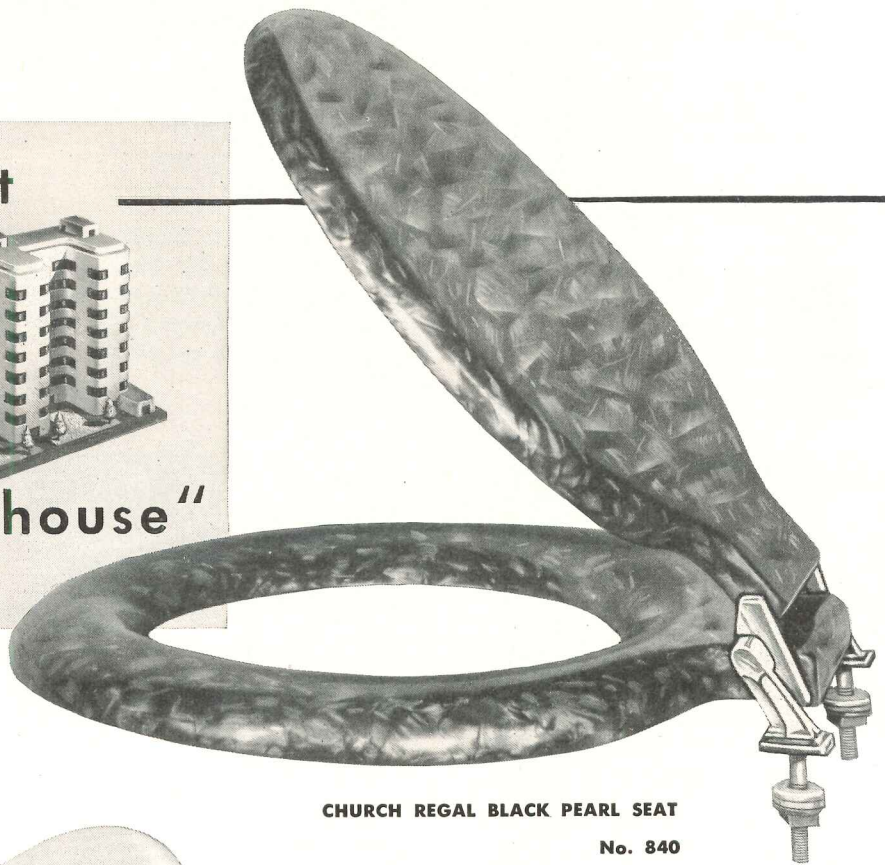

CHURCH REGAL BLACK PEARL SEAT

No. 840

Architects welcome the wide range of Church Seat models: whatever the demands of use, or decoration there is a Church Seat to fit the situation.

And architects' clients welcome the assurance of Church quality. They know that whatever the model . . . whatever the price . . . Church Seats *cost less per year of service.*

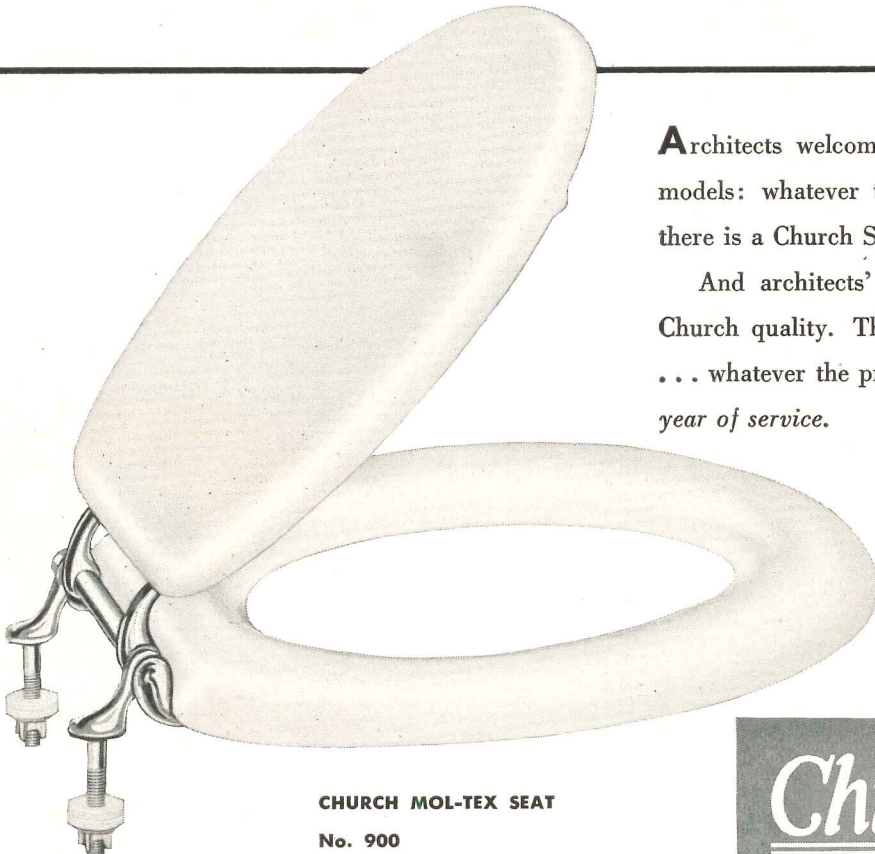

CHURCH MOL-TEX SEAT

No. 900

**Church Seats**

C. F. CHURCH MFG. CO. HOLYOKE, MASS.

Division of AMERICAN RADIATOR & Standard Sanitary CORPORATION

*Serving home and industry*

AMERICAN-STANDARD • AMERICAN BLOWER • CHURCH SEATS • DETROIT LUBRICATOR • KEWANEE BOILERS • ROSS HEATER • TONAWANDA IRON

## CANNON ANNUNCIATORS for CAFES RESTAURANTS

SAVE TIME AND MONEY



Entrance to Bob's Drive-in Restaurant in Eagle Rock, California, Type M-20 (20 number) with Chime. Cannon Annunciator over door is plainly visible to waitresses to indicate waiting orders.



Arrow points to Type RC-20J Single Pole Toggle Switch Control Unit, with Jewel Bull's-Eye Lights and Chime Ringing Buttons operated by chef as order is ready. Waitress turns off switch as she picks up order, clearing lighted numbers from annunciator.

Address Cannon Electric Development Co., Division of Cannon Manufacturing Corporation, 3209 Humboldt St., Los Angeles 31, Calif. Canadian offices and plant: Toronto, Ontario. World Export: Frazer & Hansen, San Francisco.

CANNON  ELECTRIC

## ARCHITECTURAL ENGINEERING

TECHNICAL NEWS AND RESEARCH

### PRODUCTS

(Continued from page 168)

64 $\frac{3}{8}$  in. The cover is hinged, and the housing, motor, and fan wheel can be removed without disturbing the rest of the unit. Chicago Blower Corp., 4558 W. Congress St., Chicago, Ill.

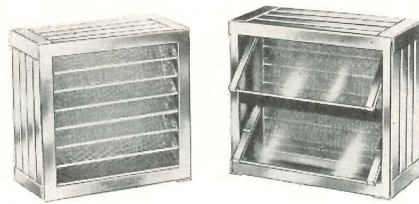

Block unit allows controlled ventilation

#### Ventilator for Glass Block

Weather-Bloc, a ventilating unit the same size as glass block, controls air with two heavy glass louvers which turn on pivots to any desired degree. A fine mesh wire screen inside the unit is said to retard rain, snow, dirt and to keep out insects. The outside is similar in appearance to glass block, with a series of horizontal obscure glass diffusers. The body is of stainless steel reinforced and ribbed to retain and adhere to mortar. No special preparation for installation is necessary.

The glass diffusers are removable and all parts can be cleaned or replaced from the inside of the room. Air Rectifiers, Inc., 3734 Southport Ave., Chicago 13, Ill.

#### Glass Cylinders

A line of stock sizes in glass cylinders is now available, in diameters from 1 $\frac{1}{4}$  to 8 $\frac{3}{4}$  in. and in lengths up to 18 in. Mass production is said to enable speedy and economical supply in any quantity. The uses recommended are decorative columns, lighting fixtures, visible hoppers, displays, dispensers, furniture and signs. The stock cylinders are of lime crystal glass with wall thickness of approximately  $\frac{3}{32}$  in. for diameters up to 4 in. and length to 5 in.; larger sizes will be approximately  $\frac{1}{8}$  in. or more thick. Ends are finished ground, ground and beveled, or burn-off (beaded edge). Dunbar Glass Corp., Dunbar, W. Va.

(Continued on page 172)

# Slash Power Costs!!

WITH

# TODD BURNERS

-GAS OR OIL

You'll be amazed how Todd Burners cut your fuel and maintenance costs. Savings up to 10% . . . increased power capacity can be yours with Todd Burners. In replacement of obsolete equipment or in new installations, skilled specialists—backed by 35 years of Todd experience—engineer your job individually to assure you utmost economy in burning of liquid or gaseous fuels.

Oil Burners

Gas Burners

Combination

Oil and Gas  
Burners

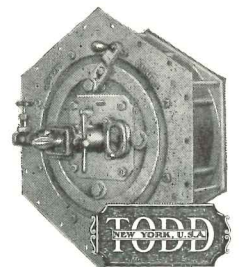

COMBUSTION EQUIPMENT DIVISION

TODD SHIPYARDS CORPORATION

81-16 45th Ave., Elmhurst, Queens, N. Y.

NEW YORK • BROOKLYN • ROCHESTER  
BUFFALO • HOBOKEN • NEWARK • PHILADELPHIA  
HARRISBURG • YORK • CHICAGO • CHARLESTON,  
S. C. • BOSTON • SPRINGFIELD, MASS.  
BALTIMORE • WASHINGTON • RICHMOND, VA.  
ATLANTA • DETROIT • GRAND RAPIDS • TAMPA  
GALVESTON • HOUSTON • MOBILE • NEW  
ORLEANS • LOS ANGELES • SAN FRANCISCO  
SEATTLE • MONTREAL • TORONTO  
BARRANQUILLA • BUENOS AIRES • LONDON



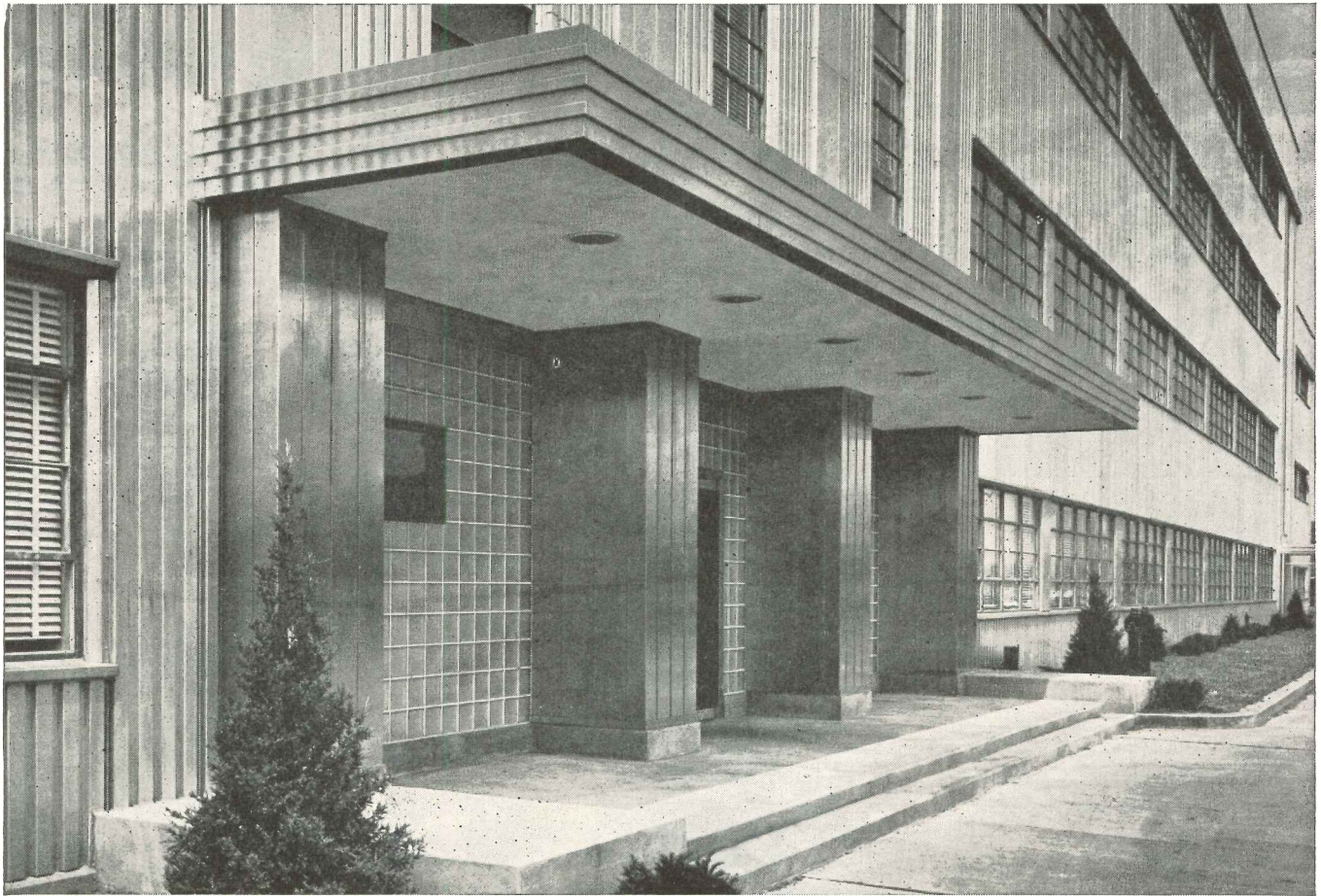

*Stone and Webster Engineering Co., Boston—Architects and Builders  
Allegheny Metal wall panels fabricated by H. H. Robertson Co., Pittsburgh*



## strikes the modern stainless note with **ALLEGHENY METAL**

**For certified data on  
individual grades of  
Stainless Steel, use**

**ALLEGHENY LUDLUM  
BLUE SHEETS**

There is a Blue Sheet for each individual grade of Allegheny Metal, giving full information on its physical and chemical properties and characteristics. Let us send you this certified, laboratory-proved data on the stainless grades in which you are interested.

**ADDRESS  
DEPT. AR-1**

The 4-story, 460-foot long office building that fronts GE's new turbine plant in Schenectady is an architectural first. The walls are 3-inch thick insulated stainless steel panels instead of the usual masonry . . . and no departure from old, time-worn methods was ever better justified.

Beside the obvious advantages of lustrous beauty and lifetime resistance to atmospheric corrosion, the use of stainless walls meant increased floor space, speedier construction, lower erection costs, and big savings in maintenance and depreciation costs. Insulating qualities were superior to a 12" plastered masonry wall. Weight was so much less that four stories could be placed on structural steel and foundations designed originally for three floors in masonry. Cold-weather construction problems were eliminated, and working conditions were safer and cleaner due to the virtual elimination of material elevators, scaffolding and forms.

Where can you use Allegheny Metal to similar advantage? Let our Technical Staff help you.

**ALLEGHENY  
LUDLUM**  
STEEL CORPORATION  
Pittsburgh, Pa.

*Nation's Leading Producer  
of Stainless Steels  
in All Forms*



W&D 2764

**ALLEGHENY METAL is stocked by all  
Joseph T. Ryerson & Son, Inc. warehouses**

**PRODUCTS**

(Continued from page 170)

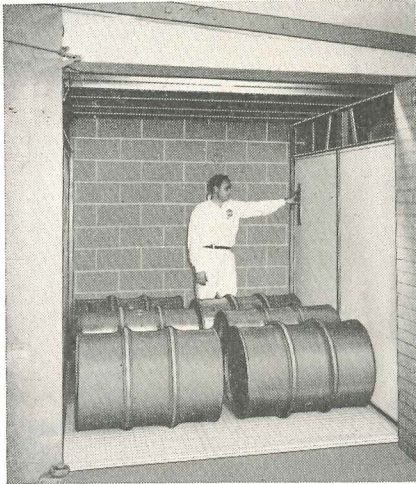

**BETTER  
INDUSTRIAL  
ELEVATORS**

Give your clients the most value, the most advantages by specifying Globe Industrial Elevators for plants and warehouses.



Low initial cost, simplified installation. Low maintenance, oil hydraulic operation. Advanced safety features. Hold-down or automatic push-button control. Rugged construction for heavy loads. No penthouse or load bearing walls required. Countless superior features assure client satisfaction. Mail coupon for specifications and complete details, now.

Estimates or suggestions furnished on any industrial lifting problem by Globe's Lifting Engineers. No obligation.

**MAIL COUPON  
TODAY**



**GLOBE HOIST COMPANY**  
1000 E. Mermaid Lane  
Philadelphia 18, Pa.

Please send Bulletin A150 showing illustrations, specifications on Oil Lift Freight Elevators, Side-walk Elevators, Lifting Platforms and Ramps.

Company.....

Name.....Title.....

Street.....City.....State.....

**GLOBE HOIST COMPANY**  
Des Moines 6, Iowa Philadelphia 18, Pa.

**Fireproof Ceiling**

The problem of providing a light-weight fireproof ceiling to comply with fire codes was solved in the recently constructed Brooks Recreation Center, Raleigh, N. C., by the use of aluminum extruded "T" sections and spun glass block.

The wide steel spans in the 209 by 243 ft building were originally left bare. Building inspectors asked for 2-in. thick concrete ceiling, which was considered prohibitive as to cost and excessive weight on the supporting members. The ceiling finally adopted is said to meet all requirements plus affording an acoustic surface. Dropped from the overhead roof-supporting members, 14-gage wires were inserted in hand punched holes in  $\frac{7}{8}$  by 2 in. aluminum "T" sections. These "T's" were hung in one direction only, on 24-in. centers and braced laterally by cross rods at 3 ft intervals. Spun glass blocks, 2 by 4 ft and  $\frac{1}{2}$  in. thick, were first spray-painted, then laid on the flanges of the suspended "T's" to form the finished ceiling. Reynolds Metals Co., 2500 S. Third St., Louisville, Ky.

**Glazing Compound for  
Aluminum Sash**

The new *D-P No. 1012* aluminum gray glazing compound, made for aluminum sash, is said to stick tightly to the metal. The material reportedly sets up quickly, but remains semi-plastic to withstand movement of the sash. The manufacturers further claim that the compound will not crack, chip or powder; won't creep, sag or pull away; and withstands moisture, heat and cold. The Dicks-Pontius Co., Dayton, Ohio.

**Flush Overhead Garage Doors**

A line of flush, paneled, sectional garage doors has been added to the *Wedge Tight* line. An internal framework of wood is covered on both sides with external grade, waterproof plywood, giving unbroken flush surfaces. Common stock sizes are carried, with others to order by sketch or specification. Any glass or trim arrangement desired can be furnished. The doors are supplied complete with hardware. Calder Mfg. Co., 630 N. Prince St., Lancaster, Penna.

(Continued on page 174)

**Designed To  
Stay Cleaner,  
Last Longer!**



**MODEL LP-20**—Durable solid plastic. Open front and back design cuts upkeep to a minimum, gives better sanitation. Self-raising hinge assures cleanliness.

**MODEL 50**—Durable solid plastic. Equipped with self-sustaining hinge which holds seat in whatever position it is raised, eliminating fixture breakage from slamming or kicking.



**SPERZEL**  
123 14th Avenue South  
Minneapolis, Minnesota  
All Sperzel Seats Fit Standard Bowls



WRITE NOW for details on models illustrated as well as the complete line of quality Sperzel seats. Dept. AR



Reg. U.S. Pat. Off.

**MEDUSA  
WATERPROOFED GRAY  
PORTLAND CEMENT**

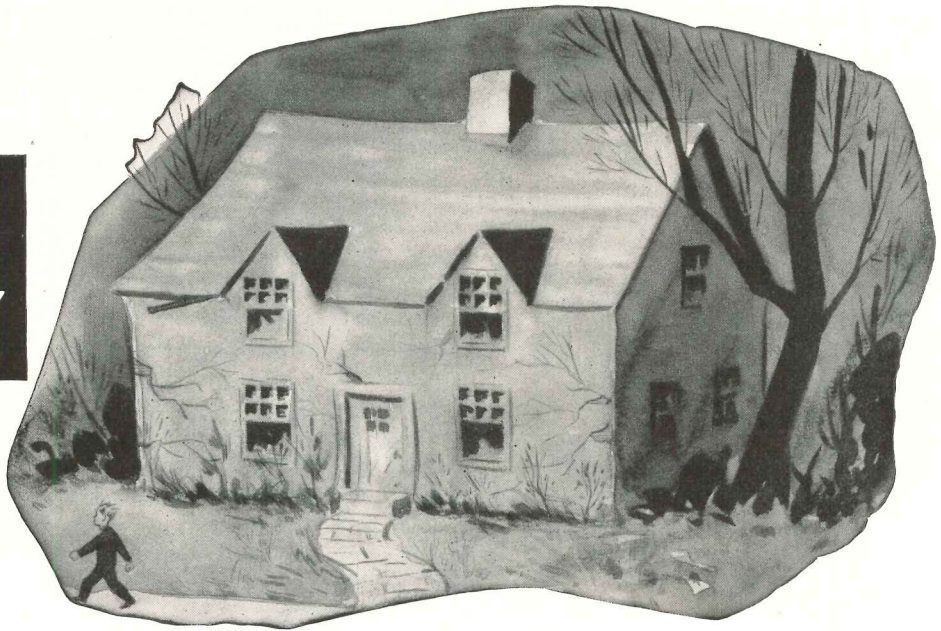

## *Are You Designing* **HAUNTED HOUSES?**

We're not talking about designing houses haunted by spirits, but we are talking about those houses that are haunted by the possibilities of water damage for the lifetime of the building! There are thousands of home owners haunted by leaky basements they can't make dry without tremendous expense . . . unnumbered others haunted by wall dampness that makes their homes unhealthy places to live . . . and still others by the unsightly stains marring their otherwise beautiful stucco homes!

Give your clients lasting protection from water damage by specifying Medusa

Waterproofed Gray Portland Cement\* . . . the cement with actual water-repellent qualities. Medusa Waterproofed Gray affords complete protection against water for all exposed concrete and mortar . . . foundations and basements . . . stucco. Stearates line the pores of concrete and mortar . . . preventing the absorption of moisture.

Hundreds of architects for over 30 years have given their clients peace of mind by designing lastingly dry construction with Medusa Waterproofed Gray. For further information on how to waterproof, mail coupon.

\*When not available, use Medusa Waterproofing Powder or Paste.

FIFTY-EIGHT YEARS OF CONCRETE PROGRESS

**MAIL THIS COUPON NOW!**

**MEDUSA  
"JOB-FITTED"  
CEMENTS**

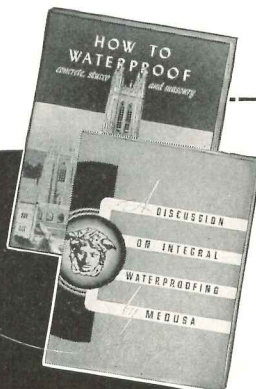

**MEDUSA**

**PORTLAND CEMENT COMPANY**

1015-6 Midland Building • Cleveland 15, Ohio

Gentlemen: Please send me copies of the free booklets, "How to Waterproof Concrete, Stucco, and Masonry" and "A Discussion on Integral Waterproofing."

Name .....

Address .....

City ..... State .....

PRODUCTS

(Continued from page 172)

Fluorescent Lighting

Two new fluorescent lamps are said to bring out the "full beauty" of all colors and to be complimentary to complexions. The lamps, called *De Luxe Cool White* and *De Luxe Warm White*, have an inner coating of a recently developed DR (means deep red) phosphor powder, which lowers light-efficiency slightly, but improves color rendition. The Cool White lamp is said to create a cool, crisp atmosphere and the best color impression. The Warm White lamp is claimed to give an effect similar to filament lighting, and to have improved color rendition. The lights will be available in 40-watt size early in 1950. Other sizes will become available in succeeding months. General Electric Lamp Dept., Nela Park, Cleveland 12, Ohio.

Glycol Vaporizing Unit

*Germatrol* is a new unit for vaporizing triethylene glycol, an agent found effective in killing air-borne bacteria. The vapors are said to be odorless, colorless, tasteless and non-toxic, yet as little as one part of glycol in 400 million parts of air are reported to control bacteria.

The unit is designed to be connected into the ducts used in any modern air conditioning or heating system. It comes in three standard sizes, or is custom-built to individual specifications. Its use is recommended in public buildings, churches, schools, theaters, offices, hospitals, stores and wherever there is a potential breeding ground for infection or the common cold. *Germatrol* Corp., 622 Brookline Blvd., Pittsburgh, Pa.

Circline Lamp Starter

A starter especially designed for use with the 32-watt Circline fluorescent lamp is now on the market. The new switch, known as the *FS-12*, is said to be especially effective in providing adequate preheating and fast starting. The manufacturers state that it is sturdily built, will absorb much punishment from a failed lamp and has long life. The starter carries the Underwriters' seal of approval. Packaging quantities are 100 switches in cartons of 10 units each. Sylvania Electric Products, Inc., 500 Fifth Ave., New York 18, N. Y.

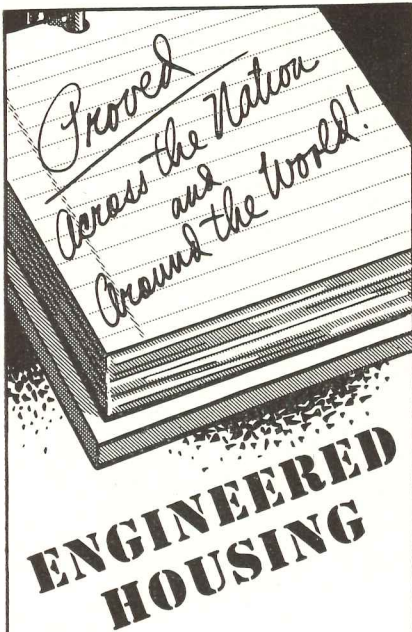

Proved by projects from New Jersey to Oregon, New Mexico to Kansas... Saudi Arabia, Australia, China, Mexico...

At Texas Housing Company we engineer your plans and tailor-fit them into mass production and your timetable. One house or a townfull!

For

- ★ COMMUNITY
- ★ INDUSTRIAL
- ★ SPECIALIZED NEEDS

No matter what you require, pre-cut and panelized homes, engineered from foundation to ridge-pole, save time and money. Engineered Houses:

- Architecturally Correct
- Designed for Economy
- Cut Erection Costs
- Made for Comfortable Living

Call, wire or write, for our booklet, **ENGINEERED HOUSES**, for full details!

TEXAS HOUSING CO.



9001 DENTON DR. • PHONE D4-2601  
DALLAS, TEXAS

PROTECT LIVES  
AND PROFITS!

SPECIFY...



MODEL 10EL  
10,000 WATTS

Onan Emergency Electric Plants provide power for all essential needs...

LIGHTS • REFRIGERATION • VENTILATING SYSTEMS • COMMUNICATIONS • OIL BURNERS • STOKERS • ELEVATORS

\* When storms, floods or breakdowns interrupt commercial power, Onan Standby Plants start automatically and take over the power load within seconds, stop when power is restored. Operating and maintenance costs are negligible. Widely used in hospitals and other institutions, radio stations, hacheries, theaters, industrial plants... wherever power interruptions would be dangerous and costly. Available from 1000 to 35,000 watts.

What size Standby Plant will your project need?



Send coupon below for folder on Onan Standby Plants. It will help you specify the right size plant and the necessary accessories. If you have an unusual problem write our engineering department.

**D. W. ONAN & SONS INC.**  
5141 Royalston Ave., Minneapolis 5, Minn.

Please send me your Standby Folder

Name.....

Address.....

City.....State.....

**ONAN STANDBY POWER**

# CRANE

*the preferred plumbing*

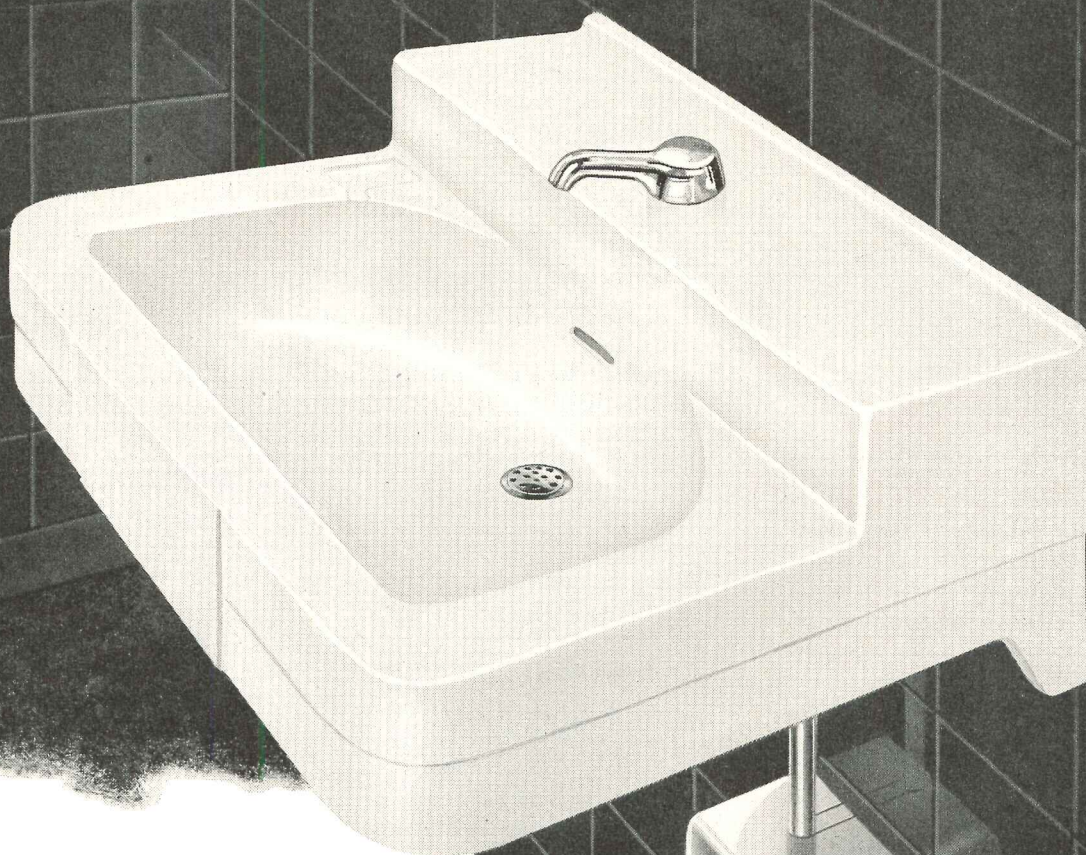

**CRANE YORKSHIRE LAVATORY  
WITH PEDAL VALVE**

The Crane *Yorkshire* Lavatory, with foot pedal valve. Promotes cleanliness in factory, office, public building. Consult your Crane Branch or Crane Wholesaler.



# CRANE

CRANE CO., GENERAL OFFICES:  
836 S. MICHIGAN AVE., CHICAGO 5  
PLUMBING AND HEATING  
VALVES • FITTINGS • PIPE

GET  
**Lowest  
Power  
Costs!!**

INSIST ON

**TODD  
BURNERS**

**-GAS OR OIL**

Whether you burn gas, oil or a combination, you'll be amazed how Todd Burners cut your fuel and maintenance costs . . . give you savings up to 10%, increased power capacity. For utmost economy in your boiler plant—let skilled Todd specialists, backed by 35 years of Todd experience, engineer your replacement of obsolete equipment or new installations.

Oil Burners  
Gas Burners  
Combination  
Oil and Gas  
Burners

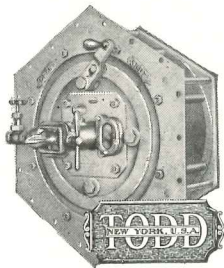

**COMBUSTION EQUIPMENT DIVISION  
TODD SHIPYARDS CORPORATION**

81-16 45th Ave., Elmhurst, Queens, N. Y.

NEW YORK • BROOKLYN • ROCHESTER  
BUFFALO • HOBOKEN • NEWARK • PHILADELPHIA  
HARRISBURG • YORK • PITTSBURGH • CHICAGO  
RALEIGH • CHARLESTON, S. C. • BOSTON • SPRING-  
FIELD, MASS. • BALTIMORE • WASHINGTON  
RICHMOND, VA. • ATLANTA • BIRMINGHAM  
DETROIT • GRAND RAPIDS • TAMPA • GALVESTON  
SAN ANTONIO • DALLAS • HOUSTON • TULSA  
MOBILE • NEW ORLEANS • SHREVEPORT  
DENVER • SALT LAKE CITY • LOS ANGELES • SAN  
FRANCISCO • SEATTLE • MONTREAL • TORONTO  
BARRANQUILLA • BUENOS AIRES • LONDON

**ARCHITECTURAL  
ENGINEERING**

TECHNICAL NEWS AND RESEARCH

**LITERATURE**

(Continued from page 134)

**Plastic Signs**

*Plexiglas, The Outdoor Plastic For Signs.* Booklet pictures in color some 30 examples of outdoor sign installations, and shows a variety of colors and lighting treatments achieved with the plastic. Illustrated uses range from small formed letters to store fronts. Properties of the material and ranges of forms, sizes and thicknesses are listed. 20 pp., illus. Rohm & Haas Co., Plastics Dept., Washington Square, Philadelphia 5, Penn.\*

**Plumbing Fixtures**

*Kohler Plumbing Fixtures For Industrial Plants, Public Buildings, Clubs, Schools.* Catalog is divided into sections each featuring one type of enameled or vitreous china fixture, and gives name, number, description, size and fittings. The sections include: lavatories, wash sinks, closets, closet seats, urinals, kitchen sinks, service sinks, drinking fountains and brass fittings. 24 pp., illus. Kohler Co., Kohler, Wis.

**Architectural Mouldings**

*Construction Details and Selector Guide: Alumiline Store Fronts, Extrud-A-Line Entrances & Hollow Metal Doors.* Shows full size construction details of various metal mouldings and assemblies. Among the items covered are: sash and door members, cornice mouldings, awning bar flaps, pilaster covering, fascia fillers, and miscellaneous store front mouldings. A few of the members are shown in renderings. 20 pp., illus. The Alumiline Corp., 166 Remsen St., Brooklyn 2, N. Y.\*

**Fabric Designs**

*Schiffer Prints: Stimulus Fabrics (Catalogs 1 and 2).* Each folder pictures 15 hand printed fabrics designed by Bernard Rudofsky, Edward J. Wormley, George Nelson, Abel Sorenson, Salvador Dali, and Ray Eames. Descriptions and color combinations available are included. Catalog No. 1 shows designs available through architects and decorators, those in No. 2 through retail stores. 4 pp., 4 pp., illus. Schiffer Prints Div., Mil-Art Co., Inc., 79 Madison Ave., New York, N. Y.

(Continued on page 178)

**QUALITY  
LOCKS**

from **ADAMS-RITE**

**THE ORIGINAL  
RITE-LOCK**

for

**SLIDING DOORS**

Single assembly easily installed by simple cut-out, even in narrow stiles. No mortising. 3 types fit doors 1½" — 2" thickness, with a ¾" wardrobe type. Thumb button emergency, 5-pin tumbler cylinder or latch type may be had interchangeably. Exterior parts solid brass. Escutcheons measure 4½" x 2½".

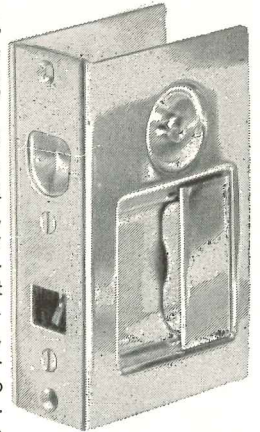

**MINIMUM BACKSET DEADLOCKS  
FOR STANDARD CYLINDERS**

Can Be Keyed to Any Job

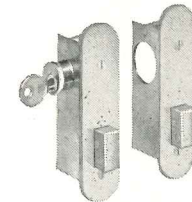

For narrowest extruded aluminum, structural steel and wood stiles. Series 970 Deadlocks for standard cylinders have 1/16" backset, 1/16" depth. Fifteen other standard backsets to 1 3/4". Series 980 identical except for 3/4" dia. pin tumbler cylinder and 1/16" backset. Rugged steel and brass construction, armored bolt with 3/8" throw, bronze or aluminum face and strike. Radius, flat and bevelled faces interchangeable.

**TEMPERED GLASS DOOR  
DEADLOCK**

Takes the place of 2 locks. Has single or double bolts and 1 or 2 cylinders. Handle operates bolts in sequence, cylinder locks handle. Designed for and can be installed in any tempered glass door top or bottom channel. 4 sizes: 1-15/16" High x 1-13/32" Wide.



**CYLINDER SLIDING DOOR  
LOCK**

Operates by cylinder from one or both sides. Fits all standard cylinders with adapter cams furnished, (specify when using Yale or Sargent cylinder). Solid bronze face, strike & bolt. Heat treated aluminum alloy case. Use your own cylinders and trim. Also used as jimmy-proof lock.

Also — Adams-Rite Solid Brass Sliding Door Flush and Edge Pulls, Surface and Jamb Bolts and Ball Latches



# CHEAPER IN THE LONG RUN

*...the Sheet Metal with HIGH Rust-Resistance*

Despite the fact that Toncan Iron may be a little higher in price than common ferrous materials frequently used for the same type of work . . . it is cheaper in the long run both for client and sheet metal contractor.

WHY? . . . To quote the men who use it, ". . . because Toncan Iron *works easier* on the bench . . . has no hard spots . . . doesn't flake. It lasts longer . . . scores of our jobs have stood up twenty years and more. It is a *better buy* for our customers."

Not a steel—and not merely a copper-bearing iron—Toncan Iron is the only sheet metal combining refined open hearth iron with twice as much copper as copper-bearing steels and irons, plus molybdenum in the right proportion to bring out the full effectiveness of the copper. See Sweet's Architectural File or write for full information.

**REPUBLIC STEEL CORPORATION**  
 GENERAL OFFICES • CLEVELAND 1, OHIO  
 Export Department: Chrysler Building, New York 17, N. Y.

for **40** years . . . HIGHEST RUST-RESISTANCE  
 OF ALL FERROUS MATERIALS IN ITS PRICE CLASS



*Here's the story*

**COPPER-BEARING STEEL**

Open hearth steel + Copper = Ordinary copper-bearing sheets

---

**TONCAN IRON**

Open hearth iron + Molybdenum in proper proportion + Twice as much copper = TONCAN IRON SHEETS, most rust-resistant ferrous sheets in their price class!

TONCAN  
 26% COPPER  
 IRON  
 REPUBLIC STEEL CORP.  
 CLEVELAND, OHIO



*Republic*  
**TONCAN COPPER MOLYBDENUM IRON**

— for ducts, gutters, conductor pipes, roofing, siding, tanks, ventilators, skylights, hoods and other sheet metal applications requiring rust-resistance — and for corrugated metal drainage products.

# LOW-COST HOME COOLING IS HERE!

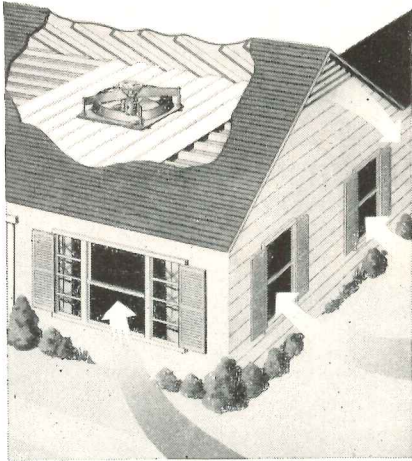

**Easily installed attic unit gives cool comfort in hottest weather**

No investment can give home owners as much comfort and pleasure as a Hunter Attic Fan. This modern convenience is now being used in thousands of houses and apartments throughout the nation. Low in initial cost and with no upkeep expense, the Hunter Attic Fan is practical for homes in all price ranges.

Installation of Hunter's new, compact package fan is simple and inexpensive. Fan, motor, suction box and shutter are all in one unit that requires only a ceiling opening in hallway and 17" clearance in attic. Four models, ranging from 4700 CFM to 9500 CFM, to fit any home size and climate. Quiet, powerful, dependable. Manufactured by Hunter, exclusive fan makers for 64 years.



Hunter Fan and Ventilating Company  
396 South Front Street,  
Memphis, Tenn.

Send copy of "How to Cool for Comfort" to

Name \_\_\_\_\_

Address \_\_\_\_\_

City & State \_\_\_\_\_

# Hunter Package Attic Fans

## ARCHITECTURAL ENGINEERING

TECHNICAL NEWS AND RESEARCH

### LITERATURE

(Continued from page 176)

#### Lighting Fixtures

*Multi Lighting Fixtures Are Star Performers Also (Bulletin S).* Describes a line of lighting fixtures for gymnasiums and swimming pools. Sketches, size and weight tables, and light distribution curves are given for various models. An underwater floodlight detail is also included. 4 pp., illus. Multi Electrical Mfg. Co., 4223-43 W. Lake St., Chicago 24, Ill.

#### Steel Storage Equipment

*How Red Tiger Will Help You (Catalog No. 110).* Illustrates and describes steel equipment for storage, materials handling, inventory control and transfer. Office equipment is included. Construction details and prices are noted. 8 pp., illus. Red Tiger Products, Inc., 20 N. Wacker Drive, Chicago 6, Ill.

### LITERATURE REQUESTED

The following individuals and firms request manufacturers' literature:

Erling G. Dollar, A.I.A., 1011 Washington St., Wilmington, Del.

Jorge Villegas Duncan, Ingeniero, Casilla 1952, Santiago, Chile.

Joseph A. Habarta, Student Architect, The Shawinigan Engineering Co., Ltd., Shawinigan Building, 600 Dorchester St. West, Montreal 2, Canada.

Lester Triem Haldeman, Consulting Engineer, 5000 Lancaster Ave., Philadelphia 31, Pa.

Harder and Droste, Designers, 21-3 Nott Drive, Troy, N. Y.

Philip H. Jagger, Student Architect, The Shawinigan Engineering Co. Ltd., Shawinigan Building, 600 Dorchester St. West, Montreal 2, Canada.

McMahon Engineering Company, 347 S. Washington St., Green Bay, Wis.

William H. Mitchell, Civil Engineer, 19 Merritt Ave., Braintree 84, Mass.

Peterson and Bartels, Consulting Engineers, 85 Livingston St., Brooklyn 2, N. Y.

James S. Sudler, Architect, 302 Colorado Building, Denver, Colorado.

Tormey and Bowersock, Architects, 2114 N. Charles St., Baltimore 18, Md.

# The RESTORATION of COLONIAL WILLIAMSBURG

*A Reprint  
of the December, 1935*

*Issue of*

ARCHITECTURAL RECORD

*104 pages, bound in cloth*

*\$2.50 per copy*



The Colonial Williamsburg Number of ARCHITECTURAL RECORD — issue of December 1935 — was sold out soon after publication but the entire editorial contents have been reprinted and bound in permanent book form with blue cloth covers.

Many thousands of these Williamsburg reprints have been sold but the demand continues unabated.

ARCHITECTURAL RECORD  
119 W. 40th Street, New York, N. Y.

Enclosed is \$..... for which send..... copies of your reprint, *The Restoration of Colonial Williamsburg*, bound in cloth, at \$2.50 per copy. (Add 2% Sales Tax for New York City deliveries.)

Name.....

Address.....

City and State..... A.R. 1-50



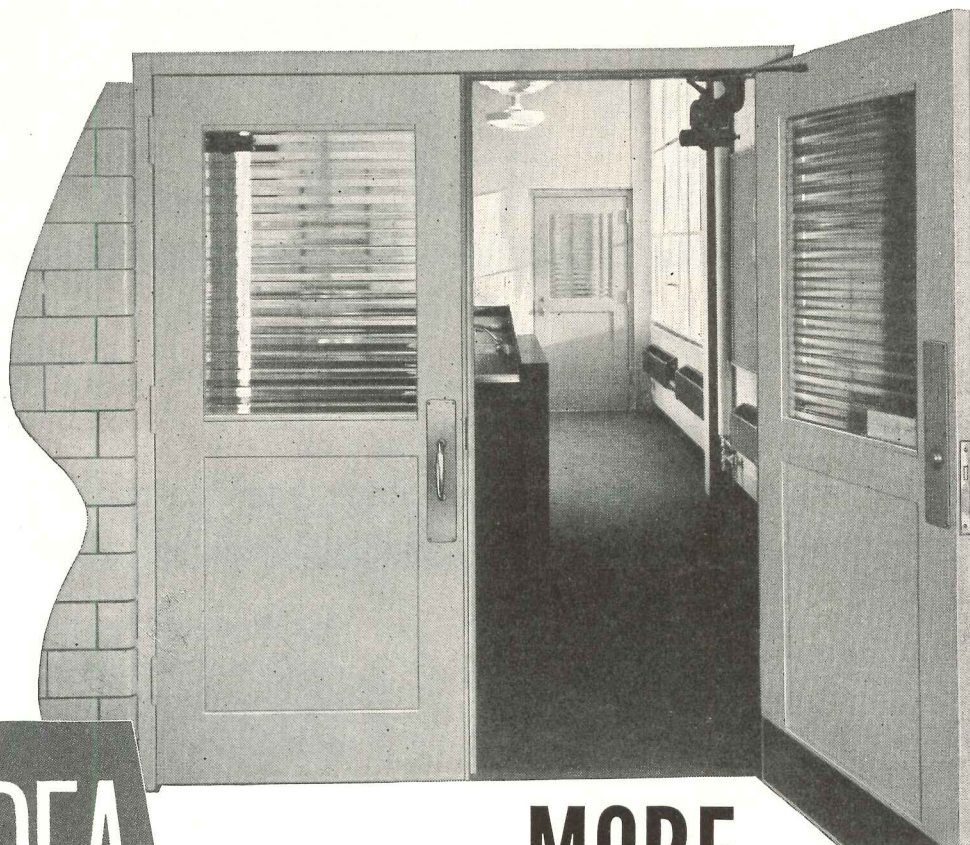

**A NEW IDEA**

**GIVES YOU MORE  
FOR YOUR DOLLAR IN DOORS**

Simplification, as a key to economy, has been given a full ride in Fenestra's latest development in doors.

You know how it has been—swing-in or swing-out, left-hand or right-hand, glass panel or metal—every different use called for a different door. That, or a lot of cutting, mortising and planing.

Fenestra\* has put an end to this with a standard hollow metal door which can fill a number of different requirements—and be installed in a jiffy.

A unique hinge arrangement makes it possible. This enables Fenestra to streamline production by concentration on less types. For you, it means savings which are passed along in lower first cost . . . so low that a comparison with what you have been paying will surprise you. This is

all achieved right along with the use of quality materials and finest workmanship.

**Complete with Frame and Hardware**

Each door arrives on the site with its steel frame, *ready to go in—ready* for application of pre-fitted, quality hardware. Cutting, mortising and drilling are done at the factory. That saves time . . . money.

Fenestra's standardization also aids availability. With one basic type of door filling so many needs, more dealers stock them, ready for immediate use. Choice of standard sizes. Doors with Underwriters' "B" label also available.

Why not look into it today? See your nearest Fenestra representative or mail the coupon.

\*®

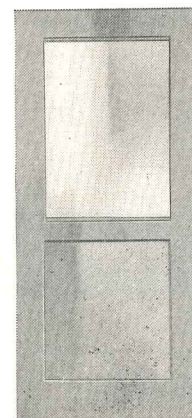

This one door can be used left or right, swing-in or swing-out, with metal or glass panel, with or without muntin. Result: economy production that gives you more door for your dollar.

*Fenestra*

**STANDARDIZED**

**Doors • Windows • Panels**

DETROIT STEEL PRODUCTS COMPANY  
Door Division  
Dept. AR-1, 2252 E. Grand Boulevard  
Detroit 11, Michigan

Please send me, without obligation, information on Fenestra Stock Hollow Metal Doors.

Name \_\_\_\_\_

Company \_\_\_\_\_

Address \_\_\_\_\_

# FIRST IN

---

## FIRST IN COVERAGE OF ARCHITECTS AND ENGINEERS!

Architectural Record reaches more architects and engineers than any other business publication . . . men who control more than 80% of all architect-designed building.

## FIRST IN PREFERENCE AMONG ARCHITECTS AND ENGINEERS!

In survey after survey of architects and engineers, Architectural Record ranks *first* among *all* technical magazines.

## FIRST IN ADVERTISING VOLUME!

More advertisers place more pages of advertising in Architectural Record than in any other publication in this field.

## FIRST IN ARCHITECTS AND ENGINEERS REACHED PER DOLLAR!

Architectural Record delivers more architects and engineers for every advertising dollar you invest than *any other publication*.

# ITS FIELD

The "Pivot Paper" for all building product advertising is Architectural Record. Here's why:

If you want to reach builders, contractors, sub-contractors or owners, there are vertical papers which reach them most economically. If you want to reach architects and engineers, one vertical paper reaches *them* most economically—Architectural Record.

The combination of Architectural Record and leading vertical magazines will give you more effective coverage of all these groups, at less cost per reader, than will *any* horizontal magazine.

For complete details, call or write the nearest Record office.

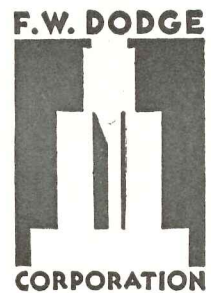

**PUBLISHED BY  
F. W. DODGE  
CORPORATION**

**NEW YORK**  
119 West Fortieth St.  
Pennsylvania 6-1500

**CLEVELAND**  
321 Hanna Building  
Cherry 7256

**CHICAGO**  
700 Merchandise Mart  
Whitehall 4-4400

**LOS ANGELES**  
672 South LaFayette  
Park Square  
Dunkirk 8-2286

**SAN FRANCISCO**  
1003 TWA Building  
Yukon 6-2522

**PORTLAND**  
907 Terminal Sales  
Building  
Atwater 4107

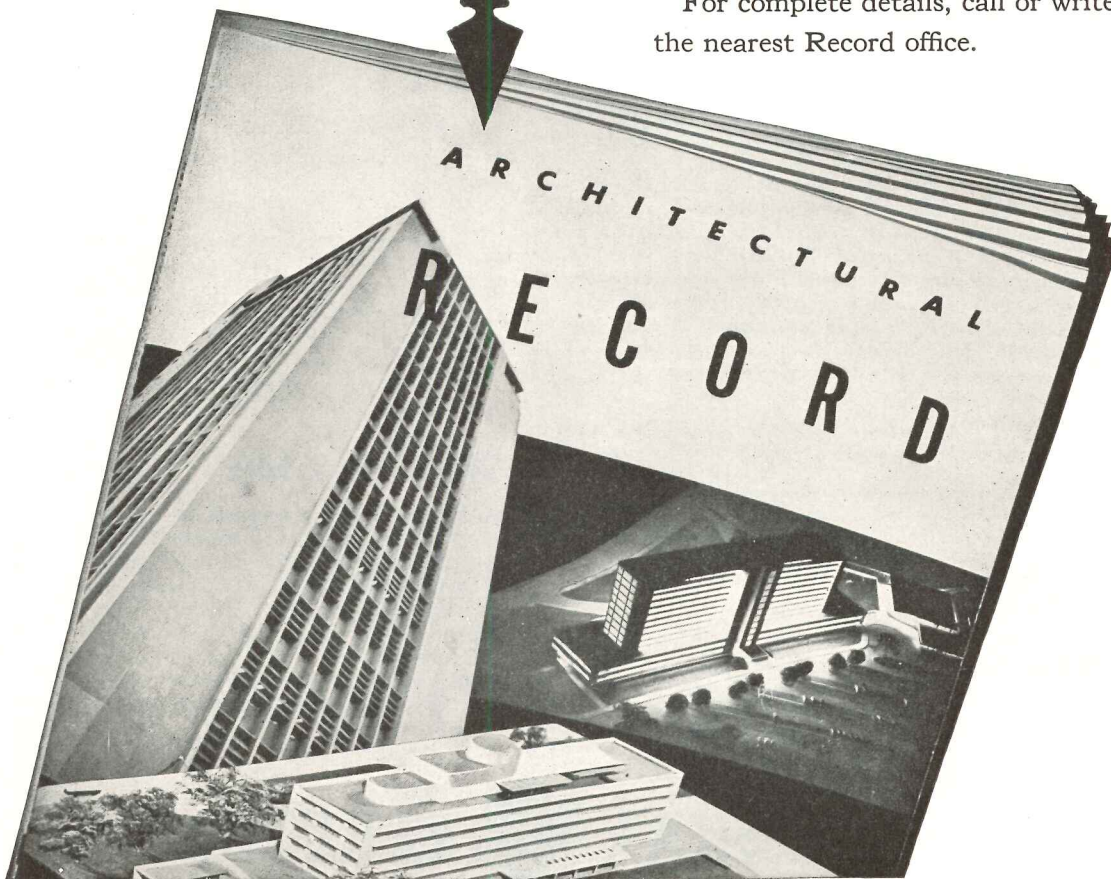



# WIRING NEWS

A PERIODICAL DIGEST OF WIRING IDEAS FROM THE GENERAL ELECTRIC CONSTRUCTION MATERIALS DEPARTMENT



## You Know You're Right With "G-E White"

There's no question about it. You get top wiring protection when you use General Electric white rigid conduit.

### Years of Protection

Carefully controlled in manufacture from raw material to final inspection, G-E White offers the advantages of a uniform, high-quality product. Top-quality steel, hot-dip-galvanized, inside and outside, means years of protection from atmospheric corrosion. Smooth Glyptal® finish adds plus protection, makes wire pulling easy and fast.

### Installation Features

During installation you'll appreciate the uniformity of G-E White. You'll like the way it cuts waste by eliminating flat bends. The electrical contractor will like its sharp, clean threads, too.

For top protection specify General Electric white rigid conduit. And remember General Electric also supplies a complete line of fittings and accessories. For information on conduit, check box (C) in coupon.

## Light Weight Makes Light Work Of Residential Wiring

Light weight . . . small diameter . . . easy stripping. These features make General Electric PVX® nonmetallic-sheathed cable a real time saver in all types of residential work.

### Built to Last

Glass-and-cotton braid resists both moisture and flame. Individual conductors are insulated with a Type T thermoplastic compound and spiral-wrapped with impregnated crushed-paper armor to provide maximum dielectric and mechanical strength. Check PVX at your local G-E distributor's, or check box (D) in the coupon.

## Silence Makes Sales

In homes, stores, plants, offices, and hospitals, the silent General Electric mercury switch is a selling feature hard to beat.

Demonstrate it. Show customers how smooth—how quiet it is. Tell them it stays on the job for more than a million ON-OFF cycles. Yes, you'll find extra "sell," extra quality in General Electric mercury switches. Check box (E) in coupon for complete information.

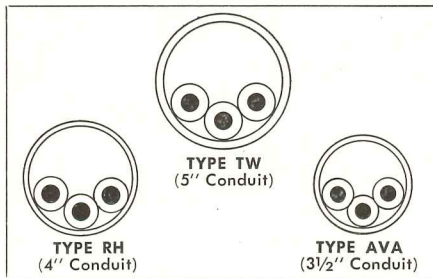

## Dream-home Lighting at Budget-home Cost

Today's prospective home buyers are harder to "sell." They insist on modern planning and conveniences . . . they look for extras . . . they demand proof of quality before they buy. That's why architects and builders recognize the value of the General Electric remote-control wiring system as a spur to added home sales.

This step-saving, new wiring system at last makes dream-home electrical control a reality. Simple and economical to install, it is easily demonstrated to the prospect. Unobtrusive flush switches at convenient locations give instant, positive ON and OFF control of any light or electrical apparatus. And, while you're demonstrating remote control, you'll have the added "sell" of the General Electric monogram.

### For Low-Cost Homes

General Electric remote-control system is practical for even budget-price housing. Designed to fit in with existing techniques, remote control requires the same tools and methods needed to install present power circuits. Small relay snaps into knockout of outlet box. Inexpensive wire can then be run from relay to centrally-located transformer and conveniently-placed switches.

For further information why not contact your General Electric Construction Materials distributor, or check item (A) in the coupon below.

## Here's How You Can Get 49% More Current Per Raceway

Now, there's a really easy way to increase circuit capacity *without* increasing raceway size — just rewire with General Electric Deltabeston® asbestos-varnished cambric cables!

Insulated with heat-defying asbestos, Deltabeston AVA cables meet the requirements for small-diameter cables in heavy-load jobs involving high temperatures. That's why at normal ambient temperatures (in dry locations, as specified by National Electrical Code) AVA cables can deliver up to 49%\* more current per raceway than ordinary types of building wires.

### Saves on New Work

In new construction, too, because of their heat-resisting asbestos insulation, AVA cables often permit smaller conductors, reduced raceway sizes, and over-all savings on weight.

If you have not considered asbestos-varnished cambric cables for space and materials savings, you'll do well to figure them in on your next heavy-load job. It may amaze you to discover what real savings Deltabeston AVA cables can offer.

For further information, consult your local General Electric distributor, or check box (B) in the coupon below.

\* (This figure was worked out for AVA cables at 1000 MCM. Other sizes offer similar savings.)

Section K1-15  
Construction Materials Department  
General Electric Company  
Bridgeport 2, Connecticut

Please send me free information on:

- A  Remote Control
- B  AVA Cables
- C  White Rigid Conduit
- D  PVX Cable
- E  Mercury Switch

Name \_\_\_\_\_ Title \_\_\_\_\_  
 Company \_\_\_\_\_  
 Address \_\_\_\_\_  
 City \_\_\_\_\_ Zone \_\_\_\_\_ State \_\_\_\_\_

# GENERAL ELECTRIC



# 50 Years of Progress in Concrete Masonry

Nowhere in the construction industry has greater progress been shown in the past 50 years than in concrete masonry.

In this time, the uses have increased from a few minor hut-like buildings to a full range of the most important structures including residences, apartments, stores, schools, hospitals, and office and public buildings in all sections of the country.

And with good reason, for practically a whole new science has been developed in the making of concrete in the last half-century. New machinery has been created for high quality, high speed production. Architectural design and engineering developments have kept pace.

Similar advances are found in the production of materials—aggregates and Trinity White cement.

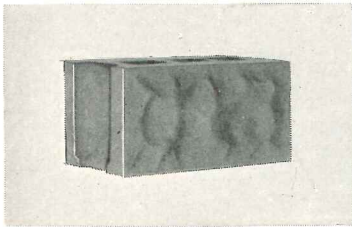

"Imitation rock-face" Block was the Fore-runner of

## MODERN CONCRETE MASONRY

The beginnings were humble—imitation rock-faced block were made of unwashed sand and gravel and sun cured. A startling contrast with today's widely used concrete units made with full benefit of modern technology. Trinity—the whitest white—is ideal for white or colored finishes for concrete masonry. May be used either as portland cement stucco or in cement paint form.

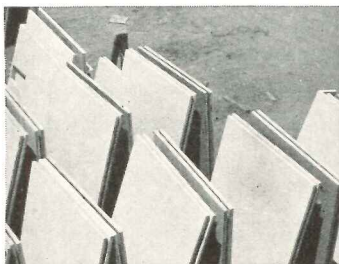

Architectural Concrete Units made with Trinity—  
The whitest white cement

The finest structures such as the Prudential Building, Los Angeles, use architectural concrete units made with Trinity White—a true portland cement. In addition to its fine appearance, architectural concrete units contribute uniquely to structural economies. Trinity white is recommended for use in terrazzo. Its extra whiteness gives an extra whiteness to the matrix, or, with colors added, a purer color tone.

## extra white... THE PRUDENTIAL BUILDING IN LOS ANGELES

This building is the Western Home Office of the Prudential Insurance Company.

The shimmering white mass rises thirteen stories in the central portion and symbolizes the strength and resources of the company whose trade mark is the Rock of Gibraltar.

Except for the window spandrels, the exterior is architectural concrete units. The remarkable whiteness of these units is achieved by the use of Trinity White portland cement

and white quartz. We have prepared a descriptive booklet on the Prudential building showing the method of placing these units. Ask for it.

## TRINITY WHITE Portland Cement

A product of General Portland Cement Company  
OFFICES AT:

111 W. Monroe St., Chicago 3; 305 Morgan St., Tampa 2;  
Volunteer Bldg., Chattanooga 2; Republic Bank Bldg., Dallas 1;  
816 W. 5th St., Los Angeles 5

PLAIN OR WATERPROOFED



"AS WHITE AS SNOW"



### CREDITS

Owner: The Prudential Insurance Co. of America  
Architects: Walter Wurdeman & Weldon Beckett, Los Angeles  
Structural Engineers: Murray Erick Associates  
Mechanical Engineer: Ralph E. Phillips  
General Contractor: Wm. Simpson Construction Co., Los Angeles  
Architectural Concrete Units Manufacturers: Wales-Bageman, Los Angeles, and Otto Buchner & Co., Salt Lake City  
Masonry Contractor: Thomas B. Childs, Salt Lake City

**ANNOUNCING**

*The New!*  
**THRUSH**

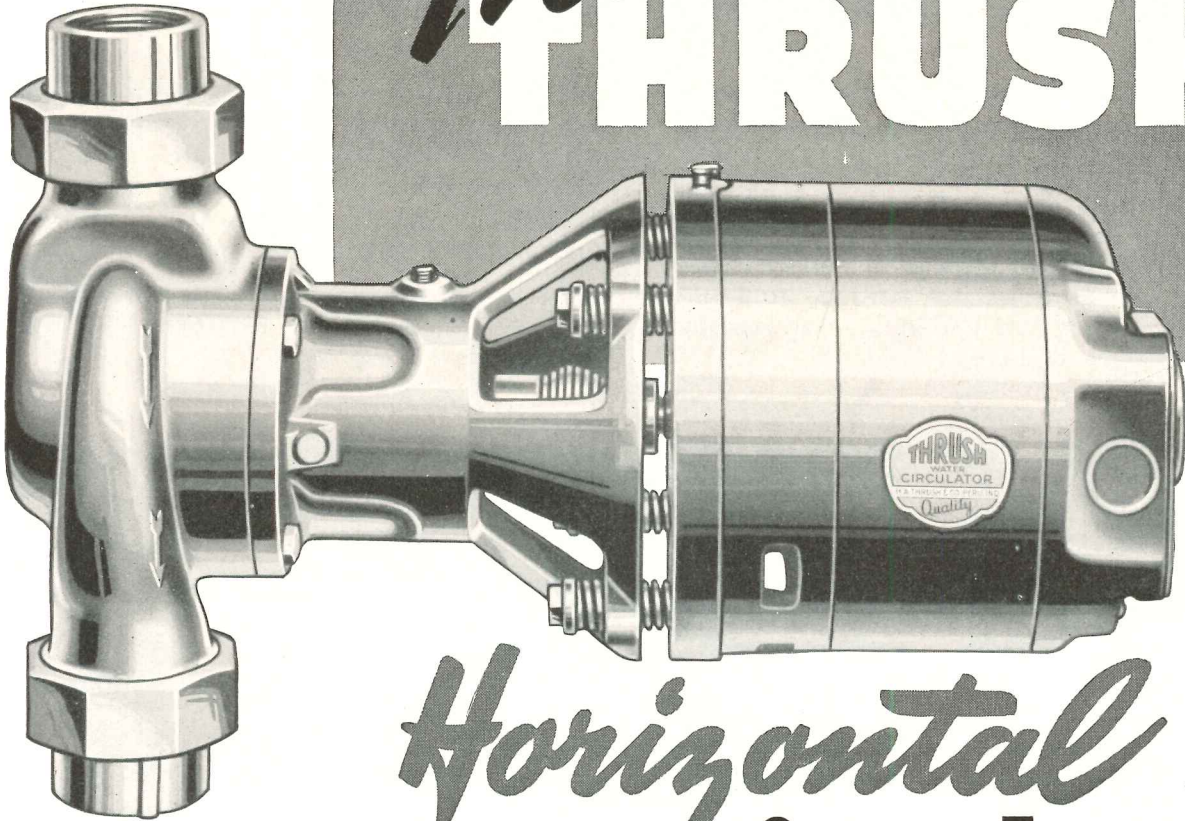

*Horizontal*  
**water circulator**

**H**ERE is a new Thrush Water Circulator to provide Forced Circulating Hot Water Heat for small or large homes and smaller commercial buildings. This new horizontal type circulating pump incorporates all the time-tested features which have made Thrush a leader through the years. Whenever you want to provide the best in radiant heat, specify Thrush Forced Circulating Flow Control System of Hot Water Heat. It provides summer-winter domestic hot water from the regular heating boiler. Installation savings place it well within the reach of the modern, low cost home.



ALSO VERTICAL MODELS

**H.A. THRUSH  
& COMPANY**

PERU · INDIANA

★ Positive forced circulation, quiet, free from service troubles.

★ Thrush Flow Control System assures constant Radiant Heat.

★ Thrush controls even anticipate outdoor weather changes.

SEE OUR CATALOG IN SWEET'S  
OR WRITE DEPT. J-1 FOR MORE INFORMATION

**FORCED CIRCULATING HOT WATER HEAT**

# LET FACTS AND SPECIFICATIONS PROVE THE SUPERIORITY OF

# MENGE L Flush DOORS



### DESIGN AND CONSTRUCTION

The design and the construction of Mengel Hollow-Core Flush Doors are the products of extensive field experience, continual laboratory research, and skilled labor which has made Mengel one of the greatest names in the wood industry.

- 1 **40% Lighter in Weight** . . . than standard panel hardwood doors.
- 2 **Patented "Insulok" Core** . . . gives stronger bond between core and faces; keeps faces flat; provides flame resistance.
- 3 **Solid Hardwood Stiles and Rails** . . . provide maximum screw-holding power.
- 4 **Key-lock Davetails** . . . keep stiles and rails permanently tight.
- 5 **Slam-tested** \* . . . 25,000 times . . . proves long life.
- 6 **Extra Guard Against Warpage** \* . . . provided by special mill-curing process.
- 7 **Broad Selection of Hardwood Faces** . . . individually beveled to satin smoothness permits wide range of finishes . . . reduces finishing costs.
- 8 **Engineered Construction** . . . assures maximum dimensional stability.

\*Mengel exclusive.

**GUARANTEE** . . . All Mengel Hollow-Core Flush Doors meet the standard door guarantee adopted by National Door Manufacturers' Association.

### USAGE

Mengel Hollow-Core Flush Doors are constructed with water-resistant, hot-press glues, and are ideal for interior use.

Stile edges may be made to match face when so ordered.

Door openings may be cut within 5 inches of the bottom or top edge, and within 5 inches of the sides (see Figure 1). If doors are to be cut down in height, equal margins should be sawn from top and bottom, and not to exceed one inch.

### SPECIAL DOORS

Mengel Hollow-Core Flush Doors can be manufactured in other sizes, widths and thicknesses, to your specifications, with circular or rectangular light openings, with louvred openings, or with special faces to suit individual designs. Doors with two lock blocks or with special interior blocking to permit installation of mirrors, etc. also can be furnished. Full details upon request.

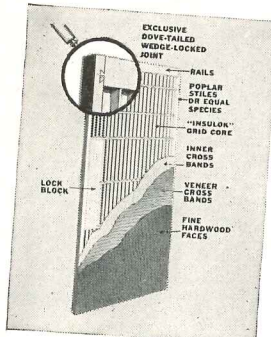

FIGURE 1



Mengel Solid-Core Flush doors match faces when so ordered. Leave 5 inches of top or 5 inches of sides. Leaves used in the same door.

### SPECIAL DOORS

Flush doors can be manufactured to your specifications—solid, or with special faces and edges may be had as Rabbeting and Beading (Std.), Beveled Edges. Full details upon request.

1-3/4" and 1-3/4" 2-piece Yellow Poplar or equal stiles are specially machined for fitting is necessary.

and bottom, 3-5/8" wide Poplar equal species stabilized by starting cross the grain at regular intervals.

doors assembled with the grain run at right angles to the grain of the face (see Figure 2).

entire assembly fabricated with water-resistant resin bonding.

Both faces of all Mengel Doors smoothly finishing perfect surfaces for natural, paint, or varnish finishes.

All Mengel Doors factory prefer to standard RAPPED—Each door individually papered dust-tight package when so ordered.

WARRANTY—All Mengel Stabilized Solid-Core meet the standard door guarantee adopted by National Door Manufacturers' Association.

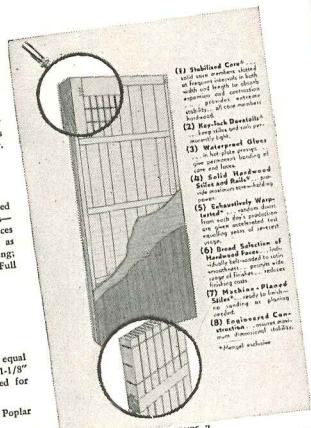

FIGURE 2



You know and we know that "all flush doors are NOT just alike." Door qualities vary as much as the experience, know-how, efficiency and integrity of their makers.

Mengel Flush Doors — Hollow Core and Solid Core — are built the way you'd want them built, of the materials you yourself would choose. Their specifications prove it. Finer or more dependable doors cannot be obtained at comparable prices.

Get the facts and specifications on Mengel Flush Doors, as contained in the A. I. A. Catalog illustrated above. Use the coupon for convenience.

## BETTER DOORS, AT COMPETITIVE PRICES

THE MENGE L COMPANY  
 Plywood Division, Dept. AR-5, Louisville 1, Ky.

Gentlemen: Please send me a free copy of the complete "A. I. A. File" Data Book on Mengel Flush Doors.

Name \_\_\_\_\_

Firm \_\_\_\_\_

Street \_\_\_\_\_

City \_\_\_\_\_ State \_\_\_\_\_



*“Great gobs of blubber, Nanook—*

*here’s a real ‘refrigerator salesman!’”*

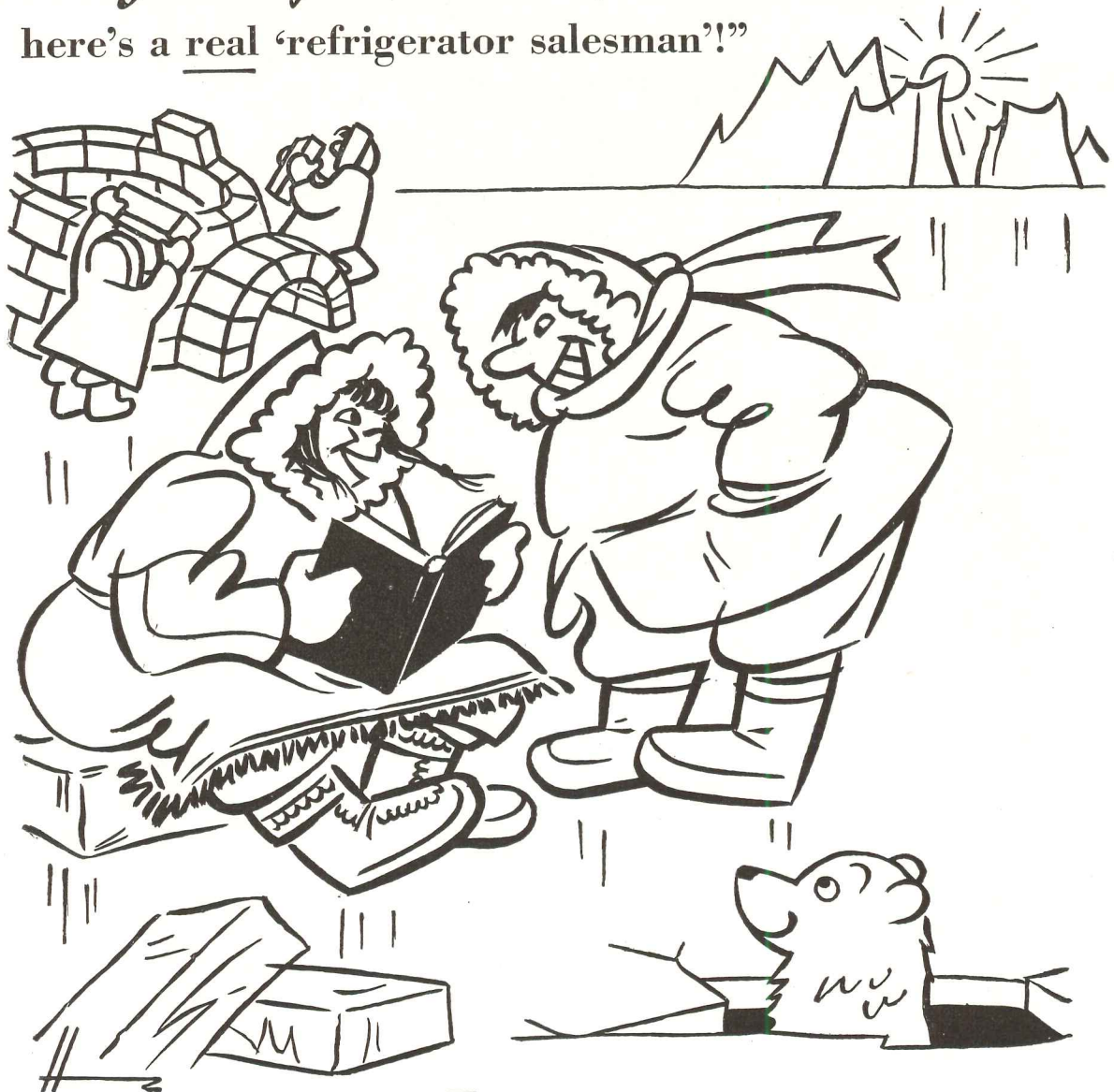

THE crack salesman who sold refrigerators to the Eskimos has a counterpart in Home Owners' Catalogs.

Matter of fact, Home Owners' Catalogs excels the proverbial refrigerator salesman! Can *any* salesman deliver your “sales presentation” to two thousand verified home-planners a week . . . live prospects who *must* buy somebody's building materials and equipment? Can *any* salesman call on hundreds of known home-planners every day . . . and charge you only ten cents per “sales call?”

Yes: Home Owners' Catalogs!

Better hire the F. W. Dodge Corporation's crack “salesman” *now*, Mr. Building Products Manufacturer! Your consumer sales literature in the next edition of Home Owners' Catalogs will bring you an igloo full of profits!



*Home Owners'* CATALOGS

119 West 40th Street, New York 18, N. Y.

F. W. Dodge Corporation's Consumer Catalog Distribution Service





miracles require planning

Stainless steel works miracles only when the *right* type is matched to the right application. Crucible, a pioneer in the development of stainless steels, offers the services of our unsurpassed metallurgical staff to help you make the right choice.

And Crucible produces a complete range of sheet and strip in gauges, grades and finishes from 1/2" to 60" inclusive, as well as all other forms: plates, bars, tubing, forgings, wire and castings to meet your specific requirements. Data sheets are available on request. CRUCIBLE STEEL COMPANY OF AMERICA, Chrysler Building, New York 17, New York.

**CRUCIBLE**

hot and cold rolled

first name in special purpose steels

**STAINLESS SHEET AND STRIP**

STAINLESS • HIGH SPEED • TOOL • ALLOY • MACHINERY • SPECIAL PURPOSE • STEELS

# Just Published!

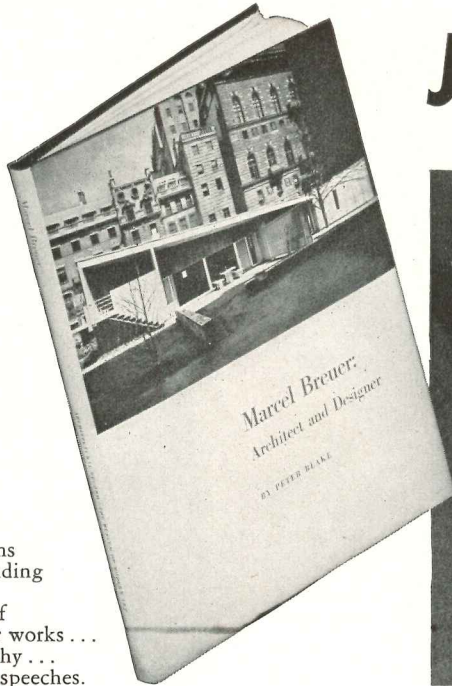

128 pages,  
Fully indexed  
196 illustrations  
Stiff, cloth binding  
Size 8½ x 11  
Includes list of  
Breuer's major works . . .  
full bibliography . . .  
excerpts from speeches.

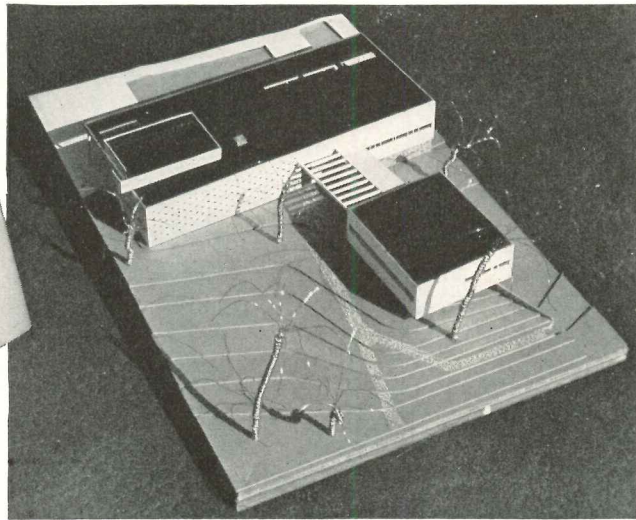

*The Inspiring Life Story of a Great Contemporary Architect . . .*

## "Marcel Breuer: Architect and Designer"

by PETER BLAKE

"In addition to being a most accomplished artist in his own right, Marcel Breuer has formed a link between the turbulent days of the early twenties, when many of the technical and esthetic ideas that have produced the new architecture were first formulated, and the present day with its increasingly widespread acceptance of those ideas in this country and abroad. This book is an attempt both to document Breuer's own work and to emphasize the main points in the message he is trying to convey."

*Peter Blake*

*Curator of Architecture and Design, Museum of Modern Art.*

PETER BLAKE'S "Marcel Breuer: Architect and Designer" is that rare publishing achievement — a biography which captures *wholly* the essence and spirit of its subject.

The essential meaning of Breuer's career is made clear in this significant and well-documented book as his life and works are traced from his initial contributions to architecture and design at the famous Bauhaus School in Germany to the present time. Considerable space, incidentally, is devoted to the Bauhaus experiment under Walter Gropius which has been responsible for so many notable advances in architecture and design.

### *Includes Many Reproductions*

Fortunately, the author realized that actual reproductions of Breuer's work would explain his growth more graphically than words. Thus, the book is profusely illustrated with plans, drawings and designs made at every stage of

the architect's career. In all there are 196 illustrations, giving fascinating glimpses of Breuer's talents in action; showing his increasing interest in architecture, as distinguished from furniture design, and his later pre-occupation with American techniques. The illustrative material includes not only Breuer's designs, but also the works of those who inspired him: the expressionists, Kandinsky and Klee as well as the rationalists, Maholy-Nagy, Albers and Gropius.

★ ★ ★

It is inconceivable that anybody could read Peter Blake's book without learning a great deal. But instruction is not its main concern, nor does it account for the book's intrinsic charm. That charm, rather, lies in its magical unfolding of the drama of a great human being — in the development of a talent which ripened with each new challenge.

Whether you read "Marcel Breuer: Architect and Designer" out of professional interest or for sheer enjoyment, your time will be well invested. Handsomely bound in stiff, cloth binding, distinctively illustrated, this 128-page book will be an important new addition to your library.

To obtain your copy, simply fill in and return the coupon below. Just off the press, printed in a limited edition, the book is now available to you at the price of \$4.00, including postage.

BOOK DEPARTMENT, ARCHITECTURAL RECORD  
119 West 40th Street, New York 18, N. Y.

Enclosed is \$\_\_\_\_\_ for \_\_\_\_\_ copy(s) of "Marcel Breuer: Architect and Designer," by Peter Blake, at the price of \$4.00 per copy. (For N. Y. C. add 2% sales tax.)

Name \_\_\_\_\_

Address \_\_\_\_\_

City \_\_\_\_\_ Zone \_\_\_\_\_ State \_\_\_\_\_



# Gold Bond's COMPLETE LINE OF ACOUSTICAL PRODUCTS

## MEETS EVERY SOUND CONDITIONING NEED... FITS EVERY BUDGET!

YOU'LL find the answer for any acoustical job in Gold Bond's complete line of acoustical products. Take a look at the chart below and you'll see the answer. Call your local Gold Bond Acoustical Applicator, listed in the phone directory under "Acoustical Contractors". He's a factory-trained and experienced engineer and at no obligation will be glad to work with you in selecting the right product to fit your budget. For additional information see our section in Sweet's, or write Division Z, Dept. AR 1.

### NATIONAL GYPSUM COMPANY, BUFFALO 2, NEW YORK

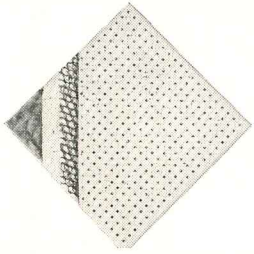
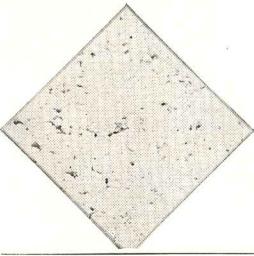
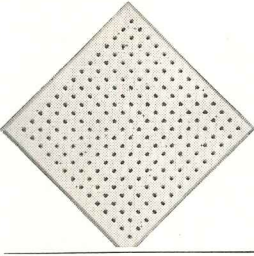
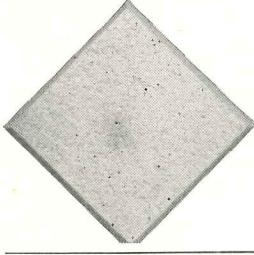
*Lath... plaster... lime... sheathing... wall paint... rock wool insulation... metal lath and sound control products... fireproof wallboards... decorative insulation boards.*

		Noise Reduction Coeff.	Thickness	Sizes	Finish
	<b>ACOUSTIMETAL</b> Low maintenance cost. Can be washed or painted any number of times. Panels quickly removed for access to plumbing and wiring. Fireproof, permanent, salvageable.	.85	1 1/4"	12" x 24"	Alkyd resin enamel finish, electro-statically applied for uniform density and coverage. Baked on by infra-red light. Bonderizing of metal assures greater adhesion of paint.
	<b>TRAVACOUSTIC</b> Fireproof mineral tile. Closely resembles beautiful travertine stone. Fissures vary in size, depth, and arrangement. Permanent, sanitary, acoustically efficient.	.65 .70	1 1/16" 1 3/16"	6" x 12" 12" x 12" 12" x 24"	Non-glaring white finish applied at the factory gives high light-reflection. Repaintable with brush or spray gun.
	<b>ACOUSTIFIBRE</b> Perforated wood fibre tile. Round, clean holes drilled deep into porous core. Chemically-treated against mould and fungus. Sanitary, cleanable, repaintable.	.55 .65 .70	1/2" 5/8" 3/4"	12" x 12" 12" x 24"	Factory-applied shell-white finish results in high light-reflection.
	<b>ECONACOUSTIC</b> Low cost wood fibre tile. Distinctive brushed texture surface offers unusual natural beauty. Cleanable with vacuum cleaner.	.60 .70	1/2" 1"	12" x 12" 12" x 24"	Prepainted white. May be spray-painted when other colors are desired.
	<b>THERMACOUSTIC</b> A mineral wool product which is sprayed to any desired thickness. Fireproof and rot-proof. Especially adaptable to irregular surfaces.	.80 at 1/2" thickness	As desired	Monolithic	Eggshell white finish gives high light reflection. Can be repainted without destroying its acoustical properties.

# Mr. Smith "Slept in" this Morning!

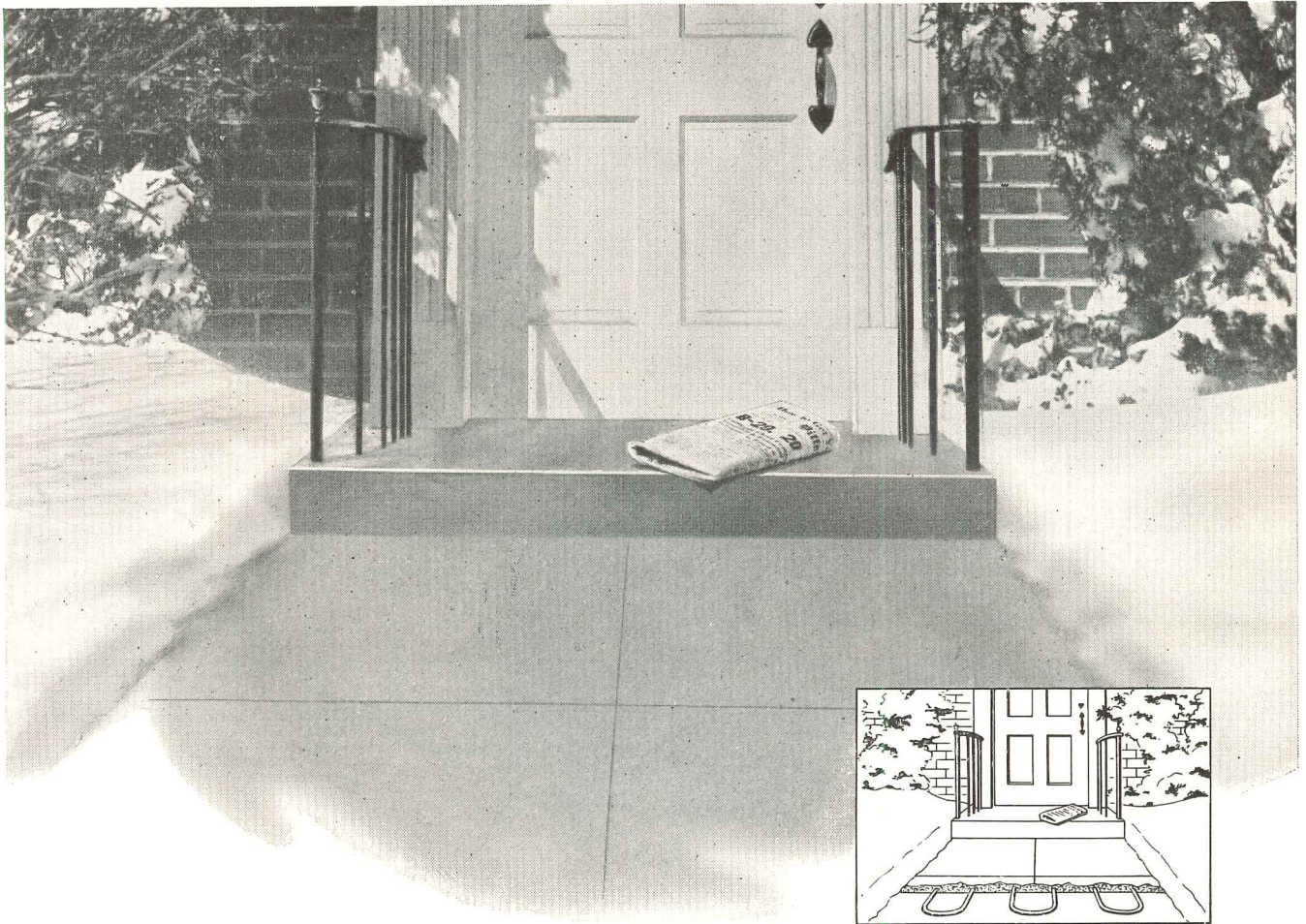

## *Steel Pipe* is first choice for snow melting systems

Fortunate is the man who can let *steel pipe* shovel his snow while he takes an extra "forty winks" on a blustery winter morning!

Yes, by circulating hot water through steel pipes embedded in the concrete, snow can be melted on contact, ice formations prevented, and driveways and walks kept dry and safe all winter long. More and more home and building owners, plants, airports, and institutions are installing such systems.

*Steel Pipe is the first choice*, for good reasons. Not alone in slab heating for snow removal, but in the similar service of Radiant Heating for interiors as well . . . because *steel pipe* has been proved for more than 60 years in the transmission of steam and hot water for conventional heating purposes.

Economical to begin with, easy to form and weld, expansion co-efficient the same as concrete and plaster, durable beyond the life of the structure . . . *steel pipe* embodies all the characteristics necessary to successful installation and operation!

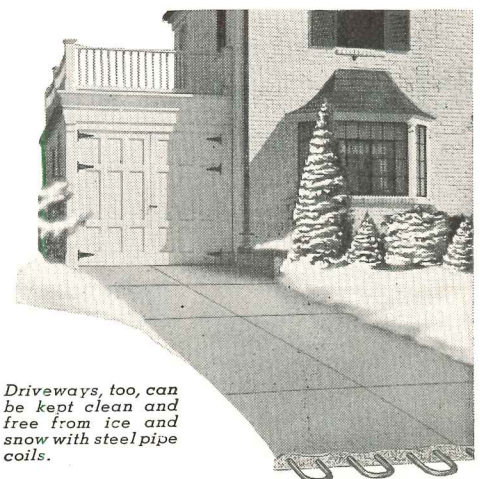

*Driveways, too, can be kept clean and free from ice and snow with steel pipe coils.*

## COMMITTEE ON STEEL PIPE RESEARCH

OF AMERICAN IRON AND STEEL INSTITUTE

350 Fifth Avenue, New York 1, N. Y.

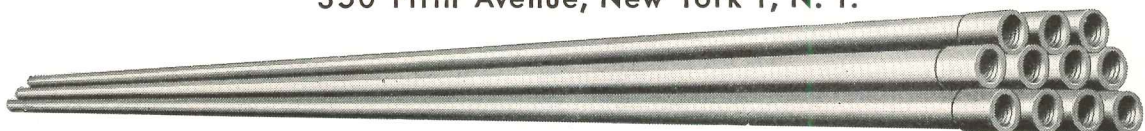



Birch and Walnut Craftsman Grade Weldwood are combined beautifully in this attractive living room. Note the built-in television corner with storage space above and below

**Welcome News for You and Your Clients . . .**  
**NEW CRAFTSMAN GRADE WELDWOOD**  
**Low in Price . . . High in Quality**

**H**ERE is one of the most important plywood developments in recent years—a decorative hardwood panel, of excellent quality, priced as much as 30% below the cost of other brands in the same woods.

This is made possible by the construction of our new mill in Orangeburg, S. C., designed for efficient straight-line production of standard panels in the most popular woods.

From the standpoint of quality and beauty, these Craftsman panels are surpassed by no other plywood *except* the superlative Weldwood produced in our Algoma plant—where every panel is given *individual* attention, from the selection and matching of face veneers through every other detail of manufacture.

While Algoma Grade Weldwood is still recommended for the *ultimate* in fine decorative paneling, Craftsman Grade fills the long-felt need for a *good* panel for applications where price is an important factor.

Craftsman Grade is currently available in walnut, oak, birch and Korina. Panels are 4' x 8', 4' x 8' and 4' x 6'—all 1/4 inch, 3 ply. We will be glad to answer any questions you may have about this popular-priced Weldwood. Simply write to: United States Plywood Corporation, 55 West 44th Street, New York 18, N. Y. *This label on the back of every panel identifies Craftsman Grade Weldwood*

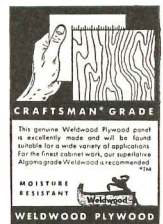

**WELDWOOD Plywood**

*Weldwood Plywood is manufactured and distributed by:*

**UNITED STATES PLYWOOD CORPORATION U.S. - MENGEL PLYWOODS, INC.**  
 New York 18, N. Y. Louisville 1, Ky.

*Distributing units in Albany, Baltimore, Boston, Brooklyn, Buffalo, Chicago, Cincinnati, Cleveland, Detroit, Fresno, Glendale, Hartford (East), High Point, Indianapolis, Knoxville, Los Angeles, Milwaukee, Newark, New Hyde Park (L. I., N. Y.), New York, Oakland, Philadelphia, Pittsburgh, Portland, Ore., Richmond, Rochester, San Francisco, Seattle, Spokane, St. Paul, Washington, D. C. Also U. S.-Mengel Plywoods, Inc., distributing units in Atlanta, Birmingham, Dallas, Houston, Jacksonville, Kansas City, Kans., Louisville, Memphis, New Orleans, San Antonio, St. Louis, Tampa. In Canada: United States Plywood of Canada, Limited, Toronto. Send inquiries to nearest point.*

Weldwood\* Hardwood Plywood  
 Douglas Fir Weldwood  
 Mengel Flush Doors  
 Douglas Fir Doors  
 Overhead Garage Doors  
 Molded Plywood  
 Armorply\* (metal-faced plywood)

Tekwood\* (paper-faced plywood)  
 Weldwood Glue\* and other adhesives  
 Weldtex\* (striated plywood)  
 Micarta\*  
 Flexwood\*  
 Firzite\*  
 Weldwood Fire Doors  
 Weldwood Flush Veneer Doors

\*Reg. U. S. Pat. Off.



**Plastics and Wood  
 Welded for Good**

*Interior grade Weldwood Plywood is guaranteed for the life of any building in which it is installed*

# Announcing... A New Store Book

Ben Schnall Photo

## "Planning Stores That Pay"

by Dr. Louis Parnes, A.I.A.

for

Architects and Store Designers,  
Department and Chain Store  
Administrators

**"The great majority of department stores today are not making the most efficient use of their space,"**

says Dr. Louis Parnes, international authority on store planning.

**"This is due to haphazard growth and bad planning . . . The tremendous occupancy costs, which absorb 6% or more of gross sales, can be cut down in relation to sales by good design."**

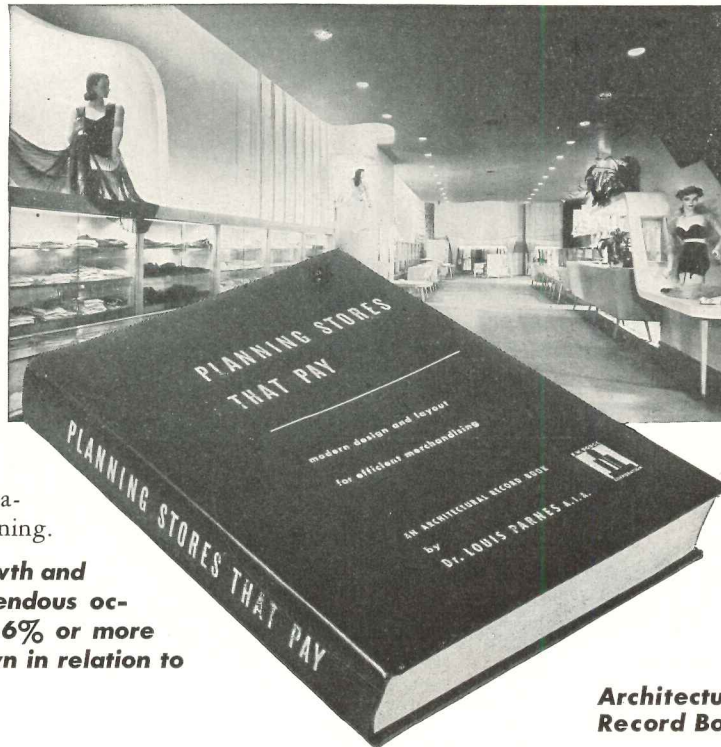

**An  
Architectural  
Record Book**

**Over 500 photographs and diagrams of floor plans, store fronts and interiors.**

Features 112 stores and shops . . . the work of more than 60 architects and designers.

300 pages; 8 3/4 x 11 3/4; heavy, durable, cloth binding; 80 lb. coated stock; Detailed Table of Contents; Comprehensive Index.

### TABLE OF CONTENTS

1. Introductory Survey
2. City Planning Considerations
3. The Selling Zone
4. The Customers' Zone
5. The Merchandise Zone
6. The Show Window
7. The Personnel Zone
8. Interior Lighting
9. Circulation and Transportation
10. Scientific Surveys and Data

### CONTENTS OF A TYPICAL CHAPTER

To indicate how logically and thoroughly this book deals with its subject, here are the section headings of a single chapter (Chapter 3, entitled "The Selling Zone"):

Space Organization. Co-ordination and Arrangement of Central Sales Areas. Relative Size of Departments. Circulation on Selling Floors: Aisle Layout; Aisle Densities; Equipment Layout. Fixture Specifications. Self-Service Equipment. Flexible and Standardized Equipment. Service Stations. Interior Display. Interior Column Spacing. Productivity, Efficiency, and Equipment Layout. Special Sales Rooms. New Trends in Basements. Main Floor Layout.

### A few of the architects

and firms whose works are discussed are:  
Carson & Lundin  
Morris Lapidus  
Shreve, Lamb & Harmon  
Kenneth Franzheim  
Fred N. Severud  
Harry Devine  
William Lescaze  
H. Roy Kelley  
John S. Redden  
Albert C. Martin  
John M. Hutton  
Morris Ketchum, Jr.  
Ernest J. Kump  
Stiles O. Clemens

In his new comprehensive study "Planning Stores that Pay," Dr. Parnes demonstrates the amazing degree to which architecture — as expressed in counter lengths, traffic flow, etc. — speeds and increases retail sales, not only for department stores but for specialty and chain stores. Point by point he conducts a tour of the store to illustrate the right and wrong aspects of profit-making design. He shows how to compute such diverse factors as, say, the ideal width of show windows and the optimum number of chairs in a shoe department.

With more than 500 illustrations, he explores every detail of the store and its arrangements — entrances, arcades, show windows, transportation systems, furniture and fixtures, receiving and shipping facilities, floor and department layouts, display arrangement and lighting, and all the hundreds of items that go to make up a modern merchandising machine. Everything is calculated from the viewpoint of efficiency, and the contribution of each part of the store to the process of selling goods profitably is the criterion of its recommended design. Diagrams, charts and scale drawings, from hundreds of leading stores and from the works of America's greatest store architects, prove each point graphically.

### Why Every Department Store — Old or New — Now Needs an Architect's Service

Composite statistics of department store income and expense have long been put to invaluable use in stepping up store efficiency. Dr. Parnes shows how they also can be used as a precise basis for designs that automatically enhance sales . . . and reveals the enormous potential profits thus available. The first store to be thus fully engineered will have extraordinary advantages! *But meanwhile every department store in the country can begin at once to plan its architectural transformation.*

### A Basic Textbook on Store Architecture

"Planning Stores That Pay" is a book of basic principles, but specific ideas flow from its pages in rapid succession. A single chapter has enough suggestions to launch a number of long-term projects in store layout, equipment,

etc. Any department store administrator can see that it will pay him to call in private architects for immediate replanning, and that such replanning may well pay for itself a hundred times over.

Department stores have exhausted great resources of effort and ingenuity to maintain their life-line margin of profit. The fact that "Planning Stores That Pay" suddenly injects into this situation sensational new weapons for combatting competition makes this an extremely valuable, if not indispensable, book for architects and store administrators. With it they can speak each other's language, work together, and make the most of today's great opportunities.

### Order Your Copy Now

"Planning Stores That Pay" is now available to you at the price of \$15 per copy. But because the demand for this book is exceeding even the most sanguine expectations, the initial printing may soon be exhausted. Therefore, to make sure of your copy of this new, basic text on advanced store design and planning, order your copy now.

Use the convenient coupon at the right. The book will be sent promptly on receipt of your order . . . postpaid.

BOOK DEPARTMENT, ARCHITECTURAL RECORD  
119 West 40th Street, New York 18, N. Y.

Enclosed is \$..... for..... copy(s) of "Planning Stores That Pay," by Dr. Louis Parnes, A.I.A., at the price of \$15 per copy. For N. Y. C. add 2% sales tax.

Name.....  
Address.....  
City..... Zone..... State.....

# How to put MORE daylight where you WANT it — and do it economically

1. Enough Daylight on Every Desk.
2. Avoidance of Bright Spots or Annoying Contrasts.

These two basic aims of good classroom daylighting need not entail expensive materials or techniques. That has been proved by two years of comprehensive research study at Southern Methodist University by Professor R. L. Biesele, Jr.

By simply using flat glass for high light transmission and using proper reflective interior surfaces, correct daylighting can be had at low cost.

A summary of Professor Biesele's findings is available to school boards and architects. It includes suggestions for window treatment, selection of glass, shading devices, decoration and seating arrangement. Mail the coupon for your copy.

This diagram shows a room arrangement found beneficial to all students. Windows of clear glass, free from piers, extend from front wall to the back.

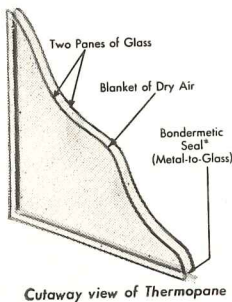
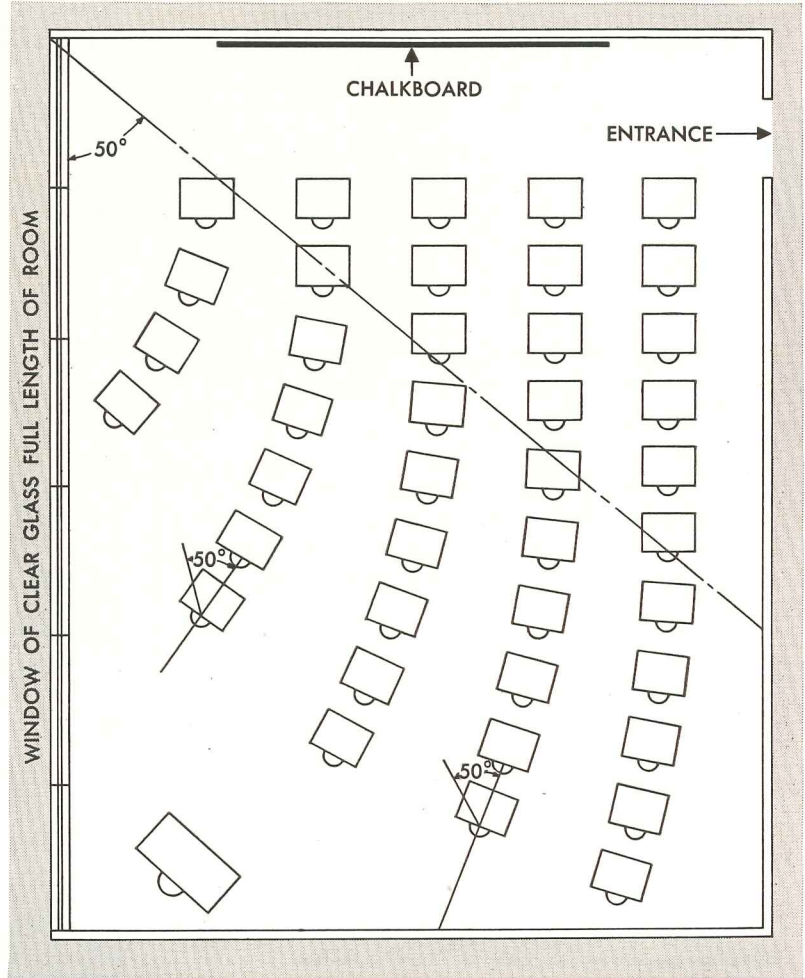

## THERMOPANE\* . . . for insulation of glass areas

For greater comfort and fuel savings, use L·O·F insulating glass. Composed of two panes of glass with dry air sealed between, it cuts heat loss, reduces drafts, minimizes condensation, makes daylight design practical

in all climates. A window wall double glazed with clear flat glass transmits 81% of daylight—more than an equal area of any other form of double glass insulating unit. That's why more and more schools have *Thermopane* windows. ®



# Thermopane

MADE ONLY BY LIBBEY·OWENS·FORD GLASS COMPANY

5615 Nicholas Building, Toledo, Ohio

Libbey-Owens-Ford Glass Company  
5615 Nicholas Building, Toledo 3, Ohio

Please send me a free copy of "Daylight Engineering in Schools", plus information on *Thermopane*.

Name .....

Address .....

City ..... Zone ..... State .....

# Why Vulcan is so popular in schools

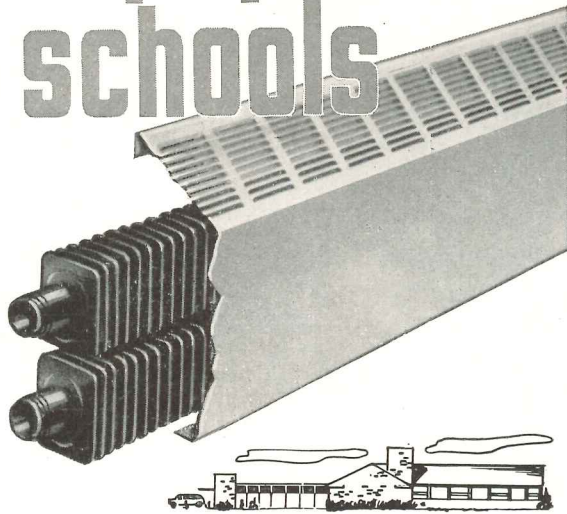

A recent survey of modern school buildings located in various parts of the country showed 4 out of 8 using Vulcan Fin-tube Radiation.

Heating engineers, architects and School Boards say "yes" to Vulcan because it easily meets the desired standards for:

- healthful draft-free comfort
- ease and flexibility of installation
- efficient maintenance-free operation
- neat appearance
- operating economy

## QUALITY CONSTRUCTION — EASY INSTALLATION

All steel units fabricated from seamless steel pressure tube, A.S.T.M. Spec. A-83. *Guaranteed* for 450 P.S.I. Fins *guaranteed* to remain rigid and tight under conventional operating conditions.

Vulcan is easy and economical to install because it is light in weight — requires few fittings and supports.

## RADIANT AND CONVECTION HEAT

Vulcan continuous line radiation installed beneath large modern windows protects the rest of the room area with a smooth blanket of combined radiant and convection heat — eliminates uncomfortable drafts.

## NEAT APPEARANCE

Vulcan covers and accessories designed for maximum heating efficiency, neat appearance and safety.

**THE VULCAN RADIATOR COMPANY**  
26 FRANCIS AVE. HARTFORD 6, CONN.

Complete information on Vulcan Standard and Vulcan Baseboard Radiation for residential heating in Sweet's Architectural File.

 **VULCAN** 25 YEARS  
A LEADER IN FIN-TUBE RADIATION

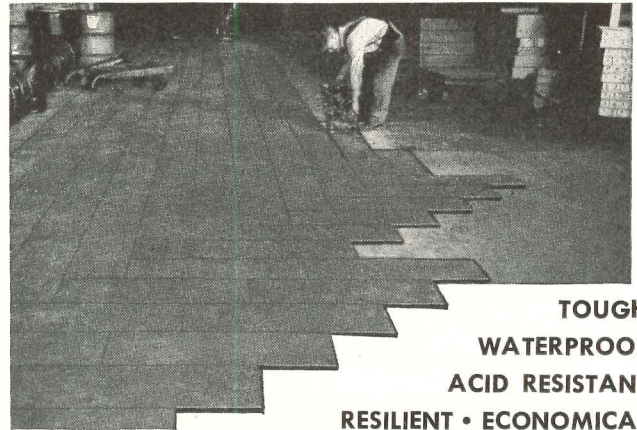

**TOUGH  
WATERPROOF  
ACID RESISTANT  
RESILIENT • ECONOMICAL**

## SERVICISED ASPHALT PLANK

*has everything!*

SERVICISED Asphalt plank is the low cost, *easy* answer to your floor surfacing problem if you need a tough, long-wearing, resilient, waterproof, non-slip floor on platforms, loading docks, truckways, etc. Economical, easy to apply, SERVICISED Asphalt Plank is made in Standard and Mineral surfaced types in any thickness, width and length to meet your requirements.

Write today for full details and illustrated circular on this superior industrial flooring. SERVICISED engineers are always available to help with your flooring problems.



**SERVICISED PRODUCTS CORP.**  
6051 W. 65th ST., CHICAGO 38, ILL.

**STOP** *that* **WATER**  
*with* **FORMULA # 640**

A clear liquid which penetrates deeply into masonry surfaces.

The hydrocarbon solvent evaporates, leaving the pores filled with a balanced formula of seven different waxes and resins.

See our catalogs in SWEET'S Architectural Files  $\frac{9a}{9}$  and Engineering Files  $\frac{4f}{3}$  under Waterproofing and Dampproofing.

WRITE OUR ENGINEERING DEPARTMENT for office test kit, technical data, or regarding any special problem

J. Wilbur Haynes, Engineer

**HAYNES PRODUCTS CO.**

4007 FARNAM STREET • OMAHA 3, NEBRASKA





PUBLIC SCHOOL No. 195  
Shore Blvd., Brooklyn, N. Y.  
Board of Education of  
The City of New York  
Eric Kebbon—*Architect*  
Caristo Constr. Corp.—*Builder*

*Here's an excellent example of how Architect Kebbon masters the art of building within a budget while making no compromise with quality. Playroom and lunchroom are lined from floor to ceiling with Enduro-Ashlar Architectural Terra Cotta, slightly less than 2 inches thick. Color is a lustrous medium green that's easy on the eyes . . . while the ceramic glazed finish is easy on maintenance costs.*



Design interiors  
that are budget-wise  
as well as beautiful  
. . . with

## ENDURO-ASHLAR ARCHITECTURAL TERRA COTTA

In meeting a creative challenge where quality, price and maintenance are of equal importance, you will appreciate the outstanding advantages offered by Enduro-Ashlar Architectural Terra Cotta. It can be produced in units large or small, for interiors or exteriors, plain surfaces or decorative sculpture, in an unlimited range of ceramic colors. What's more, the original richness and beauty of this time-proved terra cotta can be retained indefinitely by simple soap-and-water washings. All these advantages add up to the reason why Enduro-Ashlar Architectural Terra Cotta is specified so often—for educational or industrial construction, and for modernization.

*Construction detail, data, color samples, estimates, advice on preliminary sketches, will be furnished promptly without charge. Send your inquiry today.*

FEDERAL SEABOARD TERRA COTTA CORP.



10 EAST 40th STREET, NEW YORK 16, N. Y.  
PLANTS AT PERTH AMBOY AND SOUTH AMBOY, N. J.

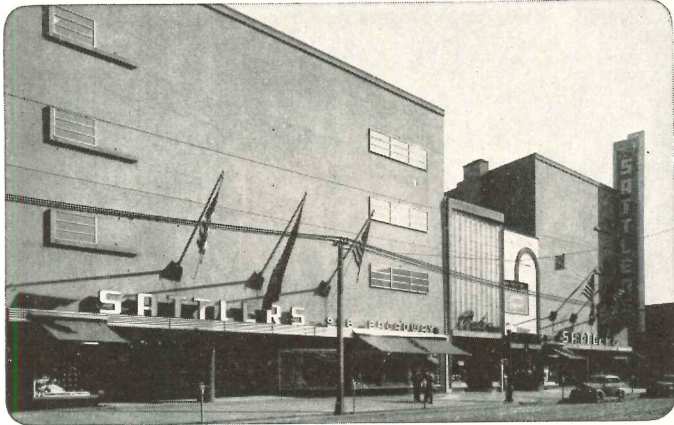

## Buffalo's Largest Store Air Conditioned throughout with Frick Refrigeration

Sattler's Department Store, covering most of a large city block, serves up to 150,000 people in a single day. The giant store is cooled in hot weather with ten Frick ammonia compressors using 920 horsepower. Installation by Mollenberg-Betz Machine Company, Frick Sales Representatives at Buffalo.



All Departments are Air Conditioned

For that important air conditioning, ice-making, refrigerating or quick-freezing job of yours, get in touch now with the nearest Frick Branch or Distributor.

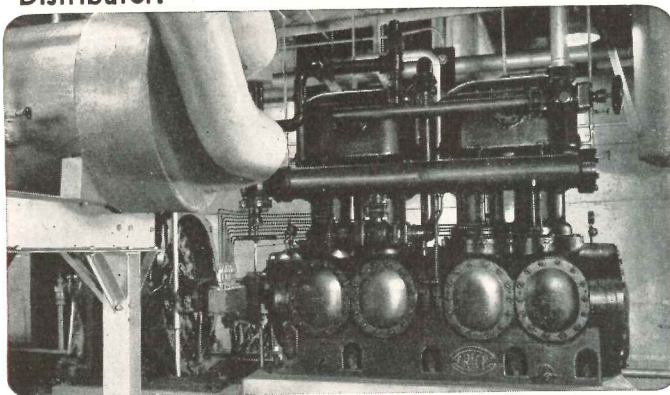

Ten Frick Compressors Are Installed on the Roof of Sattler's Store at Buffalo.

DEPENDABLE REFRIGERATION SINCE 1882  
**Frick Co.**  
 WAYNESBORO, PENNA. U.S.A.

Also Builders of Power Farming and Sawmill Machinery

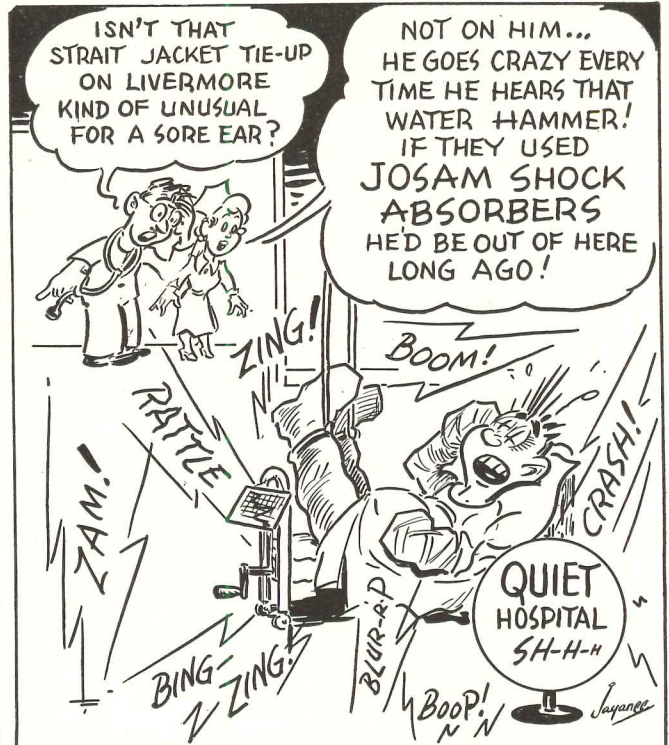

Why suffer a "shock" every time a faucet is closed, or a water closet is flushed. You can "cure" disturbing, destructive water hammer in any pipe lines by specifying Josam Shock Absorbers.

Josam Manufacturing Company  
 302 JOSAM BUILDING CLEVELAND 13, OHIO



## LONE STAR CEMENTS

COVER EVERY CONSTRUCTION NEED



### LONE STAR PORTLAND CEMENT

for concrete of outstanding quality in all types of construction



### 'INCOR'\* 24-HOUR CEMENT

America's FIRST high early strength Portland Cement—saves time, cuts costs



### LONE STAR MASONRY CEMENT

The modern masonry cement, for really great job performance

\*Reg. U. S. Pat. Off.

## LONE STAR CEMENT CORPORATION

Offices: Albany • Bethlehem, Pa. • Birmingham • Boston • Chicago • Dallas • Houston • Indianapolis • Jackson, Miss. • Kansas City, Mo. • New Orleans • New York • Norfolk • Philadelphia • St. Louis • Washington, D. C.



Your most precise medium for Prismatic Light Control...

# PYREX brand Lenslites

This installation illustrates how effective PYREX brand Lenslites are for controlling light. The problem involved the illumination of an auditorium to an intensity great enough for study purposes but at the same time providing dimmer control of the lighting for use during dramatic productions. The room is 82 feet wide by 85 feet long with an average ceiling height of 24½ feet. Using 300 watt lamps, the average reading is 23½ foot candles, an efficient lighting job.

PYREX brand Lenslites permit wide design flexibility for special incandescent

lighting effects and are available in both round and square types. With them, light can be concentrated, spread or the beam offset.

CORNING brand Lens Panels are basically Fresnel lenses in cross section, with prisms running parallel with the light source. Made of high quality crystal glass, they are available in a number of sizes and focal lengths to provide any light pattern you desire—concentration, spread or offset beam.

Bulletin LS-17 describes this lighting-ware and gives complete specifications.

Glendale Auditorium,  
Glendale College, Calif.

Architect:  
George Lindsay, Glendale  
Fixture Manufacturer:  
C. W. Cole & Co., Inc.,  
Los Angeles

Electrical Contractor:  
Victory Engineering &  
Electric Co., Los Angeles

Glass:  
PYREX brand Lenslites



Round Pyrex brand Lenslites  
—6½", 8¾", 11¼", 13¾"  
diameter—all wide angle.



Square Pyrex brand Lenslites  
—6½" conc., 8" conc., 8"  
wide angle, 12" conc., 12"  
wide angle.



**CORNING GLASS WORKS**

**CORNING, NEW YORK**

*Corning means research in Glass*

**FOR EFFICIENT, ATTRACTIVE LIGHTING...**

CORNING ALBA-LITE for diffusion of fluorescent light ... CORNING FOTA-LITE for high level illumination ... PYREX brand LENS LITES and CORNING brand LENS PANELS for prismatic light control

Corning Glass Works, Dept. AR-1, Corning, N.Y.

Please send me a free copy of your Bulletin LS-17, describing CORNING brand Lens Panels and PYREX brand Lenslites.

Name \_\_\_\_\_

Firm \_\_\_\_\_

Address \_\_\_\_\_

City \_\_\_\_\_ Zone \_\_\_\_\_ State \_\_\_\_\_

# CASTELL



World's  
Finest  
DRAWING  
PENCIL

18 degrees 7B to 9H

Still at  
Pre-war Price  
15¢ ... less in quantity  
A NAME FAMOUS  
SINCE 1761

**AW. FABER-CASTELL**  
PENCIL COMPANY INC., NEWARK 4, N.J.

## HERMAN NELSON UNIT VENTILATORS

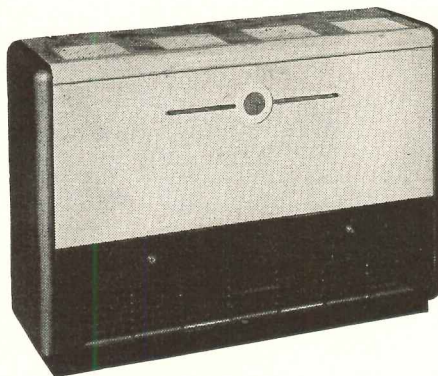

Herman Nelson Unit Ventilators maintain proper air conditions in schoolrooms, courtrooms, offices and other spaces occupied by relatively large numbers of persons. These heating and ventilating units not only provide heat when it is required, but also introduce cooler, outdoor air into the room to prevent overheating when body heat becomes excessive. Quiet, economical and attractive, these units permit automatic maintenance of uniform temperatures at all times.

*Write for Bulletin 2853*



**THE HERMAN NELSON CORPORATION**

Since 1906 Manufacturers of Quality Heating and Ventilating Products  
MOLINE, ILLINOIS

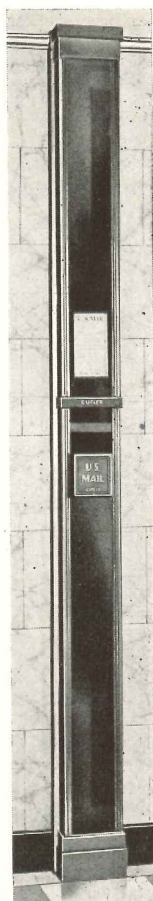

## MODEL F-50

has all the sturdiness and operating features of the well-known Cutler Model F — which has proved successful in use in the largest buildings throughout the world—plus a number of practical improvements.

*Catalogue in Sweet's*

**CUTLER MAIL CHUTE CO.**  
ROCHESTER 7, N. Y.

Here's why more architects  
are recommending **MONEL**

# Where fastenings must not fail

## TIEING UP CEILINGS

Worker of Dillaby Fire-proofing Company, Cambridge, Mass., uses pliable, easy-handling Monel tie wire to fasten steel screening on which plaster is to be applied. Photo taken during construction of John Hancock Insurance Co. building, Boston, Mass.



Monel has three outstanding characteristics that make it today's choice for tie wires and brick anchors.

It is *strong*. It is *ductile*. And it is *corrosion-resistant*.

Let's take them separately and see what these properties mean to your clients.

Monel® tie wire, for example, in the .047" diameter suggested for suspended ceilings, has a tensile strength of approximately 66,500 pounds per square inch. Accordingly, there is no need for such uneconomical operations as four-inch spacing and double-looping.

## ANCHORING BRICKWORK



Keystone-shaped end of strong, corrosion-resistant Monel brick anchor fits into Monel channel embedded in framework column of New Jersey Bell Telephone Co. building, Atlantic City, N. J. Installation by M. B. Markland Construction Co., Atlantic City, N. J. Brick anchors manufactured by Conver Steel Products Co., New York, N. Y.

For most jobs, wire mesh and expanded metal lath can be safely secured with Monel ties single-looped and spaced at *six-inch* intervals. Result: lower cost . . . safe suspensions . . . and fast installation.

First chance you get, watch one of these installations. See for yourself how ductile Monel tie wire is, how easily workers thread it into position, then bend and twist it to a snug fit. There's no breakage, no waste.

Notice, too, that nothing flakes off when Monel tie wires or brick anchors are bent. That's because Monel is *solid* metal. It has no coating, no surface protection of any kind. And it needs none, because it cannot rust. Corrosion-resistant all the way through, Monel stands up against the action of alkalis, salts and acids in plaster, lime and other materials. *Wet plaster, between-wall condensation and lime-bearing seepage make no headway against Monel.*

## SECURING FACADES

Ceramic Veneer exterior of Pacific Telephone and Telegraph Co. building, Oakland, Cal., is anchored to wall with 3/16" dia. soft temper Monel wire. Architects: Harry A. Thomsen, Aleck L. Wilson, San Francisco. General contractor: Dinwiddie Construction Co., San Francisco. Ceramic Veneer is a machine made terra cotta, available in colorful, economical exteriors.

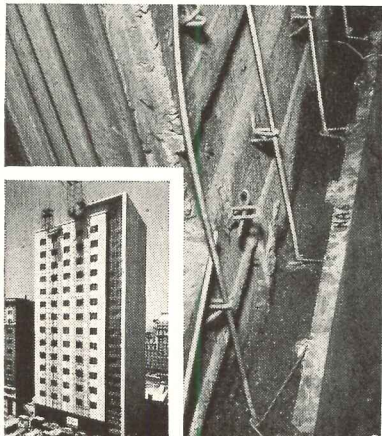

Suggested specifications for most of the common uses of Monel tie wire have been put into a convenient "file size" folder that is yours for the asking. Write today for your copy of *Monel Tie Wire*. With it, we'll also send actual samples of Monel tie wire and another versatile material, Inco's Monel Roofing Sheet.

THE INTERNATIONAL NICKEL COMPANY, INC. EMBLEM OF SERVICE  
67 Wall Street, New York 5, N. Y.



**MONEL®**...for the life of the building



To the casual observer it looks like one big, beautiful floor . . . exactly as it was meant to look. Actually, the floor in and surrounding the food serving area is Thos. Moulding Chemproof . . . a special floor that laughs off food spillage and frequent, severe cleaning. The remainder of this big McCrory store is floored with Thos. Moulding Moultilite, in matching colors and design.

This installation shows again how aptly Thos. Moulding Floors lend themselves to satisfying functional as well as artistic requirements. Incidentally, this smooth expanse of floor rests on a sound foundation of Thos. Moulding Asphaltcrete, applied to the rough cement subfloor. Asphaltcrete, one of Thos. Moulding's four famous underlayments, was specially developed to prepare cement subfloors at moderate cost for the application of all types of floor coverings.

Architects are invited to consult with Thos. Moulding about the special requirements of any project. Frequently the right floor is already at hand . . . among the wide range of Thos. Moulding Floor Materials. Or, where necessary, standard materials can be modified as needed. Close production control, under laboratory guidance, provides materials with characteristics to meet virtually all specifications. Likewise, special or matched colors can be supplied. See Thos. Moulding's listing in Sweet's . . . or write for catalog to:

**THOS. MOULDING FLOOR MFG. CO.**

165 W. Wacker Drive, Dept. AR-1, Chicago 1, Ill.

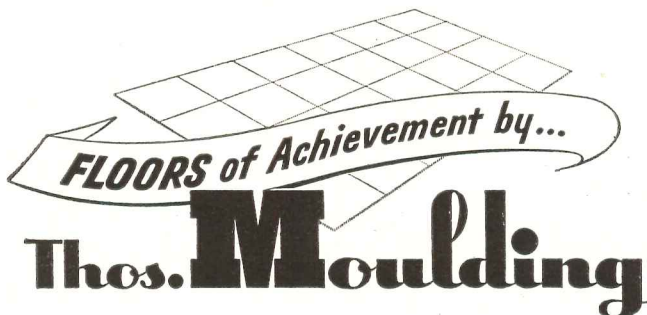

**EMPLOYMENT OPPORTUNITIES AVAILABLE**

*Advertising rates on request*

**Positions Open**

**ARCHITECTURAL, ELECTRICAL, MECHANICAL, STRUCTURAL:** men for immediate permanent employment in drafting room positions as job captains and squad leaders. Do not apply unless well qualified for work on building construction. State schooling, experience and salary expected. Leo A. Daly Co., 633 Insurance Bldg., Omaha, Nebr.

**ARCHITECTURAL DESIGNER:** Capable handling complete planning project housing, institutional and industrial work. Send full particulars P.O. Box 2192, Atlanta 1, Ga.

**ARCHITECT (1) — ENGINEER (1):** Two men to be trained by manufacturer of outstanding thermal and vapor insulation for office in N. Y. C. metropolitan area. Good typist and letter-writer preferred. State details, including age, education, experience, starting salary. Box 453, *Architectural Record*, 119 W. 40th St., New York 18.

**SPECIFICATION WRITER:** Must be experienced in writing Specifications covering architectural, structural, mechanical and electrical work for commercial, industrial, institutional and public buildings. Permanent work for qualified man. In applying, state experience, age and salary required. George L. Dahl, Architects & Engineers, 2101 North St. Paul Street, Dallas, Texas.

**WANTED:** Architect, about 45, experienced in small residences and large institutional and commercial buildings. Permanent position. Work involves preparation of drawings and copy for publications. Ability to direct work of draftsmen essential. State education, experience and salary expected. Midwest location. Box 454, *Architectural Record*, 119 W. 40th St., New York 18.

**MAJOR FOOD CORPORATION:** has excellent permanent opportunity for young Assistant Architectural Engineer. Five years education and/or practical experience in preparation of architectural plans for industrial buildings. Some experience in or aptitude for construction supervision. Write, giving full details to Box 456, *Architectural Record*, 119 W. 40th St., New York 18.

**ARCHITECTURAL CONSULTANT:** Nationally known catalog service organization seeks professionally trained young architect. Building materials specifying, sales and marketing knowledge desirable. Give full details of personal and business history. Box 457, *Architectural Record*, 119 W. 40th St., New York 18.

**Positions Sought**

**ARCHITECT DESIGNER:** Interested in partnership possibility in the West. 20 years' experience. 5 years' private practice in area of stagnant economy. Strong contemporary designer with historical training. Detailed plans, specifications, supervision. 2 degrees at leading university. Pleasing personality, drive and initiative. Active in organizations. Age 40. Box 458, *Architectural Record*, 119 W. 40th St., New York 18.

**ARCHITECT-ENGINEER WILL DESIGN PROJECTS:** to acceptance, at Chicago, or in your office anywhere in U. S. Registered. 25 years experience — all types and classes of medium or large size projects — power plants, factories, schools, hospitals, etc. Sketches, perspectives, engineering, working drawings, specifications. Fee, or hourly basis, or associate. Fred W. Langhenrich, 4541 Washington Blvd., Chicago 24, Ill.

for appearance...



*Simple, unobtrusive design  
blends with any architectural treatment.*

for performance



*Adjustment features insure  
positive control of air movement.*

**Kno-Draft**

*... adjustable air diffusers  
help solve problems  
of both form and function.*

**FREE HANDBOOK**—Send for FREE copy of new handbook on air diffusion. Complete information on Kno-Draft Adjustable Diffusers and all necessary engineering data to help you create "custom-made" air patterns. Just fill in and mail the coupon.

**W. B. CONNOR ENGINEERING CORP.**

*Air Diffusion • Air Purification • Air Recovery*

112 East 32nd Street  New York 16, N. Y.

IN CANADA: Douglas Engineering Co., Ltd., 190 Murray Street, Montreal 3, P. Q.

**W. B. CONNOR ENGINEERING CORP.**

Dept S-21, 112 East 32nd Street, New York 16, New York

Please send my FREE copy of the new Kno-Draft Handbook on Adjustable Diffusers.

Name.....

Position.....

Company.....

Street.....

City..... Zone..... State.....

# PARKWOOD

*Decorative*

**SPECIFIED**



Employees' Cafeteria

## NEW John Hancock Building

PARKWOOD DECORATIVE was specified by the John Hancock Insurance Co., and their decorators, for all genuine wood veneer plastic table tops used in their huge, modern employee cafeteria. Daily, 3,800 people lunch here in just 2½ hours — mute evidence of the sanitary and indestructible qualities of PARKWOOD DECORATIVE.

### many diverse applications

The John Hancock Building contains hundreds of PARKWOOD DECORATIVE genuine wood veneer plastic table tops of diverse woods for use in executive committee rooms, dining rooms, employees' recreation and lounge rooms, as well as for restaurant and library counter tops.



IF YOUR REQUIREMENT  
IS BEAUTY AND DUTY...

specify

PARKWOOD *Decorative*

**For beauty**, PARKWOOD DECORATIVE offers a wide variety of genuine wood veneers . . . plus the new three-dimensional patterns, PARKWOOD Pebble-Tex and Stardust — in an attractive range of beautiful colors.

**For duty**, these beautiful laminated plastic table tops wear indefinitely and are resistant to alcohol, fruit juices, cigarette burns and the usual cleaning chemicals. With PARKWOOD there's no replacement problem!

See Our Full-Color Catalogue Sheets  
in Sweet's 1950 — Index 14A-8

SEND NOW—FOR OUR BEAUTIFUL KODACHROME BROCHURE



**Parkwood Corporation**

21 Water St., Wakefield, Massachusetts

DON'T LET "TRADITION"

*Double* YOUR HEATING INVESTMENT

**DRAVO Counterflo HEATERS**  
CUT SYSTEM COSTS and FUEL COSTS!

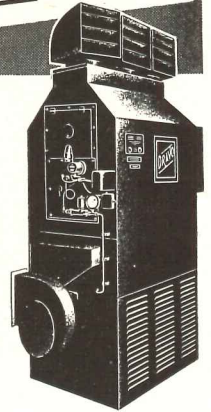

Users have saved 50 to 66% of traditional wet system costs by installing Dravo direct-air Counterflo Heaters in buildings with large open areas like showrooms, warehouses, garages, hangars, etc. No boilers or extensive piping; easy to install; burn gas or oil or both; automatic operation; thousands of successful installations. Ask for Bulletin AF-523

**DRAVO** CORPORATION

DRAVO BUILDING, PITTSBURGH 22, PA.

Sales Representatives in Principal Cities

Mfd. and Sold in Canada by Marine Industries, Ltd., Sorel, Quebec



*This grille design is*

**CHEVRONS**

one of the hundred distinctive designs in the famous Hendrick line.

Many of these designs were originally developed, according to an architect's specifications, to harmonize with the decorative scheme for some outstanding public building or residence. They are now available as standard numbers.

Fabricated in heavy-gauge aluminum, bronze, copper, Monel, steel or stainless steel. Write for full information.



Perforated Metals  
Perforated Metal Screens  
Architectural Grilles  
Mitco Open Steel Flooring,  
"Shur-Site" Treads and  
Armorgrids

**HENDRICK**  
*Manufacturing Company*

38 DUNDAFF STREET, CARBONDALE, PA.  
Sales Offices in Principal Cities





adapted from  
"TRANSFLUENT LINES"  
by I. Rice Pereira

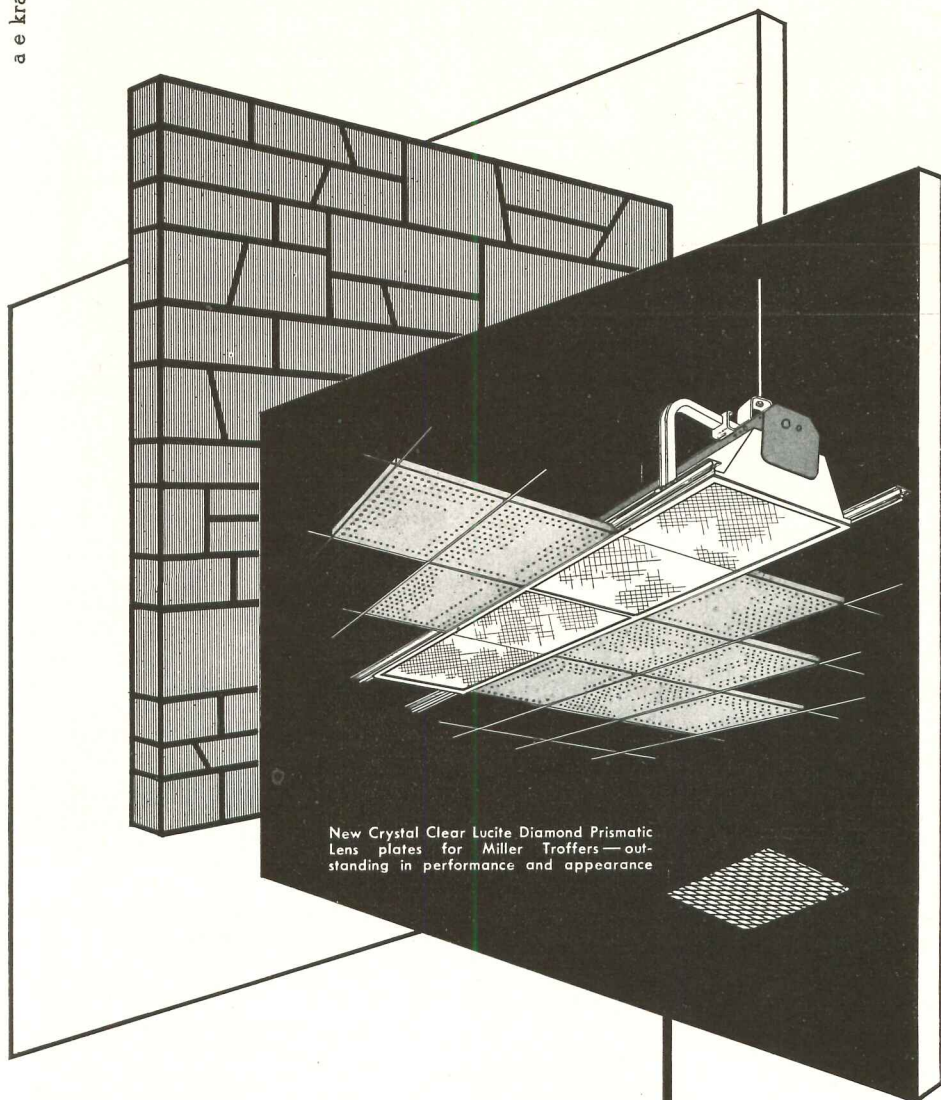

New Crystal Clear Lucite Diamond Prismatic Lens plates for Miller Troffers—outstanding in performance and appearance

Lighting becomes a structural element with MILLER FLUORESCENT TROFFER LIGHTING SYSTEMS. Their high lighting efficiency and flexibility of application gives the architect limitless opportunity for ceiling design — CEILING UNLIMITED\* — to achieve architectural harmony and individual distinction of interiors. A BIG PLUS VALUE in lighting! And there's the ease of installation — and the low maintenance cost — which contribute to the low over-all cost of Miller Troffers. It all adds up to COMPLETE LIGHTING SATISFACTION. Satisfaction with performance. Satisfaction with appearance. Satisfaction with lighting dollars wisely invested.

Miller Lighting Service is nation-wide. Miller engineers and distributors are conveniently located. Write for our brochure — "CEILING UNLIMITED".

**Lighting becomes a structural element**

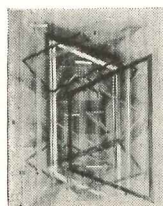

A painting illustrated in "PAINTING TOWARD ARCHITECTURE" the book about THE MILLER COMPANY'S collection of abstract paintings related to Architecture. Available at leading book stores

\*Reg. U.S. Pat. Off.

**THE miller COMPANY**  
SINCE 1844  
ILLUMINATING DIVISION, MERIDEN, CONNECTICUT

ILLUMINATING DIVISION: Fluorescent, Incandescent, Mercury Lighting Equipment; HEATING PRODUCTS DIVISION: Domestic Oil Burners and Liquid Fuel Devices; ROLLING MILL DIVISION: Phosphor Bronze and Brass in Sheets, Strips and Rolls

# R<sub>X</sub> for Flat Top Buildings

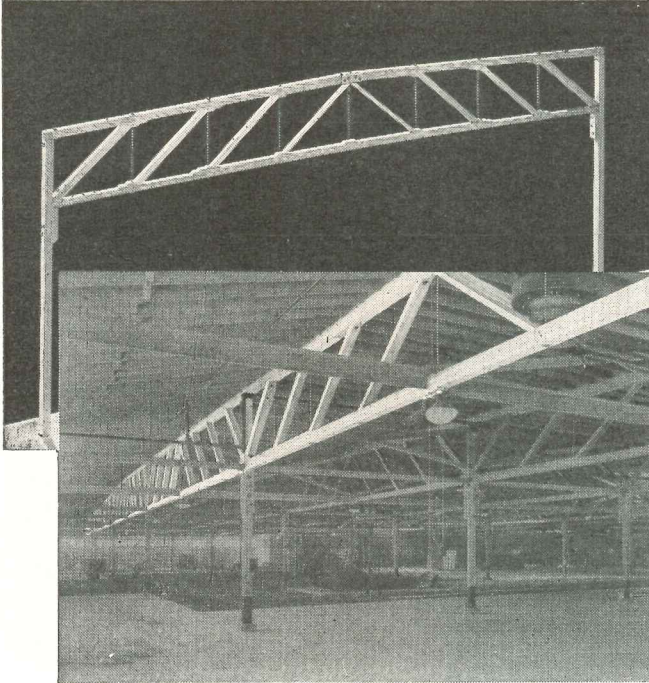

**U**nobstructed floor space, attractive appearance and maintenance-free construction are provided for buildings of nominal roof drainage by the Tim-Flat truss.

Available in spans from 40 to 100 feet and longer this truss has solid glued laminated chords of fire resistive dimensions. Material for chords is kiln dried before lamination, and will not shrink, warp, twist or check. Camber is retained without maintenance. No re-tightening of bolts is required. Length of chords is limited only by shipping requirements. Cross section of chords is graduated to develop required stress without needlessly increasing weight.

Thrust pads of proper depth and shear area are welded permanently to chords where helpful to economically develop end reactions of diagonal members. This truss develops for the first time in timber construction certain design advantages previously available only in competing materials.

### FOR BUILDINGS OF ANY WIDTH

The Tim-Flat truss is frequently used for multiple span buildings, with columns extending through to the top chords, and with vertical loads supported on corbels. To minimize height of parapet walls, roof line at the outside of the building frequently follows the end diagonal member.

Your nearest Timber Structures office will gladly give you detailed information about the Tim-Flat truss. Or write direct to us for literature and data.

## TIMBER STRUCTURES, INC.

P.O. BOX 3782-A, PORTLAND 8, OREGON

Offices in Boise, Idaho; Eugene, Oregon; Lawrenceville, N.J.; Chicago; Dallas; Kansas City; New York; Seattle; Spokane

TIMBER STRUCTURES, INC. OF CALIFORNIA • Oakland and Sacramento  
Local representatives coast to coast.

WHY ARCHITECTS, DESIGNERS,  
DRAFTSMEN & ENGINEERS PREFER  
*Mars* LUMOGRAPH

The ONLY Drawing Pencil  
that Combines these 8  
Tests of Pencil Superiority

1. America's ONLY imported drawing pencil.
2. Extra-dense, opaque lead.
3. Smudge-resistant graphite.
4. Completely grit-free.
5. Uniform lead hardness.
6. Perfect reproductions from pencil drawings.
7. Degrees marked on all sides.
8. Aged cedar, sharpens easily.

TRADITION CHROMA Colored Pencils—Mars-Lumograph's companion pencil in color is returning soon.

Demand the best—Mars-Lumograph  
#2886 Drawing Pencil, \$1.50 doz.  
#1018 Artist Pencil, \$1.00 ea.  
#1904 Artist Leads, 60c bx.



J. S. STAETLER INC.

53 WORTH STREET NEW YORK 13, N.Y.  
STAETLER SINCE 1662

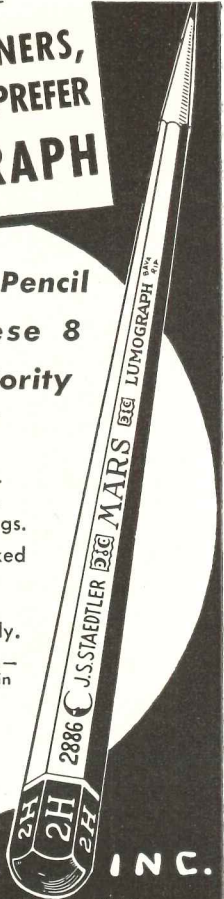

SUSPENSION UNIT ...

*Oil or Gas!*

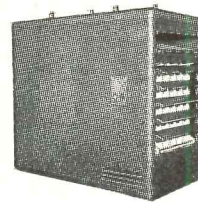

WITH AN OUTSTANDING LINE OF BOTH OIL AND GAS-FIRED SUSPENSION TYPE HEATERS, J-C COVERS THE FIELD WITH THIS INCREASINGLY POPULAR TYPE OF FURNACE.

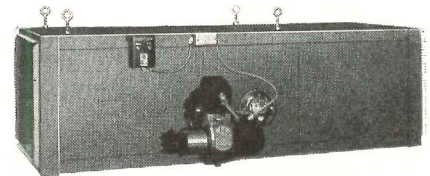

J-C GAS-FIRED SUSPENSION UNITS, fan or blower operated, have outputs of 68,000 to 172,000 BTU. Designed and built for performance and long life, the J-C gas fired suspension heater is ideal for heating, ventilating ... for residential, commercial and industrial applications.

J-C OIL-FIRED SUSPENSION UNITS have outputs of 112,000 to 450,000 BTU. An efficient heater requiring less space than any furnace of its type and rating. Units feature greater heating efficiency with less heating surface ... due to an exclusive design of ducts and baffles. Ease of installation is a feature—and ready access facilitates servicing.



... AMERICA'S LARGEST AND MOST COMPLETE WARM AIR HEATING LINE ...



A PRODUCT OF  
JACKSON & CHURCH COMPANY, SAGINAW, MICHIGAN  
WORK WELL DONE SINCE '81



## It makes disturbing noises whisper

**W**HETHER your client is planning a new office building, a theater, a hospital, a restaurant—or, for that matter, any structure in which sound is a factor—he'll want it to be relatively free from distracting and disturbing noises.

Fiberglas\* acoustical materials will make those noises whisper.

Fiberglas Acoustical Tile is well-known for its fire-safety.† That's why it is found in so many

public places. And architects also know that its dimensional stability permits acoustical treatment in extremely humid areas—without worrying about warping and rotting.

But, most important, Fiberglas acoustical materials combine beauty with exceptionally high sound absorbing efficiency—up to 85%. Your clients know that with Fiberglas noises will be whispers forever.

†Rated Incombustible under Fed. Spec. SS-A-118a.



\*FIBERGLAS is the trade-mark (Reg. U. S. Pat. Off.) of Owens-Corning Fiberglas Corporation for a variety of products made of or with glass fibers.

OWENS-CORNING FIBERGLAS CORPORATION, DEPT. 67A, TOLEDO 1, OHIO



**You can make it  
easy for your  
client to set up  
A SCHOOL PROGRAM SCHEDULE  
IN 3 OR 4 MINUTES!**

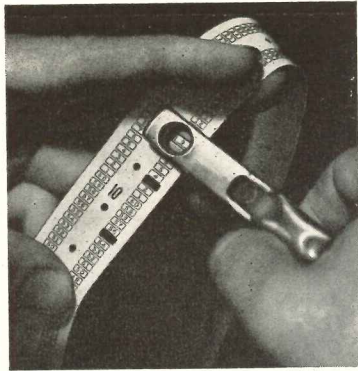

Today the school has more of everything *except time!*  
Standard Synchronous Master-Program Controller and Clock System *saves* time. Paper tapes plainly marked in hours and minutes can be punched and installed in a very few minutes and will last for years. Any signal can easily be placed in any schedule desired by simply changing the position of its plug on the bell control board.  
Bulletins and complete engineering service are available to architects.



**SYNCHRONOUS PROGRAM CONTROLLER  
AND CLOCK SYSTEM**  
The Standard Electric Time Co.

81 LOGAN STREET • SPRINGFIELD, MASS.

**Here's Your  
GUIDE TO BETTER LIGHTING**

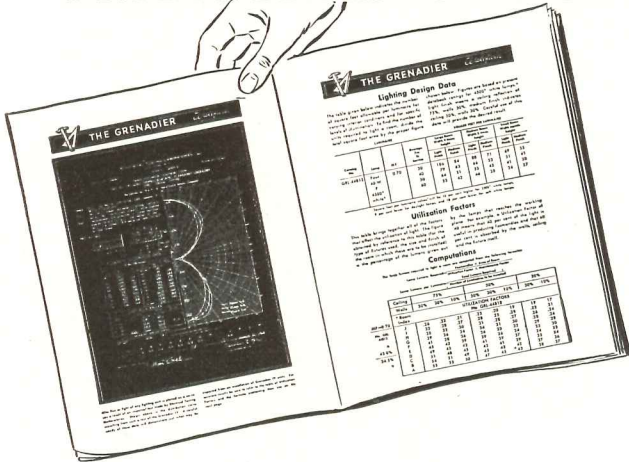

A factually written, fully illustrated 36-page catalog showing the complete Wakefield line of fluorescent and incandescent lighting equipment—with photographs, working drawings, design data and distribution curves. Write for your copy today.

THE F. W. *Wakefield* BRASS COMPANY  
VERMILION, OHIO

**Insist  
on this  
Seal...**



**when you specify  
ALUMINUM  
WINDOWS**

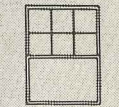

DOUBLE-HUNG



CASEMENT



PROJECTED

This seal assures windows that, when tested by the independent Pittsburgh Testing Laboratory, meet the A.W.M.A. quality specifications for materials, construction, strength of sections, and minimum air infiltration requirements.

For complete specs covering "Quality-Approved" aluminum windows—double-hung, casement and projected—and names of approved manufacturers, consult Sweet's or write to the address below, Dept. R.

ALUMINUM WINDOW MANUFACTURERS ASSOCIATION  
209 Cedar Avenue, Takoma Park, Washington 12, D. C.

**SPEED CONSTRUCTION,  
REDUCE COST  
WITH ZONOLITE\* VERMICULITE PLASTER**



**LIGHTWEIGHT**  
sticks better,  
fewer droppings



**NOT BRITTLE**  
absorbs shock  
and impact



**LESS SETTLEMENT**  
eliminates source  
of many cracks

**Only ZONOLITE Plaster Gives ALL  
These Extra Advantages:**

- Three times lighter than ordinary plaster.
- Four times more fire resistant than ordinary plaster.
- Resists chipping and cracking.
- Fireproofs steel columns, beams, etc.
- Applies easier—less tiring to workmen.
- Ends plasterer's biggest headache—the frozen sand pile.

For FREE information about Zonolite Plaster, write to Dept. AR-10.



**ZONOLITE COMPANY**  
135 South LaSalle Street  
Chicago 3, Ill.

\*Zonolite is a registered trademark of Zonolite Company



## They all add up

Whenever you're in the market for equipment that will do things to temperatures, chances are there is a combination of Trane products that will meet your needs.

Your temperature problem may be associated with human comfort or industrial process; with solids, liquids, or gases. You may want temperatures high for heating or temperatures low for cooling, in home, commerce, or industry.

Select the individual items you need for your particular temperature problem, and you'll find they all add up to an efficient, smoothly operating system.

That's because all Trane products fit into a definite, sharply defined pattern. They are all designed together and built together for use together.

This unified line of interrelated products makes us an organization of specialists. Our 2000 workers in factory and field devote all their time to the production

and application of equipment for heating, air conditioning, and other forms of heat exchange.

When the Trane Development Committee evaluates proposed new products, decisions are based not merely on "would it be profitable" but, rather, on "does it fit the Trane pattern?"

In other words, *does it add up?*

This sort of specialization has been going on for years and years and years. Trane and Temperature are becoming synonymous. It's good for us, and good for you, too. We'll prove it—at the drop of a postcard.

**THE TRANE COMPANY... LA CROSSE, WIS.**  
 EASTERN MANUFACTURING DIVISION, SCRANTON, PA.  
 Manufacturing Engineers of Heating, Ventilating and Air Conditioning Equipment—Unit Heaters, Convector-radiators, Heating and Cooling Coils, Fans, Compressors, Air Conditioners, Unit Ventilators, Special Heat Exchange Equipment, Steam and Hot Water Heating Specialties  
 ... IN CANADA, TRANE COMPANY OF CANADA, LTD., TORONTO.

Multi-Zone Air Conditioners  
 Self Cont. Air Conditioners  
 Custom-Air Conditioners  
 UniTrane Air Conditioning  
 Climate Changers  
 Brazed Aluminum Heat Exch.  
 Convectors  
 Cooling Coils  
 Heating Coils  
 Evaporative Condensers

Evaporative Coolers  
 Centrifugal Fans  
 Propeller Fans  
 Hot Water Specialties  
 Circulating Pumps  
 Booster Pumps  
 Condensation Pumps  
 Turbo Vacuum Compressors  
 Compressor Units  
 Condensing Units

Dry Expansion Chillers  
 Shell & Tube Heat Exchangers  
 Steam Heating Specialties  
 Railway Air Conditioning  
 Railway Heating Systems  
 Bus Air Conditioning  
 Bus Heating Systems  
 Propeller Unit Heaters  
 Blower Type Unit Heaters  
 Unit Ventilators

Roof Ventilators  
 Wall Fin Heaters  
 Product Coolers  
 Radio Tube Coolers  
 Air Washers  
 Fluid Coolers  
 Diesel Engine Coolers  
 Dry Condensers  
 Transformer Oil Coolers  
 Process Heat Exchangers

**NEW LOW GLAZING COSTS!  
NEW HIGH GLAZING QUALITY!**



**Requires No Painting**

**Aluminum  
Windows  
Steel or Wood  
Windows**

- Specify Tremglaze Aluminum color. It bonds to aluminum, requires no painting—ever. Proven on actual jobs for over ten years. Meets Aluminum Window Manufacturers Association standards.
- Specify Tremglaze yet pay no more for completed window installations than with a putty job. Save on the paint contract; specify—"Paint first—then Tremglaze". Put paint on the *window* where it belongs—Tremglaze requires no paint. Save on cost of cleaning glass also.

NC-102

Consult your local Tremco Representative or write to:  
**THE TREMCO MANUFACTURING CO.**  
CLEVELAND 4 • TORONTO

*Recognized Everywhere!*

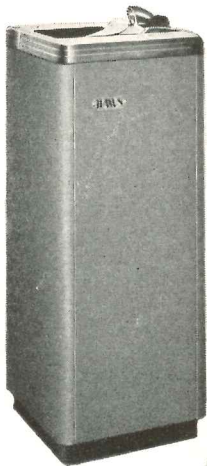

- Best Materials
  - Finest Workmanship
  - Trouble-free Valves and Fittings
  - Complete Sanitation
- Specify HAWS—and be sure!

**IT'S HAWS FOR HIGHEST QUALITY**

Write today for '49 HAWS Catalog.

**HAWS** SANITARY DRINKING FOUNTAINS  
ELECTRIC WATER COOLERS

**HAWS DRINKING FAUCET CO.**  
1441 FOURTH STREET (Since 1909) BERKELEY 10, CALIFORNIA  
Agents and Sales Representatives in All Principal Cities

**INVESTIGATE!  
GET THE FACTS!**

**SAVE MONEY AND SPACE**

**AGTAIR<sup>®</sup>  
AIR and GREASE  
FILTERS**

**Highest Efficiency!  
Lowest Cost!**

**Convince Yourself —  
Write for Bulletin FM101-2**

**AIR DEVICES, Inc.**  
17 East 42nd St. • New York 17, N. Y.

Architects, Builders, Contractors!

**ELECTRIC  
Radiant  
HEAT....**

Architect Paul Thiry

... is the answer to economical apartment **HEATING** ... Roberson HEATSUM CABLE recently installed in the ceiling of this modern Seattle apartment house makes the fourth radiant heated McCaul Apartment. Electric radiant heating is praised by apartment owners because it makes it possible for each tenant to control and pay for his own heat; it is so clean that redecorating is required only half as frequently, and it compares favorably in operating cost with other types of heating in most areas. On that next job specify ROBERSON HEATSUM CABLE.

Send for **FREE** illustrated folder

**L. N. ROBERSON CO.**  
1539 East 103rd Street      Seattle 55, Washington

An outspoken  
message from  
America's greatest  
living architect:

FRANK LLOYD WRIGHT

# "GENIUS AND THE MOBOCRACY"

Illustrated With Thirty-Nine Never Before Published Drawings  
by Louis H. Sullivan

"Genius And The Mobocracy" is both a lusty diatribe against everything architectural Frank Lloyd Wright hates, and an eloquent plea for the re-establishment of organic architecture. It's an angry book. Yet a deeply tender one. For interwoven among one of the most vitriolic attacks on sham ever written is the enchanting story of Wright's professional and personal relationship with his gifted teacher, Louis H. Sullivan.

In the words of the author: "I have tried to describe the tragedy, triumph and significance of the great man who invariably signed himself Louis H. Sullivan; to tell you why I, though never his disciple—nor that of any man—called him Lieber Meister."

**The Man Everyone Knows . . .  
But Few Understand**

Anybody as iconoclastic as Frank Lloyd Wright is bound to stir controversy; certainly this book will create a maelstrom in the minds of professional and lay readers alike. His admirers will be spell-bound, his enemies outraged. But only the most narrow-gauged person could read "Genius and The Mobocracy" without discovering and enjoying the majestic quality of Wright's mind.

Wright traces the sweep of architecture from its earliest history to the latter Greeks and Romans—through the Middle Ages and subsequent Renaissance—down to modern times. He is unhappy with its genesis. But the book has infinitely more than expert criticism to recommend it. It has faith, spirited advice—and throughout—the compelling, human story of an American genius, Louis H. Sullivan.

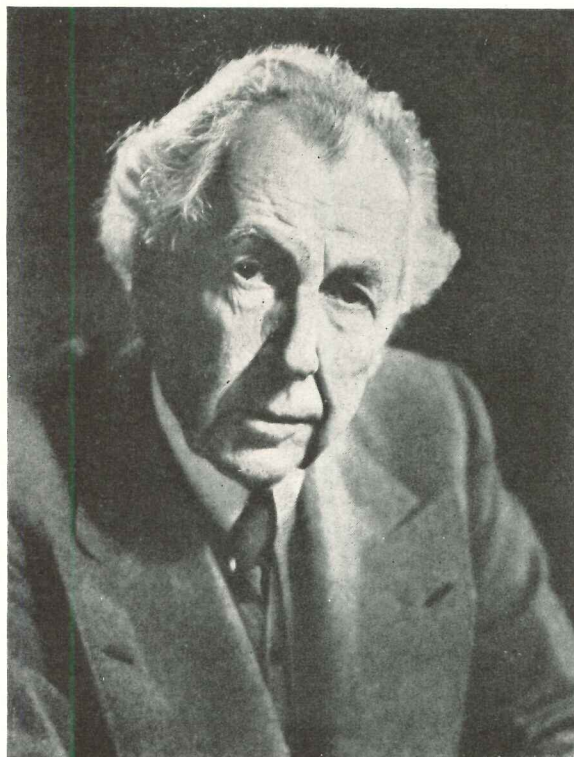

## Acclaimed by Critics

Frederick Gutheim, *N. Y. Herald Tribune*

"The present work establishes even more clearly than his remarkable 'Autobiography' the deep romanticism of Frank Lloyd Wright that has found expression in his life and his writings as well as in his work as an architect."

Talbot Hamlin, *New York Times*

"When the greatest living architect . . . writes a serious book dealing with another great architect and artist who influenced him deeply, it behooves us all to attend, to listen carefully and critically."

*Architectural Forum*

"In his new book, 'Genius and the Mobocracy,' Wright . . . has succeeded in producing a cultural document whose importance transcends the field of architecture. . . ."

## Other Books by or about Frank Lloyd Wright

AN AUTOBIOGRAPHY  
by Frank Lloyd Wright

When this now-famous book was first published, in 1932, Lewis Mumford wrote: "No autobiography on this level has appeared since 'The Education of Henry Adams.' . . . Mr. Wright's book is a literary act that compares in brilliance and originality with his building." . . . \$6.00

ON ARCHITECTURE  
edited by Frederick Gutheim

The selected writings of Frank Lloyd Wright from the period 1894 to 1940, containing both published and unpublished material. It forms a keybook and sourcebook to the ideals and to the technical and aesthetic development of the architect. . . . \$6.00

IN THE NATURE OF  
MATERIALS

by Henry-Russell Hitchcock

A study of Wright's designs and buildings from 1887 to 1941 by 'America's foremost architectural critic.' Included are illustrations of more than 100 buildings, with accompanying technical discussion, a critical and historical introduction, and an appendix listing all the executed buildings and projects of the architect. . . . \$6.75

Book Department Architectural Record  
119 West 40th Street, New York 18, N. Y.

Enclosed is \$\_\_\_\_\_ for:

- \_\_\_copies of "Genius and The Mobocracy" at \$5.00 a copy
- \_\_\_copies of "An Autobiography" at \$6.00 a copy
- \_\_\_copies of "On Architecture" at \$6.00 a copy
- \_\_\_copies of "In The Nature of Materials" at \$6.75 a copy (add 2% for N. Y. C. delivery)

Name \_\_\_\_\_

Address \_\_\_\_\_

City \_\_\_\_\_

Zone \_\_\_\_\_ State \_\_\_\_\_

**Use Coupon To Send For  
Your Copy Today**

"Architectural Record" feels so keenly the importance of Mr. Wright's new book that it has made a special arrangement with the publishers whereby you may obtain a copy conveniently of this and other books by or about Frank Lloyd Wright simply by sending in the coupon at right.

# Creative Hands

use

## PHOTO MURALS

WEST-DEMPSTER CO.  
100 West Lyon St.  
Grand Rapids 2, Mich.

# when the call is for CONTROLS

you'll find the answer **HERE**

**Bigger, Better, General Controls Catalog now ready—reserve your copy today.**

104 pages covering the *complete* General Controls line of Automatic Pressure, Temperature, Level and Flow controls. It charts, tabulates and details, capacities, pressures, dimensions and specifications of hundreds of controls. Whatever the product or process—in heating, refrigeration, aircraft or industry, there's a *better* General Control for the job. General Controls *do* more and cost *less*. The new Catalog tells how and why. Send for your copy today.

**GENERAL CONTROLS**  
800 Allen Ave., Glendale 1, Calif.

## GENERAL CONTROLS

Automatic Pressure, Temperature, Level and Flow Controls

FACTORY BRANCHES: Baltimore (5), Birmingham (3), Boston (16), Buffalo (3), Chicago (5), Cincinnati (2), Cleveland (15), Dallas (1), Denver (4), Detroit (8), Glendale (1), Houston (6), Kansas City (2), New York (17), Minneapolis (2), Philadelphia (40), Pittsburgh (22), San Francisco (7), Seattle (1), St. Louis (12), Tulsa (6).

DISTRIBUTORS IN PRINCIPAL CITIES.

# FITZGIBBONS

"The best in steel boiler heat"

FITZGIBBONS BOILER CO., INC. NEW YORK, N. Y.

FITZGIBBONS BOILER CO., INC. NEW YORK, N. Y.

**A. S. M. E. code constructed**

**Hydrostatically tested**

**Hartford insurance inspected**

**S. B. I. code rated**

Residential and commercial steel boilers in sizes from the small home to the largest structure.

**MOST ECONOMICAL IN FUEL**  
THE FITZGIBBONS BOILER  
1886

Fitzgibbons Boiler Company, Inc. 101 PARK AVE. NEW YORK 17, N. Y.

"The first important manual in a generation on . . ."

## "Hospital Planning"

by Charles Butler, F.A.I.A. and Addison Erdman, A.I.A.

"Hospital Planning" features the new and unprecedented facilities demanded by revolutionary new techniques in hospitalization. It poses actual problems and shows how they were solved.

Here is an exhaustive analysis of the most striking features of 51 modern hospitals—representing the work of 30 celebrated architects—culminating in hundreds of case histories of ideas proved exceptionally successful.

Illustrating the clear, simple text are 32 photographs, 11 site plans, 187 floor plans, and 38 special unit plans of rooms, wards, department and numerous construction details. 232 pages, 9½ x 11. Stiff cloth binding. Thoroughly indexed.

Architectural Record Book Department  
119 West 40th Street, New York 18, N. Y.

Enter my order for . . . copies of "Hospital Planning," by Charles Butler and Addison Erdman @ \$15.00 a copy. I enclose \$ . . . . .

(for New York City delivery add 30c for sales tax—\$15.30 in all.)

Name.....

Address.....

City..... Zone..... State.....

**\$125,000,000**

This is the staggering potential made available for hospital construction by the federal Housing Survey and Construction Act.

**START NOW!**





TRUSCON

*Intermediate*  
CLASSROOM  
WINDOWS

new daylight  
effectiveness...

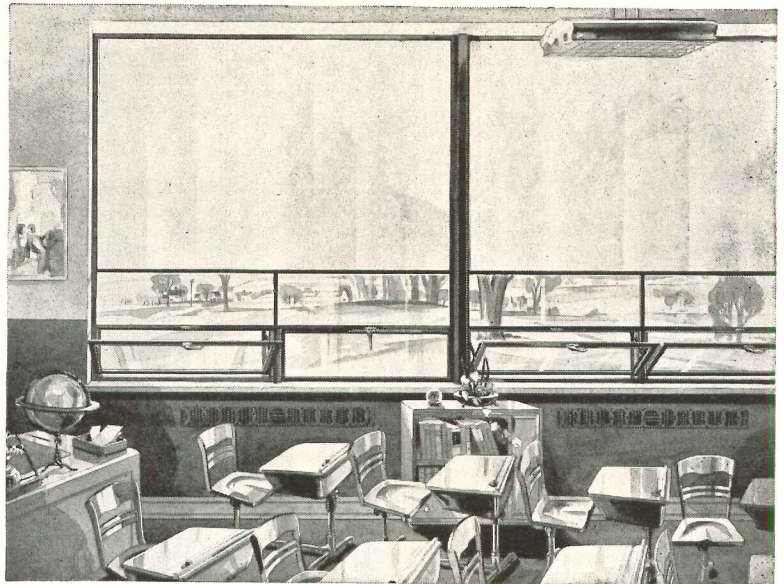

*Truscon Intermediate Classroom Windows are custom built in integral units with widths up to 10'-0" and in heights up to 9'-0". They are fabricated, bonderized and painted to the same exacting specifications as the time tested standard line of Truscon Intermediate Windows.*

*new classroom efficiency*

This is the newest development in Truscon light-and-ventilation engineering for classroom use! Point for point, the Truscon Classroom Intermediate Window offers *greater flexibility, greater and more efficient use of Nature's free sunlight and fresh air, and greater simplicity of maintenance* than any other type of classroom window. Note: Upper light of efficient diffusing pattern glass. Lower light clear. Alternate opportunities: insulating (double) glass, heat absorbing glass, or non-glare glass. Glass is installed from the interior side. Choice of glazing completely adaptable to geographical location, climatic conditions, degree of exposure. Ventilators can be installed in both lower and upper glass panels of vision strip if desired. Important feature is marked economy in original cost. Also superior maintenance from standpoint of window washing and glass replacement. Write for free illustrated literature giving complete details on this Truscon window innovation!



Manufacturers of a Complete Line of Steel Windows and Mechanical Operators . . . Steel Joists . . . Metal Lath . . . Steel-deck Roofs . . . Reinforcing Steel . . . Industrial and Hangar Steel Doors . . . Bank Vault Reinforcing . . . Radio Towers . . . Bridge Floors.

**TRUSCON STEEL COMPANY**

Subsidiary of Republic Steel Corporation

YOUNGSTOWN 1, OHIO

Warehouses and sales offices in principal cities

# INDEX TO ADVERTISEMENTS

ab	Accurate Metal Weatherstrip Co., Inc.	164
abe	Adam, Frank Electric Co.	49
a	Adams-Rite Mfg. Co.	176
a	Adams & Westlake Company	126
	Aerofin Corporation	153
	Air Devices, Inc.	208
a	Airlamp Div.	13
	Alan Wood Steel Company	136
a	Allegheny Ludlum Steel Corp.	171
a	Aluminum Window Manufacturers Assn.	206
ae	American Abrasive Metals Co.	150
	American-Olean Tile Company	6-7
ae	American Structural Products Co.	145
a	American Tile & Rubber Company	22
	Architectural Record	180-181
ae	Armstrong Cork Company	33-34
ae	Arrow-Hart & Hegeman Electric Co.	16
ae	Barber-Colman Company	151
	Benjamin Electric Mfg. Co.	138
	Better Homes Competition	167
a	Bethlehem Steel Company	40
	Books	178-188-192-209-210
a	Brasco Manufacturing Co.	125
ab	Bruce, E. L. Co.	53
ae	Burt Mfg. Co.	146
	Byers, A. M. Co.	4
ab	Cabot, Samuel, Inc.	132
a	Cannon Electric	170
ae	Carrier Corporation	38
	Case, W. A. & Son Mfg. Co.	3rd Cover
ab	Ceco Steel Products Corp.	2-3
abe	Celotex Corporation	58
	Chicago Tribune	167
a	Chrysler Corp.	13
ab	Church, C. F. Mfg. Co.	169
a	Columbia Mills, Inc.	64
	Committee on Steel Pipe Research	190
	Combustion Equipment Division	170-176
ab	Connor Lumber & Land Co.	147
	Connor W. B. Engineering Corp.	201
	Corning Glass Works	197
b	Crane Co.	175
	Crucible Steel Co. of America	187
a	Cutler Mail Chute Co.	198
a	Day-Brite Lighting, Inc.	161
abe	Detroit Steel Products Company	133-179
ae	Dravo Corporation	202
a	Ellison Bronze Co.	134
	Employment Opportunities	200
	Faber, A. W. Castell Pencil Co., Inc.	198
e	Fedders-Quigan Corporation	59
	Federal Seaboard Terra Cotta Corp.	195
a	Fitzgibbons Boiler Company	210
abe	Flintkote Company	2nd Cover
abe	Flynn, Michael Manufacturing Co.	130-131
a	Formica Insulation	214
	Frick Company	196
ab	Frigidaire Division	135
	General Controls	210
ae	General Electric - Wiring	182
ab	General Motors Co.	135
a	General Portland Cement Co.	183
a	Globe Hoist Company	172
	Granite City Steel Company	30
	Graybar Electric Co.	54-55
	Guth, Edwin F. Company	148

a	Hall-Mack Company	144
ae	Hart & Hegeman Division	16
ae	Hauserman, E. F. Company	41
	Haws Drinking Faucet Co.	208
ae	Haynes Products Co.	194
ab	Heatilator, Inc.	19
ae	Hendrick Manufacturing Co.	202
	Home Owners Catalogs	186
a	Horn Brothers Co.	162
abe	Hunter Fan & Ventilating Co., Inc.	178
a	Imperial Brass Mfg. Co.	14
	Infra Insulation, Inc.	152
ae	Inland Steel Co.	18
abe	Inland Steel Products Co.	128
ab	Insulite Division	155
	International Nickel Company, Inc.	199
a	Jackson & Church Co.	204
ae	Johns-Manville	51
ae	Josam Manufacturing Co.	196
ab	Kaiser Aluminum & Chemical Sales Inc.	168
ae	Keasbey & Mattison Company	44
a	Kennedy, David E., Inc.	66-67
	Kennedy Valve Mfg. Co.	20
	Kewaunee Mfg. Co.	142
	Keystone Steel & Wire Co.	151
	Kwikset Locks, Inc.	8
a	L.C.N. Closers, Inc.	137
abe	Libbey-Owens-Ford Glass Co.	193
	Litecontrol Corporation	165
	Lone Star Cement Corp.	196
a	Macomber, Incorporated	56
ae	Mahon, R. C. Co.	37
	Marlo Coil Co.	149
	Master Metal Strip Service	156
a	Medart, Fred Products, Inc.	35
a	Medusa Portland Cement Co.	173
a	Mengel Company	185
a	Metal Tile Products, Inc.	160
	Miller Company	203
ae	Mills Company	45
	Minneapolis-Honeywell Regulator Co.	27
ab	Minnesota & Ontario Paper Co.	155
ae	Mitchell Manufacturing Co.	141
ae	Modine Mfg. Co.	36
ae	Moulding, Thos. Floor Mfg. Co.	200
ab	Nator Store Fronts	65
a	National Gypsum Company	189
e	Nelson, Herman Corporation	198
	Neo-Ray Products, Inc.	60
	Ohio Hydrate & Supply Co.	166
a	Onan, D. W. & Sons	174
ae	Otis Elevator Company	163
ae	Owens-Corning Fiberglas Corp.	205
ae	Owens-Illinois Glass Co.	23-145

MANUFACTURERS' PRE-FILED CATALOGS  
Symbols "a", "b", and "e" indicate that catalogs of firms so marked are available in Sweet's Files as follows:

a—Sweet's File, Architectural, 1949  
b—Sweet's File for Builders, 1949  
e—Sweet's File, Engineering, 1949

	Parkwood Corporation	202
	Petko Industries, Inc.	8
abe	Pittsburgh Plate Glass Company	32-157
a	Pittsburgh Reflector Company	57
a	Powers Regulator Company	29
	Radio Corporation of America	24
a	Republic Steel Corporation	177-211
abe	Revere Copper & Brass, Inc.	46
a	Reynolds Metals Company	47
ab	Richmond Radiator Company	47
	Roberson, L. N. Company	208
ab	Roddis Plywood Corporation	50
a	Rotary Lift Co.	166
ae	Ruberoid Co.	68
a	Sanymetal Products Co., Inc.	39
	Sarcotherm Controls, Inc.	31
ab	Schlage Lock Company	159
a	Seaporcel Metals, Inc.	154
ab	Servel, Inc.	42-43
e	Servicised Products Corp.	194
ae	Sloan Valve Company	4th Cover
	Sloane-Blabon Corporation	1
	Southbridge Plastic Inc.	17
a	Sperzel	172
	Staedler, J. S., Inc.	204
	Standard Electric Time Co.	206
abe	Stanley Works	61
a	Surface Combustion Corporation	139
ae	Taylor, Halsey W. Co.	147
	Texas Housing Co.	174
ab	Thrush, H. A. & Company	184
ae	Timber Structures, Inc.	204
	Todd Shipyards Corp.	170-176
abe	Trane Company	207
	Tremco Manufacturing Co.	208
a	Trinity Portland Cement Division	183
ae	Trumbull Electric Mfg. Co.	143
abe	Truscon Steel Company	211
	Unistrut Products Co.	21
ab	United States Plywood Corp.	48-191
ae	United States Steel Corporation Subsidiaries	158
	United States Rubber Co.	54-55
a	Universal Atlas Co.	158
a	Van Range, John Co.	140
a	Vulcan Radiator Co.	194
ae	Wakefield, F. W. Brass Company	206
ae	Webster, Warren & Co.	62-63
	West-Dempster Co.	210
a	Westinghouse Electric Corp.—Elevator Div.	25
a	Worthington Pump & Machinery Corp.	32
ae	York Corporation	213
abe	Zonolite Company	206

NEW YORK—H. Judd Payne, Publishing Director; Robert F. Marshall, Business Manager; Tom Tredwell, Advertising Mgr.; Benton B. Orwig, Creative Service Manager; M. A. Murphy, Advertising Production Manager, 119 West 40th Street; BOSTON—Harry M. Horry, Jr., 855 Park Square Bldg.; CHICAGO—C. B. Riemersma, Robert T. Franden, John M. Cogan, 700 Merchandise Mart; CLEVELAND—John C. Jackson, David K. Bortz, 321 Hanna Bldg.; DALLAS—O. O. Pousell, 412 Construction Bldg.; LOS ANGELES—Bob Weltstein, 672 South Lafayette Park Place; PHILADELPHIA—Tom Tredwell, 1321 Arch St.; PORTLAND—Bob Weltstein, 907 Terminal Sales Bldg.; SAN FRANCISCO—Bob Weltstein, 1003 TWA Bldg., 240 Stockton St.

OUR BUSINESS IS IMPROVING YOUR BUSINESS

# BETTER AIR CONDITIONING FOR YOUR CLIENTS

In all your planning for clients, remember that any business can be made a better business with YORK air conditioning and refrigeration. Each YORK product is designed to cut costs, improve service, make a profit for those who install it. YORK gives you real help on every job, from the first outline to the final installation. With YORK you get experienced aid all the way through, with full cooperation from a national organization that maintains branch offices and trained engineers throughout the country.

**“See Your  
Architect,  
Engineer,  
Contractor,  
First”**

YORK believes in channeling contract work through *You*...and YORK gives you unequalled support in providing the owner with the finest central station system possible.

- a complete line of equipment
- competitive prices
- accurate, dependable product ratings
- technical assistance based on “case histories”
- cooperation with architects, engineers, and contractors
- practical help from York-Trained Engineers
- a national organization
- continuous product research and development
- certified maintenance

YORK Engineers have at their command an inexhaustible supply of practical information gathered from thousands of successful York-equipped installations. This information and their services are at *your* disposal. If you are “planning” any work involving air conditioning or refrigeration, call your nearest YORK Office. You get impartial, experienced help from the start. York Corporation, York, Pennsylvania.

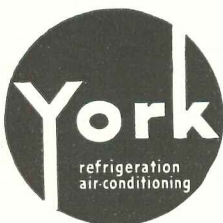

PIONEERS IN INVENTION AND DEVELOPMENT SINCE 1874

*Refrigeration and Air Conditioning*

HEADQUARTERS FOR MECHANICAL COOLING SINCE 1885

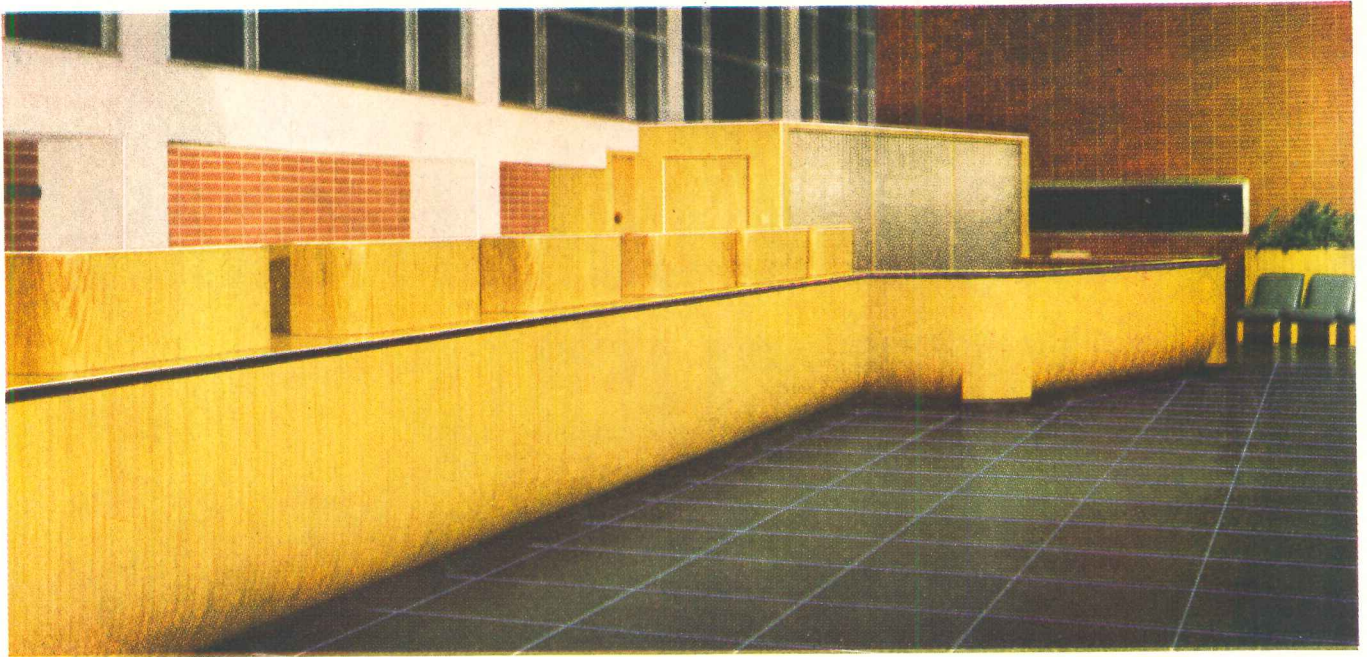

## YOU CAN BANK ON FORMICA . . .

Thousands of dollars change hands every banking day across smooth Formica counters. The same qualities of beauty and rugged resistance to wear that make Formica ideal for use in banks, are reason enough for architects to "bank" on Formica in dozens of other commercial and residential applications.

*Real Savings in Maintenance*



Formica never needs painting or refinishing. Wipes clean with a damp cloth.



There's no percentage in accepting less than genuine Beauty Bonded Formica.

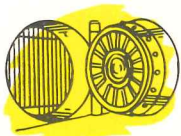

Formica is safe from harm of boiling water, alcohol, mild acids and cleaning alkalis.



Check your 1950 Sweets Section 14-A Catalog 3 for Formica information and the name of your nearest Formica representative.

