

Looking ahead with Asbestos

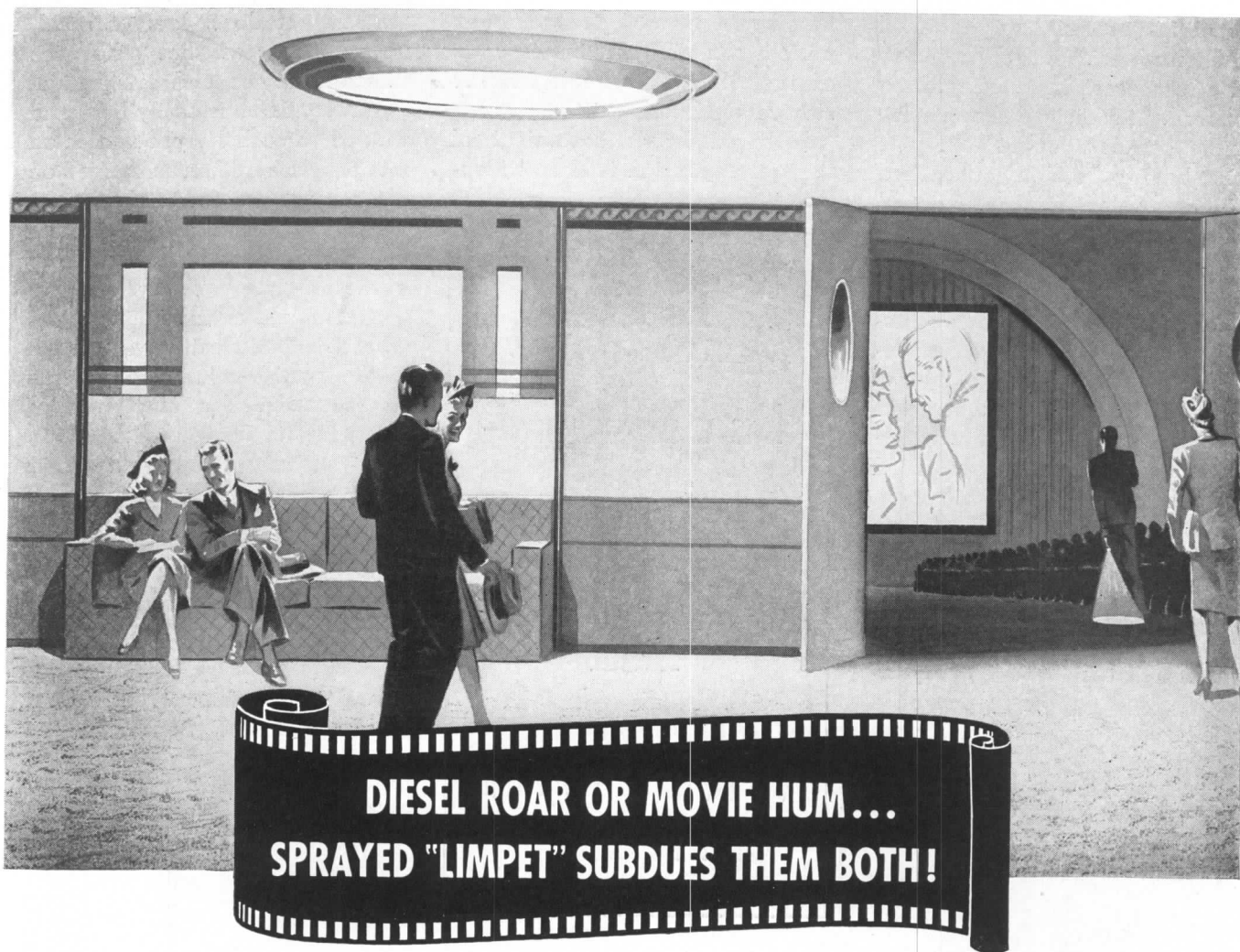

**DIESEL ROAR OR MOVIE HUM...
SPRAYED "LIMPET" SUBDUES THEM BOTH!**

Imagine yourself in a testing room with six big Diesel engines, all going at once, full-speed. What a roar of noise! What unbearable clang and clatter!

But no! It isn't bad at all. Thanks to K&M Sprayed "Limpet" Asbestos on walls and ceiling, it's a mighty quiet dynamometer room. And, what's more, it is safer from fire, despite all the oil and fumes. This is typical of the kind of job that "Limpet" is being called upon to do today in support of the war program.

If Sprayed "Limpet" can disarm the noise-and-fire hazard of six roaring Diesels, it will be child's play to handle the same, though less menacing, hazards in projection booths and auditoriums of Tomorrow's theatres. Also of

special interest, Sprayed "Limpet" frees the architect from any geometric limitation, and can be given up to ten coats of paint without loss of acoustical efficiency.

Because of war's demands, K&M's anti-noise campaign via Sprayed "Limpet" Asbestos cannot be pressed, and its full architectural utility cannot be realized until peace has come. Meanwhile, however, K&M's research in asbestos goes constantly on, so that the service to humanity of Nature's strangest mineral may be ever widened.

* * *

*Nature made asbestos;
Keasbey & Mattison, America's asbestos pioneer,
has made it serve mankind... since 1873*

KEASBEY & MATTISON
COMPANY, AMBLER, PENNSYLVANIA

Makers of

asbestos-cement shingles and wallboards; asbestos and magnesia insulations for pipes, boilers, furnaces; asbestos textiles; asbestos electrical materials; asbestos paper and millboard; asbestos marine insulations; asbestos acoustical material; asbestos packings; asbestos corrugated sheathing and flat lumbers; asbestos-cement pipe for water mains



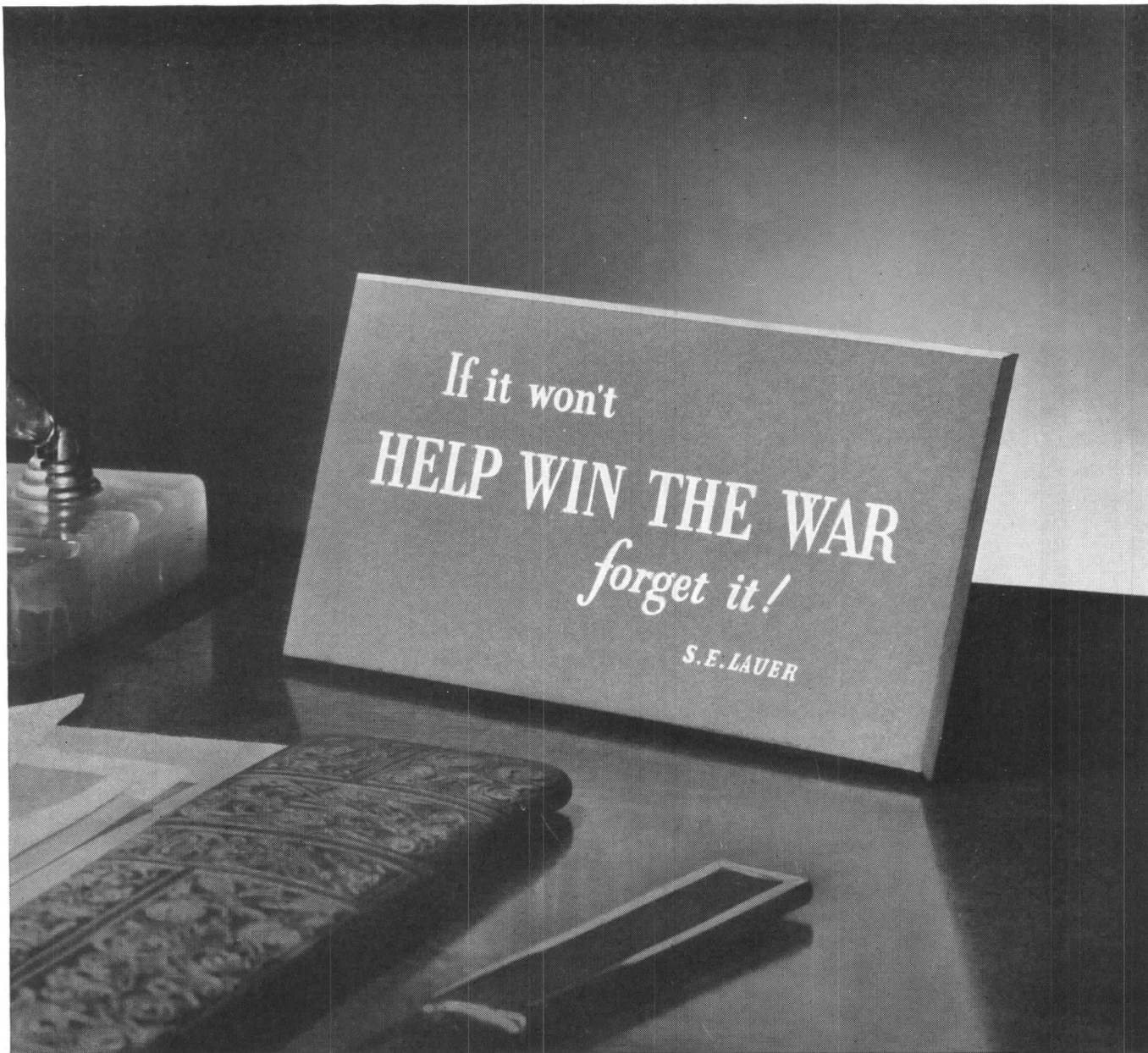

Since February, this little red, white and blue sign has been on the desk of every York executive in the offices, the shops, the Branch establishments. These crackling words from the top reduce every question of policy to its simplest terms. No man need wonder what York is doing these days, or *why*.

YORK ICE MACHINERY CORPORATION, YORK, PA.

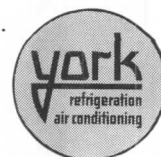

YORK REFRIGERATION AND AIR CONDITIONING FOR WAR

HEADQUARTERS FOR MECHANICAL COOLING SINCE 1885

WASHINGTON NEWS

By WILLIAM J. CASEY

New Housing Program • Civilian Construction Cut • New Steel Stress Allowances • Alternates for Lumber • New Priorities Form • Construction for Building Operators • Speed on Emergency Applications • WPB Materials Rulings • Construction Price Ceiling

NHA ADMINISTRATOR Blandford reported that at least 1,600,000 workers will move into war production areas next year, and that private housing now available and new private building cannot take care of this influx. He pointed out that on May 27 President Roosevelt asked for an additional \$600,000,000 for public war housing, and added that "the period which has elapsed since the President's message means a much more acute war housing shortage next winter and spring than had been anticipated last May, because housing funds made available now cannot get houses built as soon as funds made available at an earlier time." Mr. Blandford said it is essential to have all contracts for new housing let by next April, so that the 200,000-unit program which is contemplated can be completed by mid-summer of 1943.

There seems to be a change of attitude on war housing. It hasn't crystallized into action yet, but the outlook for housing is more encouraging. First, there is more definite recognition that essential housing is vital to the entire war production program. The increasingly acute labor tightness is focusing attention on it. Temporary barracks do not make for good morale and working efficiency. Then it is becoming increasingly clear that as the draft registers married men and even men with children, war production will have to depend more and more on workers who have large families or women with children to care for.

This may be the final impetus needed to bring definite allotments of materials for war housing. An initial step was taken when WPB decided to make 42,000 tons of finished steel available for approved construction already under way. This allotment—divided equally between public and private war housing—is much too little, but it's a start. The hope expressed in building circles is that WPB will now take the next logical steps and allot definite amounts of copper and other critical material needed to carry out construction al-

ready approved as essential. Builders are more and more inclined to insist upon definite assurance on materials before undertaking projects. They'd be willing to undertake less with definite allocation of materials, rather than start on big projects and have them bog down when priority ratings fail to pull materials.

Civilian construction cut

Effective September 7, drastic cuts were made in the amount of civilian construction to be allowed without specific authorization. Types of construction have been reclassified, making distinction in residential and non-residential categories and reducing in most instances the amount of construction for which no authorization is necessary. The new classes of construction established by the revision of L-41 with present cost limits are: residential, \$200; multiple residential, \$1,000; agricultural, \$1,000; industrial, \$5,000; certain types of commercial, \$200; other types of commercial, including highway, sub-surface and utilities construction, \$1,000. In every instance where estimated costs are under established limits the owner, before he may begin construction, must be able to acquire enough material to complete the project with-

out priorities assistance. In addition, the project must not require the use of any material, on the site or off the site, to supply electricity, gas, water, steam, telephone, or sewage disposal service.

WPB defined more fully the meaning of "project" as used in connection with the stop-construction order L-41. According to interpretation No. 2, a project means all separate buildings, structures, or units of construction situated in close proximity to each other and integrated to serve a single general use. It does not mean a particular construction operation or job. Another part of the interpretation defines "total cost of labor" as it applies to the estimated cost of construction. Labor cost must include the actual money outlay for labor employed in the construction and the estimated value of all labor performed in the construction not entailing actual money outlay. From the latter may be excluded only the labor of the owner or tenant and members of the owner's or tenant's immediate family residing with him, on a project owned or leased by him.

New steel stress allowances

WPB has established national emergency specifications for the design, fabrication and erection of structural steel for buildings. All buildings which are constructed, financed or approved by governmental agencies on contracts after November 9, 1942 will

(continued on page 10)

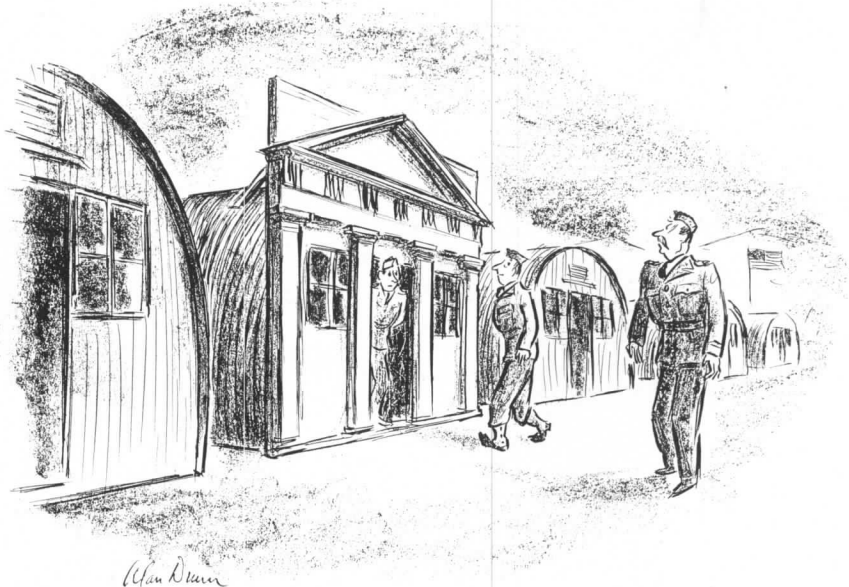

—Drawn for the RECORD by Alan Dunn

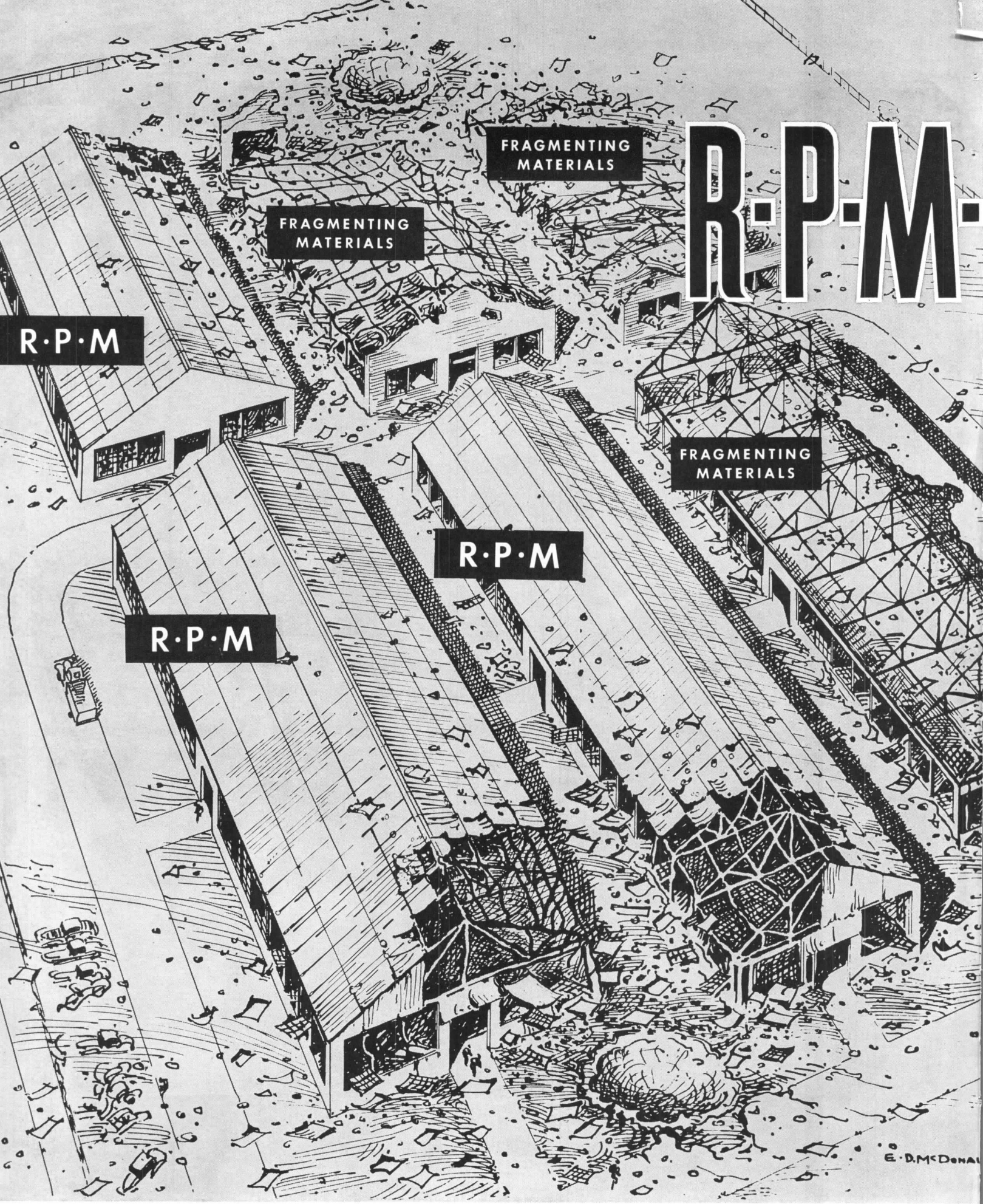

R·P·M·

FRAGMENTING MATERIALS

FRAGMENTING MATERIALS

R·P·M

FRAGMENTING MATERIALS

R·P·M

R·P·M

E·D·M·DONALD

ROBERTSON PROTECTED

A SHOCK ABSORBER

under Bombing Attacks

Robertson Protected Metal (RPM) roofs and sidewalls on industrial buildings throughout the British Isles have an exceptional record of performance during bombing attacks.

Repeated instances may be cited to show that when a detonation bomb lands near a group of buildings, those covered with RPM do not fragment into shrapnel-like missiles, and suffer only relatively slight damage, while those covered with fragmenting materials are stripped of their coverings.

Actually, RPM seems to act as a *shock-absorber* when the bombs come. There are two reasons for this highly desirable characteristic:

1. The sheets themselves have a unique combination of inherent strength, flexibility and resiliency.
2. The sheets are attached to the building framework by a method which provides, in effect, an expansion joint enabling the sheets to move, or "give," under bombing pressure and suction.

Thus, the roof and sidewalls as a whole literally "breathe" under the concussions caused by bomb explosions. The RPM covering gives and takes, which means that it stands a better chance of staying on . . . damage is localized . . . plants are quickly put back to work.

The RPM method of roof and sidewall installation is a QUICK method. It is one of the reasons . . . and there are many others . . . why we say—"*What we really make is time.*"

H. H. ROBERTSON COMPANY
FARMERS BANK BUILDING . . . PITTSBURGH · PA.



CASE V —(See Illustration Opposite) English Bombing reported by an eyewitness. "At the (Name of plant deleted) Works there were half a dozen buildings (three covered with RPM, three covered with fragmenting materials). Two bombs fell, one striking at one side of the group and the other at the opposite side, so that the blasts came from two sides of a square. The two blasts stripped the fragmenting materials from three buildings, while those covered with RPM were damaged only a few feet from the point of explosion."

METAL



H. H. Robertson Co., Farmers Bank Building, Pittsburgh, Pa.

- () Please send me copy of your new book, "Quick is the Word."
() Please have a Robertson Engineer submit new portfolio covering your Bombing Story.

Name _____ Firm _____

Address _____

City _____ State _____



SWIFT, hard-hitting tanks . . .

45 thousand in 1942 . . .

75 thousand in 1943 . . .

That is America's promise to the Victory Program—and America is going to beat that promise.

It calls for construction miracles . . . huge plants to house vast assembly lines . . . new plants for principal parts suppliers.

As America builds for Victory, every cubic foot of space must be properly heated to insure maximum production.

For fifty years, steam has been recognized as the outstanding heating medium. Steam, harnessed and brought under control with Webster Steam Heating Equipment, has proved its ability to provide maximum comfort, economy and trouble-free operation.

Today, all of our facilities not required for direct war work are freely offered to architects, engineers and heating contractors working on war construction.

Essential repairs for Webster Systems are available on A-10 priority, under W.P.B. Emergency Repair Order P-84. Orders should be limited to actual needs.

Warren Webster & Company, Camden, N. J. Representatives in 65 principal Cities

Webster
Steam Heating

THE RECORD REPORTS

(continued from page 7)

be affected. Somewhat lighter sections of beams and other members entering into the construction of buildings will be permitted. The allowable stress for beams in flexure has been increased from previous allowances ranging from 16,000 to 20,000 pounds per square inch to a mandatory 24,000 pounds per square inch. Other savings of steel are effected through the use of continuity in design and welded fabrication.

The specifications manual is binding upon WPB, the Army, Navy, Maritime Commission, RFC, National Housing Agency and all other government departments and agencies in respect to war construction. Broadly speaking, the manual follows the policy stated in the joint directive on wartime construction made by WPB and the War and Navy Departments on May 20, 1942 and the "List of Prohibited Items for Construction Work" issued by the Army and Navy Munitions Board on April 1 and revised on June 29, 1942. Although the effective date is November 9, the agencies were empowered to put the directive into immediate effect wherever possible. Authority to depart from the provisions of the directive may be granted, upon specific request, by WPB.

Alternates for lumber

Lumber is becoming increasingly tight. To stimulate lumber supplies, OPA has liberalized price ceilings by permitting higher prices where costs were increased through overtime operations, and WPB has ordered a 48-hour week in the Pacific Northwest lumber industry. Purchasing of lumber for the Army, Navy, and Maritime Commission has been centralized in the Construction Division, Office of the Chief of Engineers of the Army. The idea is to pool orders to establish demand more definitely and to reduce competitive buying.

Producers of brick and other clay products are urged by WPB to gauge production to meet an anticipated increased demand for these materials for use in the place of lumber in both temporary and permanent structures. It is believed that at least 2,000,000,000 board feet of lumber could be saved by increased utilization of brick and tile, and an additional 100,000,-

000 to 150,000,000 feet saved by use of gypsum board.

Representatives of the structural clay products industry have offered to provide technical assistance needed to facilitate the change from frame to brick and tile construction in temporary government structures.

Said John L. Haynes, Chief of the WPB Building Materials Branch, "It is merely a matter of using lime mortar instead of cement mortar so as to facilitate dismantling when the time comes, and of omitting non-essential items to conform with the temporary use for which the structure is to be employed. Buildings of tile can be readily razed and materials salvaged, if desirable for further use, with facility comparable to that of other construction.

"Gypsum board is well adapted for use as sheathing for exterior wall coverings, interior wall and partition work, roof decks and slabs, especially where some degree of fire protection is advantageous. The combination of gypsum lath and plaster for sanitary advantages should not be overlooked."

New priorities form

A revised project application form PD-200, which is to be used for obtaining priority assistance and authority to begin construction for most construction items and equipment, is now available. Beginning October 1, application on the old PD-200 form will not be accepted. However, in emergency cases where the supply of new forms is temporarily exhausted, the old form may be used if you attach a letter explaining the circumstances. This form must now be used as an application for: (1) authority to begin construction pursuant to the provisions of the Stop-Construction Order, L-41; (2) priority assistance for any project involving new construction, reconstruction, remodeling or conversion; (3) priority assistance for equipment when construction is involved. PD-1A applications formerly submitted for such equipment will no longer be accepted. When no construction is involved, however, PD-1A's will continue to be accepted for equipment.

This revised PD-200 form does not replace PD-105, used for privately fi-

(continued on page 12)



TO HELP CLOSE THIS DOOR FOREVER

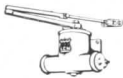

Small parts for tanks, planes, guns, ships—now stream from the machines that formerly made LCN Door Closers for the doors of peace. And the men at these machines, trained for years in the precision methods which are standard at LCN, enabled us to go all-out on this vital job. Yours for Victory now, and yours for even better door closers when Victory is won. LCN, Chicago, Illinois.



100% Production for



VICTORY

ARCHITECT-ENGINEER

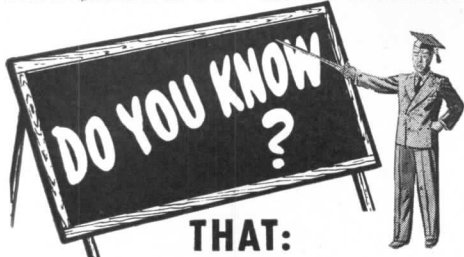

THAT:

1 A new type of wire may be more desirable for a given location than the one most frequently specified?

2 BULLETIN OK-1011 is invaluable in deciding what kind of wire and cable to use for specific jobs? That it contains, in addition to a Selector Chart: Recommended types of insulation — Conductor strandings and designs — Protective coverings for various conditions — How to approach the problem of getting cable today — Purchase specifications — Data to include in your inquiries to speed handling? That we will send a copy free on request?

3 New developments are being made constantly in Hazard wire and cable insulations?

4 Such developments are important in connection with W. P. B. restrictions on electrical wiring?

5 Hazacode, Type R wire is durable and flame-resisting and fully meets the requirements of the National Board of Fire Underwriters and the National Electrical Code?

6 Hazard engineering service will help you with any electrical problems in planning new projects or remodeling old ones?

7 With new research developments and ever-changing war regulations concerning the use of copper and rubber, you can use Hazard engineering service profitably?

8 There are Hazard district offices in all principal cities of this country where Hazard engineers may be consulted, without obligation, as to the best type of wire to specify?

**Make use of this
HAZARD ENGINEERING SERVICE!**

HAZARD INSULATED WIRE WORKS
DIVISION OF THE OKONITE COMPANY
Wilkes-Barre, Pennsylvania
Offices in Principal Cities

 **HAZARD**
Building Wires for Every Purpose

THE RECORD REPORTS

(continued from page 10)

nanced war housing, or PD-406, used for remodeling houses in critical defense areas. Neither does it replace form PD-3A, used for projects owned by the armed services and identified as "command" construction.

PD-200 applications are available at all WPB field offices, the County War Boards of the Department of Agriculture, field offices of the Federal Housing Authority, field offices of the Army, Navy, and Maritime Commission and many financial institutions. Instructions as to filing the executed PD-200 forms may be obtained at all field offices of WPB.

The coverage of the new PD-200 form has been increased and more detailed information is required. For simple types of construction, however, instructions have been drawn in such a manner that an applicant need fill out only the portion of the form applicable to his particular case.

The number of copies of the form to be filled in has been reduced from five to four. The form is now used in other than "command" construction. To reduce delays in processing, the PD-200 form has been correlated with the utilities application for utilities work in connection with a construction project.

Machinery and equipment required for a project have been separated from the construction materials and are listed in new sections. The machinery section has been divided among metal working equipment, power equipment and other machinery and equipment. The materials list has been increased. In cases where structural steel is used, a certificate must be attached to PD-200 stating WPB emergency specifications have been complied with.

Construction for building operators

Operators of industrial plants, office buildings, apartment houses, hotels, and other substantial buildings were granted permission by WPB to apply for blanket authorization to cover miscellaneous construction work over a period not to exceed six months.

This makes it possible for both the operators and WPB to avoid handling numerous applications for construction jobs which are necessary in larger buildings, but which, under the for-

mer plan, had to receive individual authorization when the cost for all such work reached the limits set in the stop-construction order L-41.

Under the new plan all routine individual construction jobs, except those estimated to cost more than \$5,000, may be included in applications for blanket authorization. In cases where authorization is granted, the applicant must file within two weeks after the expiration of each period of the term of the authorization a report covering the work done, its cost and the materials consumed. Form PD-200 should be used for all such applications and reports.

In making the report on the work done, the applicant must mark it "Report on Blanket Construction" and include with it a letter indicating the serial number and date on which the application was approved.

The application covering miscellaneous jobs should, if possible, set forth the proposed construction work within the stated period of time in terms of jobs, dollars and quantities of material. A separate application must be submitted for each separate building or project.

Where it is impossible for the applicant to forecast the proposed jobs accurately, an application of a more general nature will be considered. However, the total cost of the proposed construction and a preliminary materials list must be included.

This plan is for blanket construction authorization only and does not alter the usual procedure for obtaining priorities assistance. However, when such assistance is required, this must be indicated on the blanket application.

Where priorities assistance for items of a single type only is required, applications on Form PD-1A will be accepted. If several different items are required, the applicant must apply on Form PD-200.

Speed on emergency applications

WPB announced a method of expediting emergency applications to rebuild or replace property dispossessed because of acquisition by a war agency. Although such applications for authorization to begin construction should be filed in the usual manner,

(continued on page 14)

MAHON STEEL

ROOF DECK

The *Superior*
Roof Construction

for Arsenals, Military Barracks, Hospitals, Depots, Armories, Airplane Hangars, Factories, Mills, Warehouses, Loading Docks and all types of Industrial and Commercial buildings.

Years of actual service has proved, beyond question, the practicability of Mahon Steel Roof Deck for any type of building having flat, pitched or arched roof construction. It is simple in design and possesses great strength—when installed, the entire roof virtually becomes a solid unit of rigid, ribbed steel, securely welded to the structure beneath. It is light in weight—which makes possible substantial savings in the supporting steel. It provides the utmost security from fire. It is speedily and easily installed. Write for catalog giving full particulars of its superior construction—or see Sweet's.

THE R. C. MAHON COMPANY
DETROIT • CHICAGO

Manufacturers of Steel Roof Deck, Rolling Steel Doors, Shutters and Grilles, Kalamein Doors, Tin Clad Doors, Cast Iron Roof Sumps and Roof Sump Recesses.

★ **MAHON** ★



CRUCIAL battles will be lost, lives needlessly sacrificed, unless our men and the men of our allies get *enough* tanks, guns, shells, ships and combat cars to win.

These weapons are made largely of steel. To produce this *new* steel, scrap iron and pig iron must be melted together *half and half* in open-hearth furnaces. Because it has already been refined, scrap iron cuts down priceless production time.

This year steel mills must have six million *additional* tons of scrap—or many furnaces must shut down, produce no war steel. What can you do?

PLENTY!

On your trips, you see old metal bathtubs, water heaters and tanks, abandoned industrial machinery, obsolete equipment and much else. Urge the owners to turn in these idle materials to a scrap dealer or to the Salvage Committee. (Steel scrap collected will be purchased by the steel industry at prices set by the Government.)

If you haven't a local Salvage Committee, you'll render your country a

real service by helping to organize one. See the Mayor, City Manager or some other prominent citizen who *gets things done*. Offer to help him and get others to help. Organize house-to-house canvasses.

BACK UP OUR FIGHTING MEN

Make no mistake about it: This country must go *all out* for war. Your son, brother, other relative or friend may be in the Service now. Many, many more *from each community* will soon be called.

Will you help to give them the equipment they must have to win? Get in the scrap and get it in fast! The American Rolling Mill Company, 2841 Curtis Street, Middletown, Ohio.



THIS ADVERTISEMENT IS IN SUPPORT OF THE SALVAGE PROGRAM OF THE CONSERVATION DIVISION OF THE WAR PRODUCTION BOARD

THE RECORD REPORTS

(continued from page 12)

the field agencies may now telegraph pertinent information to WPB Construction Bureau in New York. The following information should be given to the field offices: (1) name and present location of applicant; (2) name of government agency submitting confirming letter and reason for emergency; (3) location of new construction; (4) number, type, size and value of buildings and other appurtenant construction on the dispossessed property; (5) number, type, size and value of new construction; (6) kinds and quantities of all new materials involved and cost in dollars.

WPB materials rulings

WPB has issued a Builders' Hardware Manual which lists the size, kind and quantity of builders' hardware which may be used in certain types of construction. Only those items of builders' hardware listed in the Manual and used as prescribed therein may be rated by any housing priorities issued.

Arrangements have been made to grant assistance to manufacturers of construction machinery parts in obtaining raw materials for parts sold on A-10 ratings. Under the new set-up, it will no longer be necessary for purchasers of most construction machinery parts to file separate applications for ratings, but instead they can extend on their purchase order A-10 under P-100. The Construction Machinery Branch will, in turn, assist the manufacturer in obtaining high-rated materials for the manufacture of parts to replace those sold.

WPB recently "unfroze" refrigerator stocks. This releases some 50,000 domestic mechanical refrigerators for sale to the general public.

Builders having certain types of buckets, cranes, graders, shovels, mixers and similar used construction equipment must file a report showing the type and location of the equipment. This report must be filed on WPB Form 1159. In addition, WPB Form 1333 must be used to report any change of status of used construction equipment, such as movement from one location to another, change in ownership, change from being used to becoming idle, etc. Reports are to be submitted to the nearest WPB regional office.

(continued on page 16)



START PLANNING NOW FOR SLOAN-EQUIPPED HOMES

★ ★ ★ ★ ★ ★ ★ ★ ★ ★ ★ ★

Everyone knows flush valves to be the ideal method of flushing toilets. Sloan Flush Valves are installed in luxury homes, apartments, clubs, hotels, and all types of large buildings everywhere because they give enduring satisfaction with astonishingly low maintenance cost—they protect health by preventing back-syphonage—they save water—they are quiet—they are the accepted standard of excellence yet cost no more than others.

Heretofore the use of flush valves has largely been restricted to commercial-type buildings—few being found in small homes. But here is our promise to you: there will be Sloan Flush Valves for residences after the present war is over.

So start planning now for Sloan-equipped homes. With Sloan Flush Valves you provide home owners with the ultimate in convenience, health and economy. Remember: there are more Sloan Flush Valves sold than all other makes combined.

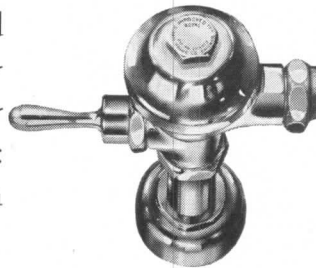

SLOAN VALVE COMPANY

4300 WEST LAKE STREET • CHICAGO

Sanymetal* ALL-WOOD TOILET COMPARTMENTS

with complete door hardware and partition fittings

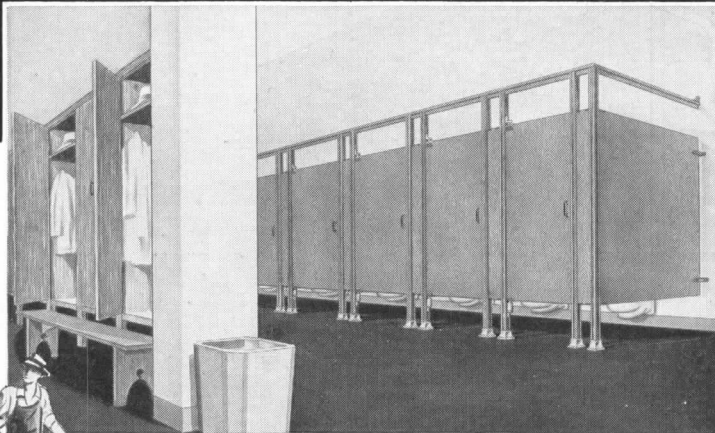

A LOWER STANDARD MAY ENDANGER THE HEALTH OF ALL THE PEOPLE

A lower standard of living must avoid endangering the health of workers, school children, and of all others. Good health is the Nation's priceless asset. Many an ordinary convenience may become a wartime luxury, but this cannot apply to toilet and washroom facilities in factories, school buildings or wherever people gather for work or play, because in many cases these facilities are already below a low standard for such conveniences. If need be, other things should be sacrificed in order to avoid risking the health of the people.

New toilet rooms are being installed and will be installed as long as plumbing fixtures are available, and with them toilet compartments. Sanymetal offers All-Wood toilet compartments that possess the same exclusive features of Sanymetal steel toilet compartments. These toilet compartments were "engineered" to eliminate dust-collecting and germ-collecting ledges and pockets. A toilet compartment that barely meets the essential requirements of privacy isn't enough. Sanymetal All-Wood toilet compartments embody "engineered" features which are usually unknown, and therefore overlooked, by those who do not have years of specialized experience to draw upon in constructing toilet compartments.

You need waste no precious time experimenting and working out a design for toilet compartments because Sanymetal Engineers have already developed an outstanding standard flush type compartment which is now available. Doors, partition panels, posts, headrail bracing, complete door hardware and partition fittings arrive on the job in the right quantity and laid out for quick, grief-free installation. No delays for assembling materials or for experimental erection. Doors and partition panels are 7-Ply Douglas Fir Plywood. Sanymetal's famous four-way design posts, panelled on all four sides and headrail bracing of all wood, make a substantial and rigid installation.

Consult a Sanymetal Representative (see telephone book—classification "Partitions") about suitable toilet rooms for every type of building. He will also show you samples of substitute materials which are being used in Sanymetal wartime All-Wood toilet compartments. Write direct for Bulletin No. 900.

Hospital Cubicles: Write for special folder illustrating and describing typical types of Sanymetal Hospital Cubicles.

THE SANYMETAL PRODUCTS CO., INC. • 1689 Urbana Road, Cleveland, Ohio

*Trade Mark Reg. U. S. Pat. Off.

"Throw your Scrap into the fight!"

THE SANYMETAL PRODUCTS CO., INC.
1689 Urbana Road, Cleveland, Ohio
Please rush by return mail your new bulletin No. 900 on Sanymetal Wartime All-Wood Toilet Compartments.

Name

Position

Firm

Address

City State



THE RECORD REPORTS

(continued from page 14)

Eleven areas have been added to the Defense Housing Critical Area List. They are: Barstow, Calif.; Benicia, Calif.; Tracy, Calif.; Terre Haute, Ind.; Aberdeen, Mo.; Laurinburg-Maxton, N. C. (for rehabilitation only); Delhart, Tex.; Stuttgart, Ark.; Sanford, N. C.; Gainesville, Tex.; (for rehabilitation only); and Walnut Ridge, Ark.

Construction price ceiling

Within the next two weeks OPA will issue a schedule of more limited scope covering the installation of coal burners to supplant oil burners. A specific schedule for construction is necessary since no construction service is the same or similar, or even comparable to a service performed in March. The pricing formula for construction service will consist of four factors: (1) materials, (2) labor, (3) rental of machinery and (4) the contractor's margin. The materials rates to be employed are the same that prevailed during March. Labor rates, however, are to be those of March but are to be adjusted upwards for any increase which occurred before July 1. Wages rates will thus conform to those negotiated by the Union stabilization agreement which was effective before July 1. The contractor's profit margin is frozen at the same amount that he obtained during March. The scope of the construction schedule has been materially limited by omitting all contracts made with Army, Navy, Maritime Commission, or other war procurement agencies.

Due to strong opposition from the building trade, OPA has omitted the clause in the former draft of the schedule of the order which provided that every contractor must furnish the buyer with an invoice giving a complete breakdown of the method of computation, thus affording to the buyer an easy means of checking up on the accuracy of the price. The schedule in its present form provides that if the actual costs exceed the contract price on a bid, the actual price may be increased but to no more than 10 per cent above the contract price. However, in case actual costs fall below the contract price the contractor must make a refund to the buyer of 75 per cent of the saving, retaining 25 per cent himself.

Wartime ways to use

"Pittsburgh" Glass!



PENNVERNON WINDOW GLASS

Long famous for its good looks, the good vision it affords, and its reasonable cost, this excellent window glass is unusually suitable for glazing defense homes of either individual or multiple-unit types. Also being widely used in designing war factories.



PITTCO STORE FRONT PRODUCTS

These quality products, leaders in their field, are designed to be used together to create harmonious, unified store fronts. They afford the architect wide latitude in design. Research and development will make Pittco Products even more helpful to the architect in solving post-war store front problems.

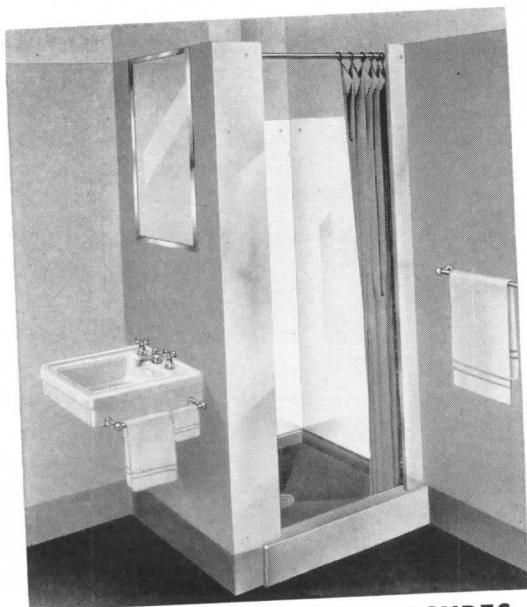

CARRARA SHOWER ENCLOSURES

New, prefabricated shower enclosures of Tempered Carrara Glass save space, construction time and critical materials in building Victory Homes. No metal involved in installation. Complete unit ready for immediate assembly on the job. Good looking, practical and economical. Eight attractive colors.

DETAILED information on any or all of the "Pittsburgh" Products mentioned here will be sent you promptly upon request. And if we can assist you toward a solution of any problems involving the use, application or installation of flat glass, we invite you to call upon us without hesitation. Address Pittsburgh Plate Glass Company, 2104-2 Grant Building, Pittsburgh, Pa.

"PITTSBURGH"

stands for Quality Glass and Paint

PITTSBURGH PLATE GLASS COMPANY

Is this your first war?

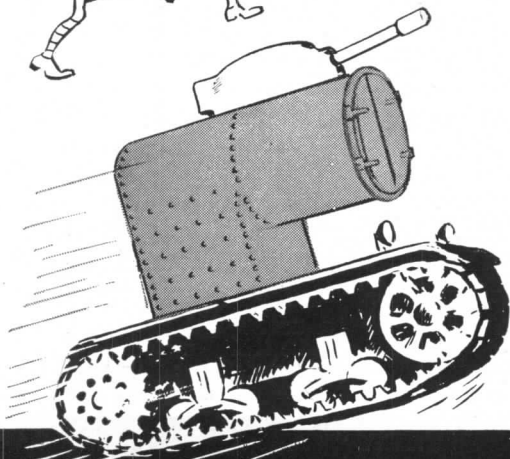

It isn't ours. Nor our second. Nor our third, unless you don't count the Philippine insurrection which was small maybe, but plenty tough. Nor even our fourth, if you include the Indian wars — which you would, if you'd been in them. Ask the shades of Custer's troops.

Anyway, we started making Fitzgibbons Steel Boilers when the Grand Army of the Republic was stepping out right pert and lively, still young. And we haven't stopped making them since, through wars, depressions, pestilence, or what have you.

Survival has become a habit, with Fitzgibbons. Like the race of Man, so designed by nature as to outlast the mastodon. We like to believe that Fitzgibbons Steel Boilers were also correctly designed at their inception, and, backed up by an organization which has long proven its ability to stay young and virile, will still be manufactured long after the present world upheaval has subsided.

Fitzgibbons is in this war a lot deeper than we were in any of the others, making queer things to come out of a boiler works. But we're making steel boilers too — and we intend to be still making them when the veterans of World War II are graybeards.



So far as we may, Fitzgibbons will work to help you maintain Fitzgibbons Steel Boilers and Conditioners now in operation. The cooperation of our Service Department is offered wholeheartedly.

Fitzgibbons Boiler Company, Inc.

101 PARK AVENUE, NEW YORK, N. Y.

WORKS: OSWEGO, N. Y.

BRANCHES AND REPRESENTATIVES IN PRINCIPAL CITIES

★ BUY U. S. WAR BONDS

FITZGIBBONS

LET THESE 3 CEMESTO ADVANTAGES HELP YOU SPEED FACTORY CONSTRUCTION With Steel or Wood Framing!

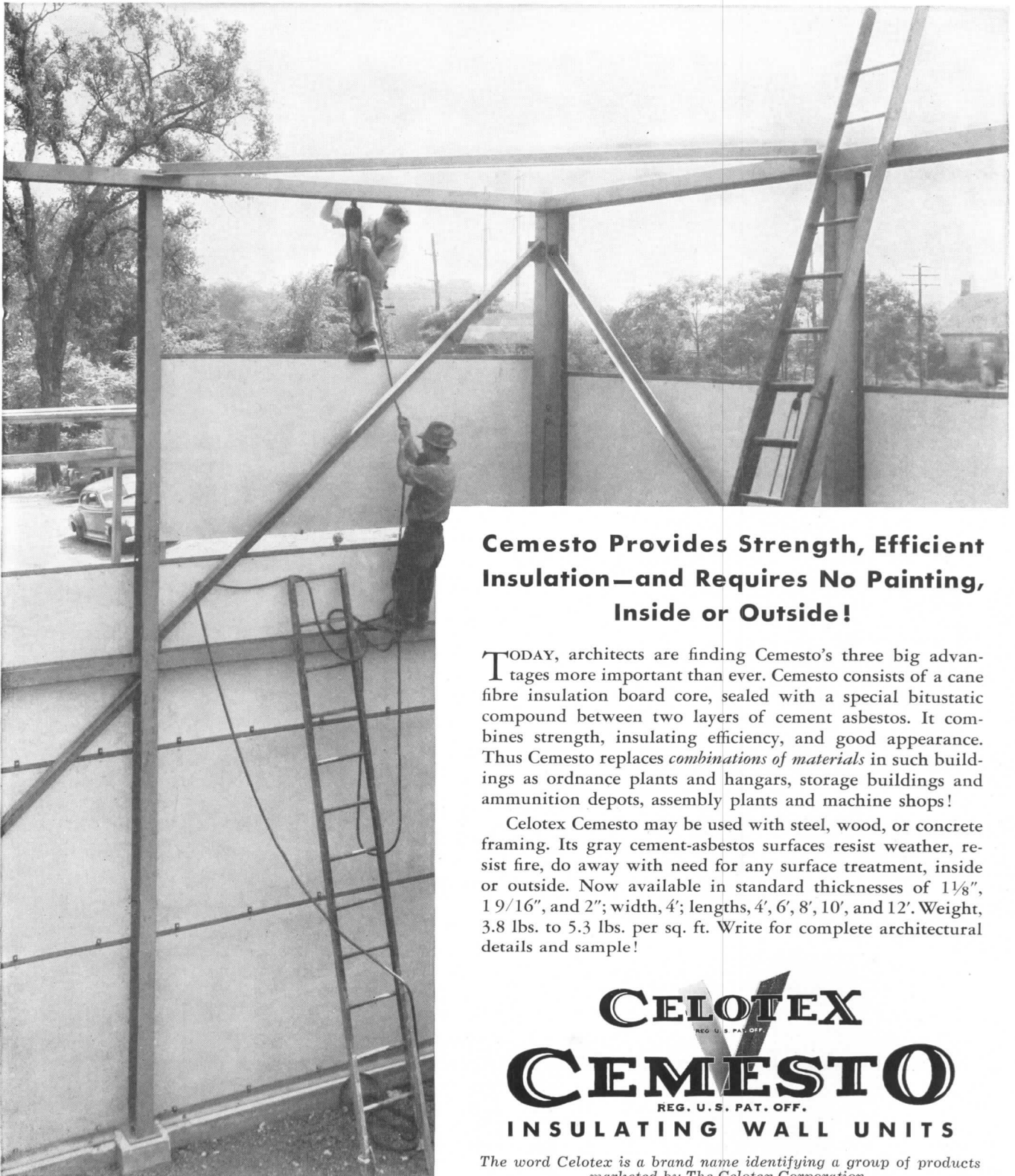

Cemesto Provides Strength, Efficient Insulation—and Requires No Painting, Inside or Outside!

TODAY, architects are finding Cemesto's three big advantages more important than ever. Cemesto consists of a cane fibre insulation board core, sealed with a special bitustatic compound between two layers of cement asbestos. It combines strength, insulating efficiency, and good appearance. Thus Cemesto replaces *combinations of materials* in such buildings as ordnance plants and hangars, storage buildings and ammunition depots, assembly plants and machine shops!

Celotex Cemesto may be used with steel, wood, or concrete framing. Its gray cement-asbestos surfaces resist weather, resist fire, do away with need for any surface treatment, inside or outside. Now available in standard thicknesses of 1 1/8", 1 9/16", and 2"; width, 4'; lengths, 4', 6', 8', 10', and 12'. Weight, 3.8 lbs. to 5.3 lbs. per sq. ft. Write for complete architectural details and sample!

CELOTEX
REG. U. S. PAT. OFF.
CEMESTO
REG. U. S. PAT. OFF.
INSULATING WALL UNITS

The word Celotex is a brand name identifying a group of products marketed by The Celotex Corporation.

THE CELOTEX CORPORATION • CHICAGO



Guard against Hitler's hidden ally



Exide
EMERGENCY BATTERIES

Power failures are hidden allies of the Axis...special friends to Hitler & Co. War production demands the protection of Exide Emergency Batteries.

Despite all precautions of utility companies, forces beyond their control *can* cause power failures. Storms, floods, fires, and street accidents may shut off power and light with disastrous results. But Exide Emergency

Batteries operate instantly and automatically when normal electric current ceases.

No architect *should* be without full knowledge of this protection. Write or wire your nearest Exide Branch, an experienced Exide Field Engineer will help you with plans and specifications for stand-by power and emergency lighting.

THE ELECTRIC STORAGE BATTERY COMPANY, Philadelphia

The World's Largest Manufacturers of Storage Batteries for Every Purpose
Exide Batteries of Canada, Limited, Toronto

What are you doing with that

EIGHTH DAY?

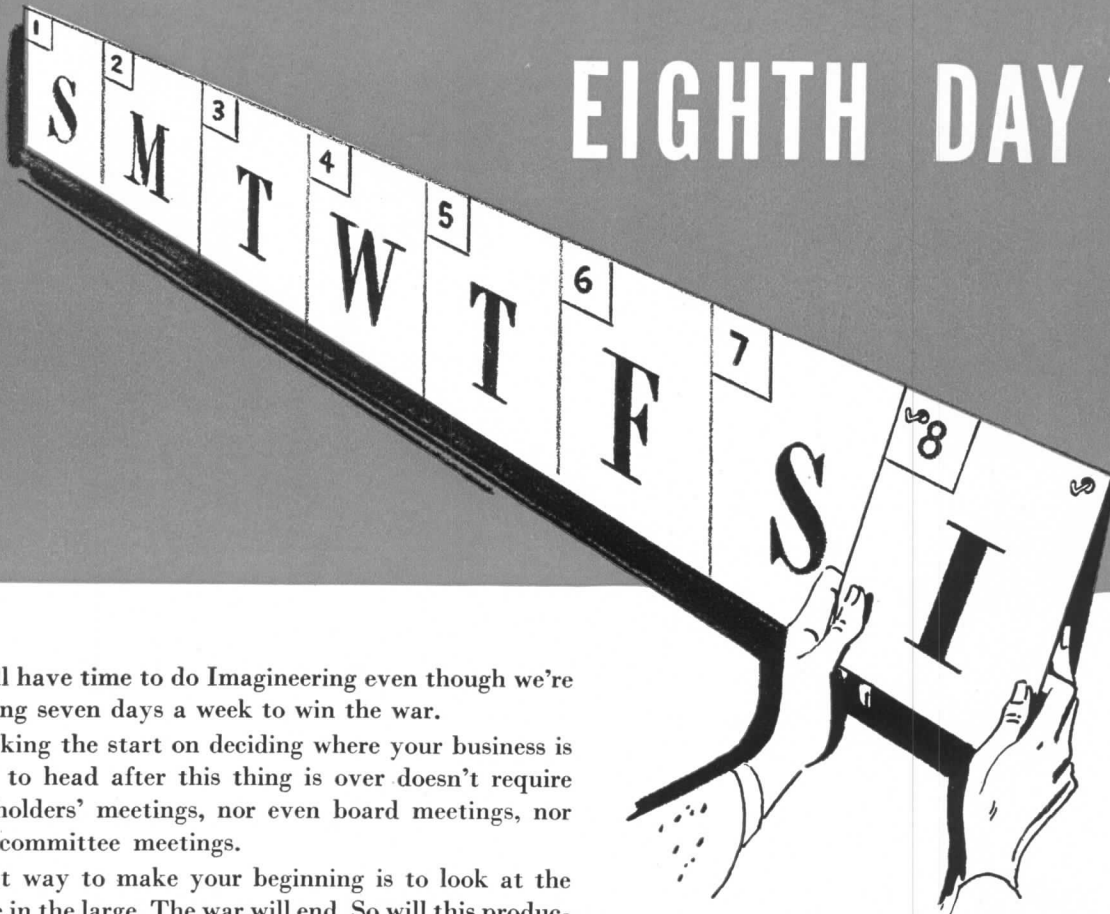

We all have time to do Imagineering even though we're working seven days a week to win the war.

Making the start on deciding where your business is going to head after this thing is over doesn't require stockholders' meetings, nor even board meetings, nor even committee meetings.

Best way to make your beginning is to look at the future in the large. The war will end. So will this production race on war materiel. Millions now employed at that kind of work will need to keep on working at *something* useful. Other millions will come home from wherever, needing useful and peaceful employment.

In the large, therefore, anyone can see that *new things to make* is a prime need for peacetime.

That makes everyone's individual responsibility clear and direct.

In the eighth day of thinking time everyone has at his disposal, he must produce new ideas for new jobs. He *must* let his imagination soar and engineer it down to earth.

He must, or else—

We believe this deeply at Alcoa. We are using our eighth days that way. We mean that no man shall be out of a job when this thing is over for want of *try* on our part right now.

And if you suspect that some of the results of our future-looking on aluminum would fit into your own Imagineering, let's compare notes for future reference.

ALUMINUM COMPANY OF AMERICA, 2167 Gulf Building, Pittsburgh, Pennsylvania.

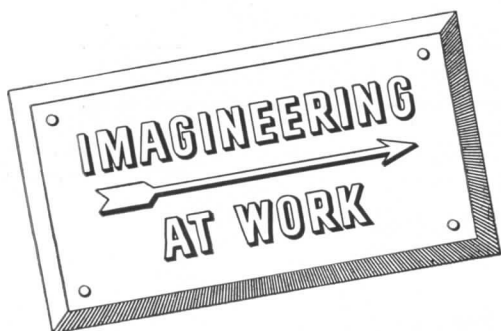

ALCOA ALUMINUM



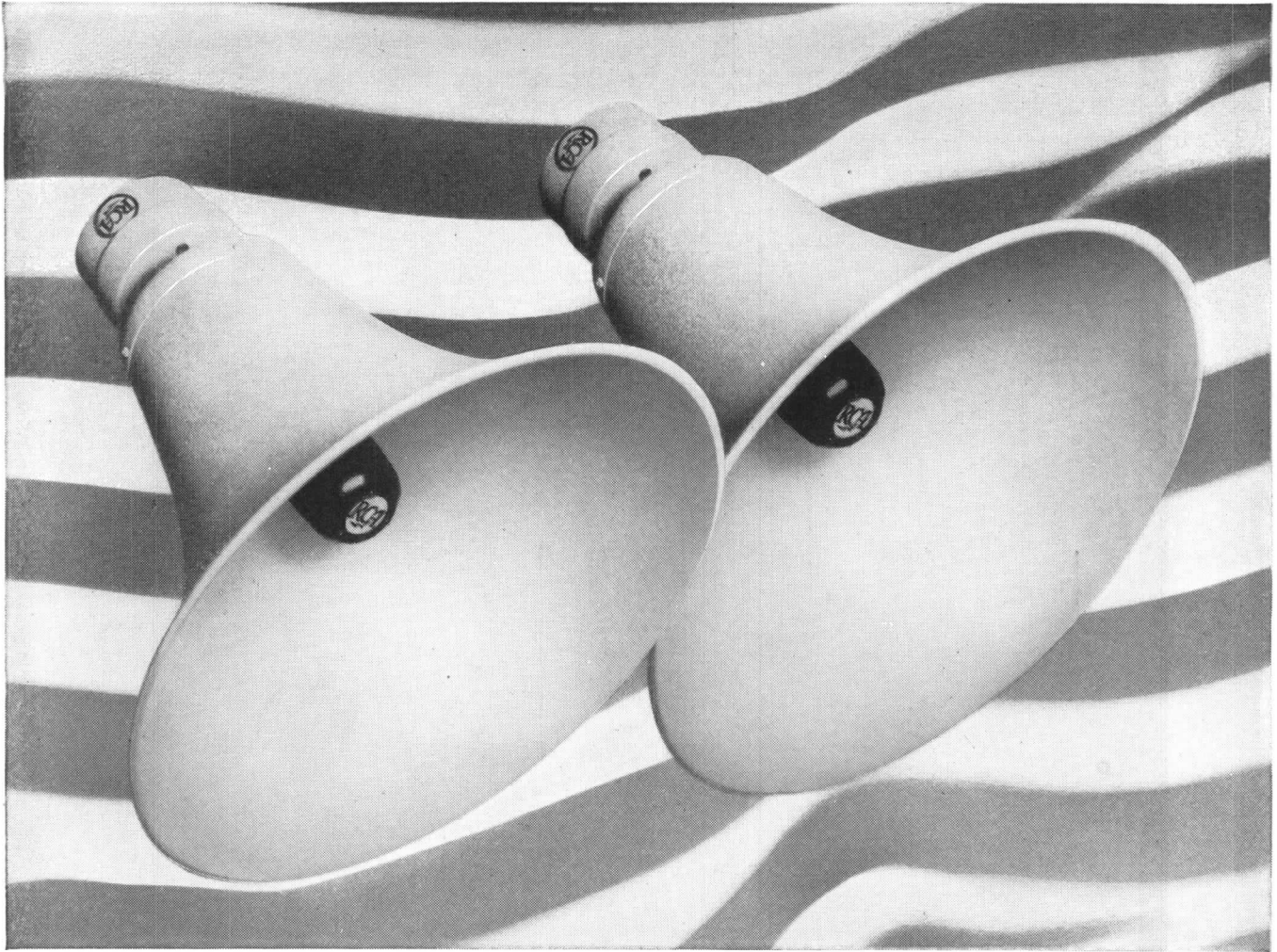

SOUND...TO KEEP FREEDOM RINGING!

In the battle of production there is a tool that serves as a spark for every operation! It's sound... an RCA Industrial Sound Communications System.

This mighty expediter performs morale building wonders... News programs from the fighting front can be broadcast throughout the plant. Rallies can be staged. Instructions can be given to all workers at once. Music to ease the tension and strain of repetitious work can be brought to the employees at periodic intervals. Walking time can be converted into working time by conveying

messages through the air. Coordination of every employee in every department becomes simple.

Be sure your clients get the benefits of an RCA Industrial Sound Communications system in their war plants. Put this important production tool to work in all your commercial and industrial projects.

For more information write RCA Manufacturing Division, Department 2-3, Camden, N. J.

★ KEEP BUYING WAR BONDS ★

 **SOUND SYSTEMS**

RCA Manufacturing Co., Inc. • Camden, New Jersey

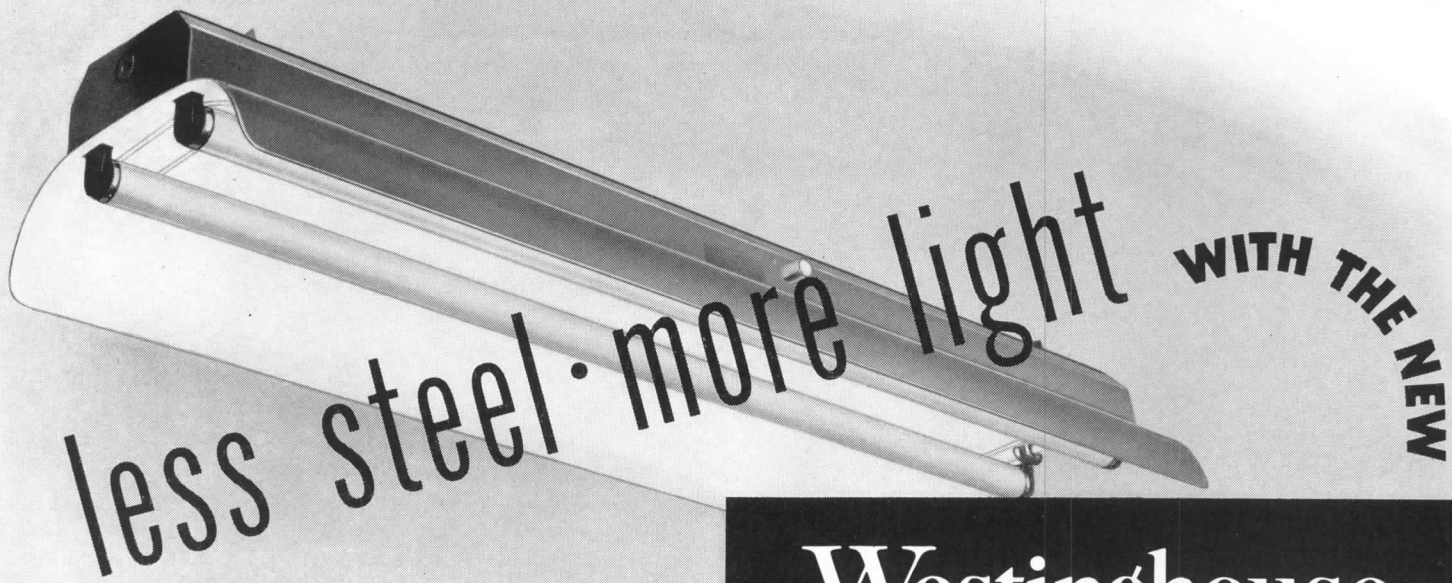

Westinghouse Nonmetallic Reflectors

HERE ARE THE FACTS!

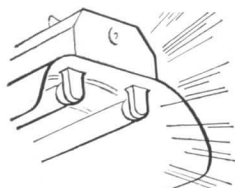

Here's American ingenuity saving steel for Victory's weapons — providing fluorescent reflectors that give *more* light for war industry. They're the new Westinghouse nonmetallic reflectors—for 40-watt and 100-watt luminaires and for continuous-strip installations.

These open-type reflectors, with a 13-degree shielding angle, provide a reflection factor of 86% and an over-all efficiency of 81% with 2-lamp units and 78% with 3-lamp units. The nonflammable, moisture-resistant reflectors are one eighth-inch tempered Reflecto-board—a wood fiber material that will not lose its original, engineered contour.

These Westinghouse reflectors are finished by a specially selected synthetic baking enamel—white inside,

gray outside. The hard reflecting finish resists scratching and chipping. It is easily and safely cleaned with ordinary soap and water. The surface is repellent to acids, alkali, hydrogen sulfide and other industrial fumes. Because it will not oxidize, the finish retains its original whiteness, sheen and reflectivity.



Easy installation, maintenance and lighting system standardization offer advantages that are exclusive. The job of attaching and removing reflectors has been simplified to a simple "twist of the wrist." A mere quarter turn of two tension-locked thumb latches instantly attaches or detaches the take-down reflector. No tools are required. There is neither wasted time nor effort in installation and maintenance.

Complete interchangeability of these

nonmetallic reflectors and steel reflectors permits use of standard replacement parts and additional lighting units. There is no sacrifice in previously installed equipment nor lost production time while new lighting equipment is being installed.

These new fluorescent luminaires with nonmetallic reflectors are further examples of Westinghouse *engineered seeing*—a new technique of combining lighting equipment design and applica-



tion which is available through 117 Westinghouse Electric Supply Company Offices and Independent Lighting Distributors. Ask today

about the new nonmetallic reflectors or write to Westinghouse Electric & Manufacturing Company, Edgewater Park, Cleveland, Ohio.



Westinghouse

L I G H T I N G
E Q U I P M E N T



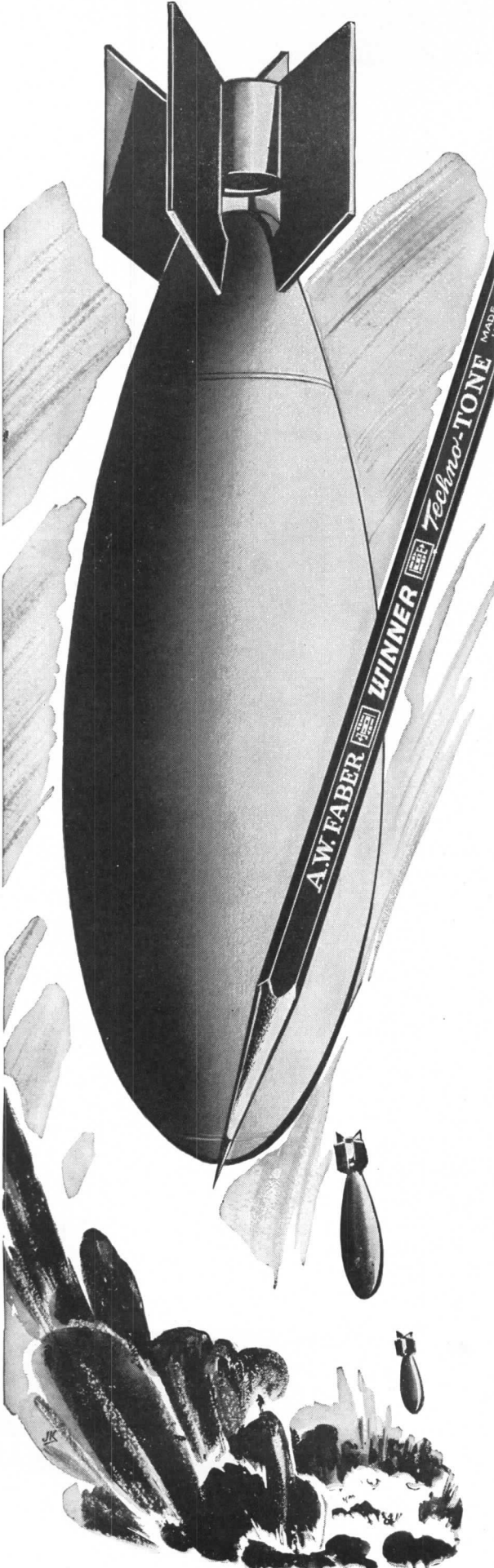

7 inches of concentrated **DESTRUCTION**

The Axis is getting the axe of America's war production.

Production that begins in thousands of factories with a 7-inch drawing pencil — A. W. Faber's WINNER Techno-TONE, America's standard of excellence.

Seven inches of polished cedar wood encasing precision milled and refined graphite—but what a punch it packs when translating the genius of engineers, designers and draftsmen into ships and tanks and planes.

If you are a pencil craftsman you owe it to yourself to get acquainted with WINNER Techno-TONE. We'll gladly send you a FREE sample of your favorite degree.

- Companion Pencil—WINNER Thin Colored Checking—Superb colors and strength. Choicest for all prints: 2381 Red; 2382 Blue; 2383 Green; 2385D Yellow; 2437D Orange. 10¢ each. \$1.00 dozen. Would you like a sample?
- WINNER Techno-TONE is available in 17 scientifically graded tones—6B to 9H. Polished rich green. Packed in metal box. Made in U. S. A.

Write Dept. AR-10, A. W. Faber, Inc., Newark, N. J.

WINNER *Techno-TONE* **DRAWING PENCIL**

13c each 2 for 25c \$1.25 dozen
At all Drawing and Artists Material dealers and leading Stationers.



MAKE THIS TEST -
Prove **BRIXMENT IS BEST!**



1

"Cap" one brick with Brixment mortar (left), and one brick with mortar made with 50-50 cement and lime. After mortars have hardened, place both brick in a pan of shallow water. (Photo 1.)



2

Keep about an inch of water in the pan. Even if soluble salts are present in the brick or sand, you will soon be convinced that *Brixment mortar helps prevent efflorescence.* (Photo 2.)

BRIXMENT Helps **Prevent EFFLORESCENCE!**

EFFLORESCENCE is an outcropping of minute white crystals on brickwork. When these crystals occur on colored mortar joints, the condition is sometimes mistaken for *fading*.

Efflorescence is caused by the presence of soluble salts in masonry materials. When reached by water, these salts dissolve, and are drawn by evaporation to the surface of the wall.

Brixment itself *does not cause efflorescence* because it is practically free from soluble salts. Even when such salts are present in the sand or brick, the waterproofing in Brixment mortar usually *prevents*

them from coming to the surface. . . . Bricklayers who have used Brixment mortar for years say they have far less efflorescence with Brixment mortar than with *any other kind.*

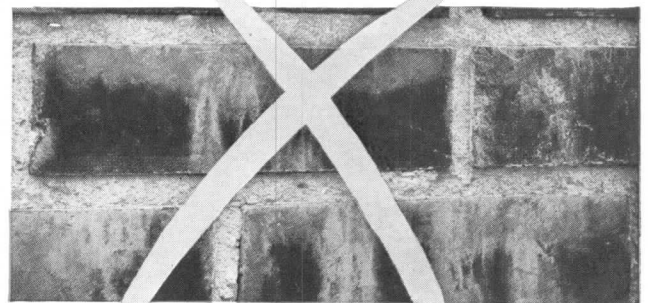

BRIXMENT

For Mortar and Stucco

Louisville Cement Company, Incorporated, Louisville, Kentucky. Cement Manufacturers for Over a Century.



St. Paul's Cathedral has been hit twice by high explosive bombs. This view shows the north transept, where the debris caused the church floor to collapse into the crypt. Neither direct hit has interfered with the stability of the structure as a whole. Photograph from "The Bombed Buildings of Britain"

THE BOMBED BUILDINGS OF BRITAIN.

Edited by J. M. Richards. Cheam, England The Architectural Press, (45, The Avenue), 1942. 140 pp., 8 1/8 by 11 1/4 in., illus. 15s.

"STORM and lightning, the death-watch beetle, Cromwell's troopers, the speculative builder, mere obsolescence—and now German bombs; the legacy they leave of ruins, or living architecture reduced to memories and legends is all one." But this well edited record of architectural casualties in 1940-41 has intense, even poignant, interest. For it shows not only the attention-compelling "architecture of destruction" with anaesthetic peculiar to itself which "contrives its effects out of its own range of raw materials . . . the chalky substance of calcined masonry, the sagging contours of once rigid girders and the clear siena colouring of burnt-out brick buildings, their rigged cross-walls receding plane by plane, on sunny mornings in the City." The careful selection by the editorial director of the *Architectural Review* (in which the material originally appeared) and the keen analytical and interpretive notes by John Summerson give us also our first conspectus of the disaster, with indication of the many poor restorations among buildings which probably will never be rebuilt, obituaries for these and for

worthier casualties—including over a score of Wren churches: the whole enlivened by suggestions that many items can be rebuilt with the decided improvement our present knowledge makes possible over the earlier restorations, and indication that "luckily" many of the essential features as well as many fine details have survived.

STATE HOUSING AGENCIES. By Dorothy Schaffter. New York, Columbia Univ. Press, (2960 Broadway) 1942. 808 pp., 6 by 8 1/8 in., tables, charts. \$7.50

ARCHITECTS and others, including doubtless professors of political science, brace themselves to examine, if not to master, a huge book on a subject somewhat cognate with their own. A sense of duty drives perhaps even when intellectual curiosity lags.

But the story of housing agencies in 21 states by Vassar's professor of political science is as delightful as it is informing. The reading is easy—though there are forty score pages including nearly a hundred of bibliography. The feeling persists throughout that collection and examination of the records have been as thorough as the digesting is careful and the conclusions balanced and impersonal. The significant in the work of many hands over many years in establishing the various agencies is vividly presented, so that each emerges complete with lineage, personality and complexion, with a record of its struggle and achievement, both within its own state and as an influence on other states, an estimate of its strength and the reason for its weakness where that exists. Professor Schaffter offers her record as a contribution to the reconsideration and reform necessary and possible after the war.

NATIONAL BUILDING CODE. Ottawa, National Housing Administration. 422 pp. 6 1/8 by 9 in., tables, diags. \$1.00. (N.R.C. 1068).

THE CODE, probably the first ever produced having for its aim regulation of building construction on a national scale, has been prepared under the joint sponsorship of the National Research Council of Canada and the National Housing Administration, with the cooperation of some sixty active committees and an advisory committee representing sixty professions, trade associations, and government agencies. There is no authority to

compel its adoption; but both the many communities in the Dominion lacking qualified advice to enable them to regulate building construction at all, and those in which requirements in design and construction are out of date will doubtless welcome the code, while localities in which unduly restrictive codes have hampered building may seize the opportunity offered by this publication to modify their present codes.

HOW TO PLAN A HOUSE, HOW TO REMODEL A HOUSE. By Gilbert Townsend and J. Ralph Dalzell. Chicago, American Technical Society, (850 E. 58th St.) 1942. 525, 528 pp. resp., 5 1/2 by 8 1/2 in., illus. \$4.50, \$4.75, resp.

HOW TO . . . "Consult an architect," is the RECORD's advice. But for the many who can't or won't, as for the many who do, there is much of value in these books, written down to the merest of laymen without, unfortunately, being written up to the level the non-technical reader has a right to expect. Tables, diagrams and much of the story are so serviceable that one wonders how it was possible to select and repeat halftones so unserviceable; and it is to be hoped that more readers than we estimate are capable of realizing that things do not necessarily look so dreadful.

EL CERRITO: A Camera report on a typical Spanish community in New Mexico. By Irving Rusinov. Washington, D. C., Gov't Printing Office, 1942. 136 pp., 8 by 10 1/2 in., illus., 45 cents. (U. S. Bur. of Agr. Econ. Misc. Pub. 479.)

THIS vivid report is a help to architecture which is trying to acquaint itself with the essential life of its corporate client, the low-income family or group. It is the first of a series of six studies (the others being Grafton County, N. H.; Lancaster County, Pa.; Putnam County, Ga.; Haskell County, Kans.; and Shelby County, Iowa) made in an effort to show social and economic backgrounds of such groups. El Cerrito, started in the early 19th Century and until a decade or two ago self-sufficient, has "culture of Spain . . . of Southwestern Indians and a few traces of our own . . . people are friendly and interested, curious and suspicious . . . the 'Anglo' has rarely helped them."

Each year the villagers clear the

(continued on page 86)

SOAK UP THE NOISE DEMONS

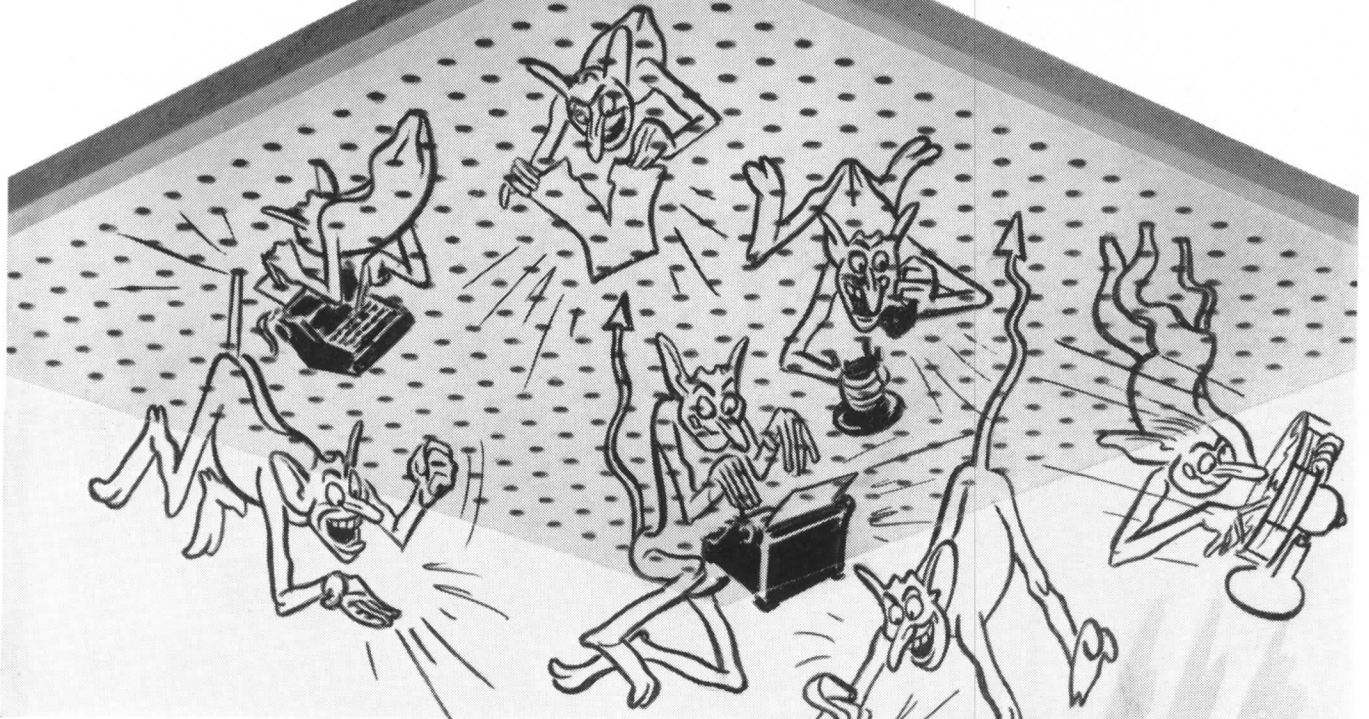

Install Low Cost Ceilings of Armstrong's Cushiontone

COSTLY ERRORS, jangled nerves, lowered efficiency—that's the price of letting noise demons have the run of your clients' offices. It's not only wise, it's easy to get rid of them with ceilings of Armstrong's Cushiontone—the efficient, low-cost way to bring peace and quiet to office interiors.

There are 484 deep holes in each square foot of this new material—484 death traps for noise demons. That's why Armstrong's Cushiontone absorbs up to 75% of the sound that hits its surface. When it's installed, the noise in any office is strikingly reduced.

Factory-painted and ready to apply, Armstrong's Cushiontone comes in 12" x 12" and 12" x 24" units. It can be installed quickly and easily to any ceiling—with little interruption to business. Cushiontone is readily cleaned, and can be repainted whenever necessary without affecting its noise-quieting efficiency. Its smooth, ivory-colored surface provides the excellent light-reflection factor of .73.

LET US SEND YOU a copy of our new booklet which gives all the facts. Just drop a note today to Armstrong Cork Co., Building Materials Division, 1245 State St., Lancaster, Pa.



Armstrong's Cushiontone

Made by the
Armstrong's Linoleum  makers of
and Asphalt Tile

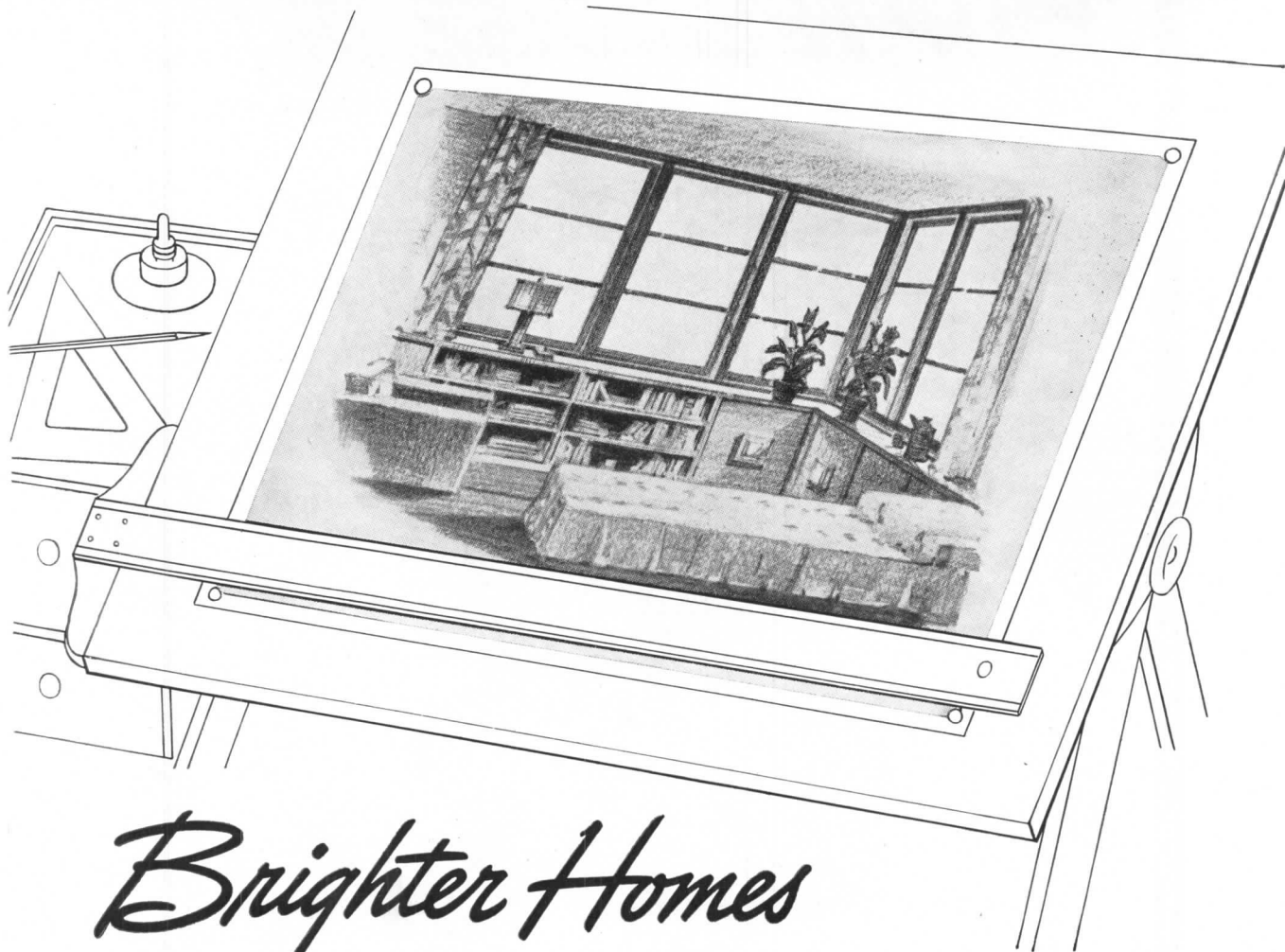

Brighter Homes

are on Tomorrow's Planning Boards

One thing sure about tomorrow's homes, they're going to be made brighter and more livable through use of larger window areas, and through installation of many new glass features.

Picture and corner windows, which were becoming an important part of architectural design in pre-war days, promise to be even more prominent in tomorrow's homes. The opportunities these windows offer for added spaciousness, sunlight and cross ventilation open the way to new possibilities for better living.

More generous use of built-in mirrors in every room of the home also will open the way to greater livability.

Recent surveys made by Libbey-Owens-Ford reveal that practically every homeowner desires more mirrors.

New applications of decorative glass in outside walls and interior partitions promise to provide another practical way of increasing natural light in rooms and hallways . . . will add substantially to decoration possibilities.

The opportunities of designing and building *better* with glass are endless. May we send you our new booklet, "Practical Glass Ideas," which contains many interesting suggestions? Write Libbey-Owens-Ford Glass Company, 1213-A Nicholas Building, Toledo, Ohio.



LIBBEY · OWENS · FORD

QUALITY *Flat Glass* PRODUCTS

How you made thousands of homes more livable, more economical



ANACONDA BRASS PIPE OR COPPER TUBES

RESULT: Owners were saved the inconvenience and expense of pipe repairs and replacements caused by rust. And at the same time they have piping that will deliver a full, rust-free flow of water.

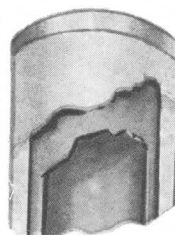

EVERDUR* METAL HOT WATER STORAGE TANKS

*Reg. U. S. Pat. Off.

RESULT: Owners will never experience the unpleasantness of hot water discolored with tank-generated rust. And they have strong, welded, non-rust tanks to give unexcelled service year after year.

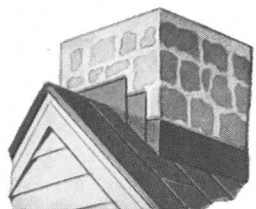

ANACONDA COPPER FLASHINGS AND VALLEYS

RESULT: There can be none of the water damage to a home's interior that rusted metal work so often causes. And, with copper gutters and leaders, the owners have lasting, economical rain disposal systems.



PRODUCT DEVELOPMENTS which promote efficiency and reduce upkeep will always be the aim of the Anaconda Organization.

Although we are now engaged entirely in war production, we are looking also toward the time when Anaconda Copper and Brass . . . in old and new forms of usefulness . . . will be ready for a booming building industry.

4215

THE AMERICAN BRASS COMPANY

General Offices: Waterbury, Conn.
Subsidiary of Anaconda Copper Mining Company
In Canada: Anaconda American Brass Ltd., New Toronto, Ont.



Anaconda Copper & Brass

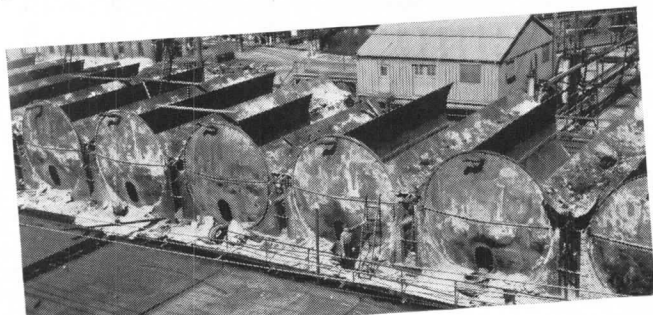

WRECKS ASPHALT PLANT TO GET WAR SCRAP—Demolition of this 26-year-old asphalt plant by an eastern refining company is yielding over a thousand tons of precious scrap, enough to make the steel for 70 "General Lee" tanks . . . Do you have any steel structures, idle now and of doubtful future value, which should be wrecked to release the scrap metal they contain?

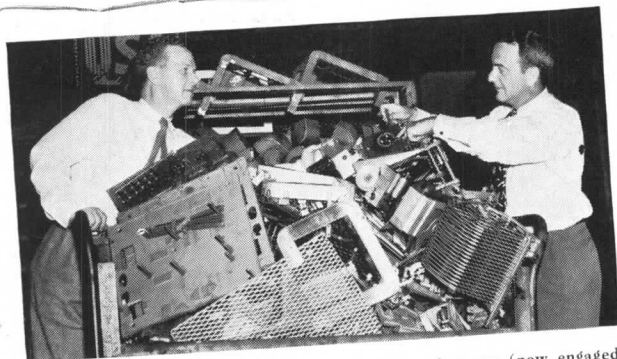

NO HOARDING HERE—A midwest novelty manufacturer (now engaged in war work) recently turned in over two million pounds of metal parts, tools and machinery at scrap metal prices . . . Are you holding idle stocks of obsolete and useless metal parts and equipment for some uncertain future need? In most cases they're worth more now to your country as scrap than they'll ever be to you.

NEWS from the Scrap Front

**TIPS FROM OTHER "WASTE WARDENS"
THAT MAY HELP YOU DO A BETTER JOB
OF "GETTING IN THE SCRAP"**



SEGREGATION MINIMIZES SCRAP LOSS—A western aircraft plant has more than doubled its scrap collections through a systematic salvage program, directed from a central office. All metal scrap is segregated into solids and machinings, and also by alloy content, right at the machines. Scrap containers are color-banded and labeled to clearly identify what goes into each . . . Have you organized an efficient scrap collection system at your plant? Does it provide for careful segregation?

THE SCRAP IS COMING IN . . . BUT NOT FAST ENOUGH!

WE have proof that industry is cooperating in the drive for scrap metals . . . proof measured in thousands of tons. But mills must get *more* iron and steel scrap if they are to meet the gigantic needs of war industry.

Don't forget . . . steel gets to work on the battlefield more quickly when plenty of scrap is available. Scrap is already metallic; therefore, less ore needs to be converted into pig iron per ton of steel produced. By remelting scrap to make new steel, more tons of high-quality products can be turned out in a hurry for war purposes. So make it your personal war assignment to see that your organization does a thorough, continuous job of "getting in the scrap." Cooperate closely with your local Industrial Salvage Committee.



FLOOR SWEEPINGS ARE "PAY DIRT"

Every day sweepings at an eastern war plant yield more than 1000 pounds of more small parts and a big pile of scrap metal. Janitors sift sweepings through wire mesh. Then magnetic separators and mechanical sorting devices finish the job. Usable parts then go back to stock, and scrap is shipped for salvage . . . Are you gleaning every pound of metal from your floor sweepings?

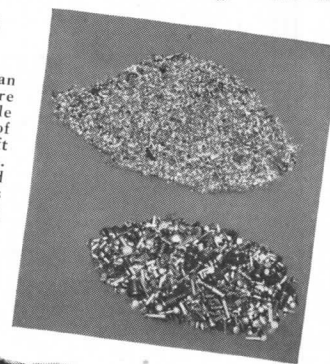

AMERICAN STEEL & WIRE COMPANY, Cleveland, Chicago and New York · CARNEGIE-ILLINOIS STEEL CORPORATION, Pittsburgh and Chicago · COLUMBIA STEEL COMPANY, San Francisco · NATIONAL TUBE COMPANY, Pittsburgh · TENNESSEE COAL, IRON & RAILROAD COMPANY, Birmingham

UNITED STATES STEEL

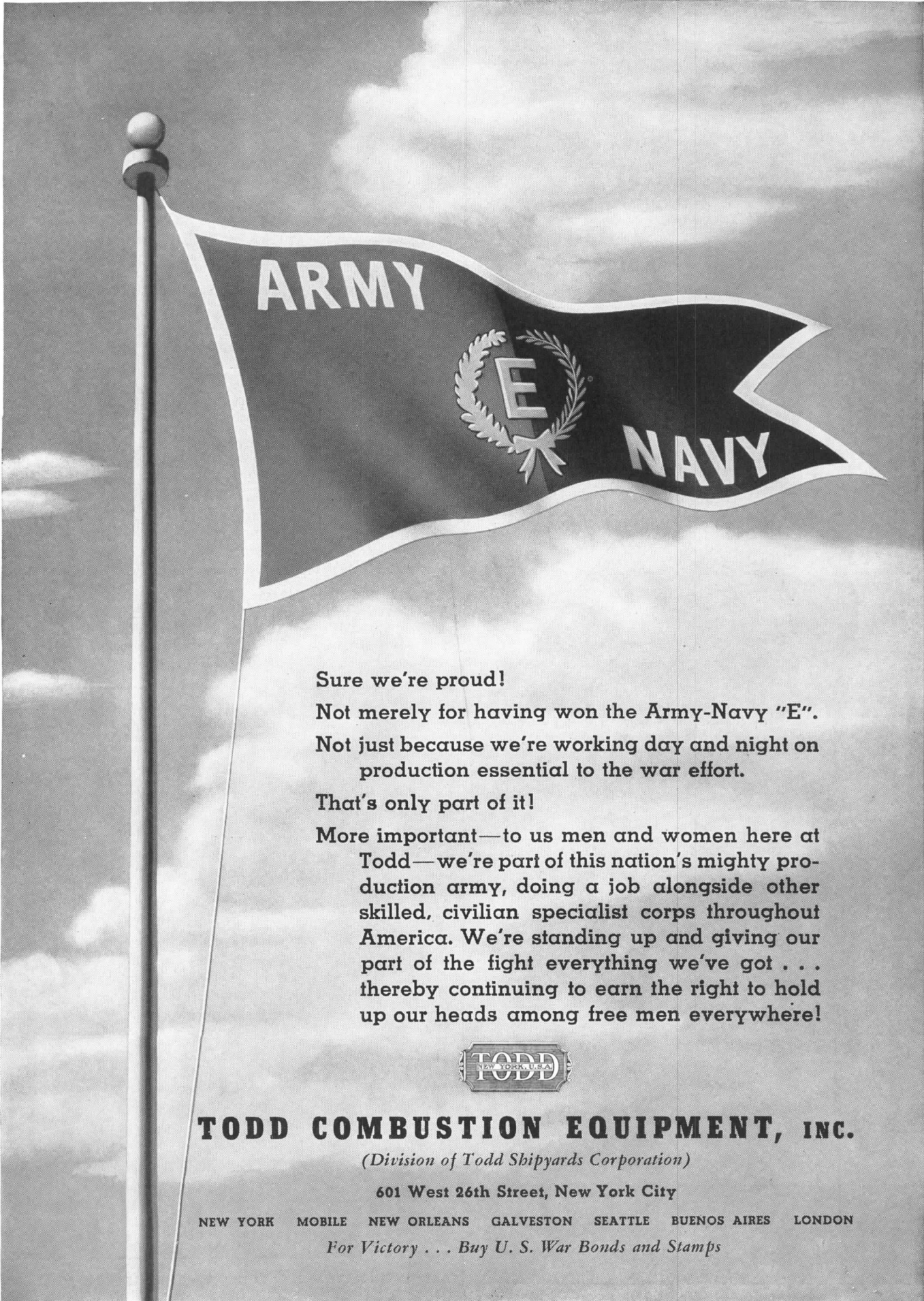

ARMY



NAVY

Sure we're proud!
Not merely for having won the Army-Navy "E".
Not just because we're working day and night on
production essential to the war effort.
That's only part of it!

More important—to us men and women here at
Todd—we're part of this nation's mighty pro-
duction army, doing a job alongside other
skilled, civilian specialist corps throughout
America. We're standing up and giving our
part of the fight everything we've got . . .
thereby continuing to earn the right to hold
up our heads among free men everywhere!



TODD COMBUSTION EQUIPMENT, INC.

(Division of Todd Shipyards Corporation)

601 West 26th Street, New York City

NEW YORK MOBILE NEW ORLEANS GALVESTON SEATTLE BUENOS AIRES LONDON

For Victory . . . Buy U. S. War Bonds and Stamps

For **EMERGENCY** plant office construction



YOU DON'T HAVE TO DELAY your client—or specify makeshift materials—even when he wants a plant office put up practically overnight! Just specify J-M Transite Walls. These modern movable partitions go up fast—and long life with low maintenance is assured by their asbestos-cement composition. Check these advantages:

RAPID INSTALLATION. Accomplished by means of a patented construction method—without interrupting routine work. Relocation possible without loss of material.

RELEASES CRITICAL WAR MATERIALS. The two basic components of Transite Walls are asbestos and cement.

FORMS ANY TYPE PARTITION. Free-standing, ceiling-high, solid or in combination with glass.

FIRE-RESISTANT, STRONG. Resistant to fire because asbestos-cement cannot burn. Highly resistant to all kinds of factory-encountered shock and abuse.

ATTRACTIVE APPEARANCE. Natural, light-gray color specially adapted to plant or general office use. Finish is permanent. Requires no painting, unless desired.

For details on J-M Transite Walls, see our Catalog in Sweet's, or write for brochure TR-22A. Johns-Manville, 22 East 40th Street, New York, N. Y.

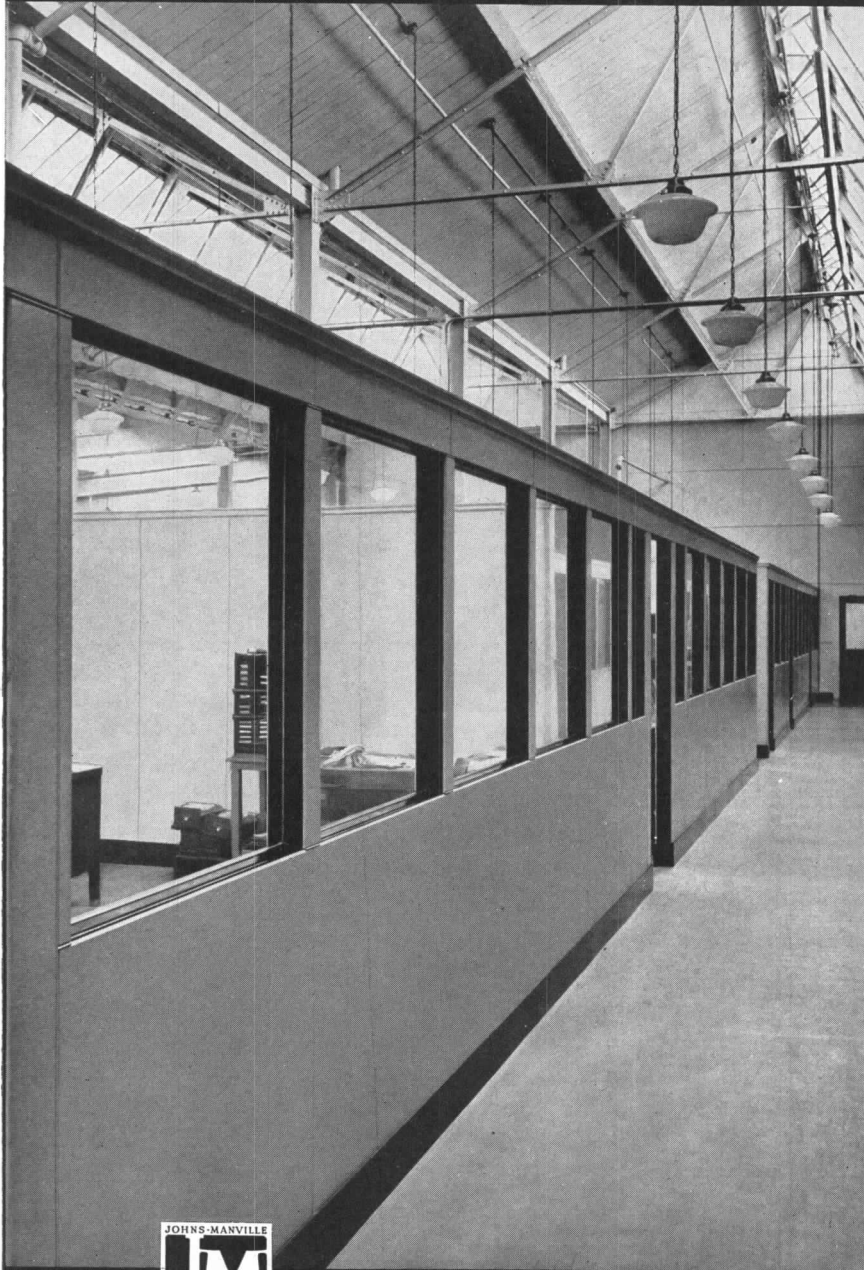

JOHNS-MANVILLE

Transite *Movable Asbestos* Walls

PLAN FOR PLANNING



These words are addressed to the architects and engineers who cannot now, because of age, physical disability or other reasons, contribute directly to the war effort. Such men can and should address themselves to the task of making sure that their fellows in war work will find their services needed in carrying out the ordered plans for rebuilding America. The men of the professions who are now with the armed services or are actively engaged in producing the facilities for winning this war should be assured that their colleagues at home are carrying on.

IF there are two functions which distinguish the special province of the architectural profession, certainly they are those of planner and coordinator. And of the architect's potential leadership there is little doubt in the mind of the profession: this is "his rightful place," that of a key man whose training, experience and judgment are essential in making decisions in the realm of building.

◆ This being so, it is obvious that his leadership and functions are now put to the test by the necessity for competent planning and coordination for the post-war period—both the immediate "after the armistice" readjustment period and the long-term development of the design for democracy, the creation of a new, efficient, healthful and pleasant environment for human activity and progress. The building industry must be ready for the readjustments and the expansion. It is the opportunity for men of vision, a responsibility that cannot be neglected without serious consequences both to the post-war economy and the position of the profession in the post-war period.

If architects do not assume leadership in coordinating the co-professions of engineers, city planners and the other factors, to plan for the future building of our towns, cities and regions—someone else will. They will, because post-war construction must be planned for *now*, if it is to contribute to the better living, working and transportation facilities which are envisioned for post-war America. It is time *now* to plan for planning—to state objectives, to organize, to determine needs, to develop techniques and groups for the study of those needs, and ways and means of meeting them.

◆ Planning under a dictatorship is easy—complete control of all factors and no rights for individuals or groups. Planning under our democratic way of life is difficult, for the rights, desires and needs of all factors must be considered and decisions on what is best for all arrived at by conference, cooperation and the determination by democratic processes of the will of the majority. This takes time, clear thinking and leadership. We cannot begin too soon, we cannot leave our future cities to chance or whim without going deeper in the mire of inefficiency and ugliness, and we cannot leave the leadership to others without being recreant to our responsibilities, beliefs and protestations. Planning and coordination in the largest sense are needed now—the exercise of imagination, intelligence and practical knowledge of the realities which are involved.

◆ We are not here advocating Utopian dream-cities or regions, stimulating as they are to contemplate, but the down-to-earth studies of what we have, what we want, and a program of progressive steps to bring about the change.

The needs of the individual, the family, the group—the needs of industry, of agriculture, of commerce, of transportation and of government—must be taken care of in our cities and regions in better ways than heretofore. There are conflicting interests that must be adjusted. Private interest must be coordinated with the public good—to the benefit of both. More than a master plan in the physical sense is needed.

◆ The questions to be faced go far beyond the maps and charts and colored plans. They involve the control and use of land, and of men, money and materials. They are concerned with property rights, municipal financing, administration and taxation, with legislation and public opinion, with population character and change, and with the trends in production, distribution and transportation.

◆ It is because planning realistically for the future is so complicated and involves so many factors that the plan for planning must be instigated now. Will the creative professions of the building industry measure up to the part of the task that is theirs? Much depends on what you and your organizations can and will do in the next few months to develop a plan for planning.

Kenneth F. Stowell

EDITOR-IN-CHIEF

of functionalism; and to insist upon a greater and more thorough dose of structural principles and practice. Our method must not be preventive merely but positive. Its principle should be the closest possible unification of structural techniques and expressive form. Since we know that in the greatest traditions of architecture expression was arrived at, not as something added on in the name of taste, nor yet as the free play of romantic or aesthetic sensibility, but rather as a part of those scientific processes by which materials are assembled, shaped and arranged for use—since our architecture has in practice arrived at that point where techniques and design are inseparable—we should so far as is practicable teach them as inseparables.

We have the problem method, the gift of Paris. Each problem must now be made to include, not plan and plastic form merely, but the design of every structural element essential to it. But that is not enough. The character, disposition, and strength of structure are not to be devised after plans are made and an expressive pattern imagined, but are to be conceived and developed simultaneously with plan and pattern. They, as well as plan and pattern, are to be a material of the imagination and essential to it; and if the imagination is thus circumscribed by a limited knowledge of techniques—if a student is forbidden to design a building which he cannot construct—that is not in the end important. What is important is a discipline in a habit of thought which in the future will be essential to success in architecture.

TODAY, in a thousand chemical laboratories, camouflaged and guarded by armed men, there are coming into life the seeds of a new architecture. Through processes accelerated many times by the urgencies of war there are evolving discoveries and inventions having a scope and adaptability undreamed of in this our antique world. We shall have, when the great storm is ended, a wealth of new materials: metals that are flexible and light and yet five times as strong as steel, wood that can be modeled, glass that is unbreakable, plastics, laminations, and synthetic fibers beyond our present comprehension. From the fierce necessities of war there will come new organizations of industries and of capital, new skills and groupings of labor, new methods of transportation, of production and fabrication, of cheap and ready power. The Athens which will then arise will be built, not by men who use new techniques to confirm old formulae, but by men accustomed to discover and exploit the potentialities of techniques and to develop from these the forms inherent in their specific energies. We can only guess at these in our present schools, but we need not guess at the training, the vision, the daring which will fit our students for their unparalleled opportunities.

We have yet to develop an educational process which will establish in the student's mind a clear and habitual apprehension of this basic relationship of form and technique or which will encourage to the fullest degree possible those aptitudes which are specific to this order of creative activity. We shall not do this by precept, or by example, or by the analysis of masterpieces, but only by such processes as will afford a progressive experience in the integration of structure with plan and expressive form. Making and doing will be the cardinal activities of the courses which afford such experiences but these

will include also a first-hand knowledge of building operations such as may be had from a direct and continued study of buildings under construction and of fabrication plants. Such courses are not to be included as incidents in a program of information courses and bread-and-butter skills. They are to form the heart of our discipline. They are to be organized into related sequences constantly studied and renewed. They will require, like the courses of the *Ecole des Beaux-Arts*, methods of teaching unique to their special objectives: an environment, equipment, conventions and, it may be, even a language peculiar to themselves; and they must be enlightened by a liberal philosophy.

WE know of course that structural techniques are only one of the architect's tools, and certainly they are less the materials of his art than the *program*: that is to say, the thing to be done, the use to be served, the idea to be made express and visible. Not the structure merely but the program must be integral with life and, in our academic way of working, must lie, like structure, within the range of a student's experience. The first and sometimes fateful step towards romance is taken when, impatient of commonplace themes, we ask our students to interpret in a pattern of architectural forms a pattern of social conduct unknown to them. *A Palace for the Governor of Algiers, a Nymphaeum in the Argentine*, may be excellent subjects for the application of abstract principles of plan and composition; and yet, in the end, they deaden rather than vivify the imagination. The imagination like the airplane can sometimes reach the stratosphere, but it must take off from solid ground.

People are sometimes surprised when they visit the Harvard School of Design by the somewhat pedestrian nature of our programs, so rounded with actualities of site and expense and homely use. And yet our purpose was not, as some suppose, to reduce architecture to a technical service merely (although it *is* a technical service) but, rather, through an awareness of service to make sure that at every step of a student's progress his expanding art should be rooted in reality.

There are many practical difficulties imposed by such a principle. The number of planning programs lying actually within the range of a student's experience—a house for his own parents, a building for his own school—is sometimes surprisingly small. On the other hand, it may seem curious that we should demand, even if the theme be one of these, an interpretation of life from men who have scarcely begun to live—all the more so if this interpretation is to be made in the unfamiliar and intractable shapes of buildings. Some conventions are obviously necessary, as they must be in any formalized system of teaching. For my part, I think that—assuming the presence of a skillful teacher—a program will suffice if two conditions are met: first, that it lies in the immediate life about the student; and, second, that it is accessible to him through observation and analysis. What I have in mind is empirical and direct knowledge of the thing to be done, even though this cannot in the nature of things go to the heart of the matter. The student is to visit an actual site, learn for himself the form and movement which life is to assume there, discover and

(continued on page 90)

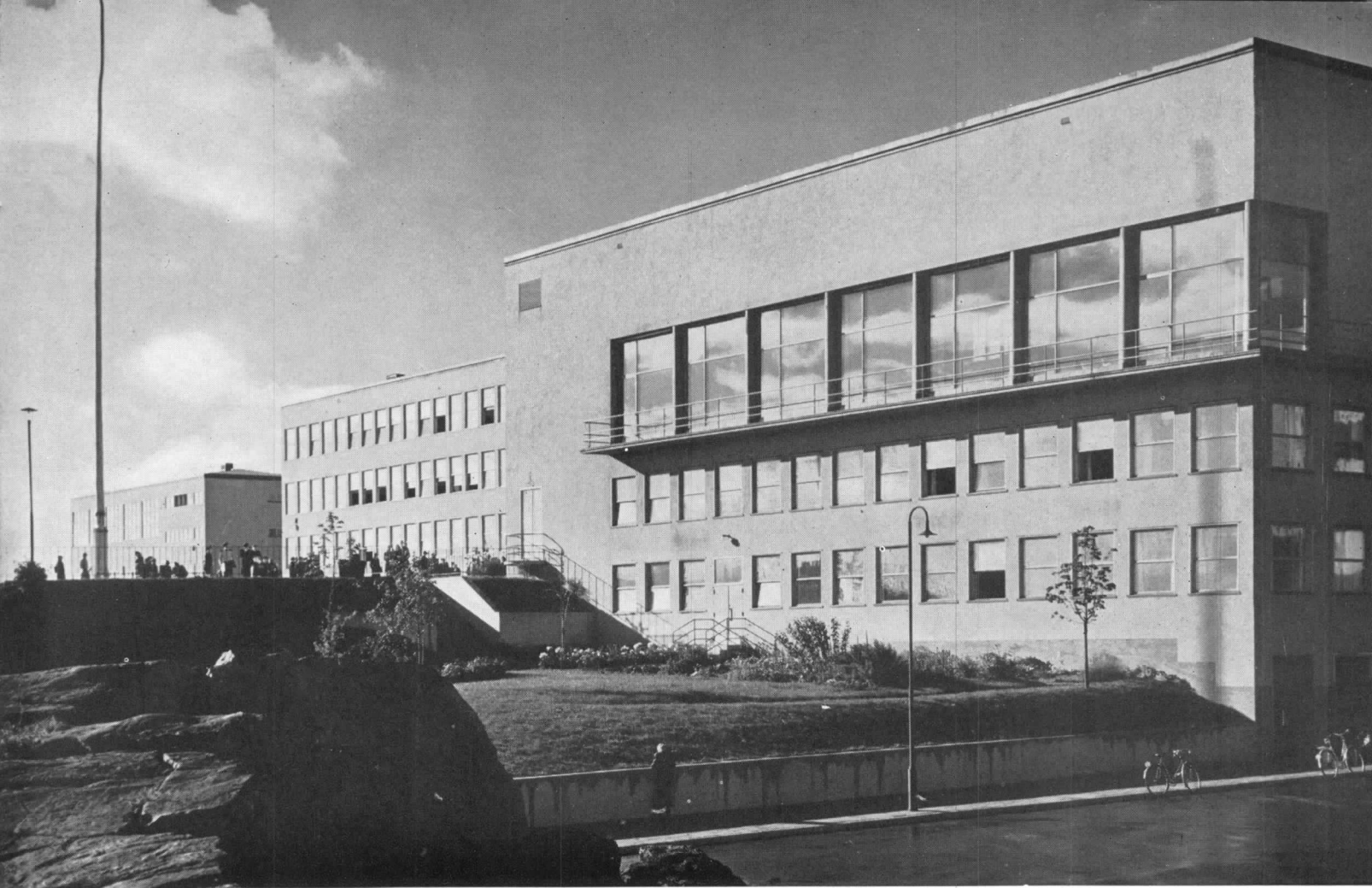

Effective multiple-level planning, necessitated by hill-top site; large auditorium windows and balcony give magnificent view (interior, page 47). SOUTH JUNIOR HIGH SCHOOL, Stockholm, Paul Hedquist, architect

LESSONS FROM SWEDISH SCHOOLS

By G. E. KIDDER SMITH, AIA*

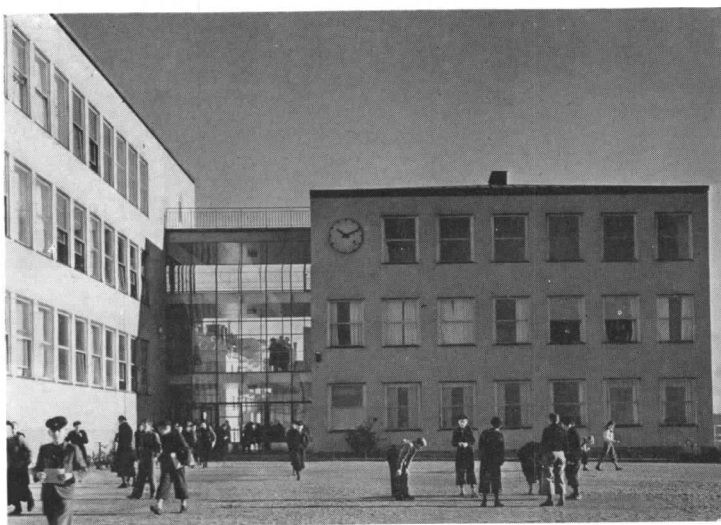

G. E. Kidder Smith

A light, glazed passage connects classroom and administrative units

THERE is no doubt that schools will be a major need in the post-war Design for Democracy. And they will be one of the first types of buildings to be erected—especially if they are planned now with that in mind. Wise municipalities are building up their “blue-prints for V-Day,” to be ready to build the many needed schools.

Much can be learned from the Swedish experience and success, which has been largely due, to the enlightened, progressive and open-minded Boards of Education that have fostered the sound approach to planning and have encouraged the architects rather than stifling them with limiting traditional mandates. The results are worth careful study and adaptation—schools well designed for their purposes, efficient in operation, economical in cost, spacious, sunny and pervaded with cheerfulness and wellbeing.

* The author's photographs and observations were made possible by a Fellowship of the American Scandinavian Foundation.

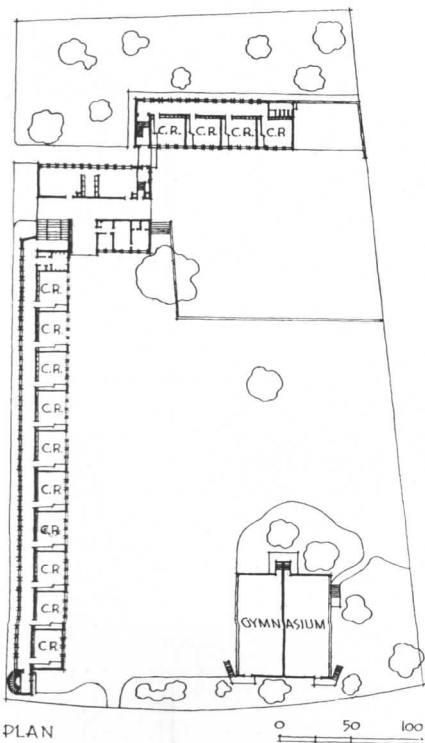

An elementary school scaled to the size of the pupils. In plan, the wing for the smallest children (upper right) segregates them from the others and provides their own separate playground. Above, the auditorium wing spares the existing tree which makes an attractive adjunct of the design. Below, the gymnasium is in a separate unit, divided for boys and girls; locker-rooms, dressing rooms and showers are below. Construction is reinforced concrete and common brick covered with white stucco. FREDHALL SCHOOL, Stockholm, Paul Hedquist, architect



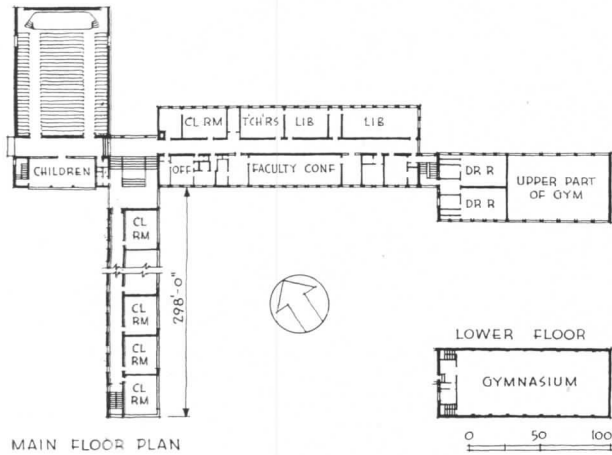

Large school sites are considered essential in Sweden, to permit free planning, and proper orientation, to provide playgrounds and athletic fields, to give a maximum of light, air and sunshine and to afford a certain amount of isolation from surrounding streets and buildings. The main entrance to this school is through a glazed connecting hall which serves the auditorium at the left, classroom wing at the right, and administrative offices and laboratories. This permits units to be used separately or together, closing off those not in use. Below, the school from the south, showing classroom wing at left, administrative and special rooms, center, double gymnasium at right. BROMMA HIGH SCHOOL, for 1,000 pupils, Paul Hedquist, architect

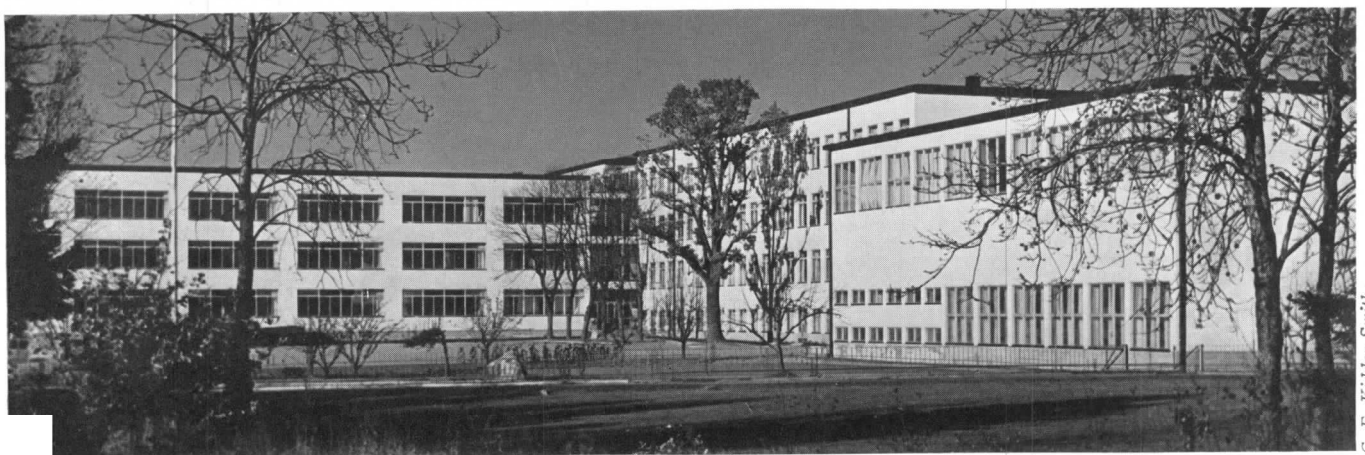

G. E. Kidder Smith



The principle of dividing the school building into functional units, joined by passages, is clearly shown. Later schools have further separated ordinary classrooms from laboratories and special rooms

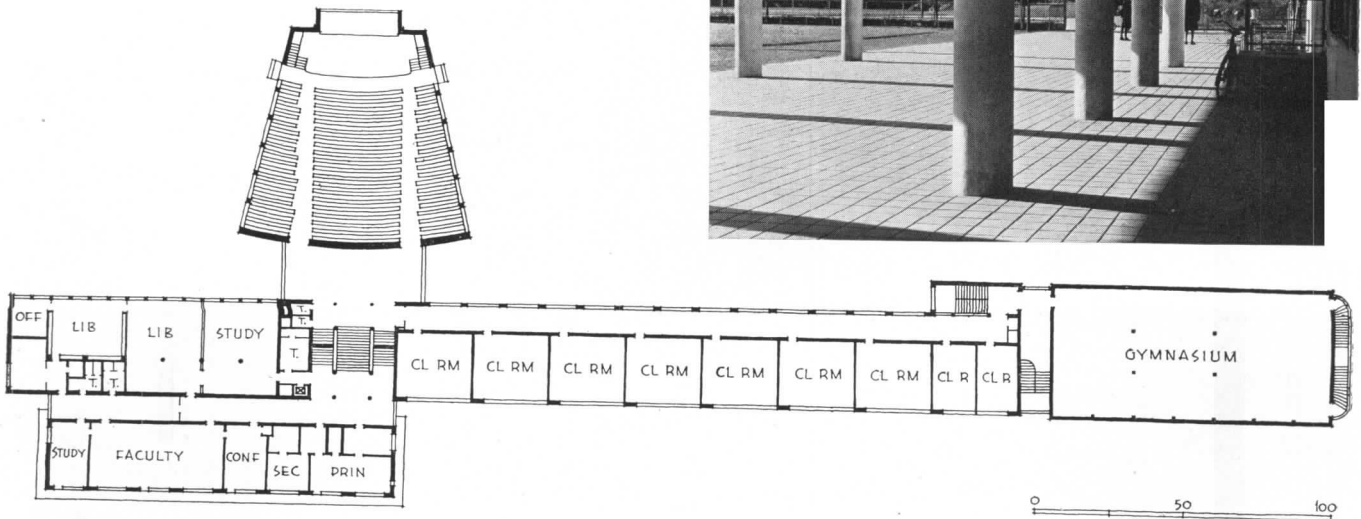

New ideas are frequently brought to light through architectural competitions. The winning design for the SECONDARY SCHOOL FOR GIRLS, Stockholm, Ahrbom & Zimdal, architects, brought about the innovations shown on this and the facing page. It was one of Sweden's first modern schools and has had its influence on subsequent design and planning. The natural functional units of the school are separated by passages or stair halls to permit them to be used separately and for ease of control. The connecting links are fully glazed and give a sense of space as well as assuring safety because of good light

The photograph at the right shows the passage connecting the main portion of the school with the auditorium. Access to the auditorium is at two levels. In the foreground is the bicycle shed, which is a necessity in Swedish schools and is increasingly desirable in American schools, both for the war period and probably thereafter. The long facade of the building is broken visually by the vertical leaders which serve the flat roofs



G. E. Kidder Smith

The gymnasium of the SECONDARY SCHOOL FOR GIRLS is separated from the main classroom building by a stair corridor. This insulates the main building from the noise of gymnasium activities. The windows are high above the floor to provide space for apparatus along the walls. Outward-opening casements are operated in banks to give through-ventilation. A horizontal visor extends over these windows, giving a protection from rain or excessive summer sun. The dressing rooms are below the gymnasium. The simplicity of the door details is worthy of note as are the long handles which can be used easily by both big pupils and small ones

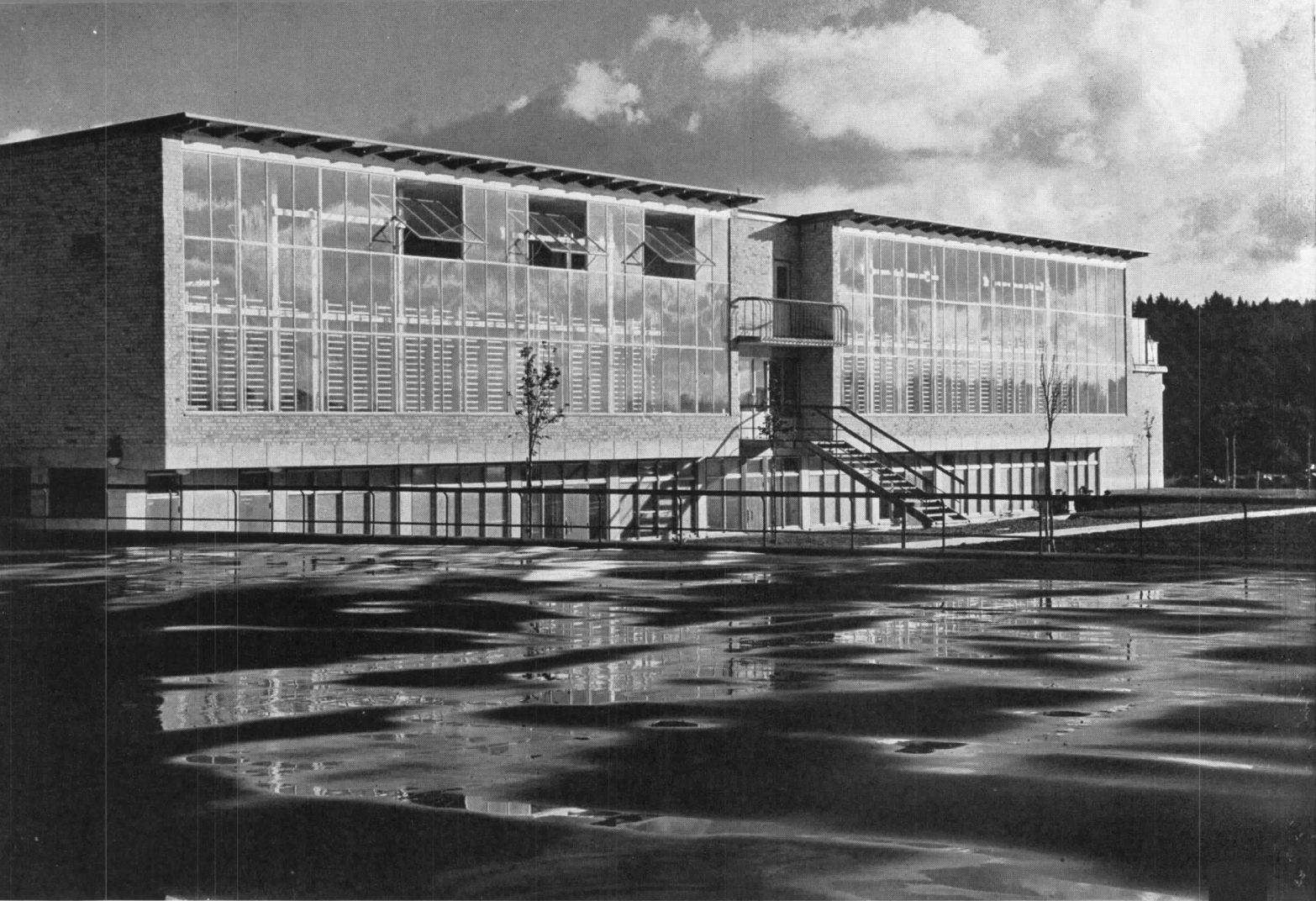

This school is really two in one—an elementary school and a school for domestic sciences. There are many special rooms, such as kitchens, sewing rooms, laboratories, craft rooms, etc. The school is built of local yellow brick over a reinforced concrete frame, and provides facilities for 2,200 pupils in 59 classrooms. It is usually considered in Sweden as being too large. The large gymnasium, shown above from the playground, is divided into four equal areas, two on either side of the central corridor and stairs. Lockers, dressing rooms and showers are below; playground, tennis courts and natural areas surround the building. There is a solarium at the far end of the building which overlooks the river. The photograph at the left shows the wing of the primary school in the foreground, with its vertically glazed stair; the administrative wing in the center, flanked by a classroom bank on its left. ERIKSDAL SCHOOL, Ahrbom & Zimdahl, architects

Plan showing the extensive area covered by the large school and the careful attention paid to orientation and landscaping. Pictures were taken before planting developed

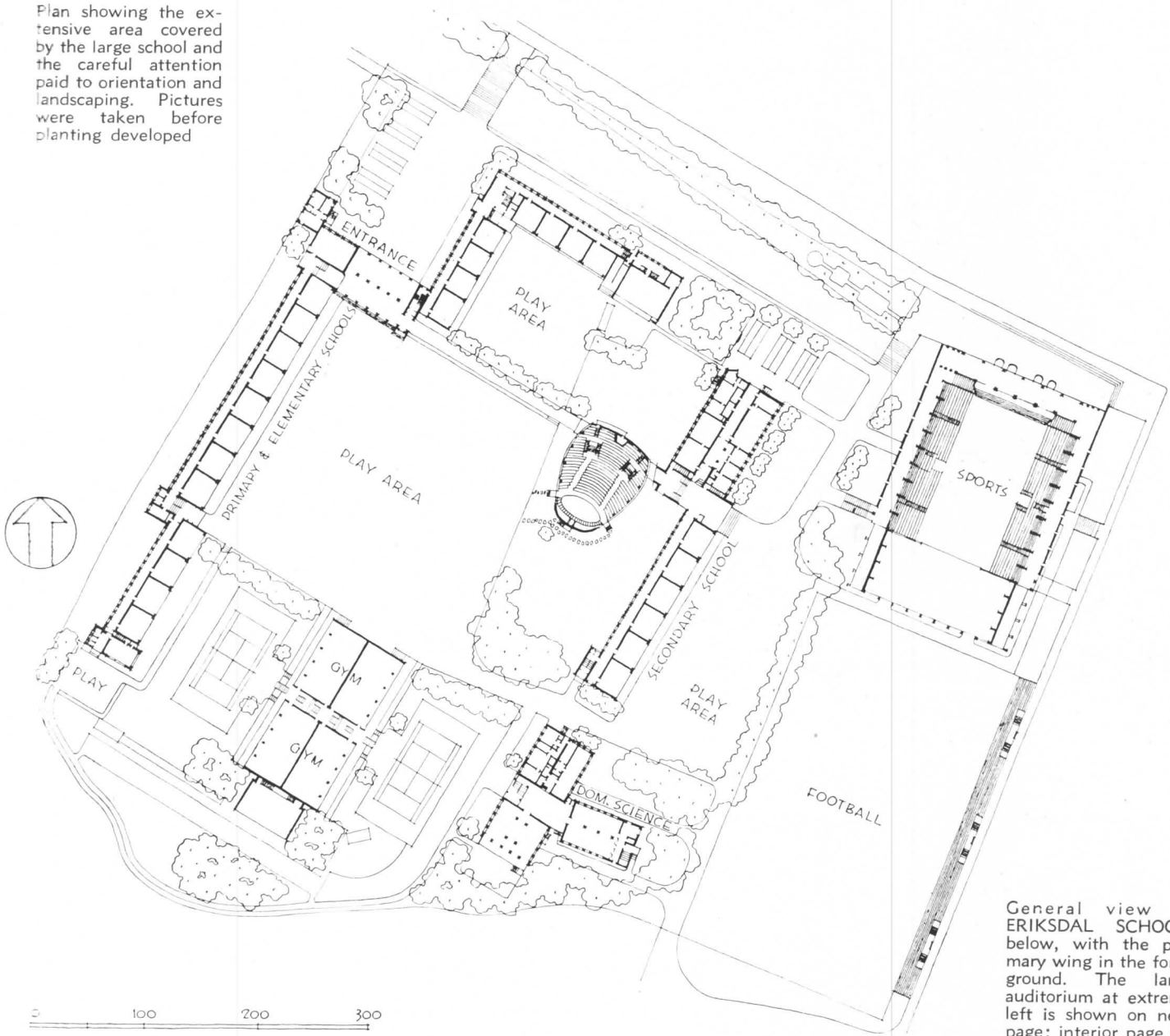

General view of ERIKSDAL SCHOOL, below, with the primary wing in the foreground. The large auditorium at extreme left is shown on next page; interior page 48

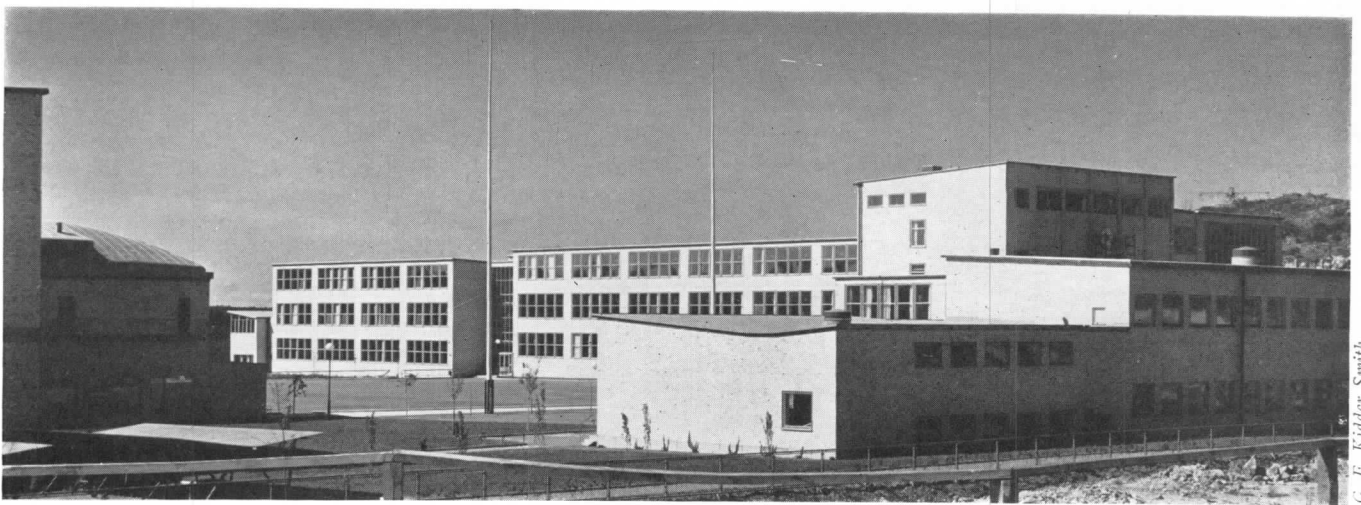

G. E. Kidder-Smith



Left, exterior of the auditorium building from the north; domestic science buildings and laboratories at right. Continuous bank of windows lights the auditorium from above the topmost tier of auditorium seats. The double brick wall has heating pipes between and is open at the top. Ducts for air conditioning are over the stage (see page 48)

The tennis and sports hall is used for competitive athletics and is integrated with the main playing field. It is used also by the public for meetings, concerts, exhibitions, etc., and has a seating capacity of 2,200, or 4,000 when the floor is used for seating. Dressing rooms, showers, etc., are under the tiers of seats and there is a stage at one end

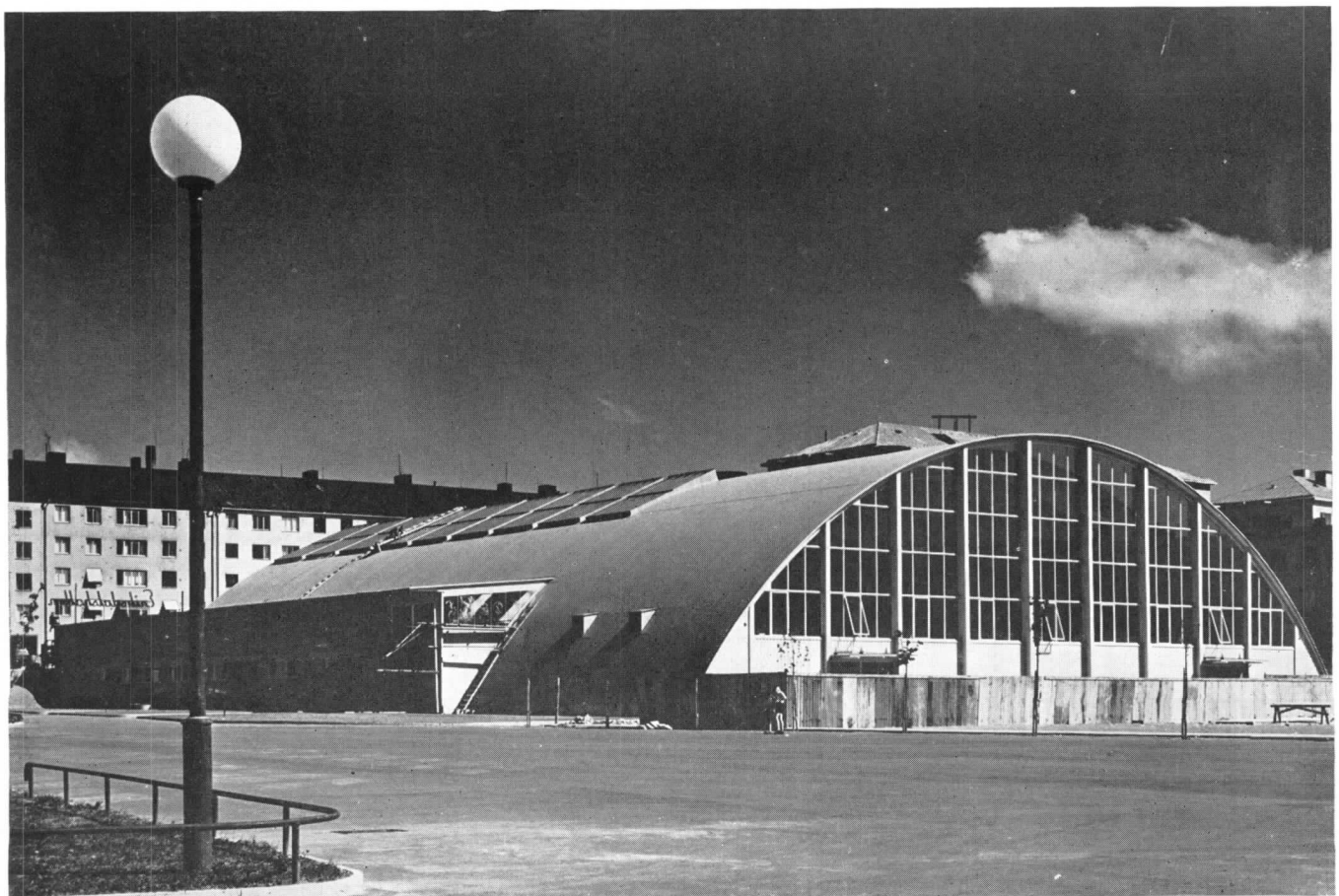



IDEAS FROM THE INTERIOR ARCHITECTURE OF SWEDISH SCHOOL AUDITORIA

The same straightforward simplicity which marks the exterior design of Swedish schools adds distinction to the interiors, which are designed in the same spirit. Above, the auditorium of the FREDHALL SCHOOL might seem bare without the soft folds of the straight-hanging window drapery, which is both useful and ornamental. The wood of the ceiling and lower cord of the built-up wooden trusses is carried down over the windows as a decorative feature. The auditorium is so oriented as to receive the cheerful morning sunlight. The chairs are of a close-stacking design

The low windows at the right of the auditorium of the SOUTH JUNIOR HIGH SCHOOL are arranged to take advantage of the view across the countryside. The complete simplicity of design, the effective use of free curves and the contrast of texture and color are worthy of note in this design. Bracket illumination is used at the right, supplemented by globes at the window side. A curtain can be drawn across the platform

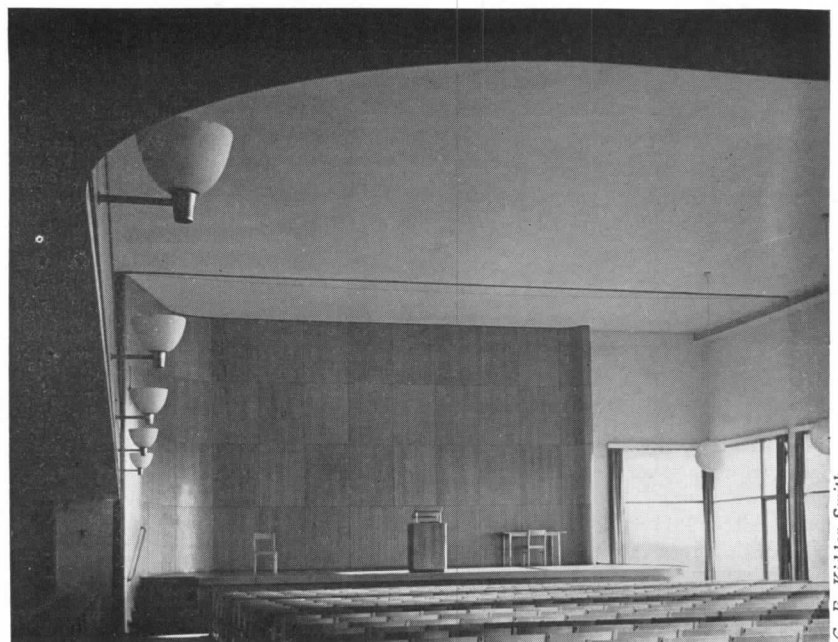

G. E. Kidder Smith



The stage is the focal point of the large ovoid auditorium of the ERIKSDAL SCHOOL. Curtain can be drawn around the stage and the organ console can be rolled off through the sliding door at the back. Air conditioning vents dot the ceiling above the stage

The stage of the SECONDARY SCHOOL FOR GIRLS is backed by a large window so arranged as to show the organ pipes. This feature has not been adopted in later schools. The smaller sections of the graduated horizontal window panels are movable, to admit sound. The organ is typical of all Swedish school auditoria



INTERESTING DETAILS FROM CORRIDORS AND CLASSROOMS OF SWEDISH SCHOOLS

One very rarely finds an ill-lighted corridor in modern Swedish schools; they are designed to be as pleasant as the classrooms or any other rooms. Usually they are lighted by the maximum glass area, simply divided. The corridor end, right above, is a case in point from the SECONDARY SCHOOL FOR GIRLS in Stockholm. The doors are almost universally flush-type, set flush with the walls. The coat hooks (shown in both photographs) are satisfactory for Swedish conditions but American practice dictates lockers



The corridor of the ERIKSDAL SCHOOL is shown below, right. Windows have a pleasant, large reveal and every fourth opening, opposite each classroom door, goes full length to the floor. Growing plants are a pleasant addition in these window recesses. Lights above each door provide corridor illumination and indicate both the floor and the number of the classroom in such a way as to be visible the entire length of the corridor. Note also the unobtrusive, thin corridor radiators



G. E. Kidder Smith



The well-lighted mural wall frames the auditorium doors in the SECONDARY SCHOOL FOR GIRLS, Stockholm. The low bench over the radiator is for the comfort of early-comers



Openings are glazed to the utmost for light and sense of spaciousness. Entrance doors, BROMMA SCHOOL, Stockholm. At the right, simple pre-fabricated concrete risers and treads are laid on reinforced concrete stair beams in the ERIKSDAL SCHOOL

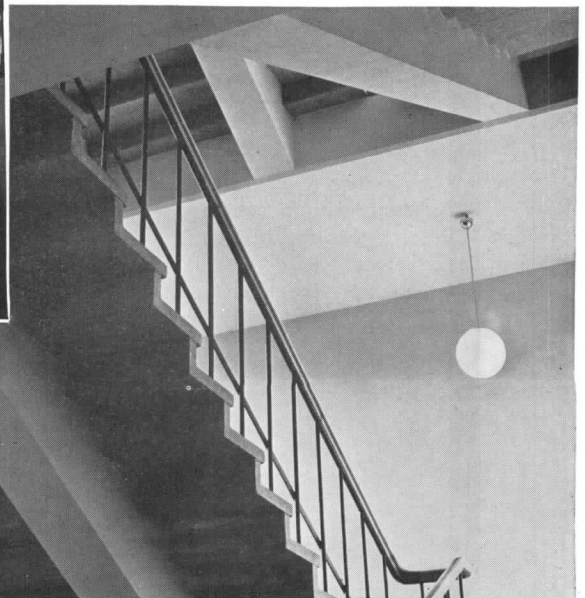



In the experimental science laboratory of the SECONDARY SCHOOL FOR GIRLS, below, work tables are arranged in tiers, to permit full view of demonstration platform. Work-top recesses carry electric and gas connections for experiments

Swedish schoolroom windows are usually simply but effectively curtained. They are large-paned and usually double-glazed for insulation. Three window types are here shown. Below, the banked seats of the demonstration laboratory in the BROMMA SCHOOL are both pleasing and servicable

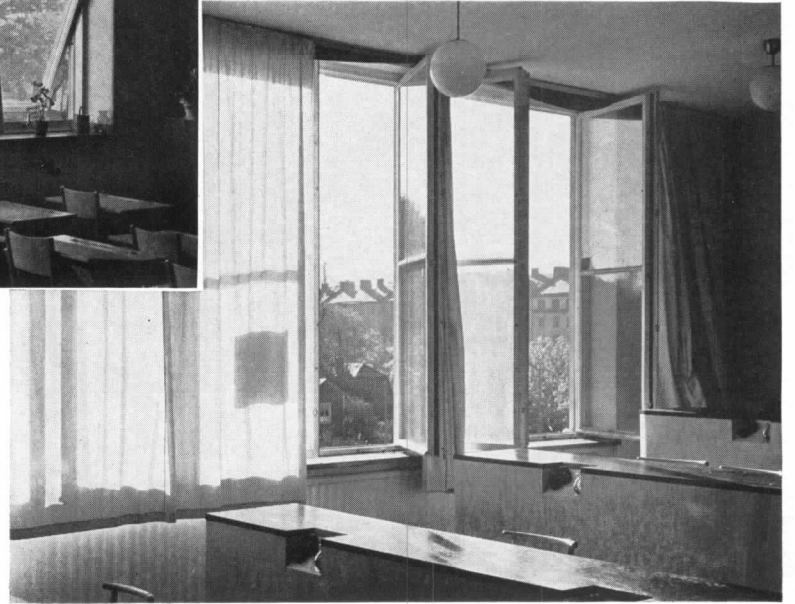

G. E. Kidder Smith



The restful simplicity of the faculty room in the BROMMA HIGH SCHOOL: convenient writing desks are ranged near the windows; the conference table is lighted by a single row of dome lighting fixtures

Below, the typical clean lines of the Swedish gymnasium are shown in this photograph of the SECONDARY SCHOOL FOR GIRLS. The lines of the omnipresent bar stalls, ladders and booms are integrated parts of the design. Gymnasias are used for calisthenics, drills and training exercises, while various sorts of competitive games involving spectators are often relegated to separate buildings, as in the ERIKSDAL SCHOOL (page 44)



G. E. Kidder Smith



DEPARTMENT STORE IN TEXAS

White House Dry Goods Co., Beaumont, Texas • Stone & Pitts, Architects

SKILLFUL guiding of shoppers past merchandise displays is a basic objective in department store design, both exterior and interior. Here this consideration fixed the location of principal elements of the plan. The main entrance, primarily for women shoppers on heavy-traffic Orleans Street, was placed centrally, to guide shoppers past window displays. Male customers got a secondary entrance on medium-traffic Forsythe Street, to let them escape the women's departments. Except for this concession to the busy business man, shoppers are carefully routed past display counters. There is also a customers' drive-in entrance in the rear.

On the inside, traffic is pulled the length of the main floor by placing the elevators at the rear, on an axis with the main entrance. Soda fountain and lunch counter are placed to draw traffic through side aisles. On the second floor, general offices are at the front, to lead



Main entrance on Orleans street

St. Thomas

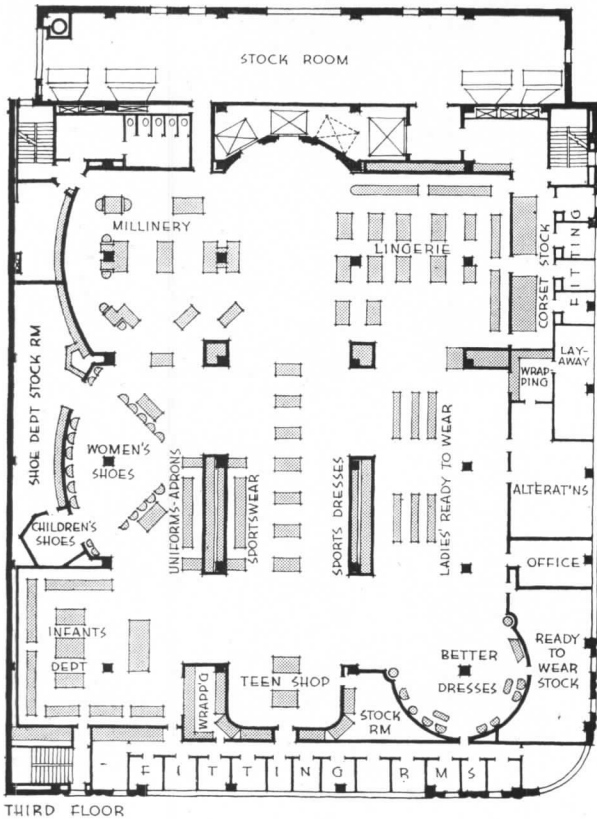

THIRD FLOOR

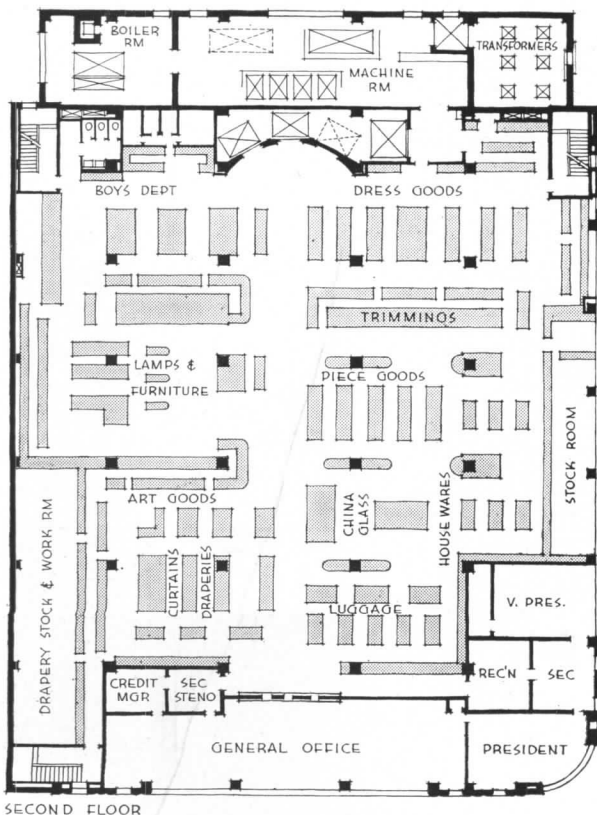

SECOND FLOOR



Vehicle driveway to parking lot at rear

people the full length of the displays. On the third, focal interest points were created at the opposite end from the elevators, but visible from them. The building is completely air conditioned for both winter and summer, in a zone system to accommodate crowds at special sales.

The continuous windows provide maximum light for fitting and alteration rooms, stock rooms and offices.

To have fireproof construction, efficient lighting, year 'round air conditioning at a moderate price, say the architects, it was necessary to work in simple forms and materials. The complete building, including everything but store equipment and lighting fixtures, was constructed for 33c a cubic foot.

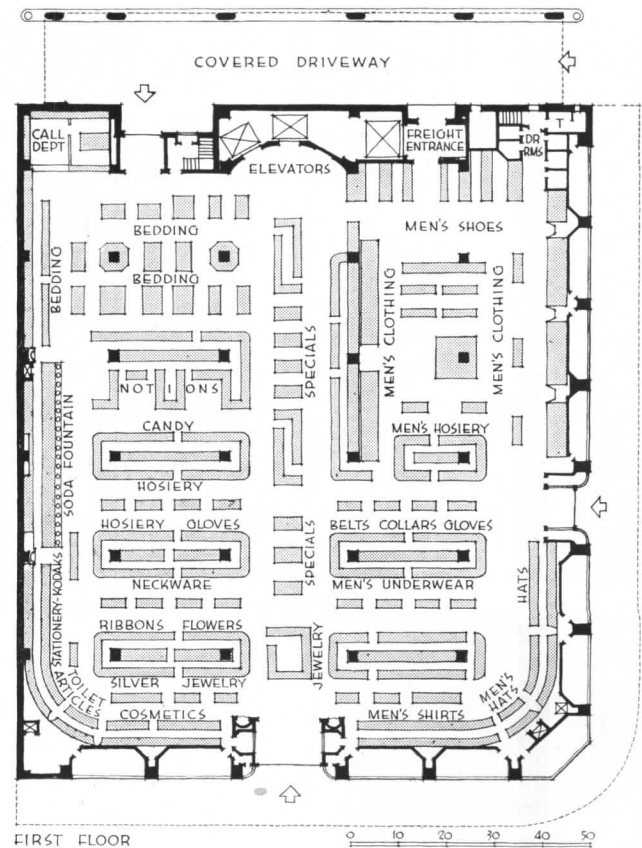

FIRST FLOOR

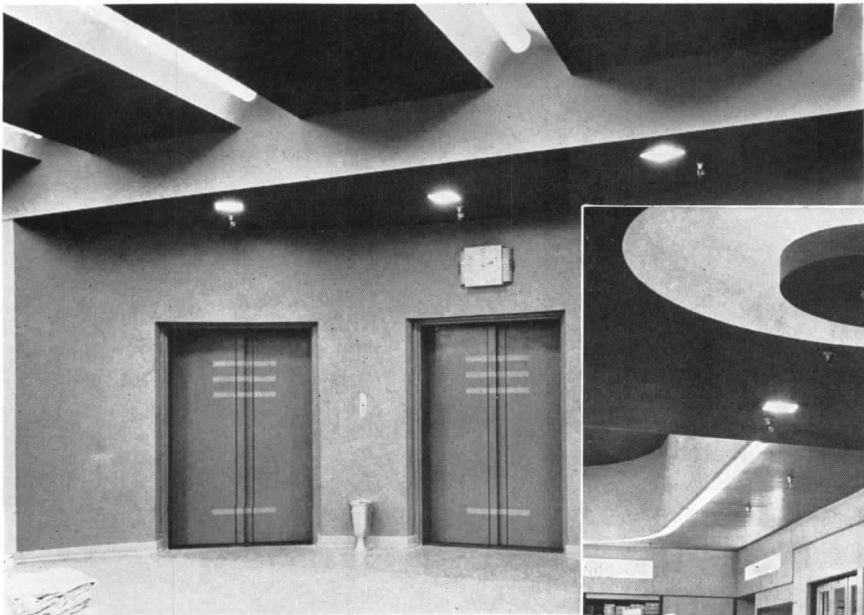

View (above) from first-floor elevator landing to main entrance on Orleans St. Floor here is terrazzo; store equipment fixtures are of bleached pin oak and prima vera. A complete sprinkler system was installed; pipes are concealed



Entrance from parking lot as seen from first floor elevator landing (right). Third floor elevator landing (above). Lighting is a combination of recessed lights with incandescent lamps, indirect incandescent lights with plaster coffers, and direct fluorescent lamps in long rows

St. Thomas



Central aisle on the third floor (above). Emphasis of long straight lines in the fluorescent lighting helps in the effort to lead shoppers to more remote displays. Floor here is carpeted; wall paper and photo murals on walls



View (left) of customers' drive-in entrance as seen from parking lot. Extreme weather conditions, with both bright sunshine and heavy rains, called for a covered entrance, covered passageway to parking lot, and marquee

St. Thomas

ACT NOW ON LOCAL PLANNING!



By WILLIAM STANLEY PARKER, FAIA*

Long-range planning, based on a realistic capital budget program, will mean more to the community and to its architects and engineers than wishful thinking. We must not be too little or too late.

MEMBERS of a profession, in the natural order of things, apply their professional capacities to the general public good as well as to the pursuit of their own professional income. Architects, as members of the planning professions, have a contribution they can make in the field of the orderly, planned development of their home cities and towns. This can be done not only through personal service on city plan commissions, housing authorities, and other governmental agencies, but also through group action that will bring pressure upon the local government to recognize the importance of comprehensive planning and to provide the planning commissions with staffs necessary for the efficient performance of their functions.

But that is not enough. Too much city planning in the past has been unrelated to the municipality's financial ability. Also financial policies have too generally been short-range, year-to-year policies, with no adequate appraisal of the future. Short-range financial policies and unlimited wishful thinking in the field of planning do not and cannot result in sound, orderly development. What is needed is long-range financial policy involving a long-range capital outlay program properly related to a master plan indicating the still longer-range scheme for municipal growth.

Therein exists a fertile field for action by the architectural profession through the local architectural organization, AIA Chapter or State Association. The architects' training will lead them to accept without question the validity of this idea. Their organization provides a means of bringing this idea forcibly and steadily to the attention of the mayor of their city or the selectmen of their town, and to the public, until adoption of the idea is secured.

Architects can act by themselves or, if local inter-professional relations are propitious, can bring about cooperative action by the architects, engineers, landscape architects, and city planners and add weight to their attack. It is not enough to pass votes and send copies to the officials. Strong committees, led by effective chairmen, must make it a personal matter, secure a conference with the mayor or selectmen, and do a real selling job—and it's a relatively easy thing to sell.

The federal government, through the work of the National Resources Planning Board aided during the past year by the Public Work Reserve—latterly called the Local Public Works Programming Office—has gone far to spread the idea of long-range programming and to teach the techniques involved. The field has been ploughed and har-

rowed and a lot of good seed planted. Architects should take up the task of watering this ground and nursing the seedlings that have already sprouted in a number of communities in the shape of long-range programs and capital budgets.

In any given state the architects can easily find out the present status of the movement from the national or regional Office of NRPB. Each architect or group of architects in a given community can then organize to take such action as the local situation requires.

Where a completed capital budget program has been developed, let the public officials know that the architects, as citizens, approve the idea and recognize the forward-looking attitude that has brought the program into being. This evidence of public support may be potent in sustaining the idea and securing its adoption as a permanent routine.

Where a capital budget study is under way, convey an expression of interest and support which may help greatly to encourage those officials who are making the study and to secure official approval when the report on the study is finished.

Where a study has been suggested and turned down or where it has never even been considered, take the initiative and urge that the study be made.

We find it easy to criticize government spending but few are in a position to realize clearly the benefits that have accrued or can accrue to our city as a result of federal government research. It is sound procedure for the federal government to develop and make available to all state and local governments improved techniques that can best result from research by a federal agency. The waste in such effort is caused when local government fails to make use of the results of such federal research.

In this case the research is completed and federal guidance is available to municipalities that desire to take advantage of their opportunities. The architects can well serve their communities by bringing their organized pressure to bear on local officials to bring about an understanding of the benefits that will accrue from a long-range program which represents an orderly process of looking ahead. Now, more than ever, this is a desirable if not indeed an indispensable procedure; and the architects and engineers can take the initiative to bring this about—if they will.

* Consultant to the National Resources Planning Board in the field of Public Works Programming in New England.



Interior view of all-glass front



MODERN IDEAS

Store for S. S. Pierce Co.

Architect: John Matthews Hatton

Engineers: Jaros, Baum & Bolles, heating, ventilating;
Smith & Silverman, lighting; S. J. Kessler, structural.
Contractors: Schweers & Smith, Inc.



View of liquor department from rear of store

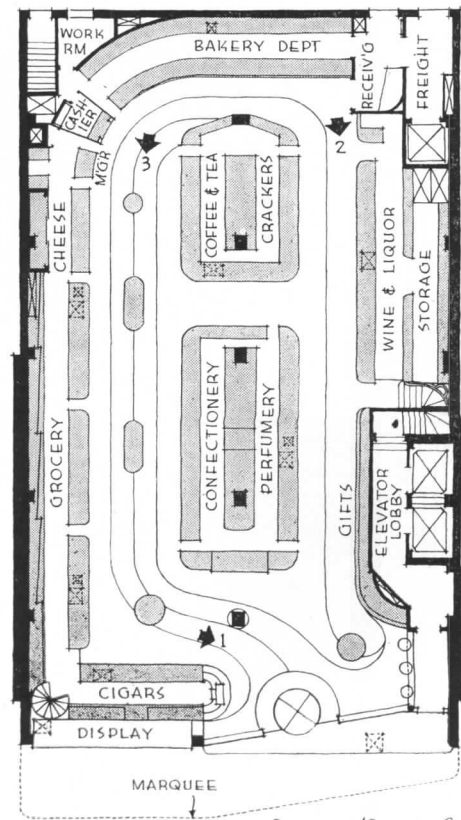



An off-center column in the facade suggested a display window in the smaller part and an all-glass store front and entrance displaying the activity of the whole store. To save space the office building entrance was incorporated with the store front. A cantilever marquee extends across the full front, its white soffit being softly floodlighted

SERVE A BOSTON TRADITION

PRINCIPAL motif of the store is the display and lighting of merchandise, the merchandise being used as the decoration. Continuous fluorescent tubes concealed at seven-foot level highlight merchandise in wall cases. Lenses in ceiling lamps pour light down on counters and showcases. The acoustic ceiling is done in dark gray-blue, to minimize its value in the color scheme. Straight-grain blond white

oak constitutes the frame for the merchandise. Wide aisles, flowing curved lines keep crowds moving easily through departments. A curving stairway with red leather walls leads to the wine cellar. Stock rooms fill the basement, with under-counter electric dumbwaiters serving sales departments above. In the new store, business volume increased by 200 per cent.



Focused ceiling lights and concealed fluorescent tubing direct attention to the merchandise

Paul J. Woolf

WALLACHS



MEN'S STORE REMODELED FOR

Wallach's Men's Store, Brooklyn, N. Y.

Architect: Morris Ketchum, Jr.

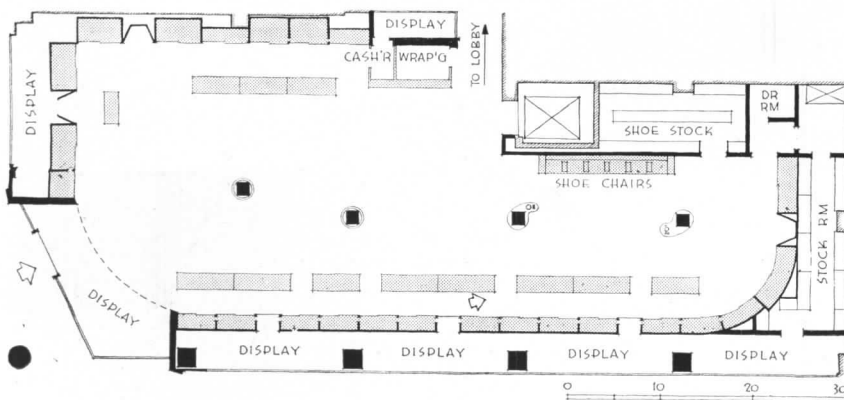

A DOZEN years after it was opened this store was obviously outdated, so fast is the pace in store design. To improve the view inward from a recessed corner entrance, the front is all-glass, with a small open display. Roominess and light characterize a once-dark interior. Walls are paneled in bleached walnut; easy chairs of the same wood are upholstered in crimson leather. A liberal use of mirrored walls enhances the new feeling of spaciousness. Large, awkward columns were reduced as much as possible and finished with woven hardwood covering. Outlines are round or kidney-shaped, depending on piping to be enclosed with the column. Ceilings were furred down below the beams, and curved at the walls to form a light cove. Lighting is the narrow, gas-type fluorescent tubing.



Ezra Stoller

MODERN MERCHANDISING

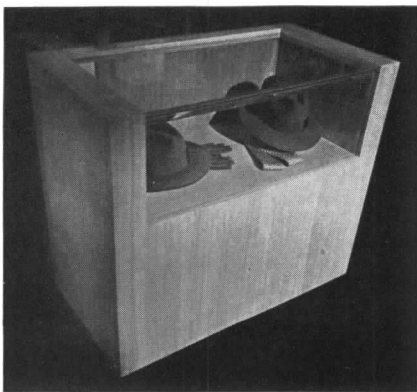

Especially successful are the transparent plastic shoe cases on the arms of the chairs. And enclosing the columns with curves instead of corners permits eye-catching shelves. The lighting is another merchandising help; each channel carries four narrow gas-filled fluorescent tubes—three white ones favoring the merchandise, one red one favoring the customers

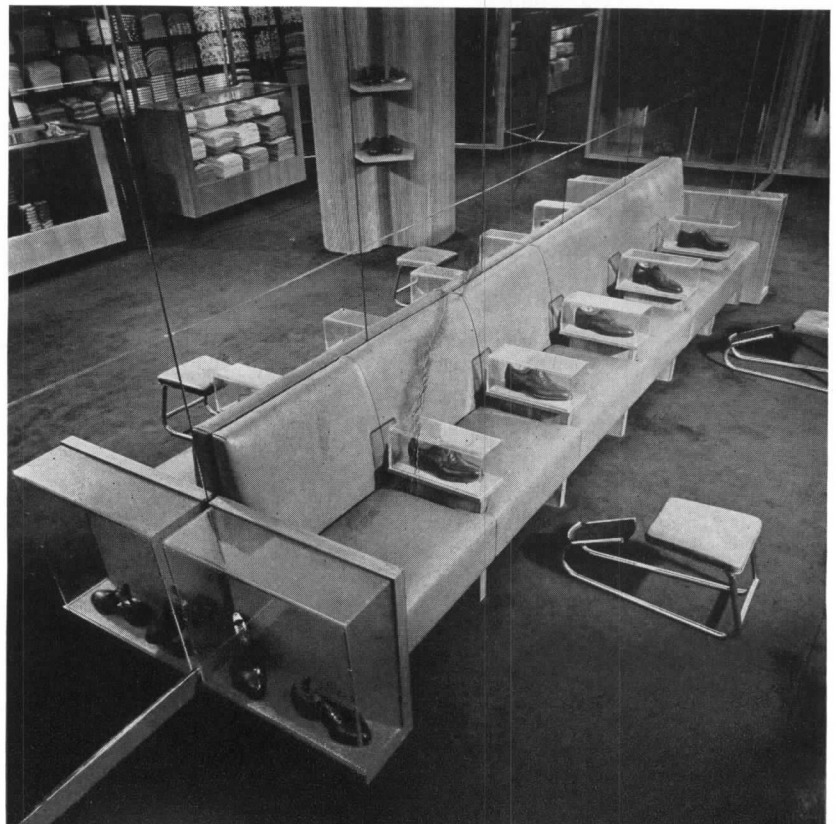



SHOPPING FACILITIES IN WARTIME



NEWEST PHASE in the war construction program, just now beginning, is the building of shopping centers for war housing developments. This new program just happens to coincide with the further restriction of normal store building work through the recent revision of the L-41 order. While, as Morris Lapidus points out in these pages, it is still possible to work style changes in existing stores, new store construction in non-war areas is certainly out, for the duration.



It is now two years since the great program of "defense" or "war" housing began, and practically all of the shopping facilities are yet to be built. Many of the housing developments are good-sized new towns in themselves, and many are new towns also in the sense of being far removed from any existing communities. But so far most of the shopping centers have been just blank spots on the site plan.

Now, however, it is clear that new, isolated communities must have shopping facilities, and the FPHA announces that those blank spots will be filled. Driving "to town" is a rapidly disappearing luxury, and private capital is obviously loath to build store buildings in communities of uncertain future. The FPHA announces the store-building program thus:



"It is the policy of the Federal Public Housing Authority to provide, or sponsor the provision of, facilities for essential retail commercial enterprise on or adjacent to all projects where existing retail commercial facilities are not adequate to serve essential consumer needs, or where such retail commercial facilities do not exist.

"Private enterprise is encouraged to erect buildings, or to lease buildings or space provided with Federal funds, in order to provide the commercial facilities needed by project occupants.

"The commercial facilities provided or sponsored for any project by the Federal Public Housing Authority include only the minimum services that are essential to maintaining the health, welfare, morale, and efficiency of war workers and their families."

The shopping centers won't look like Fifth Avenue, and the new stores won't sell Fifth Avenue merchandise. But they do represent the newest obligation of the architect to the war effort. And they take him into almost uncharted seas, for the planning problems are new and the materials restrictions will tax his ingenuity.



And what about stores that do not rate priority preference? The new L-41 cuts down construction allowances—from \$5,000 to \$200. That means, of course, no critical materials for extensive remodeling. And that means that imagination must be substituted for metal. It is surprising what can be done with glass, gypsum board, paint and wall paper. In terms of construction a restyling can be a minor job; in terms of results it can be a major transformation.



ARCHITECTURAL RECORD'S BUILDING TYPES STUDY NO. 70

which enters from the east. The stores reduce in depth from 84 ft. to 48 ft. Construction is a wood roof platform, slightly pitched to the back, supported by Lally columns, and all of the walls are of the curtain type. Floor is reinforced concrete slab, laid on compacted gravel, drained. The roof platform extends out over the sidewalk, forming a continuous concourse from the theater entrance around to the restaurant. This portion of the roof is supported by 6-in. wood columns, to save steel.

The covered concourse has several advantages. First, the sheltered walk tends to equalize the desirability of various parking spaces along the front, and thus to minimize jockeying of cars. Also, it permits the entire con-

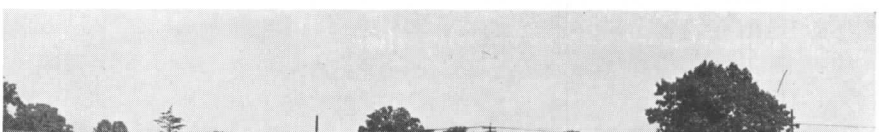

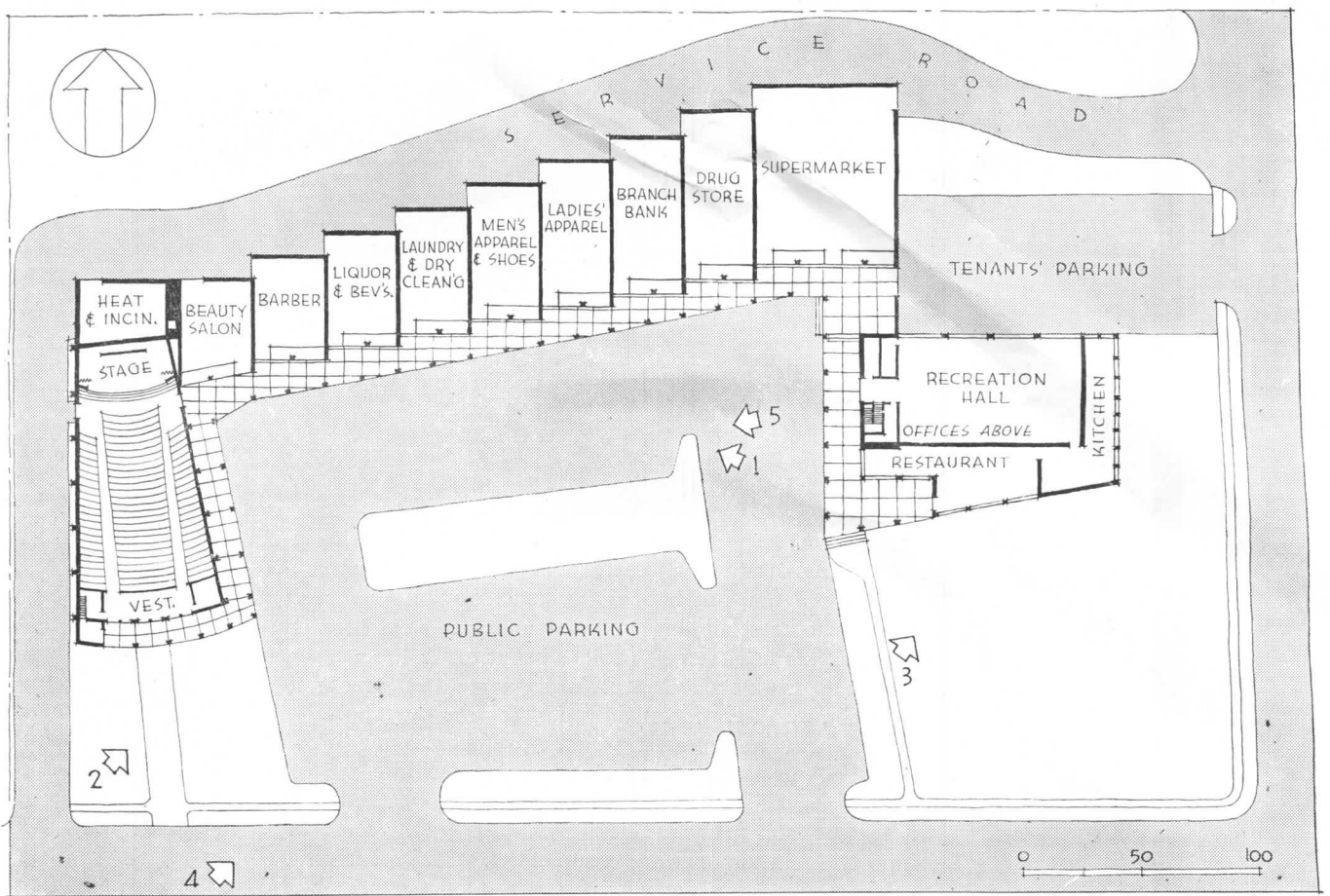

BAZAAR FOR BOMBER BUILDERS

Commercial Development for Aero Acres, Middle River, Md. Designed under supervision of Jan Porel for Glenn L. Martin Co. and Stansbury Manor, Inc. Skidmore, Owings & Merrill, Consulting Architects

NOTABLE, obviously, for points in planning, this combination of recreational and shopping facilities is notable also for experience it has already gained in a pioneer field of planning. For one thing, it gets 24-hour use,

corresponding with 'round-the-clock plant operation; thus the restaurant was enlarged and rearranged to permit a snack-bar to serve at all hours. For another, a bowling alley was considered necessary, also enlargement of

the recreation building. This addition to original plans accommodated another need: more office space on second floor for doctors, dentists, lawyers, the Red Cross, and insurance offices. And the restaurant kitchen was enlarged and arranged for serving meals to large gatherings in the recreation hall. The center serves 2,000 family dwelling units in Aero Acres, one of the developments of the Martin Co. for its bomber workers. An-



COMMERCIAL

Shopping Center for Vancouver Housing Authority (FPHA), Vancouver, Wash. A. E. Doyle and Associate, Architects

FIRST of the new federally financed shopping centers for war housing projects to reach the construction stage, this project exemplifies the paring-down process characteristic of the new program. When the problem was first posed, the elements to be coordinated included, besides shopping facilities, a 1,000-seat theater, bowling alley, beer parlor and other recreational structures. These were originally provided for in the site plans, and later dropped, at least for the present, under the essential-services-only policy. So the final plan is an adaptation of the original, and still provides for the possibility of adding recreational facilities if that is possible later.

Necessity also determined the construction, and, in turn, the form of

other 2,000 units in this area will soon call for another commercial center. The whole district is planned to develop into a new city of 75,000 population.

Rear walls of the store group are staggered to permit delivery trucks to back up to each entrance, clearing the service roadway for one-way traffic, which enters from the east. The stores reduce in depth from 84 ft. to 48 ft. Construction is a wood roof platform, slightly pitched to the back, supported by Lally columns, and all of the walls are of the curtain type. Floor is reinforced concrete slab, laid on compacted gravel, drained. The roof platform extends out over the sidewalk, forming a continuous concourse from the theater entrance around to the restaurant. This portion of the roof is supported by 6-in. wood columns, to save steel.

The covered concourse has several advantages. First, the sheltered walk tends to equalize the desirability of various parking spaces along the front, and thus to minimize jockeying of cars. Also, it permits the entire concourse to be enclosed with 1½-in. planking from column to column, forming a bomb splinter shelter and a blackout curtain which should allow the entire commercial center to function in a normal manner during extended blackouts. No electrical signs are permitted except the theater billboards. Therefore, there has been no major treatment of this item. Skylights are also forbidden. It has been found, too, that the extended roof saves maintenance expense for the merchants by keeping off the sun—the stores face south.

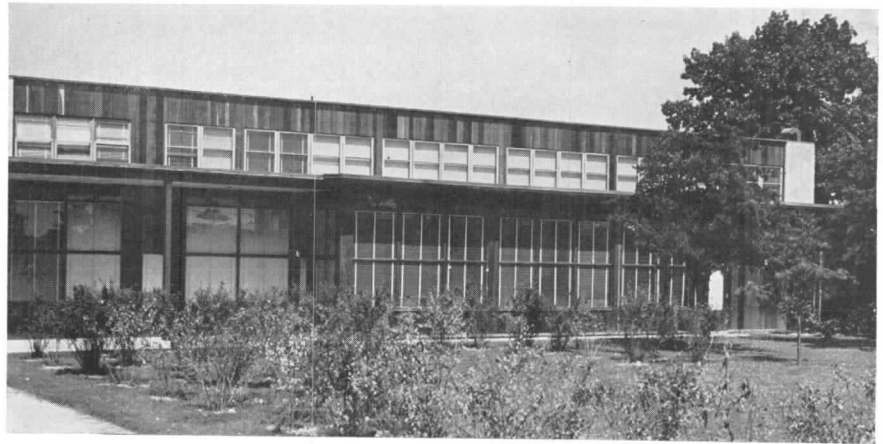



COMMERCIAL

**Shopping Center for Vancouver Housing Authority (FPHA), Vancouver, Wash.
A. E. Doyle and Associate, Architects**

FIRST of the new federally financed shopping centers for war housing projects to reach the construction stage, this project exemplifies the paring-down process characteristic of the new program. When the problem was first posed, the elements to be coordinated included, besides shopping facilities, a 1,000-seat theater, bowling alley, beer parlor and other recreational structures. These were originally provided for in the site plans, and later dropped, at least for the present, under the essential-services-only policy. So the final plan is an adaptation of the original, and still provides for the possibility of adding recreational facilities if that is possible later.

Necessity also determined the construction, and, in turn, the form of the buildings. Exterior surface will be vertical T & G Grade C pine boards, rough side out, treated with one coat of pigmented oil. Heating is provided by warm air ducts stemming from five independent heaters.

A considerable amount of study was given, by the architects and the Vancouver Housing Authority, to the type of facilities to be included and the space each should have. "As it turned out, however," reports Pietro Belluschi, of A. E. Doyle and Associate, "the preliminary work was somewhat upset later when actual leases had to be signed, as each merchant had definite ideas on how his own space should be arranged. So it appears that unless the needs are well established, the designer should favor a plan that is simple and flexible. In our case changes had to be made after the building was under construction."

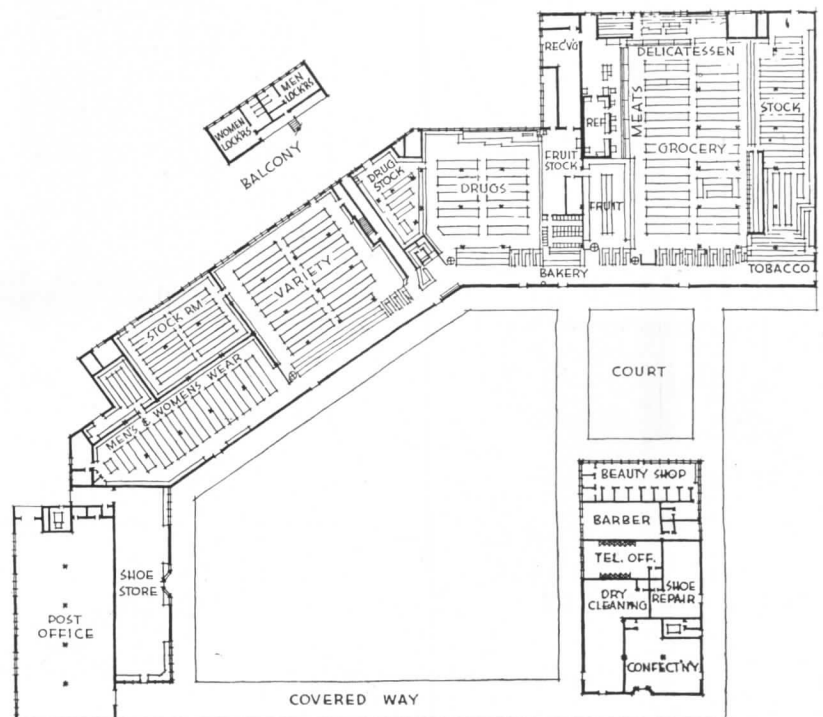

FACILITIES FOR 4,500 FAMILIES

The site plan shows the designer's concern to separate and guide the pedestrian from the automobile traffic, and the latter from the delivery traffic. Access to the center is not from the main boulevard, but from a side road. The covered passageways and canopies were dictated by the rainy climate of the Northwest section of the country.

The shopping center serves a large war housing development in the now almost fabulous shipbuilding center, housing 4,500 families. This is the first of three now being done for this busy area by the same architects.

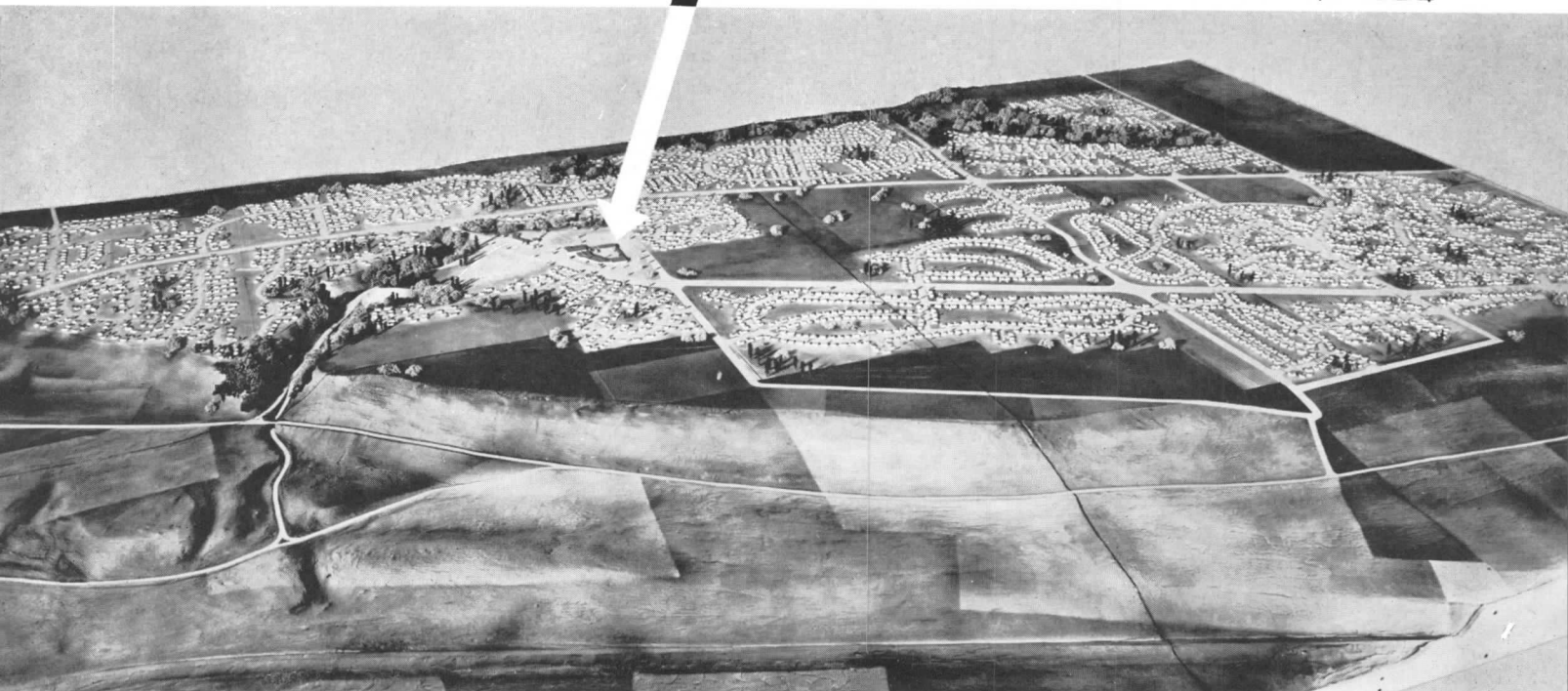
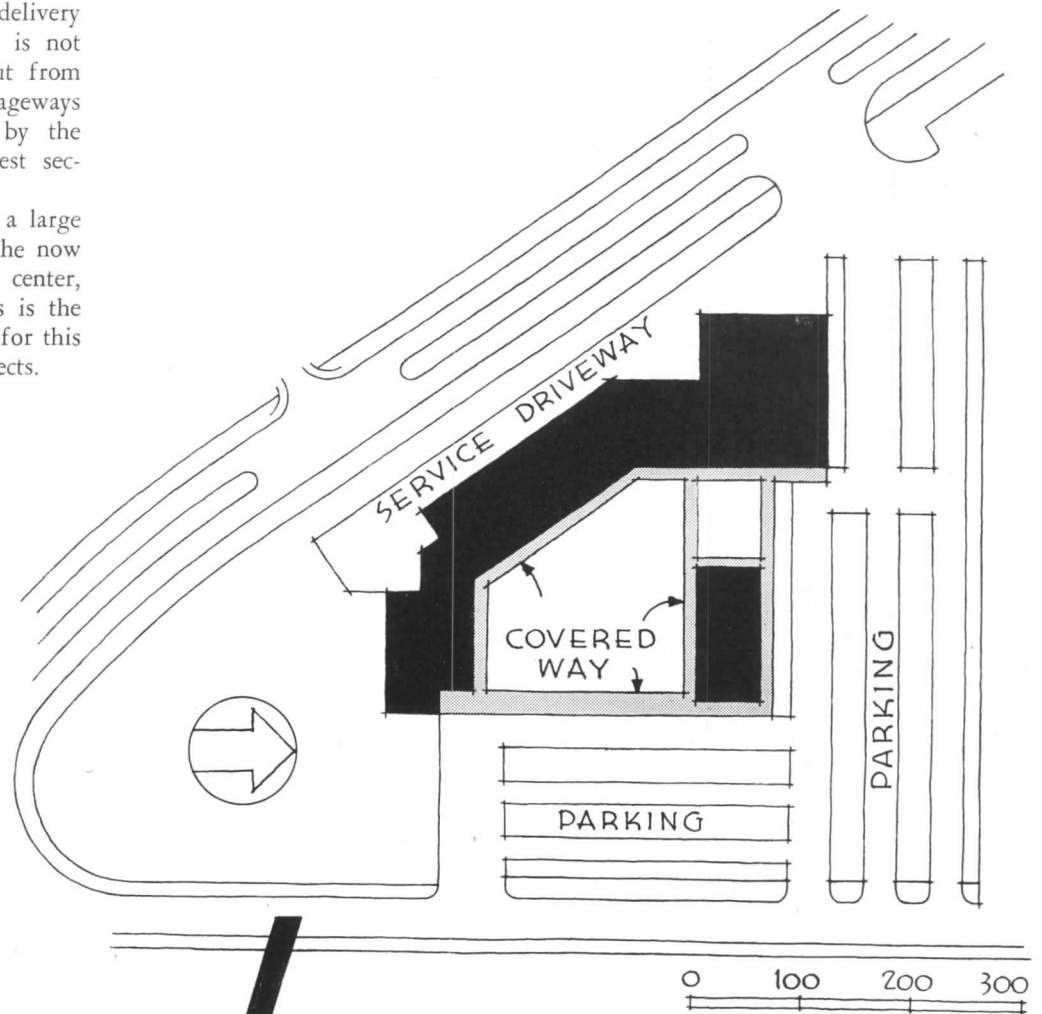

SHOPPING CENTERS FOR WAR WORKERS

Long neglected in the planning of war housing developments, shopping centers are very much a current need—a current need now the subject of hurried drawing-board work. For tire troubles and gas rationing are making shopping difficult for workers housed in isolated projects. Minimum facilities, and minimum materials, are the essential design directives.

AFTER months of hoping that private builders would fill the gaps labelled "Future Shopping Center" in site plans for housing projects, Government is now recognizing that the risk is not attractive, that Uncle Sam must do it. Even though Lanham Act funds make no provision for stores, the 3 per cent for "recreational facilities" frequently leaves room for the shopping facilities. At any rate the FPFA is now going forward with a program. It will build as few as possible, as economically as possible, with a minimum of materials.

Recently FPFA's Technical Division has issued a directive on shopping center layout, given in full below. Like similar ones for housing, this document is more a planning guide than a directive. It does define some limits and clarify some planning objectives, for designers working on FPFA's commercial centers.

One who has recently checked on

the ground for FPFA, Samuel Raten-sky of its Consultation Service, comments:

"In a countrywide program, regional differences in buying habits, distances traveled (variation in this factor is accentuated now by the fact that gas rationing is not yet nationwide) and merchandising policies make space standards subject to wide variation. However, certain elements of the problem are basic because of the war program and national policies which derive from that program: planning for minimum use of all materials and of critical materials especially, for minimum overhead and personnel, for maximum flexibility of space organization now and in the future, for convenient pedestrian access; and, above all, provision of only those services which are essential to the maintenance of the health, welfare, morale and efficiency of war workers and their families."

recreation (such as bowling, pool, etc.) is to be supplied, it should be carefully coordinated with the other recreation facilities of the project.

LOCATION OF COMMERCIAL FACILITIES

Acquisition of land. Determination of need, as set forth in "Procedure with Respect to Provision and Planning of Commercial Facilities," should be made when the site for the whole project is selected. Where the provision of commercial facilities is to be a part of the project development, enough land should be acquired for the project to include adequate commercial site or sites.

Location. Commercial facilities should be located by determining their plan relation to the project as a whole. Pedestrian access to the commercial building or shopping center should be convenient and safe and the walking distance from the farthest dwelling to be served should generally be not more than one-half mile.

For economy in construction and servicing and for convenience of tenants the shopping center should, where practicable, be closely related to the community building or management offices. Such relation may justify a location other than at the geographic center of the project population. A site at the periphery should never be chosen in anticipation of attracting transient trade.

On very large projects, where more than one shopping center is required, auxiliary facilities should be located to serve trading areas within half-mile radii.

PLANNING POLICY

Design Criteria. Design of commercial buildings should be based on:

FPFA STANDARDS

General. The commercial facilities, planned as a part of any project, temporary or permanent, whether provided by the FPFA with government funds or through investment of private capital, shall include only those services which are essential to the maintenance of health, welfare, morale, and efficiency of war workers and their families. Such services shall be provided as a part of a project only where existing services are not reasonably accessible, according to need as determined under "Procedure with Respect to Provision and Planning of Commercial Facilities," Lanham Development Manual and FPFA Development Manual inserts, August, 1942.

Type of services. The services will generally consist of:

- a. food store, including meat market.
- b. drug store, including fountain and luncheon service.
- c. variety store (or variety department in drug store).
- d. barber shop.
- e. beauty shop.
- f. dry cleaning, tailoring, laundry, shoe repair distribution station.

Additional services. Services other than those listed above should be provided only when the size and isolated location of the project make it impossible to obtain additional services in existing trading centers. If commercial

- a. organization of the various elements of the proposed enterprise for economy of operating personnel and of overhead.
- b. use of minimum quantity of materials and noncritical material wherever possible.
- c. flexibility of structure and plan to meet changing character of need during and after the war.
- d. conclusions reached during negotiations with prospective tenants to assure that space will meet equipment requirements.

Consolidation of Facilities. In each shopping center, the facilities to be provided should be assembled *under one roof* and, where feasible, *under one operating management*. Such an arrangement will favor economy of areas, partitions, utilities, and critical equipment (such as compressor equipment) and consolidation of operating personnel.

A single operating management also permits the government to negotiate *one lease* rather than separate leases with individual operators. In all instances, the single management should be a person or corporation engaging in the operation of at least one of the major services to be provided. In the case of small projects, a single lease will facilitate the provision of such services as barber and beauty shop as supplements to a profitable retail enterprise where they could not operate alone on an economic basis.

Early investigations must be made, however, to *determine if a lease can be readily negotiated* under one operating management. Where this type of organization is not feasible, the more usual subdivision of spaces in the shopping center should be provided.

Use of existing critical equipment. Services such as laundry, dry cleaning, and shoe repair involve the use of critical equipment. Since all available existing equipment should be utilized to the fullest extent possible, these services as provided in the projects should be merely distribution stations for established operating enterprises.

Parking. Adequate parking space based on unrestricted civilian use of the automobile should be reserved adjacent to the shopping center, although surfacing of such areas may be reserved

F.P.H.A. SUGGESTIONS FOR SHOPPING CENTERS IN WAR HOUSING PROJECTS

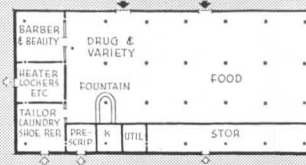

SHOPPING CENTER FOR 250 FAMILIES
(STORES UNDER ONE MANAGEMENT)

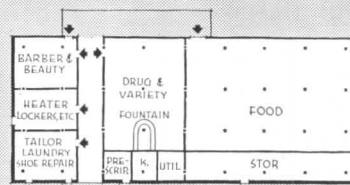

SHOPPING CENTER FOR 250-400 FAMILIES
(EACH STORE UNDER SEPARATE MANAGEMENT)

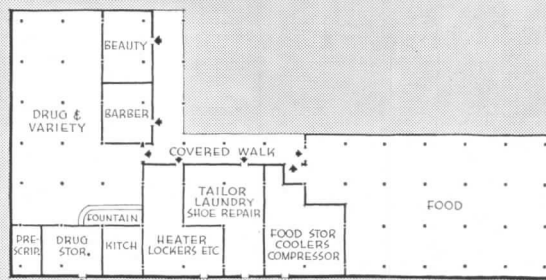

SHOPPING CENTER FOR 800 FAMILIES

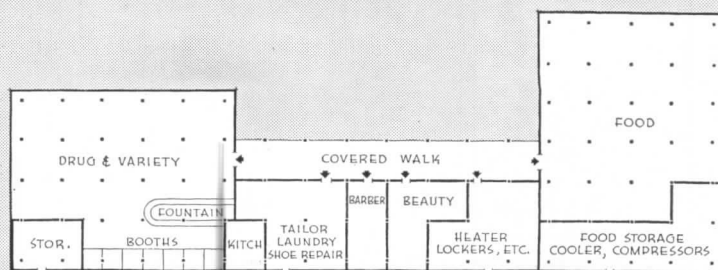

SHOPPING CENTER FOR 1500 FAMILIES

0 50 100

to a later date. Parking for 15 per cent of the number of dwelling units to be served shall be taken as the normal standard. Any smaller percentage shall be clearly justified.

Parking on perimeter streets shall not be included in a calculation of the parking space available in a shopping center.

Parking for commercial and com-

munity facilities may be combined where these facilities are related.

SPACE REQUIREMENTS

SPACE requirements will vary from project to project and according to the requirements of individual operators. Three basic types of shopping centers have been established, however, to serve as a guide in preliminary planning and in estimating costs.

Spaces as set forth in the table at the left are based on consolidated organization, and are subject to increase when subdivided into independent areas with individual entrances. This applies especially to the smaller spaces such as barber shop, beauty shop, dry cleaning, and tailoring.

CONSTRUCTION OUTLINE

THE BUILDING containing the commercial facilities should be an economical structure requiring a minimum of critical materials and skilled labor. It is important that the structural design permit flexibility of interior and exterior arrangement. The following type of construction is generally recommended.

- a. Concrete slab on six inches of suitable fill available locally, with integral cement finish floor.
- b. All wood post and girder construction, based on 16-ft. module for framing with standard 16-ft. joists. (See typical cross-section.)
- c. Structure independent of partitions and exterior walls. When open store space is more than 5 bays (approximately 80 ft.) in either direction, transverse bracing will be necessary. This may be attained by the use of partitions or other means.
- d. Exterior non-bearing walls allowing complete freedom of wall and show window arrangement. These may be of whatever practical material is available locally which will permit interchangeable solid or glass panels. Standardized panel may be site- or shop-fabricated.
- e. Interior non-bearing partitions of whatever practical material is available locally. Standardized panel may be site or shop-fabricated.
- f. Flat roof construction, with underside exposed; no ceiling finish; rigid insulation, built-up roofing.

PLANNING GUIDE FOR SHOPPING CENTERS

250 TO 400 FAMILIES

Space	Range in Area
Food, including meats	4,000 - 5,000 sq. ft.
Drugs and variety	1,000 - 1,500 sq. ft.
Barber and beauty alcove	400 - 600 sq. ft.
Tailoring, dry cleaning, laundry, and shoe repair pick-up depot	300 - 450 sq. ft.
Toilets, locker, and heater room	300 - 450 sq. ft.
Total Net Building Area	6,000 - 8,000 sq. ft.
Parking Area	9,000 - 15,000 sq. ft.
Preliminary Estimate of Cost	\$22,000 - \$30,000

500 TO 800 FAMILIES

Space	Range in Area
Food, including meats	5,000 - 6,000 sq. ft.
Drugs, including fountain and luncheon service	1,500 - 2,500 sq. ft.
Variety (may be combined with drugs)	1,650 - 2,000 sq. ft.
Barber alcove } may be com-	300 - 500 sq. ft.
Beauty alcove } mon space	500 - 700 sq. ft.
Tailoring, dry cleaning, laundry, and shoe repair pick-up depot	800 - 1,200 sq. ft.
Toilets, lockers & heater room	600 - 1,000 sq. ft.
Total Net Building Area	10,350 - 13,900 sq. ft.
Parking Area	18,000 - 30,000 sq. ft.
Preliminary Estimate of Cost	\$34,000 - \$46,000

1,000 TO 1,500 FAMILIES

Space	Range in Area
Food, including meats	6,000 - 7,500 sq. ft.
Drugs, including fountain and luncheon service	2,500 - 3,200 sq. ft.
Variety	3,200 - 4,000 sq. ft.
Barber shop	400 - 600 sq. ft.
Beauty shop	600 - 800 sq. ft.
Tailoring, dry cleaning, laundry, and shoe repair pick-up depot	1,000 - 1,500 sq. ft.
Toilets, lockers and heater room	900 - 1,300 sq. ft.
Total Net Building Area	14,600 - 18,900 sq. ft.
Parking Area	35,000 - 55,000 sq. ft.
Preliminary Estimate of Cost	\$45,000 - \$60,000

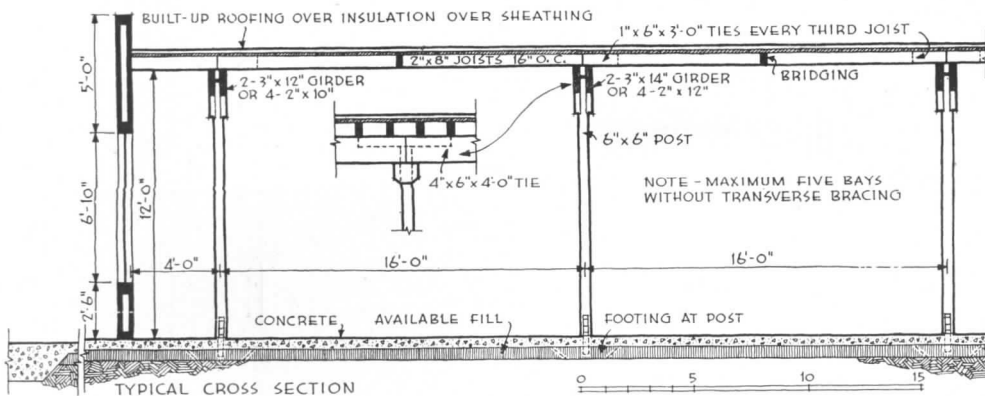

STORE MODERNIZING without metals

By MORRIS LAPIDUS

STORE modernization, especially re-planning and redecoration, is work which, to a limited extent, can be carried out under the present war restrictions. Increased purchasing power in cities throughout the country, especially those located near military camps or war production centers, has created a demand for remodeling stores to achieve greater efficiency and to increase the selling space. Much of the work entailed in such store modernization programs is not properly classified as new construction work, as it comes under "maintenance and repairs." Other portions are considered movable fixtures and such construction as is absolutely essential can be done with practically no critical materials. The design of all store work at the present time must be governed by the ability to obtain materials as well as a method of procedure which will entail the smallest cost.

STORE FRONTS

ALTHOUGH a large modernization program of store fronts could not be undertaken at the present time, it is still possible to modernize or build new small fronts, using only non-critical material and limiting the structural work entailed. In many instances it is possible to prefabricate many parts of the store front as a store fixture and to build the additional parts on the job. The design of the store front should be simplified to avoid intricate structural details. Such materials as glass, marble, stone, soft wood for construction and hard wood for surfacing, resin bonded panels, terrazzo, tile, rock lath, and plaster are still available. With these materials almost any type of store front can be constructed by working out special details around the plate glass. All forms of metal moldings must be eliminated for the present to save critical materials. With the exception of the supports for marble and stone, no steel is required in the structure of the store front. In many instances, existing lintels are sufficient to carry any marble or stone superstructure.

The electric wiring for a front presents a serious problem. In most cases

it is possible to re-use the existing wiring and reflectors from the old front. Where new wiring must be run, it should be reduced to an absolute minimum, using large-sized lamps spaced at greater distances, instead of the smaller lamps at the normal show window spacing. With the use of the new spot and flood lamps, reflectors may be eliminated entirely from the present-day store front. Signs and lettering will have to be limited practically to wood, as other materials are unavailable. Well built wood block letters finished with exterior enamels can be used effectively.

REDESIGNING THE INTERIOR

IN THE INTERIOR of the store more ambitious modernization programs may be carried out without the use of critical materials and without interfering with the war effort. The feature which dates store fixtures as a rule is the trim, which changes style from time to time. In many cases the arrangement of the fixtures is out of date, but all good quality store fixtures are built in sections and these can be rearranged to suit the more modern merchandise plan.

Completely new and modern merchandising plans can be worked out, re-using all existing cases. Newly planned spaces can be defined by lines of fixtures with new superstructure walls above them or with lightly built walls fashioned with hardboard or plasterboard or by the use of drapes or glass partitions. All of these can be done without actually classifying this work as construction.

The first step in the modernization of a store fixture is the removal of all unnecessary cornices, moldings, and ornaments. In some instances, old-fashioned wall cases will be found too deep. The backs can easily be moved forward. Old sliding drawers can be removed and replaced with simple 1/4-inch plain glass slides. Hardware on drawers, etc., can be removed and replaced with simple wood knobs or routed hand grips. Very often no refacing whatsoever is required for old cases. The exposed surfaces can be sanded and lacquered. If a facing is

necessary it can be done with hardboard or thin wood facias. The hardboard, of course, should be painted. Wood facias may be either painted or finished natural. Color, especially on the interior surfaces of wall cases, plays an important part in the decorative scheme. Colors should be chosen to harmonize with the merchandise displayed.

Floor cases may be modernized in the same manner as wall cases. In some instances the removal of moldings and ornaments is sufficient. In other cases, refacing the exterior of the floor cases with hardboard or panels will be necessary. Old-fashioned legs should be removed and a "kicked



Wall paper, rearrangement of lighting, new furniture, can transform an interior



Modernized cases with displays in superstructure walls are effective selling aids

Samuel H. Gottscho



Esra Stoller

"The trend today is to create some relief in the appearance of the store by having a portion of the wall surface without any fixtures or merchandise. These walls may be built of light construction or with drapery or sheets of corrugated or textured glass"

back" substituted. The interiors of the floor cases may be painted or finished with wall paper, fabric, mirrors, or any surfacing material best suited to display the type of merchandise.

Superstructure walls above certain floor cases will help nearly every type of retail store. Instead of presenting the appearance of a lot of fixtures cluttering the store, superstructure gives the effect of a sheer wall into which have been built the units of the display and handling of the merchandise. These walls may be faced with hardboard and plasterboard, the joints concealed by taping, paint or wallpaper. The superstructure present an opportunity for the use of display niches. These display openings can take almost any form and, properly illuminated, tend to serve both as an ornamental feature and as an easily seen indication of the type of merchandise for sale in that portion of the store. The trend today is to create some relief in the appearance of the store by having a portion of the wall surface without any form of fixtures or merchandise. These walls may be built of light construction or can be created with floor to ceiling fabric drapery or sheets of corrugated or textured glass.

Old lighting fixtures can be modernized by removing all extraneous ornament, but the best results are achieved by recessing the light wherever possible. In some instances old metal ceilings or ceilings cluttered with pipes and beams should be covered by a new hung ceiling. Unless fire laws conflict, it is possible to hang a light wood frame ceiling which can be surfaced with any available ceiling or wallboard. Scoring the boards eliminates the worry about joints, and cracks from unusual settlement or strain will not be evident. If a dropped ceiling is used, recessed lighting can be had by re-using all fixtures flush to the existing ceiling or installing new simple fluorescent or high-hat type reflectors.

With this type of remodeling, applied wall surfaces will overcome many of the difficulties entailed. Wallpapers, fabric wall covering and more elaborate material such as leatherette and mirrors and other forms of glass surfacing may be used effectively to cover up the temporary nature of the work behind. New floor covering and a carefully planned color scheme are especially helpful in making an attractive remodeled store.



Eisner's Studios

STORE MODERNIZING WITHOUT METALS 1—STORE FRONT DETAILS

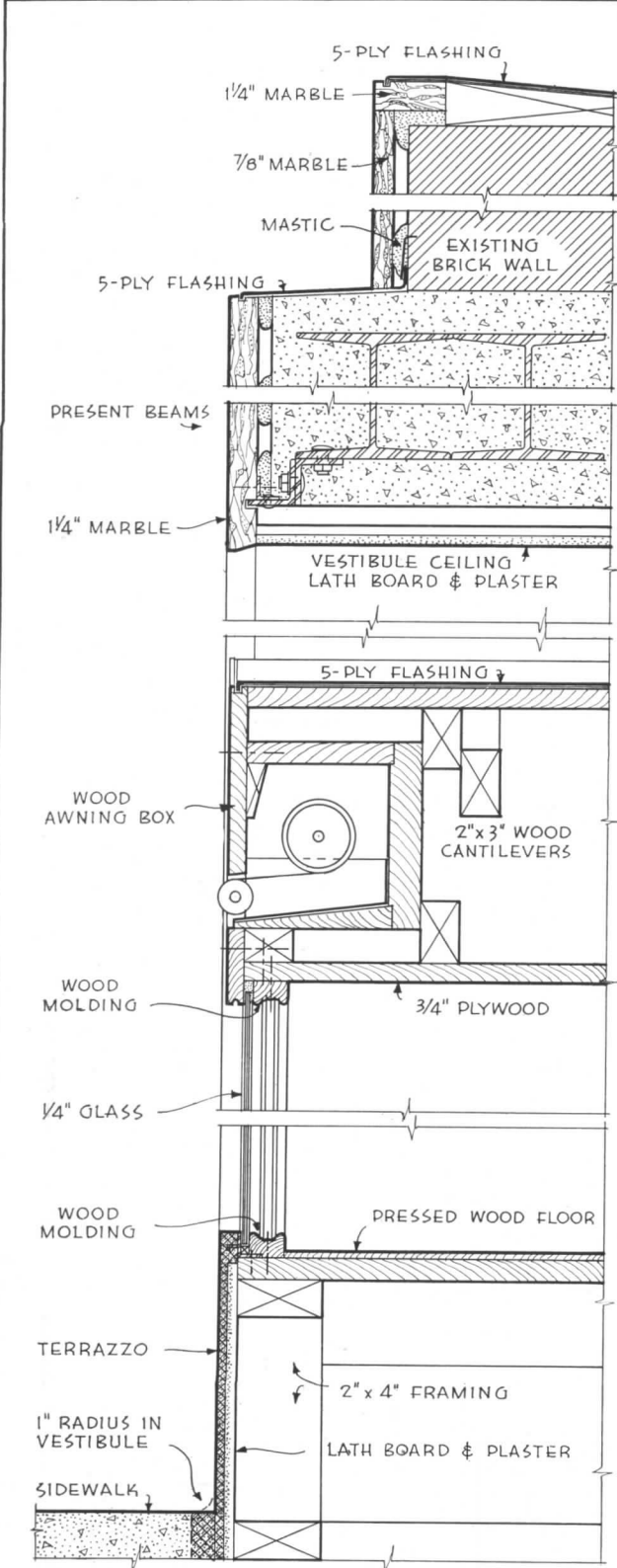

SECTION "A-A"

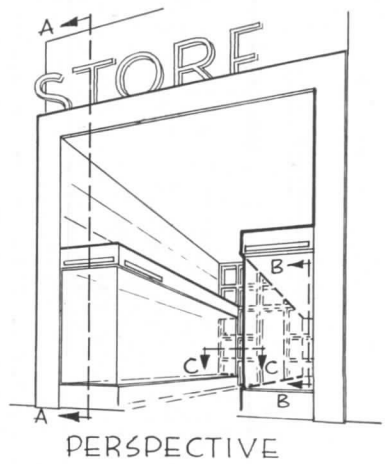

PERSPECTIVE

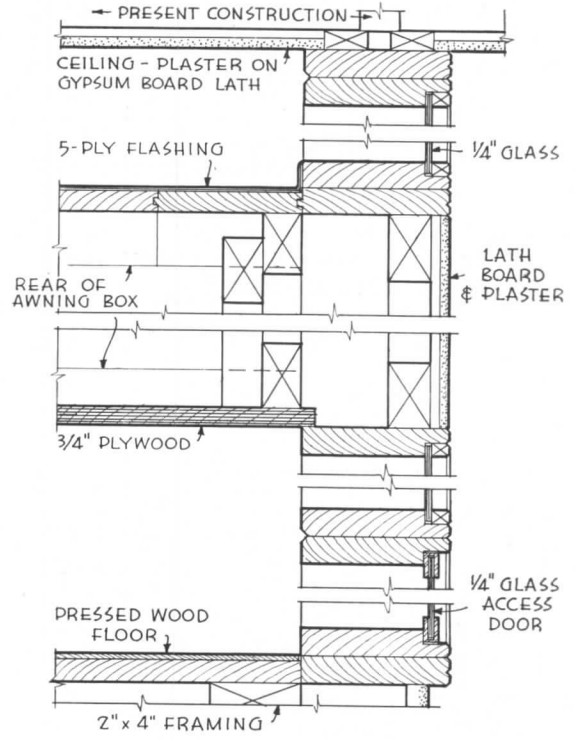

SECTION "B-B"

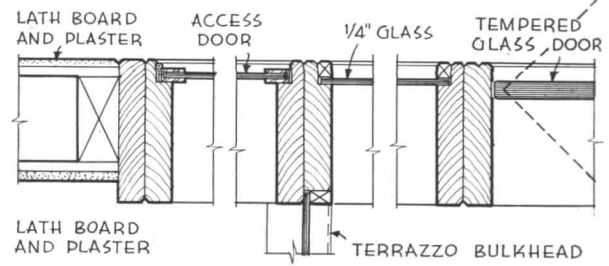

SECTION "C-C" AT REAR WALL & DOOR JAMB

SCALE 1 1/2" = 1'-0"

STORE MODERNIZING WITHOUT METALS 2—STORE FRONT DETAILS

OCTOBER, 1942

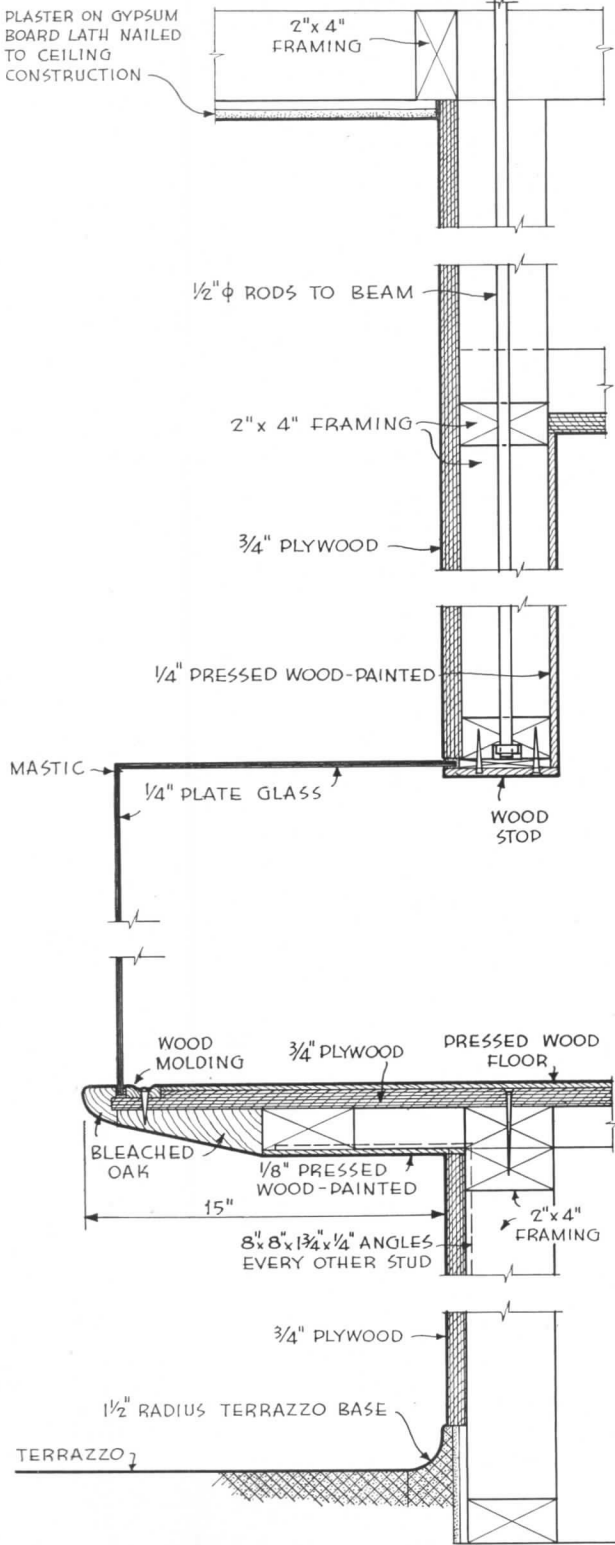

SECTION "A-A"
 SCALE 1 1/2" = 1'-0"

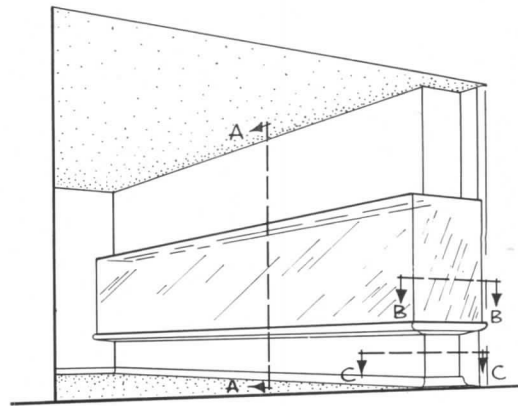

PERSPECTIVE

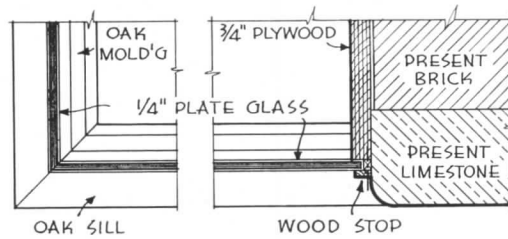

SECTION "B-B" AT FRONT SILL
 SCALE 1 1/2" = 1'-0"

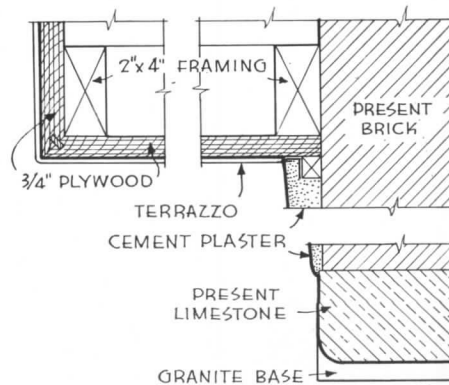

SECTION "C-C" AT FRONT
 BULKHEAD
 SCALE 1 1/2" = 1'-0"

STORE MODERNIZING WITHOUT METALS

3—STORE FRONT DETAILS

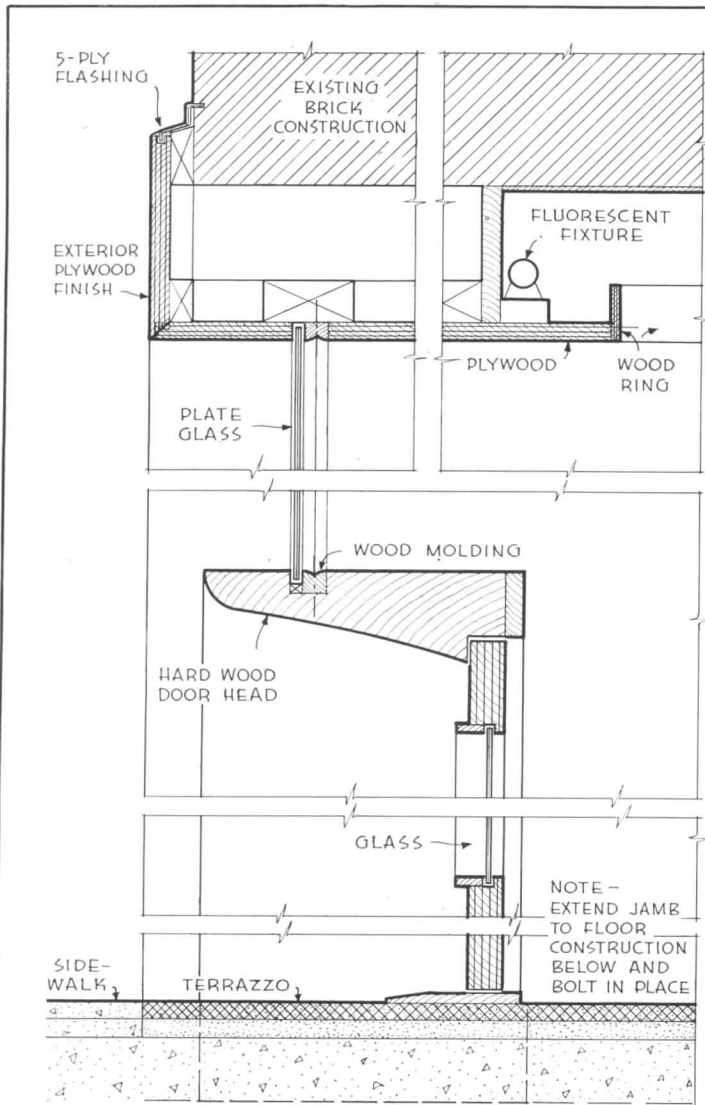

SECTION "A-A"

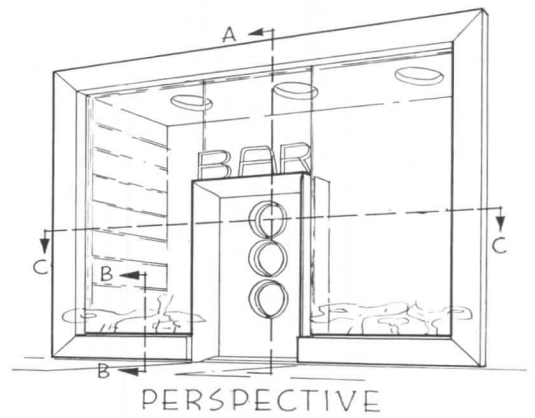

PERSPECTIVE

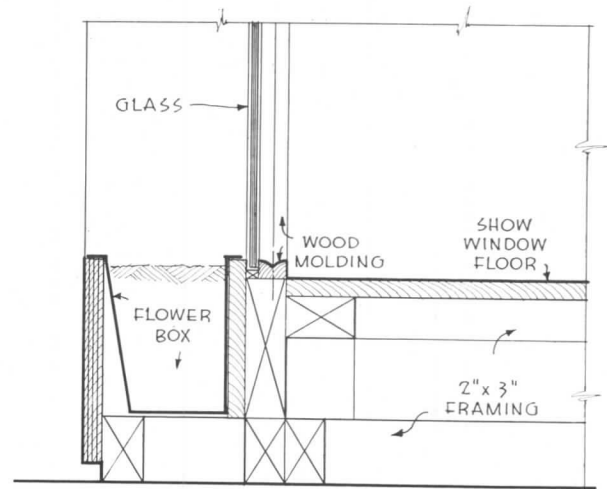

SECTION "B-B"

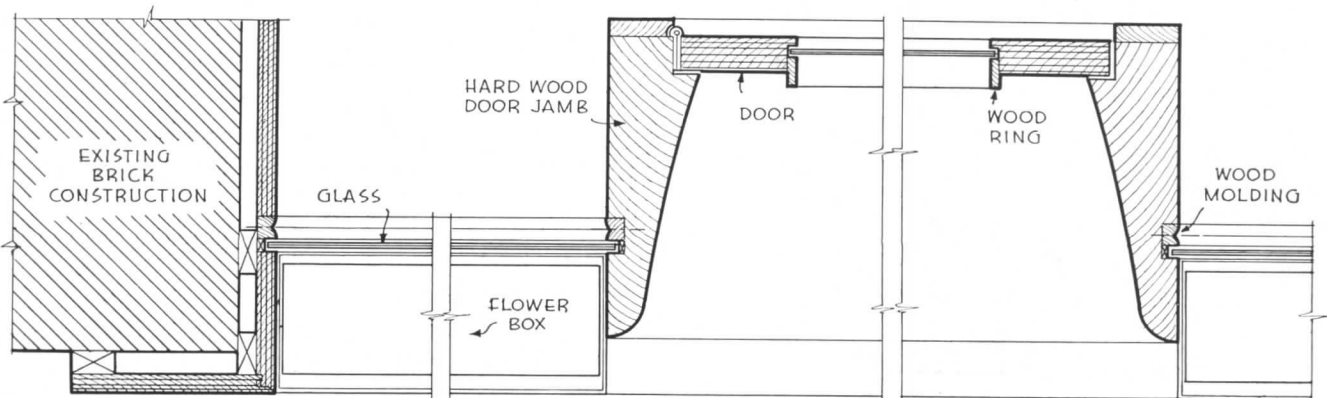

SECTION "C-C"

SCALE OF THESE DETAILS 1 1/2" = 1'-0" (APPROX)

STORE MODERNIZING WITHOUT METALS

4—STORE FRONT DETAILS

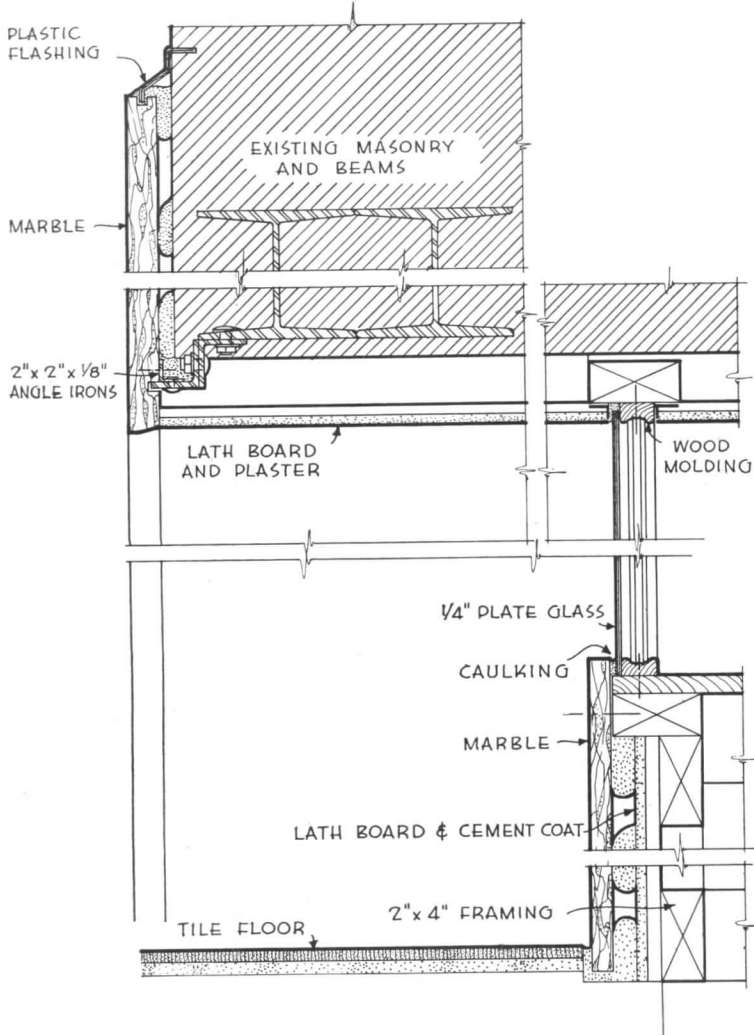

SECTIONS "A-A" & "B-B"

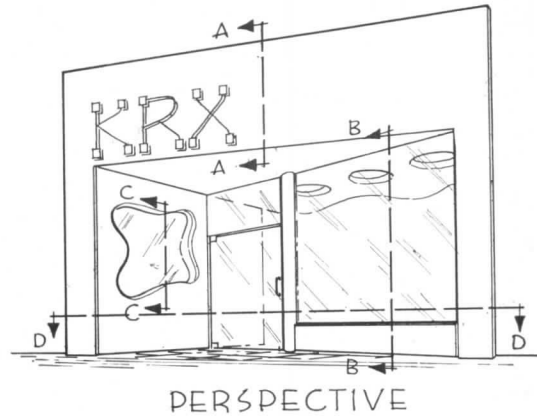

PERSPECTIVE

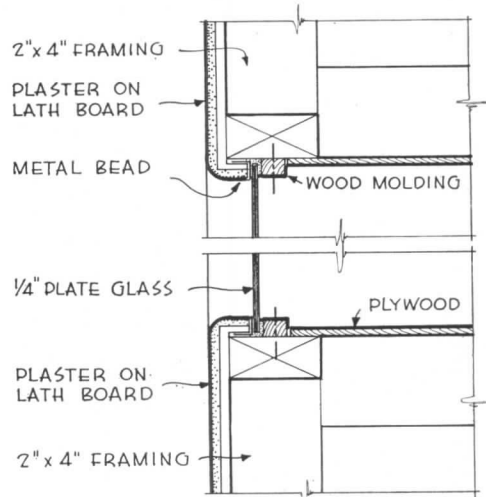

SECTION "C-C"

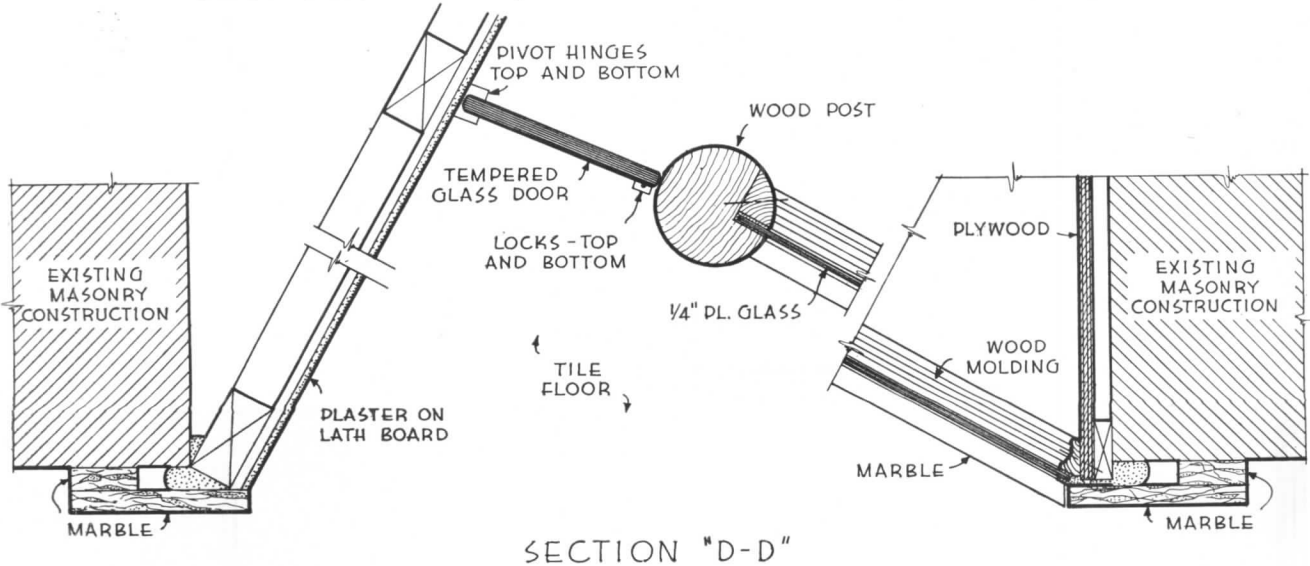

SECTION "D-D"

STORE MODERNIZING WITHOUT METALS

5—SHOWCASE REMODELING DETAILS

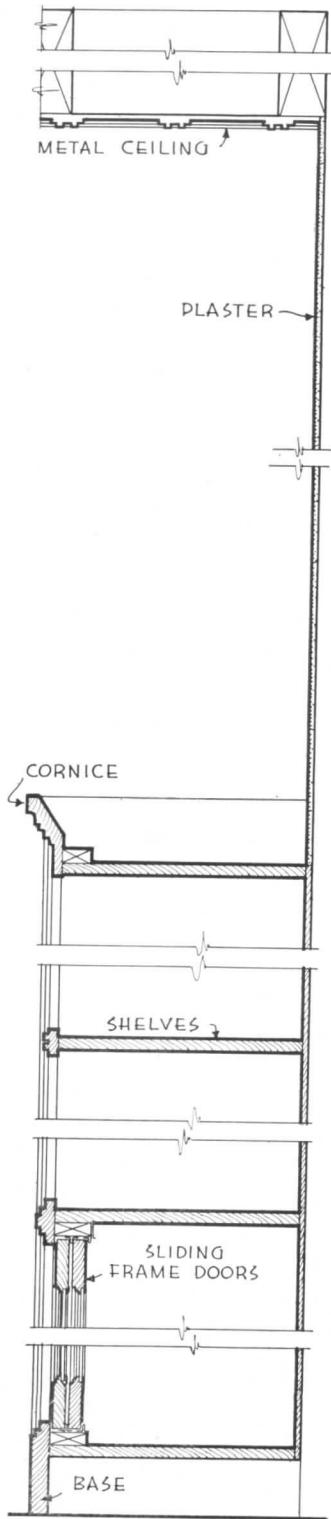

OLD SHOWCASE

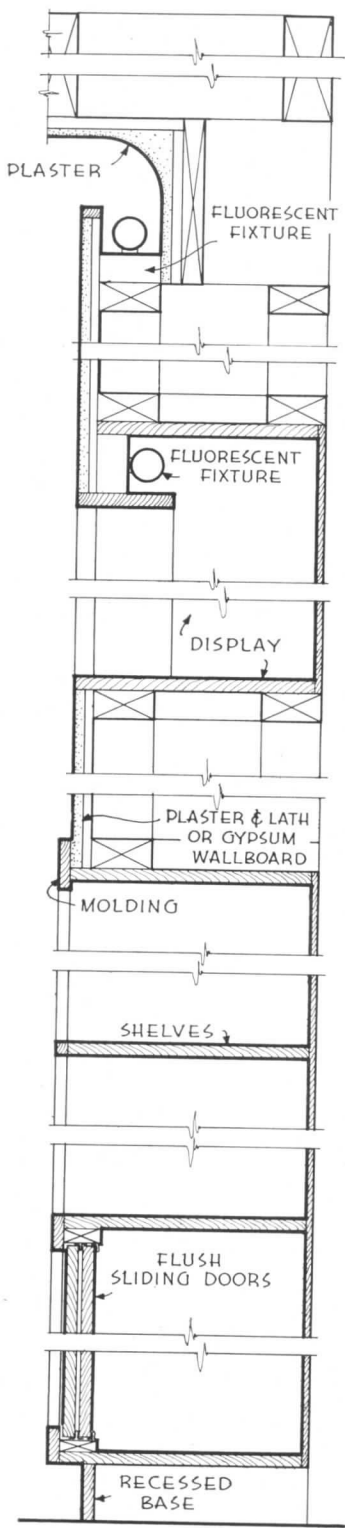

NEW SHOWCASE
 SECTION "A-A"

SCALE OF THESE DETAILS 1" = 1'-0"

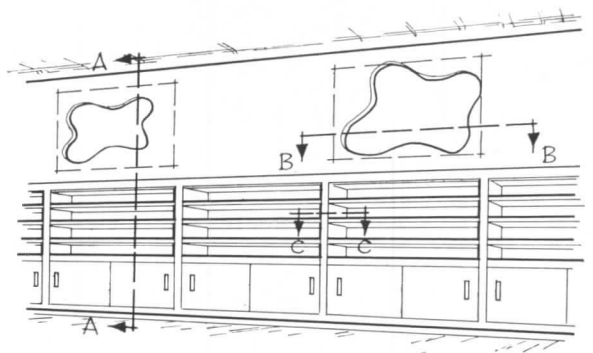

PERSPECTIVE

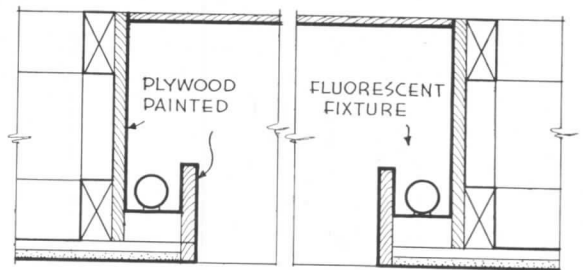

DISPLAY SECTION "B-B"

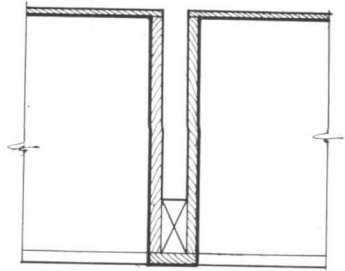

PILASTER SECTION "C-C"

STORE MODERNIZING WITHOUT METALS

6—MISCELLANEOUS REMODELING DETAILS

OCTOBER, 1942

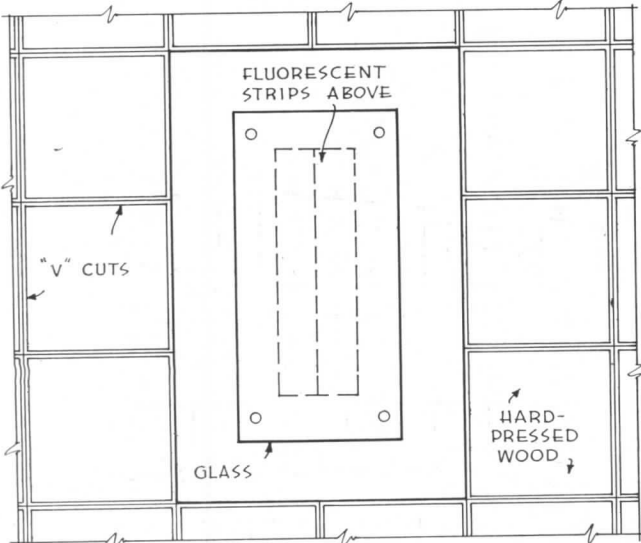
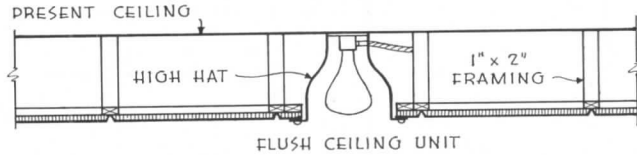
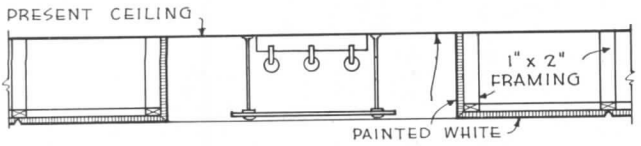

(ABOVE) CEILING SECTIONS AND REFLECTED PLAN

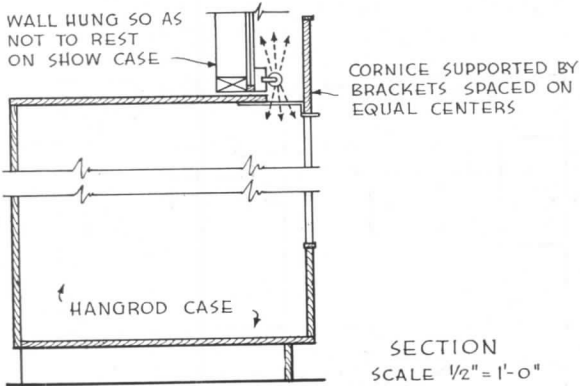

METHODS OF ILLUMINATING WALL AND CASE
 (ABOVE AND AT TOP OF PAGE)
 SCALE 1/2" = 1'-0" (APPROX).

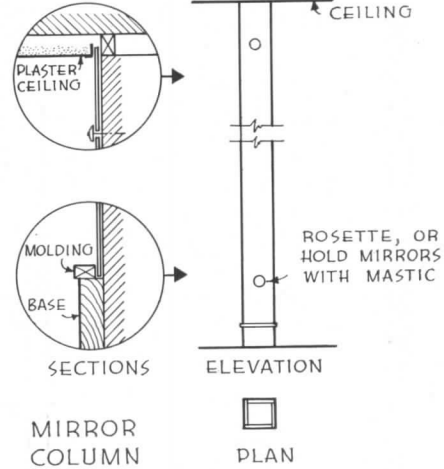

MIRROR COLUMN

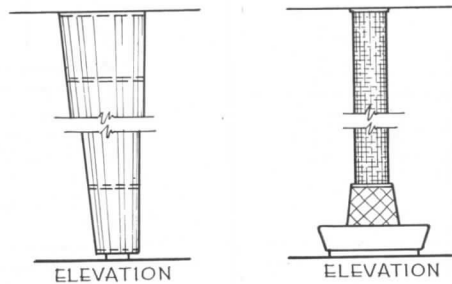

ELEVATION

ELEVATION



PLAN
 COLUMN WITH
 DRAPERY AROUND

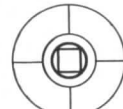

PLAN
 FLEXIBLE MIRROR
 MOSAIC COLUMN

METHODS OF REDECORATING COLUMNS

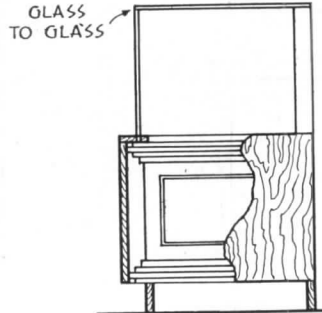
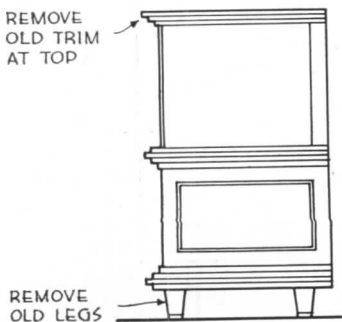

OLD CASE -ELEVATIONS- NEW CASE

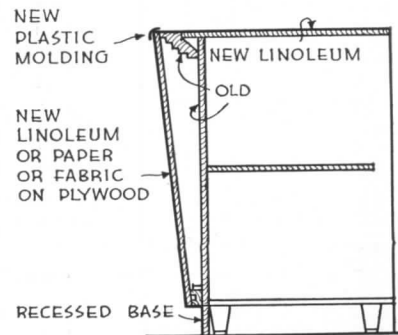

SECTION-NEW OVER OLD COUNTER

AWNINGS AND SHADES GO OUT Where Frosted AKLO Glass Goes In

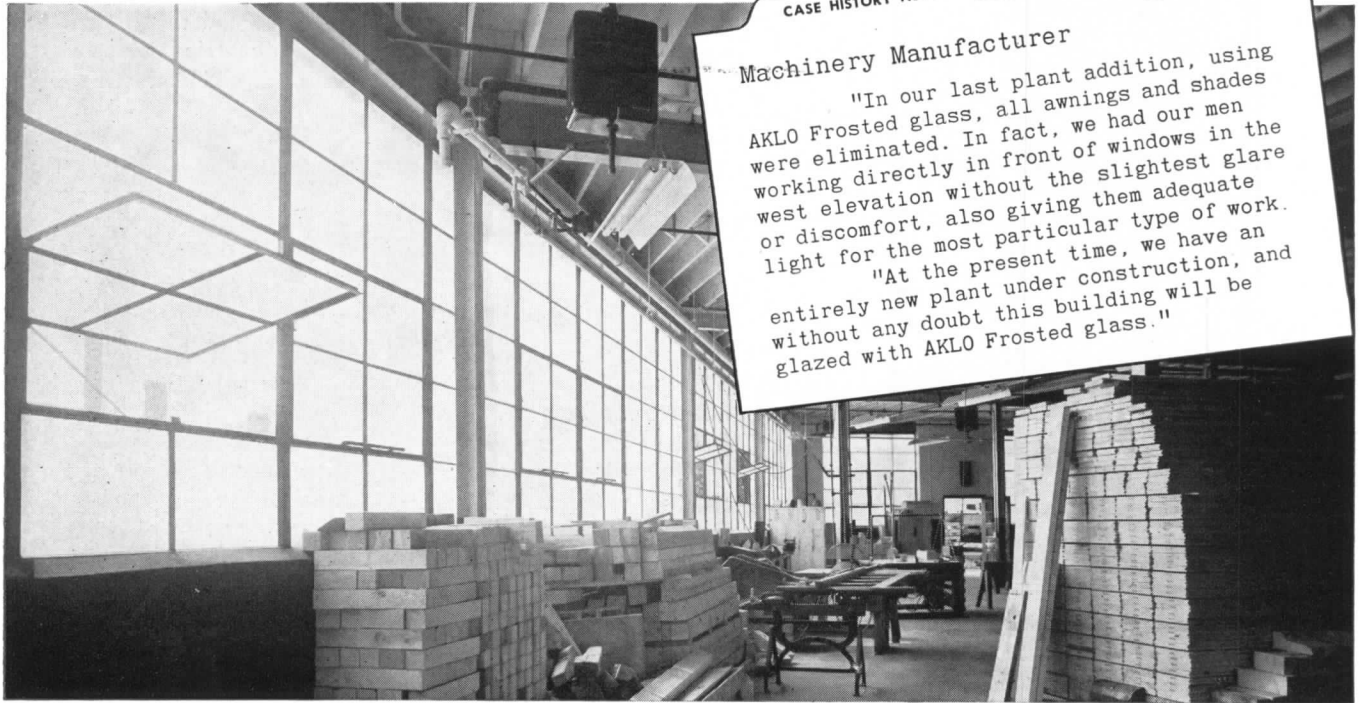

CASE HISTORY No. 9

Machinery Manufacturer

"In our last plant addition, using AKLO Frosted glass, all awnings and shades were eliminated. In fact, we had our men working directly in front of windows in the west elevation without the slightest glare or discomfort, also giving them adequate light for the most particular type of work.

"At the present time, we have an entirely new plant under construction, and without any doubt this building will be glazed with AKLO Frosted glass."

Frosted AKLO Filters Daylight Without Glare, Keeps Interiors Cooler

REDUCES GLARE—eliminates eye-strain and employee fatigue.

RETARDS SUN HEAT—keeps workers comfortable on their jobs.

RENDERS SAVINGS—eliminates shades or painting of glass.

Frosted AKLO glass reduces glare, protects workers against sun-heat, and eliminates costly shades, or whitewashing of glass. In windows and skylights, it creates better working conditions and produces direct savings in plant maintenance.

By providing glareless light, it reduces product spoilage, increases worker safety, decreases errors, speeds production.

Its heat-absorbing properties reduce solar heat entering a building by as much as 47.9%, making employees feel better and work better. In air conditioned plants, operating costs are substantially reduced.

AKLO is manufactured by Blue Ridge Glass Corporation, Kingsport, Tenn., and sold by Libbey-Owens-Ford through leading glass distributors. It is available in hammered and ribbed patterns, both wired and unwired. For information, write Blue Ridge Sales Division, Room 1281, Libbey-Owens-Ford Glass Co., Toledo, O.



BLUE RIDGE AKLO GLASS

Heat-Absorbing · Glare-Reducing · Figured and Wire Glass



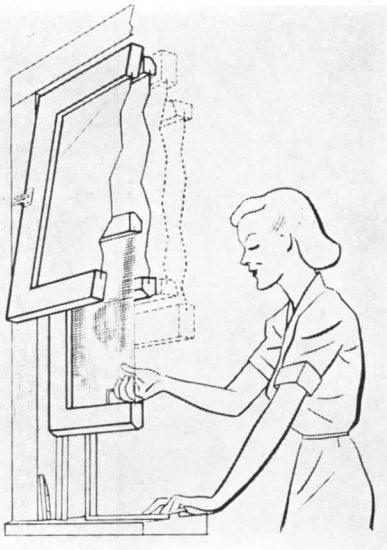

FIGURE 1

STORM SASH AND SCREEN COMBINED

INSTALLED like regular storm sash is a newly announced combination storm sash and screen. In winter the screen is "stored" behind the upper storm sash; in summer the storm sash is "stored" at the top. The combination costs no more, according to the manufacturer, than ordinary storm sash and flat frame screens. Frames are of white pine, toxic treated and water-repellent. Corners are mortised and tenoned, held by steel pins and waterproof glue. The unit is held in place by spring tension. Rolscreen Company, Pella, Ia. (Fig. 1.)

FROM THE NHA

THE Metla Window Institute advises there are more than 175,000 residential type steel windows in stock in warehouses. WPB urges that these stocks be used up to make room for other productive businesses. Provision will be made for the use of these metal windows in future FPHA contracts as options for wood windows until the existing stock is exhausted.

PORTLAND cement manufacture is streamlined by a limitation order to be issued by WPB. The order, which is not intended to restrict the use of cement, has three provisions: 1. Specifications are reduced to three types, conforming to Federal Specifications SS-C-191A Standard Portland, SS-C-201 High Early Strength Portland and

SS-C-206 Moderate-Heat-of-Hardening. 2. All cement will be stored in a common pool. Storage of specification cement will be prohibited. 3. Testing will be done only by the National Bureau of Standards, and the results will be accepted by all purchasers.

WPB recommends that cement be used wherever possible in mass concrete, walls, floors, precast masonry units, lintels, sills, roof tile, tubs, sewer pipe and in any other way where the use of concrete is advisable. The effect of the order will be to increase production with present facilities from 10 to 30 per cent per year.

STANDARD GRANITE SHAPES

PREFABRICATED standard granite shapes, machined to uniform dimensions, have just recently been introduced. The laboratory tests show that due to the high flexural strength of this granite, beams of the material may be substituted for reinforced concrete of equivalent strength without substantial change of section. Low porosity and low absorptivity give it merit for exterior use in climates of extreme variation. Its modulus of elasticity is similar to that of wood, with a compressive strength rarely excelled in commercial stone. In many cases, it is stated that these prefabricated natural granite units cost approximately 50 per cent less than custom stonework, due to mechanization and saving of red tape. H. E. Fletcher Co., West Chelmsford, Mass.

The illustration (Figure 2) below shows prefabricated standard granite units in relation to brick coursing

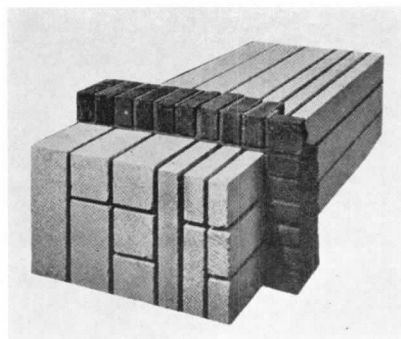

FIGURE 2

NON-METALLIC DUCT

ESTIMATED to save up to 90 per cent of the usual metal in a typical in-

stallation, a non-metallic duct for use in warm air heating and air conditioning systems has been developed. The product is suggested for residential installations carrying normal temperatures in either gravity or blower types, and can be used up to within 6 ft. of the plenum chamber on the supply line and the entire return line. Sall Mountain Company, 176 W. Adams St., Chicago. (See Figure 3.)

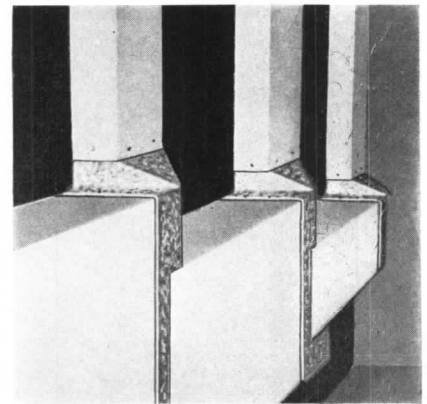

FIGURE 3

PROTECTS STORAGE TANKS

INERTNESS to petroleum, coal tar and manufactured solvents, organic and inorganic oils and fatty acids is said to be a feature of a new coating to protect concrete or wood storage tanks against the infiltration into their contents of gasoline and oil. This liquid coating is available in red, white, green or blue; is said to dry in 2 or 3 hrs. Carbozite Corporation, First National Bank Bldg., Pittsburgh, Pa.

LUMINESCENT FABRIC

A COATED fabric has been developed which glows with visible light in complete darkness. The manufacturer recommends it for making letters or strips to mark doorways, stairways, hand rails, instrument dials, control panels, etc. The fabric is said to be cheaper than luminous paint. It is applied with casein glue, wallpaper paste or thumb tacks, without special primer, and may be removed easily. Exposure to electric light or sunlight for 30 seconds, is sufficient to give the coating the power to glow for 4 to 6 hrs. Du Pont Company, Wilmington, Del.

(continued on page 82)



LET'S TALK

Horse Sense

about the Buildings of Tomorrow

EVERY building material has its place in architectural design and engineering. But Steel provides a *combination of qualities found in no other material.*

Steel is strong and tough . . . high in strength to weight ratio among building materials . . . fireproof and verminproof . . . extremely versatile . . . inherently long in life . . . easily workable . . . and low in cost, considering its advantages and years of performance.

Steel has and always will have a very definite place in all types of buildings—in which the use of less efficient materials must mean sacrifice of many important qualities.

After we've won the war and steel again becomes available in ample quantity for building construction, Republic will be ready as in pre-war days with the most complete line of steels and steel building products made by any single manufacturer.

And through the added experience gained in producing millions of tons of fine steels for armament—through constant research to improve steels and steel products—the Republic line described in Sweet's Catalog File will materially contribute to the design and construction of structures that will be better and lower in cost than ever before.

For information see Sweet's 13/6 for sheet products; 27/3 for pipe; 9/1 and 21/2 for Berger lath, lockers and other items; 23/5 for electrical raceway; 15/18 for Truscon products.

REPUBLIC STEEL CORPORATION • *General Offices:* CLEVELAND, OHIO

Berger Manufacturing Division • Culvert Division • Niles Steel Products Division
Steel and Tubes Division • Union Drawn Steel Division • Truscon Steel Company
Export Department: Chrysler Building, New York, New York

REPUBLIC STEELS
and **STEEL PRODUCTS**

(continued from page 80)

FLUORESCENT LAMP STARTER

A MANUAL-RESET fluorescent lamp starter is announced which locks dead lamps out of the circuit, allowing instant dead lamp replacement. No current flows through the ballast after the dead lamp has been locked out, and this current cut-off feature prolongs the life of the ballast and elim-

inates a cooling period. A red button on the starter snaps forward when a dead lamp is locked out. For 30-, 40-, 100-watt lamps. General Electric Company, Bridgeport, Conn.

FIXTURES MEET ARMY SPECS

A LINE of plumbing fixtures has been designed to use a minimum of critical

materials and to comply with the new Army Specification PE-623, which supercedes Specification 8000-E. Crane Co., 836 S. Michigan Ave., Chicago.

FLOODLIGHTS

A NEW LINE of wide and narrow beam floodlights is announced for lighting shipyards, construction projects, industrial yards and sports areas. Westinghouse Lighting Division, Edgewater Park, Cleveland, Ohio.

BLACKOUT BLINDS

A BLACKOUT BLIND already installed in coastal plants and government buildings is said to have numerous advantages: It raises and lowers by cord; is adaptable to windows of any size; is made of heavy crepe fiber which, it is stated, is lightproof, will not pinhole and has been flame-proofed. CLOPAY, 1207 Clopay Square, Cincinnati, Ohio.

PROTECTIVE CLOTH

A STRONG 10-mesh cotton cloth with a tough, transparent plastic film has been developed to provide a permanent or emergency flexible window or to serve as protection inside the glass. It is recommended for quick replacements of glass. Colloid Equipment Co., Inc., 50 Church St., New York City. (See figure 4.)

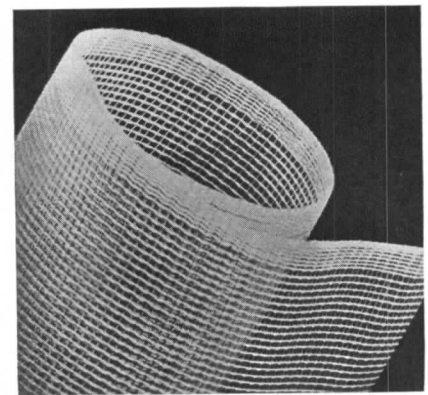

FIGURE 4

TANK JACKET

MADE of patented air cell insulation, a new hot water tank jacket can be installed on standard model 30- and 40-gal. tanks. Joint seals are made with cloth tape matching the wood grain finishes. Hinde & Dauch Paper Company, Sandusky, Ohio.

(continued on page 84)

FOR ARMY-NAVY PROJECTS and War Industries

At this time The Herman Nelson Corporation is busy furnishing Heating, Ventilating and Air Conditioning Equipment for use everywhere in connection with work vital to our National War Effort. However, The Herman Nelson Corporation is maintaining Sales and Service Offices in all Principal Cities in order to help facilitate war work. Each office is equipped to quote and aid in working out details for your war project.

HERMAN NELSON hijet HEATERS



Horizontal Shaft Propeller-Fan Type hijet Heater projects warm air downward in the desired direction. Eliminates waste fuel and space. Available in 48 models, sizes and arrangements.

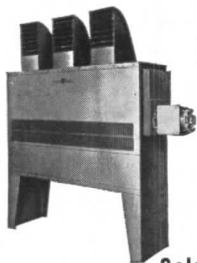

Herman Nelson Blower-Fan Type hijet Heater provides efficient heating of large areas. Streamline discharge outlets maintain large air delivery with high velocity. For floor, wall, ceiling, or inverted wall mounting. Available in 150 models, sizes and arrangements with a wide range of capacities.

AUTOVENT FANS AND BLOWERS

Autovent Propeller Fan Exclusive Autovent design—direct or belt driven. Ruggedly constructed for economical operation under severe conditions. Available in wheel diameters from 9 to 72 inches; capacities 450 to 45,000 cfm.



Autovent Blower for heavy duty ventilating and air conditioning installations. This Blower can be furnished to any speed or discharge requirements, in a wide range of sizes.

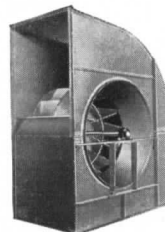

Sales and Service Offices in Following Principal Cities

Albuquerque, N. Mex.
Appleton, Wis.
Atlanta, Ga.
Baltimore, Md.
Birmingham, Ala.
Boston, Mass.
Buffalo, N. Y.
Charlotte, N. C.
Chicago, Ill.
Cincinnati, Ohio
Cleveland, Ohio
Columbus, Ohio
Dallas, Texas
Denver, Colo.
El Paso, Texas
Emporia, Kans.
Fort Wayne, Ind.
Grand Rapids, Mich.

Harrisburg, Pa.
Houston, Texas
Indianapolis, Ind.
Jackson, Miss.
Johnstown, Pa.
Kansas City, Mo.
Los Angeles, Calif.
Louisville, Ky.
Madison, Wis.
Memphis, Tenn.
Miami, Fla.
Milwaukee, Wis.
Minneapolis, Minn.
Missoula, Mont.
Moline, Ill.
Nashville, Tenn.
New Orleans, La.
New York City, N. Y.
Norfolk, Va.

Omaha, Neb.
Philadelphia, Pa.
Pittsburgh, Pa.
Portland, Maine
Richmond, Va.
Saginaw, Mich.
Salt Lake City, Utah
San Antonio, Texas
San Francisco, Calif.
Scranton, Pa.
Seattle, Wash.
Spokane, Wash.
St. Louis, Mo.
Syracuse, N. Y.
Tucson, Ariz.
Tulsa, Okla.
Washington, D. C.
Watervliet, N. Y.
Westfield, Mass.



THE HERMAN NELSON CORPORATION

MOLINE, ILLINOIS

MANUFACTURERS OF QUALITY HEATING, VENTILATING AND AIR CONDITIONING PRODUCTS

★ 2 TO 3 PRECIOUS WEEKS SAVED ★

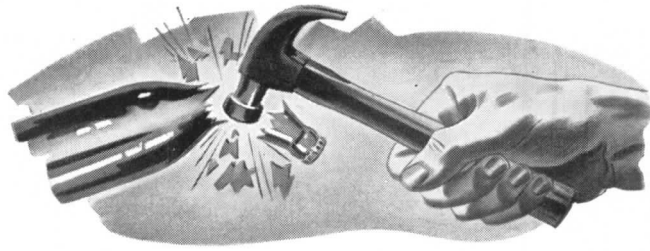

BY FULL WALL CONSTRUCTION

Proved on Scores of Both Public and Privately Financed War Housing Projects and Thousands of Homes from Coast-to-Coast



► **NO COSTLY TIME-CONSUMING OPERATIONS**
No water—no moisture—no “drying out” period. No taping—no cutting—no filling of joints. No nails to countersink—no holes to fill. And no sizing or repeated paintings—one coat usually is sufficient—never more than two. Painting begins immediately following application of trim. Only 40 to 50 man-hours of application time is needed for the average family unit.

► **UPSON STRONG-BILT PANELS**—big enough to cover a whole wall—pre-cut to size* at the factory, numbered and delivered to the site—lifted into place and driven against special pronged Floating Fasteners nailed to studs—that’s the way Upson mass production methods are speeding construction and cutting costs on many of the nation’s great war housing projects.

*On projects of 100 units or more.

► **BEAUTY THAT EXCITES ADMIRATION** from critical tenants and prospective buyers. *Crackproof* construction that assures low maintenance cost—and efficient insulation that aids year-round comfort! All these advantages complete the newest advanced conception of interior wall linings made possible by vastly improved Strong-Bilt Panels now being used by an increasing number of builders. *FHA accepted for both public and privately financed housing.*

You, too, can use Upson Strong-Bilt Panels to join time and cost saving construction with beauty and permanence—to conserve critical materials and spread available man power over a greater number of units. Skilled Field Supervisors, trained in the elimination of non-essential operations and with “know-how” gained on scores of big projects, can be supplied. For quick action, phone or wire. The Upson Co., Lockport, N. Y.

Upson Quality Products Are Easily



Identified by the Famous Blue-Center

**UPSON
STRONG-BILT
PANELS**

(continued from page 82)

LOCKERS AND CABINETS

THREE products necessary in wartime industries but eliminated by steel priorities are now offered in wood: shoprobes, providing full-length coat hanging space and private locking compartment; lockers with hardwood top, bottom and frame, and sides, back and door of pressed wood; cabinets with

hardwood top, bottom and frame, and sides and back of pressed wood. Green enamel finish. Lyon Metal Products, Inc., 3016 Clark St., Aurora, Ill.

UNDERLAY FOR FLOORING

AN UNDERLAY for linoleum and other composition flooring comes in the form

of a thin asphalt mastic board. Available in several thicknesses from 6/100 in. to 3/16 in., the product is said to provide a resilient underlay that is impervious to moisture. It is composed of a high melting point asphalt in combination with fine mineral aggregate, sealed between dry, non-bleeding liners. Keystone Asphalt Products Co., 43 E. Ohio St., Chicago, Ill.

FUEL AND EQUIPMENT

LOCAL architects in preparing plans have been instructed to provide for fuel and equipment which will occupy the *most space*, where uncertainty prevails as to the availability of a particular fuel or the availability of materials in equipment.

Examples:

A. Where fuel for ranges and space heater has not been determined, plans should be made for the use of coal.

B. Where there is any uncertainty as to WPB limitation orders affecting equipment, space should be so planned that the largest make of equipment can be accommodated.

NON-METALLIC CABINET SHOWER

RECOMMENDED for either residential use, barracks or defense plants is a non-metallic cabinet shower that is said to use even less metal than government specifications allow. Walls are fiberboard finished in baked synthetic enamel. Assembly members and top frame are metal finished in baked enamel. Precast concrete receptor; cast drain, with wrought strainer, cast integral with floor of receptor. Sizes 30 by 30 by 75 in. and 32 by 32 by 75 in. Henry Weis Mfg. Co., Inc., Elkhart, Ind.

WIRING SYSTEM

A PORCELAIN-PROTECTED wiring system, it is *claimed*, lends itself fully to the country's war needs because it conserves steel, copper, rubber and zinc and affords tested safety and economy. Porcelain wiring means: 1. Knob and tube wiring; 2. porcelain outlet boxes; 3. "surfolets"; any one or any combination of two or three. Porcelain Products, Inc., Findlay, Ohio.

This timber joint
DOES MORE — COSTS LESS

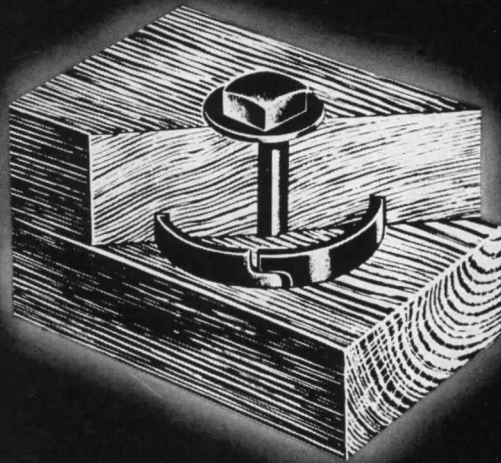

For more than 8 years TECO Timber Connector Construction has been tested by the U. S. Forest Products Laboratory and at many leading universities. The TECO Timber Connector brings into play the full stamina of each framing member by spreading the load on a joint more equally over the cross-section of the wood.

Timber ENGINEERING COMPANY

WASHINGTON, D. C.

PORTLAND, OREGON

THE NEW PENCIL POINTS — KAWNEER ARCHITECTURAL

COMPETITION

"THE STORE FRONT OF TOMORROW"

PRIZES

FIRST PRIZE	\$1,000.00
SECOND PRIZE	500.00
THIRD PRIZE	250.00
5 HONORABLE MENTIONS, \$100.00 .	500.00
	<hr/>
	\$2,250.00

COMPETITION CLOSING JANUARY 4, 1943

WRITE NOW FOR PROGRAM—NEW PENCIL POINTS, 330 W. 42nd ST., NEW YORK, N. Y.

WILLIAM LESCAZE, PROFESSIONAL ADVISOR JUDGES: FREDERICK BIGGER, F. A. I. A., WASHINGTON, D. C.

MORRIS KETCHUM, A. I. A., NEW YORK CITY—SAMUEL E. LUNDEN, A. I. A., LOS ANGELES, CAL.

MIES VAN DER ROHE, CHICAGO, ILL.—ROLAND WANK, A. I. A., KNOXVILLE, TENN.

Kawneer

RUSTLESS METAL STORE FRONTS • DOORS • WINDOWS
THE KAWNEER COMPANY • NILES, MICHIGAN

REQUIRED READING

(continued from page 26)

water courses and irrigate their lands. Two families still own sheep. "Sheds are rough and ingenious . . . bread is baked in beehive ovens. . ." The church is beautified, the houses of pinkish or buff adobe brick are neat and well kept, interior walls are tinted, "in the old type house the doors have no jambs, the beams show, the effect is very fine."

PERIODICAL LITERATURE

DUAL PURPOSE SURFACE SHELTER. Architect and Building News, London, (2 Breems Bldg.) July 24, 1942, pp. 56-8, illus.

FOUR SHELTERS, designed by G. R. Falkiner-Nuttall and Trystan Edwards to serve also as post-war housing, are one-story structures 14½ feet square with a six-foot connecting passage be-

tween them to give access and to provide space for toilets. The roof is a concrete panel reinforced in both directions and tied to the 13½-inch reinforced brick walls. The floor is similarly reinforced, and a layer of building paper inserted beneath the floor will make possible "movement of the shelter as a whole . . . in the event of the forces being sufficiently great." Fresh air inlets are at a low level, the air is warmed by electric panels and it leaves by outlets at high levels in the interior walls so that cross-ventilation is achieved by aid of the clerestory windows in the six-foot space between the units. Construction lends itself to the addition of one or more stories with possibly 11-inch cavity brick work, though the construction would permit use of larger prefabricated elements. The shelters with plumbing cost £8 (about \$32) a head including bunks, or, if provided with seats only, about £4 a head.

WINDOW DESIGN SAVES CRITICAL MATERIALS. By S. Koffsky. Engineering News-Record, New York, (330 W. 42nd St.) Sept. 10, 1942. p. 87, illus.

SUBSTITUTION of double width glass lights and elimination of alternate vertical members in a machine shop involving about 18,000 square feet of steel sash resulted in a reduction of 15 per cent for the revised design as compared with the estimate for standard, gave better appearance and more light and air, and simplified window cleaning. A typical window of 58¾ by 102¾ inches uses 99 lbs. of steel, 117 linear feet of putty; the revised design uses 82 lbs. of steel and 85 feet of putty with a saving of nearly 17 per cent of steel and nearly 29 per cent of putty, as well as 25 per cent in the cost of labor.

BUILT DOWN INSTEAD OF UP. By S. A. Carrighan. Architect and Engineer, San Francisco, (86 Post St.) Aug. 1942. pp. 19-28, illus.

PROPERTY owners in the Triangle district, containing 17 retail stores, 11 office buildings, 88 hotels, 15 clubs and 7 theaters, got together to sponsor a four-floor garage below much frequented Union Square, to accommodate 1,700 cars, or about as many as could be parked along 108 city blocks. The sponsors pay the city

(continued on page 88)

THE IMPOSSIBLE TODAY— BETTER HANGAR DOORS FOR TOMORROW!

Restrictions on steel seemed to sound taps over good hangar door construction for the duration. But Horn, pioneer builder of folding doors and partitions of every description, accomplished the seeming impossible in the NEW Horn ALL-WOOD Hangar Door.*

This new type door not only solves the problem for the duration, but also sets a new standard of door design for the future. It employs the time-tested, guaranteed Horn Automatic operator. It has the strength and rigidity to withstand terrific strains and pressures. Yet, a complete unit for a 120 x 28 foot opening—including track, carriers, operators, hinges and floor guides—uses only 3400 pounds of steel. It does sound like the impossible, doesn't it?

Here is the design so sound, and construction so good that this new ALL-WOOD door is not just a "for-the-duration makeshift".

It's really the hangar door of tomorrow—available today! Can't we tell you more about it? Call your Horn representative (he's listed in Sweet's) or write direct.

**We build them of all-steel, too. But it takes an "O.K." from Uncle Sam.*

HORN

MANUFACTURING COMPANY

DEPT. A-102

FT. DODGE, IOWA

World's Largest Manufacturers of Automatic Folding Doors and Partitions

ENGINEERED FOR THE JOB!

Delivered to the Job...
Ready for Erection...

RILCO

FACTORY FABRICATED
WOOD STRUCTURAL MEMBERS
Available Today
For Priority Construction

●Wherever clear spans, free of braces and posts, are required for the building of airplane hangars, factories, munition plants, storage and service buildings, drill halls, auditoriums, churches, recreation centers, you can get the job done better, faster and economically with Rilco laminated structural framing members.

These Rilco products include beam arches for spans up to 200 feet and over, bowstring trusses, ply beams for flat roof structures of one and two stories, boomerang and utility arches, arch rafters and structural framing members continuous from foundation to roof peak—and solid timber connector trusses.

Designed and engineered for specific job requirements, they meet the exacting specifications of U. S. Army, Navy and Building Code requirements.

Under rigid factory controls, Rilco takes modern structural glues

and scientifically kiln-dried, seasoned lumber, selected for strength, density and slope of grain, forms, shapes and permanently bonds them into any desired size and type of structural member.

Rilco wood structural members are factory fabricated in five modern plants, strategically located for prompt service and delivered to the job site, ready for fast erection.

So, wherever the location of your job, *North, South, East, or West*, whatever the type of structure, Rilco can supply the structural members

you need. Complete engineering data and design cooperation is available to architect and engineer. Write today for information on Rilco Laminated Products.

Copyright 1942, R. L. P. Inc.

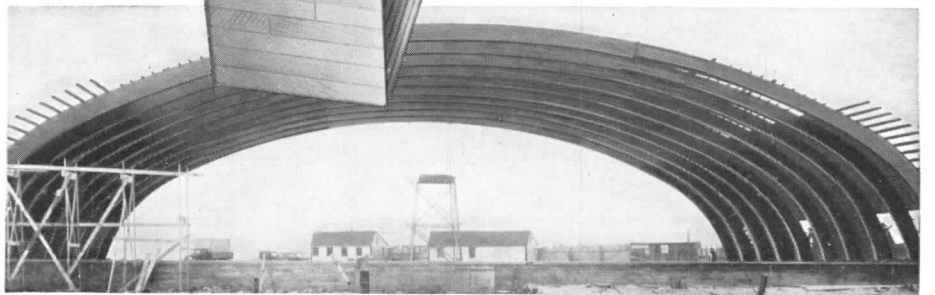
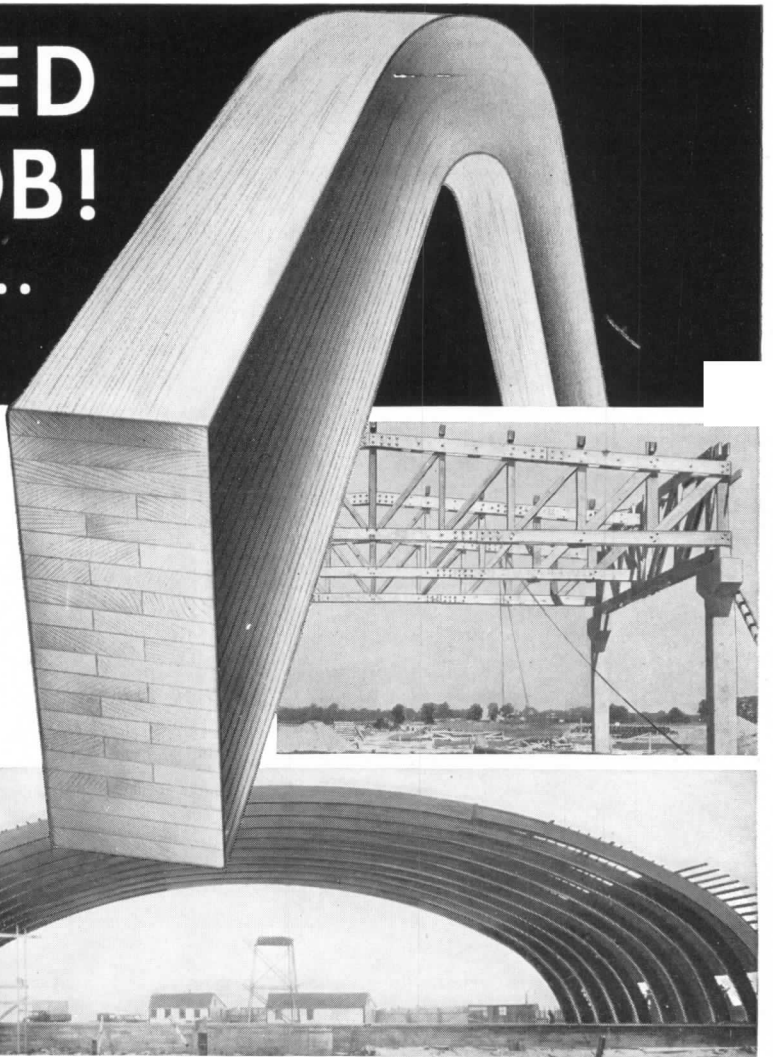

RILCO

DESIGNERS
AND FABRICATORS OF
ENGINEERED WOOD
PRODUCTS FOR A WIDE
VARIETY OF USES

RILCO LAMINATED PRODUCTS, INC.

A Weyerhaeuser Institution

1585 FIRST NATIONAL BANK BUILDING, SAINT PAUL, MINNESOTA

Factories: ALBERT LEA, MINN., BRODHEAD, WIS., CHICAGO, ILL., HUNTINGTON, IND., WILKES BARRE, PA.

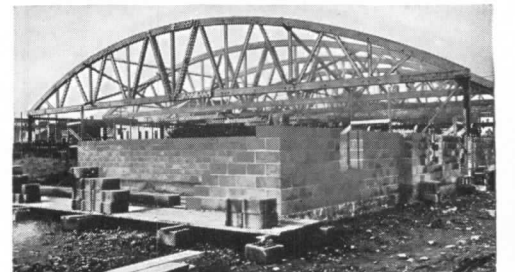

REQUIRED READING

(continued from page 86)

annually \$5,000 in rent and \$13,000 in taxes, and when the project has repaid the \$600,000 locally subscribed and the \$850,000 RFC loan it will become municipal property. Excavation averaged 48 feet, mostly in sandy subsoil; floors and mezzanines thereto are arranged so as to make possible ramps rising not more than half a story (4 feet 9 inches); all but 200 cars are

parked below the top story which houses offices, waiting rooms, telephones, etc.; the bays, 24 feet 3 inches by 27 feet 5 inches, allow more space than the usual 7 feet 2 inches per car and will be appreciated if post-war designs include a wider car. Rebuilding a park into a garage roof with an estimated average pressure of 500 lbs. a square foot included reinforcement

of the 350-ton Dewey monument granite shaft, planting 16 three to four ton trees, which with paving, granite curbs, good soil for shrubs, lawns and flowers, with drainage and sprinkler system affords an excellent shelter.

C. I. S. P. H. Architectural Review, Cheam, England, (45, The Avenue) July, 1942. pp. 41.

THE COMMITTEE for Industrial and Scientific Promotion of Housing (Chairman, Henry Weston, Chairman of the Coventry Housing Committee), omits "prefabrication" from its title because of association in the public mind of that word with temporary buildings and with an inflexible and unimaginative kind of standardization. But the committee is studying prefabricated housing methods and their application to post-war housing as well as considering house-building finance from the point of view that houses like motor cars should come to be regarded by the public as consumer goods.

COLUMBIA BASIN: A Test for Planning. By Catherine Bauer. New Republic, New York, (40 E. 49th St.) Sept. 7, 1942, pp. 279-80.

DEVELOPMENT of this tract of about 1,875 square miles may ring the familiar changes of speculative exploitation, blight, ruin and unproductive subsidy, or, as a planned enterprise with adequate government control, it may show what coordinated planning may do to house well families occupied in agriculture, industry and the necessary accompanying services, in a tract estimated as able to support half a million people. The Anti-speculation Act of 1937 restricting supply of irrigation water to family-sized farms is a beginning. HR 6522, recently submitted, would amend and improve it by facilitating government purchase of all lands as a prelude to development of irrigation, plotting farms and roads, locating villages, economical designing of rural and town housing. The things to do now demand no war material, little physical labor. They do demand straight thinking and control centered thousands of miles nearer Washington State than Washington, D. C., and in the hands of someone occupied with fewer things than are the Secretaries of the Interior and of Agriculture.

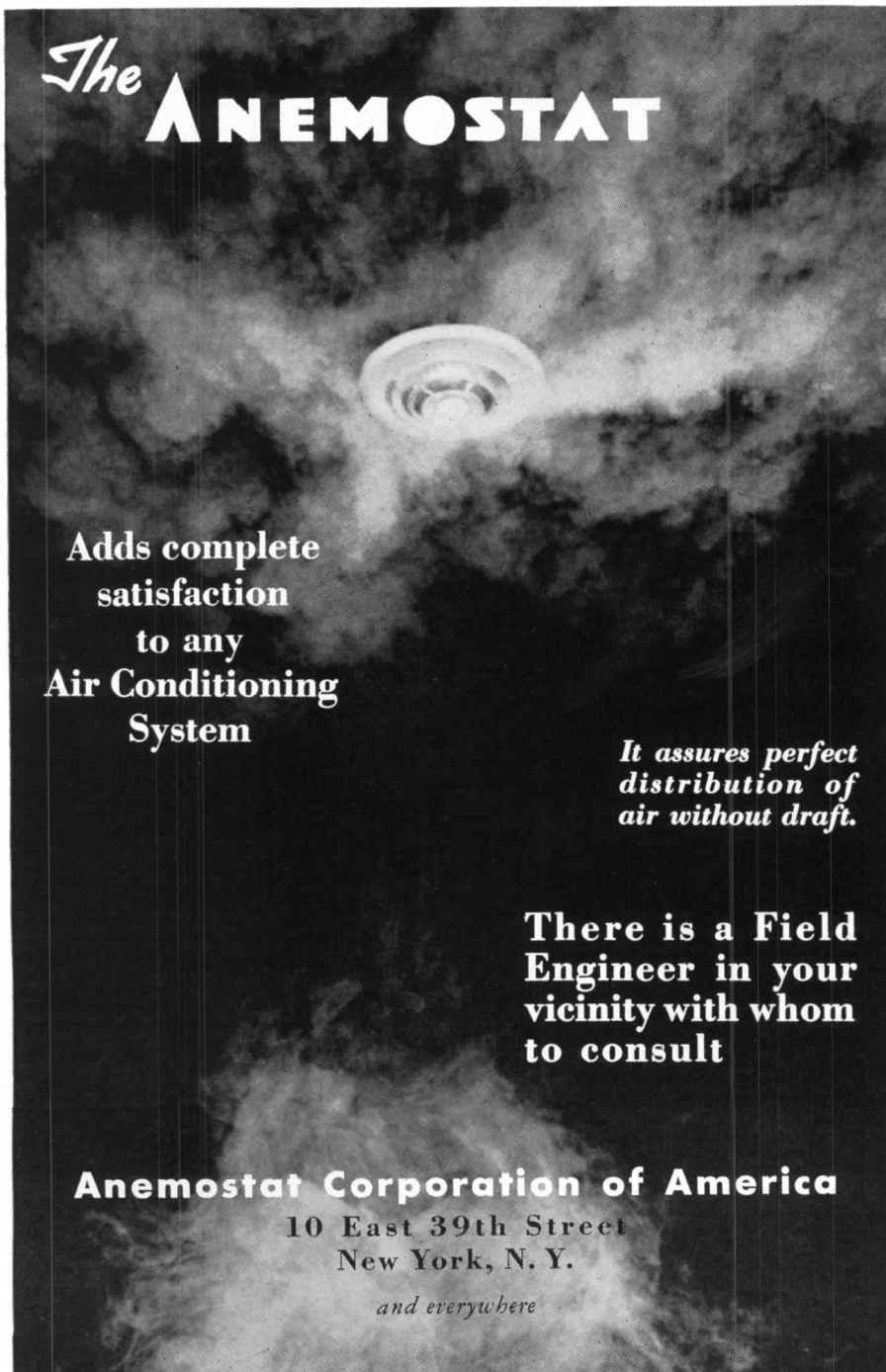

The **ANEMOSTAT**

Adds complete satisfaction to any Air Conditioning System

It assures perfect distribution of air without draft.

There is a Field Engineer in your vicinity with whom to consult

Anemostat Corporation of America
10 East 39th Street
New York, N. Y.
and everywhere



"Controlled Conditions Plants are helping win the war—"

*says Albert S. Low, Vice President and Chief Engineer,
The Austin Company, Engineers and Builders*

EFFICIENT, around-the-clock war production has become a practical reality under the constant illumination, uniform temperature and humidity that are provided at all times of the year in 'controlled conditions' plants. Manufacturers of heavy bombers, fighting planes, aircraft engines, precision instruments, radio controls and other vital war products are now achieving a real victory pace in twelve such windowless plants designed and built by us since 1930.

"In two almost identical plants like that shown above, Consolidated B-24 bombers are being produced on conveyorized assembly lines under complete atmos-

pheric control and never-changing light. There the War Department required a good working environment for maximum war production, and proper conditions to protect costly materials and sensitive instruments in storage and assembly. These 'controlled conditions' plants were authorized as the most effective means of meeting such requirements.

"Automatic blackout protection inherent in every windowless plant is a plus value which gives special advantages in wartime, eliminating the possibility of costly interruptions and need for makeshift precautions. Special wall and roof designs add the highest obtainable

insulation, plus acoustical control and maximum fire- and shatter-resistance.

"The world's first windowless factory was designed by our engineers twelve years ago to meet problems of peacetime production. Today, that plant and eleven others where we have applied the same 'controlled conditions' principles are making record contributions to America's war program through faster, higher-quality production. And when victory is finally achieved, their basic flexibility will make them permanent assets in our peacetime economy."

FACTS ABOUT "FREON" In this plant "Freon" refrigerants are used in both the general air conditioning system, of 12,000 tons ultimate capacity, and in more than 150 individual refrigeration units of 1/4 to 20 tons each.

"Freon" has been used almost exclusively for new air conditioning systems. Specifying "Freon" avoids any possibility of penalty in insurance rates, and promotes safety of life and property. Kinetic Chemicals, Inc., Wilmington, Del.



FREON

REG. U. S. PAT. OFF.

safe refrigerants

"Freon" is Kinetic's registered trade mark for its fluorine refrigerants

EDUCATION AND ARCHITECTURE

(continued from page 38)

formalize its economic basis, and from that knowledge work out a pattern of ideas to be later translated into a pattern of structures. Such investigations are, in my opinion, more useful than those general surveys in what are called, somewhat quaintly, the *social sciences*. These are apt to interpose a screen of idea and theory between the student and the substance of architecture.

The other day I heard one of our students explain to a jury his design for *A Coöperative Farm*. His explanation began with an account of the social services such a farm might render, included next some data relating to potato growing and the care of bees, and finally some considerations relative to buildings as tools for these "social and economic objectives." This explanation was assisted by charts, diagrams, reports, and photographs. The student had, it appeared, projected himself into the life of his farm. The habits of rural society were in part at least known to him—the conditions of farm labor, the changes wrought by recent inventions, and the impact of these on the forms of shelter—and it seemed to me that by that means he had attained, not a practical knowledge merely, but the sympathy and insight which gave his design a surprising eloquence. If, now, it should happen that this hypothetical farmer could not make out quite so well with his potatoes as my student planned, some essential economic or human factor having been overlooked, that would not be important. What is important is the anchor to reality implied in the method. This farmer is a better client than those ambassadors, archbishops and captains of industry who were my clients in my student days at Columbia: a truer friend to architecture even than that eccentric, affectionately remembered old gentlemen who, "finding himself in possession of four antique columns," decided to build a museum.

I SHOULD like our students to leave our schools of architecture with a wider vision and a broader range of interests than those which I had at the end of my professional studies. I should like them to feel a deeper comradeship for those who, although architects in spirit and in way of working, are yet practitioners of an affiliated art. I should wish them to be armed with a practical and immediate technology, but they should have also minds that are curious and awake to every new discovery and invention; and they should be resolute to use their art, woven into actualities and yet addressed to the spirit, for the reconstruction of our ravaged world. In that direction lies the recovered authority of architecture.

STEEL BRIDGE COMPETITION

THE American Institute of Steel Construction announces its annual bridge design competition, open to students of structural engineering and architecture. Prizes: \$200, \$100, \$50. Subject is a steel grade separation carrying a highway over the four-track main line of a railway, a canal and a dual four-lane highway. Drawings will be judged by a jury of nationally known engineers and architects, and must be received at the Institute, 101 Park Avenue, New York City, not later than February 8, 1943.



Got some big ideas for
the Small Homes
of 194X?

FOR BETTER HEATING AND
AIR CONDITIONING...TURN TO



TO ALL you architects who will plan the post-war homes of America, the door is wide open for fresh thinking. But whatever shape your plans may take, this much is certain: you will provide for year 'round thermal comfort far greater than anything known before the war.

You will want compact, low cost, economical automatic heating and air conditioning. And you will find a complete line of such equipment provided for you by G-E. For the work we are now doing to help assure Victory should surely lead to the finest, most complete range of home conditioning units in G-E history. General Electric Co., Div. 24410, Bloomfield, N.J.

FOR HEATING:

	OIL	GAS
Boilers	✓	✓
Conditioned Warm Air Units	✓	✓
Space Heaters	✓	

FOR COOLING:

Room Conditioners	✓
Central Plant Systems	✓
Store Coolers	✓
Air Circulators	✓

GENERAL  ELECTRIC

LIGHTHOUSE THROWS MORE LIGHT ON NEW TYPE OF CONCRETE CONSTRUCTION

Architectural Concrete Slabs assure permanence and low maintenance at new Coast Guard Station. Use of Slabs as exterior forms facilitates erection.

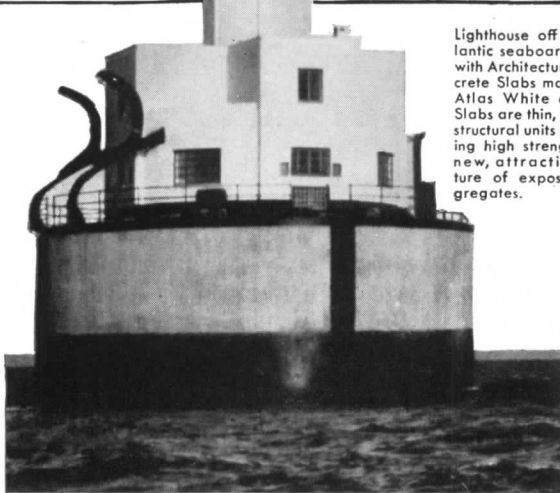

Lighthouse off the Atlantic seaboard faced with Architectural Concrete Slabs made with Atlas White cement. Slabs are thin, precast, structural units possessing high strength and new, attractive texture of exposed aggregates.

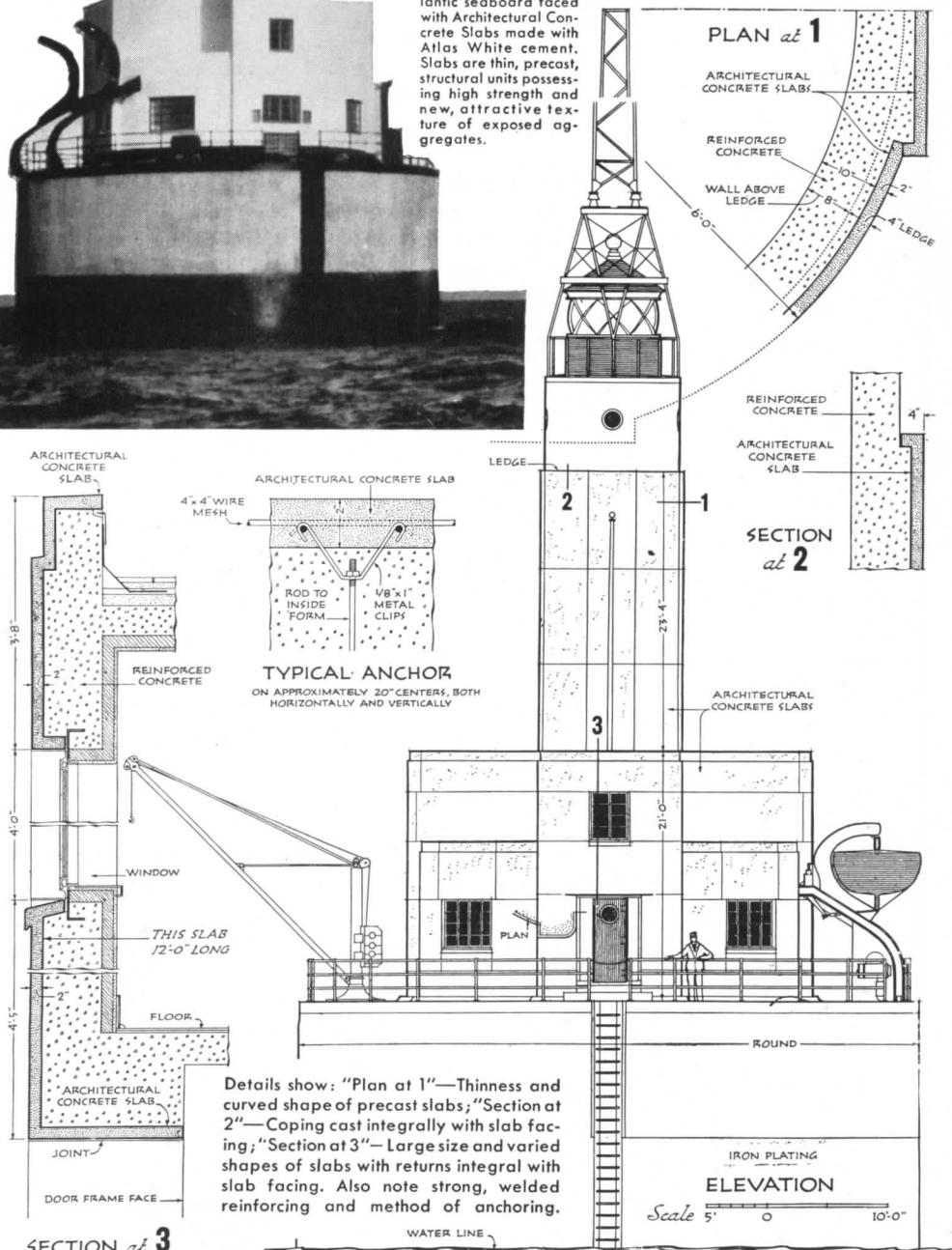

THE United States Coast Guard was faced with two primary problems in planning this lighthouse, which stands somewhere off the Atlantic seaboard:

- 1—to build a permanent, white structure that would not require periodic refinishing;
- 2—to build a structure with a minimum number of joints to reduce danger of leakage and disintegration at joints.

Thin, precast Architectural Concrete Slabs made of steel, stone, and Atlas White cement answered both requirements. They provided a permanent, white exterior that will need no repainting. The large size—up to 12' by 4½'—reduced the number of joints. Their varied shapes permitted the returns, including window heads, sills, copings, jambs, and soffits, to be cast integrally with the slab facing. This saved time and cost for waterproofing, flashing, and pointing; reduced danger of leakage and disintegration at joints; and resulted in quicker erection at lower cost. The high strength of slabs enabled them to serve as exterior forms for the structural concrete, reducing scaffolding and job forming to a minimum.

This is just one example of the versatility and adaptability of these factory-made structural and decorative units. To get the complete story, send the coupon for a new 28-page booklet, complete with plans and detailed drawings of many typical jobs. Universal Atlas Cement Company (United States Steel Corporation Subsidiary), Chrysler Bldg., N. Y. C.

OFFICES: New York, Chicago, Philadelphia, Boston, Albany, Pittsburgh, Cleveland, Minneapolis, Duluth, St. Louis, Kansas City, Des Moines, Birmingham, Waco.

Universal Atlas Cement Company
Chrysler Bldg., New York City

Please send me a free copy of your new 28-page booklet, "Architectural Concrete Slabs."

Name _____
Address _____
City _____ State _____

AR-ACS-33

ARCHITECTURAL CONCRETE SLABS

MADE WITH ATLAS WHITE CEMENT



A BRIGHTER FUTURE FOR YOUR CITY—

in soft, clear, iron-free water

HAPPIER HOMES!
soft, clear water means less work, more fun

BUSIER INDUSTRIES!
Less treatment for boiler and process water

MORE PROSPEROUS SHOPS!
Better service—at less cost—for laundries, restaurants, etc.

Permutit* Spaulding Precipitator

This new type of equipment puts soft water within reach of every community. It makes cold lime soda treatment more practical than ever, because it takes only half the space of old-type plants, cuts precipitation time, makes big savings in chemicals.

Plan now for better water



After the war, when public improvements are resumed, a good water supply will be the first thought of many communities. Be sure you are prepared with the latest information. Write for new free booklet to The Permutit Company, Dept. AR, 330 West 42nd Street, New York, N. Y. In Canada: Permutit Company of Canada, Ltd. . . . Montreal . . . Toronto . . . Winnipeg . . . Calgary.

*Trademark Reg. U.S. Pat. Off.

PERMUTIT

WATER CONDITIONING HEADQUARTERS

BOOKS FOR WAR-TIME REFERENCE

The books listed below are especially helpful for architects and engineers in solving their many technical problems, including those pertaining to war time construction and the protection of the civilian population.

1. **PLANNED A.R.P.**, by Tecton, Architects. 138 pages — extensively illustrated with photographs, diagrams and maps — Price \$2.50.
2. **CIVIL AIR DEFENSE**, by Lt. Col. Augustin M. Prentiss, U.S.A. A 334-page illustrated treatise on the protection of the civil population against air attack — Price \$2.75.
3. **BOMBS AND BOMBING**, by Willy Ley. 124 pages — A brisk, popular survey explaining how the several kinds of bombs are made and their probable effect on buildings of different types and on air raid shelters — Price \$1.25.
4. **CIVIL DEFENSE**, by C. W. Glover. Over 900 pages — fully illustrated, revised and enlarged. The most complete and authoritative book on the subject. This volume discusses in detail the precautions necessary for the protection of the civilian population — Price \$16.50.
5. **ARCHITECTURAL SPECIFICATIONS**, by Harold Reeve Sleeper, A.I.A. 822 pages — Price \$10.00.
6. **ARCHITECTURAL GRAPHIC STANDARDS**, by Charles G. Ramsey and Harold R. Sleeper, 2nd Edition — 284 pages, 9¼ x 9½ in. — Price \$6.00.
7. **ARCHITECTS' AND BUILDERS' HANDBOOK**, by Frank E. Kidder and Harry Parker, 18th edition — 2,315 pages — 4½ x 7 in. — Price \$8.00.
8. **SIMPLIFIED ENGINEERING FOR ARCHITECTS AND BUILDERS**, by Harry Parker. 214 pages — 96 illustrations — 5 x 7¾ in. — Price \$2.75.

ARCHITECTURAL RECORD

119 West 40th Street, New York, N. Y.

Please send 1. 2. 3. 4.
5. 6. 7. 8.

Check or money order for.....is enclosed.

Name

Address

City and State

AR 10-42

Check the numbers of the books you want, and mail to Architectural Record with your remittance—no extra charge for postage

An Engineer's Commendation



of the Proper Design and Pre-Planning of **OIL BURNING SYSTEMS**

Sullivan A. S. Patorno is one of the leading Consulting Engineers in the East. His organization, which handles mechanical and electrical engineering work, has acted as consultants for the New York City Housing Authority on several projects, among which was the Fort Greene Houses development in Brooklyn, N. Y. They also have been consultants for the New York State Housing Authority and on many U. S. Government defense projects. Mr. Patorno has specified Petro equipment for many years, and adds these comments on oil burning equipment:

"America's industry is all-out for victory, and in this victory program America's manufacturers are all-out for service. In the oil heating field, the Petroleum Heat and Power Company have set an enviable example of what can be done in the way of engineering assistance in order to make absolutely sure that their oil burning systems perform a hundred per cent war-time job. This kind of service results in the wisest use of oil and helps increase production all along the line."

Petro's Engineering Service Is Unimpaired

Mr. Patorno's comment brings out clearly one of the chief reasons for the continuously satisfactory operation of Petro Systems, even under the stresses of war production loads.

The engineering of the system's installation supplements, and makes effective in operation, the excellences built into the equipment by the manufacturer. And this careful pre-planning service is being rendered today as fully and effectively as ever on every installation which existing restrictions permit.

The commendation quoted above, while based on the extended experience of one large office, truly reflects the far greater aggregate experience of the thousands of operators of Petro systems.

And even under the stresses of war production loads on Petro Systems, we have had no unusual increase in calls for field service—a fact which supplies its own comment on the "plusses" which have become traditional in Petro design and manufacture.

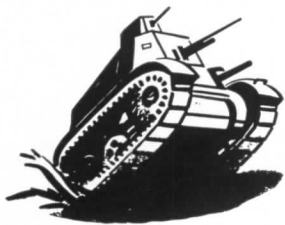

OIL IS AMMUNITION USE IT WISELY

Full data on Petro Industrial Burners are in our Catalog in Sweet's Catalog file—or we will gladly send copies on request.



PETRO

Cuts Steam Costs



PETROLEUM HEAT AND POWER COMPANY

STAMFORD

—Makers of good Oil Burning Equipment since 1903—

CONNECTICUT

On Wood Construction

CABOT'S STAINS

save time and trouble

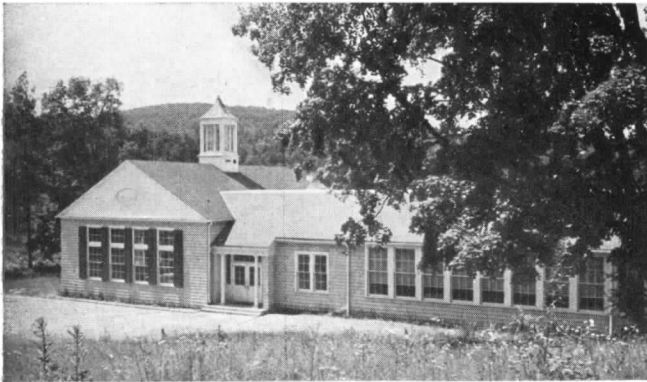

*Cabot Stained Schoolhouse at Cornwall, Conn.
Architects: Adams & Prentice, New York City*

Cabot's Stains are quick and easy to apply. Remarkably trouble-free, they do not peel or blister even when applied on unseasoned lumber, or before the building has dried out. Cost less than paint. Give maximum protection with no waste of precious raw materials.



FREE BOOKLET—*Stained Houses*. Contains full information. Write for your copy and color card today. (Or look up Cabot's Stains in Sweet's.) Samuel Cabot, Inc., 1287 Oliver Bldg., Boston, Mass.

Cabot's Shingle Stains

Creosote

Heavy-Bodied

Protect your **NORTON**
DOOR CLOSERS

For Efficient Operation and Longer Life

Under present wartime conditions the production of door closers is restricted and replacement parts are going to be hard to get. Periodic inspection, proper lubrication and careful maintenance will make your present long-life Norton Door Closers last longer. Protect the ones you've got.

NORTON DOOR CLOSER COMPANY

Division of The Yale & Towne Mfg. Company

2910 N. Western Ave.

Chicago, Illinois

*Safeguard
their
Health*

It's important to follow a known standard of health and hygiene when selecting drinking fountains for school replacement. Halsey Taylor Drinking Fountains are definitely the answer, because for years they have met every test for health-safety, until today they're recognized everywhere as superior for safeguarding the pupils' health!

THE HALSEY W. TAYLOR COMPANY
WARREN, OHIO

Write for

our latest catalogue, illustrating and describing Halsey Taylor pedestals, wall, recess and battery types.

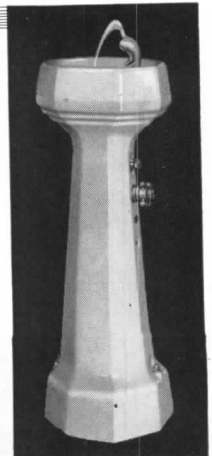

Halsey Taylor
Drinking Fountains

USERS OF SWEET'S

CATALOG FILE are turning up in unusual places these days. An architect writes us that he is now in uniform and "please rush a Sweet's file to me at . . . where we are building a two million dollar base." An engineer with a field construction force makes a similar request, explaining that he is hundreds of miles away from the office set of Sweet's files he formerly used. Add the hundreds of demands from new offices, both government and private, who see in Sweet's service the ideal answer to their information needs, and you can picture some of our problems of war-time distribution. Every effort is being made to put Sweet's on the job wherever building is being planned—for war or for post-war use. If we haven't yet caught up with you, please communicate with Sweet's Catalog Service, *Distribution Department, 119 West 40th Street, New York, N. Y.*

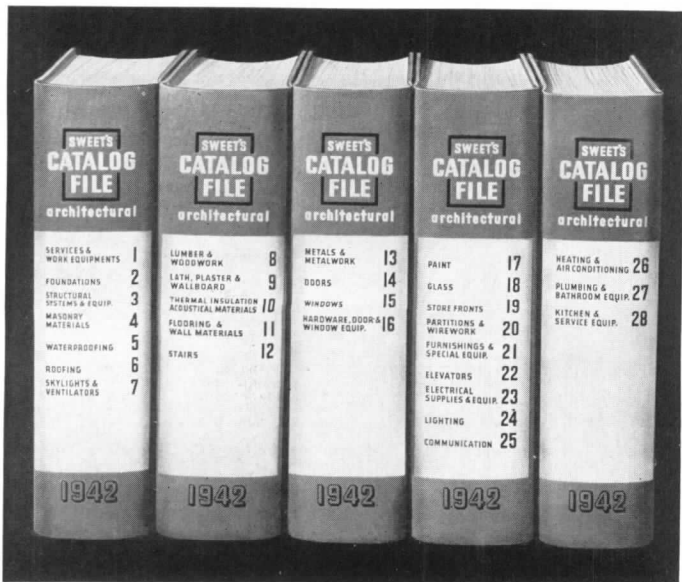

purchase m
SECTION BASE
 . . . This base is being greatly expanded and improved. We are large buyers of all kinds of machinery, heavy hardware, building materials, and electrical material. We could not get along without Sweet's."

AIR BASE
 . . . We are very much in need of Sweet's Catalog File as it is necessary for us to purchase many and varied products."

FEDERAL DEPARTMENT
 . . . This division is frequently called upon to send from country materials and equipment of American manufacture. It would be a great convenience to us in the selection of proper materials and equipment if we could be supplied a set of Sweet's."

ARCHITECTS' OFFICE
 . . . We have a force of eighty architects and engineers working in connection with this project and find a need for two sets of Sweet's Catalog Files. You were kind enough to send us one and we are wondering if it would be possible to have another."

AIRCRAFT PLANT
 . . . We have an urgent need for Sweet's Catalog File at this time to help us in the selection of building products."

DISTRICT ENGINEER
 This office is handling all War Department construction in this district and will amount to approximately \$50,000,000 during the year. Sweet's is very helpful in selecting, planning and purchasing necessary and material."

CONTRACTOR
 We are constructing one of the (Navy) projects, and have need for Sweet's Catalog File constantly."

AREA ENGINEER
 The construction work on this project is to begin in the very near future and we appreciate if delivery of Sweet's can be expedited."

AIR CORPS SCHOOL
 The purchase of a large part of the construction materials, furniture, Sweet's Catalog File will be of inestimable value. We requested that you make shipment of same by the earliest date."

ARMY CAMP
 The purchase of a large part of the construction materials, furniture, Sweet's Catalog File will be of inestimable value. We requested that you make shipment of same by the earliest date."

BASE
 . . . This base is being greatly expanded and improved. We are large buyers of all kinds of machinery, heavy hardware, building materials, and electrical material. We could not get along without Sweet's."

Eliminate WINDY-DAY Struggles

Tall buildings are like a tall chimney—they have suction draft velocities—sometimes as high as 60 m.p.h.—at the entrance.

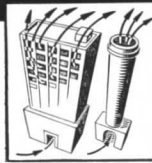

Don't force those who enter your clients' buildings to struggle with swing doors on windy days. Wind "pressure" makes swing doors difficult—if not impossible—to operate on windy, cold days.

Revolving doors eliminate "door-tugging." They are "balanced"—revolve with ease in 30 to 60 mile winds. Your clients' customers will like their convenience.

CUTS HEATING COSTS 25% OR MORE

Revolving doors will cut your clients' heating bill. They are draft-proof—hold cold air out; hot air in. Smaller heating units can be used with revolving doors, which makes for initial savings.

DELIVERIES AFTER THE WAR

Include revolving doors in your after-the-war specifications. Your client will appreciate the savings and conveniences they offer. Be among the first to get revolving doors for your clients when we again can make deliveries.

WRITE FOR FREE DATA FOLDER AND NEW CATALOG

Revolving Door

★INTERNATIONAL
★VAN KANNEL
★ATCHISON

DIVISION of
INTERNATIONAL
STEEL COMPANY
EVANSVILLE
INDIANA



"Automatic" CONCRETE CURING

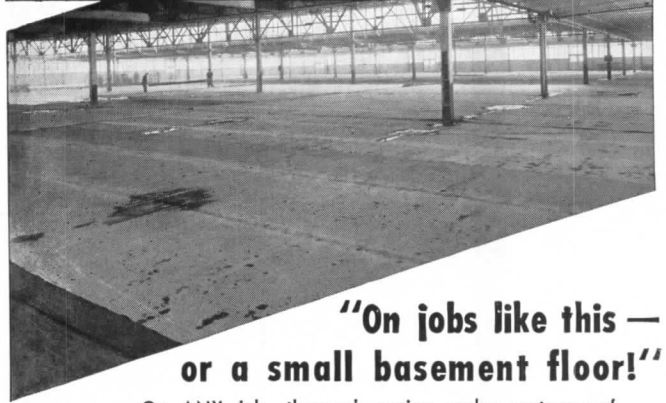

"On jobs like this —
or a small basement floor!"

On ANY job, thorough curing under waterproof SISALKRAFT assures maximum hardness, density and strength. This method is simple, positive and economical. Once the paper is laid over a freshly finished slab, no further attention is required. No sand, bur-lap or sprinkling. No human element. SISALKRAFT for concrete curing is becoming the standard specification.



Write for complete data file.

The SISALKRAFT Co.

205 W WACKER DRIVE • CHICAGO, ILLINOIS
NEW YORK SAN FRANCISCO

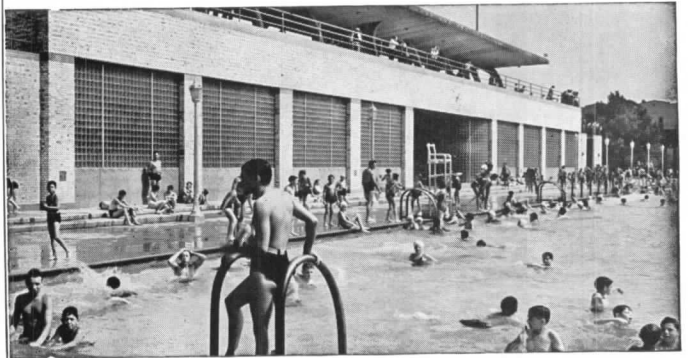

W&T

nationwide
organization services
installations . . .

"Swim
in
Drinking
Water"

IN these days of priorities it is reassuring to architects and engineers to know that the Wallace & Tiernan organization is available for servicing present installations, thereby keeping them at peak efficiency during this emergency period. Health is more important now than ever before, and chlorination in swimming pools insures the health of the swimmers. Hundreds of architects and engineers rely on the Wallace & Tiernan nationwide service organization to keep W & T equipment in top working condition. ASK FOR THE W & T SWIMMING POOL TECHNICAL PUBLICATIONS REVIEWING WATER TREATMENT ON SEVERAL DIFFERENT TYPES OF POOLS.

WALLACE & TIERNAN CO., INC.

Manufacturers of Chlorine and Ammonia Control Apparatus
NEWARK, NEW JERSEY
REPRESENTED IN PRINCIPAL CITIES



Straight Lines and Short Hauls

THE urgency of the war production program and the necessity of providing men, materials and machinery for the rapid construction of all kinds of war building and engineering projects quite naturally present many opportunities for indirect transportation and costly cross hauling problems.

But losses in time and money from such causes have been largely avoided by subscribers to Dodge Reports, who were able to obtain bids from firms whose sources of supply were located closest to each construction project.

This is just one of many illustrations of uses of Dodge Reports service which are emphasizing anew the importance of issuing timely, complete and accurate construction information to the building trades. Under the present unusual conditions with which the industry and the nation are confronted, it is more than ever essential that straight lines and short hauls be the order of the day. And, architects who keep Dodge Reporters posted on work on their boards are thus helping to improve the efficiency of the whole war production program.

DODGE REPORTS



Issued by F. W. DODGE CORPORATION, 119 WEST 40th STREET, NEW YORK, N. Y.

Daddy's 6 feet-2
but only a kid
at heart



Imagine anyone having to take care of Daddy—but it's so! He needs someone to help him choose his food, spruce-up his clothes, to remind him gently to look fit and keep fit. That's why thousands of wives and mothers say to husbands and sons, "For your sake and ours, stop at a hotel."

AMERICAN HOTEL ASSOCIATION



STUCK IN A STORM?—Don't worry about traffic or transportation if stormbound returning from a show or event. Stay at a hotel overnight.



LESS WORK, TOO, FOR MOTHER—Mother may be a wonderful cook, but the best cooks in the world like to dine out—and often! Give Mother a break.



SICKNESS AT HOME?—When contagious diseases exile you from your home, stay at a hotel during the upset period. We'll take good care of you.



The Sign of a
Recognized Hotel

for a fresh **START**
STOP at a **HOTEL**

A Short Cut to Your CONSTRUCTION COST PROBLEMS

FOR PRELIMINARY ESTIMATES

Boeckh's Manual contains cubic and square foot costs on approximately 500 types of buildings with a total of over 7,000 specific base cost figures and, in addition, thousands of specific cost variations.

All costs are keyed to local construction cost conditions through exclusive index conversion formulas—Boeckh's Manual never gets out of date if used with the conversion index.

Boeckh's Manual of Appraisal is now used by over 8,500 firms, among which are hundreds of architects and builders. This Manual is nationally recognized by Fire Insurance Companies and Mortgage Loan Agencies as a standard of Building Construction Costs.

Boeckh's Manual of Appraisals and Pad of Work Sheets. Price shipping prepaid **\$6**

Local Current Index Conversion Factors (each location). Price shipping prepaid **\$1**

Order now, examine it for 10 days, then if you are not completely satisfied return the Manual and your money will be refunded.

E. H. BOECKH & ASSOCIATES
Consulting Valuation Engineers

903 TIMES-STAR BUILDING,
CINCINNATI, OHIO

SELECTED BOOK LIST

Here is an opportunity to add one or more important architectural books to your working library. Each one of these titles is a standard on its particular subject and is well worth the price.

1. **DESIGN OF MODERN INTERIORS**, by James Ford and Katherine Morrow Ford. 132 pages, 324 illustrations—8½ x 10¾ in. — Price, \$5.00.
2. **BETTER HOUSES FOR BUDGETEERS**, by Royal Barry Wills. 104 pages—9 x 12 in.—Sketches, plans and descriptions—Price, \$3.00.
3. **GLASS IN ARCHITECTURE AND DECORATION**, by Raymond McGrath and A. C. Frost. 650 pages, 462 halftone and line illustrations—9½ x 12½ in.—Price, \$20.00.
4. **AERIAL BOMBARDMENT PROTECTION**, by Harold E. Wessman and William A. Rose. 372 pages — 5¾ x 9 in. illustrations—Price, \$4.00.
5. **HOUSES FOR GOOD LIVING**, by Royal Barry Wills. 104 pages, 9 x 12¼ in.—102 illustrations and plans—Price, \$4.00.
6. **GUIDE TO STANDARD SPECIFICATIONS FOR GOVERNMENT BUILDING**, by Harold R. Sleeper, A.I.A. Single copies, 50 cents each.
7. **SIMPLIFIED ENGINEERING FOR ARCHITECTS AND BUILDERS**, by Harry Parker, 214 pages — 96 illustrations 5 x 7¾ in. — Price \$2.75.
8. **THE RESTORATION OF COLONIAL WILLIAMSBURG**, a cloth-bound reprint of Architectural Record for December 1935 — 104 pages — Price \$1.50.
9. **WORKING DETAILS, PART I. Domestic**, edited by Mildred W. White. 139 pages. Price \$4.00.
10. **THE MODERN HOUSE**, by F. R. S. Yorke, A.R.I.B.A. 500 illustrations, 10 x 7½ in. — photographs, plans and constructional details of modern dwellings — Price, \$6.00.
11. **WILLIAMSBURG VIRGINIA IN PHOTOGRAPHS (Official publication of Colonial Williamsburg, Inc.)** 2nd edition —35 full page illustrations—Price, \$1.00.
12. **THE MODERN HOUSE IN AMERICA**, by James Ford and Katherine Morrow Ford. 134 pages—8½ x 11 in.—193 illustrations, drawings and plans—Price, \$5.00.
13. **STORE INTERIOR PLANNING AND DISPLAY**, by A. Edward Hammond. 247 pages — Price \$5.00.
14. **ARCHITECTURAL GRAPHIC STANDARDS**, by Charles G. Ramsey and Harold R. Sleeper, 3rd edition—344 pages, 9¼ x 9½ in. — Price, \$6.00.
15. **THE NEW ARCHITECTURE IN MEXICO**, by Esther Born. 159 pages—9 x 12 in.—Price, \$2.50.

Check on the order form the numbers of the books you want, and mail to Architectural Record with your remittance — no extra charge for postage.

ARCHITECTURAL RECORD • 119 West 40th Street, New York, N. Y.

Please send 1. 2. 3. 4. 5. 6. 7. 8.
9. 10. 11. 12. 13. 14. 15.

Check or money order for.....is enclosed.

Name

Address

City and State

AR 10-42

STRENGTH

Where It's
Most Needed

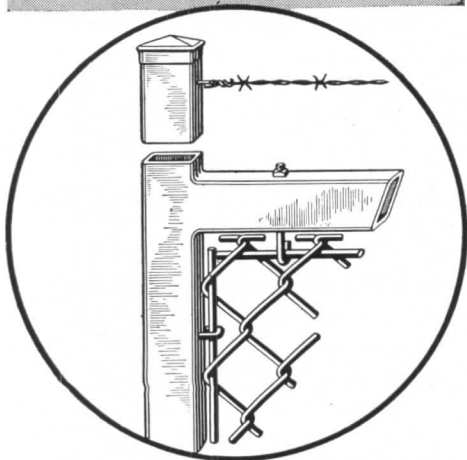

Anchor Square Frame Gates

Always specify Anchor Square Frame Gates, or equal. They swing freely, latch easily and look more attractive, even after years of service. That's because they're built of strong, two-inch square steel tubing, inseparably butt-welded at all corners to provide amazing rigidity, freedom from sagging and warping. The fabric is firmly held by rounded steel tension rods. Made in both single and double types, in a variety of sizes from single-file entrance gates to large gates for railroad sidings. Find out how Anchor Gates, and other important Anchor features provide extra protection, durability, low maintenance cost. Write for Anchor Protective Fence Manual and name of nearest Anchor Engineer. ANCHOR POST FENCE CO., 6600 Eastern Avenue, Baltimore, Maryland.

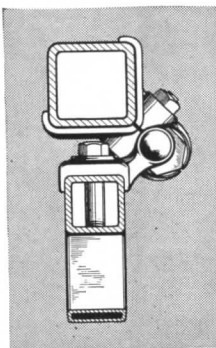

Special "Clamp-on" Hinges permit 180° swing. Can be adjusted to open either in or out.

1892-1942 Fifty Years of Service
Nation-wide Sales
and
Erecting Service



INDEX TO ADVERTISEMENTS

Catalogs of concerns marked (s) are filed in Sweet's Catalog File (1942)

	Page		Page
(s) ALUMINUM COMPANY OF AMERICA.....	21	KINETIC CHEMICALS, INC.	89
Agency: Fuller, Smith & Ross, Inc.		Agency: Batten, Barton, Durstine & Osborn	
(s) AMERICAN BRASS COMPANY	29	KOH-I-NOOR PENCIL COMPANY, INC.	32
Agency: Ivey & Ellington, Inc.		Agency: Roeding & Arnold	
AMERICAN HOTEL ASSOCIATION	98		
Agency: John Falkner Arndt & Co., Inc.		(s) LCN DOOR CLOSERS	11
AMERICAN ROLLING MILL COMPANY.....	14	Agency: J. H. Hamilton Adv. Agency	
Agency: N. W. Ayer & Son, Inc.		(s) LIBBEY-OWENS-FORD GLASS COMPANY ..	28
(s) ANCHOR POST FENCE CO.	100	Agency: Fuller, Smith & Ross, Inc.	
Agency: Van Sant Dugdale & Company		(s) LOUISVILLE CEMENT COMPANY, INC.	25
(s) ANEMOSTAT CORPORATION OF AMERICA ..	88	Agency: Doe-Andersen Advertising Agency	
Agency: G. P. Blackiston			
(s) ARMSTRONG CORK CO.	27	(s) MAHON, R. C., COMPANY	13
Agency: Batten, Barton, Durstine & Osborn		Agency: Anderson, Inc.	
		(s) MILLER COMPANY	2nd Cover
(s) BETHLEHEM STEEL COMPANY	101	Agency: J. M. Hickerson, Inc.	
(s) BLUE RIDGE GLASS CORPORATION	79		
Agency: Fuller, Smith & Ross, Inc.		NELSON HERMAN CORPORATION	82
BOECKH, E. H., & ASSOCIATES	98	Agency: L. W. Ramsey & Co.	
(s) BYERS, A. M., COMPANY	4	(s) NORTON DOOR CLOSER COMPANY	94
Agency: Ketchum, MacLeod & Grove, Inc.		Agency: K. E. Shepard	
(s) CABOT, SAMUEL, INC.	94	(s) PERMUTIT COMPANY	92
Agency: Mason L. Ham		Agency: Newell-Emmett Company	
(s) CARNEGIE-ILLINOIS STEEL CORPORATION	30	(s) PETROLEUM HEAT & POWER COMPANY ...	93
Agency: Batten, Barton, Durstine & Osborn		(s) PITTSBURGH PLATE GLASS COMPANY	17
(s) CELOTEX CORPORATION	19	Agency: Batten, Barton, Durstine & Osborn	
Agency: McFarland, Aveyard & Company			
CLEAVER-BROOKS COMPANY	4th Cover	RCA MANUFACTURING COMPANY, INC.	22
Agency: Klau-Van Pietersom-Dunlap Associates		Agency: Lord & Thomas	
(s) CONGOLEUM-NAIRN, INC.	32	(s) REPUBLIC STEEL CORPORATION	81
Agency: McCann Erickson, Inc.		Agency: Meldrum & Fewsmith	
		RICO LAMINATED PRODUCTS, INC.	87
(s) DODGE REPORTS	97	Agency: Alfred Colle Company	
		(s) ROBERTSON, H. H., COMPANY	8-9
ELECTRIC STORAGE BATTERY COMPANY..	20	Agency: Fuller Smith & Ross, Inc.	
Agency: Geare-Marston, Inc.			
FABER, A. W., INC.	24	(s) SANMETAL PRODUCTS CO., INC.	16
Agency: Advertising Associates		Agency: Lee E. Donnelley Company	
(s) FITZGIBBONS BOILER COMPANY, INC.	18	(s) SCOTT PAPER COMPANY	3rd Cover
Agency: Peterson & Kempner, Inc.		Agency: J. Walter Thompson Co.	
		(s) SISALKRAFT CO.	96
(s) GENERAL ELECTRIC AIR CONDITIONING...	90	Agency: Klau-Van Pietersom-Dunlap Associates	
Agency: Newell-Emmett Co.		SLOAN VALVE COMPANY	15
(s) GENERAL ELECTRIC—HOME BUREAU	2	Agency: Reincke, Ellis, Younggreen & Finn	
Agency: Maxon, Inc.		(s) SWEET'S CATALOG SERVICE	95
(s) GRINNELL CO., INC.	33		
Agency: Horton-Noyes Company		(s) TAYLOR, HALSEY W., COMPANY	94
		Agency: William Cohen	
HAZARD INSULATED WIRE WORKS	12	TIMBER ENGINEERING COMPANY	64
Agency: Doyle, Kitchen & McCormick, Inc.		Agency: Campbell-Ewald Company	
(s) HOME OWNERS' CATALOGS	102	TODD COMBUSTION EQUIPMENT, INC.	31
(s) HORN MANUFACTURING COMPANY	86	Agency: Wendell P. Colton Company	
Agency: Cary-Ainsworth, Inc.			
(s) INTERNATIONAL STEEL COMPANY	96	(s) UNITED STATES STEEL CORPORATION	30-31
Agency: Keller-Crescent Company		SUBSIDIARIES	30-31
(s) JOHNS-MANVILLE	34	Agency: Batten, Barton, Durstine & Osborn	
Agency: J. Walter Thompson Co.		(s) UNIVERSAL ATLAS CEMENT CO.	91
		Agency: Batten, Barton, Durstine & Osborn	
(s) KAWNEER COMPANY	85	UPSON COMPANY	83
Agency: Carter, Jones & Taylor		Agency: McCann-Erickson	
(s) KEASBEY & MATTISON COMPANY	3	(s) WALLACE & TIERNAN COMPANY, INC.	96
Agency: Geare-Marston, Inc.		Agency: G. M. Basford Company	
(s) KENNEDY, DAVID E., INC.	1	(s) WEBSTER, WARREN & COMPANY	10
Agency: Gerald Lesser Advertising		Agency: William Jenkins Advertising	
		(s) WESTINGHOUSE ELECTRIC & MANUFACTURING CO.	23
		Agency: Fuller, Smith & Ross, Inc.	
		(s) YORK ICE MACHINERY CORPORATION	6
		Agency: J. M. Mathes, Inc.	

New York—General Manager: H. Judd Payne. Advertising Manager: Tom Tredwell. B. B. Orwig, 119 West 40th Street. Boston—Robert Marshall, 855 Park Square Bldg.; Chicago—C. B. Riemersma, F. H. Bowes, 700 Merchandise Mart; Cleveland—Homer Andrews, 321 Hanna Bldg.; Los Angeles—W. R. McIntyre, 400 East Third St.; Philadelphia—Tom Tredwell, 1321 Arch Street.

Unusual features in experimental war housing



At Parkridge, a group of 168 units of a 750-house program for an Eastern industrial center, the architect was given a free hand in designing four experimental units, construction to cost \$3000 each. The unit above, a one-story, free-standing house with two bedrooms and inside bath, differs radically in both plan and structure from the others. The utilities section—with ducts of Bethlehem Galvanized Steel Sheets and Beth-Co-Weld Pipe used for water supply—is concentrated in the center for free circulation and increased flexibility of use.

Below is another of the units. Living, dining and kitchen areas are merged into one large space. Note the screened porch recessed in the rear. The two bedrooms are divided by a series of three demountable prefabricated closets, bolted together. Thus, the size of either bedroom can be changed merely by moving the closets. All units have pressed fibre-board floors and horizontally-sliding wood windows of such size that more than 50 per cent of the outside wall area is window space.

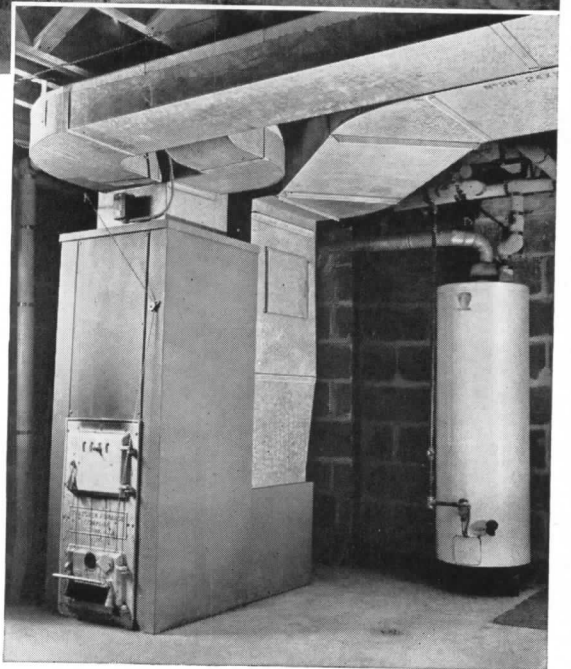

Architects: Antonin Raymond, Edwin Schruers, Associate.
Contractors: Christiansen and LaFountain.

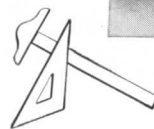

Above. All four experimental units are well heated by individually coal-fired, forced-air heating systems located in the basements which extend beneath only a portion of the floor area. All air ducts were made of tightly-galvanized, easy-forming Bethlehem sheets. For the water supply the architects specified Beth-Co-Weld Pipe, made by the continuous-weld process for greater strength and uniformity.

BETHLEHEM STEEL COMPANY



"...we'll build when war and priorities permit"

I plan to erect as soon as the p conditions are readjusted or pri are loosened sufficient to normal building.

I will, because

P.O. Box
Farm

Dear

Build

Sum

cott

\$5,00

and

comm

lot

Mass

to

we

Wilmington, Delaware

F. W. Dodge Corporation,
119 West 40th Street
New York, N. Y.

Gentlemen:

Kindly send us a free copy of Home Owners' Catalogs advertised in the April issue of Better Homes & Gardens.

We are planning to build a Cape Cod style house, containing kitchen, dining room, living room, two bed rooms and bath on the first floor and sufficient space on the second floor for two additional bed rooms. The location is to be on Van Buren Street between Market and Washington Streets in Wilmington, and the cost is expected to be about \$9,000. If we cannot build this year due to inability to obtain materials, we plan to build when the war priorities permit. Architect and builder have not been selected.

Very truly yours,
John & Jean Potter

emergency
one lot,

F. W. Dodge Co
119 W. 40th St.
New York, N. Y.

Gentlemen:

Per your ad April, 1942, page 10, I have recent address, an eight-lot approximately remodeling.

While no contract was looked into, I have looked it over, at \$3,500, for the

At the present time, it is possible to carry out until such a time as I am needed (and I am wanted), and I am willing to accept the remodeling of the glass brick house.

In the meantime, I do not know what to do that I shall be able to do exactly what you desire. I am sure that your assistance you can give me is appreciated, as I am interested in your work.

Thanking you

Gentlemen:
After the war we intend to build a home with a two car garage for a cost of \$6500.00. I live in Middletown Farmington Conn. property in yet we have no architect. Hoping to receive copies of catalogs.

Home Owners' CATALOGS

Many more such verified examples could be quoted from people planning now for homes they will build after the war. Request FREE copies of HOME OWNERS' CATALOGS for your clients and prospects building now . . . or when war priority conditions permit.

PUBLISHED BY F. W. DODGE CORPORATION—119 W. 40th St., New York, N. Y.

RESTRICTIONS—Home Owners' Catalogs will be sent only to owners who plan to build homes for their own occupancy, within 12 months, or as soon as war and priority conditions permit, in the 37 states east of the Rocky Mountains, costing \$4000 or more for construction, exclusive of land—or to modernize at a cost of \$2000 or more. THE F. W. DODGE CORPORATION RESERVES THE RIGHT TO DETERMINE THE VALIDITY OF EACH APPLICATION.

F. W. DODGE CORPORATION AR 10-42
119 West 40th Street, New York, N. Y.

In accordance with these restrictions, please send a copy of Home Owners' Catalogs to:

Name

Address

City..... State

Signed Architect of

