

# BUILDING NEWS

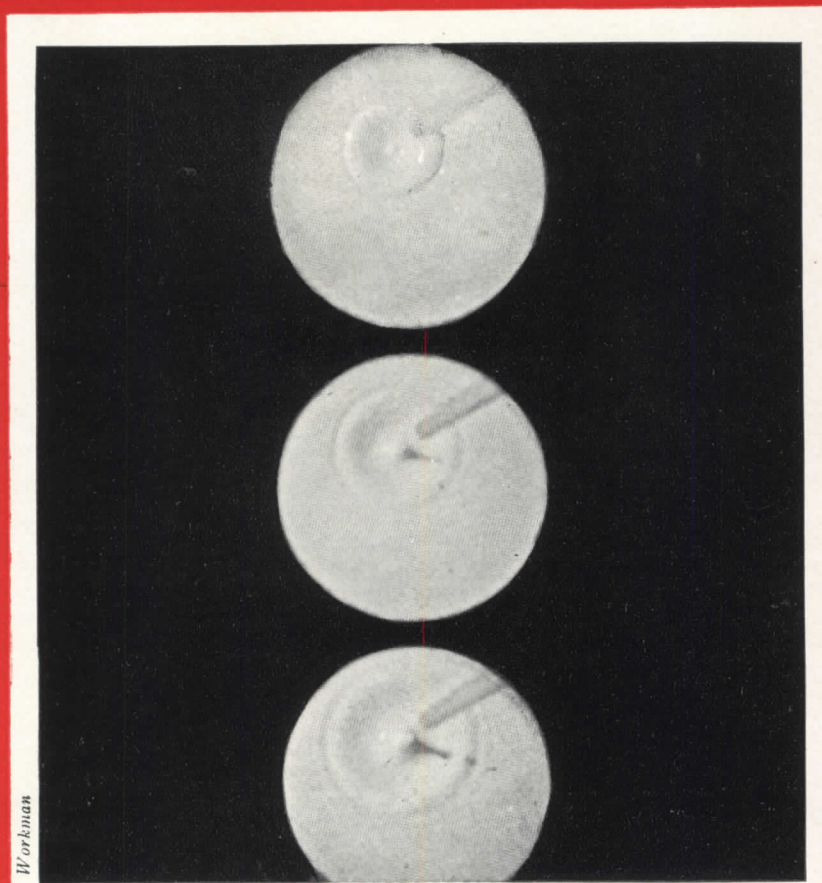

Workman

**From ripple and splash an architect evolves a new form...**

ARCHITECTURAL  
RECORD

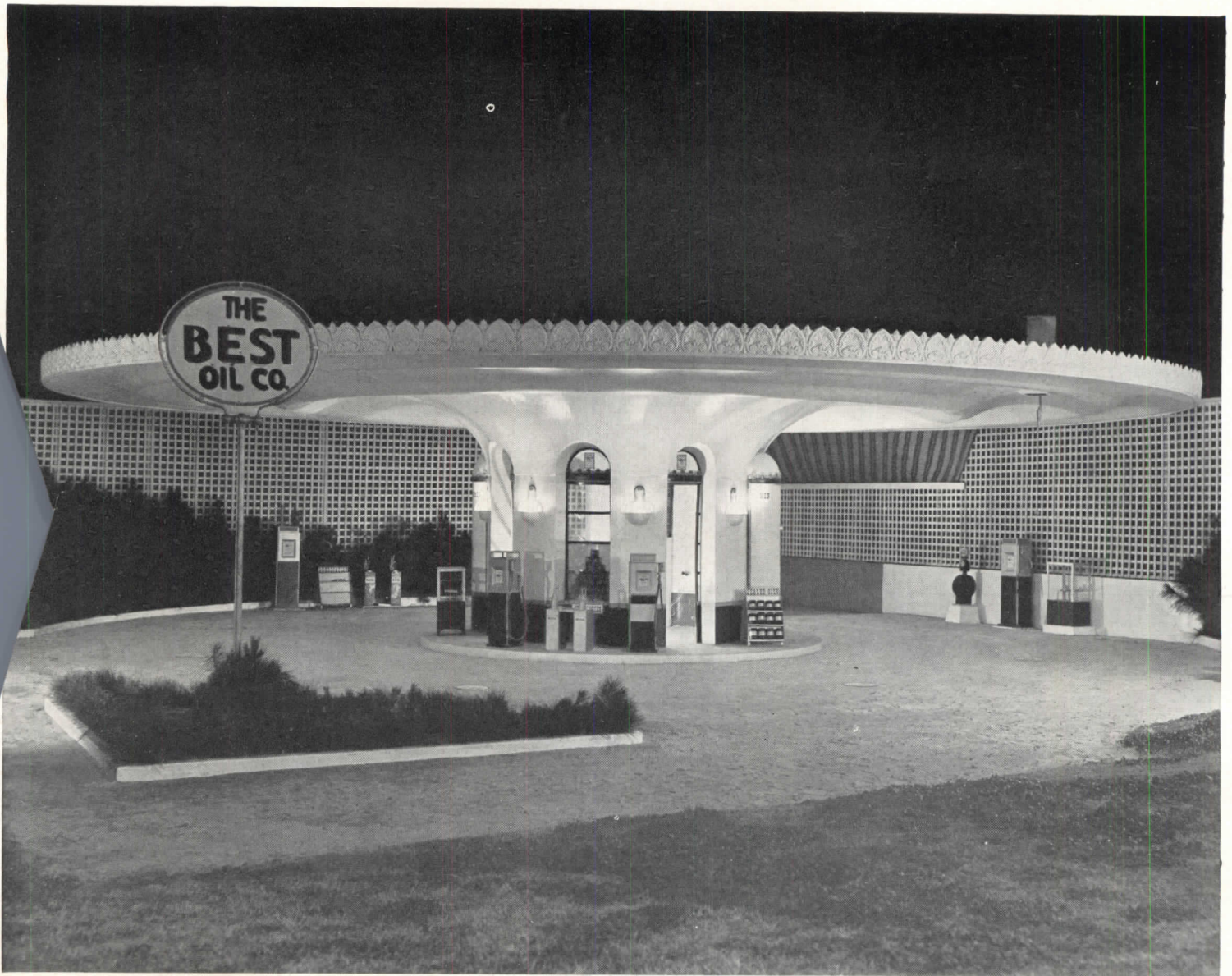

When inverted, this new building form corresponds closely to the splash and ripple of a raindrop hitting the water. Its design springs from the fact that, "as the energy of the drop's impact is diffused radially over the surface of the pool, the velocity of the moving particles changes the form of the placid surface of the water, and in so doing,

individual globules of water moving one against the other trace a *line of compressive force*; yet in moving outward from the center of disturbance, these individual globules recede from each other and, in so pulling apart, determine the *location of tensile stress*." From these two actions Mr. Workman evolved his design.

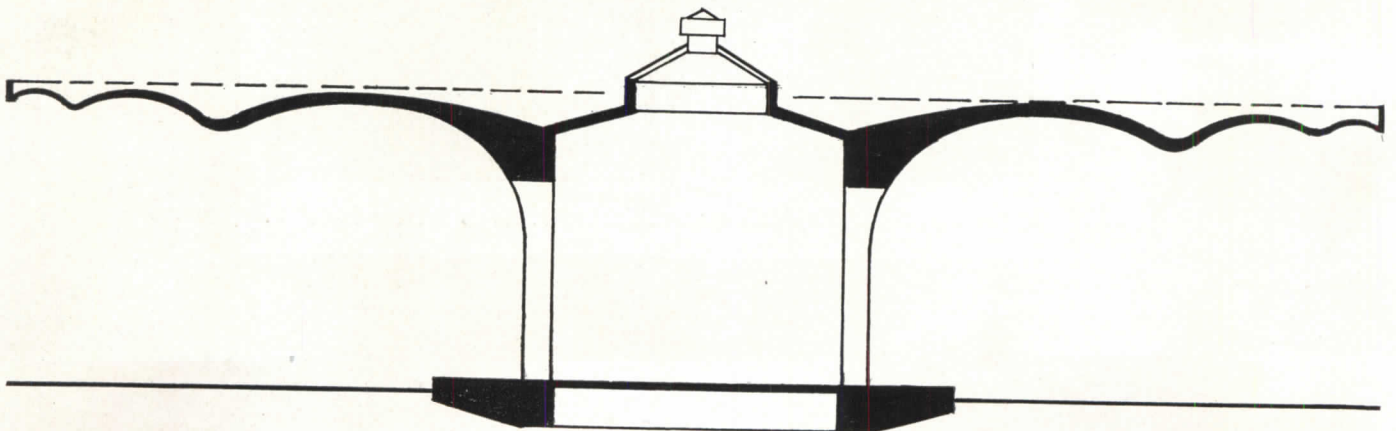

This 40-ft. plate—only 2" thick at the edge, with an average thickness of 3½" and an unsupported projection of 15'-0"—is designed to carry a load of 40 lbs. per sq. ft.

(approximate weight of sand and gravel insulation fill which tops it). It has in addition sustained a 6-in. snowfall and a maximum wind of 70 mph.

# SOUTHERN ARCHITECT STUDIES NATURE TO EVOLVE NEW FORM

JAMES MINOR WORKMAN

Architect

THE RIPPLE OF A RAINDROP in a fishpond provided the basic pattern on which design of this filling station in Winnsboro, S. C. was evolved. End result of several years of research into reinforced concrete construction—a period during which Mr. Workman analyzed the stress organization of such natural forms as morning glories and petunias—the filling station was preceded by a number of test structures employing the same structural system. (See tank test, p. 49.) Superficially resembling the now famous "morning glory" column of Frank Lloyd Wright (AR, 7/37, p. 38), the Workman system actually differs quite radically in the basic principles involved.

Strength of the Workman system lies in the fact that the stresses react upon each other with such fine compensation that a minimum stress is produced which does not become totally cumulative, and the compression in the concrete is "more nearly a direct compression than it is possible to provide with any other system of construction." Says Mr. Workman: "It is simpler to comprehend the character of these stresses by understanding what they are not. In this plate there is no semblance of cantilever action, there is no appreciable moment action, and there is no arch action; but in place of these familiar stresses there is a beautiful organization of curve-line compression and tension with no straight-line stress in the entire slab plate structure."

In the filling station itself, built by Mr. Workman as an illustration of the commercial applicability of his system, practically all equipment has been incorporated in the structural shell. Thus the pump mechanism is above headroom in the accessory store, so that standard pump equipment of the wet-nozzle control type simply has a length of insulated pipe together with an electrically operated hose reel (also insulated) interposed between the pump and the nozzle. Similarly, the washrooms for men and women on either side (4' x 5') are of prefabricated insulated metal arranged to slip directly into place. Illumination is all indirect.

[In a forthcoming issue of ARCHITECTURAL RECORD Mr. Workman will describe his new "rotational" system—its origin, its characteristics, its application.—Ed.]

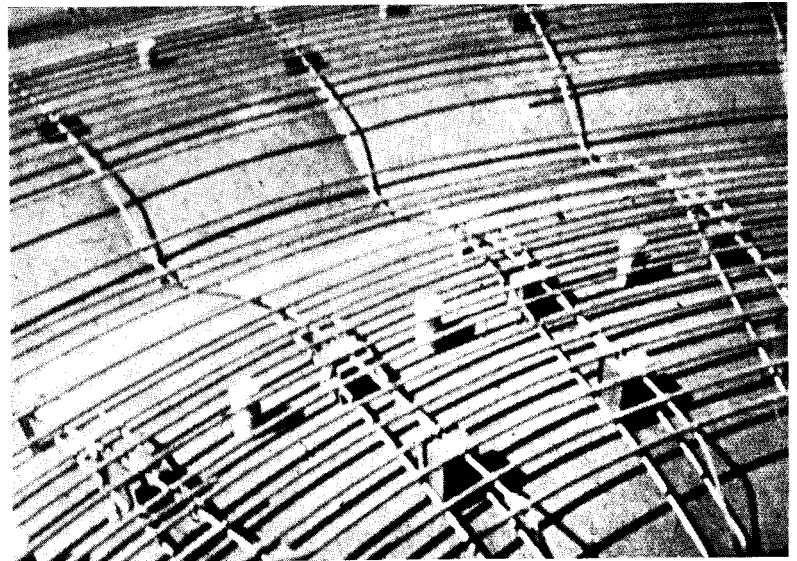

Reinforcing of horizontal plate

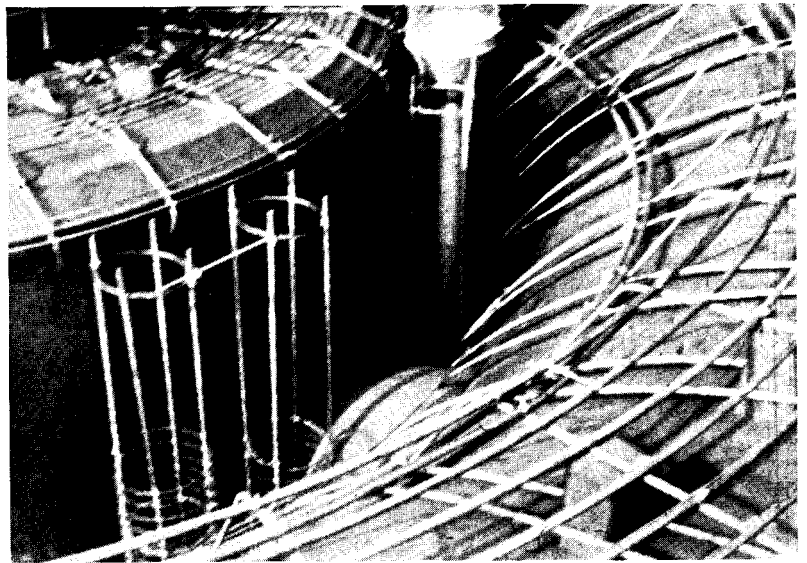

Reinforcing at "throat" of column

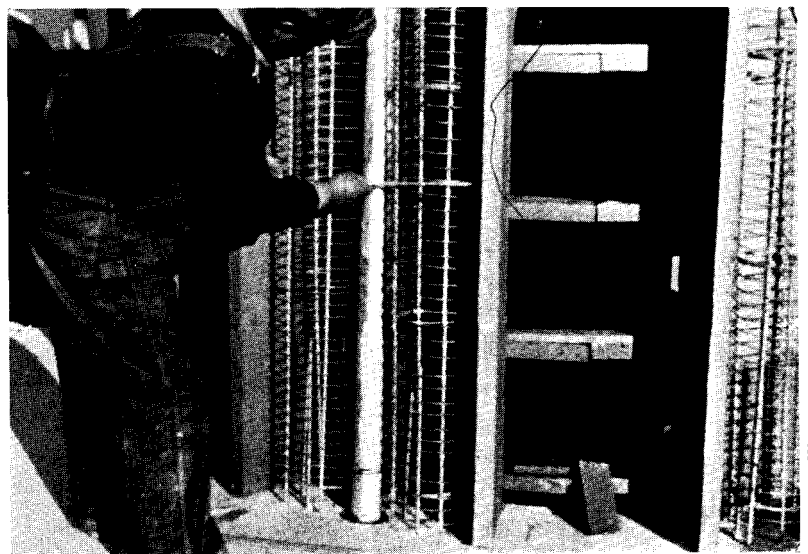

Reinforcing of vertical shaft

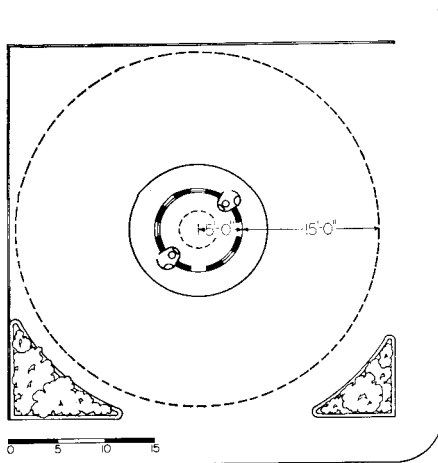

Plan

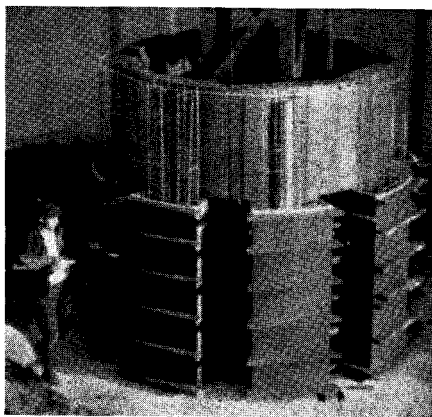
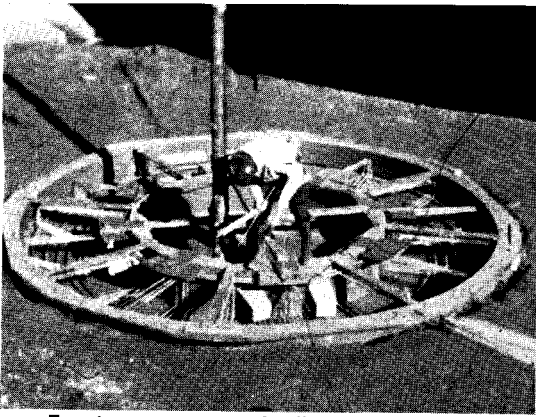

**1** Footings are poured, allowed to set and . . . **2** forms are hoisted into place . . . **3** by the derrick which tops the tower.

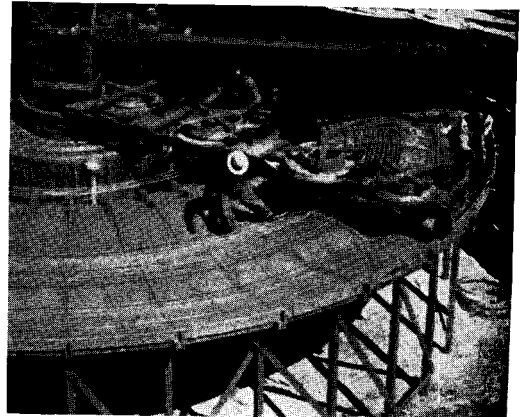
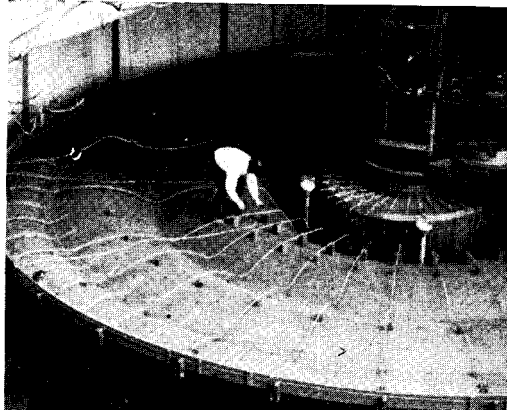

**4** Forms in place, reinforcing begins . . . **5** with pre-crimped radial steel; then . . . **6** concentric reinforcing is threaded off.

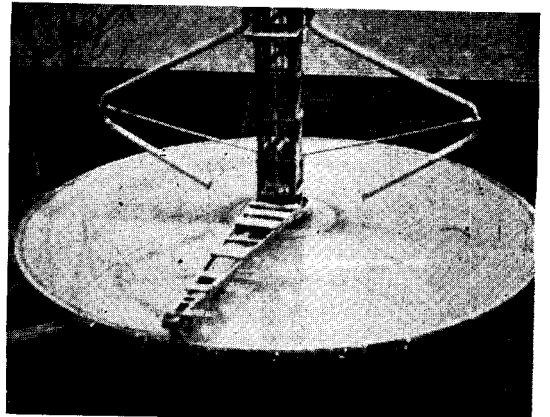
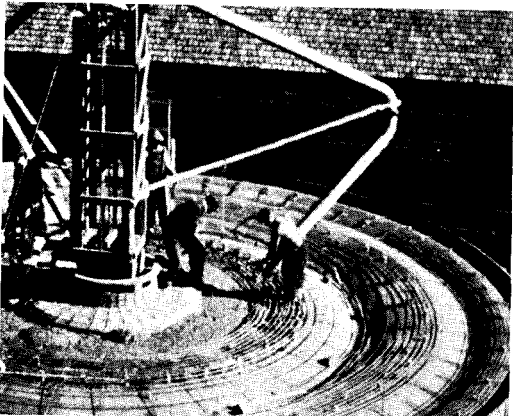

**7** Pouring begins; speed is guaranteed by . . . **8** the rotating, rubber hose and . . . **9** rotating screed gets an accurate profile.

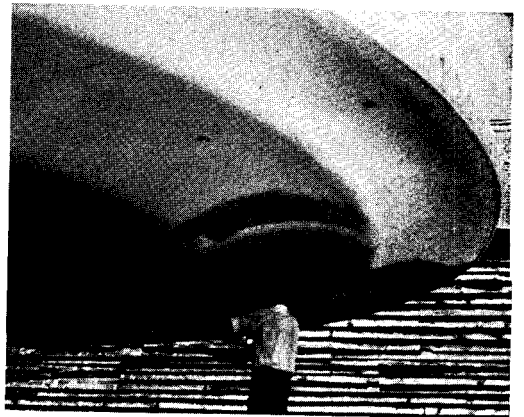
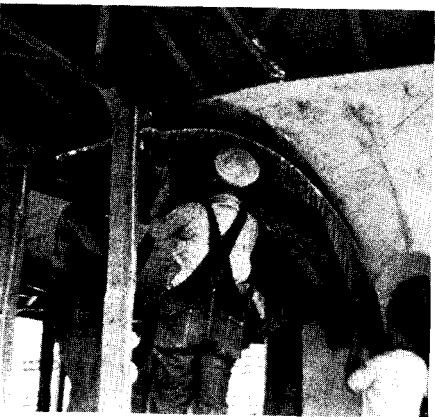

**10** Then formwork is removed . . . **11** top surface waterproofed . . . **12** and the underside spray-painted.

## WORKMAN FILLING STATION

Like an increasing number of new developments in building, Mr. Workman's *structural system* can scarcely be isolated from its *method of construction*; in other words, as in industrial techniques generally, his *process modifies his product*, and vice versa. As indicated by the construction record on the facing page, he had to design not only a system (circular plate and column) but a method of erecting it (formwork, scaffolding, screeds); moreover, precision design of the one implied precision control of the other. His complex formwork was a design problem in itself; his reinforcing steel had to be placed with unusual accuracy; his concrete supply had to be equally available over a large area; screeding had to be done mechanically to achieve the correct profile for the plate.

These factors, plus the fact that he desired to demonstrate the applicability of the system to large-scale industrial construction, demanded the maximum rationalization of the construction process. Thus the first step (after footings were complete) was to erect a construction tower in the center of the structure. By equipping this tower with a rotating derrick, he was able to handle his formwork with a minimum of time and effort (3 and 4 on opposite page). Next was added a rotating arm, which served the double purpose of threading the spools and reinforcing steel at correct intervals (6), and, later, of carrying the screed which gave the upper surface of the plate its correct profile (9). Then came the 5-in. rubber hosing (also pivoted) through which the concrete was pumped (7 and 8). Final task of the tower was to support the circular tent under which all construction took place. (The tent proved impractical in this instance, since the entire construction process was to be filmed.) In demolition, the sequence was reversed, the derrick being the last equipment to be removed before wrecking the tower proper.

In the case of this particular building, it was not practical to keep cost records on labor because construction of the building under the moving picture camera necessitated working very irregular hours, requiring the tent to be opened up and closed each day. However, the cost of all of the concrete and reinforcing materials was less than \$700. Actual guaranteed bids, based upon union labor wages and conditions prevailing in Washington, D. C., showed the cost for complete stations, including electric wiring and fixtures, plumbing and fixtures, doors and windows, and all painting and roof insulation—in fact, complete stations except for ground paving and gasoline tanks and pumps—would be \$5,000 for a 50-ft. diameter station with 15-ft. diameter office; \$7,500 for a 60-ft. diameter station with 15-ft. diameter office; \$10,000 for an 80-ft. diameter station with 20-ft. diameter office. These figures include a prorata cost of re-usable forms, the number of re-uses depending upon whether the forms are constructed of wood or steel.

The actual time of construction of this building does not afford a satisfactory forecast of normal conditions. However, time studies made of the different operations, indicate "that a commercial station could readily be constructed in less than ten days after the foundation and underground pipe work is completed." (The workmen on the job expressed the opinion that, under commercial conditions, they could erect forms on Monday; place reinforcement Tuesday; pour concrete Wednesday.)

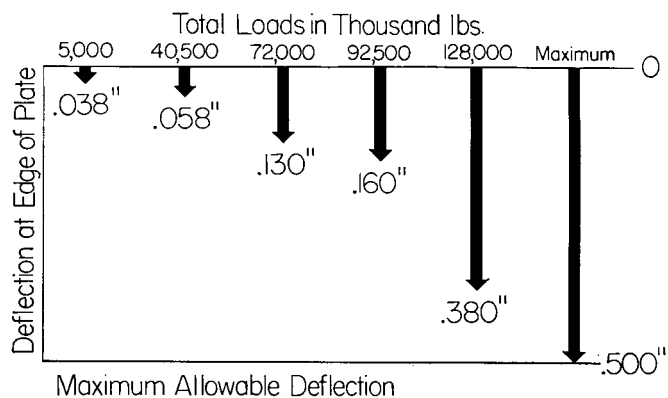
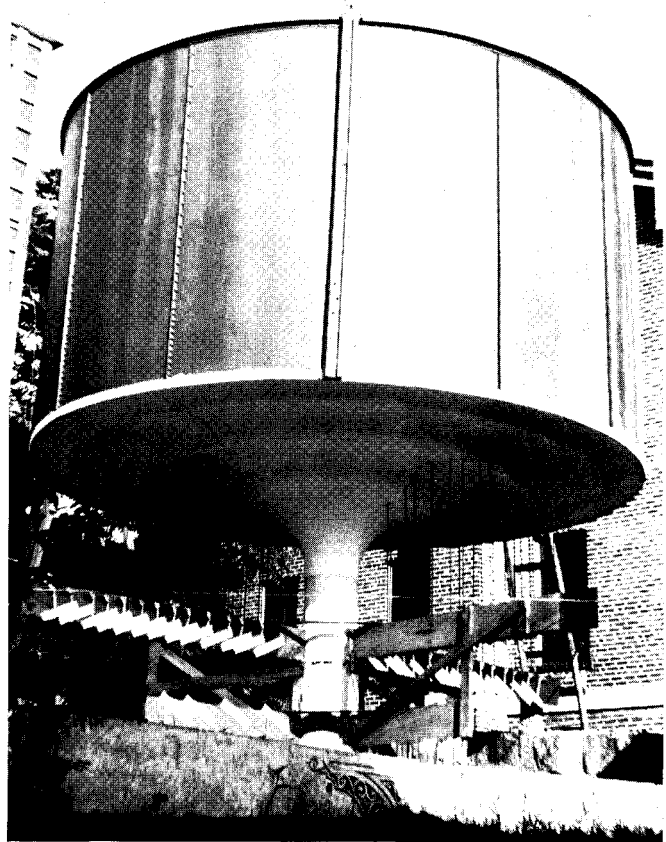

### Tank tests show system's strength

The strength of Mr. Workman's system can best be judged by his series of water load tests on a similar plate (above). This plate—18' in diameter, 2½" thick at the edge, averaging only 4" thickness and supported by a hollow 18" column with 5½" walls—was subjected to a maximum load of 505 lbs. per sq. ft. without showing any failure, without reaching the maximum allowable deflection (1/360 of the span) and despite the fact that yield point in the tensile (radial) reinforcement had been passed. Although other distributions of loads were tried (including concentration all on one side), in the water test it was evenly distributed since the tank was merely a cylinder, the plate itself serving as bottom.

According to Mr. Workman: "Test to destruction will be completed sometime in the future, but it may be of interest to note that—notwithstanding thinness of plate—the concrete itself and the compression steel was designed for 1,000 lbs. per sq. ft.; unfortunately, our supply of tension steel was prematurely exhausted and pouring could not wait for more."

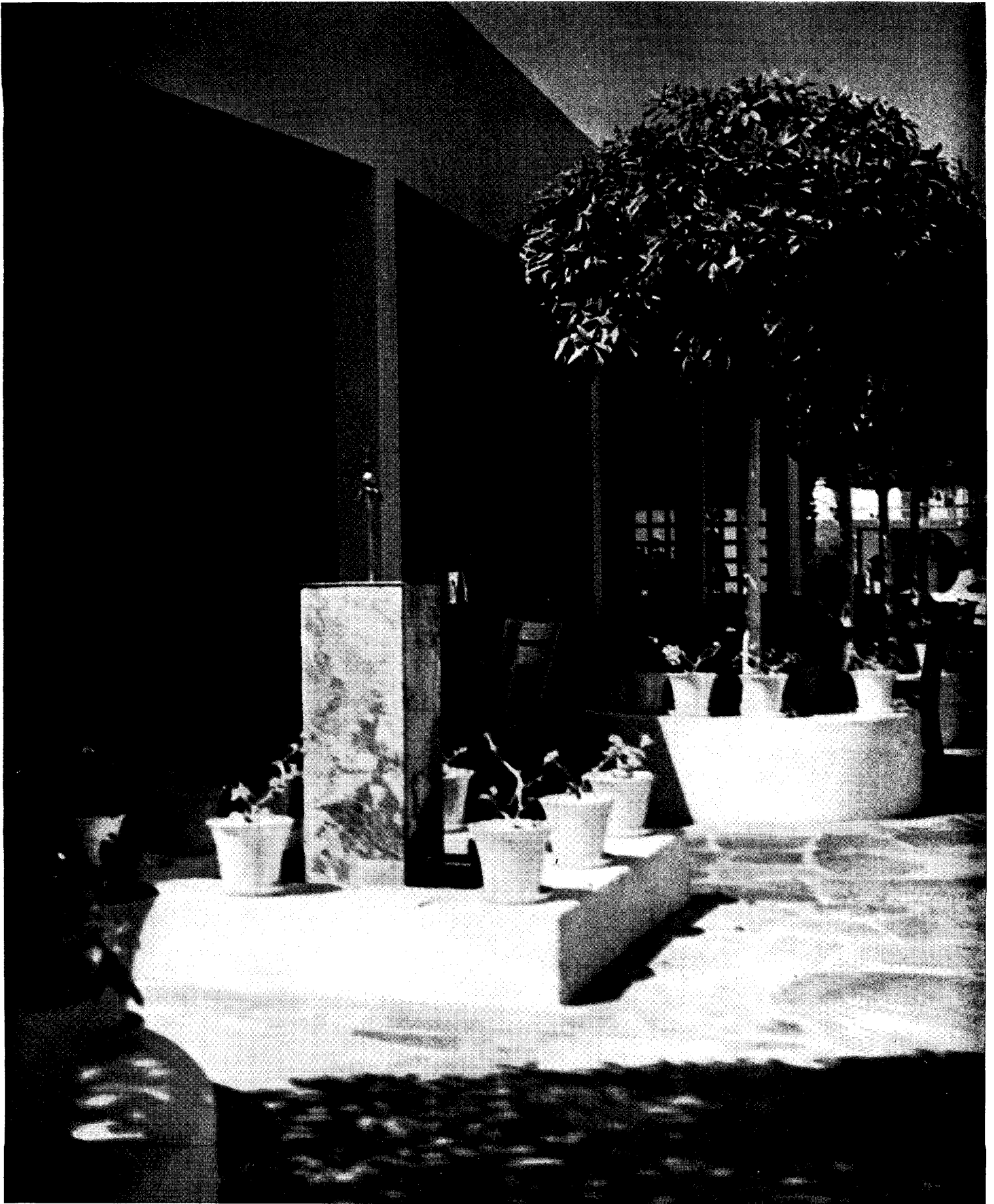

Detail, new Dining Terrace; dining rooms beyond

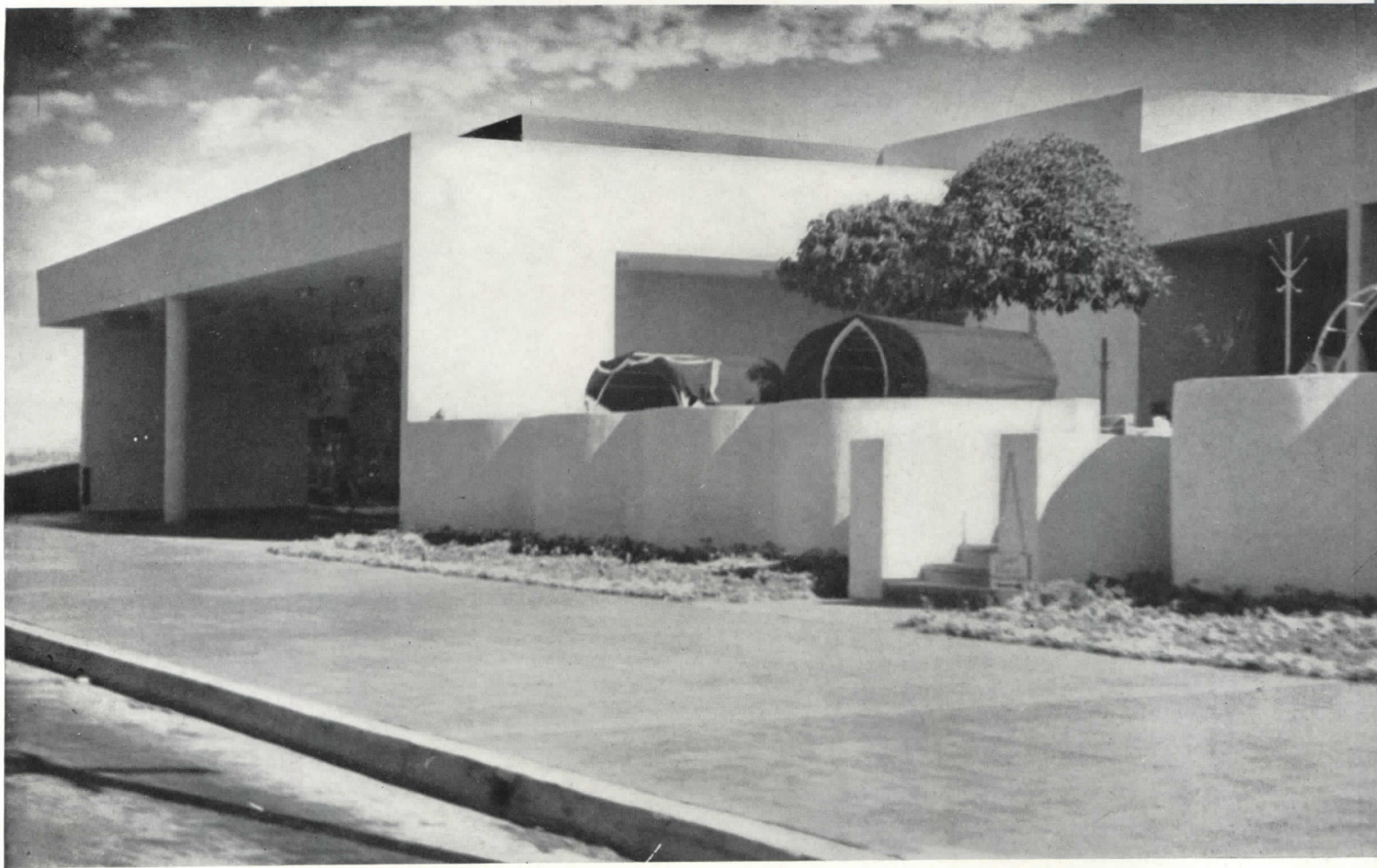

Street Front; recessed entrance at left

## LINDY'S REMODELED CAFE SHIFTS TO "AL FRESCO" DINING

HARBIN F. HUNTER  
Architect

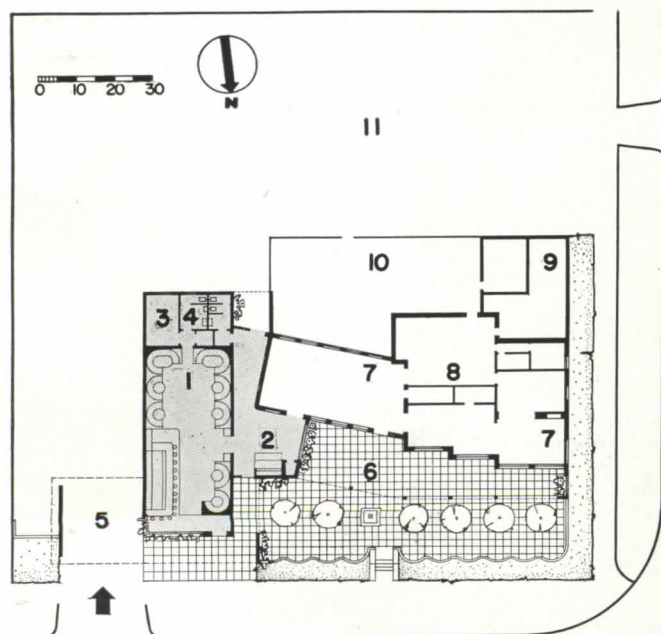

Plan

- |                    |                   |                  |
|--------------------|-------------------|------------------|
| 1. Cocktail Lounge | 4. Toilet Rooms   | 8. Kitchen       |
| 2. Entry           | 5. Porte-cochere  | 9. Storage       |
| 3. Office          | 6. Dining Terrace | 10. Service Yard |
|                    | 7. Dining Rooms   | 11. Parking      |

DESPITE OCCASIONAL spells of "unusual" weather to which even Los Angeles is subject, outdoor dining there is increasingly popular. Thus when an addition to the existing Spanish-type building which housed Lindy's Restaurant was decided upon, arrangements for a large dining terrace were an important part of the plan. This partly covered terrace is sheltered from direct sun by its location on the north side, and protected from the streets by retaining and wing walls. Also included in the new structure are cocktail lounge, entry, office and toilet rooms. (New structural work is shaded in accompanying plan.) In adding the new portion, the entire establishment went through a metamorphosis—the architectural character being changed from neo-Spanish to modern. Circulation in the finished building now pivots around the entry and cashier's booth (2 on plan). Evidence of the automobile's increasing supremacy is the fact that the main entrance to the restaurant is from the porte-cochere. A large lot at the rear provides parking space.

## LINDY'S CAFE



Exterior Corner of Cocktail Bar  
seen from porte-cochere



Exterior walls of the restaurant are of groutlock brick; lintels and beams are of reinforced concrete. The over-all finish is white plaster. Footings and floors are concrete; terrace floor is flagstone. Color comes largely from the wide use of potted plants.





F. S. Warren

## NEW THEATER IN PINEAPPLE LAND DESIGNED FOR AUTOISTS

C. W. DICKEY  
Architect

THAT THE AUTO is exerting the same pressure on building design in far-off Hawaii as elsewhere is clear from the design of Honolulu's new Waikiki Theater. Situated on an important boulevard four miles from the downtown district and opposite the famous Royal Hawaiian Hotel, the Waikiki is designed to attract motorists from afar and provide for their cars after they get there. Thus the entire building, with its towering central sign, is illuminated; it is surrounded by the open space of its own gardens and parking lots; and its actual entrances and lighted marquees have been relatively subordinated (see next page). The structure cost \$150,000.



Front Elevation

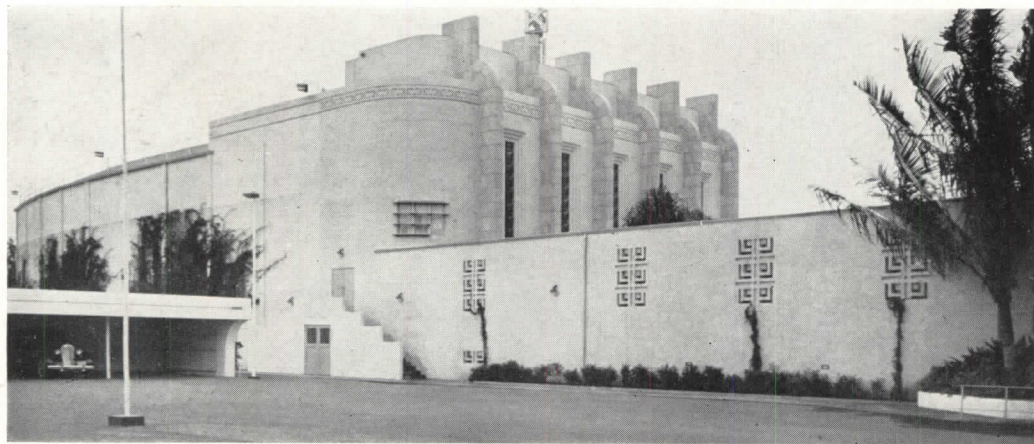

Side Elevation from parking lot

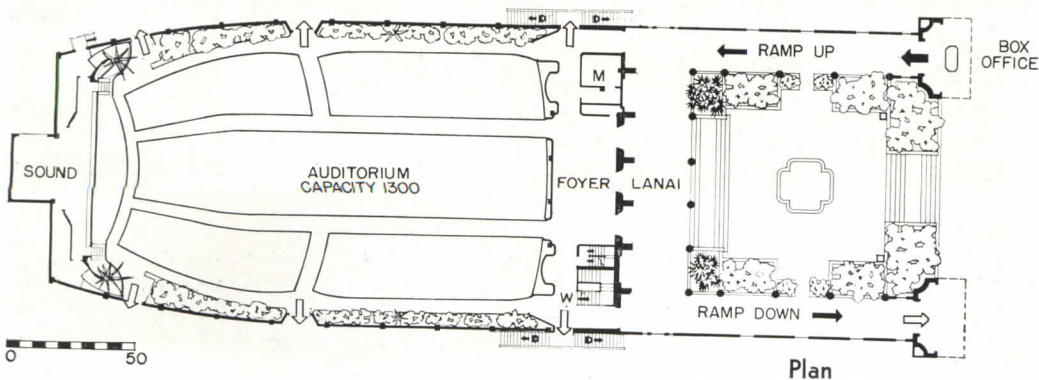

Climate, custom and zoning regulations led to an unusual plan; instead of the typical central entrance crammed against the building line, the Waikiki's auditorium lies behind a large landscaped court which is flanked by entrance and exit ramps leading directly to the foyer. Novel, too, are the parking lots which flank the theater (left, center) with exits directly from the theater. The theater proper resembles the typical movie palace, except that in this instance seating is of the stadium type, all on one floor. Elaborate smoking and rest rooms underlie the foyer and lanai at basement level.

# WAIKIKI THEATER



The Court (above) and the Lanai (below)



The use of landscaped open areas suggests potentialities in commercial theater design not necessarily limited to the tropics. Here native plants are used to good effect; even the side and rear walls of the auditorium have treillage for vines (see facing page). Walls are of off-white stucco; pavements of court, ramps and lanai are of concrete chemically stained dark-green.

# WAIKIKI THEATER

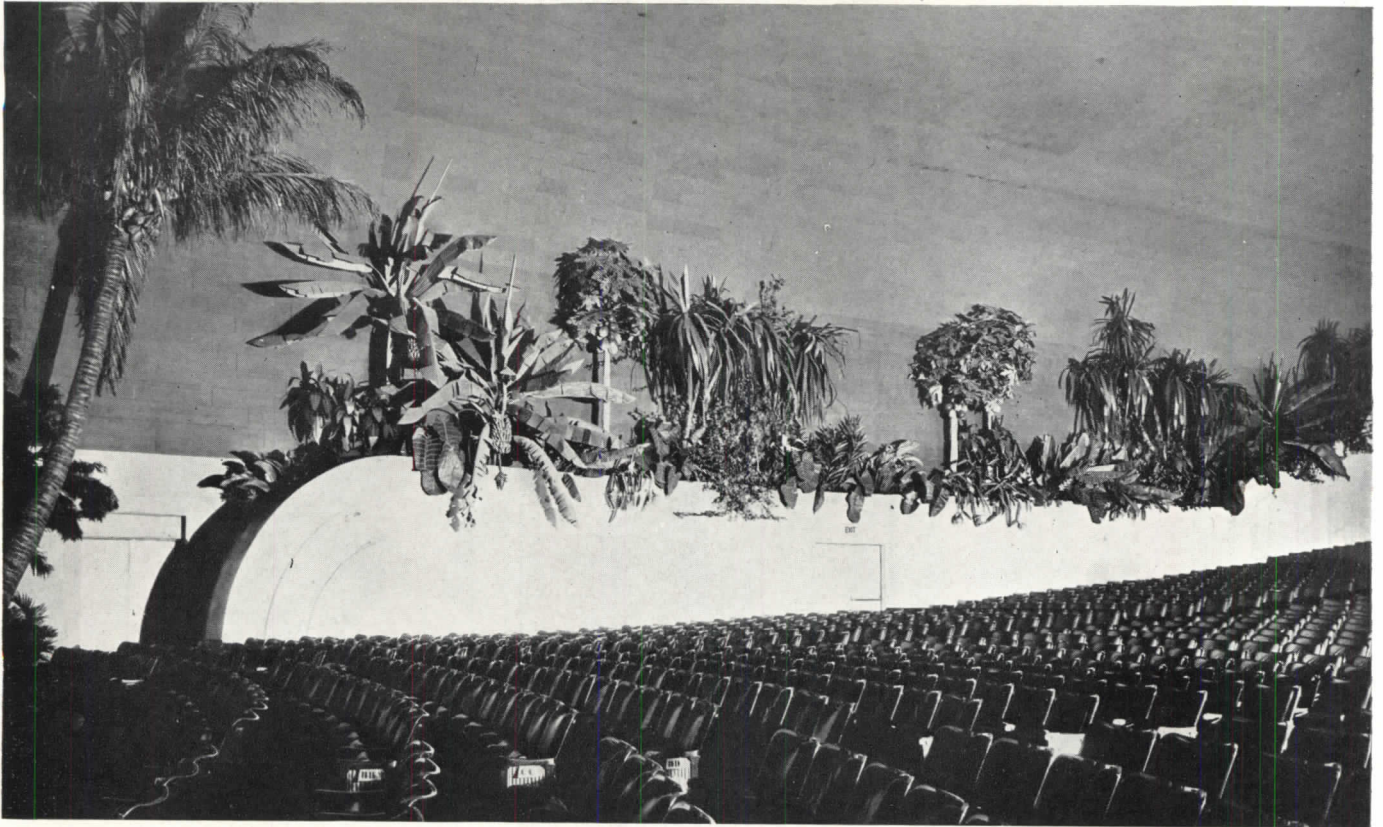

Photos by F. S. Warren

Interior

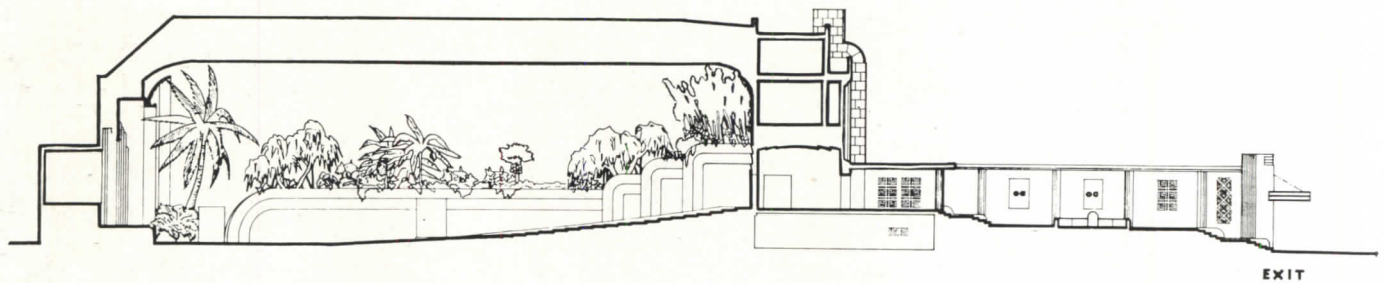

Section

EXIT

Like other so-called "atmospheric" theaters, the Waikiki's ceiling is painted deep blue for sky effect. The "garden walls" are cream-colored and the foliage—Hawaiian-made reproductions of native flora—is in natural colors. Walls and ceiling are of a locally made acoustic plaster, Valdastri Acousti-pulp, and rear wall is of Acousti-Celotex. The proscenium arch is independent of the auditorium walls, serving as amplifier for the screen. It is provided with cove lighting for various color effects. The reveal between proscenium and screen can likewise be played up with colored lights. Projection booth and air-conditioning equipment room are situated above the foyer; sound equipment is behind the screen.



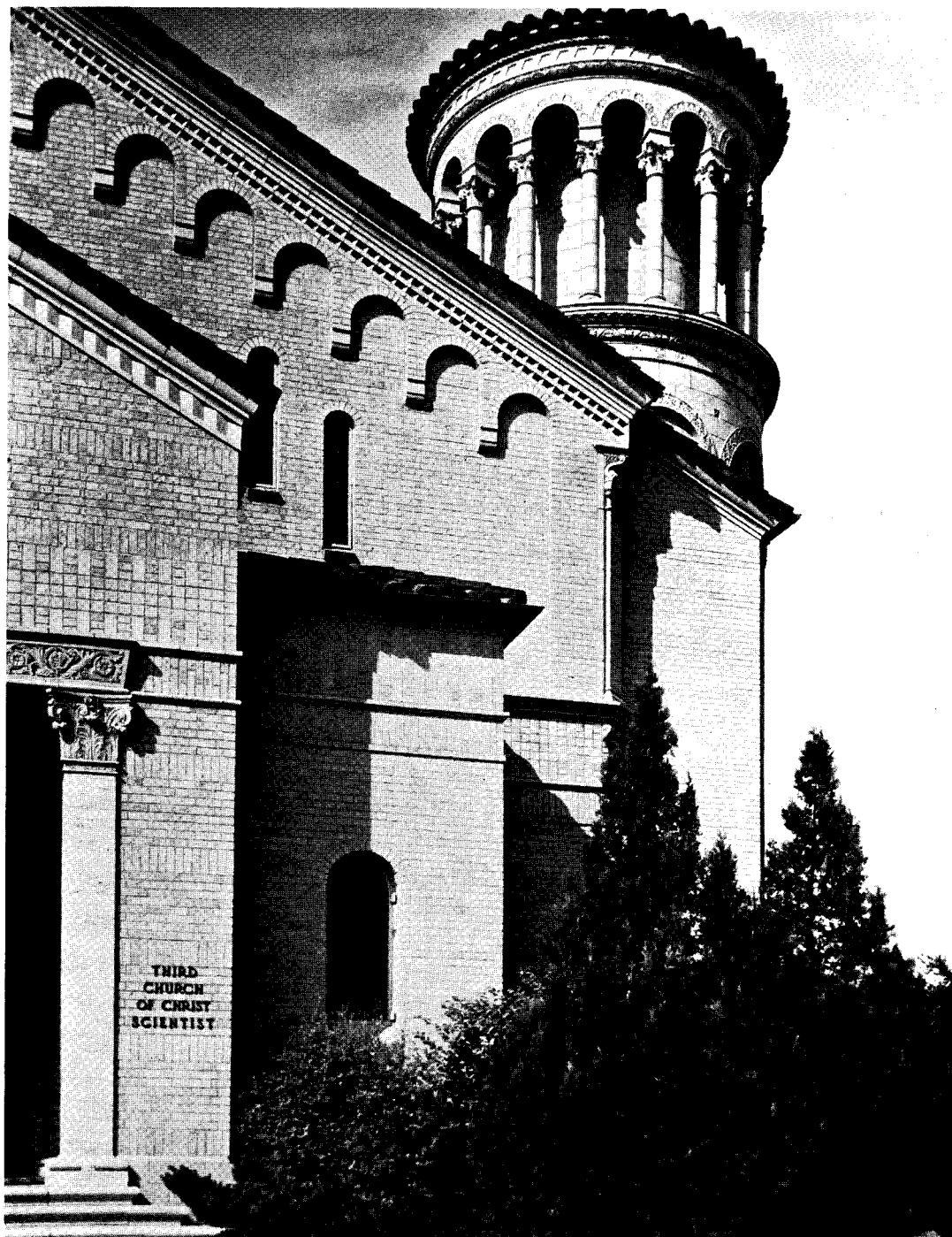

*Photos by Archiphoto Co.*

MARK LEMMON  
Architect

## CHRISTIAN SCIENTISTS USE ROMANESQUE

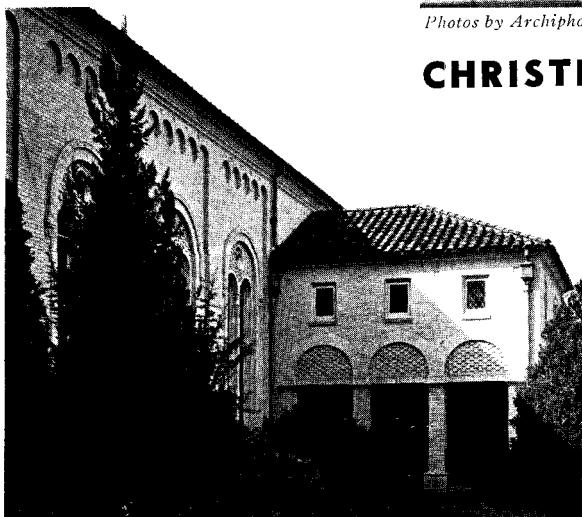

THE ROMANESQUE architecture of the Third Church of Christ Scientist in Dallas, Texas, is a unique departure from the traditional colonial and classic styles of other churches of that creed. Selling this style to the congregation was no easy job, Mr. Lemmon comments, because the plans called for north and south aisles and a level auditorium floor—unheard-of innovations in a Christian Science church. Reaction, however, proved favorable to the completed building. The exterior walls are of face brick with a common brick backing. Ornamental cornices and trim are of terra cotta. Total cost of the building was \$165,000.

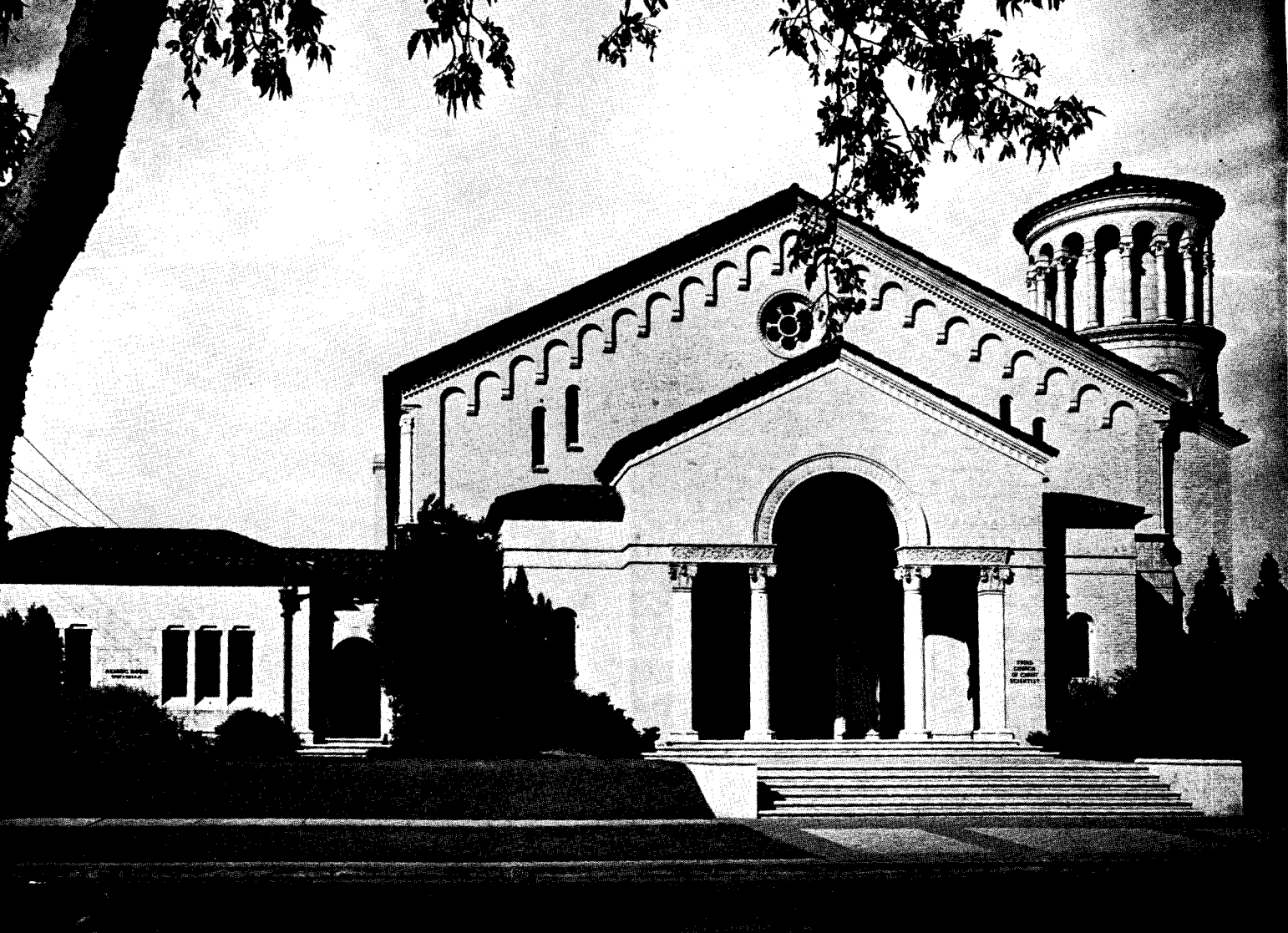

Front Elevation

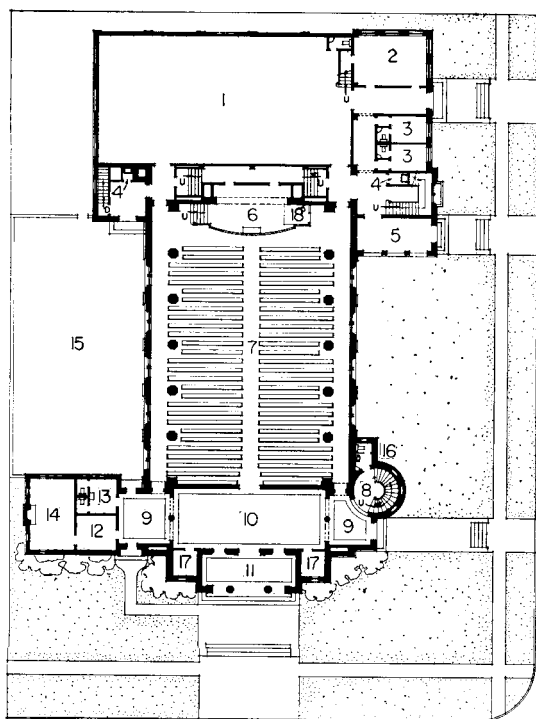

First Floor

1. Sunday School
2. Literature
3. Reader
4. Janitor
5. Porch
6. Platform
7. Auditorium
8. Stair Tower
9. Vestibule
10. Foyer
11. Loggia
12. Salesroom
13. Women
14. Reading Room
15. Garden
16. Men
17. Checkroom

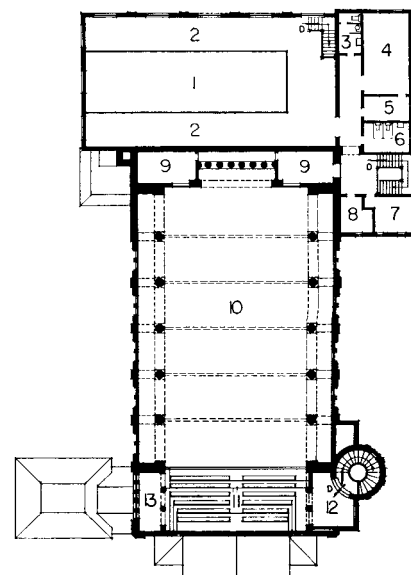

Second Floor

- |                  |                   |
|------------------|-------------------|
| 1. Sunday School | 7. Soloist        |
| 2. Balcony       | 8. Organist       |
| 3. Men           | 9. Organ          |
| 4. Board Room    | 10. Auditorium    |
| 5. Office        | 11. Balcony Seats |
| 6. Women         | 12. Vestibule     |
|                  | 13. Alcove        |

## DALLAS CHURCH

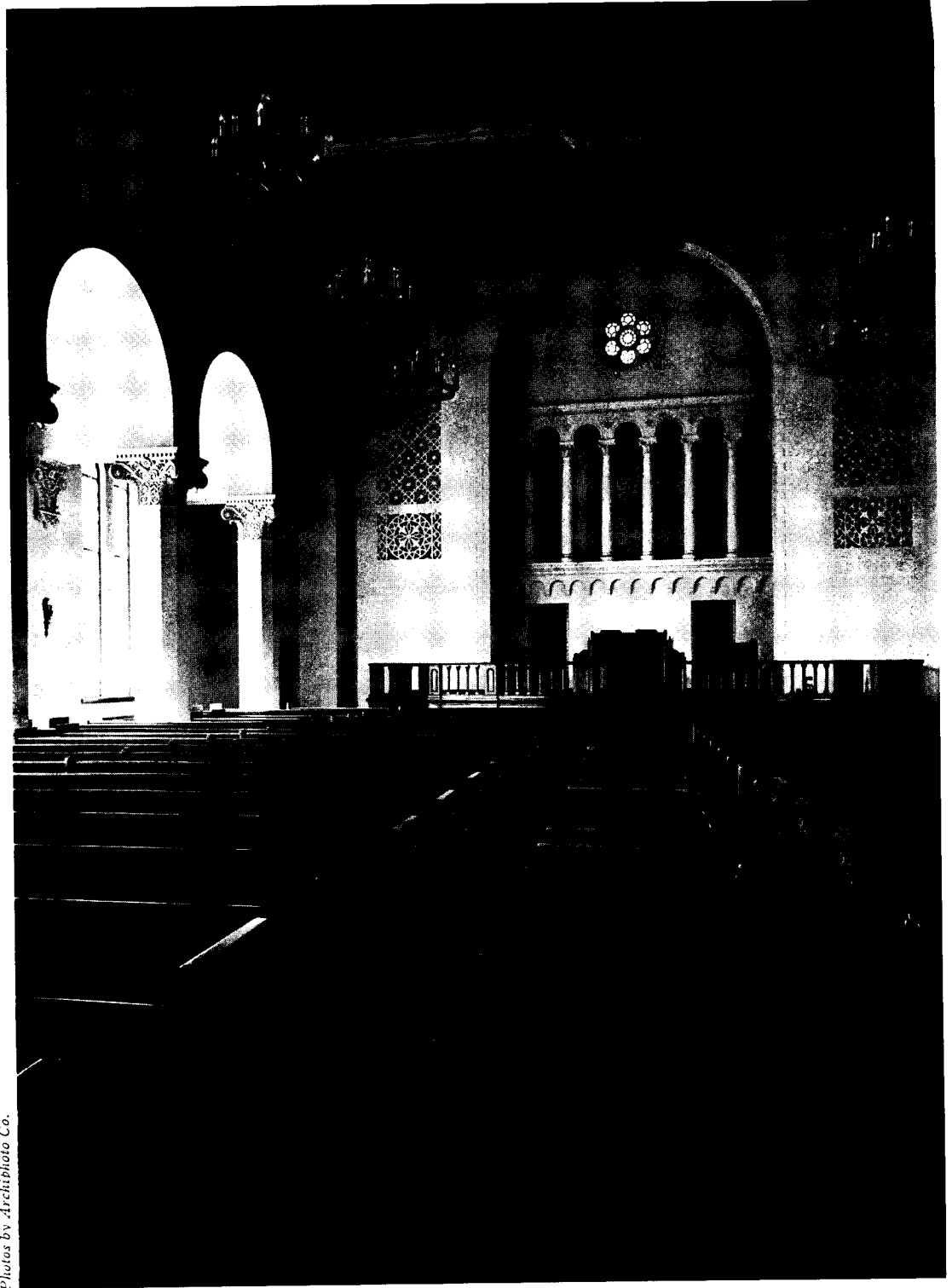

Photos by Archibphoto Co.

Auditorium

In the planning of Christian Science churches certain definite requirements must be met. Since at services some statements are made from the floor of the auditorium as well as from the reader's desk, the acoustics must be perfect. The reader's desk must be visible from any point in the auditorium; furthermore, it is desirable that every seat be visible from every other seat. Where the seating requirements necessitate a balcony, as in the Dallas church, such an arrangement is, of course, not possible; but in this case the majority of the congregation are seated on the first floor. Between auditorium

and Sunday School room, sound insulation had to be provided, as frequently both services are held at the same hour. For the same reason there had to be a separate entrance to the school section of the building. A special entrance to readers' offices was also required. The climate of Dallas is, for the greater part of the year, dry and warm; hence free circulation of air is imperative where no provisions for mechanical ventilation are made. The tall windows by which this is accomplished also fulfill another requirement—ample light to make artificial light unnecessary during the day.

# DALLAS CHURCH



Photos by Archibhato Co.

First Floor Vestibule and (below) Stair Tower



Foyer and vestibules are plain except for the coffered ceiling of decorated concrete, and the color derived from the Faience tile floors. At one end of the foyer is a literature salesroom and, beyond, a reading room; at the opposite end is the stair tower, which leads to the balcony vestibule. The main entrance to the auditorium opens off the foyer; minor entrances to side aisles open off vestibules at either end of the foyer. Auditorium floors are oak, except in the aisles, where they are carpeted; between the decorated wood trusses the ceiling is treated with acoustic tile, also decorated.





Fireplace End, Crane Memorial Room

## MUSEUM MAKES USE OF UNUSED LIGHT COURT

MORRIS AND O'CONNOR  
Architects

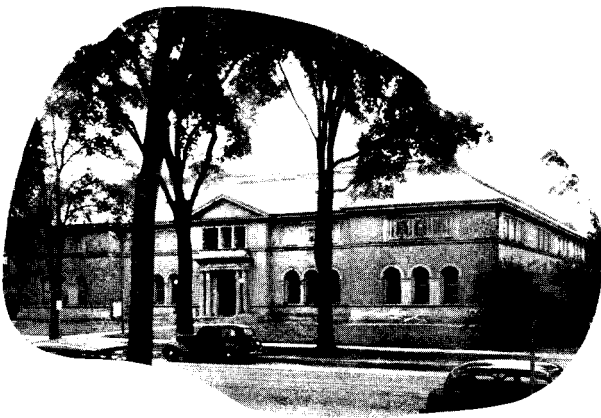

ADDITIONS to existing buildings are not always so successfully handled as in the case of the Ellen Crane Memorial at the Berkshire Museum. Without compromising the gray brick Italian Renaissance exterior (designed in 1902 by Harding and Seaver) the architects for the alterations made use of an open central court to erect, as a corporate part of the building, a two-story structure housing an auditorium and exhibition room. Only outside evidence of the change is the exhibition room's skylight, which is just visible in the photograph at left.



SECOND FLOOR: Memorial Room for Exhibitions

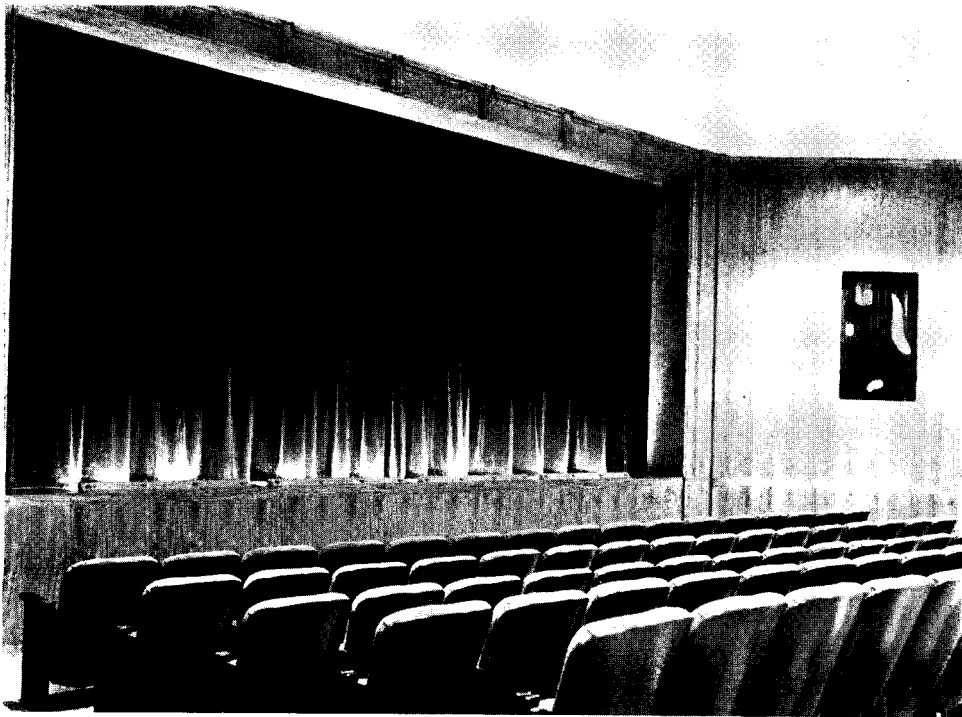

FIRST FLOOR: Auditorium

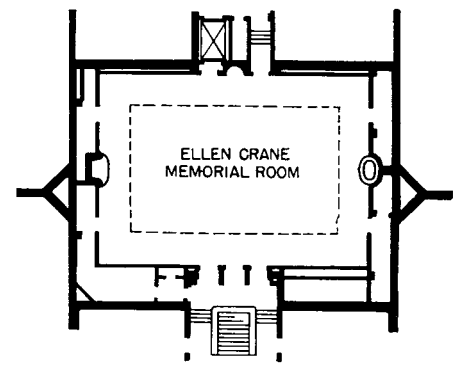

Second Floor

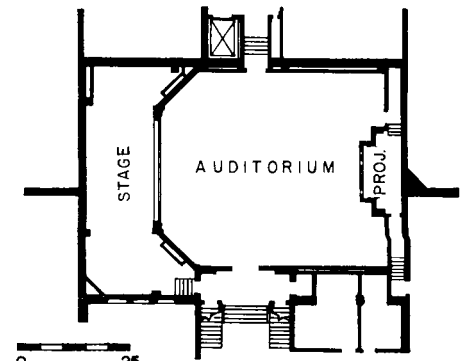

First Floor

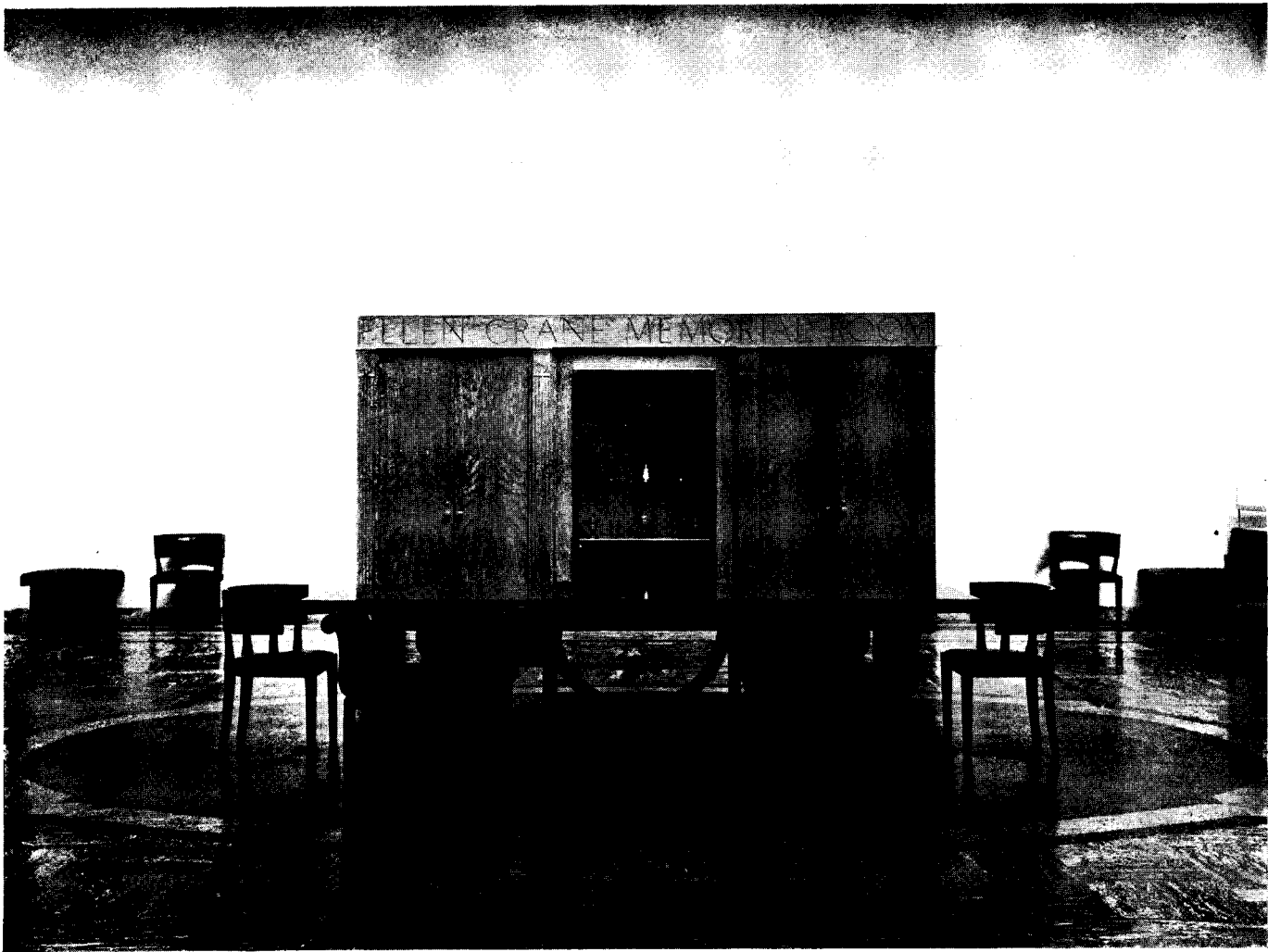

Memorial Room seen from entrance

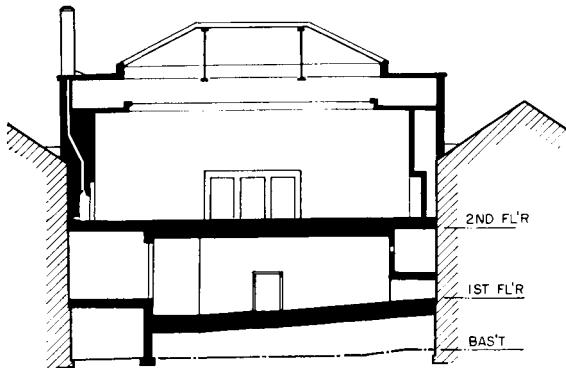

Section

Necessary height for the auditorium was obtained by raising the Memorial Room above second-floor level and lowering the auditorium below ground-floor level. A new double-run stairway, installed to make this possible, placed the auditorium on the building's central axis, and added dignity to the Memorial Room approach. Opposite the triple opening to the room is a similar motif incorporating a secondary exit to other galleries, a niche for exhibits, and the door to the freight elevator which facilitates transport of objects from basement receiving room.

Extreme simplicity proved the best solution for a room which is required to serve as a background for changing exhibits, and also as a pleasant and restful room when no special exhibition is in progress. Much of its effect derives from the proportions of the room itself—40' x 60' in area, 20' in height—and from the color, texture and materials used in the furnishings. North and south end walls, of waxed English brown oak, are grayish tan in color; side walls are of plaster, painted gray with an undercoating of strong chrome yellow. The furniture, of walnut with henna and green upholstery, was designed by Miss Gheen, Inc. The fireplace is of Swedish green marble. The floor is rubber tile, red-flecked gray, with an oval of maroon bordered by cream gray and verde antique. Ventilights regulate the amount of light admitted by the skylight.

The auditorium (left) is designed to meet all the requirements of the museum's recently amplified educational program. The stage end is paneled in Philippine Paldao, which has a soft pink tone; remaining walls are plaster painted buff-pink. Seats and stage curtain are of peacock-green rep. The "mobiles" on the walls flanking the proscenium act as screens for ventilating ducts. These mobiles revolve as air from the ducts passes them, but may be stopped during performances by a braking device. They were designed by Alexander Calder.

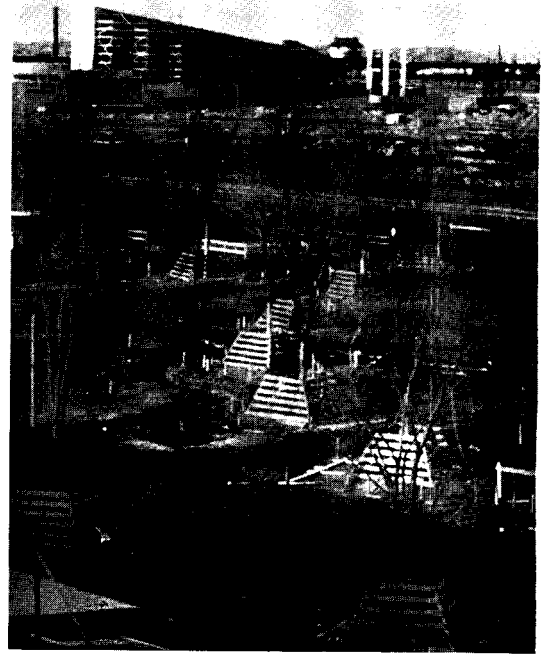

**NEW YORK**

New York World's Fair is rapidly rising. At left is the first section of steel framework for the much-publicized 700-ft. tylon, the Fair's tallest structure. This structure and the adjoining 200-ft. perisphere will form the "Theme Center" of the exposition. Above is a view showing construction on the Textile Building; in the foreground are some of the several thousand trees already transplanted. Behind the Hall of Business Administration (below) rise the pylons of the Communications Building.

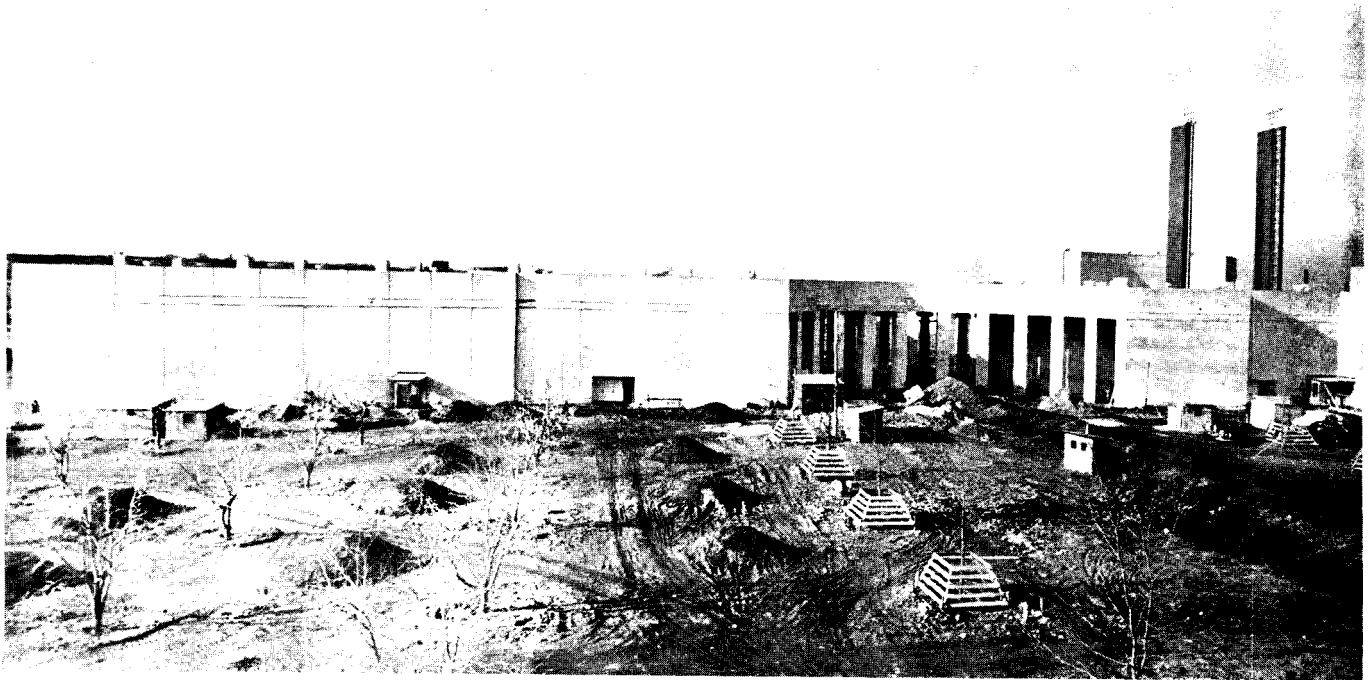

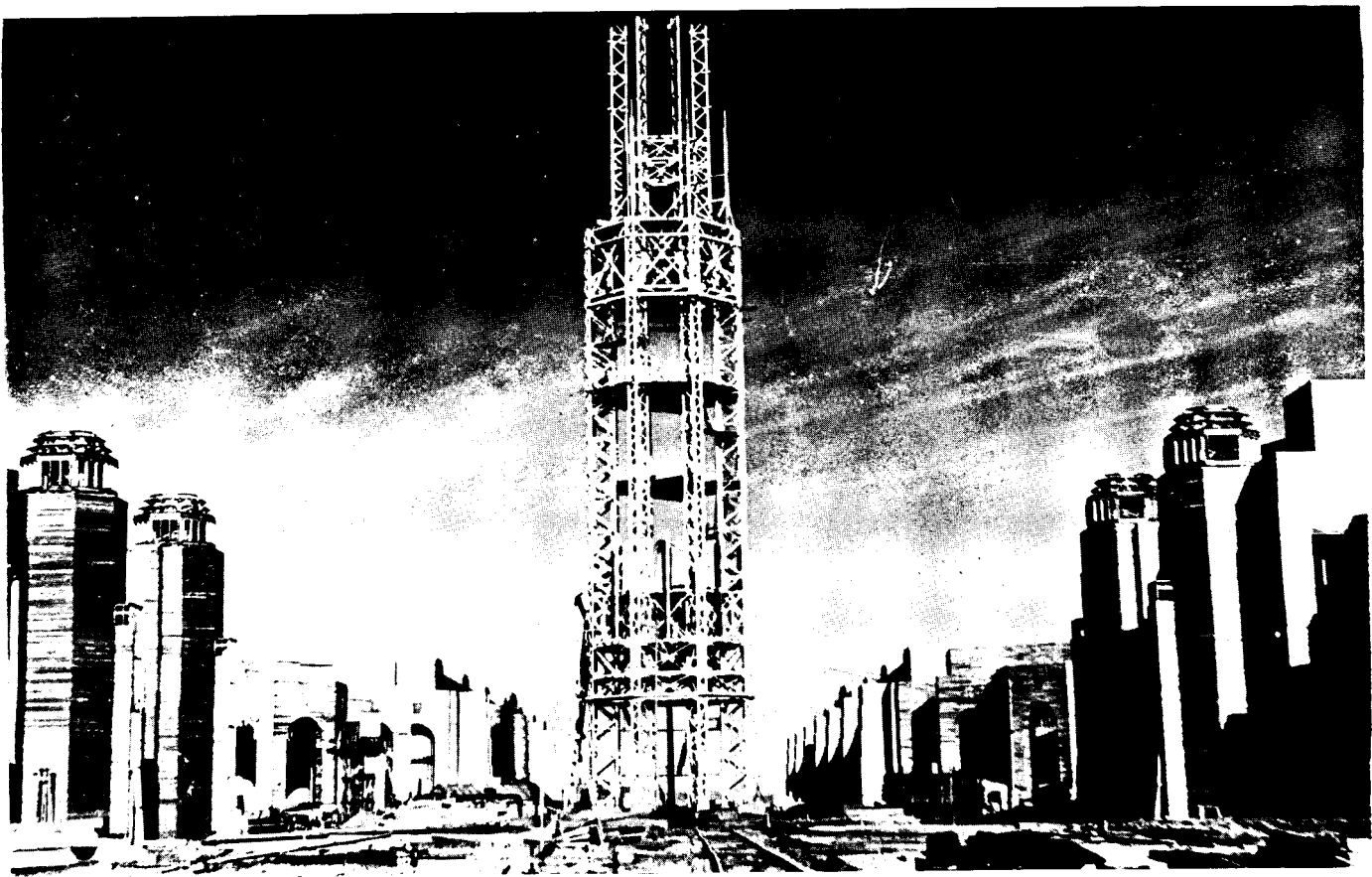

Wide World

## SAN FRANCISCO

Treasure Island, site of the Golden Gate Exposition, has no trylon, but boasts instead a 400-ft. "Tower to the Sun", framework of which is shown above. The Tower stands in the Court of the Moon, flanked on left by the Hall of the Mineral Empire, on right by the Homes and Gardens Building.

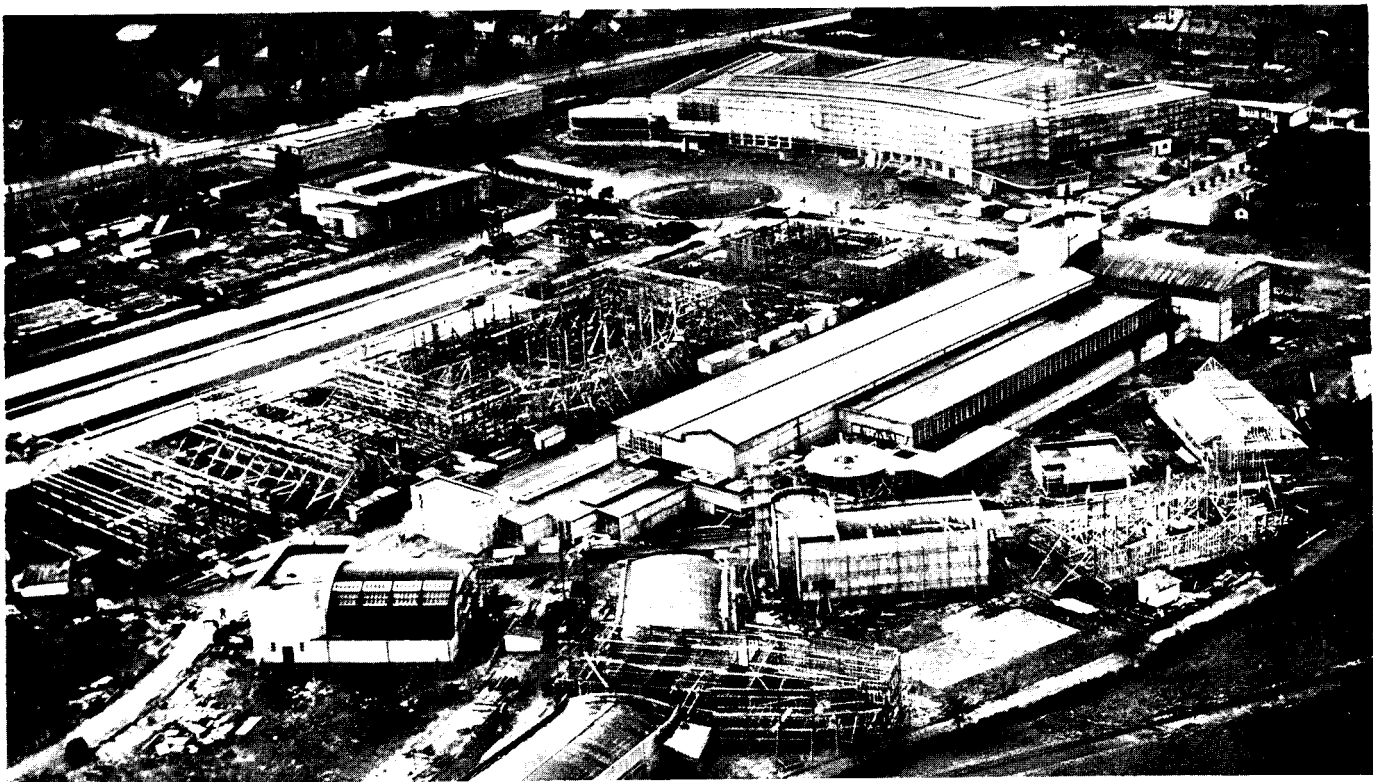

Globe

## GLASGOW

Scotland's Empire Exhibition will open next month. It will include 200 pavilions and kiosks; total cost for buildings and landscaping is expected to reach £10,000,000 or about \$50,000,000.

## PROPOSED BUILDINGS

Photos of Drawings by Ruth Cantliff Russell

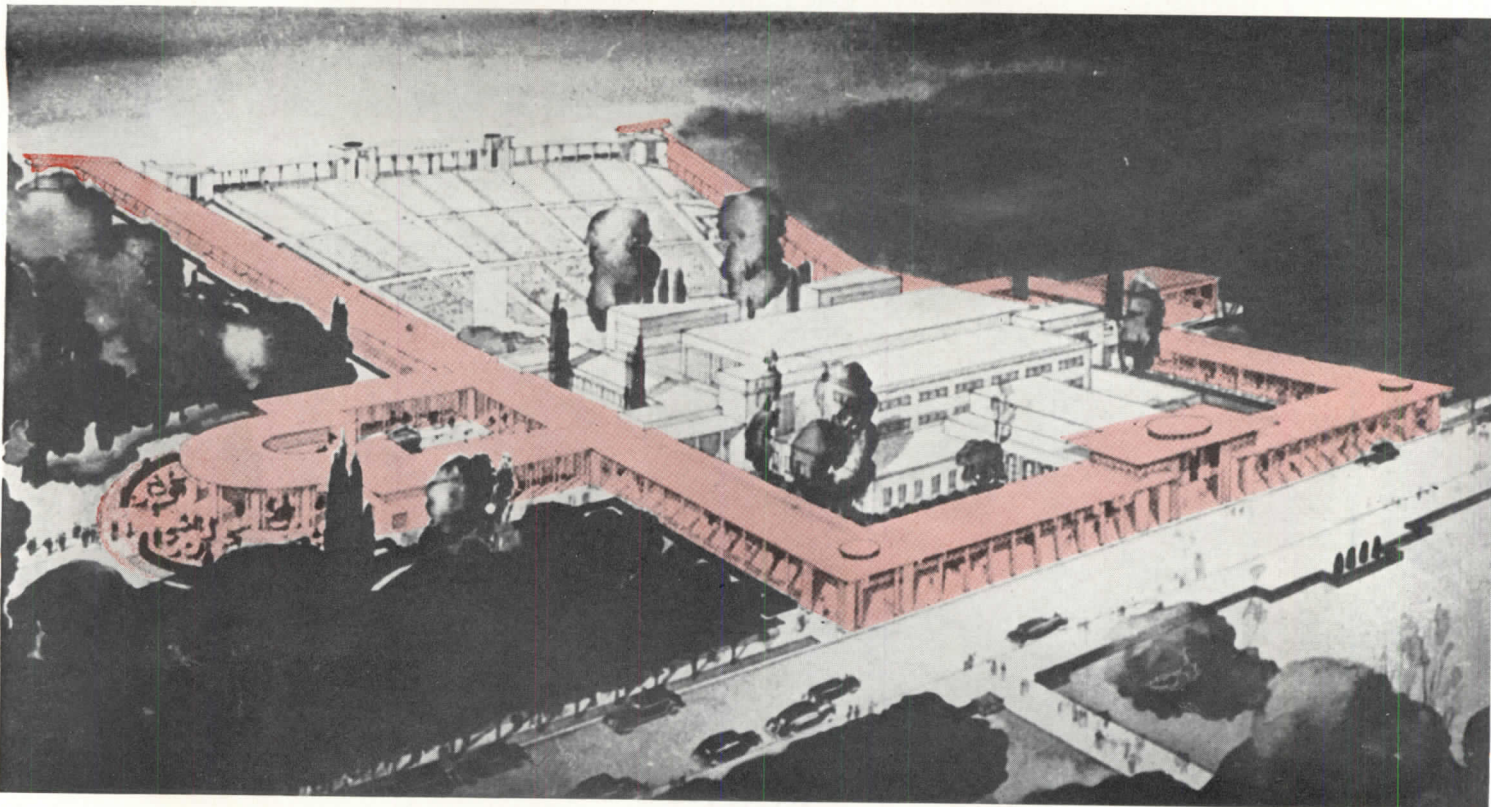

Bird's-eye View of Theater; portion in color is to be immediately constructed.

JOSEPH D. MURPHY and  
KENNETH E. WISCHMEYER  
Architects

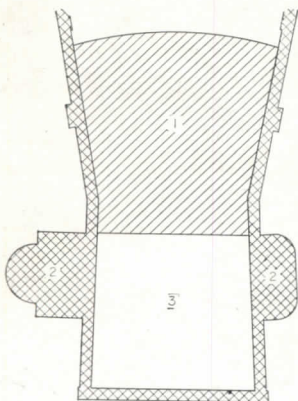

Existing and proposed buildings at St. Louis Municipal Theater are shown above in diagrammatic plan. Present auditorium, stage and proscenium (1) will be kept as part of the permanent structure. To be erected according to the winning design are open shelters and cafes (2) surrounding three sides of the project; last unit (3) will be rehearsal, storage, office and personnel accommodations.

### St. Louis to Build Shelters in 3-Stage Theater Reconstruction

ONE OF THE WORLD'S largest permanent outdoor theatrical enterprises—the St. Louis Municipal Theater—last month completed plans for the second stage of renovating its plant. As a result of a competition run by St. Louis' AIA, Murphy and Wischmeyer were selected as architects for reconstruction of the shelters which enclose the theater. Few are the outdoor theaters which provide adequate shelter for audiences during sudden showers; all the more striking, therefore, is this design, which provides shelter for the theater's capacity audience of 10,000. Existing shelters are capable of accommodating only part of the audience. Thus the competition called not only for larger and permanent shelters, but also for the inclusion of two open-air cafes.

Although the competition actually was aimed at the design of a "substantial and permanent enclosure for the theater and a shelter for the audience in the event of rain", the program included permission to present plans for future development of the production end of the project—dressing, wardrobe, rehearsal and reception rooms, offices, etc. These supplementary buildings were not to be included in the \$100,000 mentioned in the program, which was intended to cover only construction of shelter, cafes, ticket offices, etc., and paving, grading and

piling. Other mandatory requirements were: projection booths at rear and sides of auditorium for stage lighting; a ticket office in the front shelter; service entrance; ticket and telephone booths on each side; and a ticket booth in rear shelter.

Requirements for the design of the shelters were fairly specific. The width had to be such as to cover and project beyond existing pavements. Where shelters acted as an enclosure for the theater, they had to be open on both sides for air circulation; but when used to enclose the area backstage, they could be left open on the outer side and closed on the inner side to provide a barrier to this section. The existing rear shelter is not to be changed at present, but provision for future construction at this point was required on competition drawings.

Located in a natural amphitheater (bottom, facing page), the auditorium "proscenium" and stage with its revolving platform are now in permanent form. The shelters mark the second stage of the reconstruction; eventually the "behind the scenes" portion will be completely and permanently housed. Because the summer open season begins in June, very little construction will take place this year. Only the shelter and the refreshment stand at right of entrance are expected to be erected.

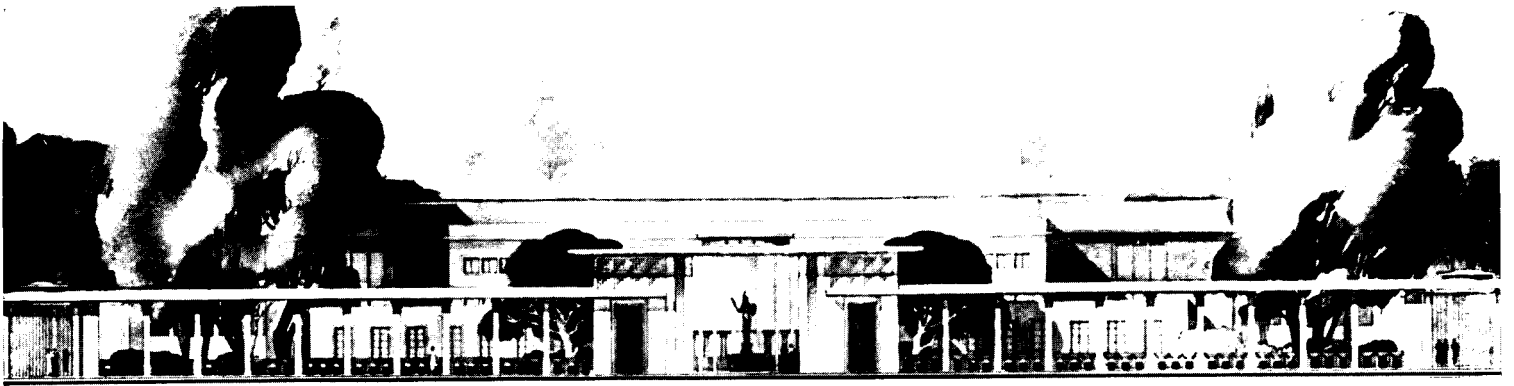

The central ticket office (above) with its flanking shelters will be built, while behind it lie Messrs. Murphy and Wischmeyer's conception of what the administration unit should look like. The concrete shelter has a typical section (right) which varies only as to balustrades, screen walls, etc., and grade; along the sides of the auditorium, its roof and floor levels follow the grade.

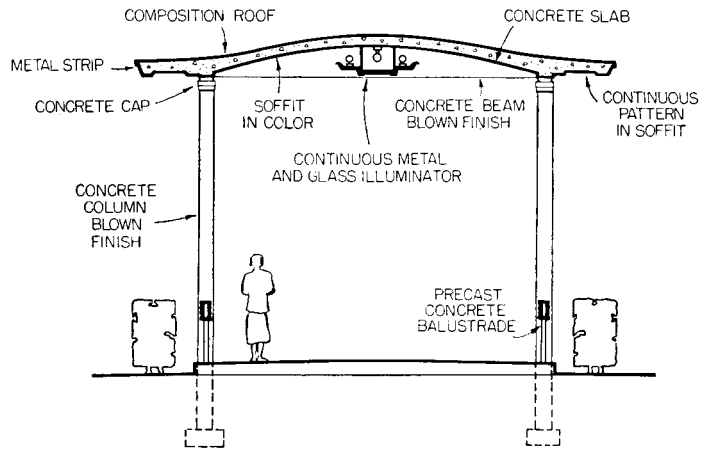

A. Sanders



The existing pergola (right, above) will be replaced, while the auditorium (right, below) is now in permanent form.

# PROPOSED BUILDINGS

Gordon Conner

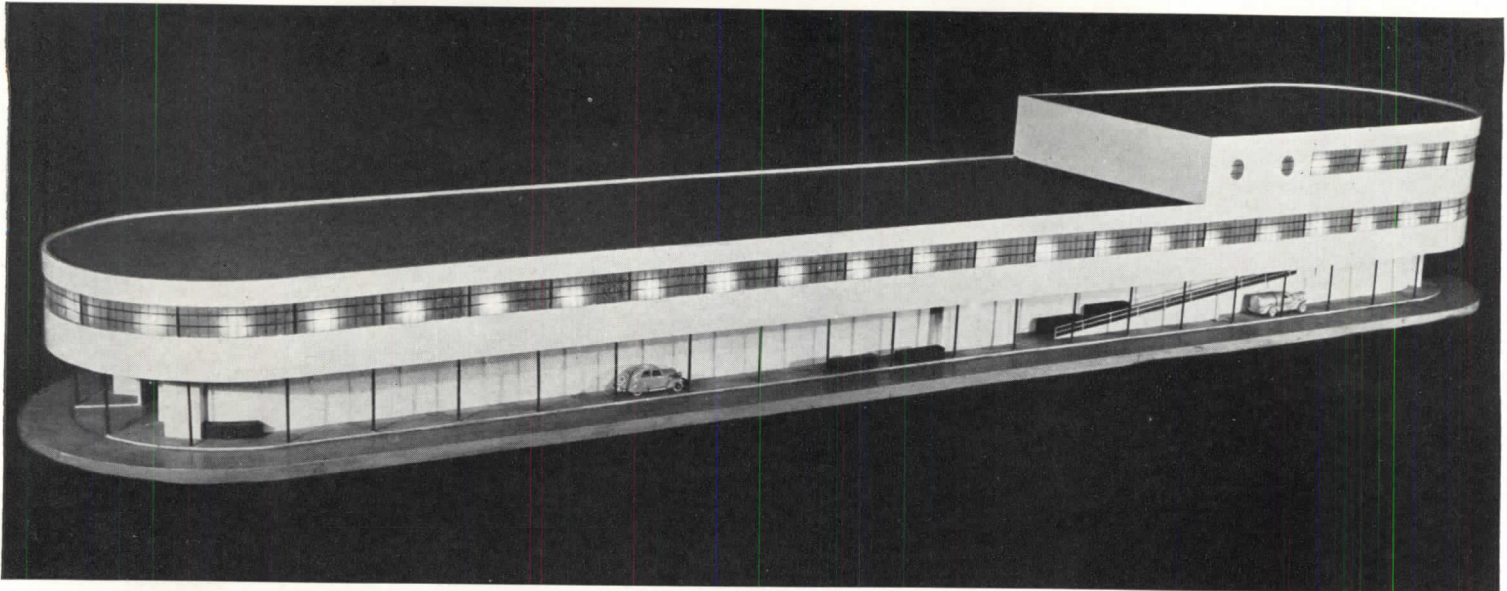

## Detroit, Mich.: Auto City Yields Motorized Market Design

WILBUR HENRY ADAMS  
Industrial Designer

INCREASINGLY important to building design is the problem of providing for automobile traffic. Parking of vehicles—with consequent traffic impediment—around public and commercial buildings has proved the greatest source of trouble. Suggested as a possible solution to the problem is this proposed food market building, which provides off-the-street parking facilities for 100 cars and trucks. Actually the reverse of the now familiar drive-in market, the building has a ground-floor garage with parking space at each side. Ramps along each side, and service stairs and elevators at either end, give access to upper floors. Counters provided along the first-floor level on the exterior of the building slide back

on casters when not in use, and are protected from theft by garage-type doors which roll down, allowing foodstuffs to be left in place. On the second floor are arrangements for display and sale of meats and various kinds of foodstuffs. The third floor contains a cafeteria and rest rooms. The roof, surrounded by a protective parapet, is intended for use as a playground for children. Refrigeration is provided in every stall from a central unit, which also serves to air-condition the entire building.

Adequate lighting was carefully studied in the model. Construction of the building is specified as fire-proof. The exterior finish is porcelain enamel, which provides an easy means of upkeep.

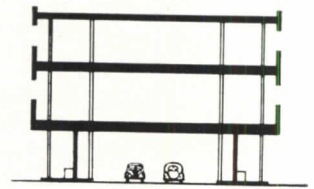

Section

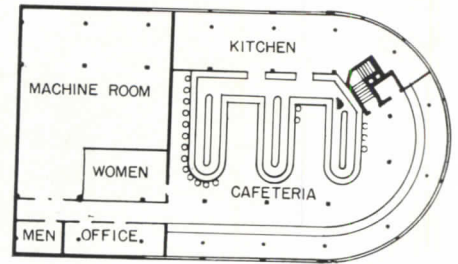

Third Floor

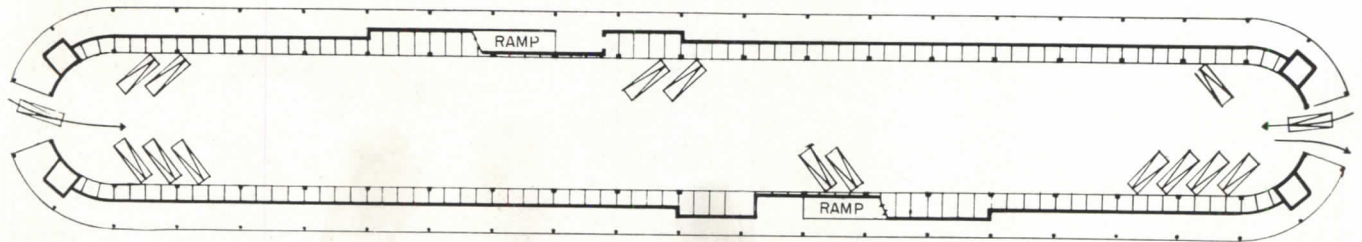

First Floor

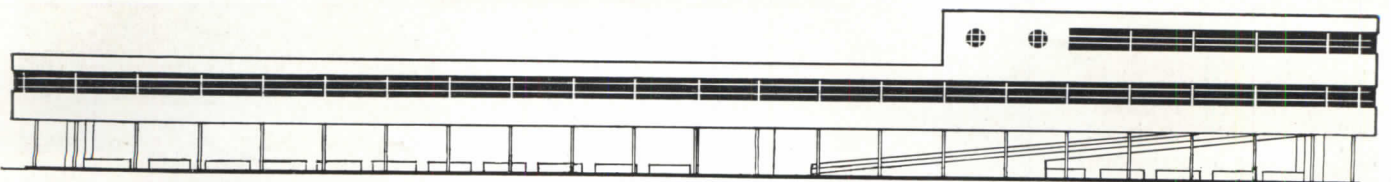

Elevation



# NEW STRUCTURAL SYSTEMS

## Low-cost, Firesafe House Employs New Unit

CONSCIOUSLY aiming toward the development of a new kind of low-cost house, the Blaw-Knox Company last month opened its demonstration prefabricated all-steel house at Clairton, Pa. Although exact figures on construction costs were not made public, engineers for the firm stated that the demonstration house cost about \$4,000, but that as production increased this would be reduced.

The essential point in this system is that walls, roof and ceiling are all constructed of the same steel panels, fabricated to the exact size required. For flexibility of design, the panels are made in units 20" and 40" wide. Each panel consists of a steel core of welded rust-resisting copper-bearing steel channels. Both sides of this frame are covered with 1-in. metal-clad rigid insulation, permitting a 3-in. dead-air space. Copper-bearing formed steel sheets are laminated to the insulation with a rust-inhibitive asphalt emulsion coat. The completed panel after receiving a shop coat of metal priming paint is ready for erection and provides smooth wall surface—interior or exterior—without exposed bolts, screws or welding seams.

Bolted to concrete block foundations is a sill or base angle to which the wall panels are bolted. The same method is used to secure them at the wall cap. Special wedge-shaped brackets and stud connectors attached to side channels hold the panels in place both vertically and horizontally. Roof framing consists of double steel channels welded together, sheathed with standard steel panels and insulated with 1-in. asphalt-impregnated rigid insulation; top membrane is of galvanized standing seam metal. Interior partitions are constructed of channel studs covered on both sides with  $\frac{3}{8}$ -in. composition board. Metal-clad insulated ceiling panels are supported by bottom chords of trusses, attached with clip brackets and Helyx nails.



Exterior walls are free of bolts, screws or welding seams.



Six men erected the structure in six days.



Exterior walls and ceiling are 1-in. metal-sheathed panels; a standard metal joint system and crack filler give interior finish without molds or battens (left).

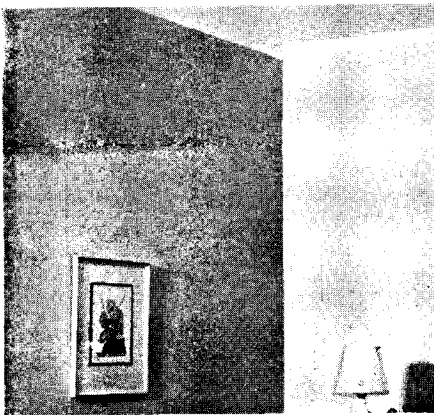



Photos by Ben Schnall



On deposit of the required number of coins, an automatic device delivers the desired article. More convenient than other similar devices which require two hands to operate, this one is designed for the customer who is already balancing a cup of coffee and has but one free hand. The lower shelf descends to open space at counter level and its contents are easily picked up.

### Cafeteria Uses New Mechanical Food Server to Complete Food Service System

POMERANCE AND BREINES  
Architects

ASIDE FROM employing a new type of "food server", Scharf's recently completed Automatique Cafeteria in Brooklyn, N. Y., represents an unusual effort to provide a complete food service system in relatively narrow confines. Here food preparation and service are vertically organized, one above the other, and connected by a series of dumbwaiters. Separation of these departments provides good circulation on the main floor, and

permits departmentalized food preparation in the basement, without the interruption of service activities.

Banked along one wall of the main floor are the automatic machines from which the restaurant takes its name. They deliver cold foods to the customer on deposit of the required number of coins. When the coins make the necessary contact the machine goes into operation: the glass-enclosed shelves

carrying individual food portions slip down until the bottom plate reaches the open space level with the counter. An ingenious device at the coin box tests each coin for size, weight and metal; the machine does not function unless the coins test satisfactorily. Behind the automatic machines is a narrow corridor for the few attendants required to keep the shelves filled. As the top shelf—there are six in each machine—reaches counter level and is emptied, the attendant raises the shelves, opens a door at the back of the machine and refills them.

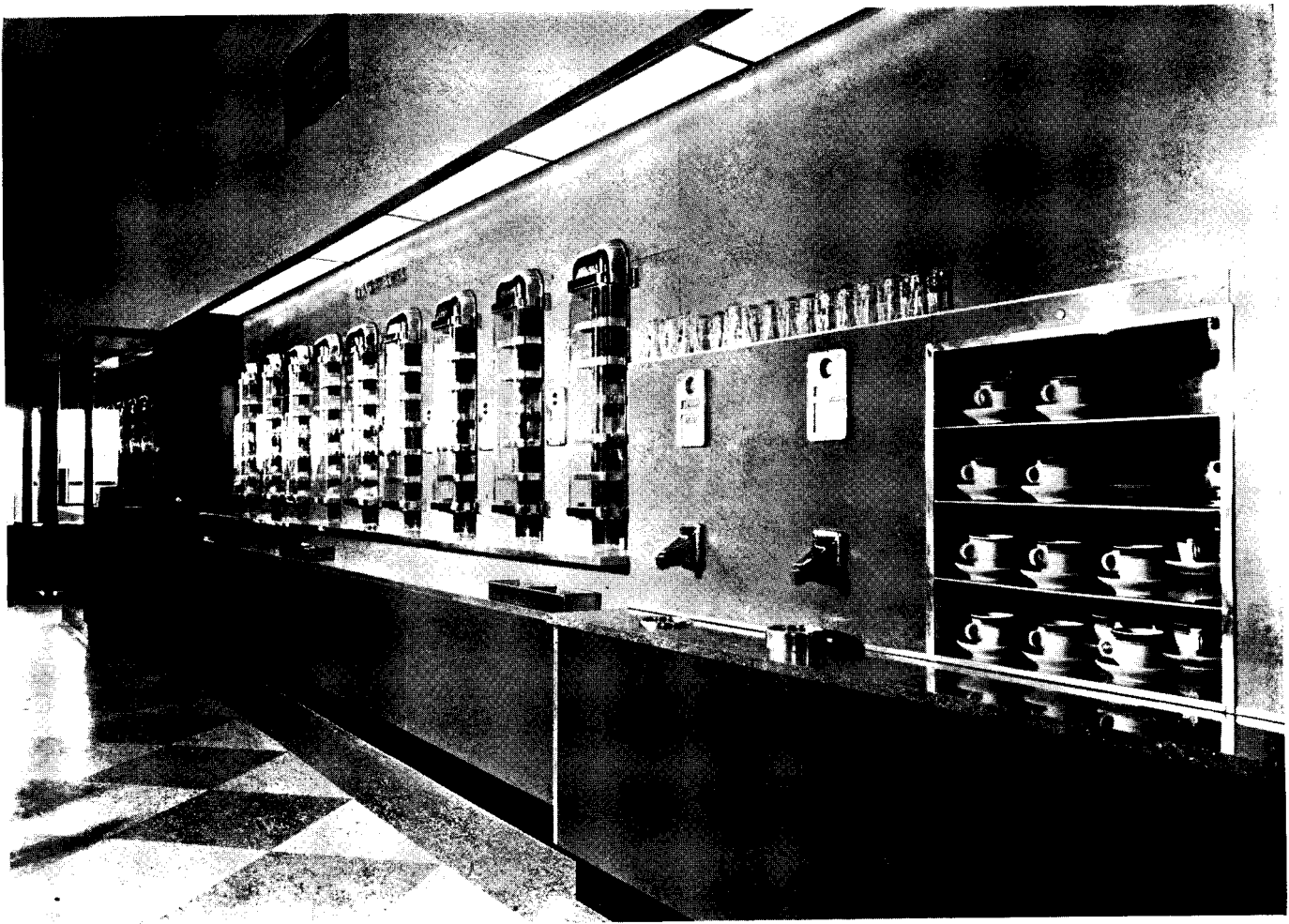

Automatic machines for sandwiches and beverages

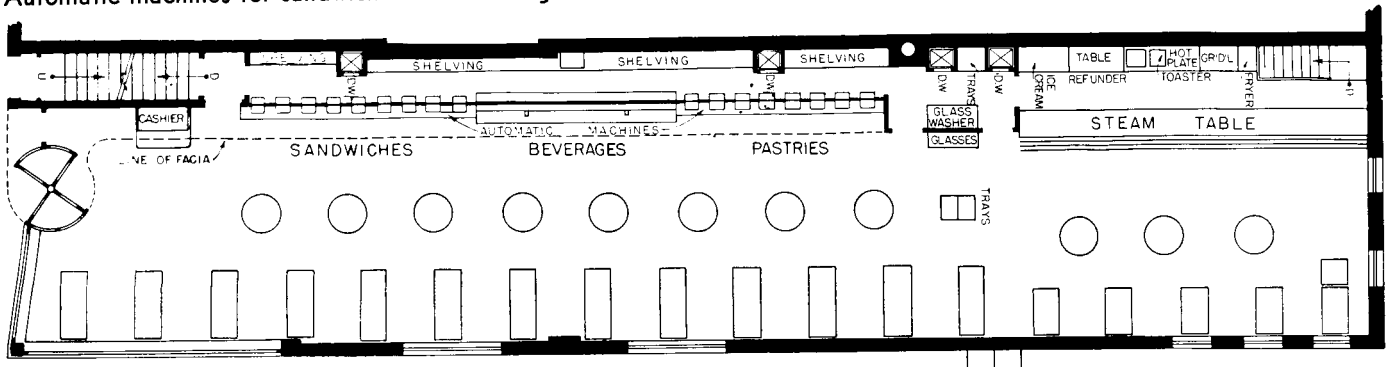

Street floor

Efficient service in the Automatique is largely attained by vertical—instead of the more usual horizontal—organization of operational activity. Each main-floor service has its supply source immediately below in the basement. Sandwiches made in the cold kitchen are transferred by dumb-

waiter to the sandwich portion of the automatic machines directly above. The same holds true of hot drinks, pastry and hot foods. Dishwashing is done in the basement in a location corresponding to that for glass-washing on the first floor.

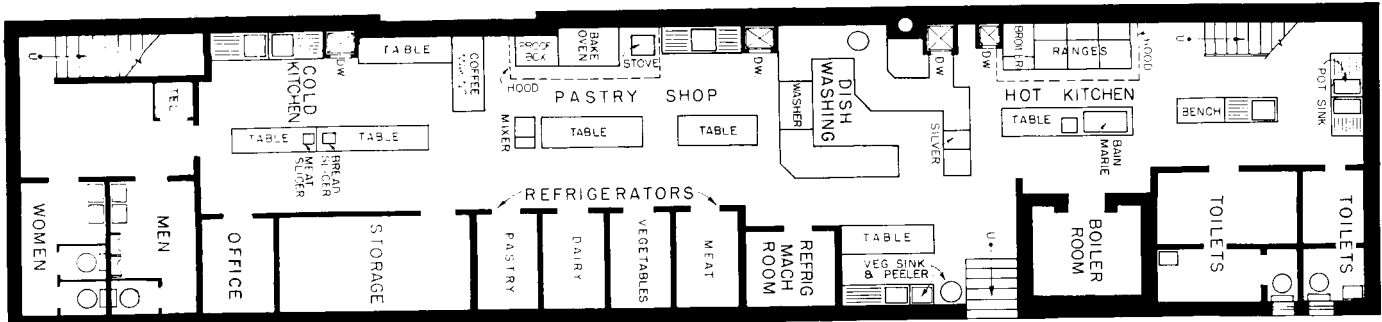

Basement

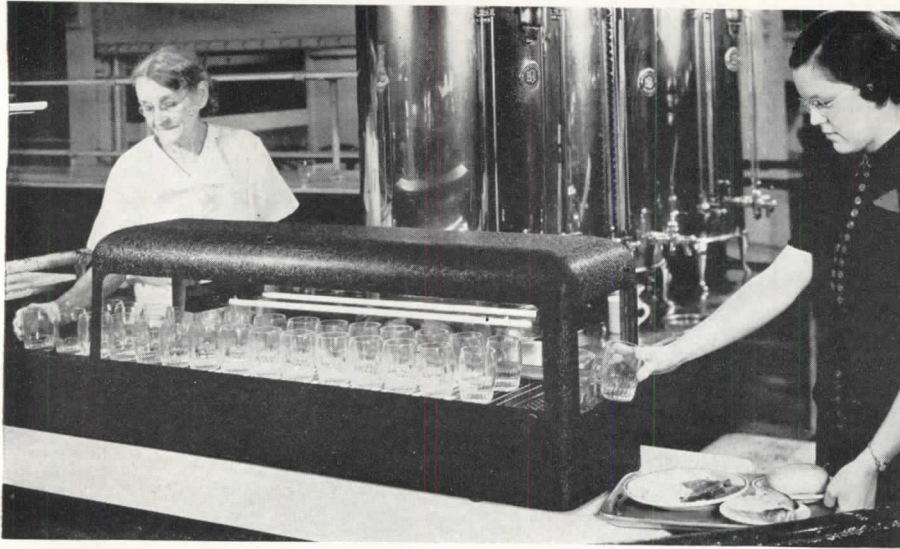

**RESTAURANTS:** Only the most rigid application of superheated steam can compete with Sterilamp in sterilizing china.



**MEAT MARKETS:** Meat can safely be stored at much higher temperatures either by direct application of Sterilamp (above) or in sterile air.



**INDUSTRY:** In this cosmetic factory, jars are passed under a bank of Sterilamps for sterilization while cooling.

## Perfected Germicidal Lamp Promises Wide Application

HAILED as the most important recent development in the field of asepsis, the Sterilamp, an ultraviolet lamp which sterilizes by radiation, last month had its first public demonstration at a meeting of New York's august scientific society, The American Institute. Present to describe their product were Drs. Harvey C. Rentschler and Robert F. James, research physicist and biochemist, who designed the Sterilamp. Their lamp provides a quick, inexpensive and absolutely effective means of sterilizing eating utensils, preserving foods and eliminating infection resulting from contamination with air-borne bacteria. (For earlier report on use of Sterilamp in bakery, see AR, 11/37, p. 39.)

Although rays from the Sterilamp deal certain death to microbes, they are harmless to humans, in contrast to the usual ultraviolet lamp, which operates under appreciable power and generates considerable heat. Sterilamp operates on a low wattage (power for two lamps and one transformer is less than is required for a 25-watt bulb), and at a temperature only 4° or 5° above room temperature. Sterilamps come in three sizes with over-all lengths of 14½", 24½" and 34½", and effective radiation lengths of 10", 20" and 30" respectively; tube diameter is 7/8" for all lengths. When operating at a normal room temperature of 70°F. the average life expectation of a lamp is 4,000 hours. Retail price is about \$10.

Applications of Sterilamp to industrial and commercial buildings are many and varied; it can be used to kill bacteria on a specific object or, by installing several lamps in a room, it can completely sterilize the air. Tests on several installations in factories indicated that after an exposure of 1.2 seconds to Sterilamp, 90% of the bacteria in the air were killed. The use of this lamp in hospitals has already been proved effective in the control of post-operative infections. (See AR, 4/37, p. 96.)

In the sterilization of glasses Sterilamp, installed in series along the baffles of bars and soda fountains, or in wire glass-holders, gives 99.99% sterilization in a few seconds and maintains sterility until the time of using.

Present installations of Sterilamp on farms indicate its value to agriculture not only in combating infection among animals but in the milking operation. Air-borne bacteria that usually fall into the pail can be killed, so that raw milk will be as safe as pasteurized milk.

## X-ray Jumped from Diagnosis to Radium Substitute

A 1,000,000-volt X-ray machine, one of the largest in the world, is now in use at the Los Angeles Institute of Radiology for the practical therapeutic treatment of cancer. This equipment, housed in a specially designed building, is the result of extensive research by Westinghouse engineers and physicists, who, spurred on by the fact that radium—until recently the only known treatment for cancer—is costly and scarce, sought an effective but less expensive source of the cancer-curing gamma rays. These rays are generated in sufficient quantity for curative use only when extremely high voltages are applied to X-ray equipment. Of the rays produced by the million-volt machine at Los Angeles, only 20% are usable; the rest are filtered out by copper and lead screens.

The equipment installed at the Institute of Radiology weighs 2,000 tons and pierces three floors, two of which are underground. This last was found expedient in order to eliminate side radiation or exposure from the X-ray. The transformer actually consists of five auto-transformers, each rated at 200,000 volts crest, stacked one above the other, with spun metal corona shields between them. Each unit is in an oil-filled tank surrounded with Micarta. The central section of the equipment is of steel, sheathed with three tons of lead—the only known insulation against the radium ray. This part of the tube passes through the treatment room, where provision is made for the treatment of four patients at once. When the current is turned on, the patients are left alone, but constant observation is maintained by means of a periscope placed near the controls for measurement of the amount of X-ray furnished to each.

The Institute's equipment is constructed so that it can be changed from X-ray to Neutron ray, if that radiation, which has a penetration twice as great as X-ray and is less destructive to the normal cell, should prove of value.

### Plan 2,500,000-volt X-ray

Deep X-ray therapy has also been used at Boston's Huntington Memorial Hospital and at Presbyterian Hospital, New York City, where 1,000,000-volt machines are installed. The Boston installation, designed by a group of physicists from MIT, has yielded "surprising results" during the first six months of use. But Huntington Memorial doctors are already "looking forward to a 2,500,000-volt machine", which would make the cancer treatment even more rapid and cheap.

### GRADE LINE

(All apparatus below this line lies underground.)

**TRANSFORMERS:** Gamma rays, generated in the giant 5-unit transformer at left, are transmitted to treatment room below.

**TREATMENT ROOM:** Four patients can be simultaneously treated in this room whose floors, walls and ceilings are armored against the rays.

**AUXILIARY EQUIPMENT** and pumps are housed in this room, 2½ floors underground.

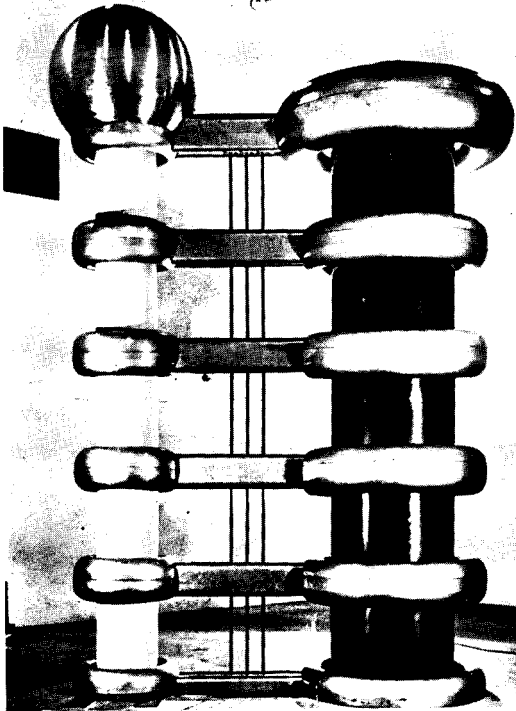
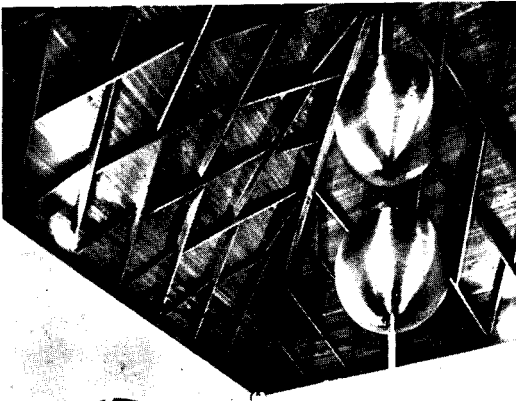

2-ft. armored concrete slab



2-ft. armored concrete slab

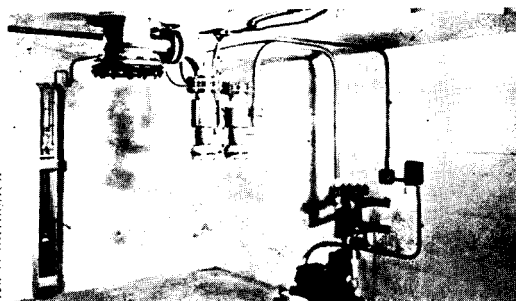

Dick Whitington

## NEW EQUIPMENT

Photos by Trede-Lemmerz

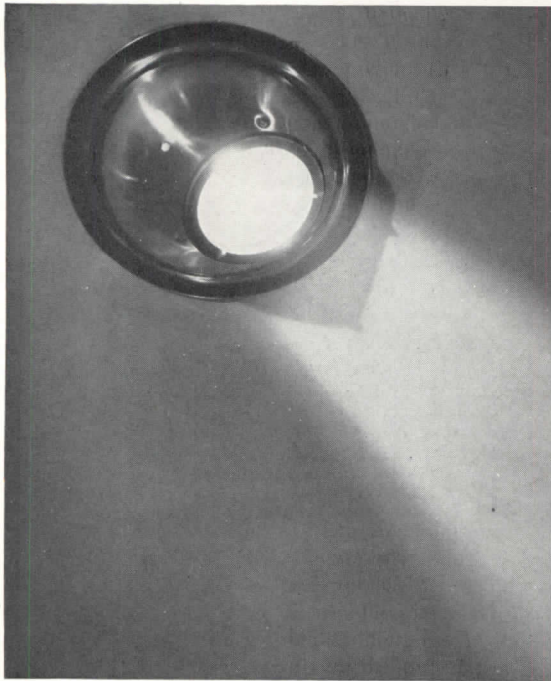

### Stage lighting yields new merchandising fixture

For dramatic lighting of freestanding merchandising displays, Century Lighting, Inc., recently evolved a variation of its theatrical unit, Fresnelite. Known as Ceiling Fresnelite, the new unit makes use of a spherical universal angle mounting so that the 500-watt T-20 lamp can cast a beam in all directions up to 32° from the vertical. The unit has a 6-in. Fresnelens (step lens), and provides for the use of a color glass holder. It is said to produce an illumination of 100 footcandles at a 15-ft. mounting height.

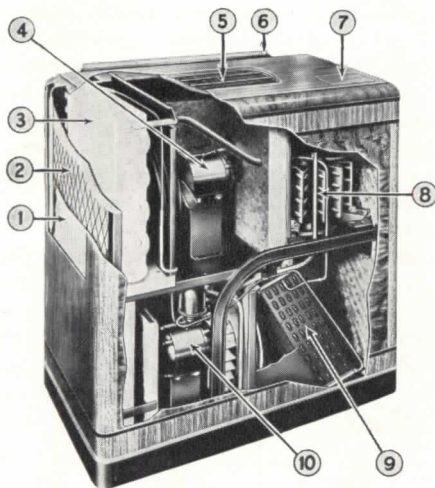

1. Intake grille (room air)
2. Filter
3. Evaporator
4. Circulating fan and motor
5. Outlet grille to room
6. Window duct connecting to outside
7. Concealed control panel
8. Sealed refrigerating unit
9. Refrigerant condenser coil
10. Cooling condenser

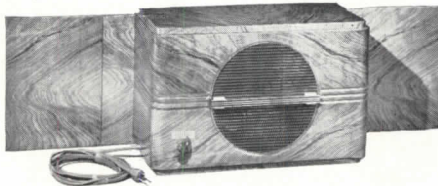

Shigeta-Wright

### Control of room atmosphere upped by two new units

Shifting from equipment for the entire building to that for single rooms, manufacturers last month introduced two units. Most notable feature of Delco Frigidaire's portable self-contained conditioner (left, above) is that it requires no plumbing connection, no special electrical connections, one outlet at window. Providing complete and flexible control for circulation, cooling, cleaning and humidity, the unit will retail at \$399 installed. Chicago's ILG Electric Ventilating Company brings out a new "Ilgirator" (right, above), which filters and circulates up to 250 cfm. Available in four widths, the unit has a revolving grille for deflection of current in any direction.

### "Daylighted" merchandise possible with new lamp

A TELLURIUM VAPOR lamp which has a continuous spectrum, and consequently produces a light similar to sunlight, has been announced by Drs. J. W. Marden, N. C. Beese and George Meister of the Westinghouse laboratories. Although still a "laboratory curiosity", the lamp represents a further step toward the production of a vapor lamp that will faithfully imitate sunlight.

In external appearance the tellurium vapor lamp resembles a low-pressure quartz mercury arc lamp with liquid mercury pool electrodes. Pool-type electrodes have to be used because of tellurium vapor's great chemical activity when highly heated. The lamp itself is made of quartz to withstand the high operating temperatures. (During one observation the temperature near the cathode surface was 700° C., and near the anode surface 825° C., but these are below actual inside temperatures.)

Ionization causes tellurium vapor to give off all colors of the rainbow—bluish white at low pressures and temperatures and with little electricity; nearly white at greater heat and with more power; golden yellow at extreme temperatures and a vapor pressure above that of the atmosphere. Because neon gas is used to start the lamp, its initial glow is red. The tellurium must be extremely pure or the lamp will not operate; since it is capable of absorbing and adsorbing inert gases, neon is pumped into it several times, saturating the tellurium and flushing out volatile impurities.

Practical demand for such a lamp has not yet materialized, but scientists feel that the tellurium lamp may be a crucial step in the search for a cheap and efficient source of light rays in which colors will retain their actual values.

### Fluorescence applied in many fields

WITH THE DEVELOPMENT of inexpensive sources of black light, products with fluorescent qualities have come into widespread use. (For report on black light and fluorescent paint, see AR, 11/37, p. 39; 10/37, p. 42.) Recently announced by Westinghouse is a fluorescent chalk which glows in the dark when irradiated with black light. It can be used in fluoroscopic examinations, for blackboard writing, or in connection with the showing of stereopticon or moving pictures.

For outdoor use on advertising signboards Continental Lithograph Corporation, Cleveland, Ohio, has developed a line of fluorescent inks and lacquers.

Tests made by the Corporation indicate that no appreciable deterioration takes place when this medium is exposed to weather, but, at the present time, it is recommended for bulletin use only. Equipment required for this new type of display includes ordinary incandescent lamps in shielded reflectors for showing the sign as a whole, and ultraviolet lamps (black light) for the fluorescent portion. The two kinds of light are regulated for alternating illumination of the sign. The fluorescent

materials are no more visible in daylight than when flooded with light from incandescent lamps.

In a recent issue of *Rocks and Minerals Magazine* a page printed with fluorescent inks is featured. When exposed to ultraviolet light the print appears to be bright green on a black page; when seen under ordinary light it shows up as red on a white page.

At San Francisco's Golden Gate Exposition, plans are being made for fluorescent fountains. The effect is

easily obtained by addition to water of a chemical solution which fluoresces under black light.

Industry has likewise found a use for fluorescence: Different substances, which are similar in appearance under ordinary light, show up distinctly when fluoresced and exposed to black light. By this means, zinc ores have been distinguished from worthless rock at Franklin Furnace, N. J. Tungsten ores in Nevada have also been identified in the same manner.

## NEW MATERIALS

### Use of clays advocated for efflorescing brickwork

EXPERIMENTS recently concluded at the New York State College of Ceramics, Alfred, N. Y., on the use of New York State clays in masonry mortars, indicate that clay mortars are superior in strength and have less tendency to develop efflorescence than mortars of lime content. By substituting finely ground New York State clays for lime in mortars, the experimenters, H. G. Schurecht, Professor of Research, and M. Corbman, Research Fellow for New York State Brick Manufacturers, found that the average adhesive strength was increased 55.2%. The same substitution raised the average compressive strength 36.9%, and the average tensile strength 40.2%. The importance of using mortars with high water retentivity was demonstrated by the fact that mortars with high clay or lime content retained water more tenaciously, allowing the mortars to develop a greater percentage of their potential strength. However, when compared on an equivalent bond strength basis, the water retentions of mortars containing clay and cement were higher in most cases than those with lime.

The tests produced new data on the causes of efflorescence—a subject of increasing interest to the building industry and brick manufacturers alike. The report states: "Portland cement caused excessive efflorescence in brickwork, while clay caused little or none. Substituting clay for Portland cement, therefore, reduced this trouble." (For report on method of predetermination of efflorescence in brick, see AR, 9/37, p. 26.) Addition of small amounts of borium carbonate to mortar, and harder firing of brick, were found to reduce efflorescence still further.

A composition which gave good results with practically all the clays tested was made up of 0.25 clay or shale, 0.75 Portland cement and 3 sand, on a volume basis.

Other advantages of mortars containing clay over those containing lime, according to Messrs. Schurecht and Corbman, are greater resistance to freezing, less shrinkage and less deterioration from heat. In addition such mortars do not burn or bleach mortar colors, are not injurious to masons' hands, and are economical of time and labor. Although not yet nationally available, many building supply companies in Iowa handle mortar mixtures containing Iowa clay—a recognized commercial product in that state—under different trade names.

### Compounded lumber designed to rigid specifications

LUMBER compounded to specification of uniform weight, strength and—to a reasonable degree—color, is now in production at the Mobile (Ala.) plant of the Meyercord Compound Lumber Company. Although the process used is essentially that of making plywood, increased refinements in equipment give increased control over the design of compounding woods for specific physical properties. The core of the new product is made up of woods unsuitable for many construction purposes; this is covered with other types of wood in proportions complying to specifications. To permit uniformity of color, the wood will be marketed with a light "blonde" surface. Boards with the same properties and within 5% of the same elastic moment can be prepared from practically all forest and even jungle woods, it is said.

Logs are first soaked in a pool to facilitate peeling of the veneer, then fed into a high-speed peeling lathe. The resulting ribbon veneer is clipped to uniform size and automatically separated into "books" of desired combinations of light and heavy sheets. These are then kiln-dried in a specially designed kiln, and subsequently coated with phenolic resin adhesive. After electrical heating and pressing at proper temperatures, the

boards are delivered as finished lumber. As a final step, a synthetic resin finish of the Bakelite type may be applied if desired. This phenol and formaldehyde glue impregnates the wood, making it fungus- and, according to the manufacturer, weatherproof. A uniform adherence to specification comparable to that of the steel industry is claimed.

### Increased strength in new gypsum cement

A RECENTLY DEVELOPED hydraulic gypsum cement is said to have a tensile strength of 600 to 1,200 lb. per sq. in., and a compressive strength of 6,000 to 12,000 lb. per sq. in. The new material, produced by Rumford Chemical Works, Rumford, R. I., can be made from practically any commercial grade of rock gypsum, anhydrite, or synthetic gypsum. Density of this cement is said to be greater than that of ordinary cement by reason of a volume change which occurs in the furnace. The density and strength of the material indicate its possible future use for floor and wall tile. The cement is quick-hardening: the first set can be controlled so as to occur in two hours, and the final set in four hours. Cost of the Rumford cement, according to a report of the Bureau of Mines, should be approximately that of Portland cement.

### Linoleum kills shoe-borne microorganisms

LINOLEUM has the valuable and little-known property of destroying non-spore forming bacteria, according to research by Congoleum-Nairn. This bactericidal power is due to certain chemical groups, especially linoxyn, in the linseed oil which is used as the binding medium in linoleum. Whereas the linseed oil in disinfecting wall paints wears off after a few months drying, it has a lasting effect in the linoleum. Frequent moistening is said to accelerate the disinfecting property.

## ON THE HOUSING FRONT

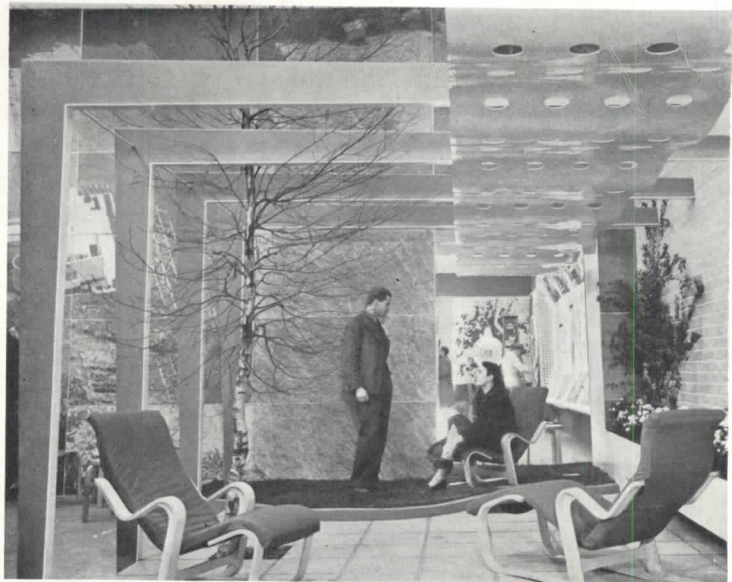

Wide World

### MARS proposes "supple" building—with "mobility of marble dove"

ARCHITECTURAL shows rarely attract public attention as did the recent London exhibition of MARS (Modern Architectural Research Society). Aside from the fact that its financial backers—manufacturers of building equipments and materials—had nothing to say about its plan, the show was chiefly notable for its integration of material, and for the fact that it represented a collective and anonymous effort on the part of MARS members.

Although there seemed general agreement as to the value of the MARS presentation itself, the design principles advocated were not without critics. Said Lance Amadeus (in *Architects' Journal*): "The first quality of a man is that he is always changing. A concrete building is an irrevocable statement . . . it endures forever. It has the mobility of a marble dove. The man who is going to live in a monolith must first close his mind to all

thoughts of improvement. . . . But the Martians go further than this. Not only do they fix the structure for all time, but they also plan the interior with scrupulous accuracy. . . . It is all very nice. But if you suddenly want to keep a tame koala or have two more children or do the big apple, you just can't. . . . We must have greater fitness; but—and this is the thing they keep forgetting—it can only be aesthetically justified by a decrease in cost."



Soichi Sunami, courtesy Downtown Gallery

### Artists show housing needs, recommend improvements

"ROOFS FOR 40 MILLION"—an exhibition on housing, is this year's offering of An American Group, Inc., a cooperative, non-profitmaking association of artists. The 200 works of art—paintings, sketches, models, photographs—on

exhibition represent, says the group, "the artists' response to the campaign to eradicate slums and replace them with livable buildings". Typical of the show are the photograph and painting reproduced above: "Town Planning in

Roanoke, Va.," taken by P. Ingemann-Sekaer (left), and "The Various Spring", by Louis Gugielmi (right). The exhibition runs to May 1, at La Maison Française, Rockefeller Center, New York City.



## WITH THE PROFESSION

### Ethical publicity to aid architects prepared

CONCISELY STATED in a leaflet prepared by AIA's Committee on Public Information are the most important reasons for employing an architect rather than buying a ready-made home or building without an architect's services. These leaflets are available in any number at cost price, \$0.02½ per copy, from E. C. Kemper, The Octagon, Washington, D. C.

As a graphic means of conveying the same message, a series of motion-picture productions, entitled "Consult Your Architect", has been released by Mason Wadsworth, a business film concern. The films, intended for commercial and educational showings, have been prepared with the editorial assistance of a committee of American architects. The series is designed to "show the importance of America's architects in the building of America."

### 1939 ICA meeting to be in Washington, D. C.

AMERICAN ARCHITECTS will be hosts to the Fifteenth International Congress of Architects, which is slated to meet in Washington in September 1939. The Organizing Committee for the Congress, as appointed by President Roosevelt, includes Charles D. Maginnis, Chairman; Richard Southgate, Louis A. Simon, Edwin Bergstrom, Harvey Wiley Corbett, R. H. Shreve, George Oakley Totten, Stephen F. Voorhees and C. C. Zantlinger.

### Building trades unions launch cooperation drive

LAUNCHED BY THE leadership of Cleveland's Building Trades Council (AF of L) is the "Build America" campaign for organized sales-promotion activity on the part of the building trades to "generate favorable conditions for the employment of men and materials in privately financed construction." Although its program—drawn up by James C. Caffrey, co-ordinator of Cleveland's FHA activities, and Albert Dalton, president of the Cleveland Federation of Labor—was originally set up for application to the city of Cleveland, a campaign is now under way to make it a nation-wide movement.

A corporate offspring of the Council proper, "Build America" hopes to promote local goodwill. As evidence of good faith, the Cleveland Building Trades Council has already moved that there be no advance in wage rates for the next two years. In addition, an arbitration board has been set up.

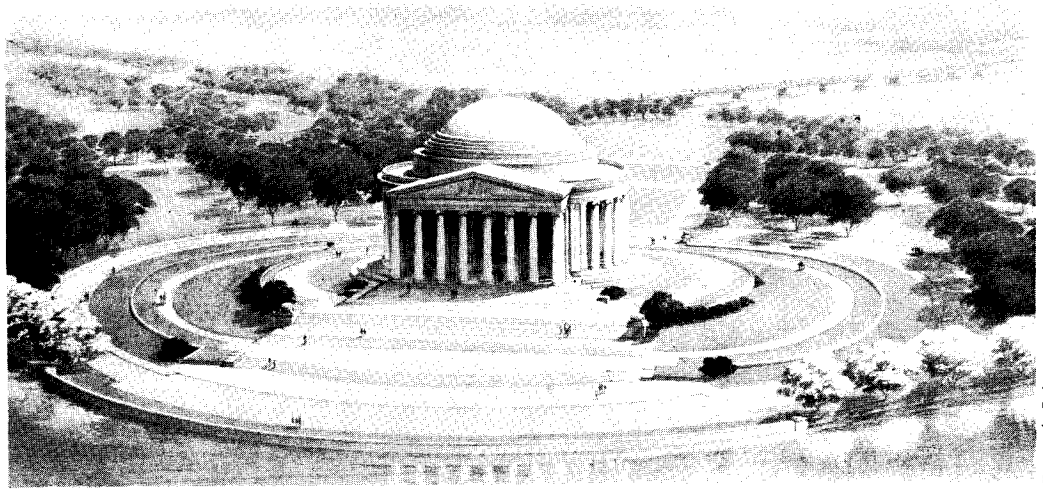

Peter A. Juley

### Cherry trees win in Jefferson Memorial debate

WITH THE RECENT announcement of a new site and altered plans for the Thomas Jefferson Memorial in Washington, the cherry trees appear to have won and the "modernists" lost in the Capitol's "battle of the century." (For original plans, see AR, 6/37, pp. 24-26.) Central point in that many-sided controversy was the proposed removal of a large number of the famous cherry trees to make way for the domed classical structure designed by the late John Russell Pope. According to the new plan, the cherry trees—except those di-

rectly in front of the projected building—will remain intact. Relocated to a position on the banks of the Tidal Basin, 450 feet southwest of the original site, the Memorial will complete the central plan of the city, says Rep. John J. Boylan, chairman of the Memorial Commission.

The new plan was prepared by the Office of Mr. Pope, and was last month approved by President Roosevelt, Thomas Jefferson Commission, Fine Arts Commission and National Capitol Park and Planning Commission.

### Goucher College announces competition for new building

GOUCHER COLLEGE, Baltimore, Maryland, announces a competition to choose an architect to prepare a general development plan for its land near Towson, Md., and to design one building on the property. Invitations to submit designs will shortly be extended by the College to a limited number of architects. The Advisory Board of Architects for the competition consists of Edward L. Palmer, Jr., Richmond H. Shreve and James R. Edmunds, Jr. Architects who desire to submit designs may obtain information from the Advisory Board of Architects, Goucher College, St. Paul & 23 Sts., Baltimore, Md.

### Sculptors to hold outdoor exhibit

AN OUTDOOR exhibition of contemporary American sculpture will be held April 12-30, on a vacant lot at Park Avenue & 39 St., New York City. First of its type, the exhibition is sponsored by the Sculptors Guild, and includes works in marble bronze, terra-cotta plaster, cast-stone and wood.



American-Swedish News Exchange

### Sweden's "first functionalist"

Gunnar Asplund, noted Swedish architect and designer of the Stockholm Fair of 1930, arrived recently for a lecture tour of a number of this country's architectural schools. Besides the Stockholm Fair design, Professor Asplund's work includes the State Institution of Bacteriology, the Stockholm Town Library, the Skandia Theater and the Forest Cemetery.

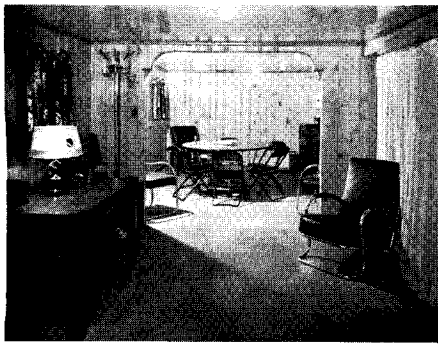

### Better basement

First prize in the recent contest for the best modernized basement, conducted by the Chicago Coal Merchants Association, was awarded to the above basement recreation rooms because of their "livability."

### 4-way gas use pushed in competition

AS THE main feature of its campaign to further the use of gas in homes, the American Gas Association has announced a competition open to architects, town planners, engineers, draftsmen and designers resident in the United States and Canada. The competition—which closes May 23—is presented in two parts: Part I concerns House Design; Part II, Neighborhood Planning. Part I is divided into two classes, one for the design of a house containing 18,000-24,000 cu. ft., the other for design of a house containing 24,000-32,000 cu. ft.

Part II involves layout on a real or hypothetical site of a community of families of diverse occupations whose incomes range from \$2,000 to \$7,000 per year.

Entries to Part I must show details of kitchen and basement or utility room, including laundry, planned for efficient use of space and equipment. All competitors must submit designs in either class of Part I; they may in addition enter a design in Part II. Further information from Competition Director, American Gas Association, 420 Lexington Ave., New York.

### Soap sculpture up again

ENTRIES to 14th Annual Competition for small sculptures in white soap are due May 15, according to the National Soap Sculpture Committee, 80 E. 11 St., New York City. The competition is divided into three classes: junior (under 15 years of age); senior (15-21 years); and advanced amateur (21 years and over). A total of 97 awards, ranging in value from \$10 to \$200 will be presented by the Procter & Gamble Company to winners in the three classes.

## NEW INFORMATION FOR THE BUILDING FIELD

### BOOKS

#### General

*Air Conditioning Furnaces and Unit Heaters.* By J. Ralph Dalzell. American Technical Society, Chicago, Ill.

*A New Home by Frank Lloyd Wright on Bear Run, Pennsylvania.* Museum of Modern Art, 14 W. 49 Street, New York, N. Y.

*Decorative Art, 1938: The Studio Year Book.* The Studio Publications, Inc., 381 Fourth Avenue, New York, N. Y. Price, (paper) \$3.50; (cloth) \$4.50.

*Heating, Ventilating and Air Conditioning Guide, 1938.* American Society of Heating and Ventilating Engineers, 51 Madison Ave., New York, N. Y. Price, \$5.

*Historical Color Guide.* By Elizabeth Burris-Meyer. William Helburn, Inc., 15 E. 55 St., New York, N. Y. Price, \$6.

*Negro Housing in Towns and Cities, 1927-1937.* A bibliography. Russell Sage Foundation, 130 E. 22 St., New York, N. Y. Price \$0.10.

### Manufacturers' Publications

#### Electrical Equipment

*Bull Dog Current Catalog No. 381.* Bull Dog Electric Products Co., Detroit, Mich.

*Miller Mer-Tung Lighting Equipment, Catalog Section 29.* The Miller Co., Meriden, Conn.

#### Heating and Air-Conditioning Equipment

*De Luxe Smith Boilers with Full-Flo Circulation.* The H. B. Smith Co., Westfield, Mass.

*The Key to Secrets of Better Heating.* For the consumer. National Coal Association, 804 Southern Bldg., Washington, D. C.

*Victor In-Bilt Ventilators.* Victor Electric Products, Inc., 712-720 Reading Road, Cincinnati, Ohio.

#### Materials and Equipment

*Bakelite Laminated.* Bakelite Corporation, 247 Park Ave., New York, N. Y.

*Decorative Mouldings of Metal.* Heron-Zimmers Moulding Co., Detroit, Mich.

*Higgin Screws and Light Tight Shades.* Higgin Products, Inc., Newport, Ky.

*Homes of Charm.* For the consumer. Western Red Cedar Lumber, 5566 Stuart Bldg., Seattle, Wash.

*Imperial Floatless Sump Pumps.* The Imperial Brass Co., Chicago, Ill.

*Kinnear Rolling Doors, 1938 Catalog.* The Kinnear Manufacturing Co., 820-870 Fields Ave., Columbus, Ohio.

*Koppers Roofing Specifications.* Koppers Co., Tar and Chemical Division, Pittsburgh, Pa.

*Weisway Cabinet Showers, 1938 Catalog No. 338.* Henry Weis Manufacturing Co., Inc. Cabinet Shower Division, Elkhart, Ind.

### CHANGE OF ADDRESS

The RECORD publishes changes of address only on request, making no attempt to keep a day-to-day account. Only organization in the country with facilities for this is Sweet's Catalog Service, whose painstakingly maintained list undergoes an average of 23 changes per day for every working day in the year.

Roger C. McCarl, Architect, formerly located at Wrightsville Sound, N. C., has removed his office to 306 Stearns Building, Statesville, N. C.

Stanley McCandless and Edward B. Kirk have opened an office as lighting consultants at 101 Park Ave., New York, N. Y.

Chester D. Sommerich, Architect, has opened an office for the practice of architecture at 6635 Delmar Blvd., St. Louis, Mo.

In the reorganization of the firm of Hoener, Baum & Froese, Architects and Engineers, the following changes are announced: Albert H. Baum, Jr., and Ewald R. Froese will continue in the practice of architecture and engineering with offices at 3605 Laclede Ave., St. Louis, Mo.

P. John Hoener, Architect and Construction Consultant, has opened offices at 3417 South Kingshighway, St. Louis, Mo.

### CALENDAR OF EVENTS

- April 19-22—Annual convention, American Institute of Architects, New Orleans, La.

- April 20-May 12—National Exhibition, Architectural League of New York, American Fine Arts Building, 215 W. 57 Street, New York, N. Y.

- May 15—Closing date, competition for small sculptures in white soap. National Soap Sculpture Committee, 80 E. 11 Street, New York, N. Y.

- May 15—Closing date, applications for Kate Neal Finley Memorial Fellowship in Art, Music or Architecture, University of Illinois, Urbana, Ill.

- May 23—Closing date, Architectural competition sponsored by American Gas Association, 420 Lexington Avenue, New York, N. Y.

- June 1—Closing date, competition for sculpture on United States Government Building, New York World's Fair.

- June 1—Closing date, Lincoln Arc Welding Contest, James F. Lincoln Foundation, Box 5728, Cleveland, Ohio.

# DESIGN TRENDS



*Fairchild Aerial Surveys, Inc.*

**THE ARCHITECT'S PLACE IN HOUSING**

ARCHITECTURAL  
RECORD



**SLUM CLEARANCE AND PUBLIC HOUSING**



**LARGE-SCALE, PRIVATELY FINANCED HOUSING**



**PRIVATELY BUILT SINGLE FAMILY HOUSES**

# Does Housing Offer a Career to Architects?

## A SYMPOSIUM

With the spotlight of government attention focused upon it, housing has again been brought into sharp relief as a matter of major importance to every element of the building industry. It is an old problem. But recent events—social, economic and technical—have combined to give it new aspects. The United States Housing Authority is taking a long first step toward slum clearance and low-income public housing on a nationwide scale. Recent liberalization of Federal Housing Administration policies has opened a new financial door to small house building and large-scale, low-renting housing. How profoundly do these events affect the status of the building designer? Do they imply that the architect will find it increasingly difficult to conduct an independent professional practice? Or will they solidify his present position and widen the scope of his technical and economic opportunities? Answers to these questions can be truly made only in terms of future developments. But their significance is clear today in view of statements recently made by three men who are in the forefront of housing activity on a national scale. These statements are published here. Comments regarding them hardly represent a cross section of professional opinion. But they can serve as a basis for further discussion to clarify trends of professional thought and, possibly, to aid in forming individual and collective policies for future action.

## SLUM CLEARANCE AND PUBLIC HOUSING



Wide World

SPEAKING at the Architectural League of New York on February 3, 1938, Mr. Nathan Straus, United States Housing Administrator, in his discussion of Public Housing, offered the following personal message to the Architects of America:

"One of the greatest services you can render to the American architectural profession and to the cause of low-cost housing, is to

encourage a different attitude toward government housing among members of your profession. A government housing project should not be regarded merely as an architectural job. There should be a pride in being given an opportunity to engage in this type of work. Government housing should not be regarded merely as a source of fees. It should be, and I hope it will be for many of our architects, a career.

"Today we are faced with the definite need for adequately trained technical staffs on local housing authorities. Trained 'housing' architects, ready to devote themselves in the government service to the cause of low-cost housing, are badly needed today. Architects who are interested in housing can often serve better by going directly into local housing authorities. They will then be in the work at first range rather than by standing on the outside and acting merely in what has been in this country the traditional role of architects.

"This field for architects already has been recognized and assumed in the countries abroad. The outstanding housing architects abroad have been associated with slum-clearance housing legislation and policy continuously from its inception. It was often they who organized the cooperatives, assisted in the organization of the tenant associations, and educated the trade unions to take leadership in the housing movement. There is need for work along similar lines by the architects of the United States, for there are opening up in this country today like opportunities for making slum-clearance and low-rent housing construction a life career. May our architects make equal use of these opportunities."

**QUESTION: Do you agree with Mr. Straus that government housing offers a career for architects? If so, do you believe they should become government employees, or should they operate on an independent professional basis?**

I AGREE with Mr. Straus that government housing offers a career for architects somewhat in the same manner that architects have specialized in schools, hospitals, railroad stations, office buildings, churches, industrial buildings, residences and other types of structures.

I believe that housing will be best served by the work being turned over to private architects; but I certainly believe that either as full-time or part-time consultants, or as employees of government agencies in an advisory capacity, there is a very splendid field for many architects who not only enjoy that sort of work, but are particularly adapted to that field of endeavor.

Architects employed in government agencies, who come in contact with the many problems involved in housing, can render very valuable assistance, not only to the members of their own profession but to the public at large, by developing educational programs for the architects, engineers and the public.

It is quite impossible for an individual architect to become an authority on all phases of housing; but he should be acquainted with all sides of the questions in order intelligently to carry out his own functions.

I believe there is a distinct place for the architect in Government as a research man, an educator of the American people. But I believe also that the architectural work should be performed by private architects operating in their own localities where they are thoroughly acquainted with local conditions.

—**WALTER R. McCORNACK, Cleveland, Ohio**

I AGREE with Mr. Straus that the needs of public housing are best served if the architects connected with it are career men. This, of course, is subject to several provisos:

(1) That the architect's work be not confined to the drawing of plans and preparation of specifications for which others have determined the picture; but that the architect's function as co-ordinator of the entire project

be definitely recognized. Unless he is constantly in the picture from the time the first negotiations are started until the last nail is driven, there is no advantage in having him employed by the Government, and private architectural firms can do the work better.

(2) If a career in government architecture is to attract competent architects, it must offer them security and adequate pay.

I agree with Mr. Colean that large-scale, privately financed housing offers a profitable career to architects. If they are merely temporary employees of private organizations engaged in this type of work, it is probably in a large measure their own fault. Here too the architect must be familiar with the entire field.

—**EUGENE H. KLABER, Federal Housing Administration, Washington, D. C.**

ONE CAN agree with Mr. Straus that government housing offers a career for architects as technical advisers if: (1) housing authorities are so set up as to keep their technical advisers free from politics; if (2) they pay a salary commensurate with the ability required and the responsibility offered; if (3) they place him in a position not only of responsibility but of authority.

However, I gravely doubt the advisability of projects being designed in government offices, at least for a long time to come. There is always a tendency for such a bureau to freeze plans into "stock plans" in the interest of so-called economy of production. We do not know enough about low-rent housing to take the risk of becoming stereotyped.

Private architects selected from a panel chosen by competition, with a thoroughly competent technical adviser in the local authority to guide development of final plans, would seem the most satisfactory procedure. In that way knowledge and experience will be spread in the profession, which now sorely lacks the necessary economic background and social understanding.

—**HENRY S. CHURCHILL, New York City**

I HEARTILY agree with Mr. Straus that all architects should cooperate and participate in the various phases of the housing programs. We can learn much from the demonstration projects which have already been built by the Federal Government; but this is only a start. We still have a long way to go and the problem deserves the best we can give it.

Every local housing authority might well have an architect member, familiar with the best work that has been done to date, to pass judgment on the technical virtues of the many projects which will be presented.

To my mind, however, no architect should limit himself to this work alone, nor can he do his best as a salaried employee of the Government. This results inevitably in grooved mediocrity.

He can profit much from ideas he may develop in the design of many other types of building; and he can do himself and his job justice only by retaining that alert and vital point of view acquired in the keen competition of private practice.

—**A. C. ESCHWEILER, JR., Eschweiler and Eschweiler, Milwaukee, Wisconsin**

MUCH CAN be said, pro and con, of Mr. Straus' plan for government housing. The problem is one for the individual architect to settle for himself. Doubtless, many younger men will be attracted, which may be beneficial for them as well as for the housing problem. There are all the dangers of bureaucratic control, loss of professional identity and so on, and the many benefits to be derived from large-scale projects, specialization and close study of a pressing problem. That housing has been made successful in Europe is a hopeful sign; that conditions there are different in many ways must not be overlooked.

—**TEMPLE HOYNE BUELL, T. H. Buell & Co., Denver, Colorado**

AS I LISTENED to the three paragraphs quoted, it was hard to realize that it was Mr. Straus speaking. Since when, I asked myself, have financial business men cast out the

present economic order? But this is a topsy-turvy world; and it has become impossible to distinguish between the voices of the living and the voices of ghosts.

Of course technical men in large numbers are needed in Government if Government is to embark upon the design and production of habitations *in conjunction with the lending of funds for their erection*. This would make sense if we had decided to abandon our economic system; but that is plainly not the intention. And so one may safely predict that so long as housing is a matter of financial business, whether by Government or otherwise, authority will rest with politicians, financial business men, lawyers and judges; and final decision as to what is to be done will rest in their hands.

Technical men will no doubt enter the field of government housing and start out with high hopes of reaching the top by way of the ladder of career men. But they will work themselves up that ladder at about the same rate that they abandon the criteria of science and technology under which such men must work if they are to do what lies within their capacity to deliver.

The three paragraphs quoted run with the general trend of thought

within the frame of a liberal point of view. One might even mistake the statement for a deliberate move toward a socialistic scheme of things. But housing by subvention is nothing of the sort. It is one of many strategic moves to save an economic scheme out of which the present state of maladjustment arose. The provision of housing by government loans and subvention and by mortgage insurance, etc., reflects aims which point in directions 180° apart. This is what makes the position of the architect so confusing.

—**FREDERICK L. ACKERMAN, New York City**

THE GREENBELT projects now completed and nearing completion have given a great impetus to housing throughout the country. Whether to incorporate and execute any large percentage of this work directly in charge of government employees, as in Europe, is most questionable. Certainly the regimented strip housing of Germany or the serried rows of the English developments would neither meet our needs nor appeal to our citizens.

The extraordinarily rapid development and superiority of our country has been due in the past to individual initiative and energy, fired by com-

petition and the necessity of improvement in any line if one is to succeed. Such incentive may exist for a time in government bureaus, but is sure to flag, producing eventually perhaps a fine technique, but gradually becoming obsolete, lifeless and inflexible.

Could the Government maintain a bureau of information with minimum requirements and establish a system of careful checking, both in the plan stage and later in the field, we should be spared repeating many mistakes, and be able to avail ourselves of the varied talents of the individual architect so necessary in this field.

The Government has done an excellent piece of work in standardizing and assembling the best plan arrangements in large-scale housing developments. This is invaluable to the architect undertaking "Housing"; but to organize and continue under government control work of this character would seem eventually to invite work devoid of interest, variety and adequate investment returns.

Certainly, when viewed from all angles, the projects undertaken under limited dividend companies have achieved a much higher standard, commensurate with costs and income returns, as well as architectural merit.

—**FRANK A. CHILDS, Childs & Smith, Chicago, Illinois**

## LARGE-SCALE, PRIVATELY FINANCED HOUSING

Underwood & Underwood



RECENTLY, in discussing the subject of housing, Miles Colean, Technical Director of the Federal Housing Administration, made the following comments on the relation of architects to large-scale privately financed projects.

"The need for adequate dwellings properly planned and constructed, financed and managed under a sound plan geared to the ability to pay, constitutes a challenge

to every individual in any way connected with the building industry.

"This need cuts through all income classifications. Housing requirements for the family of moderate means are just as pressing as those for families of lower income brackets. Both rental projects and sales projects for families of moderate means can and should be developed as self-supporting ventures yielding a satisfactory return

to private capital.

"The Federal Housing Administration is concerned with this type of privately financed housing project. Its function is not to lend money, but to insure private capital against loss. To do this, however, the FHA must have recourse to adequate standards of design and must be certain that all details of the project are properly co-ordinated to produce insurable values.

"In the development of such standards and in their application to specific housing projects, FHA must rely upon the architect to solve many of the technical and economic problems that are involved. They are best qualified by training to do this.

"The privately financed field of large-scale housing opens a new career for architects. No basic change in professional relations is necessary to make such a career practical and profitable to all concerned. I believe the architect's most valuable contribution to any housing project comes from his ability to analyze the problem and direct its solution as a professional consultant. As a member of a housing bureau of any sort he too often loses the unbiased, objective point of view that is one of his most valuable professional characteristics."

**QUESTION: Do you agree with Mr. Colean that large-scale, privately financed housing offers a profitable career to architects on an independent professional basis? If not, do you think the technical and financial complications of such projects imply that architects become employees (temporary or permanent) of organizations engaged in this work?**

IF YOU mean by "independent professional basis" what I understand it to mean, "business as usual" (and that is the basis generally being accepted in this locality for such projects), I see no possible cause for dis-sension.

But I can see no cause for alarm even if the architect were forced to become one of the administrative cogs of a development machine. Architects were not put in this world by divine mandate and the sooner the profession realizes this the better. An architect should be able to furnish imagination, advice and direction whether cloistered in his own office or exposed to the firing line of business activity. If he cannot hold his place with promoters, contractors and realtors, he does not deserve to exist.

—**J. WOOLSON BROOKS, Proudfoot, Rawson, Brooks & Borg, Des Moines, Iowa**

WE HEARTILY agree with Mr. Colean in his statement that large-scale, privately financed housing can and should be handled by architects on an independent professional basis. Definitely, it is our experience that the best architectural service has not been realized where the architects are employees (temporary or permanent) of organizations that promote or build housing projects.

The independent architect is more likely to keep himself and his organization in position truly to analyze plan-and-construction problems and direct their solution, than an architect-member of a housing bureau, who, all too often, is subject to control of those whose primary objective is the promotional end of the organization.

—**CARLETON W. ADAMS, Adams & Adams, San Antonio, Texas**

A REAL OPPORTUNITY is open to architects in the comparatively new field of large-scale, privately financed housing. While it is difficult to foresee the way in which the architect will be able to place his advice at the disposal of those who need it for the development of large-scale projects, it is certain that if he shows adapta-

bility and understanding of the value of the advice which he is capable of giving, an increasing amount of business of this nature should be opened up to the well-trained architect.

The initial difficulties vary with the type of properties that will be developed. In housing designed to replace or improve blighted areas, the architect will suffer the temporary handicap of finding no client who can speak for the many independent owners of properties which comprise blighted areas. The architect will have to do some promotional work himself in order to organize new entities and to inspire in them an interest in this type of planning. It is possible that the advice which architects give may fall into two general categories. The first of these will be advice of a general nature such as is essential for the formation of corporations to construct and operate large-scale housing enterprise. Architects, especially those who have had a good deal of experience in the field of large-scale planning, should be able to tender their services on a consultation basis, perhaps leaving the preparation of detail drawings to another class of architects who, although they have had long experience in construction, are unfamiliar with the economic and social aspects of group planning.

In cases where large corporations already exist, capable of carrying out both construction and operation on a large scale, architects may find it advantageous to accept a permanent retainer from such corporations or even to become members of their staffs. It is probable, however, that the architect with wide housing experience will be able to provide better service as an independent consultant than as a member of a single organization. The building and development corporations would probably prefer to retain men on their permanent staffs who can take charge of the details of plan-making and co-ordinate these with the desired economies in construction proper. They will, on the other hand, welcome the outside advice of the consulting specialist in regard to site planning; large-scale de-

sign and criticism respecting rents and facilities furnished in projects to be developed in relation to neighboring properties.

The experienced architect in large-scale investment housing should also find an available field as consultant with city planning commissions; and housing authorities should be of real value in interpreting the aims and ideas of public planning bodies to development corporations, as well as to interpret the immediate objectives of the development corporations to public authorities and planning commissions.

—**ARTHUR C. HOLDEN, Holden, McLaughlin & Associates, New York City**

I MOST heartily agree with Miles Colean. Privately financed, large-scale housing, in order to be successful, will require studies of all the factors that will affect the ultimate results: coverage, grouping, height, orientation, typical plan, sizes, relation and number of rooms, style of elevation, fenestration, type of construction—general and of details inside the apartment and in public spaces—mechanical and sanitary equipment, finish of surface—all of which must be considered as they affect appearance, initial and ultimate costs. Also organization and planning of the free spaces, urban and social approach to the project. A proper co-ordination and interpretation of such studies seems to me the proper function of a well-trained architect.

The great danger of such studies by organizations or bureaus lies in the fact that their tendencies would be one-sided, leaning too much to the technical or to the financial or to the social, depending on the setup of the organization.

Someone must be found with the proper balance appropriately to weigh the different aspects of a large-scale housing problem. Perhaps I am biased; but I believe that nowhere will the problem receive a better study than in a well-equipped, well-staffed and well-directed architect's office.

—**J. ANDRE FOUILHOUX, Harrison & Foulhoux, New York City**



THE FIELD of privately financed large-scale housing is not a *new* field for architects who had been engaged in multi-family housing with a high degree of success until the general collapse of 1929. The crash in the building industry was a child of no particular parentage—certainly not the architects—and it is manifestly unreasonable to hold architects incompetent to produce good housing economically because a dizzy decade of land speculation, unsound financ-

ing and excesses in merchandising, contracting and labor regulation unbalanced the industry engaged in the production of shelter along with all other industries.

Sound, economical housing must be large-scale. Sound, economical housing means, essentially, good planning, good construction, and full use of the products of mass production plus reasonable land values and banking charges.

Housing is the architect's domain.

He can and will produce sound economical housing if given proper cooperation by the banker, realtor, material manufacturer, contractor and labor.

Whether he will be the leader or only the employee in the development of the housing of tomorrow will depend on the architect himself—certainly, there will be no good housing without good architects.

—HENRY DUBIN, Dubin & Dubin, Chicago, Illinois

## PRIVATELY BUILT, SINGLE FAMILY HOUSES



AT A RECENT conference on conditions in the small house field, Kenneth W. Dalzell, chairman of the AIA Committee on the Small House Problem, made the following observations. Though he is chairman of this committee, the opinions offered by Mr. Dalzell are strictly his own—not the committee's.

"The traditional methods of professional procedure and practice are costing archi-

tects leadership in certain fields of building—especially in the small house field. This leadership is being assumed by realtors and promoters and, in consequence, professional architects are becoming, in the majority of cases, only designers.

"How can this situation be successfully combated?

Personally, I offer two suggestions:

"1. Architects should revert to the old system of awarding contracts, but at a higher additional fee than the 4% now recommended by the Institute. I consider this figure entirely inadequate for the services which must be rendered.

"2. Architects should recognize the desirability of again becoming—in reality—*master builders*. They should be encouraged, particularly in the small house field, to deliver to the buyer a complete 'package' for a definite contract price. This should include fees for design, finance, overhead, and costs of labor and materials. Such a procedure would enable architects to approximate most completely the combined services now offered owners by the speculative builder and realtor. Any competent architect should produce, by this method, a better house at a lower price.

"This latter recommendation, by the way, is not original with me. It merely suggests, for this country, a practice that is being successfully followed in some other countries."

**QUESTION: Do you agree with Mr. Dalzell that architects can capture leadership in the small house field by awarding separate contracts at increased fees, or by offering complete building services as a "package" to the owner?**

I HAVE NO quarrel with the desirability of Mr. Dalzell's thesis. It seems to me that there should be first ascertained the conditions in the community under consideration. The vast majority of residences in Buffalo and vicinity are being built either from the builder's own plans or from plans procured from architects who furnish them for from \$25 to \$125. These are not what one ordinarily calls stock plans, but are usually drawn to the builder's requirements. For the money they are a good value; as instruments of service they are sadly insufficient.

The architects who are preparing

plans for the speculative builder are no more furnishing architectural services than would the physician furnish medical service if he permitted the druggist to prescribe the medicines.

Our local plan—which is rapidly approaching completion and which will soon be ready for public announcement, hopes to sell to the prospective home owner a complete, well-drawn set of plans and specifications, six inspections, and a certificate of compliance on completion of the home for a fee of about one-half to one-fourth of that which would be required for the type of service which Mr. Dalzell recommends. The service

will not appeal to everyone, and will be limited to homes costing \$10,000 or less. In a small way we hope by our program to bring the architects into control of the building operation.

—JAMES WILLIAM KIDENEY, Paul Hyde Harbach & James William KideneY, Buffalo, New York

I DO NOT agree with Mr. Dalzell's first suggestion, because I believe that anything which would increase an architect's fee would definitely lessen his chances for employment at all. Furthermore, I do not believe the small house architect can control or award

the various subcontracts, because most of the small houses are being done in groups of ten or more, using day labor instead of subcontractors.

I do agree with the intent of the second suggestion, but do not believe it can be accomplished by the architect in the *small* house field. We have successfully used this procedure for houses in the higher bracket. But in the small house field, where *price* is the essence, the requirements are a volume of similar houses, careful buying and job efficiency.

Now, the average architect would rarely have the opportunity of creating such a volume with *individual* clients and therefore could not eliminate the promoter-developer-contractor who controls volume.

Furthermore, the architect, by nature, gives the small house client so *very* much more than he would be extremely happy with, that his buildings cannot compete in price with those executed by the unappreciative untrained group.

—ARNOLD SOUTHWELL, Miami Beach, Florida

IN REGARD to Mr. Dalzell's two suggestions, it is our opinion that the first one is particularly good for those of us who do not want to realize that, in this world of coercion and propaganda, the day has arrived when the architects are not only not able to establish themselves in their proper position, but are even unwilling to fight for it.

The "old system" never did establish us in the small house battlefield in the old days and it isn't going to establish us in the new days.

The idea of functioning as agents in the lower economic groups and offering our services on a person-to-person basis is as obsolete as the idea of scattered building for this group.

It is our opinion that the solution to the small house problem is in large-scale effort based upon standardization and directed by the architects whom the psychology of ornament has not overwhelmed.

This is a bewildered world; and although every person or group of

persons in the building industry is lending his efforts, unwittingly or not, to the general confusion, one fact is certain; and that is, that the general senility and impotence of our profession has deprived it of a splendid opportunity of being something more than just the "guy" who sews the lace on the nightgown.

We can succeed in the small house battlefield only by placing ourselves in the key positions, doing the men's work, demanding the men's pay and thinking a few of the men's thoughts.

Mr. Dalzell's second suggestion meets our opinions, more or less. Less, if he is speaking of single houses; more, if he is thinking of groups.

—RUSSELL SIMPSON, Hays, Simpson and Hunsicker, Cleveland, Ohio

FOR MANY obvious reasons, small houses for people of moderate incomes should be constructed in large numbers, one of the reasons being that large operators can turn their backs on the small, incapable, substandard builder and specialty manufacturer who tries to "muscle in" on the small man.

Business men of means who look upon their house as a home rather than a smart investment prefer to pay their architects directly for impartial professional service rather than employ one who participates in the profits of construction. But inexperienced people with small budgets should buy their homes from these reliable operators. The competent advice from a capable appraiser, and not high-pressure selling, should influence the buyer and will give him the protection that he could not otherwise afford to have.

—RANDOLPH EVANS, New York City

I AM IN entire agreement with the thought that the architect cannot be effective in the small house field if he insists on practicing in the manner customary and desirable in the field of larger buildings. The proof of this lies in the fact that the vast majority

of small houses never see a responsible architect until after completion, when he happens to go by and scathingly denounces their lack of architectural sense.

It is my feeling that small houses must be designed, *planned and built* in groups by competent organizations if they are to be economically and aesthetically successful. In the formation and management of such organizations, the architect should take a leading, if not *the* leading, part. This may well mean an enlarging of the architect's scope; it may also mean a complete shift in his methods of practice. I can see no real lowering of dignity in this. Aloofness in this field means impotence and that is scarcely to be preferred to an imaginary loss of dignity.

—ROBERT W. McLAUGHLIN, JR., Holden, McLaughlin & Associates, New York City

I DO NOT agree with Mr. Dalzell, because: (1) I do not believe that architects ever had the leadership in the small house field; (2) I do not believe the methods he suggests would help to obtain that leadership.

I believe that architects can obtain leadership in the field simply by salesmanship. We are living in a period dominated by salesmanship. I believe that it is obvious to any owner, when the facts are presented to him, that an architect can secure for him a better home for less money than can a contractor or realtor. (I am assuming that the architect is competent and giving the service he should; such is not always the case.)

The day of the "mousetrap" idea is gone. You must have a superior product and *the public must know about it* or there will be no beaten path to your door. How an architect's service can be sold to the public, I do not know. I do know this: that the great majority of owners would employ an architect if they knew the facts. Our problem is to get the facts to the owner before the contractor has sold him.

—JAMES A. SPENCE, Frantz & Spence, Saginaw, Michigan

## IN THE HOUSE OF REPRESENTATIVES

FEBRUARY 16, 1938

Mr. WEARIN introduced the following bill; which was referred to the Committee on Public Buildings and Grounds and ordered to be printed

**A BILL**

To provide for the procurement of architectural services for public buildings and memorials by anonymous competition.

1 *Be it enacted by the Senate and House of Representa-*  
2 *tives of the United States of America in Congress assembled,*

3 That section 2 of the Public Buildings Act of May 25, 1926,  
4 as amended and supplemented (U. S. C., 1934 edition, title  
5 40, sec. 342), is amended by adding at the end thereof the  
6 following subsection:

7 “(d) Notwithstanding any other provision of law, in  
8 the cases of new buildings involving an estimated construc-  
9 tion cost in excess of \$100,000, contracts for the construc-  
10 tion of which are awarded pursuant to invitations for bids  
11 issued after the date of enactment of this subsection, the Sec-

2

1 retary of the Treasury shall obtain designs, drawings, and  
2 specifications for any such building, and local supervision of  
3 the construction thereof, by anonymous competition, open  
4 to all qualified architects, subject to such conditions as the  
5 Secretary may prescribe. Designs, drawings, and specifica-  
6 tions so procured shall be subject to such modifications relat-  
7 ing to plan or arrangement of the building and selection of  
8 materials as may be directed by the Secretary. Costs of  
9 such competition and payment for services so procured shall  
10 be appropriated for as part of the cost of the building.”

11 SEC. 2. Plans and architectural services for all monu-  
12 ments, statues, memorial buildings, and other structures here-  
13 after authorized to be constructed under the direction of any  
14 special commission or agency, executive or congressional,  
15 established by the Congress, shall be selected by anonymous  
16 competition open to all qualified architects, subject to such  
17 conditions as the commission or agency may prescribe.

# Open Competitions — or Closed Politics?

**Douglas Haskell discusses the Wearin Bill and highlights the trend toward competitions as a means of selecting architects for public works.**

ABOVE IS the “Competitions” bill. At the forthcoming AIA convention at New Orleans it is sure to command a great deal of attention. Its sponsor is the National Competitions Committee, an independent group of architects including men well known in the profession, among them Leopold Arnaud, Paul Cret, Walter Gropius, Talbot Faulkner Hamlin, Henry Hornbostle, Joseph Hudnut, Ely Jacques Kahn, A. Lawrence Kocher, Philip N. Youtz and many others. The chairman is Henry S. Churchill, the secretary William Lescaze.

The gist of the bill is that all U. S. Treasury-built public buildings and all monuments of any magnitude must be submitted to competition, such

competitions to be open, anonymous and not limited—with the one restriction that competitors be architects legally qualified, and the requirement (yet to be written into the bill) that the successful competitor be given the job.

Still in the formative stage is a measure referring to competitions for painting and sculpture. It has not yet been introduced as a bill, but the Competitions Committee hopes that it will ultimately contain the same general provisions that characterize H. R. 9528.

With the Wearin Bill there comes into focus a recent trend toward public competitions. The immediate background of the bill is the controversy over the Jefferson Mem-

orial; the Committee hopes to prevent the recurrence of such episodes.

Most architects are familiar with the Jefferson Memorial developments in broad outline. Congress appointed a memorial commission, which in turn appointed an architect of its own choice, the late John Russell Pope. To Congress there was brought back not a tentative proposal but a complete scheme ready for immediate execution. Though the commission, in thus taking the full conduct of the enterprise into its own hands, protected its chosen architect against haggling and interference, it proved unable in the end to secure acceptance of his concept in a lump.

Discussion had been delayed but was all the more vehement. The

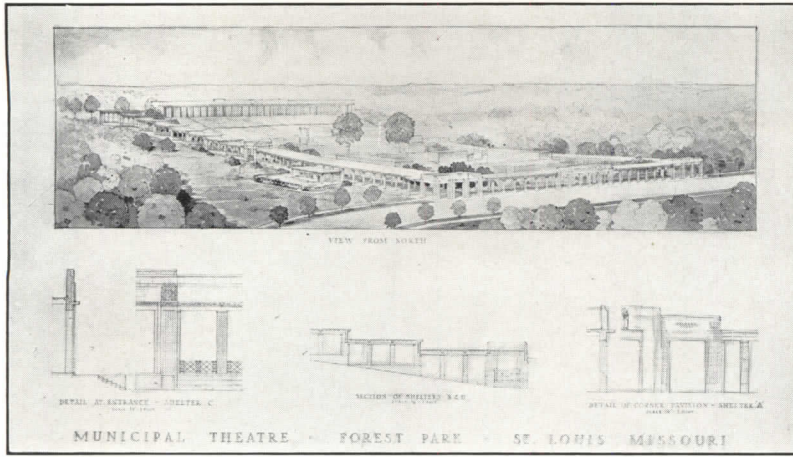

Pleitsch and Price, Architects; 2nd Prize, \$500

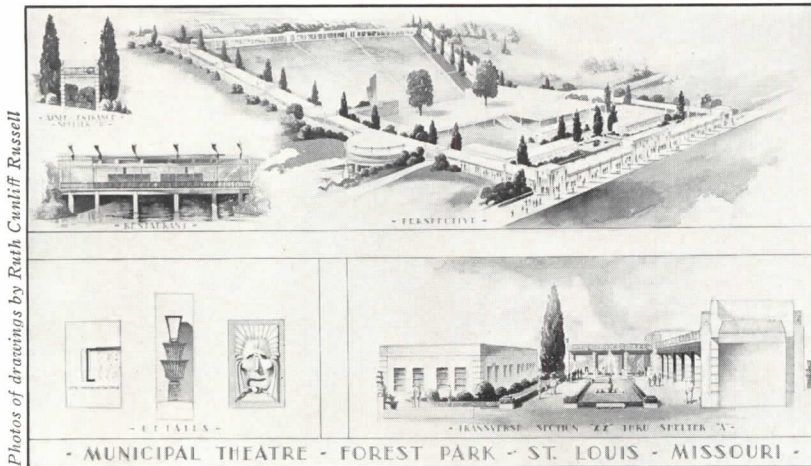

Photos of drawings by Ruth Cunliff Russell

Charles T. Wilson, Architect; 3rd Prize, \$300

Typical of a well-regulated competition to select an architect for a public structure was that recently conducted by the Municipal Theater Association of St. Louis, Mo. (see pages 66 and 67 for illustrations and story of 1st Prize winner). This was an anonymous two-stage competition approved by the AIA, open first to all St. Louis architects and finally restricted to ten entrants selected on the basis of preliminary sketches. The winner was awarded the contract as architect for the project. All second-stage entrants were paid at least \$100.

storm of protest was directed not against the competence of the architect in his own chosen idiom—his ability was unquestioned—but against the wisdom of making the memorial a monument at all; against the idiom of the design as such, and as an expression of Jefferson; and finally against the commission's "high-handed" procedure in pressing for quick acceptance without debate. In short, the objections were against aims and general concepts.

If the Commission stood for the authoritative rule of experts, its critics—chiefly gathered in an improvised League for Architectural

Progress—stood for democratic control over objectives. At present writing the Jefferson project is quiescent, apparently not so much because of the architectural discussion as because of Congressmen's fears arising from public resentment at the ruthlessness of the scheme against its beloved cherry trees.

The National Competitions Committee is the outgrowth of the League for Architectural Progress. But competitions have come to recent public attention in connections other than this. In 1936, the open competition for the State Capitol of Oregon brought on the lively controversy

usually associated with such events and the consequent public airing of architectural views. The winning design, as usual, had its critics and defenders. Some of the discussion had significance beyond the event. It hinted at the success, in competitions, of a type of architectural demagoguery aimed at the foibles of juries, as political demagoguery aims at the foibles of voters. If the architect was not to know the composition of the jury in advance, he stood to lose a lot of time on designs they would never pass—for example, drawing "modern" designs for a "conservative" jury. On the other hand, knowing the jury, architects would be tempted to address themselves to its known prejudices rather than to the problem. At best, in the words of Frank Lloyd Wright on another occasion, a jury judgment was the "average of an average on an average."

Against this intrinsic weakness of the method there was cited the fact that in public competitions which arouse controversy, the "opposition" can always give its arguments force by means of concrete alternatives expressed in definite plans; it is not reduced to appearing merely vindictive or destructive. Such uncrowned schemes can have strong and beneficial influence on the plan finally adopted for the building. Again, like the famous minority opinions of the Supreme Court, such plans may lay a firm foundation for future victories of new but sound points of view.

The most famous victory for such a "minority" report was won not in a competition for public building, but in the case of the Chicago Tribune. The second-prize design of Saarinen, a new man brought by the competition into sudden prominence, deeply affected all future skyscraper building, including the later designs of Raymond Hood, who had been proclaimed the Tribune winner.

In the Oregon Capitol case, the criticisms warranting the closest attention of all were those concerned not with design but with the method of procedure. The jury, mainly non-professional, arrived at its decision in the record time of 18 hours and returned all but the winning drawings with unexampled speed, thus dispersing evidence generally accepted

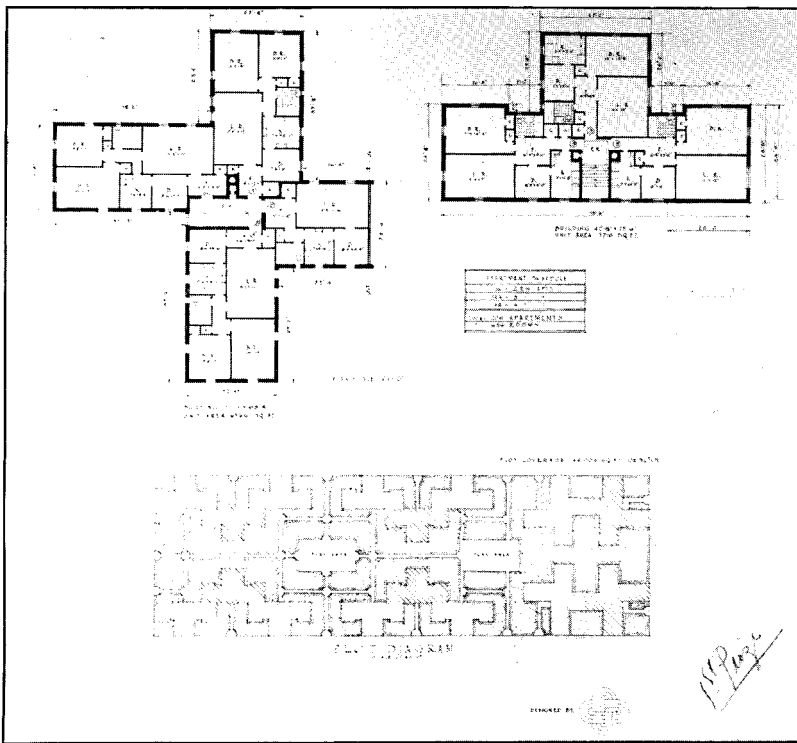

Informal competitions on matters of current professional importance are held from time to time by the N. Y. Society of Architects. Typical of these—which are anonymous, and open to all N. Y. City architects, but carry only certificates of merit as prizes—was that recently won by Charles H. Sacks, of Brooklyn, N. Y., whose entry is shown above. The program called for a unit layout and plot plan of a 4-story, low-cost apartment conforming to the new Building Code and all other building regulations of New York City.

as necessary both for public and expert review of the jury's own work. Moreover, only part of the program had been submitted to the AIA and secured its approval.

In view of the importance of having a sound competition method, casual readers may be surprised that the Wearin Competitions Bill is not more specific in directing procedure in detail. The sponsors answer that serious debate of this question led them to avoid too intricate a legal machinery as a menace to success. Enforcement within the meaning of the act, they say, must in any case depend ultimately upon the alertness of the profession itself. Putting full details into the statute would only open the way to dissensions in the backers' ranks, would stand in the way of improving competition technique with much needed experience, could be used by hostile administrators to pile up difficulties and might

lull the profession into false security. "If the profession is too inert to secure control of the machinery through the AIA Code and administrative procedures," writes Mr. Churchill, chairman of the committee, "it's just too bad, and fiats from Sinai would not help." The inclusion of a provision guaranteeing that the winner be given the work is promised when the Bill goes into committee.

Activities of the National Competitions Committee are somewhat at variance with those of another professional body—the AIA Committee on Public Works, headed by Francis P. Sullivan. In the past the policy of the latter group has been against legislation in favor of hopeful persuasion as a means of getting Government to recognize more completely the value of architectural talent in the production of public works. No firm basis exists for a statement that the AIA committee has been—or is—

against open competitions as a means of achieving this end. But action to date reflects a policy far from militant in favor of competitions and, according to an impressive body of professional opinion, one that is both tedious and ineffectual so far as tangible, widespread results are concerned.

Mr. Sullivan's committee has apparently been spurred by introduction of the Wearin Bill, for it has drawn up a counter proposal. This, as a basis for a substitute bill "to please everyone", is still tentative and not yet ready for release. In its present form, however, it does not include the provision that the National Competitions Committee deems of paramount importance—anonymous competitions open to all qualified architects.

Whatever the fate of the Wearin Bill in the Congress or in the discussions of the AIA, it is pertinent to remark that provision for competitions falls into a trend that is international. Indeed, England and Germany rarely award public work on any other basis than competitions; and with growing experience they have developed very much simplified procedure, avoiding especially the great bugbear of elaborate "competition drawings."

Proof that on occasion public competitions in the United States can be conducted with greater satisfaction all around than chanced to be the case in Oregon is afforded by the famous competition, in 1925, for the State Capitol of Nebraska. The White House was a competition building; so was the New York City Hall and the Washington Monument. The designer of the Monument, Robert Mills, based his career as "first American-born architect" on this and other competitions. Among recent or living practitioners well-known to their associates, not only Goodhue gained prominence through competitions, but Paul Cret, Cass Gilbert, Harvey Wiley Corbett, and a number of others, not forgetting John Russell Pope himself.

Those interested in further information on the bill can write to the National Competitions Committee for Architecture and the Allied Arts, Box 493, Grand Central Annex, New York City, or to Congressman Otha Wearin in Washington.

# Effect of Air Conditioning on Building Design

By **A. WARREN CANNEY**  
Air-Conditioning Consultant

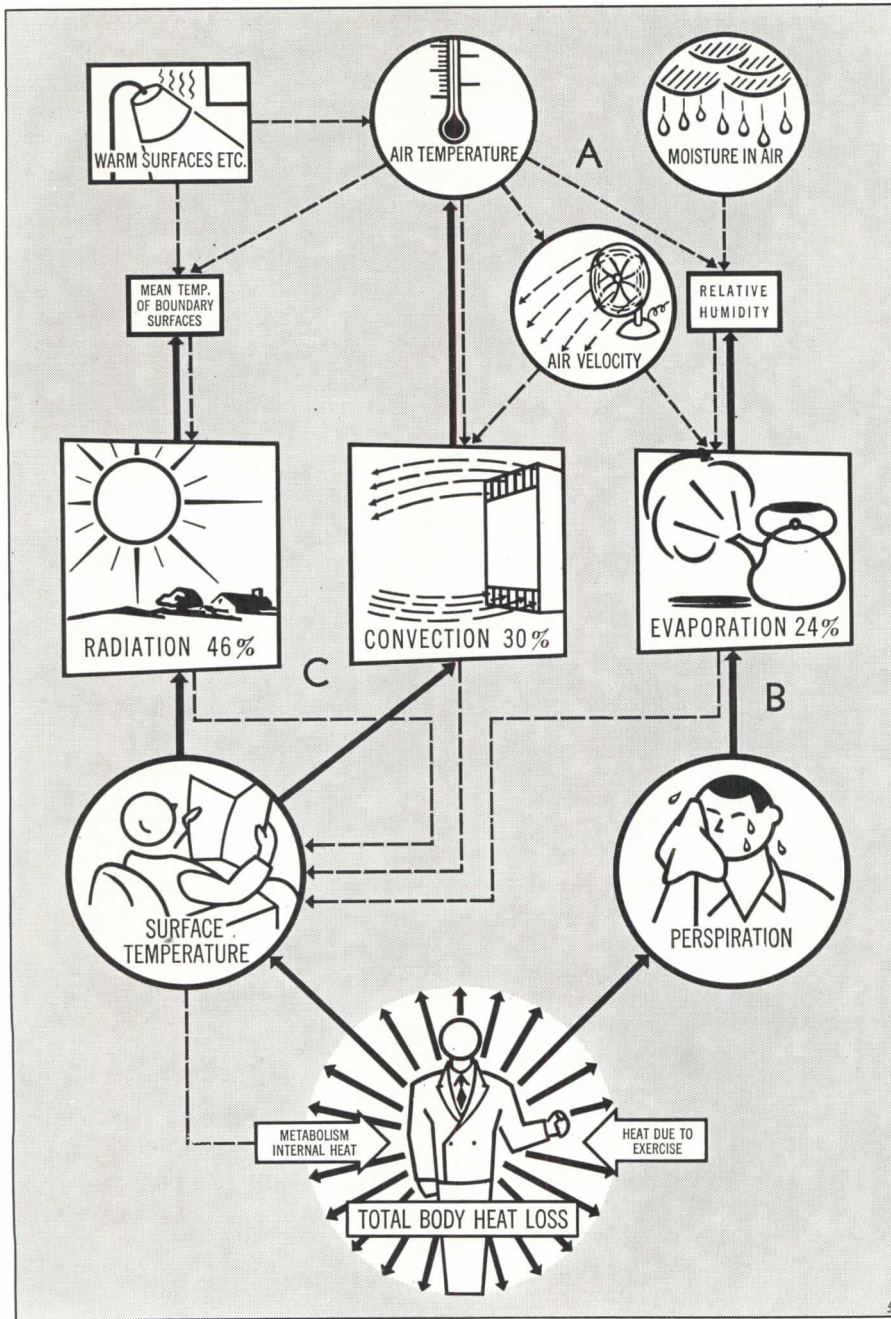

Figure 1: Solid lines and arrows indicate how the human body loses heat; dotted lines show how air conditioning influences these heat losses by controlling factors shown in circles at A. Percentages for radiation, convection and evaporation are approximate averages for an adult standing still, as developed from studies at the Smithsonian Institute by L. B. Aldrich and reported in the Institute's publication, "A Study of Body Radiation." The rate of evaporation (B) is different for each individual, varying with the amount of exercise. Rates of radiation and convection (C) are constant for each specific thermal environment. To maintain comfort conditions, the total heat generated by the body is balanced by the total heat loss according to restrictions imposed by surface temperatures and air-conditioning factors.

THE INFLUENCE on building design of any system for maintaining comfort conditions is governed, generally, by three broad classifications. These indicate the relation between the mechanics involved and the building design in terms of desired results. They are:

*First:* Relation between spatial characteristics and methods of air distribution.

*Second:* Relation between thermal characteristics of construction and operating characteristics of any comfort-conditioning system.

*Third:* Relation between economics of building design and the mechanical operation of the system to produce a balance between over-all costs and operating expenditures.

In the February issue of the RECORD the first of these relative conditions was discussed. Desirable standards for air distribution were noted in terms of velocity, rate of air change, room volumes and shapes as factors of satisfactory diffusion and outlet arrangements to meet a variety of practical conditions. In addition, the article pointed to the fact that these three classifications were interdependent, all being important as factors of any specific problem in economical comfort conditioning.

The phrase "comfort conditioning" is substituted here for the narrower term "air conditioning", because the end-objective of air-conditioning mechanics is maintenance of human comfort under a variety of physical and social conditions. To produce this comfort the conditioning of air itself—involving relative humidity, temperature, velocity, cleaning, etc.—constitutes only one part of the problem. The other—often of great importance, both technically and economically—might be termed "struc-

**This is the second of two articles dealing with the spatial and structural relationships necessary to maintain comfort conditions in modern air-conditioning practice. The first article, published in the February, 1938, RECORD, discussed the influence of air-conditioning installations upon the size and shape of interiors. This one is concerned with the part that building construction plays in producing comfort, particularly as it involves means for maintaining desirable temperatures of interior surfaces.**

ture conditioning", a term suggesting the means used to develop interiors that permit a simplification of mechanics for producing comfort conditions and a consequent increase in the economical efficiency of the entire system.

The fact that every part of the problem is directly related to the biology of human beings cannot be too strongly reiterated. Normal requisites for human comfort are shown in Figure 1, which also tells a great deal about the problem of comfort. This diagram indicates how control of air governs comfort, why air temperature plays a major part inside an enclosure and where body radiation (responsible for 46% of our comfort) fits into the picture.

The diagram discloses, also, the basis for the fact that, since the air temperature in conjunction with air distribution controls wall, ceiling and floor surface temperature of an inside room or its well-insulated equivalent, the control of air temperature alone (with good air distribution) does over 80% of the job of establishing comfort under such conditions.

However, when air temperature is normal and all boundary surfaces are at the same temperature, the actual humidity content of the air occupies a minor, though obviously important, place in the composite picture of comfort control. Radiation is the most important factor. And, because this is so, the blunt message presented by Figure 1 is that indoor comfort really begins with building design and can only partially be produced by mechanical equipment.

As noted in the February article (see pages 72 and 73), the construction of buildings to provide controlled indoor comfort must recognize two distinct problems:

1. *The temperature limit of the inside room surfaces of exterior construction.*

2. *Control of room-air temperature to compensate for heat losses or heat gains, according to the season.*

The effective temperature produced by an air-conditioning system can produce satisfactory comfort for an occupant in a room within the center of a building. With cold weather outside, this same effective temperature in an outside room, having an exterior wall largely of ordinary glass, would cause the occupant to feel chilly unless the air were discharged so as to heat the glass surface. Otherwise, heat loss from the body by radiation would be excessive.

If the glass were replaced by a 1-in. thick cement slab, heated by embedded pipes or electric wires to maintain the inside surface of the cement at 70° F., the occupant would be comfortable for two reasons: body-heat loss by radiation would be restricted to a comfortable value of roughly 200 Btu. per hr.; and no cold down-draft convection air currents would be present.

When walls and windows provide adequate insulation value of their own, both of these problems disappear from the requirements of a mechanical system for controlling comfort in an inside room. Thus, with the exception of correctly designed radiant heating, we discover that the lower the insulation value (particularly in cold weather) the greater the necessity for having a mechanical system to control the temperature of surfaces. This is a required function of the system in addition to sustaining of air temperature when insulation value is poor.

Figure 2 shows the inside surface temperature of several materials and

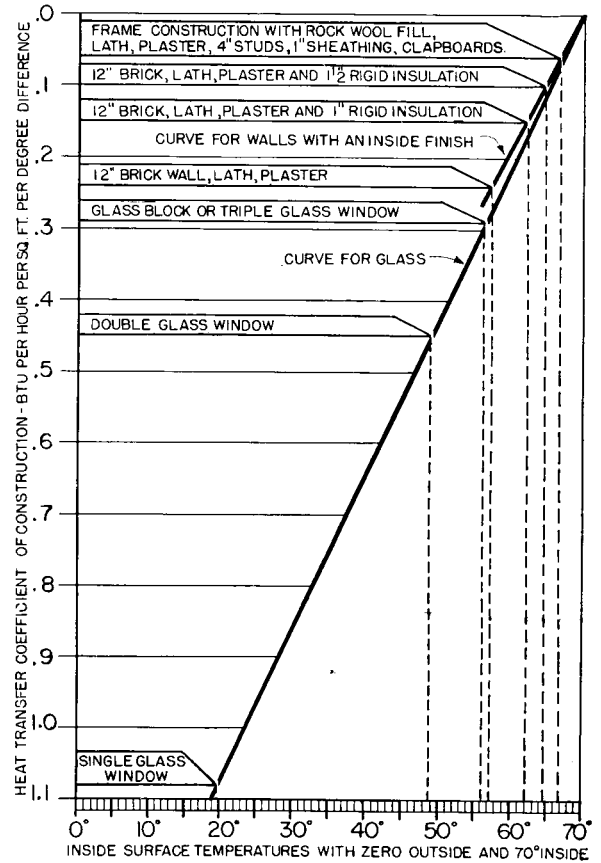

Figure 2: This chart shows, comparatively, how the insulation value of wall construction and window areas predetermine inside-surface temperatures in winter. Numerically high heat-transfer coefficients should be avoided because they establish low insulation values. With such low values, inside-surface temperatures vary too much from room-air temperature, thus causing excessive fluctuations in body-heat loss through radiation. It is the prime function of mechanical equipment to prevent this condition when wall insulation values are low.

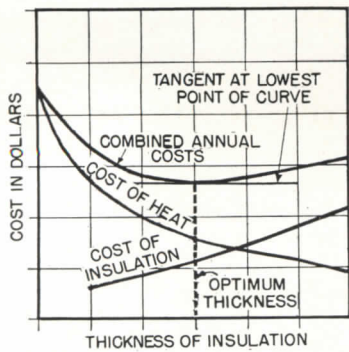
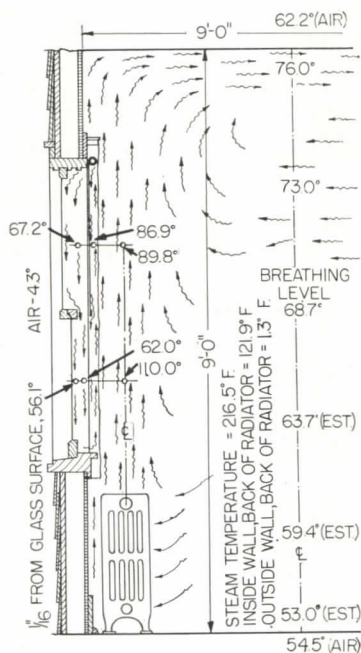

Figure 3: A method of determining graphically the most economical thickness of wall insulation. As thickness of insulation increases, installation costs rise. At the same time heating costs decrease. If cost curves of each and a curve of the combined costs are plotted, a perpendicular (shown dotted) from the low-point tangent of the combined cost curve will determine the most economical thickness of the type of insulation chosen. Heating and insulation are thus economically balanced, for at the tangent point costs of both are minimum.



Adapted from "Heating and Air Conditioning Manual" by L. A. Harding—copyrighted, 1935, by Louis Allen Harding.

Figure 4: This diagram illustrates the difficulty of raising the inside-surface temperature of single-glass areas to an adequate level. To make it both practical and economical to raise surface temperatures by a radiator or warm-air supply, wall construction must be insulated and window areas at least double-glazed and sealed to prevent air leakage.

constructions in a room indirectly heated to 70° F. when it is zero outside. The lower the *insulation value* of the construction, the colder the inside-surface temperature. The considerable spread between walls and single-glass windows tells the story, if it is realized that in a room which is near a window, and which is unheated except by the maintenance of an air temperature of 70° F. a few feet away, an occupant's heat loss by radiation is increased by 20 to 25% in excess of the normal total.

The importance of establishing inside-surface temperature of exterior construction within a limit approximating air temperature is apparent when it is considered: first, that the body, when comfortable and resting, loses by radiation *nearly half* its total heat to surroundings; and second, that radiating this high percentage *depends on the small average temperature-difference of only about 13°*. (The average surface temperature of a clothed person is about 83°; the wintertime average of all inside surfaces of a comfortable room is 70°; 83° — 70° = 13°.)

The influence of room size in relation to the area of cool surface may be clarified by considering two hypothetical cases: Visualize two cubical rooms, one 10 feet on each side and another 50 feet on each side, both of the same wall construction, each with one exterior wall, zero outside and a 70° air temperature inside sustained by an indirect heating system. There is but one window in the exterior of each room, without a radiator or other warm-air supply nearby. An occupant in the center of the smaller room would probably feel chilly; but an occupant in the center of the larger room, or even in the vicinity of the window would not be chilly, because of the small percentage of cool surface.

*The important thing to realize is that all of these conditions, under any setup, can be predicted by sufficiently accurate analysis.*

The real solution of indoor comfort in exterior spaces does not necessarily lie in the creation of conditions which require considerable compensatory measures of a mechanical nature, but rather in limiting the magnitude of the conditions which heating or cooling systems have to offset.

As an extreme example, it may be said that a windowless structure simplifies greatly the problems of heating and air conditioning. By replacing single-glass membranes with glass block, these advantages were realized recently when air conditioning was installed in an existing building. *Where exterior spaces are provided with an air supply which "covers" the glass block, the effect of such a substitution is to eliminate pipes, etc., from the periphery of the structure, thus removing the necessity for mechanical equipment at sills. All functions of comfort control are met by the same mechanical systems located, for the most part, toward the interior of the structure.*

The insulating value of windows, and consequently their inside-surface temperature, may also be raised by double-membrane glass. The effectiveness of double-membrane windows is shown by Figure 2. Since most existing windows are designed for ventilation, one might expect attention to novel means of attaching removable inner glass with an effective seal.

Where the desired daylight area is large, it seems reasonable to look forward to an increasing use of glass block in walls having "windows" of small transparent double-glass casements. It has not been possible to locate a precedent for determining the practicability of double-glass blocks. Thermally, an ideal wall could thus be provided with a heating element, possibly electric, in the air space between the blocks. With such an arrangement, theoretically considered, it would not be necessary for an air-conditioning system to limit surface temperature while "taking up" on any heat loss. With single or double glass, the advisability of radiators should receive careful attention.

If a single all-purpose mechanical system is to be installed, a high insulation value of all exterior construction is essential—not only for desirable efficiency but for economical operation of the system as well.

The same heating element cannot be used to maintain the inside-surface temperature of poorly insulated construction at a constant value of, say, 70°, by air currents, with the simultaneous employment of the same air currents as a heating means to control air temperature.



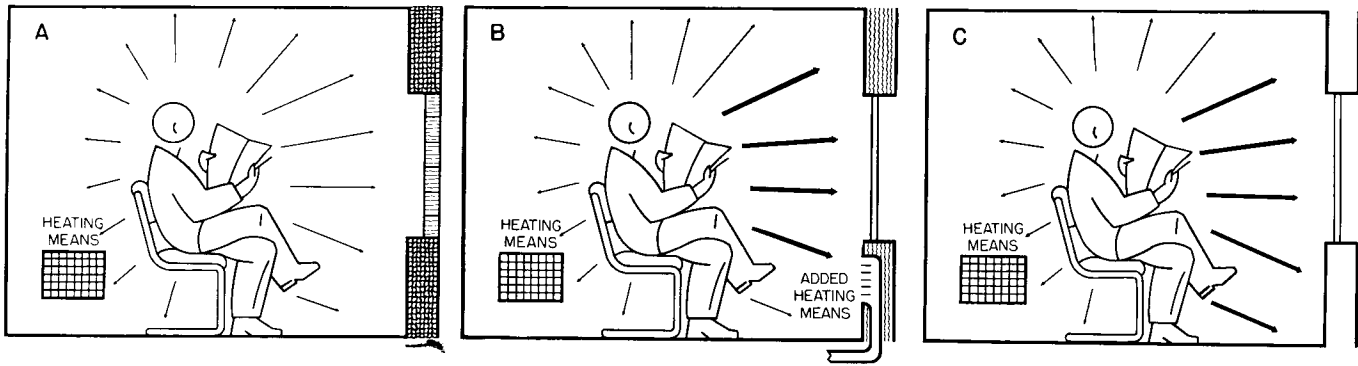

**Figure 5: Insulation of exterior construction influences radiant heat losses by helping to control inside-surface temperatures. In A, high insulation values give adequate surface temperatures. In B, low insulation values require added heating means to maintain satisfactory surface temperatures. In C, absence of insulation produces relatively cold interior surfaces that quickly absorb radiant body heat.**

But if insulation value is economically adequate and if air distribution is properly designed, undesirably low surface temperatures in winter can be avoided.

Figure 3 shows the *types* of curves which yield the most economical thickness of wall insulation in the form of a rigid or blanket material to be added to any selected conventional wall construction.

There are three significant facts in regard to engineering economics thus applied:

1. Insulation proportionately related to heating and cooling plant capacity can produce a saving in dollars and cents for at least three-quarters of the life of the structure.

2. When insulation of an economic thickness is added to usual wall constructions, the air-circulating system is able properly to maintain an inside wall surface temperature at substantially room-air temperature, without the elaborate equipment otherwise required to give the same result.

3. Comfort is increased, the condition known as "cold-70°" being eliminated so far as the walls are concerned.

Regarding single-glass windows, Figure 4, adapted from data of L. A. Harding, heating engineer, shows measured temperatures at various points with an ordinary radiator set-up. Under test conditions a vertical air layer of 110° keeps the glass surface at a temperature of less than 56°.

The layer of warm air in front of a window does not in itself impede the radiant heat loss from an occupant to the cool inside glass surface.

Therefore, it is important that a radiator or hot-air supply be installed at the base of a window, in order to heat the glass. But it is not only uneconomical, but impractical, to attempt heating the inside surface of single-glass windows to normal room-air temperature.

The vogue in Europe for radiant heating takes cognizance of this difficulty by attempting abnormally to restrict body-heat loss in directions other than cool glass and walls, in order, by a compensating effect, to restrict the total heat loss from occupants to a comfortable level. The ideal place for embedded warming panels or pipes to sustain inside-surface temperature is within the exterior construction.

From the foregoing it is possible to classify solutions to the distinct problems of inside-surface temperature of exterior construction and room-air temperatures. These can be:

*First:* Perfectly solved when insulation values of both walls and glass areas are high.

*Second:* Satisfactorily solved when wall insulation is of low value, but when separate mechanical means are provided for controlling inside-surface temperatures of exterior construction in addition to temperature of room air.

*Third:* Imperfectly solved when economic insulation values are neglected.

#### Heat capacity of walls

The heat capacity of walls is an important economic consideration, particularly where buildings are intermittently reheated or re-cooled

from day to day. For example, 16" of concrete plus 1½" of cork has virtually the same heat *transmission* value as 2" of cork plus 1" of concrete; but the former has 15 times the *heat capacity* of the latter.

Maintenance of inside wall surfaces at temperatures equal—or very nearly so—to the room-air temperature has already been noted as an important function of any "comfort-conditioning" system. But to accomplish this economically the *mass* of walls should be as little as possible consistent with high *insulation value*. Walls of massive construction invariably have greater heat capacities than those of lighter character and require, therefore, proportionately more thermal energy to bring the temperature of their inside surfaces to the desired level. Generally speaking, the lower the mass of exterior construction, the lower the cost of maintaining proper inside-surface temperatures—provided, however, that insulating values are equally high.

#### Sealing against air leakage

Satisfactory comfort conditioning requires a constant balance between desirable extent of air conditioning and the physical factors that have an influence upon the operating efficiency of the system. Prevention of infiltration and exfiltration is important in this connection. Wind pressure that operates through wall constructions or through window and door cracks will unbalance a system of air distribution, room-air temperature or interior wall surface temperature. To seal a structure against wind pressure is often as difficult as to limit the air

pressure caused by the height of tall buildings.

Infiltration should be particularly guarded against by equipping doors and windows with adequate weatherstripping. At ground-floor elevator vestibules in tall buildings a revolving door would probably soon pay for itself in air-conditioning economy. And in all shafts, stair wells, pipe chases and continuous hollow wall constructions, cutoffs—or air seals—should be made at frequent intervals.

#### Reduction of heat from sunlight

The sunlight load may prove a factor of importance in reducing total cost of an air-conditioning installation. But here is an interesting fact: if a sunlight load constituting 20% of the refrigeration capacity is reduced by half, the installed refrigeration capacity will usually admit *not* of a reduction by 10%, but of something less than 10%. On one small job, the plant may not be reduced at all, while on another it may be cut as much as 20% through attention to sunlight reduction. As in most thermal problems, the economics must be worked out for each situation, balancing the cost of treatment to favor a net yield against reduction in plant and reduced operating expense.

Glass block windows tend to reduce transmission of sunlight. Exterior metal awnings outside single windows are thermally better than unshaded glass blocks and also cut out much more sun than inside shades.

When double windows are used, borosilicate heat-absorbing glass should be considered for the outside. The economic worth of single heat-absorbing glass is questionable, since this glass becomes hotter than the ordinary glass and re-radiates heat partly to the inside unless an inner pane shields it.

To maintain comfort conditions during warm seasons, the same control of inside-surface temperatures must be exercised as that noted for cold weather. The purpose of using materials for limiting sunlight load is to prevent excessive restriction of body heat by radiation. This permits simplification of mechanics that control inside temperatures to achieve the desirable close relation between the summer temperatures of inside surfaces and room-air temperatures.

For the same material, the following colors influence the amount of solar radiant heat reflected, decreasing in the order listed, a black surface just about doubling the absorption of a smooth white surface:

- |                          |               |
|--------------------------|---------------|
| 1. White, smooth surface | 5. Brown      |
| 2. Gray to dark gray     | 6. Dark brown |
| 3. Green                 | 7. Blue       |
| 4. Red                   | 8. Dark blue  |
|                          | 9. Black      |

But color alone is no criterion. For example, a polished green is better than a flat white; polished aluminum is superior to aluminum paint; and black lacquer, sprayed on, is experimentally found better than snow-white enamel on iron.

The color of inside shades is an important consideration. Four years ago, parts of a large job were inadequately conditioned until a different color was applied to the outside surface of the shades. Before this change was made, the total heat from sunlight per window exceeded the design value allowed.

#### Windows and condensation

Single-glass windows are inadequate for air conditioning, because in winter it is impossible to sustain adequate humidity without condensation on the glass. In winter 45 or 50% relative humidity should be provided. Unfortunately, when it is cold outside, humidistats are set down to stop window condensation and then are not set back. The result is that the pleasurable benefits of adequate humidity in winter is too seldom available even in air-conditioned interiors.

Although differential thermostatic control devices and "window stats" are available to provide automatically all the humidity possible without fogging windows, these offer no real solution. *The solution is the sound planning of new buildings by prefixing the minimum inside-surface temperature with especial regard to windows.*

Window stats, etc., provide inside relative humidities like this:

OUTSIDE AIR TEMPERATURE	INSIDE RELATIVE HUMIDITY
— 10°	17%
+ 10%	26%
+ 30°	41%
+ 50°	61%
+ 70°	(Humidifier presumably not operating)

We are compelled to relinquish one of the most valuable attributes of air conditioning—adequate humidification—unless we provide, at least, the thermal equivalent of double glass where the minimum outside temperature is 10° above zero, and the thermal equivalent of vacuum glass block where the minimum outside air temperature is —15°. *In winter, in central and northern United States, the full value of air conditioning cannot be realized where single-glass windows are used.*

#### Double glazing in tall buildings

Use of double-glass windows in multi-story commercial buildings, to make practical a constant winter humidity of 45 to 50%, presents a difficult problem in window design. This is because, in addition to the vapor-pressure difference, there exists a considerable draft-head above the midpoint of our taller buildings. Above this midpoint, or neutral pressure-zone, inside-air pressure exceeds outside pressure, a condition that increases with height. Wind pressure on one side of the building or the other may further accentuate temperature differences. To prevent condensation on the inside surface of the outer glass, under such conditions, special precautions are necessary to seal the inner window frame while providing ready access for cleaning. A thorough test is advisable before adopting double glazing to solve the problem imposed by the combination of factors involved.

#### Condensation in walls in winter

Considerable publicity has recently been given to the possibility of condensation of moisture within wall construction during cold weather when a relative humidity of around 40 to 50% is maintained inside.

Solutions to problems of construction which this moisture condition creates have recently been the subject of much research, notably by L. V. Teesdale, senior engineer, Forest Products Laboratory, Madison, Wisconsin, and F. B. Rowley, A. B. Algren and C. E. Lund of the Engineering Experimental Station, University of Minnesota.

A report of the work of these men and an interpretation of their research findings appeared in the March, 1938

issue of the RECORD in an article "Preventing Condensation in Insulated Structures", by Tyler Stewart Rogers. (See AR, 3/38, pp. 109-119.) Briefly, it showed that the damaging effects of interior wall condensation can be eliminated by interposing a barrier to water vapor on the warm side of the insulation.

Although research tests were made specifically with rock wool, results apparently establish a principle of insulating technique that applies with equal force to all types of insulating material. In Figure 7 this principle is illustrated; and the thermal aspects of the matter are made clear in Figure 6—A to D, inclusive.

**Proximity of occupants to warm surfaces**

The effective temperature of the air may be maintained correctly, but a person sitting near a fully shaded window may be uncomfortably warm when the sun is shining because body radiation is restricted too much. The same thing occurs when people are close together, as in an auditorium, since there can be no radiation between surfaces at the same temperature. Consequently, there is no exchange of radiation between occupants. This is an additional factor with bearing on the limited cube which makes the air conditioning of theater mezzanines difficult. When the cube is considerable, such as in the main part of an auditorium, this condition of stoppage of body-heat radiation between occupants is partially relieved.

In small spaces indirect lighting may warm portions of the walls and ceilings. If this heat load is not taken into account and the air-conditioning system adjusted to compensate for it, occupants may be uncomfortably warm because body-heat loss by radiation is restricted.

Activity also plays an important part in comfort-conditioning mechanics. The body loses heat faster when exercising; and it is practically impossible to control air-conditioning mechanics so that conditions remain constantly comfortable in the same room for all degrees of activity. Therefore, separate spaces are necessary for various types of physical exertion if air conditioning is to provide ideal conditions.

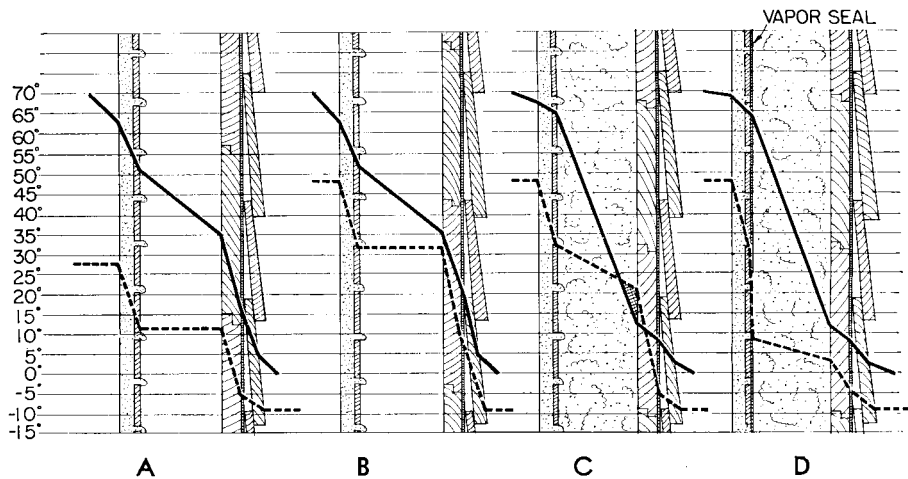

Figure 6: Sections showing thermal aspects of internal condensation. Solid lines represent material temperature gradient and dotted lines the dew-point temperature gradient. In B, where relative humidity is higher than in A, the dew point is so close to the temperature that if insulation is added, as in C, the material temperature drops, overlapping the humidity gradient and producing condensation. If a vapor seal is used internally with insulation, as in D, the resulting spread between dew point and material temperature will prevent condensation of moisture in any part of the construction.

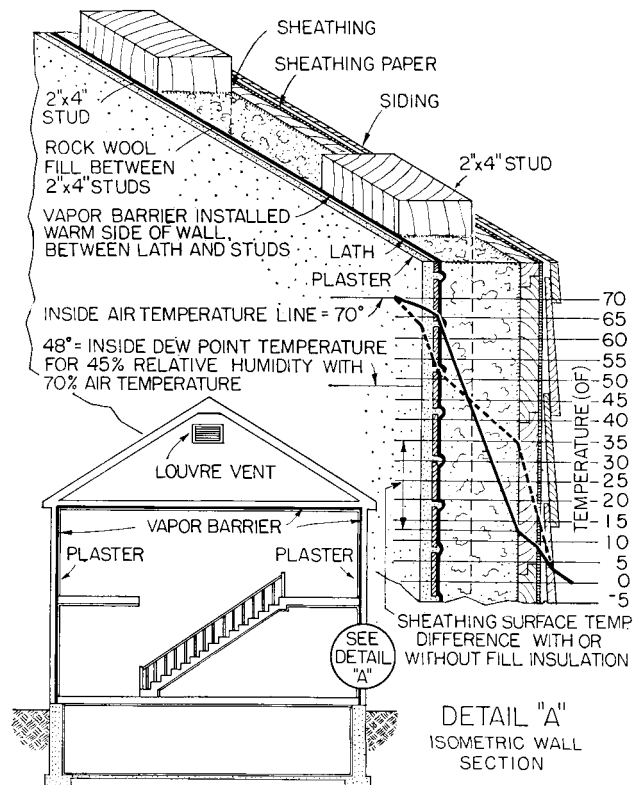
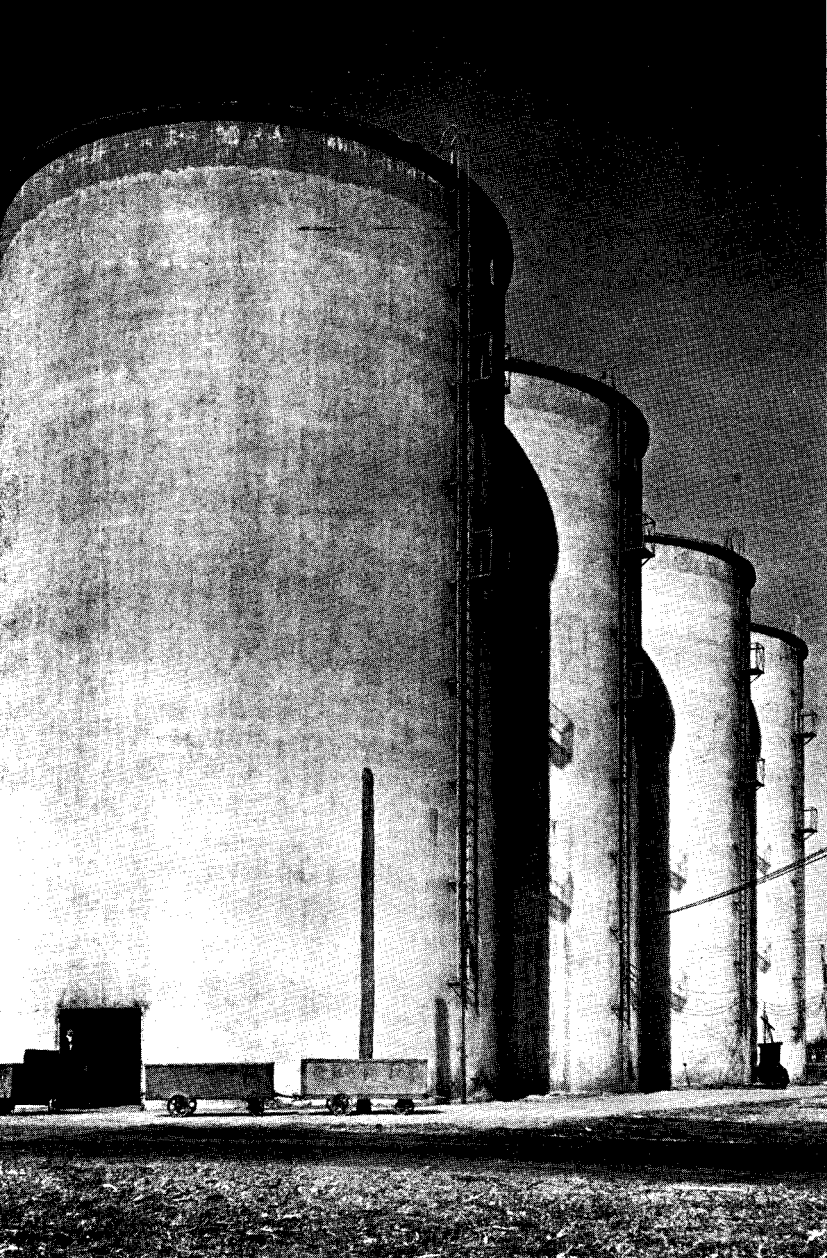
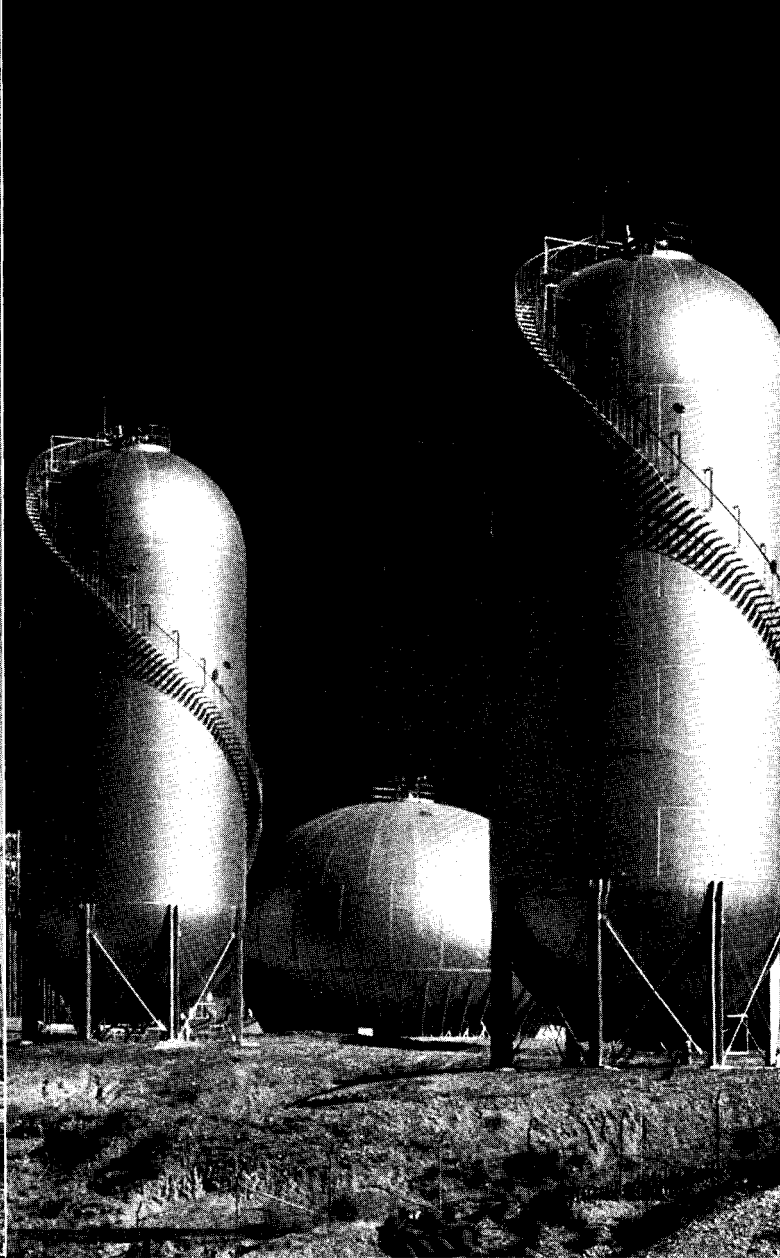

Figure 7: Use of a vapor barrier on the warm side of an insulated wall is one important means of preventing condensation within a wall (see AR, 3/38, pp. 109-119). These drawings show such a barrier in an insulated wall of typical frame construction. The dotted line in Detail "A" shows the temperature gradient through an uninsulated wall; the solid line shows the gradient through the same wall filled with 4 inches of mineral wool, according to tests of L. V. Teesdale of the Forest Products Laboratory, Madison, Wisconsin.



*Robert Yarnell Ritchie*



*Robert Yarnell Ritchie*

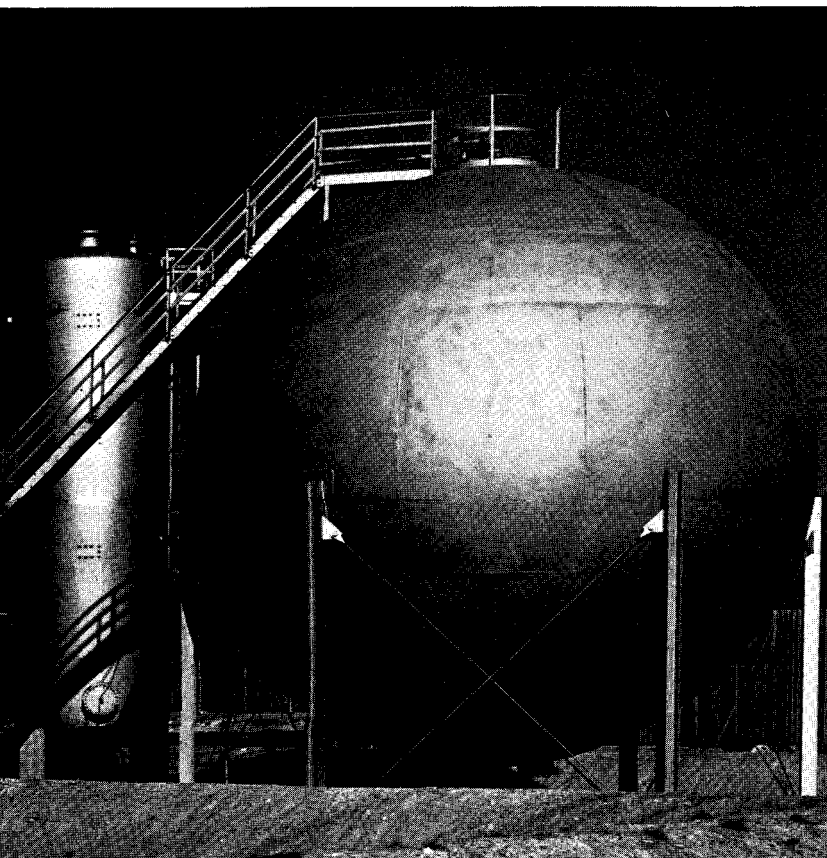

*Ewing Galloway*

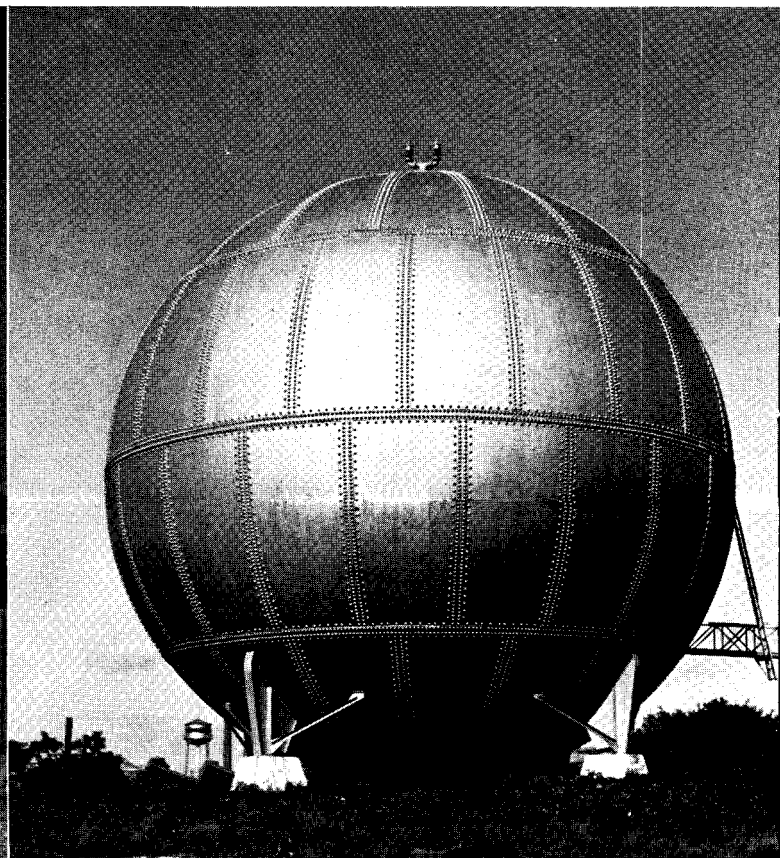

*© G. A. Douglas from Gendreau*



## OLD SILOS IN VERMONT

The silos in which modern industry stores its products are all essentially related to the simple, weatherbeaten structures on the quiet hills of the Vermont countryside. A concrete grain elevator, a delicately supported steel pressure sphere and an old silo on a farm near Morrisville have all been created out of the same necessity. Power and steel and concrete have shaped forms different from those which handicraft has fashioned from local materials. But behind the needs of industry are the parallel requirements of rural activity. In the photographs that follow, Robert Imandt reports how Vermont farmers have met these requirements—and in doing so contributed a commentary to progress.



**Above: Near Jeffersonville, Vermont**  
**Opposite: Near Jeffersonville, Vermont**



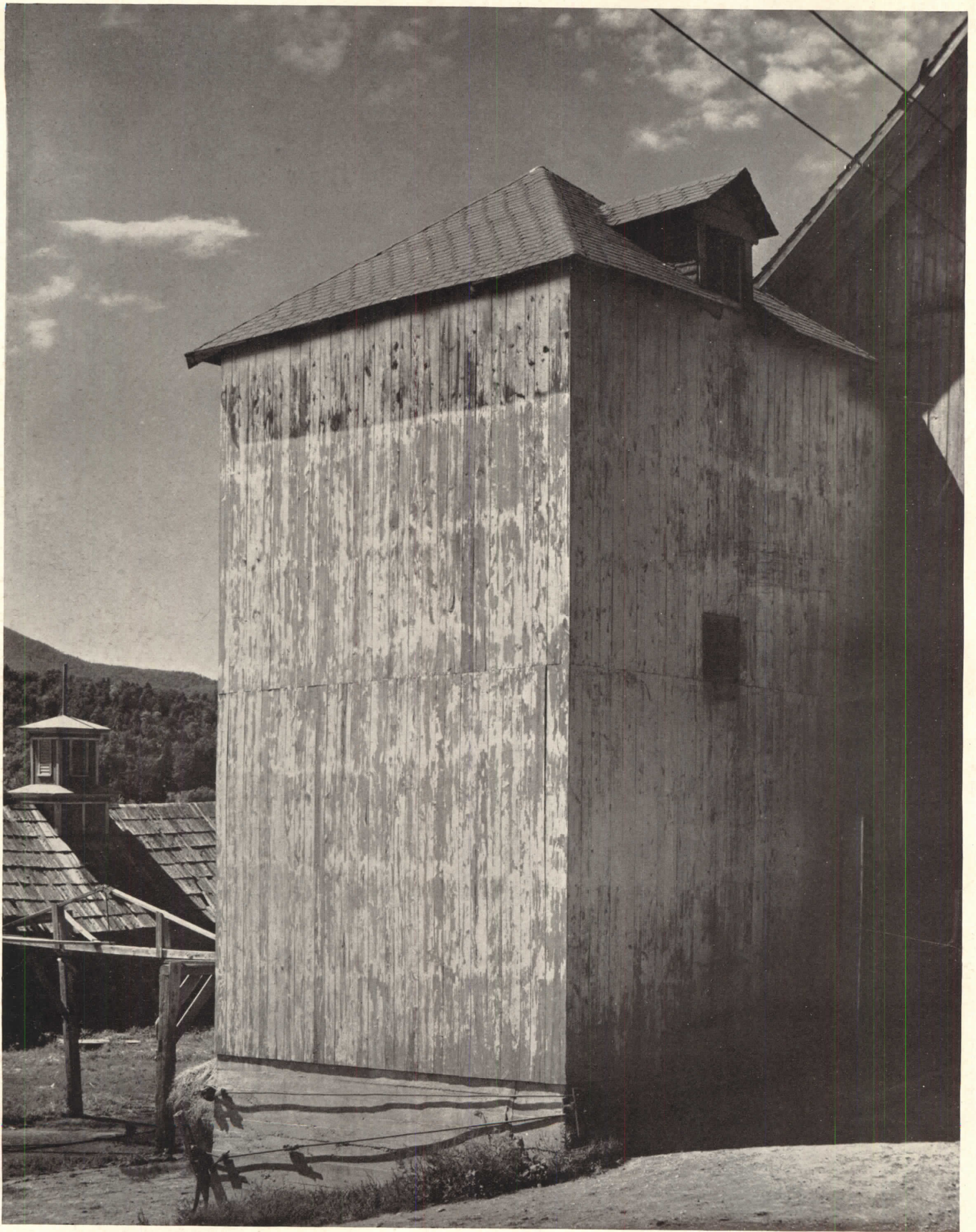

**Above: Near Hyde Park, Vermont**  
**Opposite: Near Johnson, Vermont**





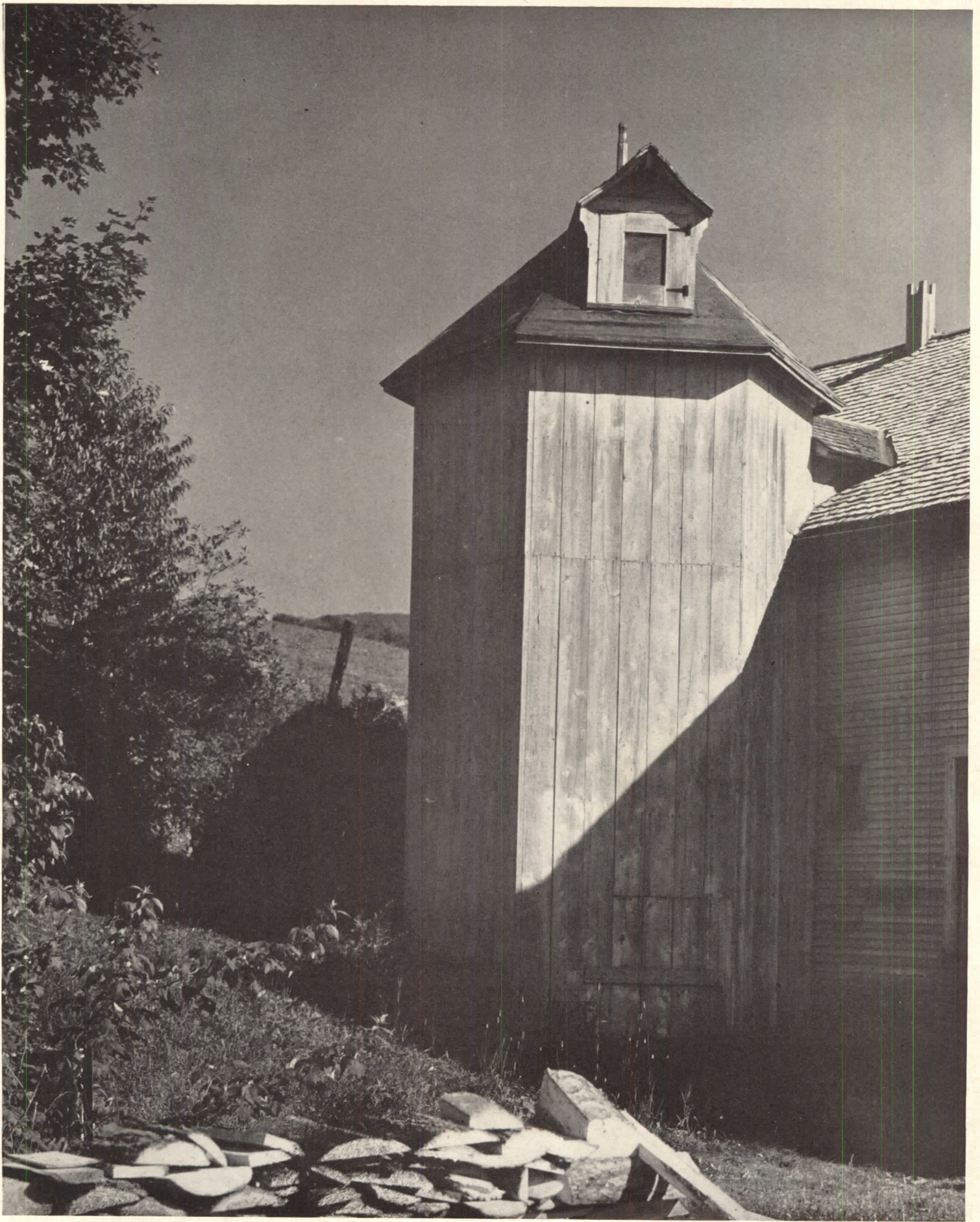

**Above: Near Stowe, Vermont**  
**Opposite: Near Stowe, Vermont**





**Near Rochester, Vermont**

# Building Volume Trends for 37 Eastern States

## Architect-Engineer Planned vs. Planned by Others

By **CLYDE SHUTE**, Manager, Statistical & Research Division, F. W. Dodge Corporation

### TOTAL BUILDING

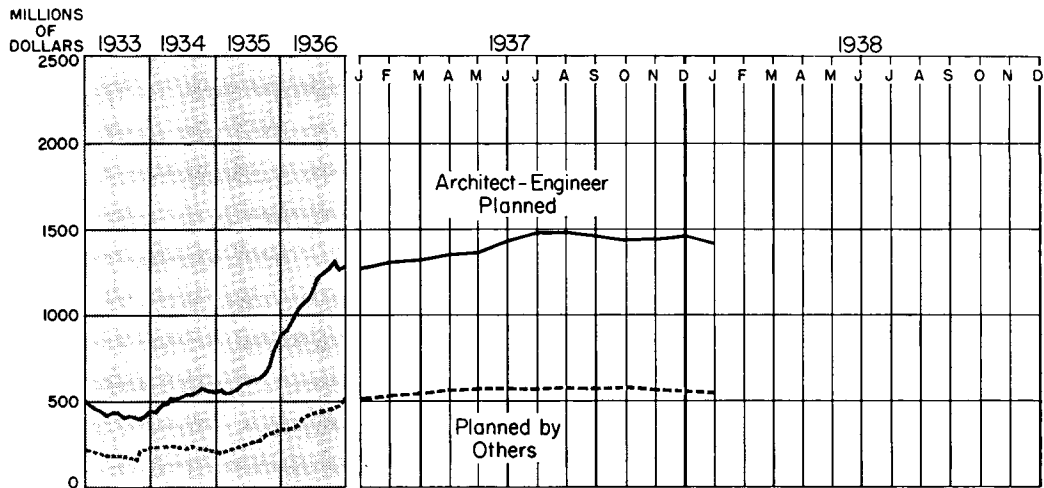

### HOSPITALS AND INSTITUTIONS

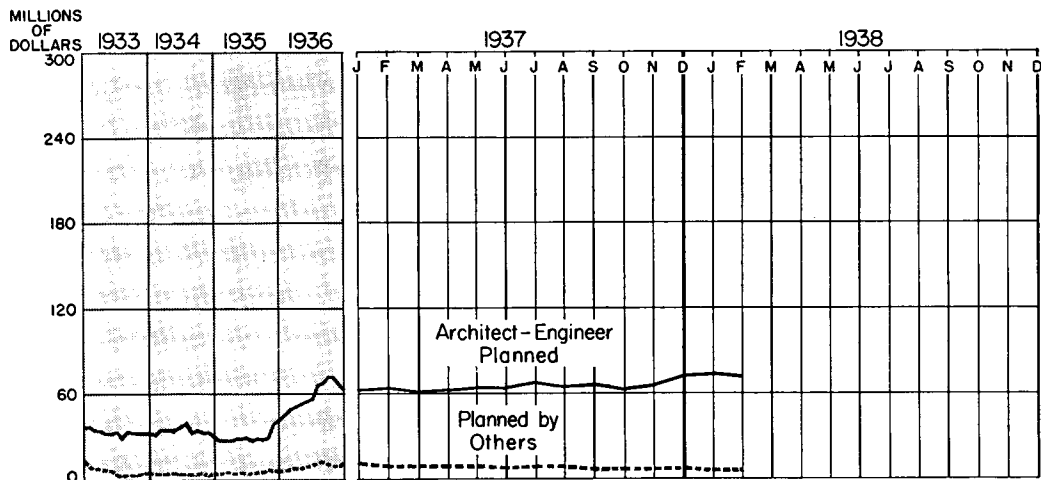

### TOTAL BUILDING 37 EASTERN STATES 2 MONTHS - 1938

Planned by Architects,  
Engineers, and by others

Classification	Architect - Engineer Planned		Planned by Others		Total Thousand Dollars
	Thousand Dollars	%	Thousand Dollars	%	
One- and two-family houses	26,000	43	35,168	57	61,168
All other building	<u>98,554</u>	84	<u>19,193</u>	16	<u>117,747</u>
Commercial	18,186	64	10,249	36	28,435
Industrial	11,515	100	.....	..	11,515
Educational	33,117	96	1,324	4	34,441
Hospitals and Institutions	7,896	91	772	9	8,668
Public buildings	5,566	76	1,762	24	7,328
Religious and Memorial	3,027	75	1,021	25	4,048
Social and Recreational	7,157	81	1,691	19	8,848
Apartments and Hotels	12,090	84	2,374	16	14,464
<b>TOTAL BUILDING</b>	<b>124,554</b>	<b>70</b>	<b>54,361</b>	<b>30</b>	<b>178,915</b>

# Building Cost Trends

By **CLYDE SHUTE**, *Manager, Statistical Research Division, F. W. Dodge Corporation*

**CONSTRUCTION COST INDEX** U. S. average, including materials and labor, for 1926 - 1929 equals 100

AN APPROXIMATION to accuracy of construction cost data on materials and labor combined can only be obtained by determination of cost trends.

The basic data for the charts displayed on these two pages have been secured from E. H. Boeckh & Associates, Incorporated.

The United States average for each general type of construction for years 1926 - 1929 is used as the base period, or 100, because prices of both labor and materials showed greatest stability during these years.

Six general construction types are presented at the rate of two per month, because the quantities of the

different building materials and the amounts of the different classes of labor vary in each type of building. The six types to be shown appear in the following order:

1. Brick (Residence)
2. Steel (Commercial and Factory Buildings)
3. Frame (Residence)

## FRAME BUILDINGS

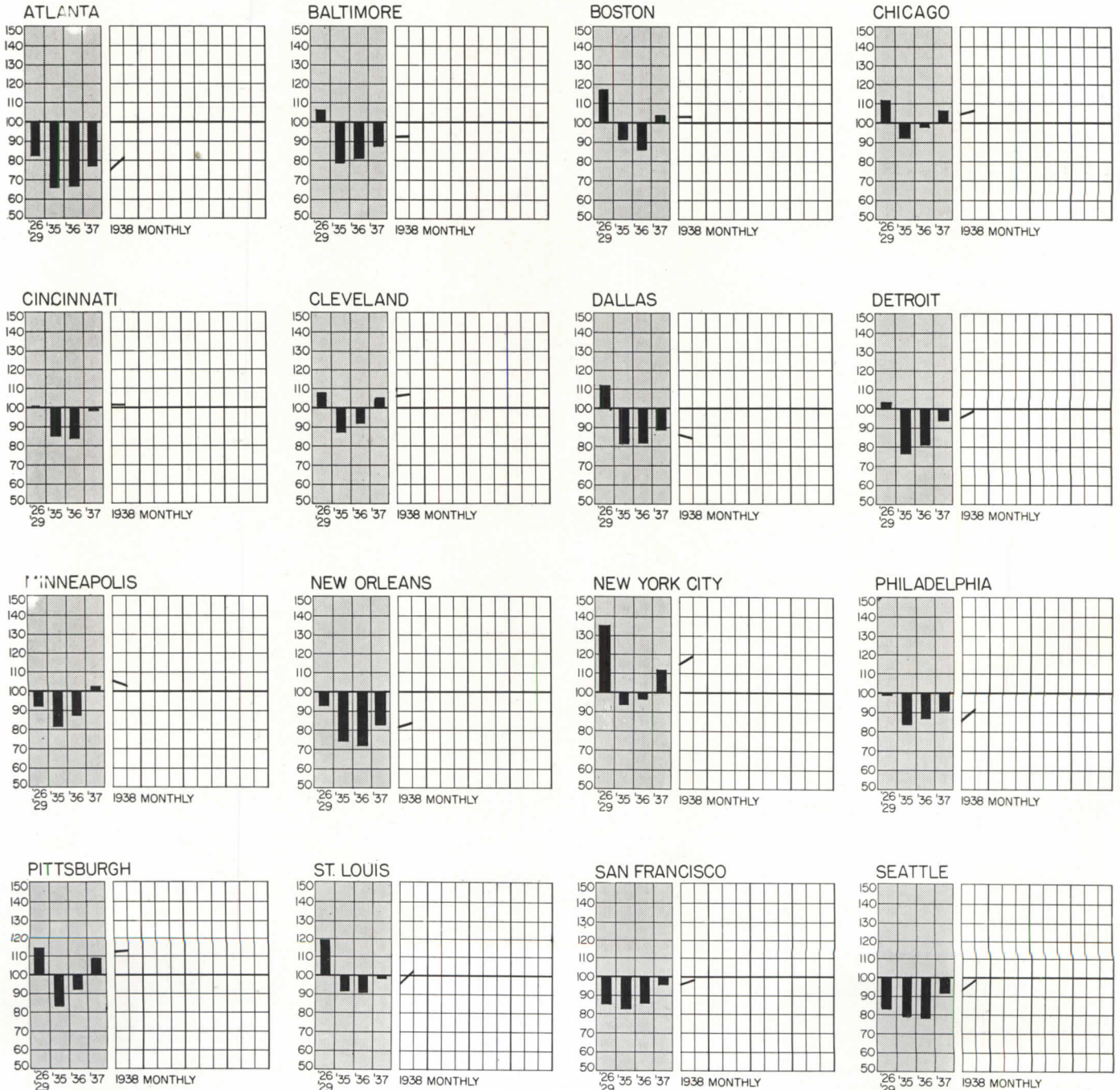

4. Brick and Wood (Apartments, Hotels, Office, Commercial and Factory Buildings)
5. Brick and Concrete (Apartments, Hotels, Office, Commercial and Factory Buildings)
6. Brick and Steel (Apartments, Hotels, Office, Commercial and Factory Buildings)

Sixteen representative but widely scattered cities are shown monthly for each type displayed because material prices and labor rates are different in the various localities and do not change at the same time in

all cities, nor in the same degree.

The index numbers indicate the relationship of the current or reproduction cost of a building at any given time, in any given place, to the 1926-1929 United States average cost for an identical building.

The plotted data provide a quick and efficient method of expressing construction cost comparisons in percentages; or, in other words, the difference between any two index numbers divided by one of the two numbers represents the percentage

difference. For example, if the current month's index number for city "A" is 110 and the corresponding index number for city "B" is 95, it can be said that construction costs in city "A" are approximately 16% higher than in city "B", ( $\frac{110-95}{95} = 16\%$ ). These same index numbers also permit the statement that construction costs in city "B" are approximately 14% below city "A", ( $\frac{110-95}{110} = 14\%$ ).

### BRICK AND WOOD BUILDINGS

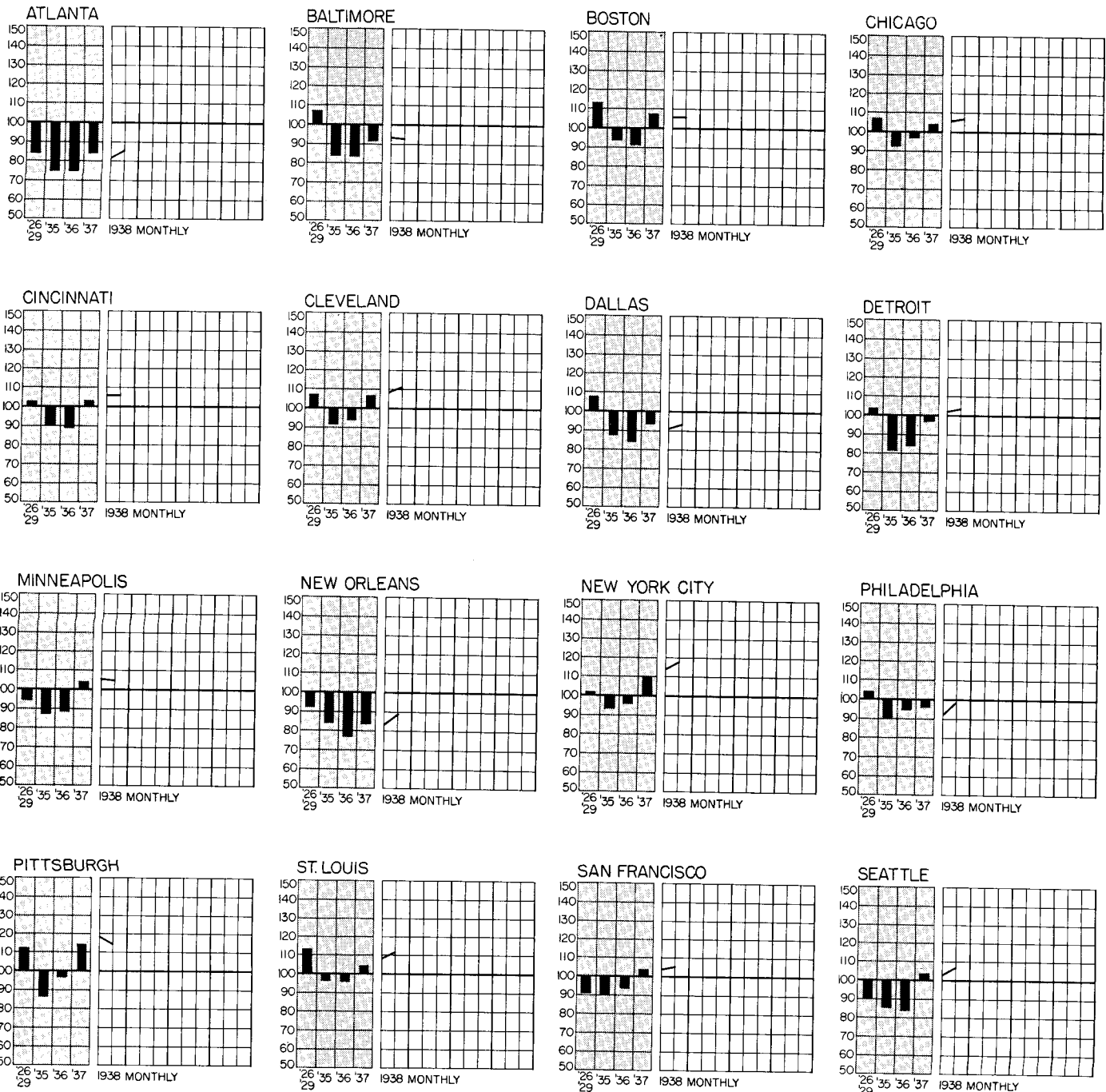



## Reviews of New Books



**SMALLER RETAIL SHOPS.** By Bryan and Norman Westwood. Architectural Press, London. Handled in U. S. A. by Architectural Record. 1937. 9 1/4" x 12 1/2". \$4. 120 pages.

THIS ORDERLY reference study of store planning makes up for a slight depreciation in exchange value by the agreeable flavor of its visual presentation. Being largely based on English standards unrelated to our own merchandising practices, some of the subjects treated are of little use to the American designer. Among these are standards referring to London codes or other British legal restrictions and much of the chapter on heating, which, incidentally, completely ignores air conditioning. "Even the humble oil stove hints that the customer's welfare has been considered." This is a minimum standard unacceptable to most American stores. Obviously, all information on costs is of comparative value only.

On the plus side are chapters on interior and exterior surface finishes, store lighting, fixtures, display windows, sign lettering—all accompanied with photographic and detailed drawings. In addition to an analysis of general factors influencing store planning there are ten shop types presented diagrammatically.

The examples chosen to illustrate current European work—emphasizing British work, of course—represent no departure from the general

trend in store front treatment observable in this country.

Much of *Smaller Retail Shops* has appeared previously in *The Architects' Journal* and *The Architect and Building News*.

A bibliography is included.

**WASMUTHS LEXIKON DER BAUKUNST** (Dictionary of Building Design). Vol. V. Verlag Ernst Wasmuth, Berlin. Illustrations from drawings and photographs. 1937. 9 1/2" x 11 1/2". 624 pages.

THIS LATEST volume of the *Lexikon* covers the years 1932-1937 and serves as a supplement to the preceding ones. Like them it is written in German and notes developments in building design, particularly in Germany.

**THE NEW HEATING, VENTILATING AND AIR CONDITIONING GUIDE.**

American Society of Heating and Ventilating Engineers, 51 Madison Ave., New York City. 1,140 pages. \$5.

THE HEATING, Ventilating, Air Conditioning Guide, 1938, is the 16th edition of the official reference book compiled by the American Society of Heating and Ventilating Engineers.

The 1938 edition contains 840 pages of technical reference data included in 45 chapters, covering material on design and specifications of heating, ventilating and air-conditioning systems. Important new material which has been added on the cooling phases of air-conditioning practice, includes extensive revisions of chapters on Refrigerants and Air Drying Agents, Cooling Load Determinations and design of Central Systems for Cooling and Dehumidifying. Noteworthy is the fact that a chapter on Air Conditioning in the Treatment of Disease appears for the first time. A new feature is a visual chapter index.

In addition to the technical material, over 300 pages of manufacturer

(Continued on page 110)

### HOUSES COSTING FROM \$7,500 to \$15,000

A reference study—which includes 14 pages of Time-Saver Standards data—starts on page 115 in the BUILDING TYPES section.



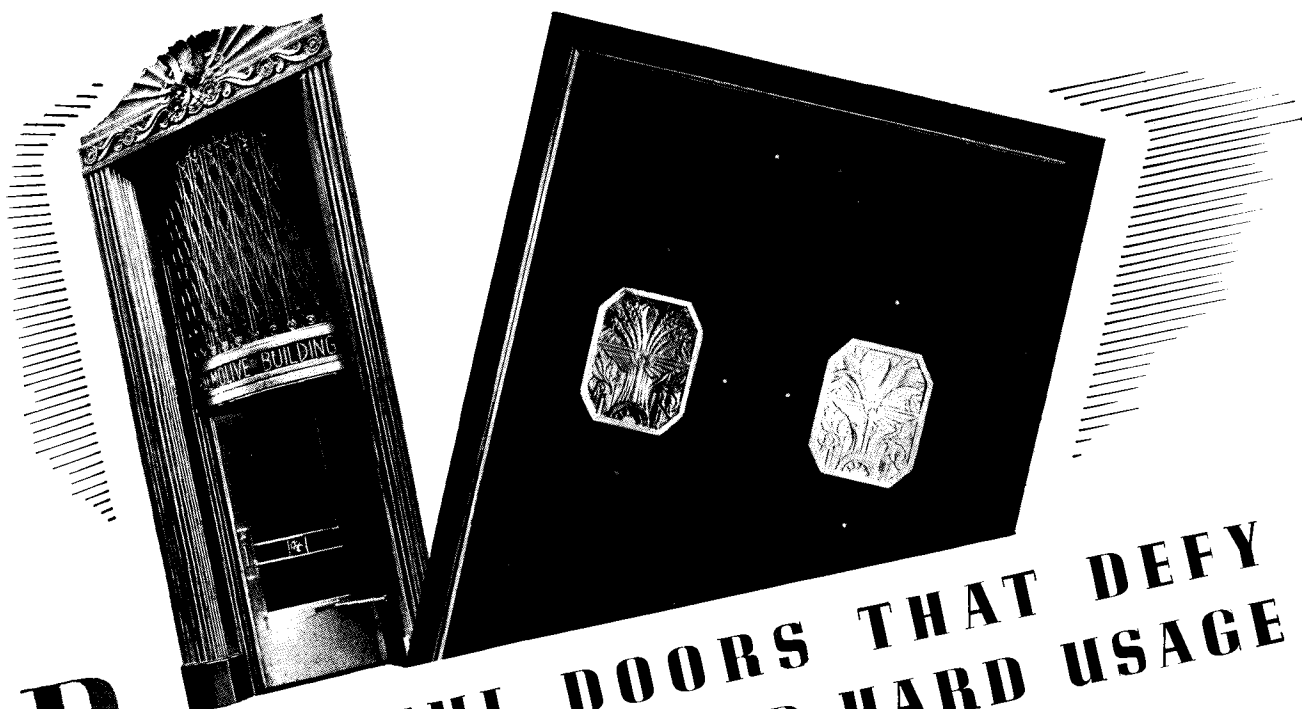

# BEAUTIFUL DOORS THAT DEFY TIME, WEATHER AND HARD USAGE

There is scarcely any architectural feature of a building more important than its doors. • They are the focal point of interest and the focal point of traffic. Hence they should combine beauty of design and materials with unusual durability. • The gallery of Solid Nickel Silver doors pictured here gives you a good idea of the beauty of this lustrous white bronze which architects are widely favoring for this purpose. • Rich in color, brilliant or subdued according to your needs, the Solid Nickel Silvers also offer time- and weather-defying properties that result in lasting service. • The Solid Nickel Silvers are also highly practical from the standpoint of cost. They may be obtained in a wide range of wrought shapes or in a broad variety of cast compositions to meet specifications in design. They respond readily to ordinary fabricating processes and harmonize well with all the commonly used building materials. • Architects or fabricators will gladly advise you on the architectural uses of Solid Nickel Silver.



## SOLID NICKEL SILVER

THE INTERNATIONAL NICKEL COMPANY, INC., 67 WALL ST., NEW YORK, N. Y.



**T**HE owner of a midwestern office building recently distributed the following notice to tenants:

"To comply with the request of various tenants that something be done to more evenly heat the offices, we are going to try operating our steam heating system for the next 30 days without the thermostat controls. We are asking your cooperation. In the event your offices are too warm, please turn the heat off at the radiator instead of just opening the window. Thank you."

When ordinary thermostat control proves inadequate for the heating of a large building, the proper procedure is to secure the service of an organization with specialized experience in the heating and control of large buildings.

The difficulty apparent in the case reported would not occur with a Webster Moderator System because the Moderator System provides (1) balanced steam distribution throughout the entire system and all radiators, (2) delivery of heat continuously to all radiators varied according to need, (3) automatic change in heating rate of each radiator with changes in outdoor temperature, (4) convenient and useful manual adjustments which supplement the automatic control to assure both maximum economy and maximum comfort.

### No Need To Beg Tenants To Save Steam With Webster Moderator Systems

There is an impressive list of building owners who have solved the problem of tenant discomfort and wasteful heating by installing Webster Moderator Systems. Many concise "case histories" have been reported in this column during the past two years. Many more will be similarly reported in future issues.

Have you investigated the possible benefits of a Webster Heating Modernization Program for your building? If not, write us. You incur no obligation.

1888 WARREN WEBSTER & CO., CAMDEN, N. J. 1938  
Pioneers of Modern Steam Heating  
50 YEARS OF HEATING PROGRESS

Consult nearest Webster Representative

ALBANY	DAYTON	MINNEAPOLIS	ST LOUIS
ATLANTA	DENVER	NEW HAVEN	ST PETERSBURG
ATLANTIC CITY	DES MOINES	NEW ORLEANS	SALT LAKE CITY
BALTIMORE	DETROIT	NEW YORK	SAN ANTONIO
BIRMINGHAM	EASTON	OMAHA	SAN FRANCISCO
BOSTON	EL PASO	ORLANDO	SEATTLE
BUFFALO	GRAND RAPIDS	PHILADELPHIA	SPOKANE
BUTE	GREAT FALLS	PHOENIX	SYRACUSE
CAMDEN	HARRISBURG	PITTSBURGH	TOLEDO
CHAMPAIGN	HOUSTON	PORTLAND ORE.	TULSA
CHARLOTTE	INDIANAPOLIS	RALEIGH	WASHINGTON
CHATTAHOOGA	JOHNSTOWN	RICHMOND	WHEELING
CHICAGO	KANSAS CITY	ROANOK	WICHITA
CINCINNATI	LOS ANGELES	ROCHESTER	WILKES-BARRE
CLEVELAND	LOUISVILLE	ROCK ISLAND	YAKIMA
COLUMBUS	MEMPHIS	SAGINAW	YORK
DALLAS	MILWAUKEE		

IN CANADA DARLING BROS. LTD., MONTREAL

## Reviews of New Books

(Continued from page 108)

ers' catalog data are included, as well as an index to modern equipment listing 300 items, crossed-indexed as to product and manufacturer. A listing of society members, including their professional or business connections, forms a separate section.

**THE SCIENCE OF SEEING.** By Matthew Luckiesh and Frank K. Moss. D. Van Nostrand Co., New York City. Illustrations from drawings. 1937. 6" x 8 1/2". 548 pages.

THE SCIENCE of seeing, according to these two members of the General Electric Lighting Research Laboratory, encompasses many factors—controllable aids and hindrances to seeing, internal penalties and rewards to the human seeing machine, characteristics and requirements of performance, and eventual efficiency, comfort, welfare and experience through the activity of seeing. So wide a scope must, of course, include many sciences; and the purpose of the authors here is to delimit the subject to new concepts and knowledge of seeing. The discussions deal largely with controllable factors which can contribute toward quick, certain and easy seeing. Among such factors are the physiology of seeing, visibility of objects, and a technical discussion of light and lighting, with regard to both quantity and quality. The book is well illustrated with charts and diagrams, based on experimentation in the General Electric Laboratory. A bibliography is provided.

**AIR CONDITIONING FURNACES AND UNIT HEATERS.** By J. Ralph Dalzell. American Technical Society, Chicago. Illustrations from drawings. 1938. 6" x 8 1/2". 430 pages.

THIS BOOK is intended as a guide in the solution of specific problems in air-conditioning design. Several chapters especially valuable to the building designer are devoted to transmission coefficients and tables. Conductivities and conductances of practically all building materials and insulators, separately and in various combinations, are systematically tabulated. Similarly, common types of residence floor plans are analyzed as case studies in the application of design methods. Furnaces and unit heaters

are also discussed in this very usable form, with typical examples and solutions. This book should be very useful to those interested in the immediate and practical problems in building design that are posed by air conditioning. An index is provided.

**GREAT GEORGIAN HOUSES OF AMERICA.** Volume II. 1937. Introduction by Fiske Kimball. Printed by the Scribner Press, New York. 11 1/4" x 14 1/2". 256 pages.

THE SECOND of two similar volumes published for the benefit of the Architects Emergency Committee, this book includes photographs, plans and measured details of 33 Georgian houses built in the 18th and early 19th centuries. There is no text, apart from the introduction.

**THE TOWERS OF NEW YORK.** By Louis J. Horowitz and Boyden Sparkes. Simon and Schuster. New York City. 5 1/2" x 8 1/4". 277 pages. 1937. \$2.25.

LOUIS J. HOROWITZ was chief of the Thompson-Starrett Building Corporation during the years when the skyline of New York was moving sharply upward, and in this book he tells the story of that era in building. Among the great structures erected during his tenure were the Gimbel Department Store, the Woolworth Building, the Equitable Building and the Waldorf-Astoria.

The rapid erection of these buildings represents a triumph of organization and coordination. On a big job, hundreds of contracts had to be signed and tons of materials delivered and installed. The work of thousands of workmen had to be so coordinated that waste of time and labor was held to a minimum.

Mr. Horowitz takes legitimate pride in having played a part in some of the largest and most successful of such jobs. His pride is tempered, however, by an awareness of the social and, in the long run, the commercial impracticability of extremely tall buildings. He declares: "Socially, the gigantic buildings are, to my way of thinking, quite wrong . . . no city ever was meant to contain the buildings of fabulous size—fifty, sixty, or seventy stories and more—that have been attached like monstrous parasites to the veins and arteries of New York. . . . The higher you build,

(Continued on page 112)

# More Radiation IN A GIVEN WALL SPACE

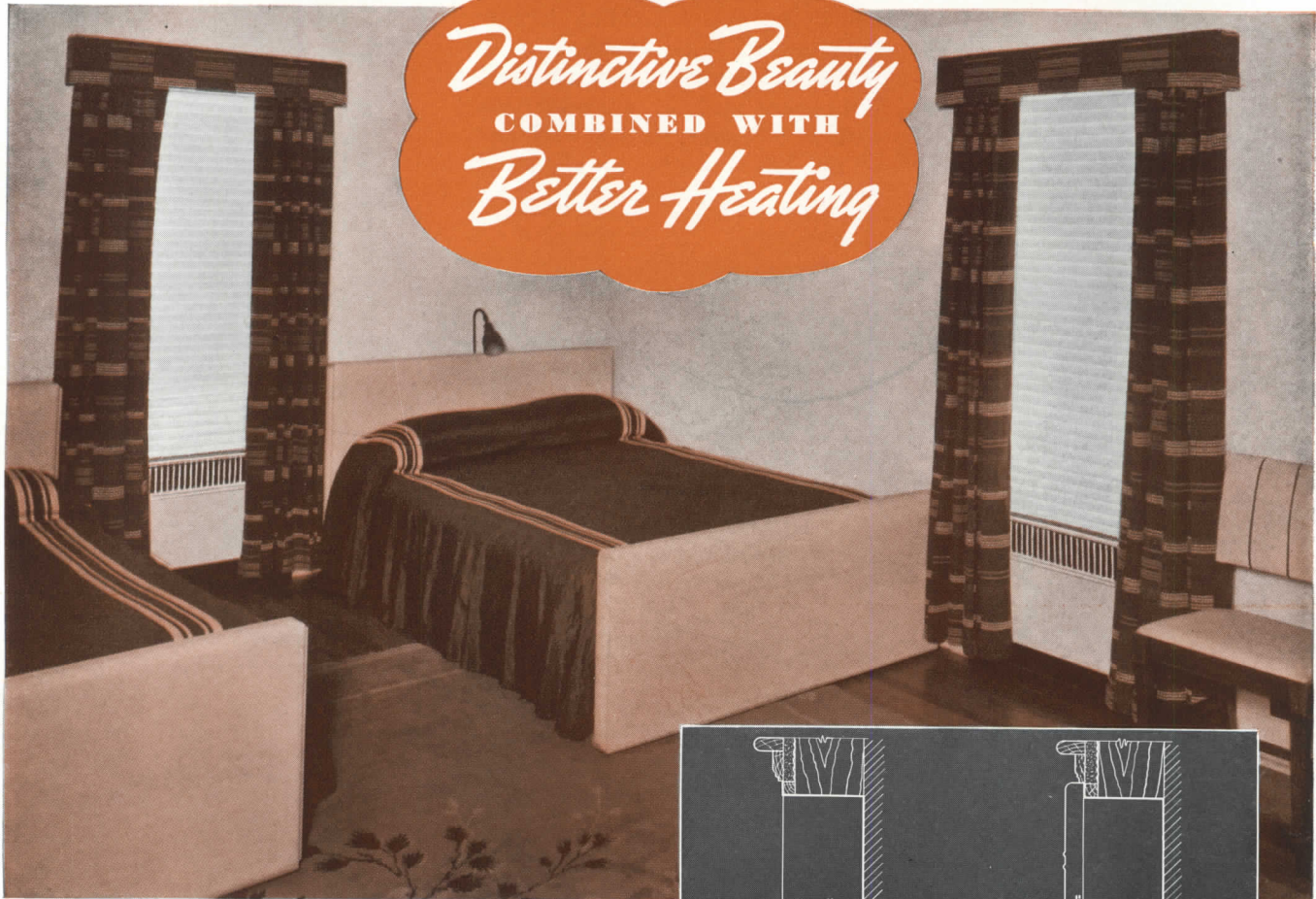

An inherent advantage of convector heating is the saving of floor and wall space. This is particularly true of the Modine Recessed Type Convector.

A Modine Recessed Convector with a 5½-inch heating unit can be installed in a wall of 4-inch stud depth. An ordinary flush-front recessed convector, installed in the same wall space, will accommodate a heating unit only 3½ inches deep.

By specifying Modine Recessed Type, you gain approximately 45 per cent more heating capacity . . . without using any more wall space. (See Diagram) This frequently results in lower installation costs when only one Modine convector need be placed in a room which would otherwise require two.

The steel enclosure front of the Modine Convector extends into the room only 1½ inches . . . just about the required depth for base and quarter

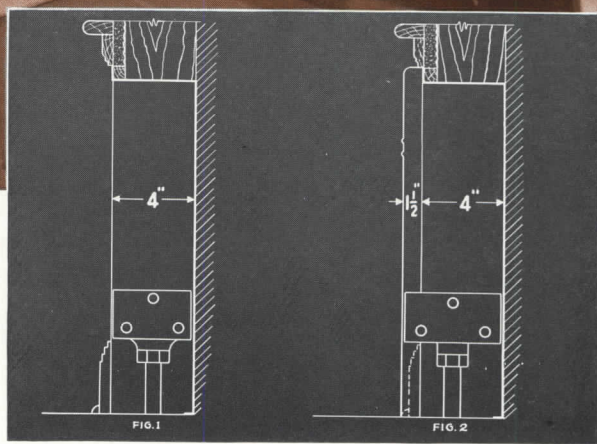

Observe in Fig. 2 above, how the Modine Recessed Convector occupies the same amount of wall space as the ordinary flush-front type in Fig. 1. . . yet accommodates a deeper heating unit with much greater capacity.

and for sill. Its rounded edges and corners, and gracefully proportioned lines give a pleasingly paneled decorative effect under the window . . . Write for Bulletin 237-B.

**MODINE MANUFACTURING COMPANY**  
1773 RACINE STREET RACINE, WISCONSIN  
HEATING, COOLING AND AIR CONDITIONING EQUIPMENT FOR  
RESIDENTIAL, COMMERCIAL AND INDUSTRIAL APPLICATION

**MODINE** *Copper* **CONCEALED RADIATION**

## Reviews of New Books

(Continued from page 110)

the more space you have to provide for elevators to distribute the people in these human hives; likewise, the plumbing stacks swell thicker. At that point where the space sacrificed on the lower stories for these services begins to offset the advantage of diluting the cost of the land, and the added cost of building high, the building becomes unsound from an investment standpoint."

What of the future? The author believes that building is not on the

same technological level as the other major industrial arts. It is, in fact, dominated by "primitive methods of labor." And these methods will have to be discarded before the housing problem can be solved: "In order to provide low-priced homes on a basis that will permit the masses of Americans who will occupy the houses to afford them, the building industry must accept some changes. Costs would be lowered sharply if arrangements were made to assemble many units in a factory, so that what came to the job could be quickly put in place."

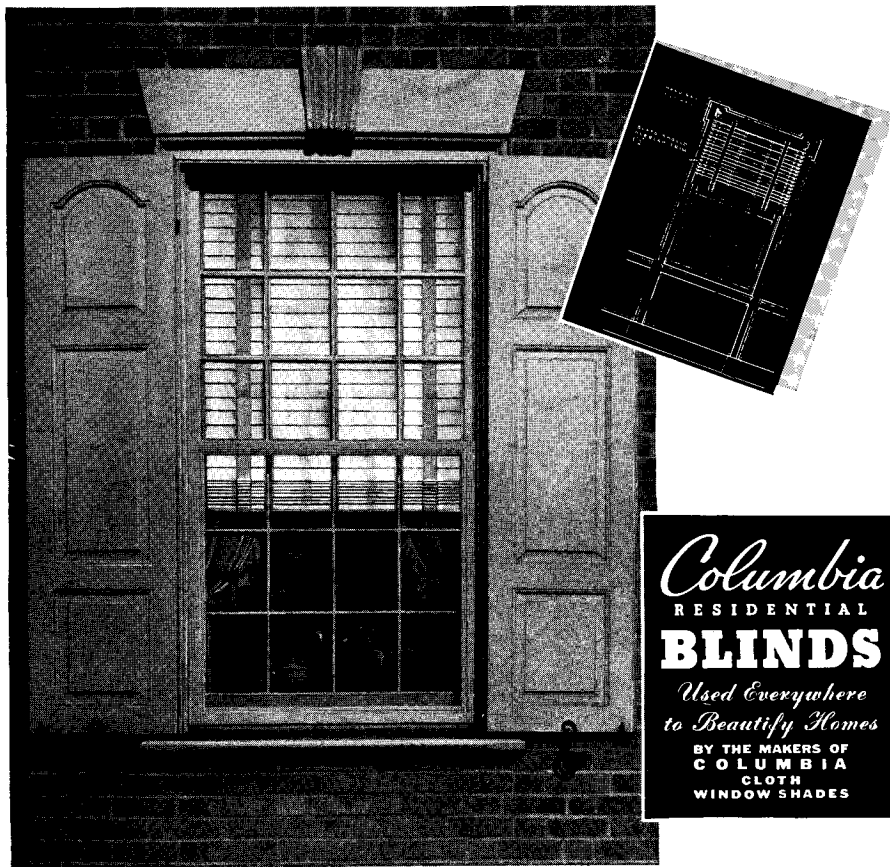

*Columbia*  
RESIDENTIAL  
**BLINDS**  
*Used Everywhere  
to Beautify Homes*  
BY THE MAKERS OF  
**COLUMBIA**  
CLOTH  
WINDOW SHADES

### View Venetian Blinds from Exterior

TRUE VENETIAN BLINDS as we know them today were first made in France about 1757. Soon afterward they became popular in America and the vogue spread to England, Spain and Italy. Columbia Venetian BLINDS, therefore, can be specified with admirable effect for buildings whose architecture is adapted from 18th Century work. For

almost half a century, The Columbia Mills, Inc. has cooperated with architects in the solution of window treatments and we invite the architect to discuss his plans either personally, at any one of our offices located in the larger cities (see Sweet's Catalog), or write to our Architectural Plan Department, New York City.

Write for your copy of "Architectural Data Sheets No. 1"

**THE COLUMBIA MILLS, Inc., 225 Fifth Ave., New York**

# Uniform as Grenadiers of the Guard!

YOU cannot afford to use drawing pencils which are not accurately graded—nor pencils that are not uniform. Even a speck of grit in your pencil may ruin the effect of your drawing.

That is why Mars Lumograph is the standard of so many artists, architects, draftsmen, engineers—Mars Lumograph can be depended on for perfect work—always—without a thought being given to the quality of the pencil while you are working.

#### BETTER Reproduction Direct From Drawings

Mars Lumograph contains a secret light absorbing element that adds to the natural opacity of its finely ground, perfectly mixed, choice graphite particles. The result is more solid, denser lines—approaching ink in their opaqueness and producing perfect reproductions direct from pencil drawings without inking in.

This one feature alone makes Mars Lumograph the superior pencil where time, work and money savings are important. But Mars Lumograph is also a strong, long lasting, non-smudging, clean erasing pencil that will delight you to use. Try one or a dozen—from your dealer or us. 17 true degrees — from ExExB to 7H — 15c. each — \$1.50 the dozen.

**J. S. STAEDTLER, Inc.**  
53-55 Worth St., New York

Photomicrograph of Lumograph line (upper), and other drawing pencil (lower); Proving Lumograph's superior opacity.

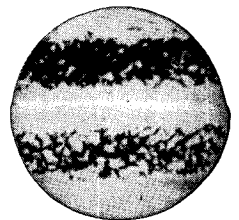

**MARS**  
**LUMOGRAPH**

# THE ARCHITECT SPEAKS OF *Interior Design*

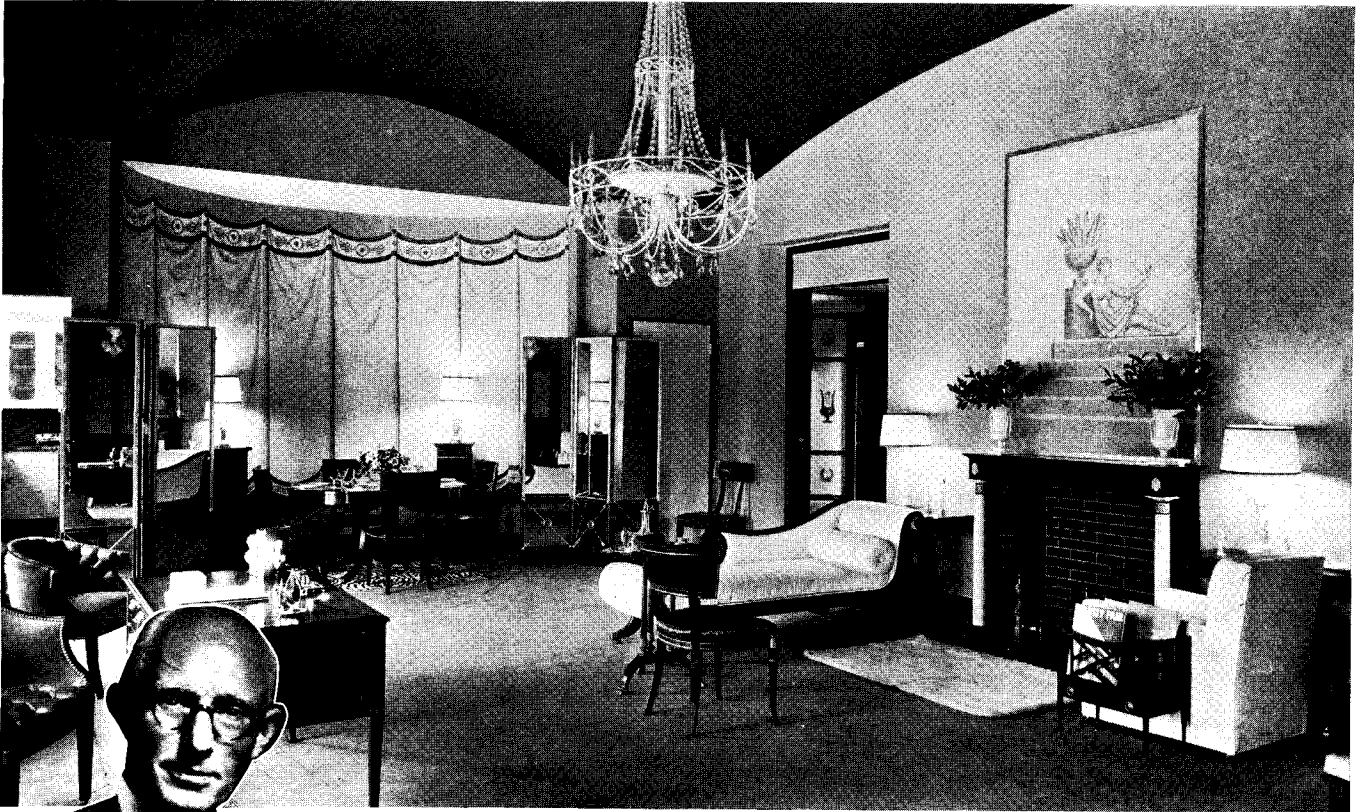

*The brilliant achievements of Harvey Wiley Corbett, one of America's foremost designers, make his comments on Interior Design of unusual significance in showing the growing endeavor and interest of architects in this field. Mr. Corbett says:*

"Skyscraper architecture has so effectively established the name and fame of the American architect that he, as well as his public, has been prone to estimate a building according to its distinction in the skyline, rather than the state of mind induced in

the human contingent who spend most of their waking hours each day in the building.

"The ultimate success of the building, and coincidentally the professional progress of the architect who designed it, are usually based less on the steel and stone impressiveness of the shell than on the satisfaction engendered by use of the interior spaces. The shell itself is determined by the plan arrangement, which is only one way of saying 'interior design.'

"Honesty in architectural design implies well proportioned and conveniently arranged internal spaces. And it has been my experience that the more thoughtfully these internal spaces have been designed, the finer an exterior the building usually achieves.

"Honesty in interior design, whether the designer is the architect, the decorator or the client, implies a clear and sympathetic understanding of the character and needs of those who will use the spaces.

"It has always been my endeavor to provide satisfactory interior spaces; and when I have been asked to complete in detail the decoration and furnishing of a space, I have been most appreciative of the intelligent and expert cooperation available from experienced organizations in the field of interior designing."

*Harvey Wiley Corbett*

These "editorialized" announcements on "*The Architect Speaks of Interior Design*" are sponsored by the following concerns. Architects and others are invited to obtain complete information and service from these companies:

## **DRIX DURYEA, INC.**

54 East 57th St., New York  
*Photo-Murals*

## **McMILLEN, INC.**

148 East 55th St., New York  
*Decorative Art Objects  
Fine Old Furniture*

## **J. E. Catlin, the VIRGINIA CRAFTSMAN, INC.**

222 East 46th St., New York  
*Complete Furniture Service Specializing  
in Historical Reproductions*

## **RICHTER FURNITURE CO.**

510 East 72nd St., New York  
*Facilities for Reproducing Classic  
and Designing Modern Furniture*

## **W & J SLOANE**

575 Fifth Ave., New York  
*Contract Furniture Division*

THE **MODUTROL** SYSTEM IS  
FLEXIBLE ENOUGH TO MEET  
*any* CONTROL PROBLEM!



TO meet any control problem it is necessary that Automatic Controls not only satisfy the temperature and air conditioning requirements, but that operating costs be held to a minimum. The Minneapolis-Honeywell Modutrol System is flexible enough in its application and accurate and dependable enough in its performance to exactly meet the requirements of any building, large or small, old or new. It is the only system which includes Electric, Pneumatic or a combination of Electric and Pneumatic Controls. For the best possible results at the lowest operating costs, recommend and install the Minneapolis-Honeywell Modutrol System. A Minneapolis-Honeywell engineer is available to assist you with any control problem. Minneapolis-Honeywell Regulator Co., 2804 Fourth Ave. So., Minneapolis, Minn. Branch and distributing offices in all principal cities.

■  
*Dependable Controls Cost Less Than Service*

**MINNEAPOLIS-HONEYWELL**

BROWN INDUSTRIAL INSTRUMENTS  
NATIONAL PNEUMATIC CONTROLS



*Control Systems*

# BUILDING TYPES



*Courtesy Portland Cement Assn. G. A. Fehrson, Architect.*

**SERVICES AND EQUIPMENT FOR**

**HOUSES — \$7,500 to \$15,000  
WITH TIME-SAVER STANDARDS DATA**

ARCHITECTURAL  
RECORD

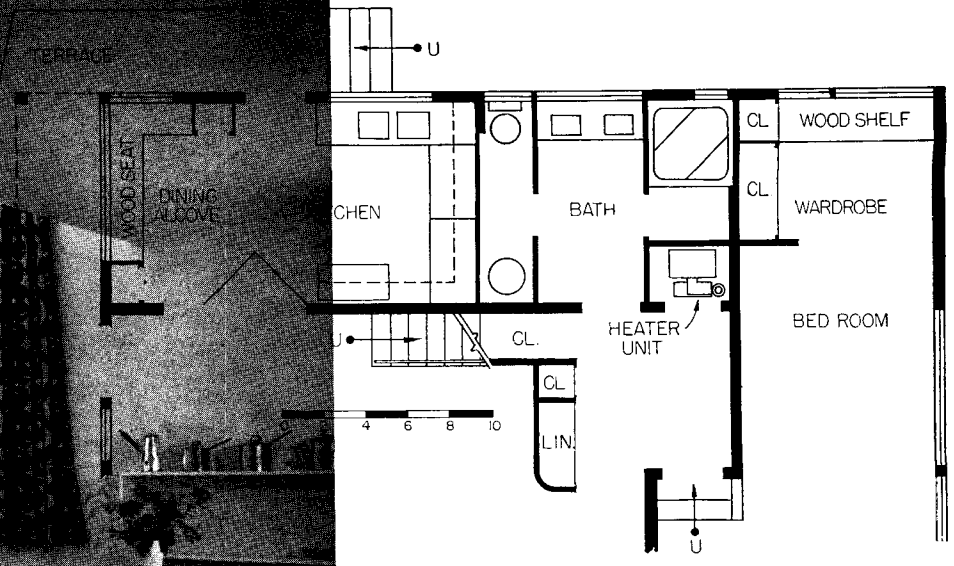

Service systems and equipment in houses should function smoothly, without being obtrusive. The plan above shows the service portion of a house for Alfred de Liagre; William Muschenheim, Architect. Upper: Food service in a house at Lee-on-Solent, England; F. R. S. Yorke and E. Marcel Breuer, Architects. Lower: Built-in dressing room equipment, house of Frank B. Foster, Phoenixville, Penn.; Oscar Stonorov, Architect.

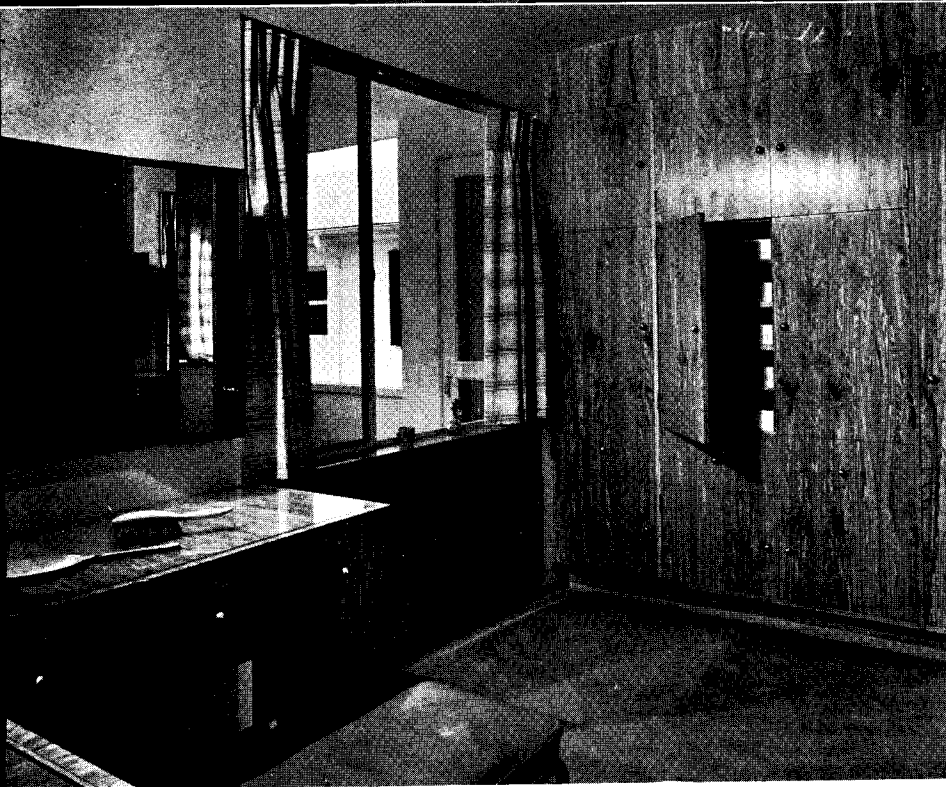

Photos by F. S. Lincoln



# Planning Integrated Service Systems

For Residences Costing from \$7,500 to \$15,000

**Desirable standards for horizontal planning were compared with field practice in the Building Types section of the RECORD for March, 1938. The following study is devoted to the services and equipment which function within activity areas, and on which additional funds are spent.**

SERVICE SYSTEMS may include all items of equipment which serve living activities. For ease of installation and maintenance, and for economy, many such items are currently recognized as parts of "systems", as heating or air-conditioning systems. Only a slight extension of the idea is necessary to bring into range of systematized planning such seemingly isolated units as built-in dressers, bookcases and closets; or details of sound-isolating construction, "zoned" planning for sound control, and sound-absorptive finishes. In the first case, if storage spaces of all types are preplanned and co-ordinated, a *storage system* results. In the latter case, structural and finishing methods and materials combine with preplanning to form a *sound control system*. Service systems may operate in all or in a limited number of activity areas.

For the purposes of this study, a definition may be derived from the foregoing as follows:

*A service system results when units of space, structure or equipment are co-ordinated to increase utility of space for living activities, and to improve standards of health and comfort.*

## Types of systems and their integration

On the following page are listed the more outstanding examples of service systems. All are subject in some degree to fluctuating requirements dependent upon clients' needs, geographical location, site and similar factors. This study contains data on systems least subject to such variables.

Since the relative value of service systems depends upon the advantages which they contribute to living areas,

it follows that their integration stems from living activities. Eating, for instance, involves food service, lighting, power, storage, circulation and communication directly, as well as sanitation and other systems involved in food preparation. Convenience, health and comfort will all be benefited and economy of installation and operation increased, if the multitudinous interrelationships are co-ordinated.

For clarity, systems are here discussed independently, with their various interrelationships noted.

## Sanitation systems

Sanitation systems may be divided into three parts: (1) water supply; (2) use; (3) disposal. Each part may be further subdivided. Problems relating to hot-water supply are slightly different than for cold water. Use areas—bathrooms, lavatories, kitchens, laundries, hobby rooms—involve dimensional planning problems related to dimensions of the human figure, and of types of equipment as well as location of rooms or space. Disposal systems can be subdivided into several parts.

Sanitation systems include water supply for heating systems as well as for living activities of toileting, laundering, food-preparation and such outdoor activities as gardening, car-washing, etc. Isolation of noises caused by use of sanitation systems constitutes a serious problem. If supply and drainage systems can be simply planned and laid out with reference to the structural system, economies of installation and maintenance will result. Full consideration of health requirements and prevention of creation or transmission of sound to portions of the house structure are also important.

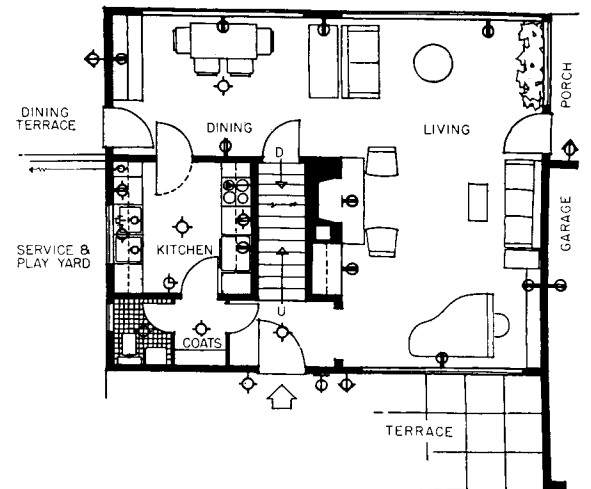
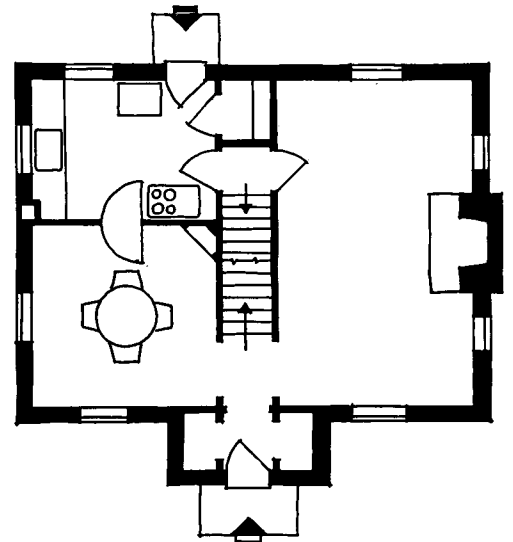

Top: A typical first-floor plan. Center: As restudied by the Architectural Service Division of the General Electric Home Bureau: this emphasizes desirability of arranging elements of space and equipment so that co-ordination naturally results—co-ordination not only of electrical specifications and products, but also of other equally important service system units.

### Lighting systems

Lighting systems consist of natural and artificial lighting and of means of controlling both. Contrary to a popular assumption, natural lighting—daylight—is not always perfect; nor is artificial light—electric light—inherently bad. Sources of either type can be controlled by proper location of windows, electric outlets and fixtures. Quality and quantity of light can be controlled by blinds, shades, type of lamp and fixture. Lighting levels can be controlled by regulating finish of the area lighted, as when a room with north light only is painted a light, highly reflective color. Light, in addition to satisfying the bare necessity of seeing, can be used to emphasize or subdue structural elements or furnishings. It can also be used to create an atmosphere psychologically conducive to health and comfort. Again, the ultimate result should be considered, as well as the incidental means of securing that result.

Lighting systems operate in all activity areas; hence their problems are perhaps more closely allied to all services than is the case with others here considered. Built-in fixtures such as coves, troughs, soffit lights and the like imply a close relationship to structure.

### Food service systems

Food service systems are commonly regarded as consisting of a kitchen, pantry and dining room; sometimes a breakfast nook or room and dining terrace are included. These constitute, in reality, centers for preparation and eating; requirements for modern living indicate another need. No matter how methodically the kitchen is planned, if access to the recreation room, the living room, the living porch, the garden, the bedroom or sickroom—even to the den or “quiet room”—is not convenient, the maximum of utility, comfort and health is not obtained. For the purpose of this study, food service systems consist of ways—passages, passways, doors, dumbwaiters—through which prepared food is transported for consumption. Relative locations of activity areas are extremely important.

Since food service may in some cases be considered a subdivision of the circulatory system, circulation and communication are the most important of the related systems. The special nature of food service problems leads to its study as a separate entity. Built-in

equipment furnishes the link to storage and structural systems; and the manner in which lighting elements are often incorporated in built-in furniture, and their importance to the functions of serving and eating indicate a necessity for considering lighting systems.

### Storage systems

Storage systems include, as previously mentioned, all types of spaces in which portable equipment is stored. In many cases, articles to be stored may conveniently be housed in furniture, such as desks. Such items are here considered as furnishings unless they are built in, and so not within the scope of this study; nor will such highly developed forms as kitchen cabinets, which are adequately treated elsewhere, be included except in passing.

Storage space is required by nearly all living activities, and so is in one way or another tied to all service systems. Portions of sanitation systems need storage for towels and other equipment. Lighting is in some cases necessary to illuminate closets; in others, as previously noted, it is incorporated in built-in equipment. Food service requires storage space. All types of storage spaces, even “dead” storage, must be accessible; hence circulatory systems must be considered. One of the most effective ways of localizing undesirable sounds in residences consists of placing storage spaces between sources of sound and areas where sound disturbance is to be minimized.

### Communication systems

Communication systems consist of those portions of the residence which facilitate the acts of talking, hearing and passing from area to area. Communicating doors, hallways, stairs; and telephones, radios, bells, buzzers and annunciators are included.

Analysis of communication systems—which in addition to mechanical means of communication include means of circulation and annunciation—at once reveals their importance to all other service systems. Convenient circulation is one measure of a good residential plan. But others exist as well, and should not be sacrificed. Ease of communication and convenient location of communicating devices should be studied not only in relation to the activities they serve, but in relation to all living activities.

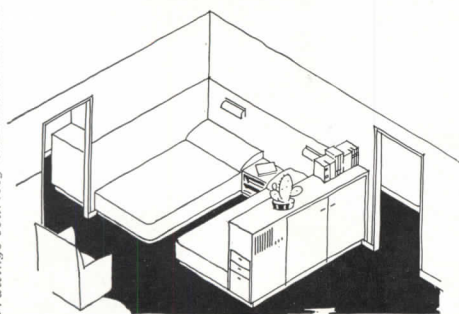
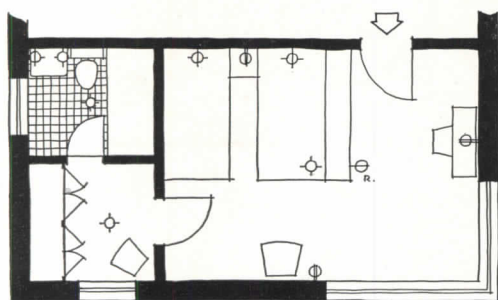
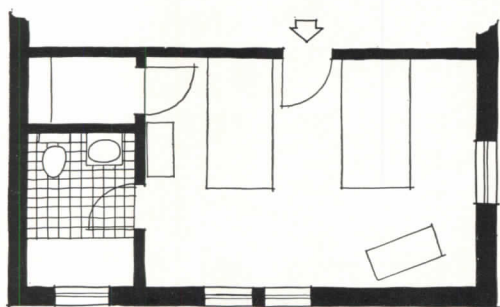

Drawings courtesy G.E. Home Bureau

Top: Co-ordination of structural elements, equipment and furniture is poor in this bedroom unit. The same space and partitions can be used to provide more uncluttered floor area in the bedroom, a dressing room with built-in wardrobes, and a sizable bathroom in which supply and soil piping will not be costly or inefficient.

**Sound control systems**

Sound control systems, as outlined before, comprise planning, construction methods and finishing materials, all studied with a view to localizing or preventing the transmission of objectionable sounds within the house.

Chief among residential sound control problems are those arising from use of sanitation facilities and from waste disposal systems. Means of communication and of food service are frequent offenders. Location of storage spaces, in plan, to act as sound baffles, can prevent many cases of noise transmission. Most important in methods of solving all types of sound control problems, however, is the necessity for a structural system of high quality. This is due to the fact that mass of material will do more to prevent sound transmission than remedial measures.

**Methods of co-ordination**

The following pages contain data and diagrams which indicate means of solving problems of individual systems and of relationships with other systems. It is not intended in any case that the forms shown should constitute the only solutions; rather they are intended as bases for formulating independent solutions. Problems encountered in designing a residence should be studied in relation to all factors affecting the particular job at hand.

Examples of solutions of such problems are contained in the pages devoted to houses recently built.

Acknowledgement is made to the following, who have supplied source material and criticism: U. S. Dept. of Agriculture, Bureau of Home Economics; State University of Iowa, College of Engineering; Wisconsin State Board of Health, Bureau of Plumbing and Domestic Sanitary Engineering; American Public Health Association; General Electric Company, Incandescent Lamp Division, and Home Bureau; Electrical Research Products, Inc.; New York State College of Home Economics, Cornell University; Johns-Manville Corporation; Plumbing and Heating Industries Bureau.

Various individual consultants within the above organizations as well as independent sources have also helped. Illustrations were drawn by Lester E. Balstad.

**TYPES OF OPERATIONAL SYSTEMS**

**SPACE SYSTEM:** co-ordination of activity areas into plan types; considerations include dimensions, clearances, and provision for satisfactory servicing of both individual areas and complete plans.

**CONSTRUCTION:** types of materials, foundations, walls, roofs, openings.

**SOUND CONTROL:** location of spaces in plan, sound baffles, precautions, structure.

**COMMUNICATION:** telephones, radio, annunciators, bells, buzzers, house telephones, circulation.

**STORAGE:** closets, bins, built-in cupboards, bookshelves, luggage rooms, cabinets.

**INTRUSION PROTECTION:** locks, alarms, lights.

**HARDWARE:** types, sizes, numbers required; interior, exterior.

**FIRE PROTECTION:** structural methods, materials; fire-fighting devices, alarms.

**SANITATION:** supply, use and disposal; piping, fixtures, spaces.

**CLEANING:** household cleaning, laundering, equipment.

**FOOD PREPARATION:** spaces, equipment, dimensions, clearances.

**FOOD SERVICE:** accessibility to dining areas; passways, passages, dumbwaiters.

**HEATING:** primary heat source, distribution, local heat sources, temperature control.

**AIR CONDITIONING:** humidification, dehumidification; ventilation, air cleaning; air heating or cooling; temperature and other controls; distribution.

**LIGHTING:** natural, artificial; control of both.

**POWER:** for lighting, heating, motors and other devices.

**SAFETY:** proportions of steps; location of mechanical and other devices; structure.

**COLOR:** light reflectivity, orientation, psychological effects.

**RAMIFICATIONS OF SANITATION SYSTEMS**

- |           |              |               |
|-----------|--------------|---------------|
| EATING    | PLAYING      | HOUSECLEANING |
| DRINKING  | HOBBY-RIDING | CHILD-CARING  |
| REFUSING  | COOKING      | PET-CARING    |
| TOILETING | SERVING      | PLANT-CARING  |
| BATHING   | DISHWASHING  | STORING       |
|           | LAUNDERING   |               |

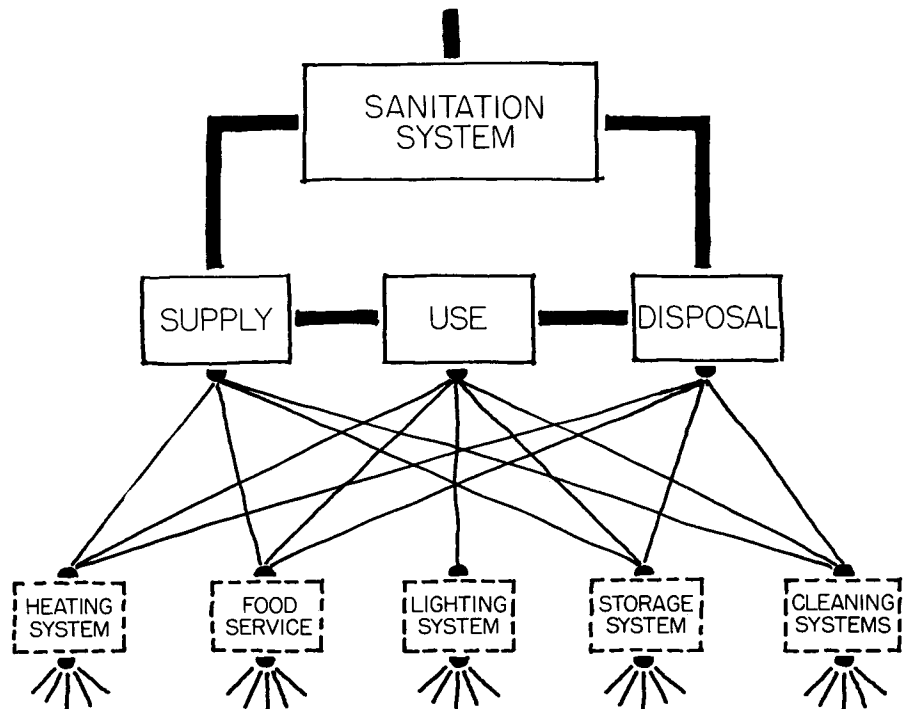

**SANITATION SYSTEMS—1. SUPPLY**

**Water-supply systems may be divided into two parts: (1) the source and type of water; and (2) the piping system, including connections, valves, tanks and other necessary adjuncts. Both involve consideration of health standards, hydraulics, chemistry and plumbing practice. Piping systems consist of cold- and hot-water supply.**

SOURCES of water supply may be classified as public and private. Potability of public water supplies is maintained by governmental agencies, but private supplies commonly relied upon in outlying districts are not always subject to official supervision. The U. S. Department of Agriculture, Bureau of Agricultural Engineering, as well as other agencies, have available data and instructions for installing private supplies such as wells. General precautions to be observed are: Wells of all types should be located at least 100 feet from and on the uphill side of sources of contamination and should be protected from surface drainage by impervious curbs or linings or both.

It should be remembered that even a seemingly properly located well may be contaminated in periods of drought or excessive pumping, when the water table is lowered below the level of sources of pollution. Tests of water from private supplies for potability under all conditions, normal and adverse, by local or state boards of health, are recommended.

**Types and characteristics of water**

Pure water contains hydrogen and oxygen only, but is almost never found in nature. Relative proportions of various chemicals contained in solution determine its suitability for use.

Hard water may be temporarily or permanently hard, depending on whether calcium or magnesium compounds are entirely precipitated by boiling or only partly precipitated. Soap will not lather freely in it; consequently, soap solutions are used to measure hardness, which is expressed in calcium carbonate (CaCO<sub>3</sub>) parts per million (ppm), or grains per U. S. gallon. Water containing 120-180 ppm is the hardest generally considered tolerable, and will probably be only slightly chemically aggressive to piping. Water of greater hardness than 180 ppm will probably not cause pipe failure from corrosion, but may clog hot or cold lines with deposits of a limy nature. Small amounts of such deposits are beneficial in preventing corrosion. Hardness greater than 180 ppm renders water unsuitable for most uses. To soften such water,

many types of mechanical devices are available.

Soft water is likewise a relative designation. A hardness content up to 120 ppm, though noticeable in ordinary usage, may not cause undue precipitation and "liming-up" of system. Hardness caused by sulphates, however, may render waters within this range of concentration extremely corrosive. Waters with hardness of 60 ppm and less can be termed "soft." Such waters are usually corrosive to most piping materials, even including red brass and copper if carbon dioxide content is high.

Aggressive water is the chemical term for water which attacks pipe metal. Aggressive action is, briefly, caused by chemical reactions between dissolved compounds, absorbed gases and metal pipe walls and is electrolytic in nature. Degree of aggressiveness involves alkalinity, concentration of dissolved mineral compounds, extent of free carbon dioxide and "pH value." The pH value indicates extent of hydrogen ion concentration (acidity); chemically pure water having a pH value of 7, or one gram of free ionic hydrogen per 10,000,000 liters. Aggressiveness of soft waters is a corollary of their degree of alkalinity.

Mineral compounds of chlorides and sulphates produce distinctive, often unpleasant tastes in water. Concentrations of chlorine below 10 ppm and of sulphur below 20 ppm are usually not excessive from this point of view. Iron in solution tends to accelerate corrosion of iron and steel pipe; concentrations should be limited to 0.3 ppm. Potable water should not contain more than 0.1 ppm of lead (U. S. Public Health Service).

**Corrosion**

Corrosion may result from hard or soft water. All kinds of pipe have proved satisfactory under certain conditions, but local experience, which may not conform to any theory, should be the primary guide in interpreting water analyses and in selection of piping materials.

The second important consideration is that fittings should be of the same metal as the piping, in order to lessen galvanic action, which may cause corrosion

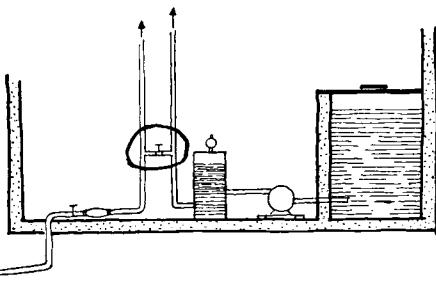
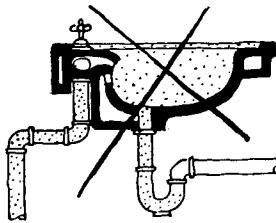
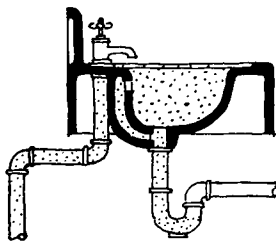

Typical cross-connections resulting in back-siphonage and contamination of potable water. Top: A safe faucet has its outlet at least 1/2 inch above highest possible water level. Similar cases often arise in water closets, particularly those equipped with flush valves which do not leave satisfactory air checks; and in tubs. A direct cross-connection between city water and cistern water, circled in the lower drawing, should be eliminated.

in any water and which will be accelerated in aggressive water.

Chemically, corrosion can be limited somewhat by adjusting proportions of chemical content. Aggressive though comparatively soft water with high carbon dioxide content can be rendered less harmful (1) by passing water through a bed of marble chips or limestone, (2) by aeration, (3) by feeding minute amounts of sodium silicate, automatically proportioned to the flow, directly into the water. Hot water alone may be treated with lumps of sodium silicate placed in tanks through which hot water flows.

**Piping systems**

Normal residential considerations are covered in the accompanying tables and typical riser diagram. Piping should be laid out with a minimum of fittings and turns, and with regard to structural systems.

Pressure required to operate plumbing fixtures satisfactorily is 15 lb. per sq. in. for flush valves and 10 lb. per sq. in. for ball cocks and faucets. These are actual residual pressures at fixtures while system is operating, not static pressures. Street water pressures may be as high as 50 lb. per sq. in. without causing annoying splashing and noises. For constant higher average street pressures, install reducing valves in supply lines at points where mains enter buildings.

To determine whether basement pressure tanks or attic gravity tanks are necessary ascertain minimum street pressure, multiply by 2.3 and subtract 34.5 from the result. Answer will indicate approximate height above street main of uppermost fixture.

**Back-siphonage and cross-connections**

Water pollution may occur with water from any type of source if fixtures and piping are improperly designed or installed. The diagrams show typical examples only. Many more are shown in publications of the Wisconsin State Board of Health and similar organizations.

Back-siphonage results when negative pressures—partial or complete vacuums—in potable water-supply piping draw upon waste water or nonpotable sources for relief. Cross-connections are the means of transfer of unsafe water from waste or nonpotable supplies to systems containing potable water.

Conditions permitting back-siphonage commonly arise when toilet flushometer valves are not equipped with automatic air reliefs; when fixture inlet openings are lower than possible maximum water level; when cistern or other unsafe water—"soft" laundering or washing water—is directly connected to combination faucets to which potable water is also directly connected; when sewage or other pumps are primed with potable water directly connected to the pump and are not protected by properly located check valves and air breaks; and like cases.

Prevention of back-siphonage necessitates selection of fixtures in which bottom of supply or faucet is at least 1/2 inch above maximum possible high-water level; elimination of all direct cross-connections; and protection of all possible indirect cross-connections or doubtful cases with automatic air breaks and check valves. Proper piping design will minimize possibilities of negative pressures within systems, but their entire elimination is almost impossible.

**RULES FOR DETERMINING COLD-WATER AND HOT-WATER CONSUMPTION AND CAPACITIES OF HOT-WATER STORAGE TANKS**

A. Total average water consumption	50 gal. per day per person
B. Total daily consumption of cold water in gallons	50 times the number of occupants
C. Total daily consumption of hot water	1/3 of total daily cold water
D. Maximum probable hourly demand for hot water	1/10 total daily hot water
E. Average hourly demand for hot water	1/24 total daily hot water
F. Capacity of hot-water storage tank (assuming 75% available stored water is hot)	Maximum probable hourly demand minus average hourly demand, divided by 0.75

**Residential supply riser diagram with noncirculating hot water, the most common for houses within this price range. Circulating hot water would require a 3/4-in. hot-water supply and return loop either (1) around basement ceiling, with risers to upper floors, or (2) running to topmost fixture, with laterals or risers to each fixture en route.**

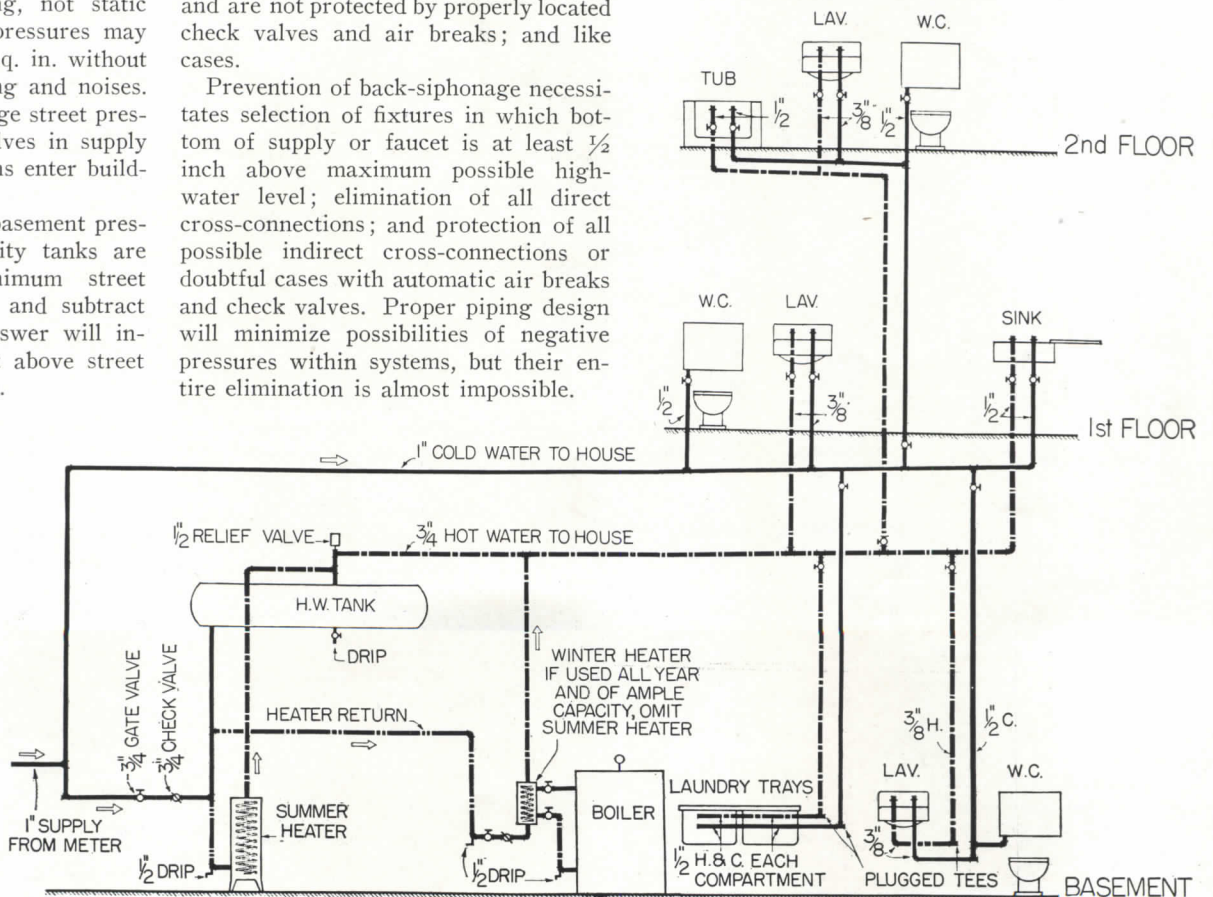

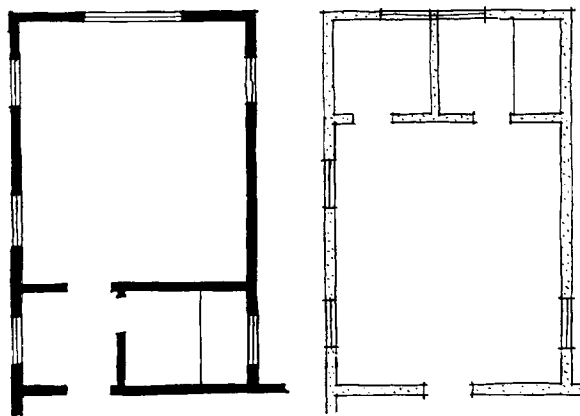

Locating bath-dressing room units at hall end of bedroom will increase available bedroom exposures.

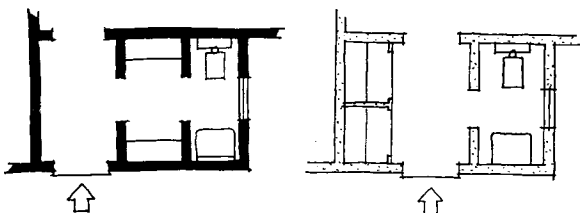

Lavatory at front entrance is quieter and more private when separated from entryway by closets.

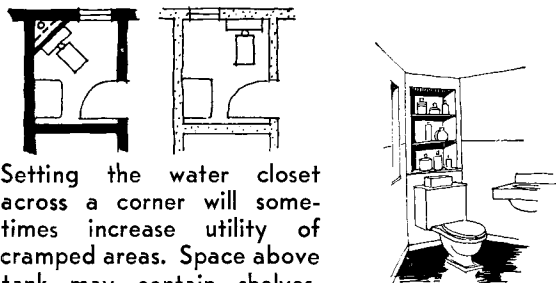

Setting the water closet across a corner will sometimes increase utility of cramped areas. Space above tank may contain shelves.

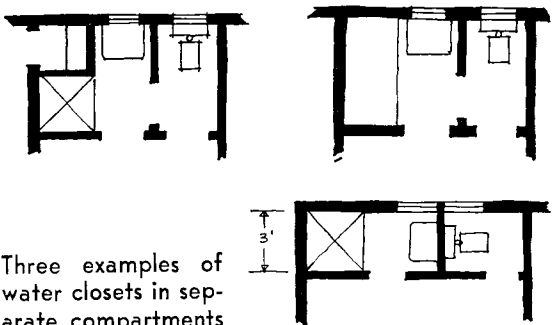

Three examples of water closets in separate compartments

Space-saving layout for lavatory—water closet—shower stall combination

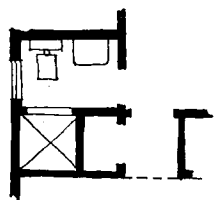

(Drawings adapted from studies by G. K. Geerlings)

**Points of use include lavatories, bathrooms, kitchens, pantries, laundries, hobby rooms, bars, garages, heating and air-conditioning units and outdoor areas. Disposal of sewage comprises traps, waste lines, soil lines, house drains, house sewers and vents.**

**Use areas**

FIXTURES in most use areas should be laid out with reference to the sequence of operations performed, if a maximum of utility is to be attained. In recent years standards based upon exhaustive research have been evolved for kitchens and laundries. Such data can be freely obtained from manufacturers of kitchen and laundry equipment, and from independent bureaus maintained by universities and other agencies. Research by the Oregon and Washington Agricultural Experiment Stations has determined the optimum average height for sinks at which food is prepared to be: 32½ inches from floor to bottom of sink; 31 inches if drainboard is used as a mixing board.

Sinks in hobby rooms and bars should likewise be placed for maximum convenience, but since plans necessarily vary to suit individual requirements, standards are difficult to set up.

Outdoor use points in residences costing \$15,000 or less are usually limited to sill cocks. A safe rule for their location is to provide at least one on each side of a house from which a hose is likely to be used; if the house is long and narrow in plan, provide two or more per side, preferably spaced so that not more than 100 feet of hose will be needed to reach any part of adjacent lawns or gardens.

In garages, a single hose connection may suffice. A slop sink or utility sink is desirable if the budget will permit. Water lines to detached garages, laid underground, should preferably be of lead or copper tubing similar to that used for service mains. In districts subject to freezing weather, sill cocks and outdoor lines should be protected from damage by installing combination stop-and-drain valves within the house.

All types of heating and air-conditioning plants, except warm air units without humidification, require a water supply. This may vary in amount from a minimum of a humidifier pan manually filled and placed in a warm-air furnace to the great quantity automatically fed into some types of air-conditioning systems. The amount and type of delivery of this water supply should be determined by competent heating authorities.

For maximum economy of installation and operation, fixtures in the average bathroom should be located so that outlets are as close together as possible. This does not necessarily mean that fixtures must be lined up against one wall. Fixtures with outlets close together can almost always be served by one soil stack and one pair of hot and cold supplies. In addition to reducing flow resistances within piping, such practice will almost always eliminate the need for excessively cutting structural framing, for changing direction of floor joists or furring ceilings below lavatories or bathrooms. Where possible, plumbing lines concealed in partitions should be erected before partitions are completely framed. Removable panels for access to piping mechanisms are seldom required when modern fittings are used.

Lavatories containing two fixtures only (water closet and lavatory), possibly combined with an auxiliary dressing space or powder room, are preferably located on the first floor convenient to main hall or other circulation. Door location should not be unnecessarily conspicuous. If garages or hobby rooms do not contain sinks, or if lavatories are intended for use by children or adults returning from outdoor play or work, location should be convenient to garage, hobby room or secondary exterior door.

Utility bathrooms contain three fixtures (water closet, lavatory, tub with or without shower). In this class fall baths adjacent to dens, studies and other rooms which can be converted into extra bedrooms. More than one person may use these in certain instances, as when the den is used as a sickroom. More free floor space than the minimum is necessary.

Servants' bathrooms may be reduced to the absolute minimum in size, and usually contain water closet, lavatory and tub. If extra servants are occasionally brought into the house, servants' baths should be accessible from a rear hall, porch or work area.

Private bathrooms adjacent to bedrooms—often the master's room—usually contain a water closet, lavatory and either a tub-shower combination or a

**Sanitation Systems—2. Use and Disposal**

tub and separate shower stall. Since two people may occupy the room at the same time, additional floor space above the absolute minimum is desirable. Installation of two lavatories or one lavatory and one dental basin, and provision of a separate water closet compartment are two means of increasing convenience and privacy.

*Baths serving adjoining bedrooms* generally include a water closet, lavatory and tub-shower combination, or shower-stall only. Problems of circulation are discussed under "Communication Systems."

**Disposal systems**

Drainage systems are composed of three elements: (1) means of removing wastes; (2) means of providing continuous nonmechanical seals or traps between disposal means and open fixture outlets; (3) means of maintaining constant atmospheric pressure and free air circulation in disposal piping.

Soil or waste lines are defined in the accompanying table. House drains are usually separated by building or sanitary codes into those used solely for storm water, those solely for discharge of soil or waste pipes, and those serving both purposes. The latter are often prohibited by local regulations. Pitch of horizontal lines should be ordinarily 1/4" per ft. to permit velocities of flow sufficient to scour the line. If the high point of the street or private sewer is not well below the level of the house sewer, a sewage pump will be necessary or the house drain must be run high along a wall. In this case, basement plumbing fixtures must be omitted. In districts where natural water table is high and sewers may be temporarily flooded, backwater valves are essential. If flooding is regularly recurrent, house drains should be raised above normal or sewage pumps installed.

Pipe sizes, particularly sizes of lateral branch drains, are directly dependent upon actual discharge rating of fixtures. Sizes in the tabulation herewith are normally adequate for residential work, taking into account a balance between the scouring action necessary to prevent clogging, capacity sufficient for peak loads, and such considerations as noise and structural difficulties. For solutions to problems arising from abnormal conditions, consult sanitary engineers, sanitary codes or recommendations of the U. S. Department of Commerce Building Code Committee.

Use of Y and combination Y-and-1/8 bend fittings instead of T-fittings may double stack capacities.

Adequate venting is the only means of maintaining constant air pressures and circulation in waste and soil lines. All air pressures, positive or negative, must be promptly relieved to prevent blowing or siphoning fixture traps. Of the types defined, all have proved satisfactory under specific conditions, but circuit and loop vents may often be dangerous and should usually be avoided. Individual vents are excellent, but connections to trap crowns or tops of waste lines should not be allowed, since scouring of the vent fitting, which is important to disposal system design, is not possible in this method of installation. Individual venting may require additional stacks, furring of ceilings and relocation of plumbing fixtures, if necessary clearances are not provided.

Loop and circuit venting require that the same pipe shall convey both fixture discharge and air, thus constituting "wet venting." This is objectionable because of possible stoppages, lack of free air circulation and decomposition of deposits inside pipes. These types of venting can be used only when drains are oversized, pitched at least 1/4" per ft., fitted with Y or combination Y-and-1/8 bend connections, and when branches are lightly loaded.

Omission of vents to individual traps is permissible only in the case of the highest fixture on a stack, which must be usually within 4 feet of the fixture.

No connection in soil or waste lines should be sharper than 45°. Bends should be made with "long sweeps", except that vents carrying air only can have 1/4-bends. Base fittings, which must carry large flows at maximum velocities without clogging, should always be Y or Y-and-1/8 bend type. Cleanouts should be installed so that every portion of the disposal system can be reached by a plumber's "snake" not longer than 50 feet. However, they should be as few in number as possible. As to traps, simple "P" or "S" types are usually effective as they offer no impediment to smooth discharge flow. Antisiphon or resealing traps are designed to resist seal-breaking pressure in systems poorly designed or installed.

Most sanitary engineers agree that house traps and fresh air inlets are unnecessary for residences. When sewers connect to private disposal systems they should never be used.

**MINIMUM SIZES IN INCHES OF TRAPS, WASTES AND VENTS FOR RESIDENTIAL SYSTEMS**

Bathtub .....	1 1/2
Bath, infant's .....	1 1/4
Shower, single-head .....	1 1/2
Shower, multiple-head .....	2
Lavatory .....	1 1/4
Dental lavatory .....	1 1/4
Laundry tray .....	1 1/2
Sink and tray combination.....	1 1/2
Sink, kitchen and pantry.....	1 1/2
Sink, hobby room, slop sink.....	2
Water closet .....	3
Soil and waste stacks.....	3
House drain .....	4

Data from Subcommittee on Plumbing, U. S. Dept. of Commerce Building Code Committee. Also consult local sanitary codes.

**DEFINITIONS OF DRAINAGE TERMS**

**BRANCH**—Lateral run of pipe from a main soil or waste stack receiving fixture outlets and not directly connected with the main.

**BRANCH INTERVAL**—Section of stack not more than 8 feet long to which are connected one or more soil or waste branches on one floor level.

**DEVELOPED LENGTH**—Length of a pipe along center line of pipe and fittings.

**FIXTURE UNIT**—Measure of rate of discharge from plumbing fixtures in terms of gallons per minute based upon average discharge of a washbasin with 1 1/4-in. trap and waste pipe.

**HOUSE DRAIN**—That part of the lowest piping of a house drainage system which receives discharge from waste or soil stacks and conveys it by gravity to the house sewer. House drain ends outside building wall.

**HOUSE SEWER**—Pipe line connecting terminal of house drain with city sewer.

**MAIN**—That part of a piping system to which fixtures are connected directly or through branch pipes.

**SOIL PIPE**—Any pipe which conveys to a house drain discharge of water closets and other fixtures containing fecal matter.

**WASTE PIPE**—Pipe which conveys discharge of any plumbing fixture except water closets and other fixtures receiving fecal matter to waste or soil stacks or house drain. An indirect waste does not connect directly with a stack or house drain.

**STACK**—Any vertical line of waste, soil or vent piping.

**VENT**—Any pipe provided to ventilate a house drainage system and thus to equalize air pressures in soil and waste pipes to seals.

**Bow Vent**—Adaptation of individual venting to avoid installation of vent stack to free-standing fixtures. The vent line is brought over the fixtures and down again to connect with the main vent stack below floor line.

**Circuit Vent**—System of venting in which the upper end of a branch line is connected above the fixtures to a main vent stack on the side of the branch opposite to the main stack.

**Loop Vent**—A system of venting in which the upper end of a branch line is connected above the fixtures to a main vent stack adjacent to the main stack.

**Yoke Vent**—A method of increasing the efficiency of any venting system by connecting the main vent and soil stacks in any branch interval. Connection to the vent stack is always above the soil stack connection.



Frank Randt

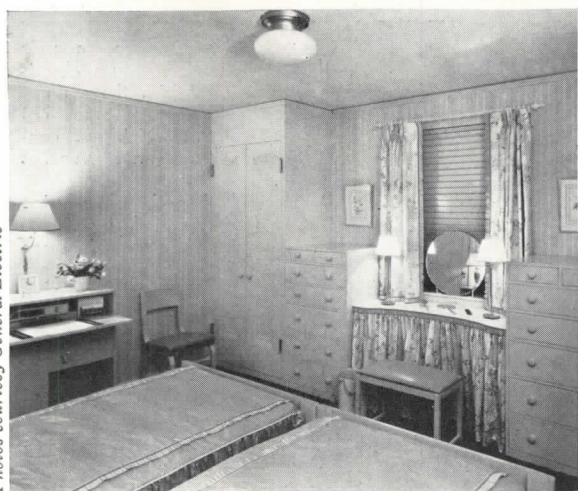

Photos courtesy General Electric

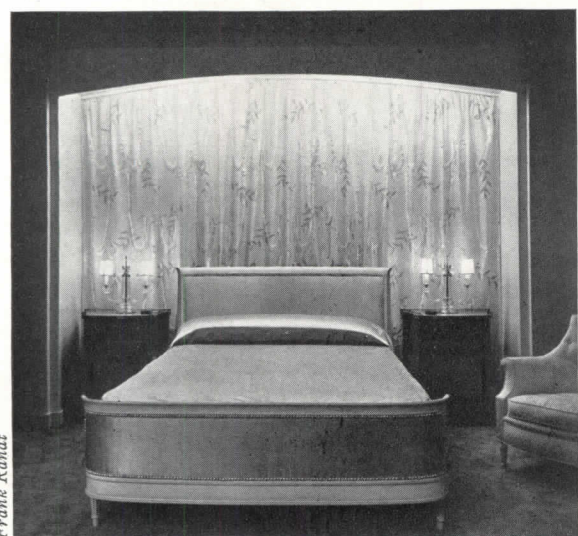

Frank Randt

Variations between even general illumination and high concentrations where needed are useful in relieving monotony. Care must be taken to eliminate glare, harshness and sharp shadows. Top: Living room with built-in indirect lighting. Center: Inexpensive and functionally satisfactory bedroom fixtures. Bottom: Specialized bedroom application.

**Residential lighting should be entirely without glare and should be so distributed that dark shadows and extreme contrasts are eliminated. Illumination levels should not be lower than scientifically established minima. Light sources should be controlled to maintain a ratio not greater than ten to one between local and general illumination, and should be secondary to the lighting effect produced.**

BOTH NATURAL and artificial light are important to residential lighting systems. Methods of controlling natural lighting include blinds, shades and exterior planting as well as orientation of the house, window size and placement, and dimensions of areas to be lighted. Portions of the following data on artificial lighting systems are also applicable to natural lighting.

**Artificial lighting**

Artificial lighting of residences is usually lower in general intensity than in commercial structures, since high uniform levels are usually associated with work areas. For illumination of specific tasks, localized high-intensity lighting is used, quantity of light being dependent upon the nature of the task performed, as noted in the table on the facing page. This dual lighting—general and local—may be obtained from portable lamps, wall and ceiling fixtures, and built-in fixtures. Types of light emanating from all three sources depend on the character of the source and the manner in which it is used.

*Indirect lighting* is entirely reflected; a large source directs light upon the upper walls and ceiling. Desirable features are maximum softness of shadows, uniform spread and absence of glare; it is an excellent source of general illumination, but when built in is often too expensive for residences costing less than \$15,000.

*Semi-indirect lighting*, in addition to functioning as indirect lighting does, transmits primary or nonreflected light to lower walls and floor. Where maximum softness and diffusion are unnecessary, semi-indirect lighting may increase illumination levels without increasing wattage.

*Direct lighting* may provide highest possible level of illumination from a given wattage but may also introduce high brightness, glare and hard shadows.

Combinations of all three kinds of lighting may be obtained from any or all types of sources for uniform general illumination. Other factors are room dimensions and number of light sources. Lighting engineers have evolved a rule of thumb, sufficiently accurate for most

purposes, as follows:

*Spacing between fixtures may be one and one-half times distance between horizontal plane at which uniformity is desired and position of light source.* This desirable minimum is seldom achieved in residences with ceiling fixtures alone. Wall brackets often introduce glare, and are usually supplemented or replaced by portable fixtures.

**Control**

Lighting may be controlled as to quantity by the wattage employed, number of sources, reflectivity of room finishes and selection of fixtures or portable lamps. Adequacy of wiring is important; wires too small for their length of run, number of outlets and total wattage used, cause noticeable drops in efficiency. In general, and in spite of National Electrical Code and other minimum requirements based on safety only, authorities are agreed that wiring for lighting should not be smaller than No. 12 AWG. Wire for long runs, great numbers of lamps or large wattages should be increased in size.

Quality of light is also controlled by all the foregoing factors, with particular emphasis on fixture selection and relation of general to localized lighting. Fixtures are classified according to the degree of directness of light transmitted. It is necessary to consider whether the light source is visible, causing glare; whether shades or coverings transmit sufficient light or so direct the light that hard shadows are avoided; and, above all, the relationship of the fixture selected to other fixtures and to the space in which, and the task at which, it is to be used.

Mechanical means of control include switches, convenience outlets and fixture outlets. Standards of adequacy have been set up by the Industry Committee on Interior Wiring Design, and are available to the public. In brief, they are as follows:

*Lighting outlets:* At least one wall or ceiling outlet is desirable for each porch, front entrance, living room, bedroom, reception hall, library or den, recreation room, enclosed porch, dining space, etc. When ceiling outlets are sole sources of



general illumination: in rooms (1) with area greater than 400 sq. ft., (2) with length more than twice their width, or (3) with extremely low ceilings, two ceiling outlets may be required. Halls with stairways require one lighting outlet at each floor to illuminate head and foot of stairs. Kitchens and other work areas require one centered ceiling outlet for general illumination, with local lighting from ceiling, wall or built-in fixtures over work centers. Bathrooms require a ceiling outlet plus wall outlets at each side of mirror. In baths less than 60 sq. ft. in area, ceiling outlet may be omitted. Closets 3 feet or more deep, or more than 10 sq. ft. in area, require one outlet unless shelves interfere. Basements and attics require stair lights, one ceiling outlet and one outlet per enclosed space or work center.

**Switches:** Sources of general illumination should be switch-controlled; and if doorways commonly used as exits and entrances are 10 feet or more apart, multiple switching (3-way, etc.) is desirable. Stair light switches should also furnish multiple control. Switches for totally enclosed or little-frequented areas (closets, attics, cellars, garages) should be either automatic door-operated type or equipped with pilots.

**Convenience outlets:** For lighting, convenience outlets should be placed so that no point along the floor line in any wall space unbroken by doors is more than 6 feet from an outlet—with at least one convenience outlet in every space 3 feet or more long at the floor.

**MINIMUM RECOMMENDED ILLUMINATION FOR HOUSEHOLD ACTIVITIES**

Visual Tasks	Footcandles
<b>Reading</b>	
Ordinary reading, books, magazines .....	10 - 20
Prolonged reading, fine type ..	20 - 50
<b>Studying</b> .....	20 - 50
Writing or typewriting .....	10 - 20
Card playing or games .....	5 - 10
Drafting or other detail work ..	50 - 100
Bench work .....	10 - 30
<b>Handicrafts</b>	
Weaving, knitting, etc. ....	10 - 30
<b>Sewing</b>	
Ordinary, on light goods .....	10 - 20
Prolonged, on light goods .....	20 - 50
Prolonged, average sewing .....	50 - 100
Fine needlework on dark goods ..	100 or more
<b>Playing</b>	
Children's games, etc. ....	10 - 20
Kitchen work centers .....	10 - 20
Washing and ironing clothes .....	10 - 20
Shaving, make-up, etc. ....	10 - 30
Walking up and down stairs .....	2 - 5
General circulation in rooms .....	2 - 5

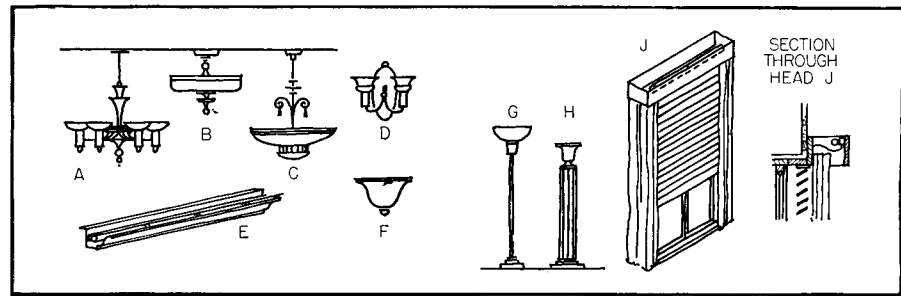

Indirect and semi-indirect lighting. A, B and C: Ceiling fixtures with one to five reflecting bowls. Opaque bowls furnish indirect light; translucent bowls, semi-indirect. D and F: Wall fixtures similar to A, B and C. E: Prefabricated cove with Lumiline lamps. G and H: Indirect floor torchere and urn, requiring shades if bowls are translucent. J: Continuous lighting in open-top valance box for both general indirect light and local light.

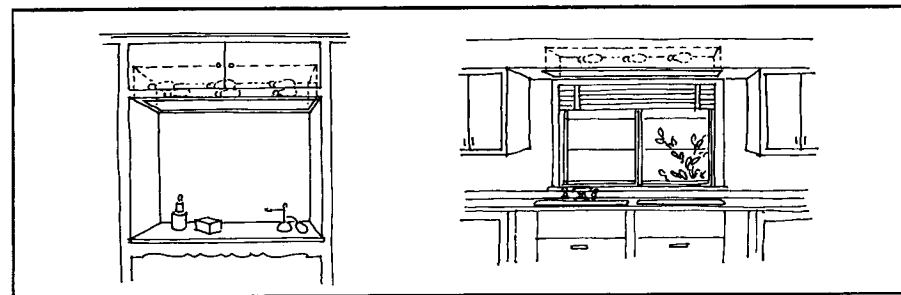

Built-in soffit fixtures for local lighting. Dressing table side and table-top mirrors make side lighting unnecessary.

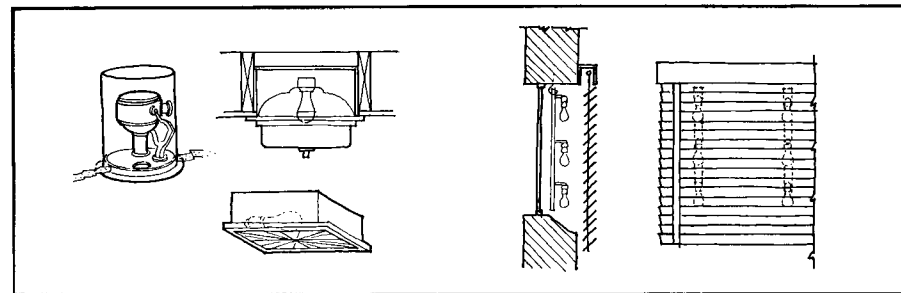

Methods of building in lighting units. Projector-type is set with bottom plate flush with plaster; a hole 1 1/2 inches in diameter transmits a beam of light which can cover a 6-ft. table. Other ceiling units: above, reflector, 100-150-watt silver-bowl lamp and shallow-etched glass bowl; below, 12-in. square prismatic glass, 100-150-watt lamp. Strip lights, 9" to 12" o. c. behind Venetian blinds, furnish indirect light.

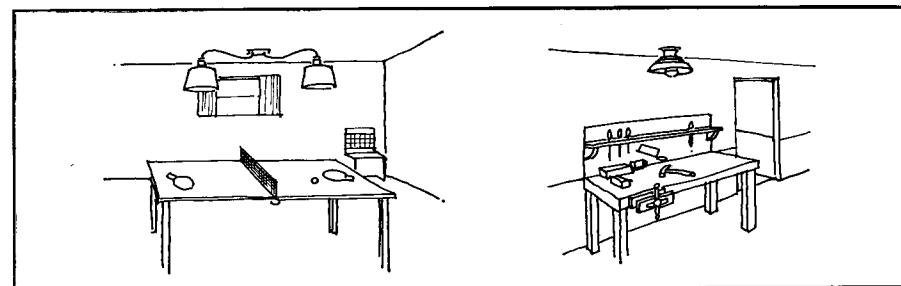

High intensity local lighting: ping-pong table, two 150-watt lamps, shades (8 1/2" deep, 5" top diameter, 14" bottom) to prevent glare. Workbench light, silver-bowl lamp, 12-in. dome reflector for 100-watt lamp, 14-in. for 150-watt.

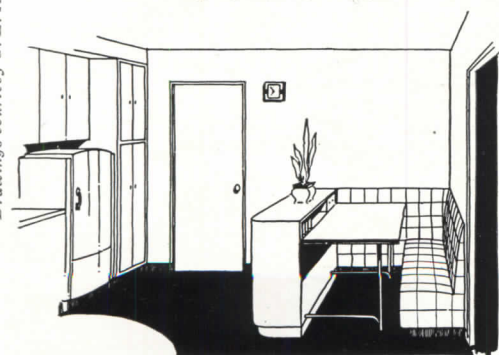
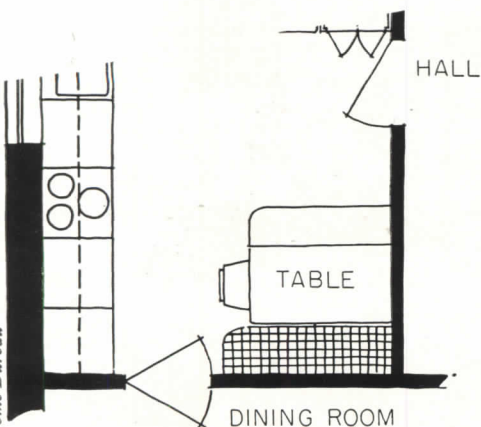
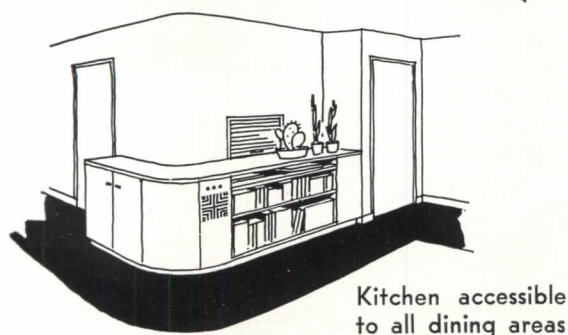
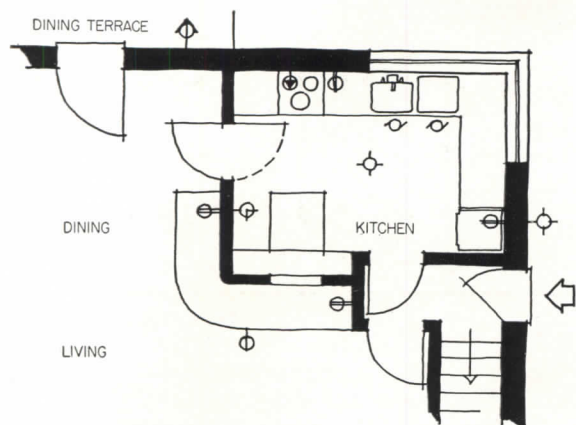

**Dining alcove which serves also as a kitchen planning table and serving table for dining room service**

**Convenient food service requires convenient circulation, ease of communication and storage space. Built-in passways or dumbwaiters, dish, linen and silver cupboards, and fixed or semifixed dining furniture may be considered. All portions should be unobtrusive when not in actual use; and transmittal of undesirable noises or odors should be minimized.**

DIRECT FOOD SERVICE between the kitchen and a space set apart for dining only is not the sole consideration. People eat in many portions of the house: in dining rooms, breakfast or dining alcoves, on terraces or other outdoor dining spaces; and in recreation rooms, bedrooms, living rooms, sickrooms and quiet rooms.

Circulation in all the foregoing areas should be as direct as possible.

**Vertical circulation**

Since not all dining activities occur often on one floor, stairs should be quickly accessible from the kitchen, preferably without the necessity for obstructing upon general living areas en route. Easy access is particularly desirable from kitchens to recreation areas; this may in some cases render it advisable to locate basement stairs independently of other flights, even at the expense of floor space. Recreation room stairways often open from a small secondary hall or alcove which, besides having a door to the kitchen, may lead to a garage, quiet room or other isolated portion of the house. If any stair, basement or other, is to be used for food service, its ratio of riser to tread should fall within the comfort range, of which the optimum is approximately a 7-in. riser to an 11-in. tread.

Dumbwaiters, another means of vertical circulation, are available prefabricated or may be specially built. Dumbwaiter service between kitchen or pantry and basement recreation room is exceedingly convenient and may be used as well for transporting supplies from a basement liquor or preserve closet to the first floor.

**Doors**

A double-acting door is commonly installed between the dining room and the kitchen or pantry, but has certain definite drawbacks. The necessarily loose fitting produces cracks through which sounds and odors easily pass, and if more than one person serves food

through a double-acting door, there is the hazard of collision. To remedy the first, doors can be fitted with flaps of rubber or other flexible, easily cleaned material. For the second, since two doors are seldom installed, the only remedy seems to be insertion of a small glazed panel at eye level. The glass may be slightly obscure or curtained; or the door so located that from the dining space a direct view of the entire kitchen is not possible.

Swing of doors opening into food preparation areas should be determined from that side. The possibility of opening the door so that it blocks off a portion of a counter should be avoided. A door swinging against a counter end, or preferably a blank wall, is more desirable.

**Passageways**

Halls or passages between cabinets or furniture extending above elbow height, or between seated persons and a wall, should be approximately 3'-0" wide or wider for maximum convenience. Between items of equipment of less than elbow height, or between seated persons, 2'-6" to 3'-0" is desirable. The survey made by the Washington and Oregon Agricultural Experiment Stations gives minimum dimensions of 1'-5" between low obstructions and 1'-9" between high ones, but these measurements applied to food service around seated people would cause difficulty, and should be increased wherever possible.

The plan relationships between food preparation areas and halls are discussed under "Communication Systems."

**Equipment**

Food service requires storage for linens, china, glassware and silver. For estimating required storage space, the following rule has been evolved:

"For complete table service for 12 people, including china, glass, linen and silver, without duplication or reserve

Drawings courtesy G. E. Home Bureau

space, allow 6'-0" of linear wall space fitted with upper cabinet with three shelves 12" wide (18 lineal feet), and lower cabinet with two shelves 20" wide." This will accommodate a complete dinner service, luncheon set, breakfast set, tea set and salad service; in addition to a dozen each of tumblers, grapefruit, cocktail, sherbet and cordial glasses, finger bowls and comports; and a punch bowl, pitcher, decanter, vases, candlesticks, etc. Drawers for flat silver should be 2" to 3" high and fitted with division strips, front to rear, 2" and 3" on centers. Drawers for doilies, 2" to 3" high; for mats or runners, 3" to 3½"; for napkins, tablecloths, 6" to 8½"; for table pads, 8" to 10".

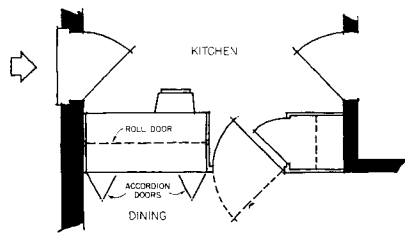

Here passway cupboards are so located and constructed that need for a structural partition is eliminated. Materials which will not shrink and cause cracks, and good workmanship, are necessary to reduce sound and odor transmission.

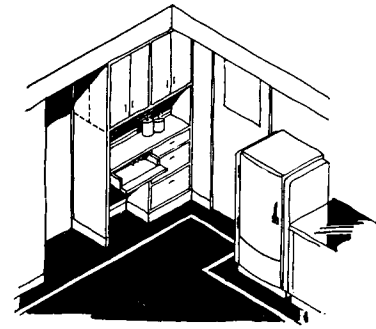

Passways, as shown in the drawings, should have doors both sides, accurately fitted to reduce sound and odor transmission. Interference between doors and objects on counters can be prevented by using top- or side-rolling slats, narrow folding doors or doors hinged to drop down, possibly forming a counter extension.

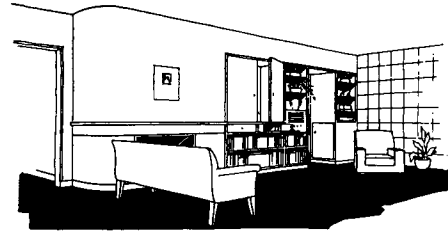
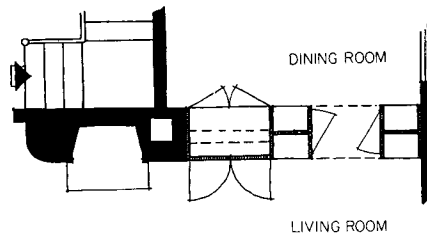

Drawings Courtesy G. E. Howe Bureau

Equipment may also include a dish-warming cabinet, towel dryer and tray and platter storage space. Plate warmers may be heated by electricity, gas, steam or hot-water coils. Towel dryer may consist of sliding racks in a ventilated cabinet, heated either independently or by a room radiator. Trays may be stored on edge in vertical racks, or horizontally in deep shelves with drop fronts for easy accessibility. At least one duplex convenience outlet for toaster, waffle iron, percolator or chafing dish should be within easy reach of the dining table, or may be incorporated in built-in tables or seats.

Another nonstructural partition. Interior views shown (above, from living room side; below, from kitchen) illustrate complete and practical utilization of the space around an interior chimney — often awkwardly handled.



Storage space for tableware is not usually located within kitchens of houses costing from \$7,500 to \$15,000. Use of a pantry reduces possibilities of sound and odor transmission and aids in screening kitchen operations from dining areas; and if the pantry is equipped with a refrigerator, it may serve to segregate preparation of cold foods as well as preparation of coffee, toast, etc., from cooking activities.

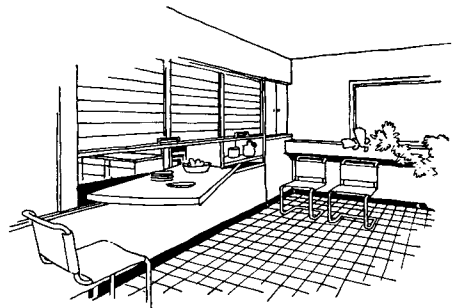
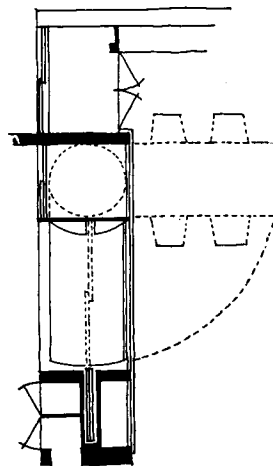

A combination of passway, disappearing table and storage space used in a house in Tokyo. Iwao Yamawaki, Architect

F. S. Lincoln



Van Anda

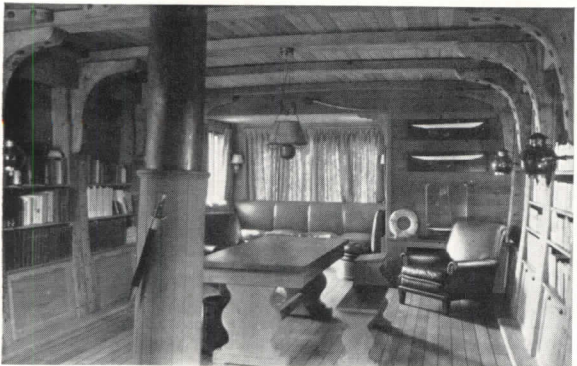

F. S. Lincoln



Top: Built-in bookcases, desk and radiator in residence of Frank B. Foster; Oscar Stonorov, Architect. Center: Storage spaces in hobby room of Briggs Cunningham; Visscher and Burley, Architects. Bottom: Liquor storage cabinet, residence of Ira Younkers; Joseph Aronson, Decorator.

**Dimensions of objects commonly requiring storage space and sizes of portable furniture were given in the March, 1938, issue of the RECORD. Built-in storage spaces of all types, including closets, cupboards, dressers, shelves and bins, are covered in the following discussion.**

CLOSETS for storage of personal effects may vary from those equipped only with shelf, pole and hookstrip to those completely outfitted with drawers, racks and trays. The former are advisable when use requirements are likely to be varied or uncertain, as in closets off first-floor dens sometimes used as emergency guest- or sickrooms. The latter are highly desirable in dressing rooms, or as small dressing closets adjacent to bedrooms. Overclothing closets are located preferably convenient to entrances; and trays, grids and special hanging spaces for wet-weather clothing, all equipped with removable drip pans, are often included.

*Closets for children's use*, if equipped with shelf, pole and hookstrip units adjustable in height, can be useful in educating children to self-help. Adjustments should be possible from 3'-0" above the floor to 6'-5" or 6'-8", the usual maximum adult height, in approximately 4-in. intervals.

*Utility and staple storage closets* range from liquor or preserve closets in basements to linen closets, including space for foods, cleaning utensils and all housekeeping necessities. Sizes, equipment and construction of kitchen and pantry cupboards are well standardized; additional information on these is available from homemaking bureaus maintained by manufacturers and from independent agencies.

Liquor closets for bulk storage should have provision for storing bottles on their sides, with pigeonholes, honeycombs or other devices to keep containers from rolling. Location should be such that contents are kept at even, moderately low temperatures. Walls of masonry or insulated frame construction are ideal and locks should be provided.

Preserve and vegetable closets and bins similarly require even, moderately low temperatures. In addition, vegeta-

ble storage space needs ventilation. Bins or shelves should be raised above floor level and constructed of slats or mesh; and doors may have screened ventilating panels. Tight screening is usually needed for protection from insects. Preferred locations are in basements, service entries or other utility portions of the house. When accessible to outsiders, it may be desirable to provide locks for doors.

Spaces for storage of equipment used in outdoor activities should be included in the house or incorporated in garages or other outbuildings. Access is preferably direct from outdoors, or immediately adjacent to secondary exterior doors. Access through garages, kitchens or other work areas is likely to interfere with other activities. Equipment to be stored includes bicycles, roller skates and other outdoor play equipment for both children and adults, as well as gardening tools, etc.

Fuel storage for heating systems involves space for liquid or solid fuels. Small liquid fuel tanks are sometimes permitted indoors, but a better location is outdoors and underground, convenient to a road or driveway for easy filling, yet close enough to heater location to reduce piping to a minimum. Larger tanks — above 550-gal. capacity — require less frequent servicing and are desirable where delivery service is infrequent. The minimum solid fuel storage bin recommended by fuel producers contains 220 cu. ft., or 5.83 tons, of anthracite coal. To determine contents for solid fuels, multiply cubic feet contained by 0.015 for coke, 0.0235 for bituminous coal, or 0.0265 for anthracite. Location of solid fuel bin inside house, adjacent to a road or driveway, will usually reduce delivery charges.

Housekeepers' closets should contain hooks or clips for hanging mops, brooms, pails; free floor space for vacuum cleaners and carpet sweepers; and shelf space for bottled or packaged cleaning materials. Desirable locations place one such closet on each floor

where activities are normally carried on, closets being accessible from main circulation and service portions of the house, but not obtrusive.

Built-in cupboards, dressers and bins are illustrated on this and other pages. In building such equipment as drawers into closets fitted also with doors, care should be taken to provide sufficient clearance for drawers when closet doors stand open at 90°. Clearance of 2 inches between back of door rebate and edge of drawer is generally sufficient.

Children's bedrooms, playrooms and nurseries should have shallow, low cupboards. Great depth will cause articles at back of shelves, etc., to get lost. Modern educators do not recommend the old-fashioned toy box. It is possible to build children's cupboards of light yet strong materials, so that they are easily used; and to make portions of them adjustable as recommended for children's clothes closets, so that heights can be changed as the child grows.

**DESIRABLE DIMENSIONS FOR STORAGE SPACES**

	Inches
<b>Minimum toe space:</b>	
Width (front to back).....	4
Height .....	3
<b>Maximum height of shelf for articles in frequent use:</b>	
a. No obstruction—	
Shelves for books and light-weight articles .....	79
Shelves for plates, hats, bedding .....	74
b. Obstruction 12 inches wide (as in reaching over work counter)—	
Shelves for books, etc.....	76
Shelves for plates, etc.....	71
<b>Maximum height of shelf visible throughout entire width.....</b>	<b>61</b>
<b>Maximum height of drawer.....</b>	<b>59</b>
<b>Maximum height of knobs, latches, switches and controls, locks, hooks:</b>	
No obstruction .....	79
12-in. obstruction .....	76
24-in. obstruction (as in reaching over sink to window latch) ..	69
<b>Maximum height of pole in clothes closet .....</b>	<b>81</b>

Based on surveys made by Evelyn H. Roberts and Maud Wilson of Washington and Oregon Agricultural Experiment Stations.

Narrow, deep closets shown at right may be converted to more efficient shallow ones—right, below. Perspective of beds indicates possible storage shelves and night tables.

(Courtesy G. E. Home Bureau)

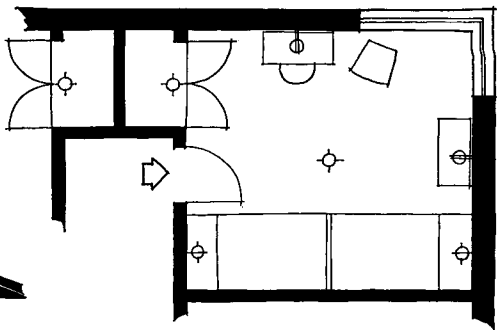
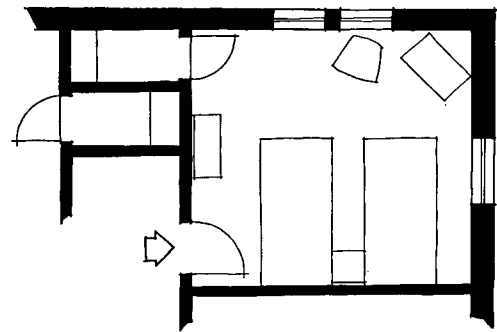
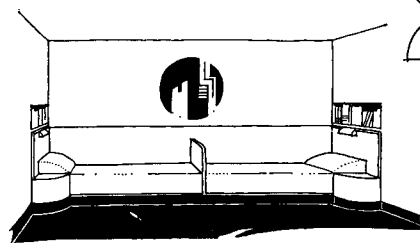

Storage spaces at a fireplace. Section at left shows concealed storage; seats should be 16 to 18 inches high.

(Adapted from studies by G. K. Geerlings)

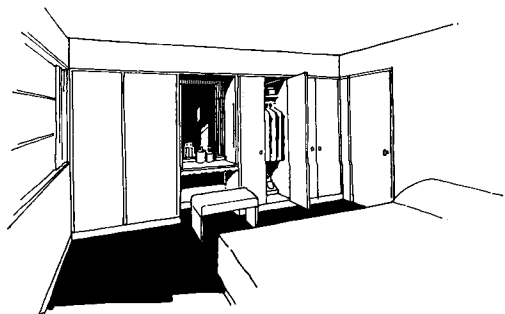
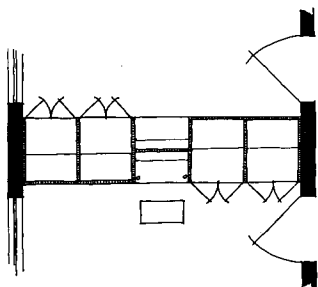
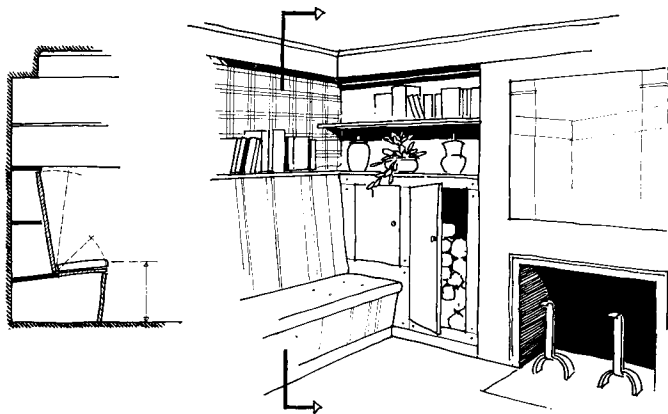

Utility partition such as is developed by Beatty and Strang, Architects, for use between bedrooms. Doors, etc., should be accurately fitted and partitions between dressing alcoves doubled to reduce sound transmission. Addition of full-length mirrors on doors would increase utility.

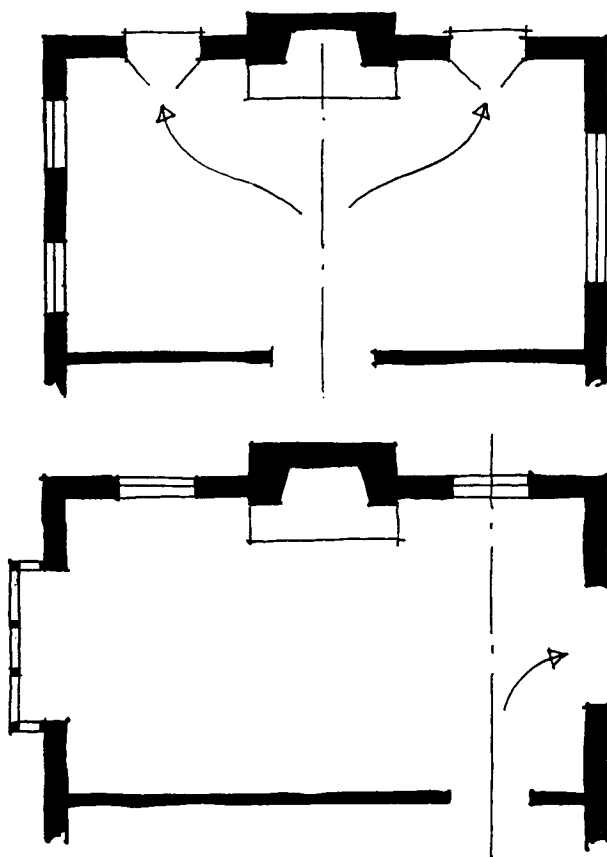

Relation of doors to fireplace should be such that circulation does not interfere with activity space, as it does in top plan.

(Adapted from studies by G. K. Geerlings)

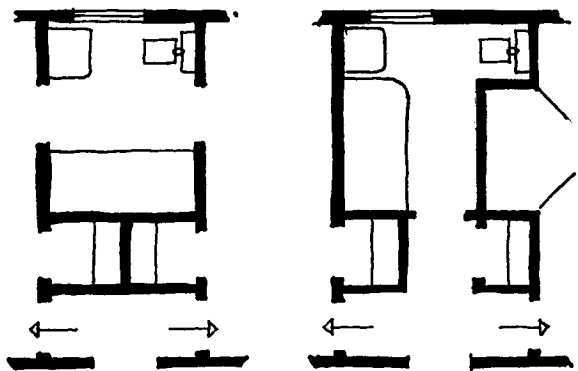

Circulation through a bathroom common to two bedrooms reduces privacy and convenience; better plan shows access through a common corridor.

(Adapted from studies by G. K. Geerlings)

Adequacy standards prepared by the Industry Committee on Interior Wiring Design form the basis for the following recommendations for electrical communication systems. In addition to these, means of physical communication and access from space to space in and about the residence—the circulatory system—are also discussed.

BELLS, BUZZERS AND ANNUNCIATORS require an outlet for connecting a bell-ringing transformer (usually more satisfactory than battery operation) with low-voltage wiring, consisting of braided rubber-insulated wire not smaller than No. 18 AWG, to a push button at each outside door. Signaling devices should be bells of differing tones, or bells and buzzer, usually located in the kitchen. In addition, a foot- or hand-operated push button in the dining room will be found convenient, and may be connected to a signaling-type floor receptacle fitted with a plug of a kind which cannot be inserted in convenience outlets. Annunciator systems will be found more convenient than bells or buzzers if calls are to be received from more than three different places.

For outside telephone service at least one outlet box on each active floor is recommended. Wiring should be concealed. Data on conduit sizes and outlet locations may be obtained from the telephone company. Intercommunicating telephones are seldom required for houses in this price range.

Desirable for radio are at least three outlets for antenna and ground connections, usual locations being living areas, recreation areas, kitchens and bedrooms. Unless another method at least equivalent is specified, a twisted pair of No. 18 rubber-insulated wires should be carried from each antenna outlet to aerial location, usually the attic. Not all types of antennas can satisfactorily accommodate more than one receiver. Antenna leads do not require rigid enclosures, but provision of solid raceways will facilitate changes as the science of radio and television advances. Flexible raceways or armored cable are not advisable. Ground connection should be No. 14 copper wire connected to a water pipe; and for outside aerials, lightning arresters are recommended. It is the opinion of some engineers that radio mechanisms should be incorporated in built-in equipment for best results.

**Circulation**

Circulation may be subdivided for study into three parts: (1) Passage-

ways, whether controlled by walls as in halls or suggested by furniture groupings in more open areas; (2) means of direct access, as between communicating bedrooms; and (3) vertical circulation, as stairs.

The minimum entrance hall often contains only space for entrance door swing and one or two persons. From it should usually be accessible first-floor living quarters, stairs to second floor, and space for overclothing storage. Further considerations should include accessibility directly from service portions of the house without necessity of traversing occupied living areas; and accessibility of powder rooms or lavatories. These last are often adjacent to first-floor studies, dens, libraries or guest rooms. Access to basement living areas is also desirable, but is sometimes more convenient from other areas than halls. If space considerations permit, room for a chair for waiting visitors may be provided. Minimum clear width for an enclosed hall, exclusive of stairs, is approximately 3'-0".

Second-floor halls should provide access to a bathroom for general use, to each bedroom, and to utility and linen storage spaces. Corridor-type halls along an exterior wall use wall space which might be made available for bedroom windows or furniture. Natural lighting may be obtained through the stair hall or from windows at the end of the hall; this points to a location approximately in the center of the plan as one solution. Special planning factors may of course lead to different solutions.

Circulation through activity areas should be unimpeded by furniture groupings or other equipment for normal living activities. Observance of this principle will increase comfort of persons occupying the activity areas as well as increasing accessibility of all portions of the house, and in some cases eliminating necessity for extensive enclosed halls. Examples of common violations of the principle and methods of correcting them are given in the drawings.

Means of direct access, in addition to comprising the obvious item of doors, may be extended to cover access to utility spaces common to two or more activity

areas, illustrated by the accompanying plans of a bathroom serving two bedrooms, and access between first-floor service areas and main entrance. There should be access either through the main hall as noted before, or by two alternate routes through activity areas. A kitchen adjacent to the main entrance may have a door to the entrance hall. Kitchens remote from the main entrance necessitate either large hall areas or double routes.

Directly communicating doors between parents' bedrooms and children's bedrooms may prove undesirable as the child grows older or with change of occupancy. Another solution is to provide a door from each room into a small semiprivate hallway or alcove.

Most building codes determine dimensions of stair treads and risers, and sometimes width, rather closely. Several formulas for tread and riser ratio are available. The most important are: tread in inches plus riser in inches shall not exceed  $17\frac{1}{2}$ ; their product shall not exceed 75; and the hyperbolic formula developed by Ernest Irving Freese, which may be solved mathematically as follows: if R is fixed,  $T = 5 + \sqrt{7(9-R)^2 + 9}$ ; or if T is fixed,  $R = 9 - \sqrt{1/7(T-8)(T-2)}$ . All have proven satisfactory, the first two within limits which usually necessitate checking against one another. In all cases width of tread is exclusive of nosing.

Stairs designed for comfortable human passage only may be 2'-0" minimum for one person to 3'-6" for two persons abreast. Usual averages are 2'-6", 2'-8" or 3'-0". Furniture clearance usually requires from 2'-8" to 3'-0" in residential stairways, depending upon dimensions of turns and landings and upon headroom available. Ideal handrail height is considered to be from 2'-9" to 2'-10".

In two-story-and-basement houses, if stairs are located directly over one another, the necessity for headroom can be accommodated without wasting space, and the small inconveniently shaped spaces where stairs join floors can be reduced to a minimum. It should also be borne in mind that while open-well stairs make for easy furniture passage and may be in other respects desirable, such stair wells are difficult to heat and may use up an excessive amount of space. As with all problems of circulation, all possible factors must be balanced one against the other and a decision reached in view of the particular conditions at hand. No one solution will satisfy all cases.

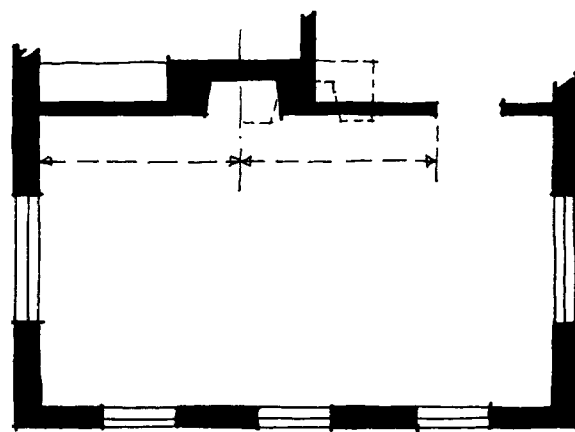

Wall space around fireplaces or other focal points, in both above cases, is least useful when fireplace is centered on room. Center of interest should be located away from circulation routes.

*(Adapted from studies by G. K. Geerlings)*

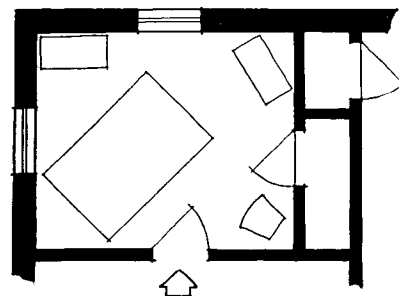
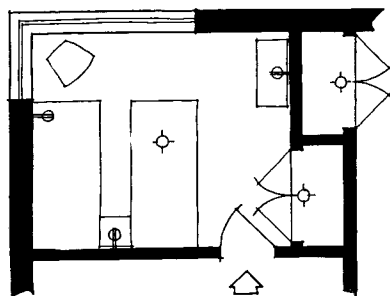

Poor door and window spacing hamper furniture placement and circulation in bedroom plan at right. Plan at left shows improvement also in closet usability.

*(Drawings courtesy G. E. Home Bureau)*

Minimum passage clearances determined by Washington and Oregon Agricultural Stations: W (obstructions less than elbow height) equals 1'-5"; W' (higher than elbow), 1'-9". See also "Food Service Systems."

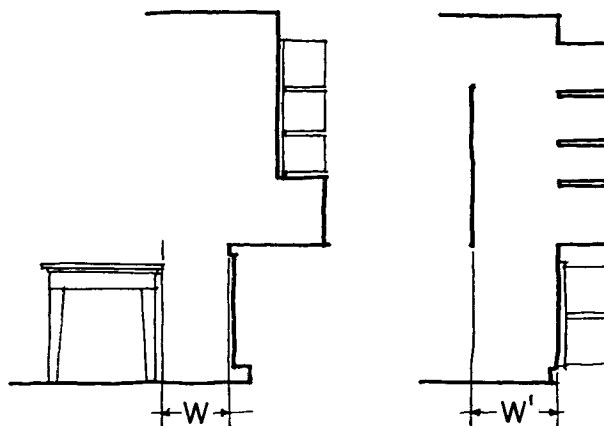

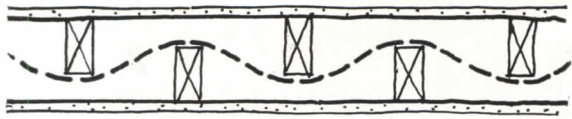

Construction methods are important in retarding passage of air-borne noise. Above: an effective double-stud wall with no connections, spikes, etc., between independent faces reduces transmission about 50%. Added cost of flexible or rigid board "sound-curtains", as indicated by dotted lines, is usually justified. Method is also applicable to floors. Sound is easily transmitted through thin floors, into duct-like spaces between joists, under partitions and back through floor into adjacent rooms. To overcome this, concrete floors on bar-joists have sufficient density; in wood construction, insert under partitions continuous wood blocking or two thicknesses of  $\frac{3}{4}$ -in. building board.

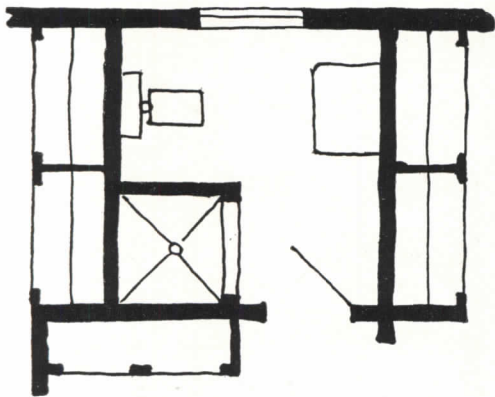

Isolating noise sources with closets

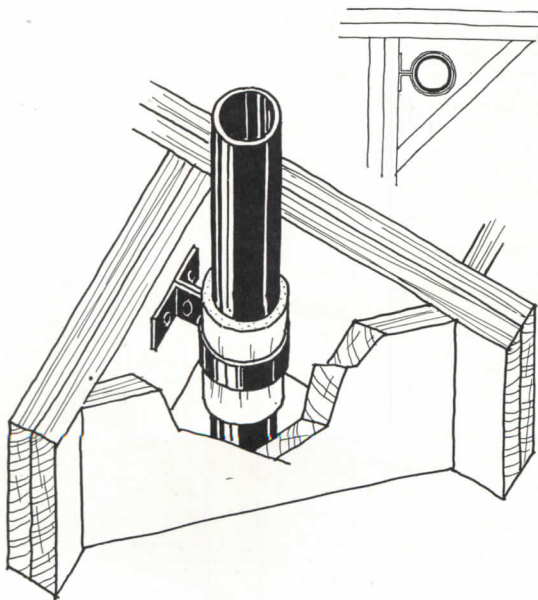

REVERBERATIONS of sound within areas and impact noises can easily be diminished by using rugs, hangings and upholstery of a sound-absorptive nature. Reverberation can also be lessened by using sound-absorptive finishes on ceilings or walls of noisy spaces. Many products designed for this purpose, in forms of tile, wallboard and sound-absorptive plaster, are available. However, muffling sound within a space will not necessarily prevent its transmission to other spaces. For instance, in a ping-pong room finished with sound-absorptive materials, the sound of the ball hitting the racket will in many cases be confined to the recreation room; but the sound of the ball hitting the table may penetrate to other rooms. The table legs rest in intimate contact with a portion of the residence structure, and act as sound conductors. Methods of minimizing conducted sound are discussed later.

Treatment with sound-absorptive finishes or furnishings may have value in rooms where undesirable noises originate, such as recreation rooms, dining rooms, kitchens, butlers' pantries, servants' recreation rooms, workshops, nurseries and uncarpeted corridors. In bars and game rooms, treatment of four walls and ceilings may be necessary for maximum results; otherwise, ceiling treatment only is generally sufficient.

Air-borne noises which penetrate from outdoors or from noisy to quiet areas within the house, are in the great majority of cases transmitted through open windows, through cracks around

Left: Hanging soil pipe to minimize conducted sound. Continuous sound insulation will increase results and aid in preventing freezing and condensation. Blocking soil against joists or using metal hangers not insulated from pipe by hair felt or similar substances will nullify all precautions.

Undesirable noises in residences are in general transmitted in two ways: by air (air-borne sound) and by portions of the structure (conducted sound). Air-borne noises filter principally through cracks around openings. Conducted noises result from lack of forethought in planning or from undesirable construction practices.

openings, and to a lesser extent through glass areas and thin door panels. In extreme cases, windows can be sealed and ventilation obtained through sound-baffling ventilators. Weatherstripping achieves the same result for exterior doors.

In fitting interior doors, an allowance is usually made for carpet clearance. This leaves at the floor line a readily discernible crack through which noises pass. Since saddles are now commonly eliminated, an alternative seal for this and other interior door-cracks is, again, weatherstripping. Elaborate devices of this nature are available and are used on broadcasting studio doors, but are too expensive for normal residential purposes. Doors to kitchens, pantries, baths, recreation and hobby rooms and nurseries may be treated with weatherstripping.

Troublesome conducted sounds arise in most cases from use of mechanical equipment and supply and disposal systems. Their control is governed by three principal factors: (1) selection of equipment for silent operation, (2) isolation of offending portions of equipment or systems, (3) proper preplanning and construction.

In selecting equipment for quietness, it should be borne in mind that a degree of noise may be necessary for proper operation. Thus, efficient operation of toilet bowls is dependent upon scouring action of water, which inevitably produces noises. Compromises between maximum efficiency and maximum silence have been effected by manufacturers of sanitary and other equipment. With many other types of equipment noise of operation can be almost entirely eliminated, as with large-sized, low-speed attic ventilating fans which are to be preferred to small, high-speed fans.

Complaints most commonly received by acoustical engineers indicate that the chief mechanical sources of residential noise are: soil lines, water supply piping, heating piping and ducts, oil burn-



ers, pumps or compressors, kitchens and bathrooms.

Noisy equipment which is directly connected by rigid means to portions of the building structure will telephone its noise throughout the house. An undersized soil line secured to a joist by a hook or chain, or wedged in place with wood blocks, will transmit noise. The remedy, as indicated in the drawings of pumps and soil pipe, is interposition of hair felt, live rubber or other cushions against vibration and sound between the equipment and its rigid support.

Treatment of ducts to prevent undesirable telephoning of sound is a slightly different matter. Here the duct acts as a speaking tube; hence, application of sound-absorptive material to the interior of the duct is the solution. Methods of accomplishing this are likewise indicated in the drawings.

Water and heating piping systems need cause no noise if properly designed. Consultation with heating engineers will avoid these difficulties; remedies can be suggested by any competent plumber.

Aside from leakage of air-borne noise previously discussed, kitchen and bathroom noise can be controlled by pre-planning. Types of plans were discussed in the March, 1938, RECORD under "Zoned Planning for Noise Control." Research into sound control problems has developed the fact that resistance to sound transmission is almost directly proportional to total mass. Thus, a 2" x 4" stud partition will have only half the resistance to sound travel of an empty closet walled both sides with 2" x 4" stud partitions. Similarly, the same closet is many times more effective when full of clothes than when empty. The value of isolating rooms which are noise sources by means of closets or halls, etc., is derived from this fact.

Structural systems may be so designed as to prevent transmission of vibration or noise. A method possible for more expensive work is contained in the drawing of a double stud partition. Ordinary residential problems will be avoided if correct structural practices are followed and accurate workmanship is insisted upon. The ratio of sound transmission to mass holds as true for structural methods and materials as in planning space allocations.

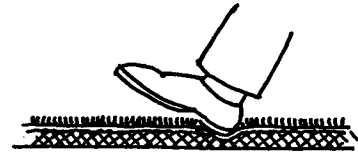
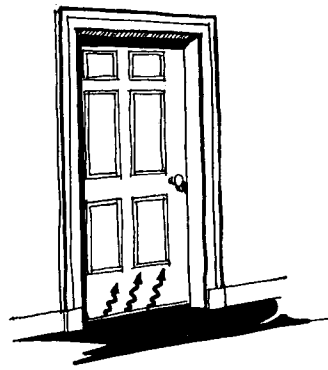

Air-borne sound comes through door cracks. Above: Heel impact on floor deadened by rug and rug-pad.

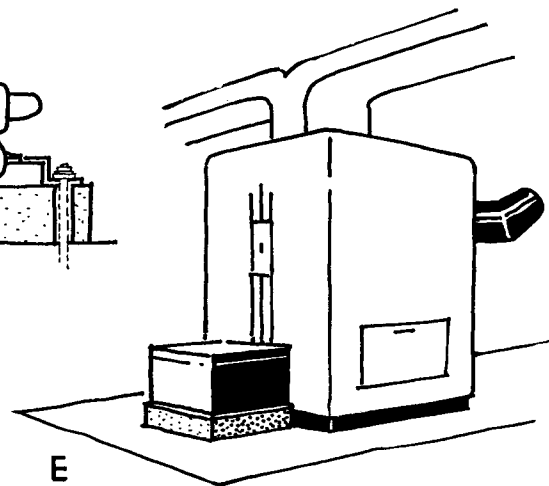
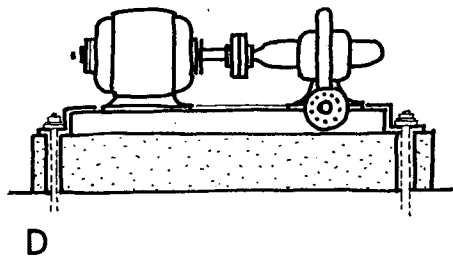
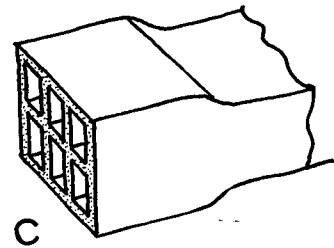
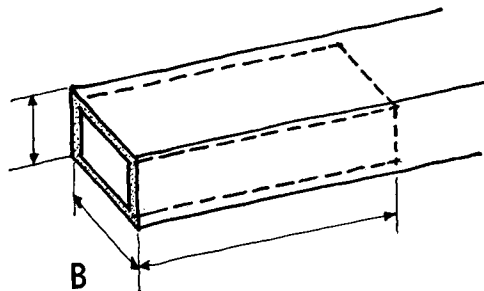
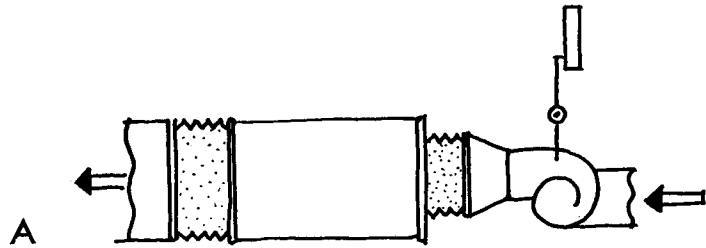

Mechanical equipment need not cause vibration and noise, if properly installed. A: Canvas connections and sound-insulating hangers for air-conditioning units. B: Sound-telephoning ducts may be lined with sound-absorbent material for distance equal to ten times mean diameter, back from outlet. C: If space is not available, increase diameter of duct and install "honeycomb" system, maintaining effective duct cross-section. D and E: Pumps and oil burner motors should be mounted so as to reduce noise transmission, and may be housed to muffle undesirable sounds.



**HOUSE FOR ROBERT M. ADDOMS**

**MAXIMILIAN BRADFORD BOHM**

PLAINFIELD, NEW JERSEY

Architect

THE OWNERS of this house expressed a definite desire for maximum privacy, proper orientation, an ample second-floor hall and an amateur theater in the basement.

The architects took advantage of the site to provide an easily served dining terrace whose privacy is assured by its high retaining wall; and to the west, a lawn terrace accessible from the living room. The study is isolated from the rest of the house, and provisions for service systems are generally adequate. Location of the basement heater room and laundry might be improved. Position of second-floor dressing-room-and-bath unit necessitates use of owner's bedroom as a corridor.

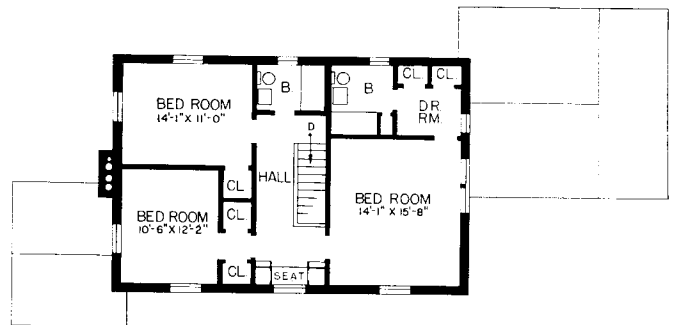

Second Floor

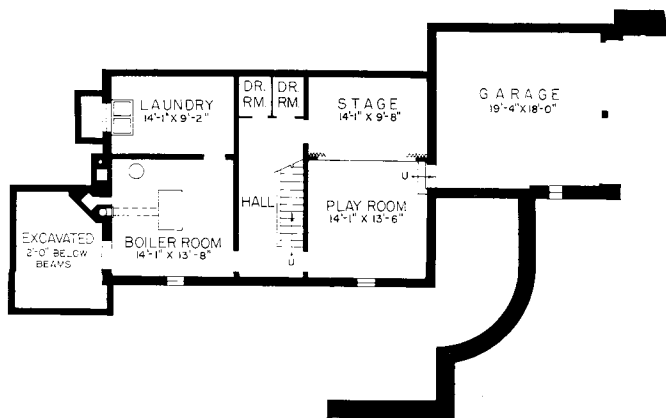

Basement

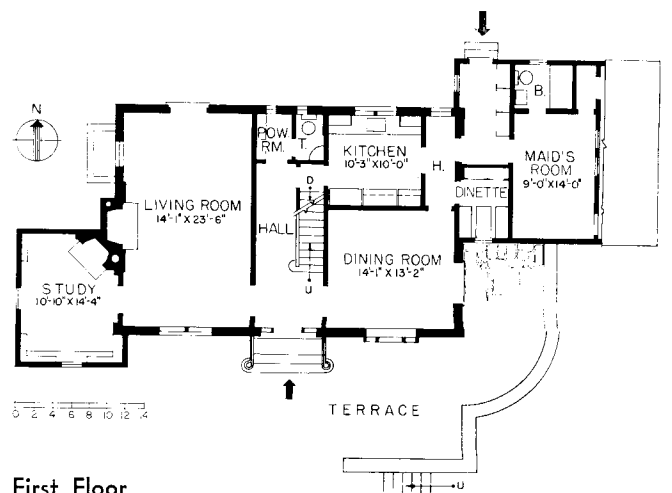

First Floor



Opposite page: View from southeast, showing retaining wall which supports dining terrace. Above: Entrance front from southwest. Right: Living room interior.

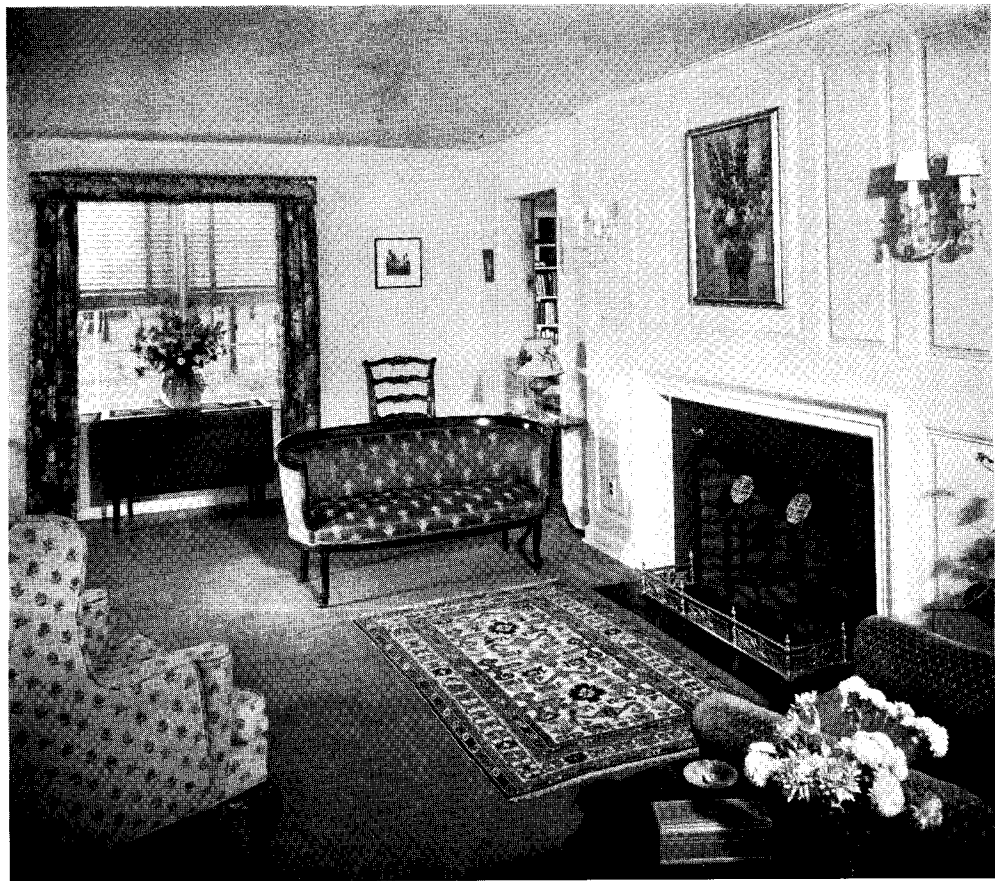

# HOUSE FOR ROBERT M. ADDOMS

MAXIMILIAN BRADFORD BOHM

Architect

## SCHEDULE OF EQUIPMENT AND MATERIALS

<b>FOUNDATION</b>	Cinder block on concrete footing
<b>EXTERIOR</b>	Brick veneer, wood framing
<b>Roof</b>	1 1/4-in. black slate
<b>INTERIOR</b>	
<b>Finish</b>	Study, paneled pine; bedrooms, paper; dinette, plywood panels, scored and painted; other rooms, painted plaster
<b>Floors</b>	White oak; linoleum in hall, kitchen, lavatory and powder room
<b>SASH</b>	Curtis Companies, double-hung
<b>INSULATION</b>	Rock wool
<b>LIGHTING &amp; WIRING</b>	BX cable; fixtures by owner
<b>PLUMBING</b>	Brass pipe; Standard Sanitary Mfg. Co. fixtures
<b>HEATING</b>	Thatcher Furnace Co.; gas-fired air conditioning
<b>KITCHEN EQUIPMENT</b>	Kitchen Maid Corporation

Cost: approximately \$12,800, including fees

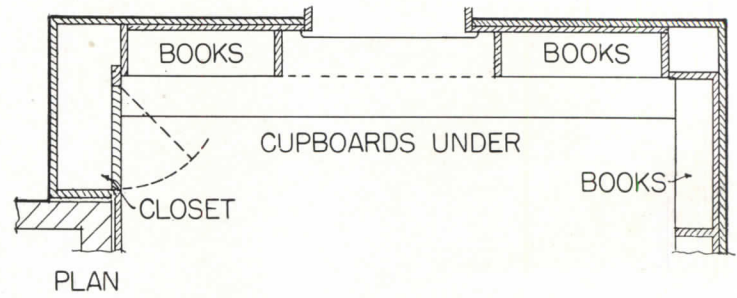
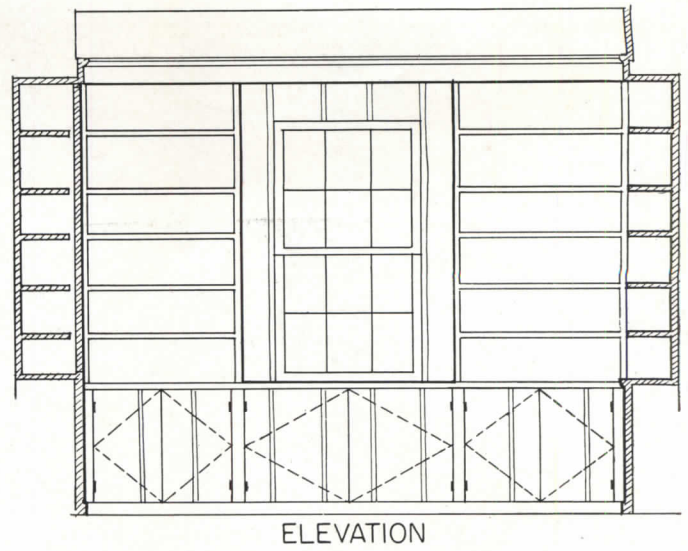

SOUTH END OF STUDY

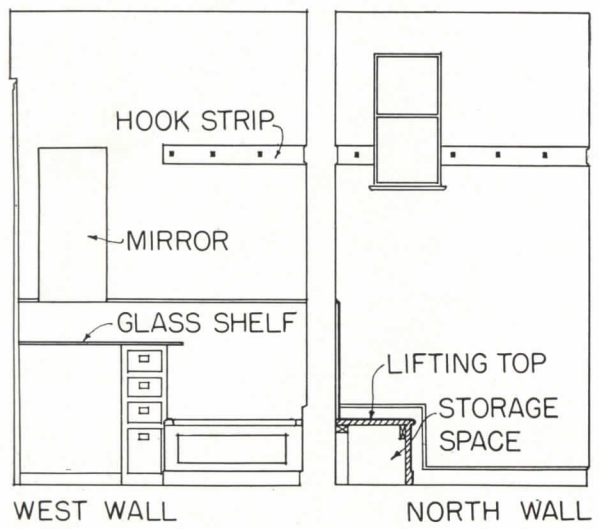

WEST WALL NORTH WALL

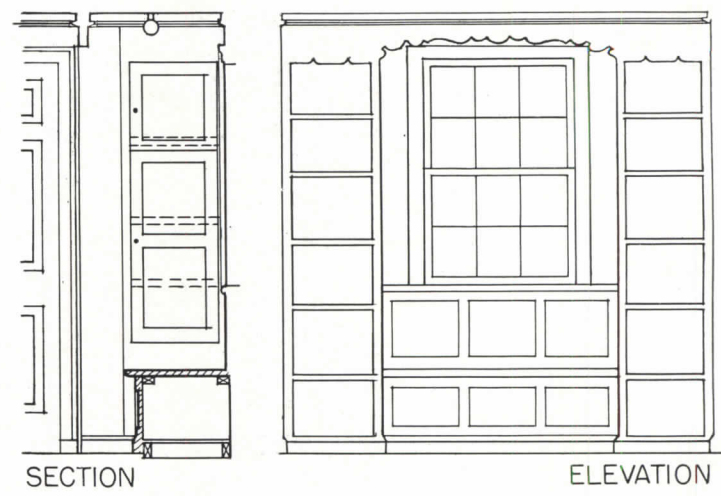

SECTION ELEVATION

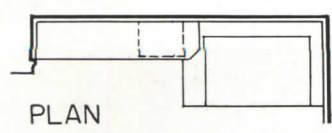

POWDER ROOM

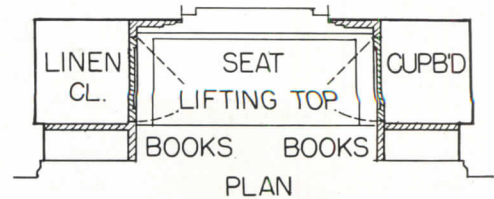

STAIR HALL CLOSETS

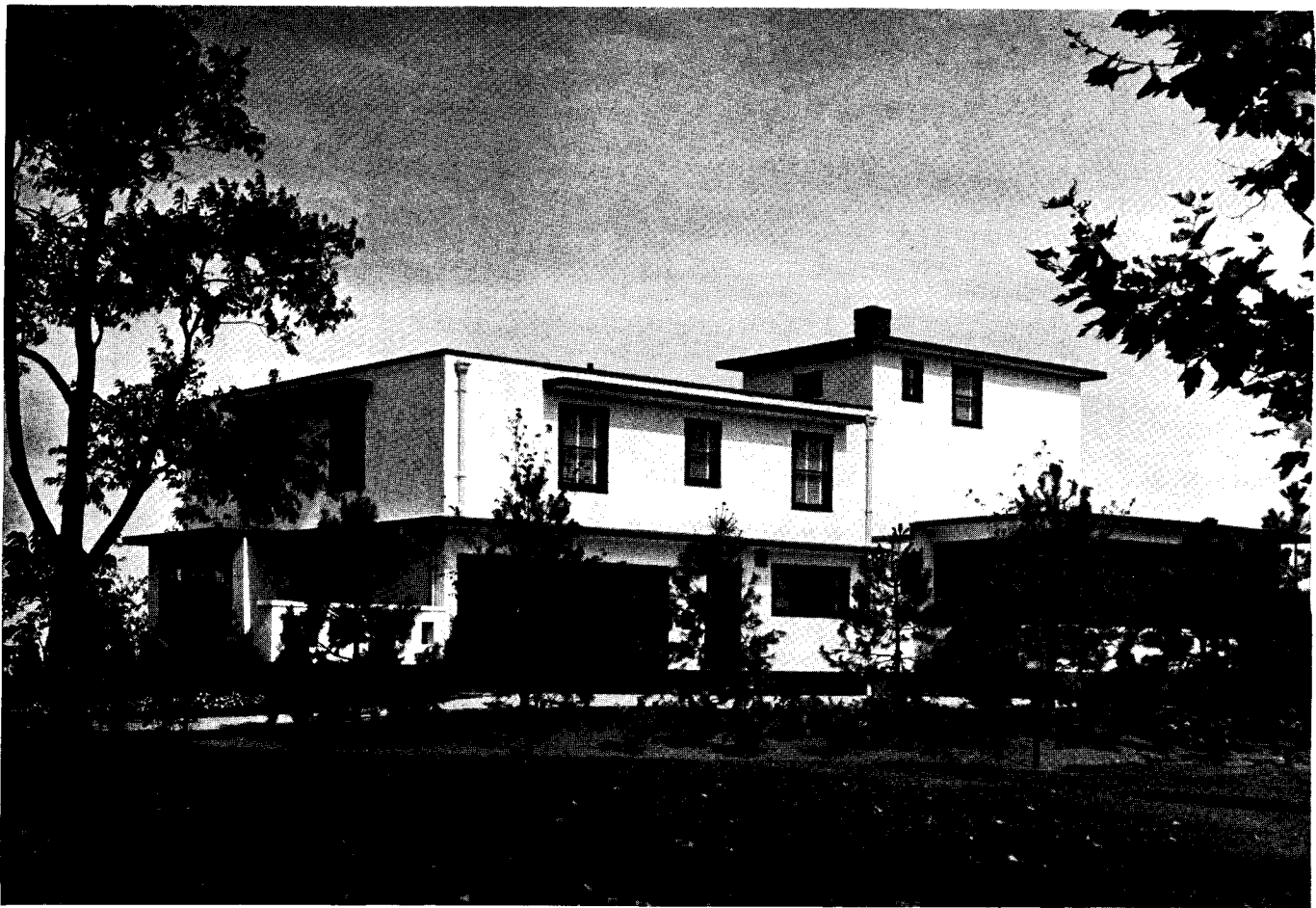

**HOUSE FOR MARSHALL VAN WINKLE, JR.**

OCEANPORT, NEW JERSEY

**C. C. BRIGGS**

Architect

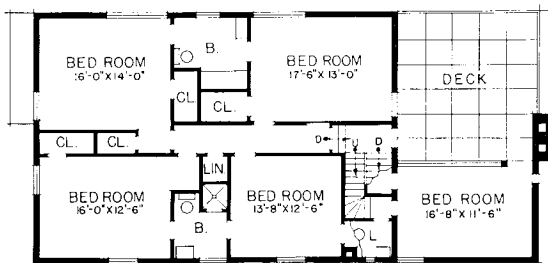

Second Floor

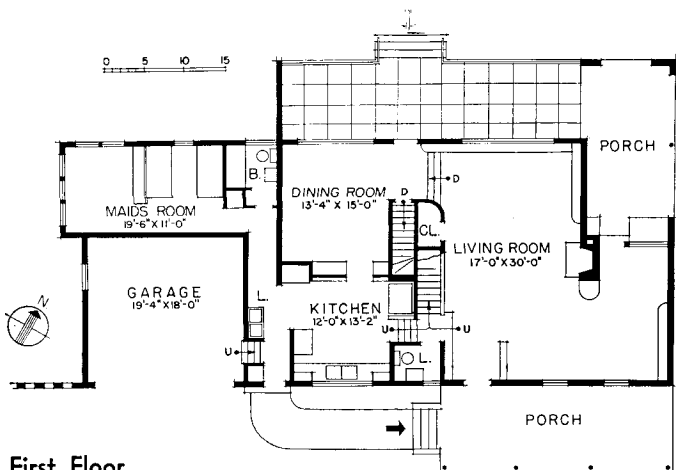

First Floor

LOCATED ON THE New Jersey shore, this house needs its roofed porches for relief from glaring sun. Interior equipment and furnishings have been planned by the architect. Stairways, closets and changes in level are used to separate the service portion of the first floor from living areas. Kitchen location is convenient; but opening of main entrance directly into living room and lack of physical separation between den (in southeast corner) and living spaces are debatable points. Second-floor baths are so located that plumbing costs are minimized. Bathroom doors opening into secondary passages might be more satisfactory than doors to bedrooms. Ample furniture space and natural ventilation have been provided.



### SCHEDULE OF EQUIPMENT AND MATERIALS

<b>FOUNDATIONS</b>	Waterproof concrete, Medusa Portland Cement; walls and floor poured at same time	<b>Floors</b>	Wood joists; hardwood-finish floor; Armstrong's linoleum over entire first floor and all baths
<b>STRUCTURE</b>	Wood frame	<b>Mirrors</b>	Libbey-Owens-Ford Glass Co.
<b>EXTERIOR</b>		<b>INSULATION</b>	Baldwin Hill Mineral Wool
<b>Walls</b>	Stucco on metal lath; white marble dust used in Portland cement	<b>LIGHTING &amp; WIRING</b>	BX cable; some indirect and flush ceiling fixtures; Lightolier and Amman fixtures
<b>Roof</b>	Built-up, Barrett Co.	<b>PLUMBING</b>	Chase copper tubing; Standard Sanitary Mfg. Co. fixtures; Samson disposal system
<b>Sash</b>	Seal-tite double-hung, Curtis Companies	<b>HEATING &amp; AIR CONDITIONING</b>	Gas heater, Fox Furnace Co.; air conditioning throughout
<b>INTERIOR</b>		<b>KITCHEN EQUIPMENT</b>	Copeland refrigerator; Excel metal cabinets; Magic Chief range
<b>Walls</b>	Float-finished plaster, except for wall linoleum in kitchen and den		

# HOUSE FOR MARSHALL VAN WINKLE, JR.

C. C. BRIGGS  
Architect

Left: Fireplace in living room is faced with linoleum; mirrors and float-finished plaster above. Part of den is visible beyond. Opposite page: View across living room from den. The recess shown was designed for an aquarium; it has a glass soffit with concealed lights and a light set flush with the counter. A built-in desk opens into the den.

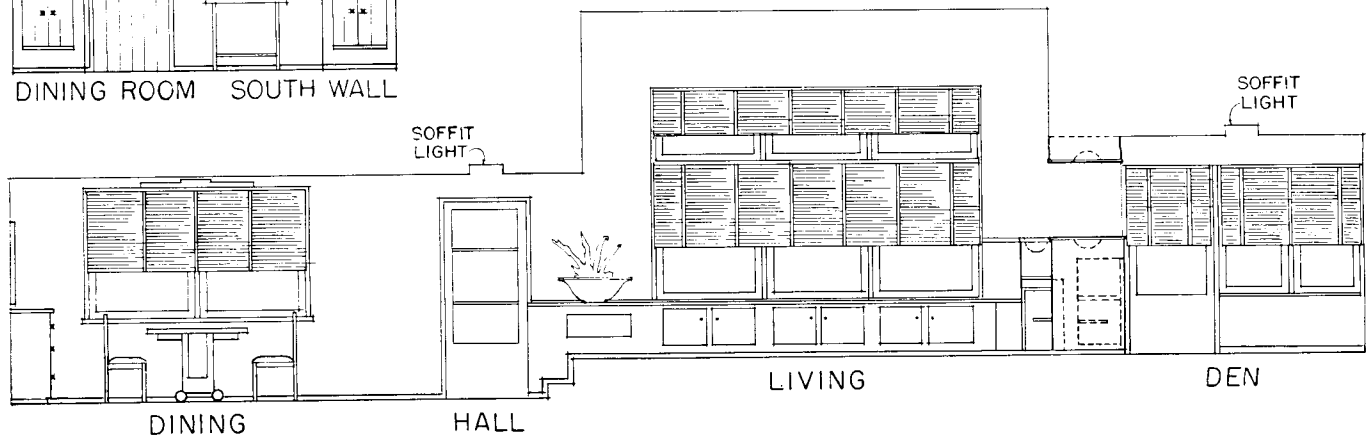
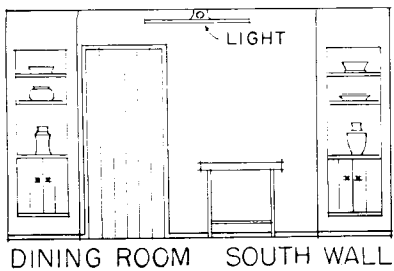
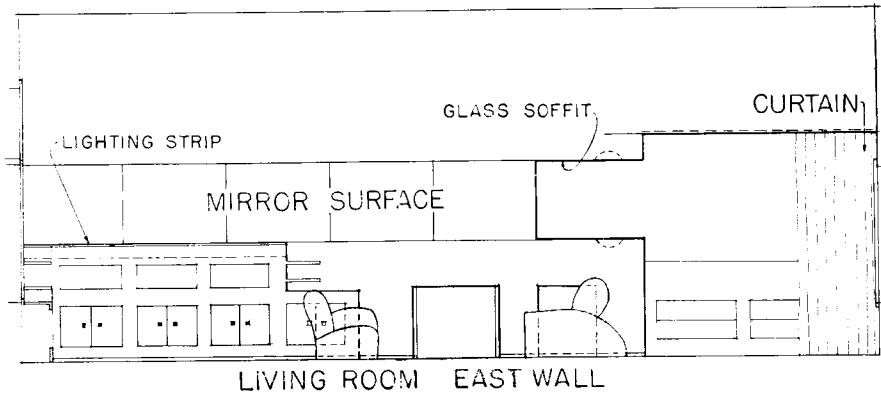
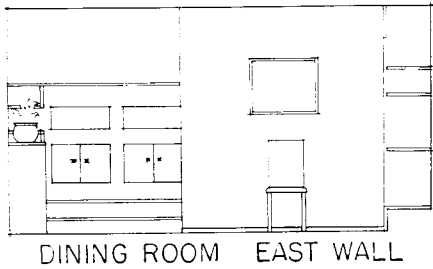

Photos by Schnall

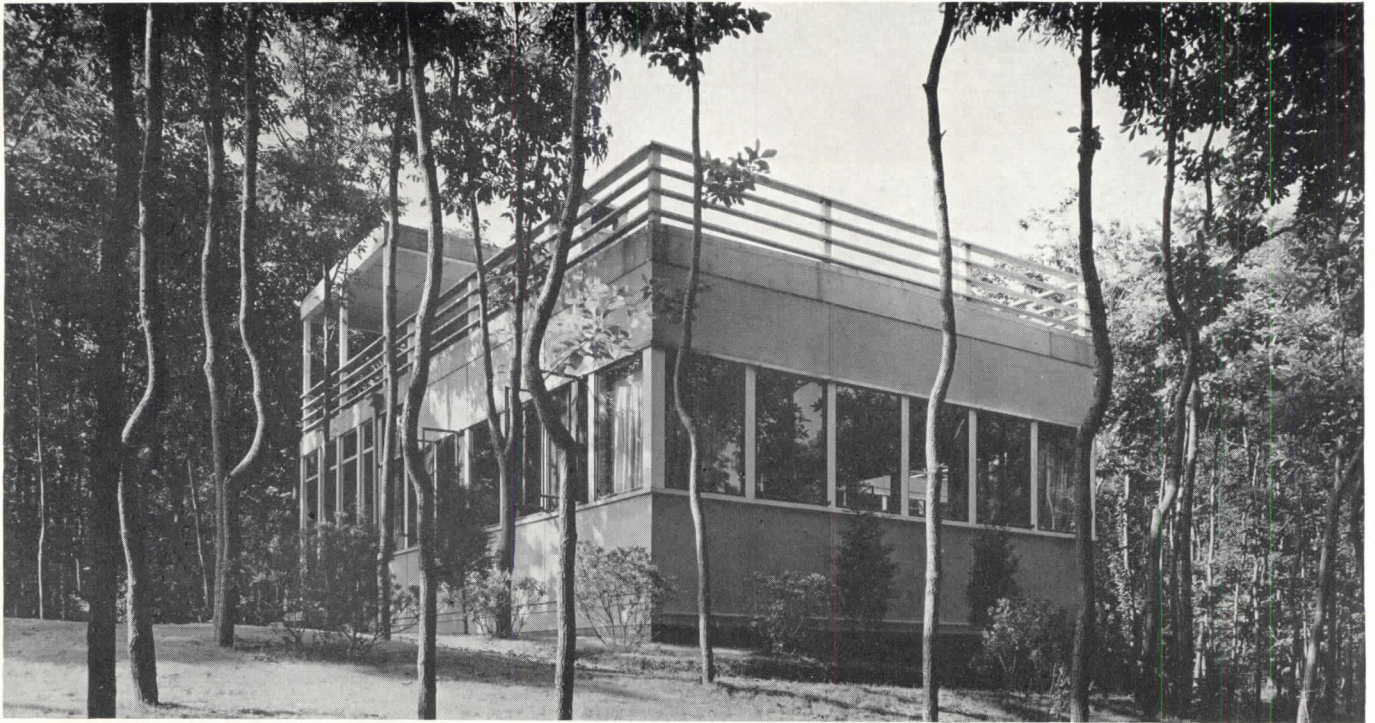

**VACATION HOUSE FOR JULES SINGER**  
RIVERHEAD, NEW YORK

**ALLMON FORDYCE—WILLIAM I. HAMBY,**  
Architects

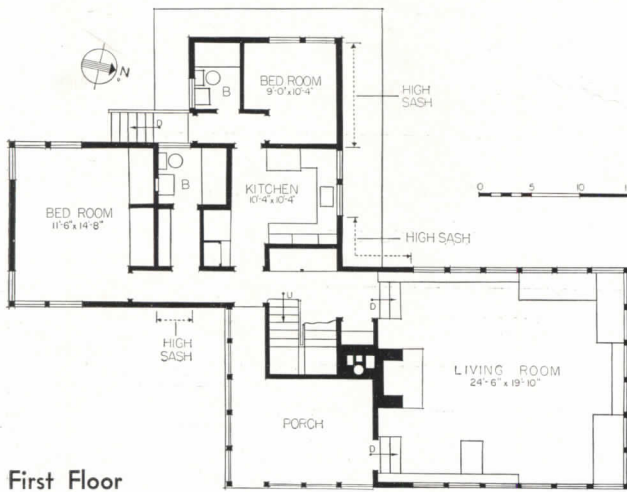

First Floor

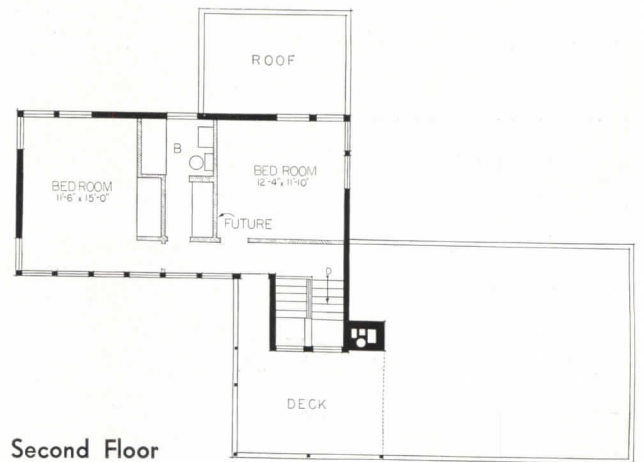

Second Floor

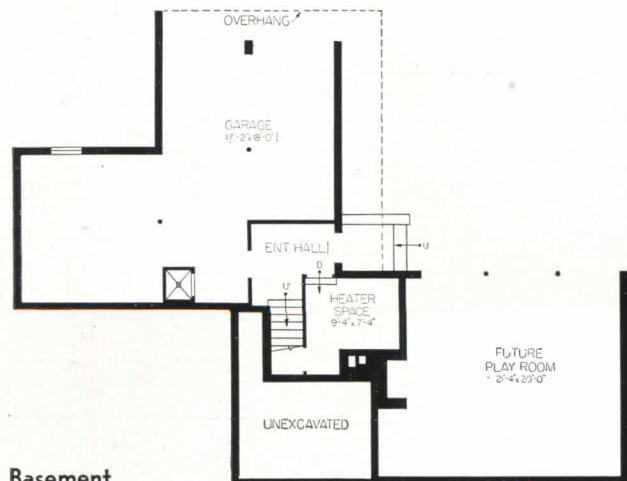

Basement

**SCHEDULE OF EQUIPMENT AND MATERIALS**

<b>FOUNDATION</b>	Concrete block
<b>EXTERIOR</b>	
Walls	4" x 4" studs, 4'-0" o. c., faced with Johns-Manville Transite panels
Roof	Celotex and asphalt
Sash	Steel casements
<b>INTERIOR</b>	
Floors	Pine
Walls	1/4-in. fir plywood
<b>INSULATION</b>	Rock wool
<b>WIRING</b>	BX cable
<b>PLUMBING</b>	Brass piping with sweated joints; Standard Sanitary Mfg. Co. fixtures
<b>HEATING</b>	Fox Furnace Co.



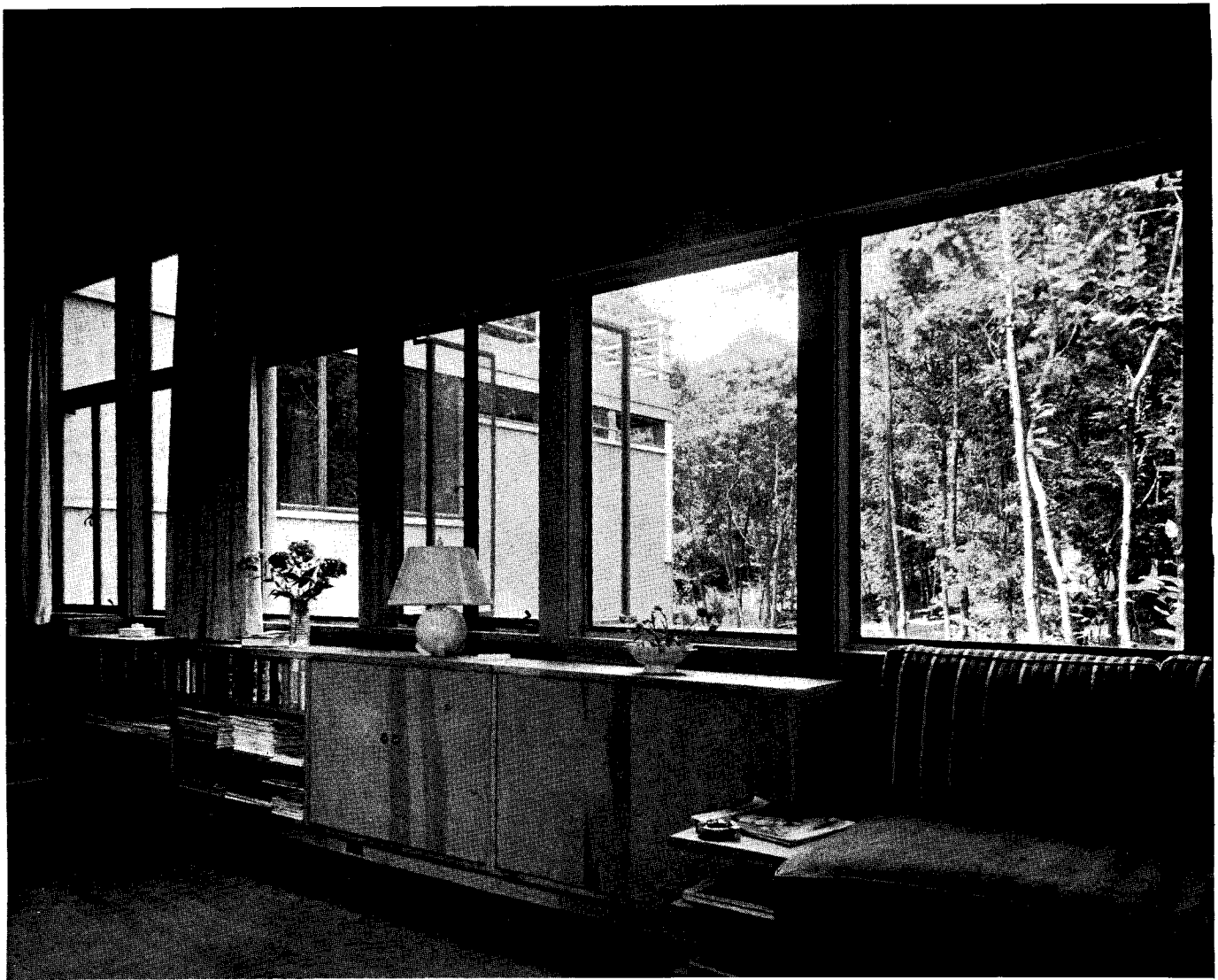

Two views of the living room. Above: West wall. Below: South wall. Both show built-in storage equipment and furniture.

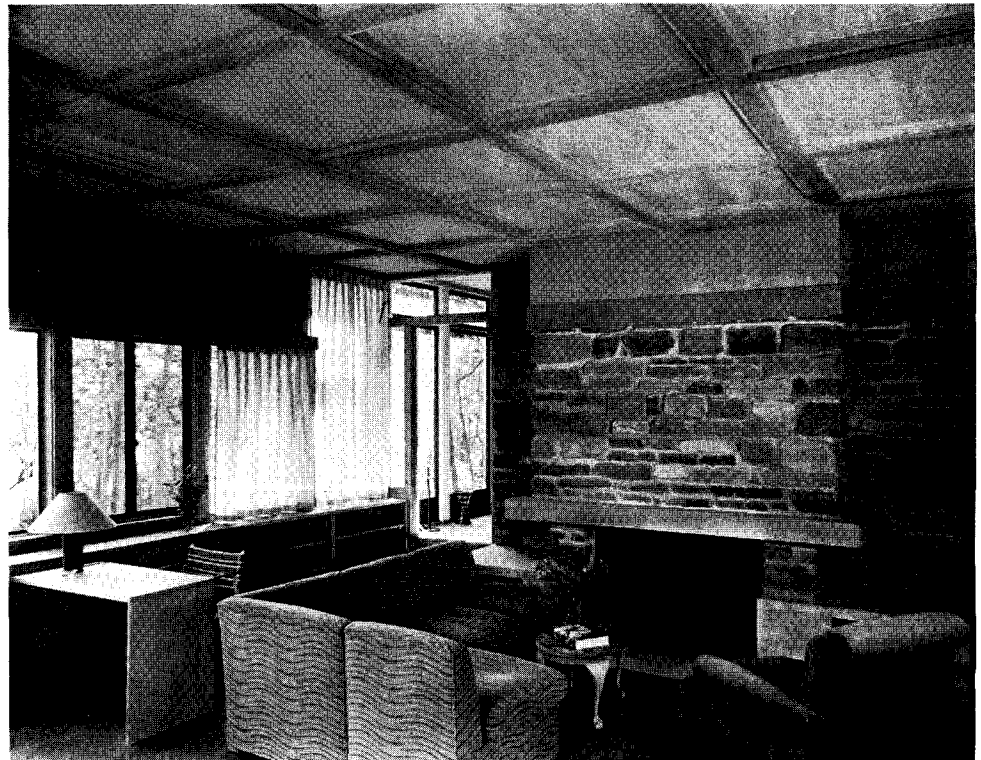

Photos by De Mott Studio

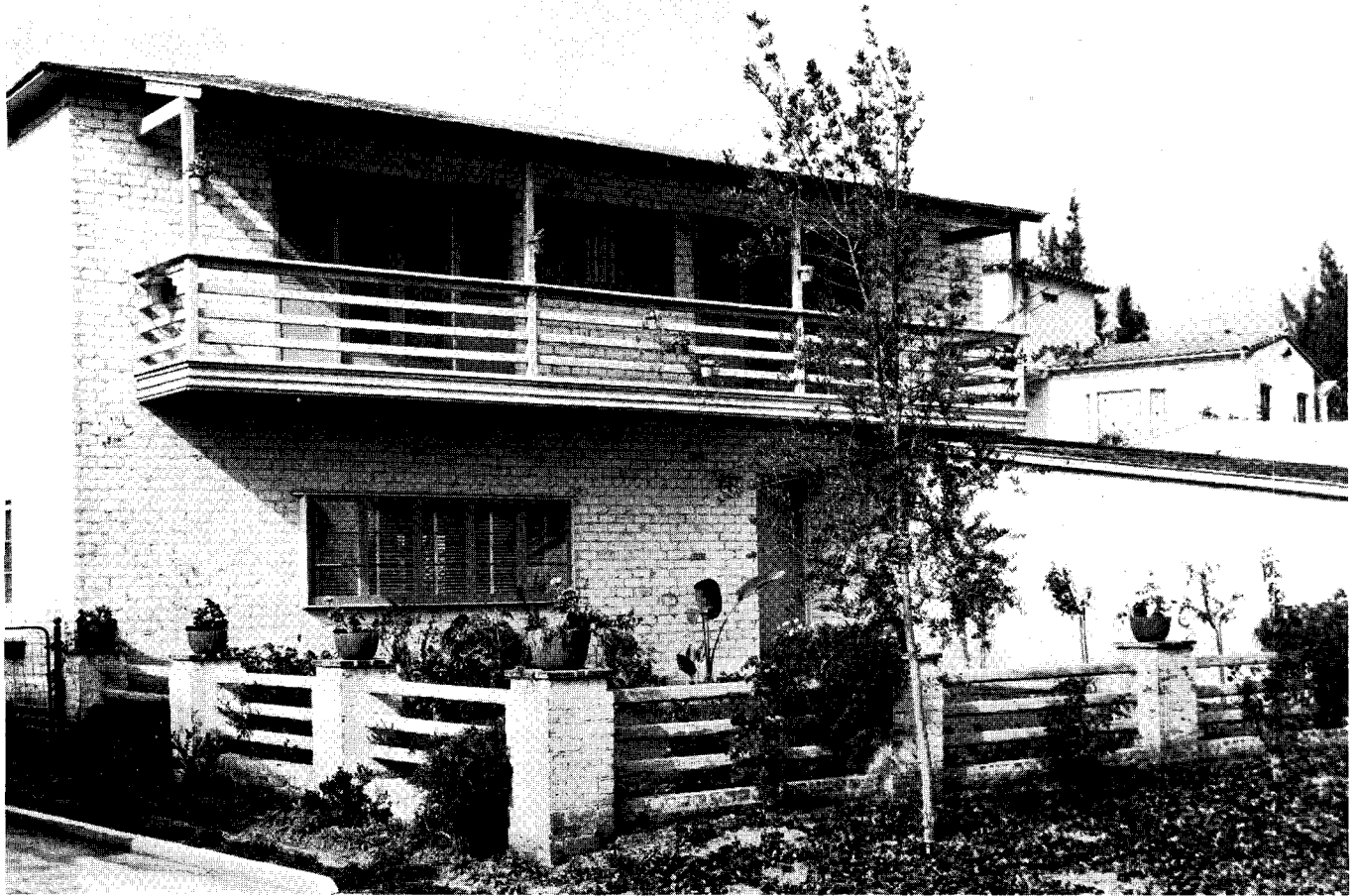

## HOUSE FOR HOWARD A. CAMPION

WESTWOOD, CALIFORNIA

LEO F. BACHMAN

Architect

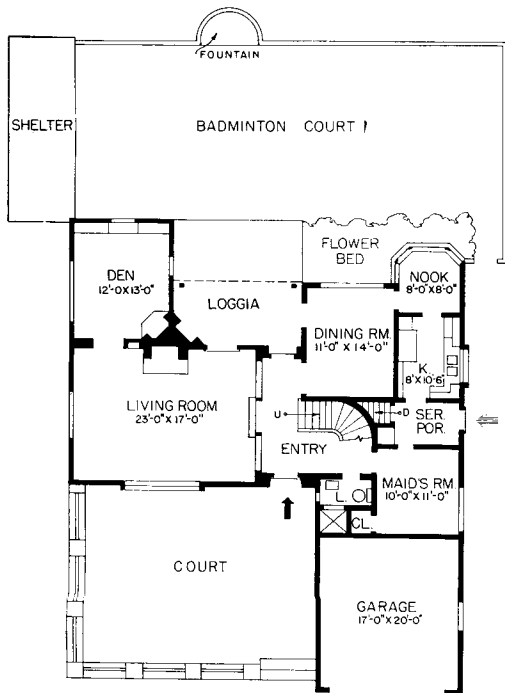

First Floor

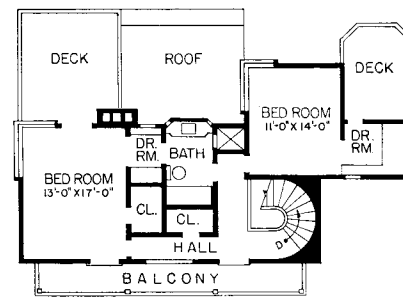

Second Floor

### SCHEDULE OF EQUIPMENT AND MATERIALS

<b>FOUNDATION</b>	Concrete, Victor Portland Cement
<b>STRUCTURE</b>	Earthquake and fire-resisting brick
<b>EXTERIOR</b>	
Walls	8-in. reinforced groutlock brick, Simons Brick Co.
Roof	Redwood shingles
Sash	Wood casements; copper screens
Entrance Door	"Rezo" honeycomb core; Paine Lumber Co., Ltd.
<b>INTERIOR</b>	
Floors	Wood joists, Diamond Hardwood Co.; wood finish
Walls	Plaster
<b>HEATING</b>	Hot-air, forced circulation, semicooling; Payne Furnace & Supply Co.
<b>HARDWARE</b>	Chrome throughout; Schlage Lock Co.
<b>PLUMBING</b>	Standard Sanitary Mfg. Co. fixtures
<b>PAINTING</b>	Exterior: Sherwin-Williams—brick, tan; woodwork, warm brown Interior: Texolite, U. S. Gypsum Co.
<b>GLAZING</b>	Pittsburgh Plate Glass Co.

Cost: \$8,500 for building only

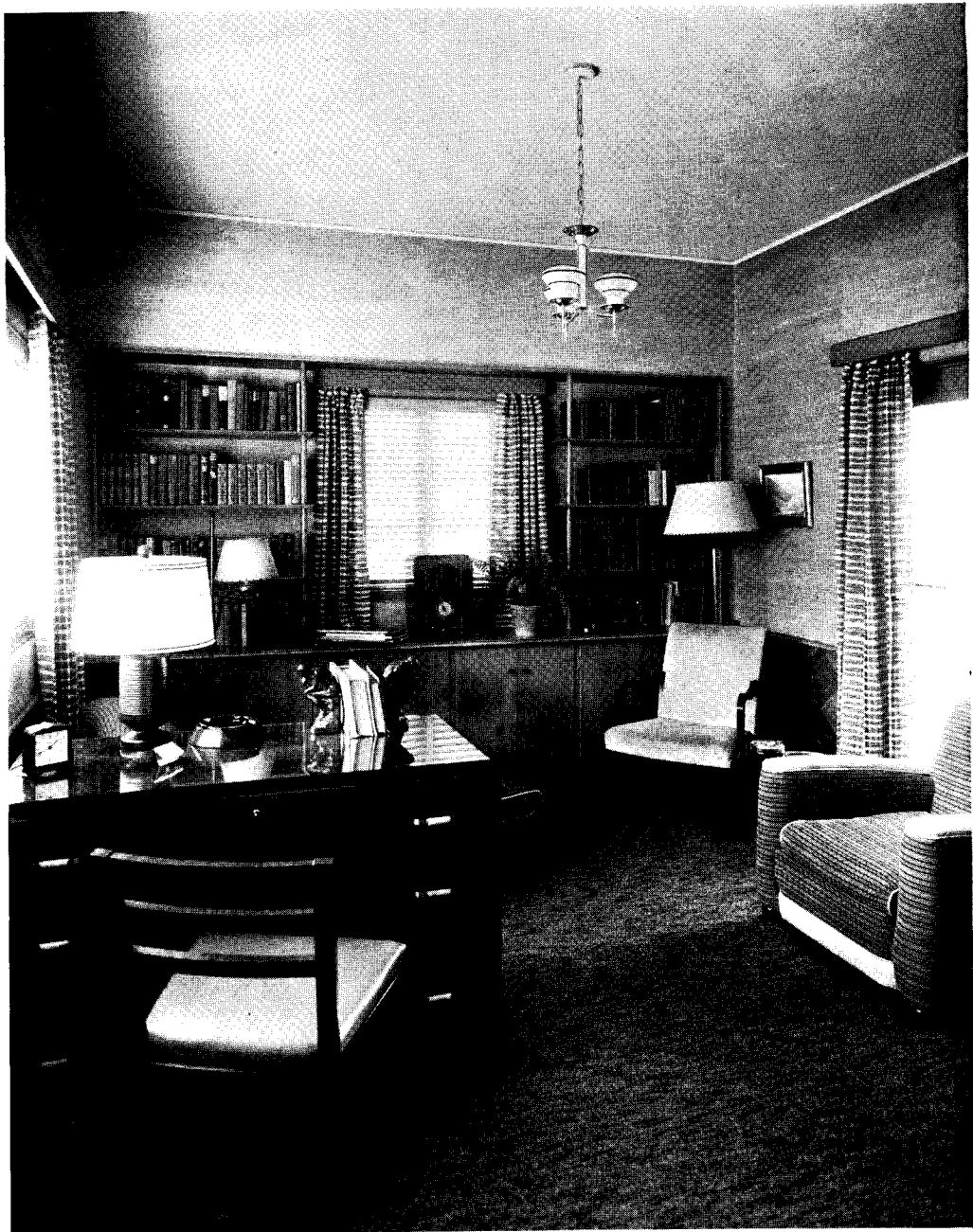

Opposite page: Entrance front, garage at extreme right. Right: Interior of den, showing built-in book-cases. Below, left: Rotisserie in loggia; right: End of living room, looking toward hall.



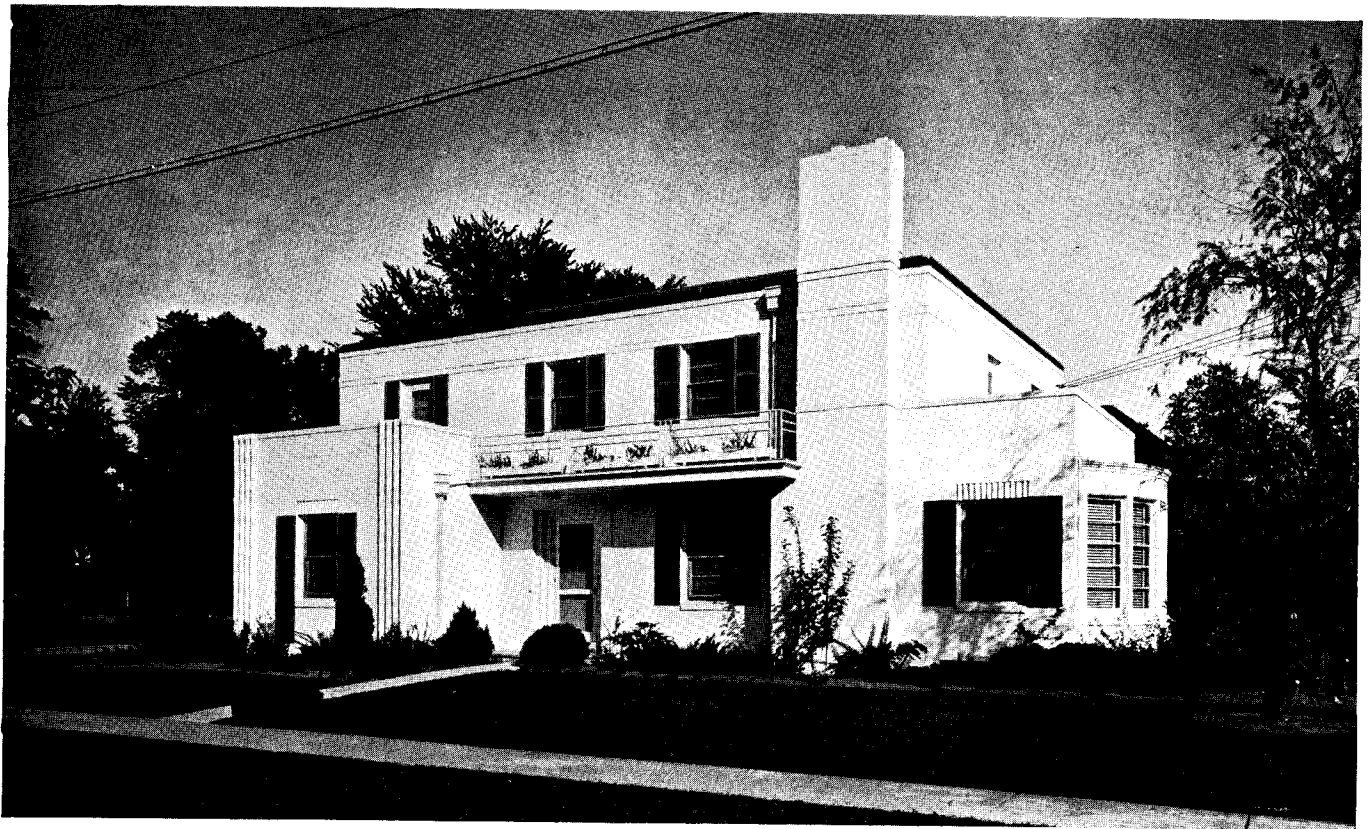

## HOUSE FOR HOUSTON BOYET

DETROIT, MICHIGAN

EARL L. CONFER

Architect

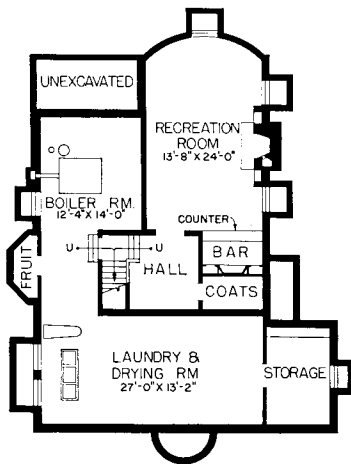

Basement

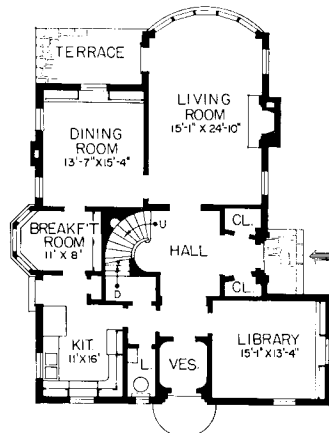

First Floor

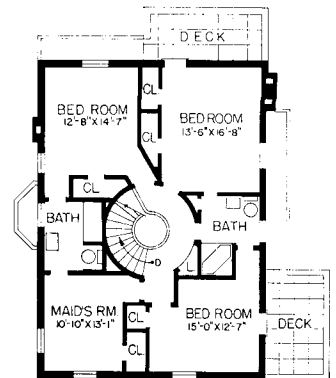

Second Floor

### SCHEDULE OF EQUIPMENT AND MATERIALS

<b>FOUNDATION</b>	Sand Lime block
<b>STRUCTURE</b>	Brick veneer on wood frame
<b>EXTERIOR</b>	
Walls	Common brick
Roof	Deckman-Dawson tapered asphalt shingles
Sash	Non-stick double-hung; weatherstripped
Garage Doors	Overhead Door Corp.
Decks	U. S. Quarry tile floors
<b>INTERIOR</b>	
Floors	Armstrong linoleum in service portion; otherwise "Ritter" select red oak
Walls	2" x 4" studs, U. S. Gypsum Rocklath and plaster
Woodwork	White pine

### INSULATION LIGHTING & WIRING

### PLUMBING

### HEATING & AIR CONDITIONING

### KITCHEN EQUIPMENT

### PAINTING

### Exterior Interior Woodwork

4" Air-o-cel rock wool
Romex and rigid conduit; Lightolier Co. fixtures
Copper pipe and fittings, Mueller Brass Co.; fixtures, W. A. Case & Son Mfg. Co.
Direct-fired, General Electric Co.
Kelvinator refrigerator; Hot Point electric range
Devoe & Reynolds "Bay State"
Enameled, Ripolin

Cost: Approximately \$14,000, including landscaping and built-in equipment

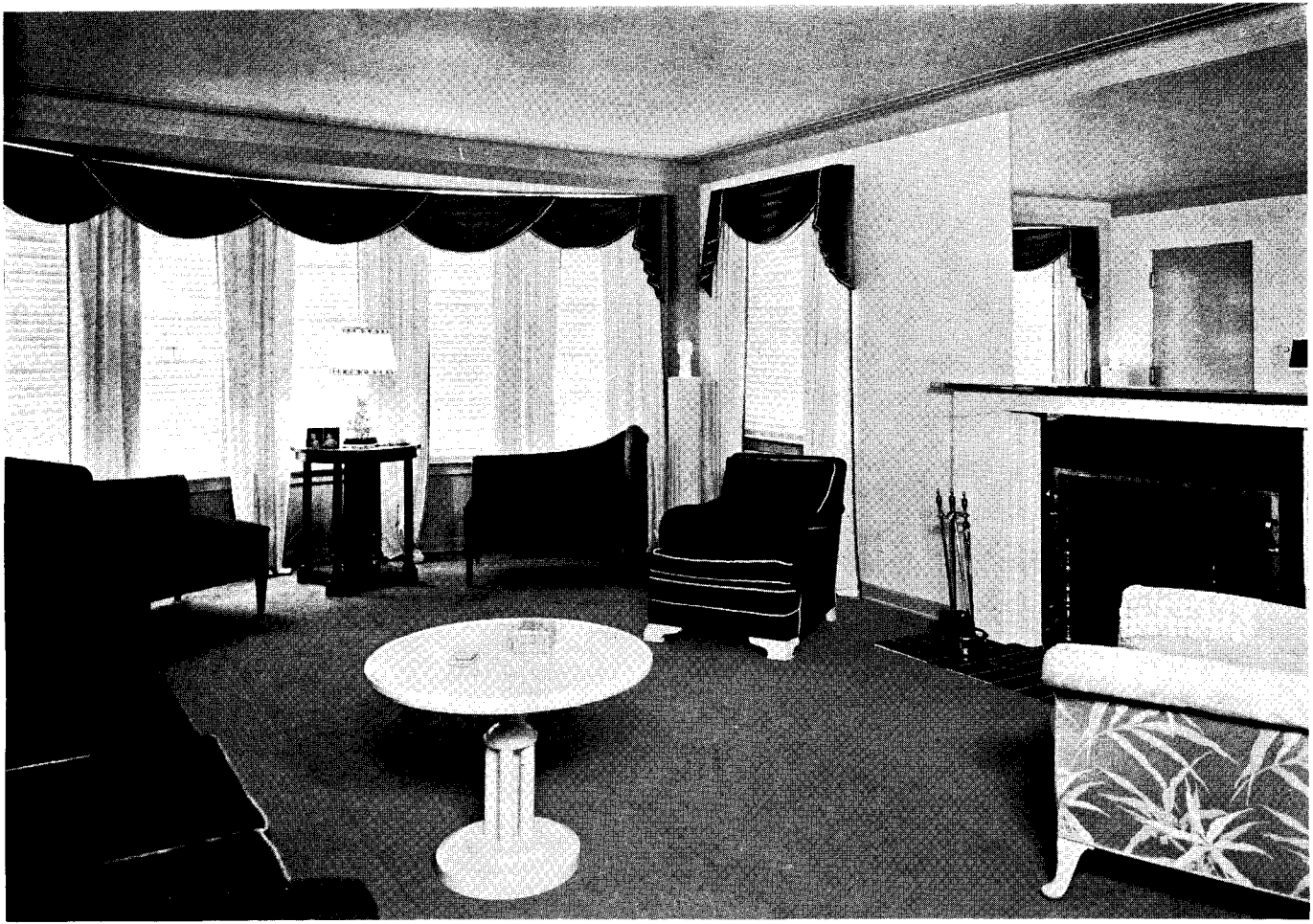

Opposite page: Main entrance front. Roof is pitched, but so low it can hardly be seen. Blinds, coping and roof are deep blue in color. Above: Living room interior. Right: Dining room.



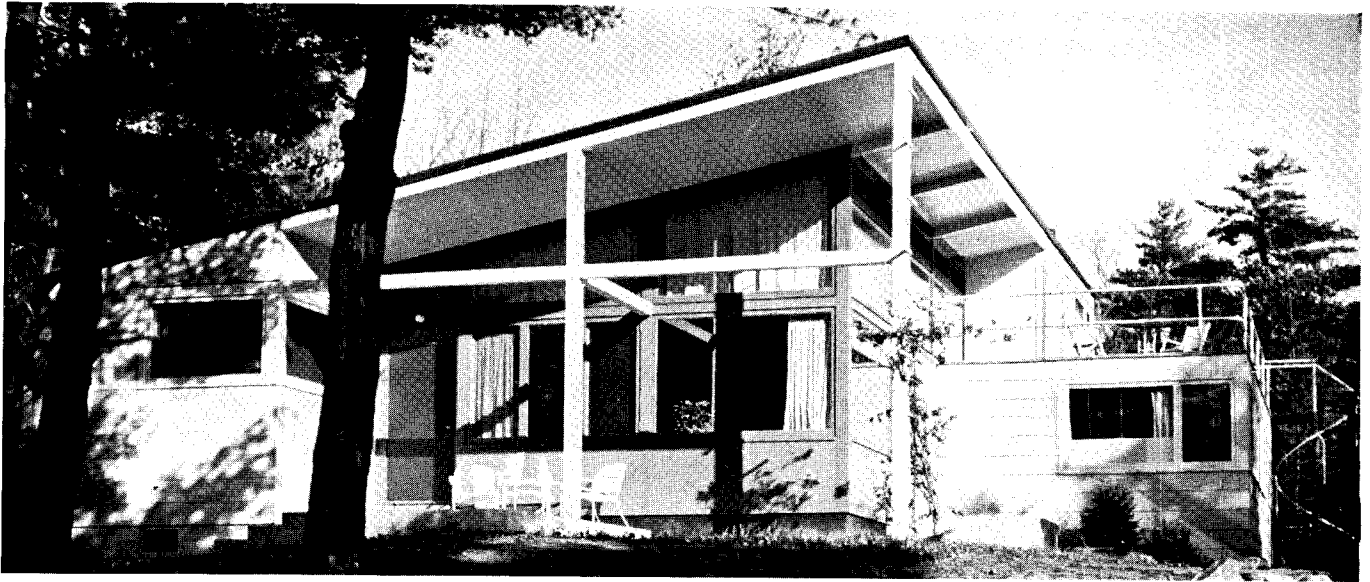

## VACATION HOUSE FOR ALFRED DE LIAGRE

WOODSTOCK, NEW YORK

WILLIAM MUSCHENHEIM

Architect

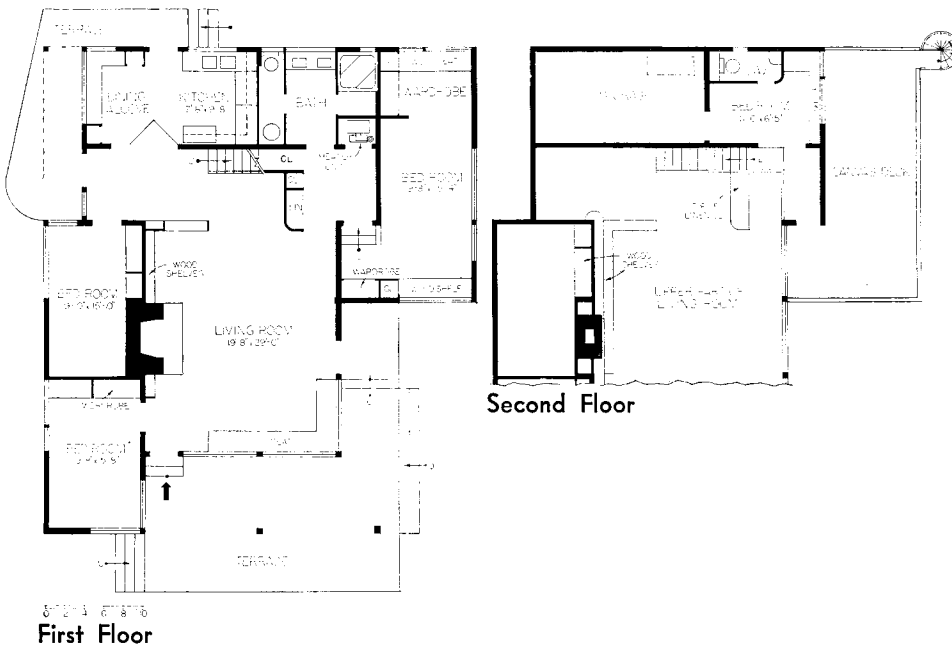

### SCHEDULE OF EQUIPMENT AND MATERIALS

<b>FOUNDATION</b>	Concrete block
<b>STRUCTURE</b>	Wood frame
<b>EXTERIOR</b>	
Walls	Johns-Manville asbestos shingles
Roof	Johns-Manville, built-up; decks, canvas
Sash	Wood casement and sliding; bronze screens
<b>INTERIOR</b>	
Floors	Wood joists; wood finish; Armstrong's linoleum in kitchen and lavatory
Walls	Wallboard and plywood
<b>INSULATION</b>	Rigid board, Johns-Manville; rock wool under roof
<b>HEATING</b>	Heatilator fireplace unit; Florence oil-burning heater
<b>HARDWARE</b>	Brass, P. & F. Corbin
<b>PLUMBING</b>	Copper tubing; Standard Sanitary Mfg. Co. fixtures
<b>LIGHTING</b>	Fixtures by Kurt Versen
<b>GLASS</b>	Pittsburgh Plate Glass Co.

Cost: Approximately \$10,000

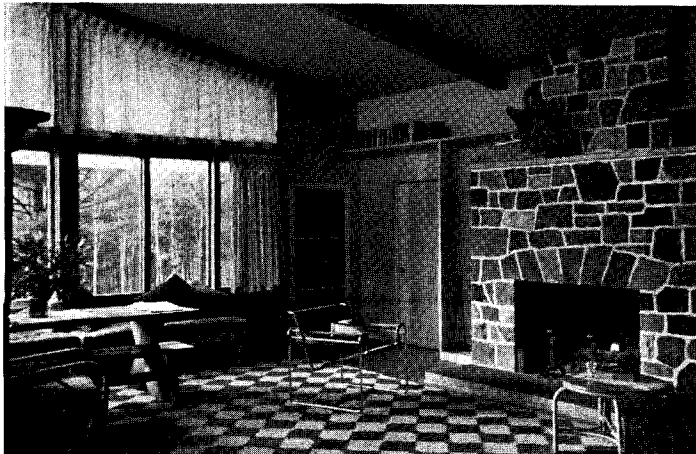

Living Room, looking toward fireplace



Looking toward service portion