

NEW ARCHITECTURE IN MEXICO

As a companion volume to the present English number of The Architectural Record, the April issue will feature recent new architecture in Mexico. It has been said that "modern architecture, almost non-existent five years ago, is now more at home in Mexico City than in almost any other city in the world."

This paradoxical situation was unsuspected by all excepting a few who visited Mexico during the past two or three years. Esther Born, accomplished photographer and herself an architect, spent months in Mexico last year, recorded what she saw and collected drawings and pertinent architectural facts. There will be in excess of 80 pages on the New Architecture in Mexico, almost all "Born photos." Ernest Born, well known to the profession for his typographical layouts, has planned and arranged the pages for this issue and also has created a cover for the Mexican number.



The new idea springs up in the midst of the old. England's most notable contribution to modern examples, the Bexhill Pavilion (Mendelsohn and Chermayeff, architects), shown in its setting: the confusion of a seaside esplanade. Across the forecourt is still thrown the shadow of the Edwardian rococo past in the form of a hotel adjacent: symbolic perhaps of the state of progress of the Modern Movement today. But there are signs that the shadow is diminishing, as the pages that follow attempt to show.

1860-1930

By Nikolaus Pevsner

IN tracing the development of the Modern Movement in England, two phases should clearly be distinguished. Up to about 1895, to 1900, England was actively and boldly leading Europe towards a new and truly contemporary style; after 1895 or 1900 the decisive steps were taken on the Continent and in the United States, whereas England remained faithful to the principles and forms which had been discovered and evolved by the pioneers of her past and were in the meantime accepted as reliable tradition.

Only after the war did British architecture and industrial art by degrees take up those modern forms which, between 1895 and 1914, men such as Frank Lloyd Wright, Adolf Loos and Walter Gropius had created, and it is hardly before 1932 that any English buildings can be found showing features of a modern and, at the same time, visibly English character. The way thus indicated is to be described more fully in the following pages.

With regard to the origins of the Modern Movement, there cannot be any doubt that they lie in England exclusively or almost exclusively, whether one wants to date them back to Pugin's theories of honest building practice or if one prefers to give William Morris the entire credit for the new conception. In Pugin's *Apology* of 1843 we find sentences such as this: "Styles are now adopted instead of generated, and ornament and design are adapted to, instead of originated by, the edifices themselves." And in his *True Principles of Pointed Architecture* of 1841 he pleaded for designing every building so that exterior and interior would be "illustrative of, and in accordance with, the purpose for which it is designed." Consequently, ornament should never "conceal the purpose." It should "beautify, not disguise," and designers should only think of

"making the most convenient form and then decorating it."

However, Pugin's teachings and those of other progressive English thinkers such as Ruskin or Owen Jones* remained academic theory, whereas Morris possessed the tremendous energy to put his ideals into practice. This is what caused the extraordinary effect of his writings and his works on Britain and foreign countries. His foremost title to fame is that he has resuscitated handicraft in a moment when it had fallen into desperate decay. His fabrics, his stained glass windows and tiles, his wallpapers and rugs, his printed books, have restored the faith of artists in applied art. When he started, no painter of high standing (and only very few architects) would have considered it worth while to take an interest in objects of everyday use. When he died, an ever-increasing group of followers spread his gospel over England, the Continent and America. His gospel — for inspiration was not only derived from his work; his life and his doctrine proved at least equally stimulating.

It is not necessary here to say much about these. The greatest deed in his life was probably that he, as a trained architect and painter, instead of joining or founding a group of artists united by some purely aesthetic ideal, preferred to open a shop and to start workshops. The firm of Morris, Marshall and Faulkner, Fine Art Workmen in Painting, Carving, Furniture and the Metals, came into being in 1861, and it can scarcely be fully appreciated today how revolutionary this gesture of Morris was. In his lectures, delivered between 1877 and 1894, Morris provided the philosophical foundation to his work. What he taught was that all art must be pleasurable

*"Every object to afford perfect pleasure must be fit for the purpose and true in its construction." *The True and the False in the Decorative Arts*, Lecture of 1852, published London, 1862, p.21.

and useful or, as he once put it, "a joy to the maker and the user." The Fine Arts — and he was the first artist in Europe to realize this — had lost all root in contemporary life. What was done was of interest to a few connoisseurs only. The things of workaday use were left unheeded, whereas it should be the greatest and most urgent problem for the artist to make them as beautiful and valuable as in Morris's time were solely some pictures and sculptures.** This problem can, in Morris's opinion, be solved only if the production of the object for use is a joy in itself. Morris was adamant here. He did not admit any aesthetic value to be possible where production is mechanical and man is not wholly responsible for shape and adornment. Hence his "Ludditism," his hatred against the machine.

His immediate followers, as the painter and designer Walter Crane, the great cabinetmaker Ernest Gimson, the architect, designer and theorist C. R. Ashbee, and the majority of those showing their work at the Arts and Crafts Exhibitions of 1888, 1890, 1893, etc., held up his ideal of pure craft, holding up as a rule also his medievalizing socialism. If we today call this stage of the movement the Arts and Crafts, we rightly stress two of its chief characteristics: its derivation from the Fine Arts more than from architecture, and its anti-machine attitude. Morris's aesthetic discoveries or re-discoveries predominantly concerned matters of surface decoration, and not of structure, i. e., the pictorial more than the architectural side of applied art. His textiles, his wallpapers, his books seemed so fresh and novel at the time when they appeared, because they were based on the soundest understanding and the purest apprecia-

**"That which is made by unassisted individual genius."

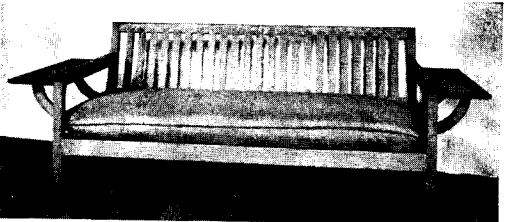
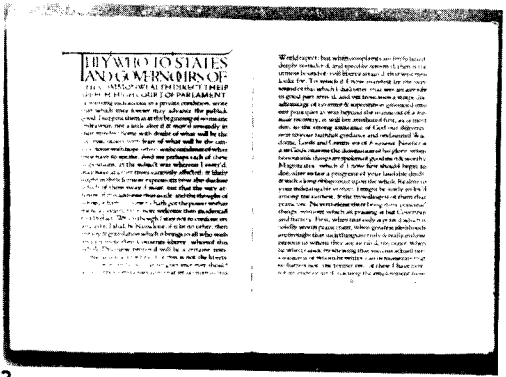
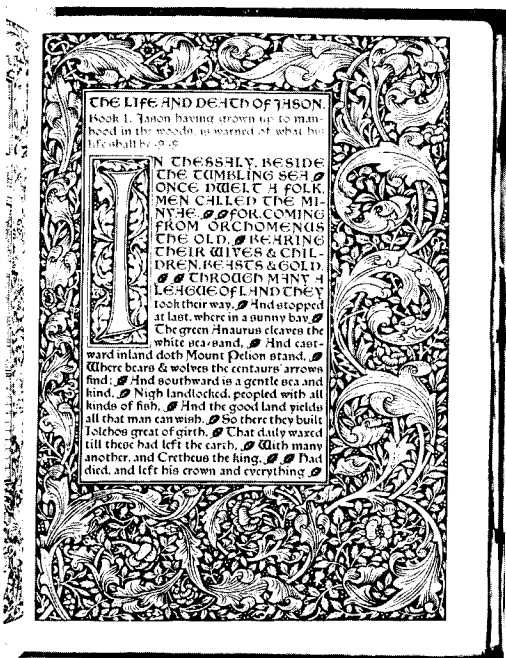
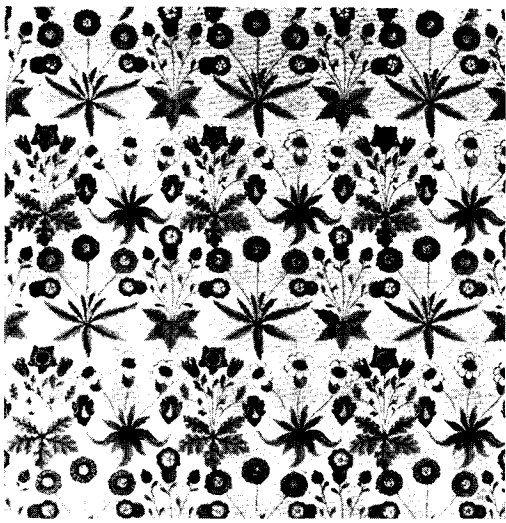

tion of what decorating a wall, decorating a floor, decorating a page should mean, namely, a balanced arrangement of form and color in the flat. That is what distinguished his works from the messy and overcrowded productions that filled the palace of the exhibition of 1851. While these qualities were kept by all those who recognized Morris's genius, there were only very few independent spirits who ventured upon a path beyond Morris, the path that led on to the new style of the 20th century.

The difference between Morris's aims and those of the younger pioneers is best shown by a comparison between a page from a book of the Kelmscott Press (started in 1890) and a page from one of the books which Emery Walker and Cobden-Sanderson produced at the Doves Press (started in 1900). Whereas to Morris a beautiful book means a book with beautiful ornamentation, beautiful initials, and beautiful illustrations, Emery Walker goes back to fundamentals and achieves perfection by the sheer clarity of the shape of his letters. This may to some appear a poor solution of the problem set to the book artist, but then this concentration and restraint, this elimination of accidentals, this economy of means and distrust of adornments are essential qualities of the new style.

C. F. Annesley Voysey (born in 1857), the most comprehensive spirit of that generation, has certainly admired bareness as a value in itself, but in spite of that his early work exhibits—almost against its creator's own will, it seems—the same independence of thought and the same truly contemporary outlook. This applies to both his architecture and his designs for industrial art. For with Voysey we come to a designer whose activity was devoted to industrial art, and no

longer to handicraft. Voysey designed furniture, he did not make it as Gimson did. He designed rugs, but did not tuft and weave. He designed patterns for printed fabrics but did not print as Morris would at least have liked to do. Voysey supplied manufacturers regardless of the process, whether hand or machine, by which the designs were to be carried out. In doing so he took a step of signal importance in the development of modern industrial art. And he took it years before Frank Lloyd Wright delivered his challenging speech on the Art and Craft of the Machine. Voysey, one is led to believe, did not speculate much on what he did, for his personal style is always so graceful and amiable that one cannot see the determined revolutionary in him. And yet the forms of his cabinet work are sometimes surprisingly bare and simple. In his most progressive pieces nothing is left of Morris's medievalizing tendencies. In his wallpaper designs and textile designs there is the most lovable freshness and lightness. Convincingly stylized trees or flowers and painstakingly portrayed birds are his favorite motives. Without worrying much about rules and principles he achieves effects as candid and round as those of genuine folk-tales.

Even more astonishing and historically even more important are the same qualities as they are expressed by Voysey's earliest architectural works, such as a house at Bedford Park, London, which was built in 1888. The general lack of symmetry here, the lightness of spirit so unusual in Victorian work, and the bold relation of white surfaces to low horizontal windows are equally adventurous, much more so in fact than most of what Voysey did in the years of his mature mastership. His numberless country houses of the late nineties and the earliest years of our century are a return to tradition, though to a tradition where it is wholly in keeping with modern requirements. Their practical and yet picturesque ground plans, and their simple elevations with mullioned windows, high-pitched roofs and buttressed walls are perfect in their way. They are never copies or imitations. Everything seems freshly and aptly conceived, and yet they happily blend into the surrounding scenery. This evolution from strik-

1, "Daisy" wallpaper, designed by William Morris in 1861. 2, Typical page, Kelmscott Press book, by William Morris. 3, In contrast typical pages from a Doves Press book, by Emery Walker. 4, An oak settee, designed by C. F. A. Voysey in 1906.

ing novelty to understanding wisdom should be kept in mind as being a typical English evolution.

Voysey was by no means the only architect in late-Victorian England who sought new forms and a new style. The most remarkable instances of independence are C. R. Ashbee's house in Cheyne Walk, Chelsea, of 1895, Dunbar Smith's and Cecil Brewer's Mary Ward Settlement, also of 1895, and C. H. Townsend's Whitechapel Art Gallery of 1897-99. These most progressive English buildings have a peculiar wilfulness of detail in common. They may lack in balance but they convey a strong feeling of youthful enterprise. In Townsend this quality goes so far that his main desire seems to be to excite the public by a display of something unprecedented.

Now this attitude is undoubtedly in discordance with usual English mentality, and it is therefore not surprising to find that its most brilliant representative on the British Isles was not English but Scottish, Charles Rennie Mackintosh. The fanaticism with which Mackintosh shapes and details a room so as to make it a unique piece of spacial art was not to Voysey's liking and has always remained slightly uncanny to English critics. Mackintosh on his part has certainly learnt a good deal from Voysey's designs, but at least as much from Beardsley's and Toorop's exquisite and decadent drawings. And just as Beardsley as a draftsman must be considered an exponent of Art Nouveau, so must Mackintosh's architecture and interior decoration be considered a true expression of that odd Continental phase in the development from period imitation to the new style of the 20th century. One would never associate Voysey's designs with Art Nouveau, although they strongly impressed its Belgian creators. With Mackintosh it is different. His works possess a delicacy, a swift imagination, an enchanting suppleness and, sometimes, an indulgence in freakish vagaries which are all betokening Art Nouveau. No wonder that Mackintosh was one of the principal inspirers of the Viennese style of the "Sezession."

And as Voysey influenced the Belgians and Mackintosh the Austrians, so did the Morris Movement and the Arts and

Crafts Movement in many ways influence the beginning of a new era in German architecture and design. The connecting link here was Hermann Muthesius who had lived in London from 1896 till 1903. He brought home the new gospel of simplicity, utility and comfort — Voysey's more than Mackintosh's gospel — and preached it in order to replace Art Nouveau by a sounder and simpler style. Thus he was the main promoter of the idea of the German Werkbund founded in 1907 to foster good contemporary design. In close cooperation with the ideals of the Werkbund were those who developed the new forms in Germany, Peter Behrens first, and Gropius later. The goal was reached about 1910-11, Loos's Villa Steiner and Gropius's factory at Alfeld being probably the most advanced examples carried out before the war. Almost everybody would mistake buildings such as these for 1930.

These remarks on Continental architecture were necessary, because the fact has to be stressed that England did not produce anything so progressive before the war. What were the leading tendencies in England between 1900 and 1914? Voysey's and Baillie Scott's style for country houses, i. e., an extremely pleasant and reasonable adaptation of late medieval domestic building, and Norman Shaw's and his followers' style for town houses. While on the Continent Neo-Renaissance was replaced by a wild Neo-Baroque turning out over-decorated facades of bulging relief, Norman Shaw in England also gave up Neo-Renaissance — i. e., its English version, Neo-Elizabethan — and rediscovered Queene Anne, the style which was coetaneous with Continental Baroque though aesthetically almost its reverse . . . owing to the fact that English mentality was at the beginning of the 18th century similar to what it is now. Shaw revived

5, A Voysey cretonne design. 6, A house by Voysey, built near Malvern in 1893. 7, House in Cheyne Walk, Chelsea, by C. R. Ashbee, 1895. 8, The Horniman Museum, by Townsend, 1897.

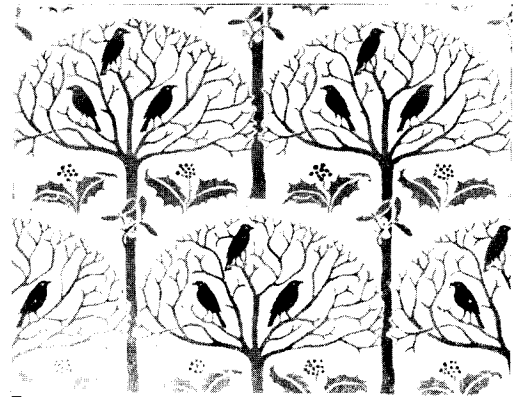

5

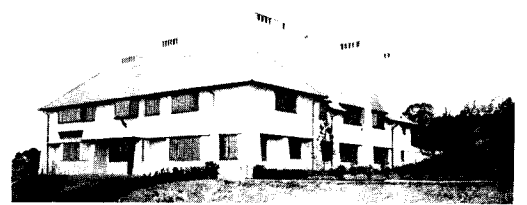

6

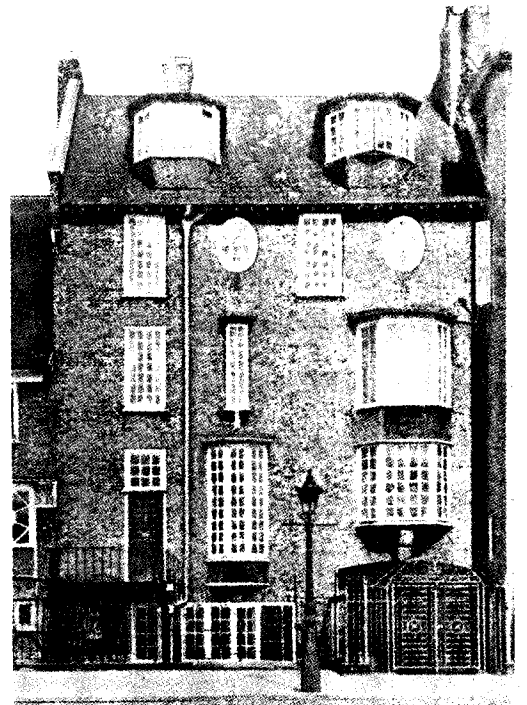

7



8

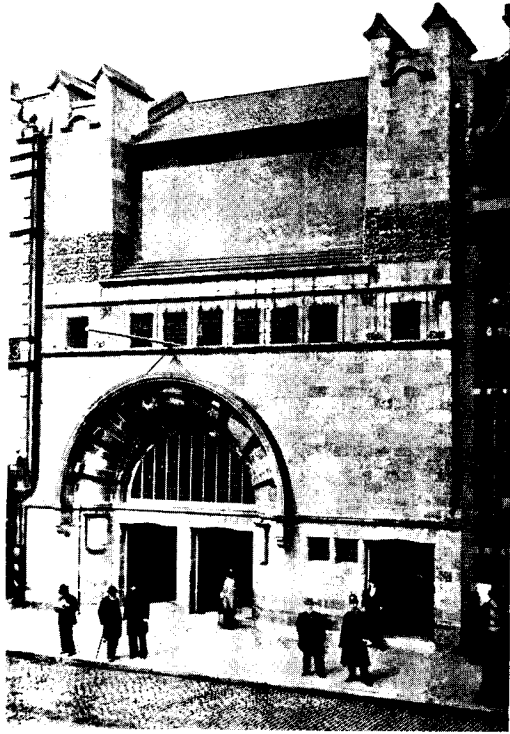

9

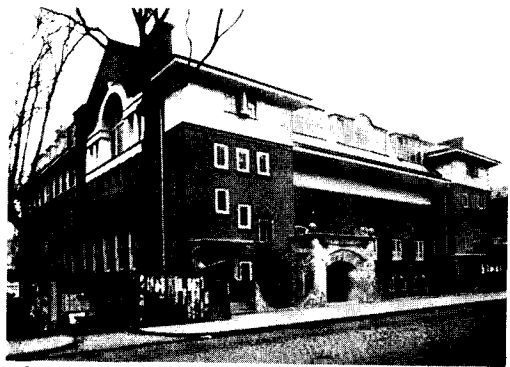

10

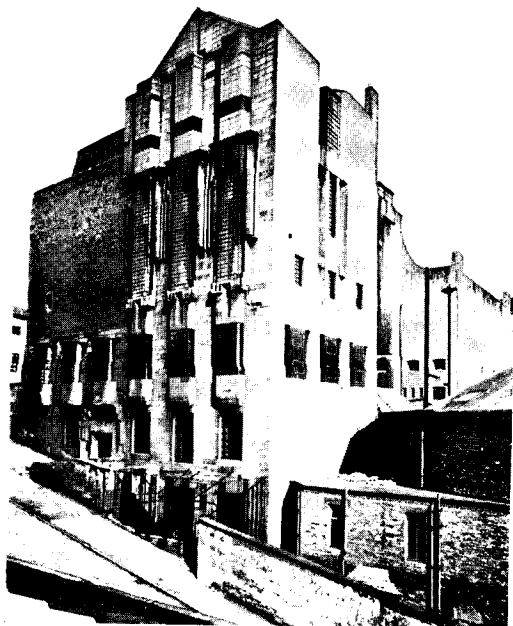

11

9, The Whitechapel Art Gallery, by Townsend, 1897-1899. 10, The Mary Ward Settlement, London, by Smith and Brewer 1895. 11, The Glasgow School of Art, by C. R. Mackintosh, 1907.

the simple forms of Queene Anne facades—the first instances of the revival date from just before 1880—and with their aid created (just like Voysey) something so reasonable and suitable for modern needs that one cannot help calling it modern although it was avowed period imitation. Lewis Day was right when he once alluded to the Neo-Queene Anne as a “no-style-in-particular.”

So the situation in England during the first decade of our century was like this: those architects who felt young and progressive followed Voysey and Shaw, whereas those employed on the big official jobs still preferred to borrow their effects from late Roman grandeur or Baroque pompousness. One of the most showy examples of the pre-war years is Daniel Burnham's Selfridge store of 1909; one of the most dignified and accomplished John Burnet's back facade of the British Museum (1914).

If we now compare this situation with, say, 1925 or even 1929, we see that not much has changed. The majority of new public buildings, of headquarters of banks, big business firms or municipal and governmental departments, still go in for a kind of Neo-Caracalla. The illustrations show instances of 1922 (the Port of London Authority by Sir Edwin Cooper), 1925 (Britannic House in Finsbury Circus by Sir Edwin Lutyens), and 1929 (Nottingham Council House by C. Howitt). Sir John Burnet's new building for Lloyd's Bank (1927-31) could also be quoted. And, according to the results of some of the most recent competitions, one can hardly say that this kind of architectural expression is dead and buried in this year of grace 1937. Still, today, some English municipalities seem to like representing their dignity by disguising offices with rows of colossal columns invented for

purposes entirely alien to the present day.

In a way one could probably accuse most English detached and semi-detached middle-class houses of the same lack of contemporary spirit. So far as the typical builder's suburban estates go, nobody would hesitate to do so. Sham half-timbering and similar bastard effects still prevail. Thinking, however, of the type of small houses as they were built before the war at the Hampstead Garden Suburb, and after the war at Welwyn Garden City, or of larger houses of Georgian inspiration, one feels unable to uphold one's objections. Maybe they are more conventional than justifiable in a time as hard and ruthless, as adventurous and unsafe as ours, but in any case they are comfortable, soundly planned, well workable and devoid of unnecessary fuss—exactly as English social and political life appears, if compared with the unrest and the violent ups and downs in nations of more passionate nature. Here we are probably faced with the final explanation of England's attitude towards the new style of our age, a style of “totalitarian” character as is every genuine style.

Twentieth century England has often been blamed for her slowness in taking up new movements. She rather likes other nations to try out lofty schemes. Political and social pioneer-work entails a good deal of turmoil and upheaval. Let all this first settle; we shall then have ample time to examine what is good and lasting in the new system and quietly to adopt it. The lack of contemporaneity inherent in this principle does not seem to worry people in England. With regard to design, R. Goodhart-Rendel, a distinguished architect, said two years ago: “New or old in style? It will all soon be old, and neither better nor worse in itself for that.”*

It is precisely this quality that makes modern buildings on the Continent so exciting. Now the *idiom* which impresses us in these buildings, although it was formed before the war, did not become universal immediately after the war in the most progressive European countries either. Taking Germany as the center of the group of those

*Professor Goodhart-Rendel in *The Conquest of Ugliness*, Methuen, 1935.

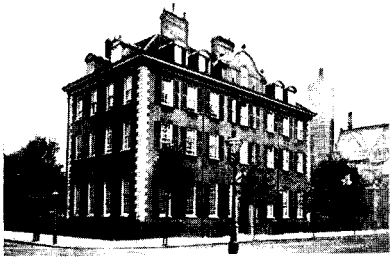

12



13

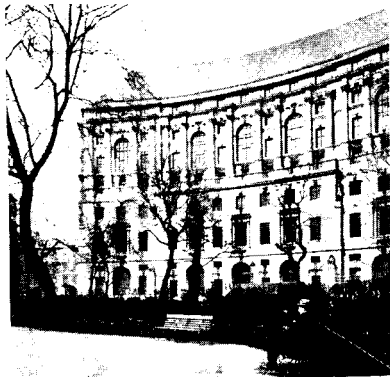

14

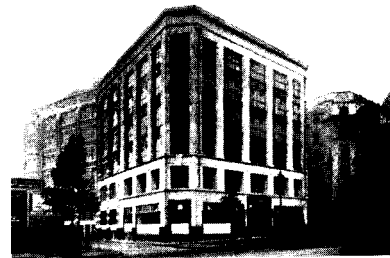

15



16

12, House in Queen's Gate, London, by R. Norman Shaw, 1888. 13, Britannic House, Finsbury, by Sir Edwin Lutyens, 1925. 14, Nottingham Council House, by Cecil Howitt, 1929. 15, Kodak Building, Kingsway, by Sir John Burnet, 1910. 16, The Library of C. R. Mackintosh's Glasgow School of Art, 1908-1909.

countries in which the Modern Movement was most wholeheartedly accepted, one finds the following state of affairs in running through periodicals and trying to recall events. Between 1918 and 1924 the first post-war shock brought a reaction towards a kind of infuriated Neo-Art Nouveau, something clearly connected with what is called "Expressionist" painting. The languid melodies of line in Art Nouveau decoration have now become crude angles pushing forward

and against each other in the syn-copated rhythm of Jazz. Sobriety returned about 1924, and the masterpieces of 1910-14 were re-installed. Between 1925 and 1928 most of the work illustrated in go-ahead Central European magazines was representative of the new style with its straightness, plainness and airiness, and its easily recognizable details such as flat roofs, wide white surfaces, eliminated moldings, and sweeping horizontal windows often carried around the corners of

buildings. In 1932 one can safely say period imitation had entirely disappeared, and traditionalism almost entirely.

In England, perhaps the most "modern"-looking building of pre-war years is Sir John Burnet's Kodak House in Kingsway (1910), a structure clearly exhibiting its steel frame and not recurring to the past for decorative adornment. If we compare it with the same architect's Adelaide House of 1925, a similar spirit prevails, although the unity



17



18

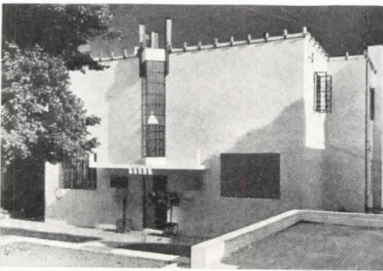

19

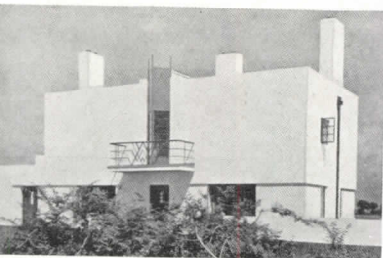

20



21

and separateness of the block are more emphasized, and details are harder and severer. Something menacing has been introduced that was absent before the war. The treatment of the entrance and its surroundings tell of American influence, that of Frank Lloyd Wright in particular.

In the year following that of the erection of Adelaide House, the first building was set up in England that wholly represented Continental post-war tendencies, "New Ways" at Northampton, by Peter Behrens. Whereas the garden front of this house relies for its charmingly harmonious effect on proportion only, the other side has some features, such as the bay window on a triangular base, which point back to the year of "Expressionism." And, in fact, those young English architects who were anxious to conquer for England the new style could not help passing through a short period of "*Sturm und Drang*." Thus Raymond McGrath designed the fantastic interiors of Mr. Forbes's house, "Finella," in Cambridge in 1929, and T. S. Tait built some houses at Silver End near London in 1928 of which one re-echoed the jagged parts of Behrens's house, the second took up French experiments in asymmetrical grouping, whereas the third, a row of cottages, achieved composed equilibrium with a minimum of individual effects. Since then, every year has brought some more instances of the new style. In 1927-29 Charles Holden erected the Underground Building, in 1930 Joseph Emberton the new facade of the Olympia—with obviously Dutch details. For 1934, 1935 and 1936 it would be impossible to enumerate all that belongs to the new style.

It seems alarming that so often the historian, in dealing with modern buildings in England, has to point to foreign sources. Are there no pieces of architecture (this must be the last question to be answered) which are genuinely English in their design, although they show the international style of the present day? For there cannot be any doubt that this modern architectural style, while seemingly international, is in point of fact subtly differentiated into various national idioms. French grace and intellectual extremism can easily be distinguished from German thoroughness and precision or the charm of the Swedish Golden Mean, or from the new Italian Romanita. Is there anything as English in English modern building as there is in Voysey and Norman Shaw?

I think one can point to a few examples at least. Let us single out Mr. Charles Holden's suburban Underground Stations. Take Arno's Grove, for example (1932-33). You see a small building of simple and restrained shape, as bare as anything on the Continent and as functional too. In fact, the function of the Underground station, being something like a pithead, could not find a more adequate expression than this low cylinder coming right out of the ground. And yet, with all its functionalism and plainness, something is kept here of English dignity, and even of English tradition. In buildings such as these Underground stations a synthesis seems achieved between the character of our century and the inborn character of the English, a synthesis that leaves us full of hope for the future of the Modern Movement on the soil which once begot it.

17, The Edward VII Galleries, British Museum; by Sir John Burnet, 1914. 18, Adelaide House, London Bridge, by Sir John Burnet and Tait, 1925. 19, House at Northampton, by Peter Behrens, 1926, the entrance side. 20, House at Silver End, Essex, by Thomas Tait, 1928. 21, Arnos Grove Underground Station, by Adams, Holden and Pearson, 1932.

The English Scene

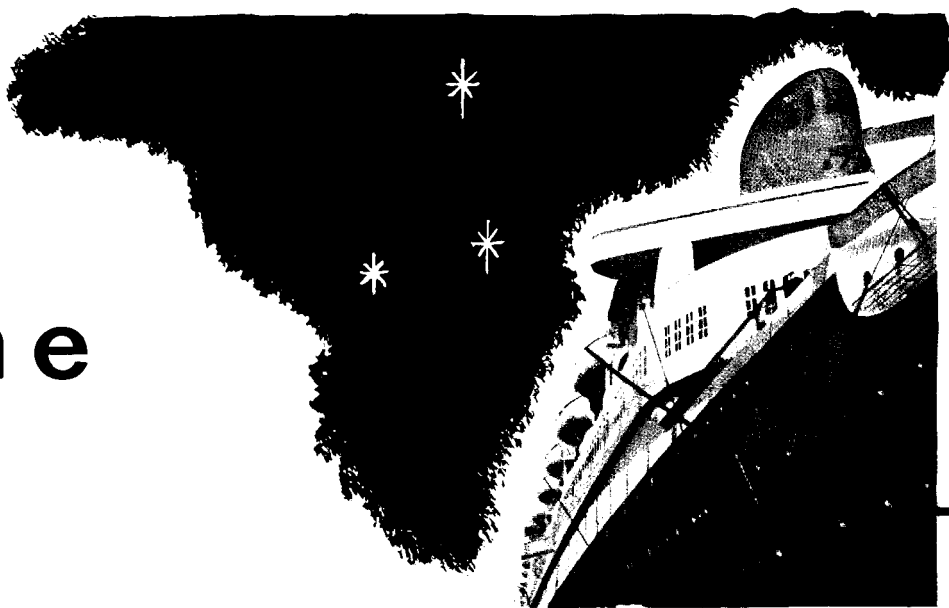

By
Hugh Casson

THERE was a time when the English scene could be found as near Broadway as the further end of a gangplank on Pier 90. From the clamor and arc lamps of a midnight wharf, the traveler stepped into the tangle of tortured oak and beaten pewter which created, for the delight of every one on the ship except the passengers, an atmosphere of Olde Englysshe good cheer. For the next few nights he dined inevitably seated in a Windsor chair screwed firmly to the floor, played bridge in an inglenook, and warmed himself at a glowing "Electrolog" fire. But "*Tudor omnia vincit*" has now ceased to be the motto of shipping companies. The hand of Lalique lies heavy and glistening on lounges, flush paneled in Empire woods, and so cavernously top-lit, that the furniture wears the despondent air of having settled at the bottom of a tank, in the dim depths of which the passengers grope and bump their way. England has been driven off the seas, to make way for Paris, Barcelona and Zenith.

Sylarite, but still a victim of that dreariest of fates, a compelled member of a group of people in whose composition he has had no say, the traveler will greet with relief the

first gray outlines of what D. H. Lawrence has called "our poky and inoffensive little country," however remotely it may resemble the pictures, imagination and the fashion artists of "Esquire" have combined to create for him.

England is a country of secret delights, and her glories are not thrust upon the casual eye. Here is no dramatic skyline, no welcoming sirens and fleet of committee boats. The traveler must land, as Anita Loos says, "on the beach," and nearly a hundred miles from London. He will be wise to appreciate this gradual approach, which will enable him more easily to adjust himself to the novelty of the English scene, with its curious combination of miniature scale, and heaviness of proportion, in people, buildings, food and landscape.

Southampton conceals behind its busy harbor an appearance and form very typical of the haphazard English country town, which wears its history plainly written upon its face, and its future as plainly written on suburbs and hoardings. The old town wall still skirts the shore and incloses a huddle of bow-fronted houses, down-at-heel hotels, and gaunt warehouses. Built on a peninsula, development has been confined to one direction and the traveler, driving up the main street towards Lon-

don, can see, as well here perhaps as anywhere, the story of architectural progress, page by page. The stucco and elegance have gone by the time the Bargate is reached, straddling the street, isolated, ridiculous and festooned with tram cables. From here on it is a familiar parade of familiar units; the standardized facades of chain stores; the Jubilee clock tower; the staring, new town hall; the Gothic Revival club; the Methodist chapel; the War Memorial; the bulbous public library; the parks; modernistic cinemas; past the old well-to-do suburban mansions, engulfed by development; past the housing estates and the last straggling fringes of brick, stretching out like the purple knobbly wrists of children outgrowing their coat sleeves, into the country. These units, in various arrangements, combine to give to the majority of English towns a monotony of appearance and shape, inevitable when there is no longer a tradition of local craftsmanship

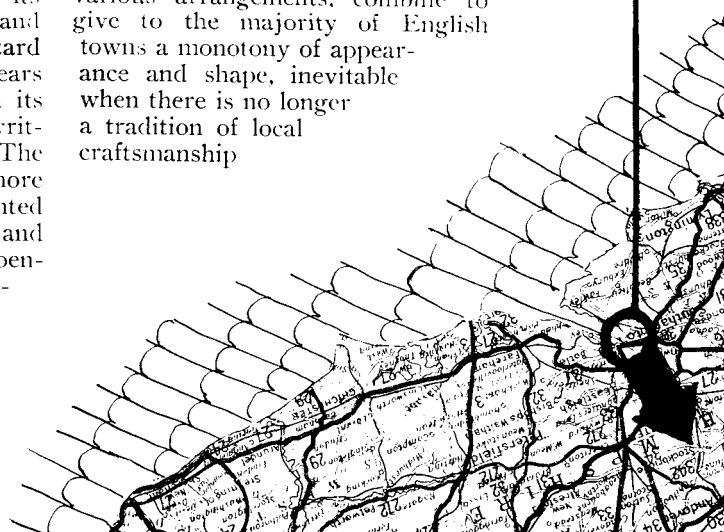

T H E



and materials, but puzzling to the stranger, who can now no longer tell whether he is in a brick or a stone country, except by observing the painstaking facades of the more conscientious chain stores.

The English countryside, more particularly in the south, has the appearance of a very large and prosperous estate under the management of a Croesus. The scene is comfortable, domestic, and on the human scale. The multiple elements which make up the landscape can be interpreted more easily by the stranger, if he remembers that these typical features—the hedgerows, coppices, fields and plantations—are artificial creations of man, carried out to reduce the scene to a personal and individual scale. The influences of Poussin, Claude and Hobbema, the work of Brown and Repton, have formed, on a basis of agricultural economics, the English scene as it appears today. The eighteenth century tradition of improvement, when every local squire molded the neighboring countryside to form a personal setting to



his house, is still there today in the heart of a man who starts a chicken farm on a by-pass. Every Englishman is at heart a countryman; he is not, like the American, bewildered by the peasant, and for this reason insists on a plot of ground to encircle his home. Then one more villa stands, perky, insecure, but surrounded, anyway on three sides, with "Property" to join a thousand others, covering acres of ground and yet creating no space.

Inevitably, too, the architectural elements of the scene, the church, the mansion, the inn, the cottage, have changed in character. The

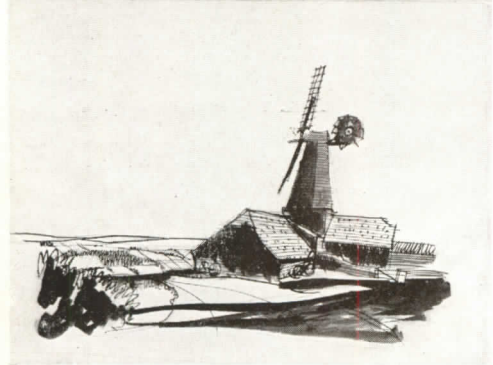
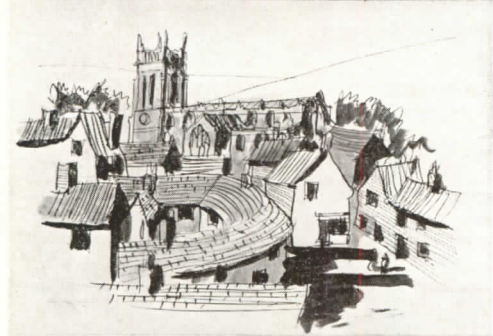

N G L I S H S C E N E

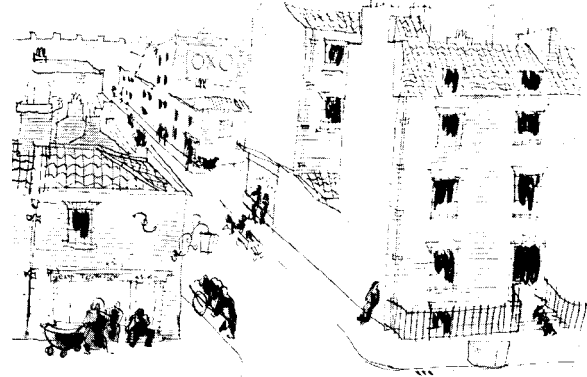
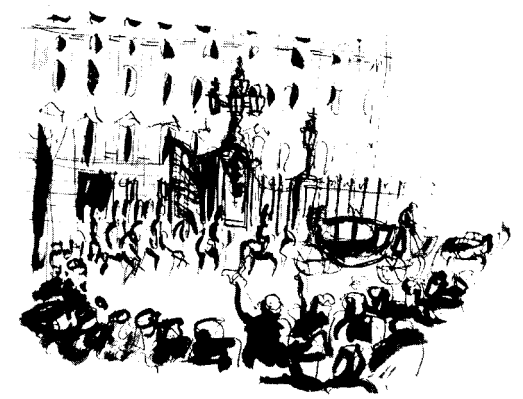
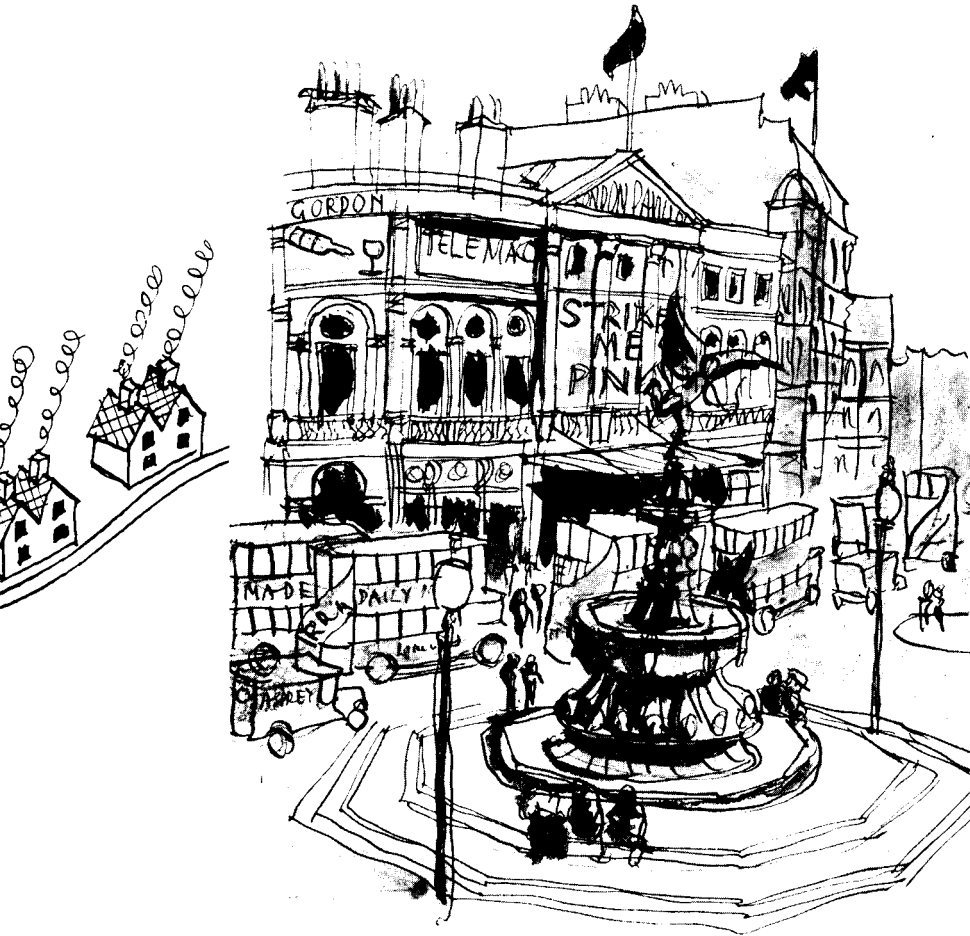

focus of village life has moved on motor bicycles to the local market town. The mansion meets one of two fates; the estate is either encumbered with building development or, taken over by a municipality, it hangs on a fraying cord of serenity over the depths of disorder and ugliness, the grounds littered with railings, urinals and dapper little tea-châlets. The inn caters now to the passing motorist; conscientiously designed by architects to reproduce the appearance of an old hostelry, its sign painted by an Associate of the Royal College of Art, declared open by an M. P. or dramatic critic. . . . It is easy (but erroneous) to suppose that the old inn was a center of good-humored revelry, but at least it never wore the air of respectability which hangs like a cloud over the typical road-house of today.

There are many of them on the Southampton-London road, punctuating the rows of villas and garages like posts in some nightmare fence, erected to screen off the country behind. He who penetrates beyond this fence, off this or any main

road, is rewarded by a lonely expanse of countryside, unspoiled and mellowed, where the parish pump has not yet got "Shell" stamped upon it, and where England of a hundred years ago can still be glimpsed behind a yew hedge or through a half-opened cottage door.

Winchester, crouched long and gray at the foot of the downs; beechwoods and turf; the sandy slopes of Surrey, with week-end cottages and red and white striped sanatoria; the villages straggling closer and closer, until imperceptibly they join in the fringes of outer London; the stucco-fantastic factories of the Great West Road; scarlet busses, clamor and London has swallowed the road, and it has become a street.

No traveler can enter a foreign city, however beaten the track which leads to it, without a thrill of anticipation. For the American in London this thrill is sharpened by a sensation of home coming. Even on his first visit, he feels he has been there before. Fenimore Cooper remarked upon it on landing at Liverpool, and thousands have ex-

T H E E N G L I S H S C E N E

perienced the same feeling since.

It has often been remarked that England is not to be found in the cosmopolitan atmosphere of the capital. The visitor is urged to seek her quality in the somnolent market places of the West; on the green smooth lawns of quadrangle and cathedral close, or in the curious, evanescent airs of coast resorts, now desolate, now crowded, stretched beneath the flapping seaside wind; in the mountains of Wales, or the marshes of Essex. But London is inexhaustible, a thousand cities in one. Others yield up their treasures within a few days; after a lifetime London still baffles and allures. In her vastness lies that magical air once held by Babylon and Byzantium. There is an atmosphere of confidence, good nature and security, which is the essential basis of city life, and is not found in the senseless hurrying crowds and shrill preposterous streets of Paris and Rome. And yet surely no other great city has so shabby a skyline. Incoherently the roofs sprawl from Southend to Slough, from Bromley to Watford, with scarcely a noble building conspicuous above the tangle of chimneys. With few exceptions her proud and famous monuments stand in narrow alleys, behind locked gates, in the shadow of gloomy office buildings or slovenly warehouses.

The past, worshipped by the townsman in the country, is no idol here. A Regency Square still stands because no financier has chanced to purchase the site. Inevitably an eighteenth century terrace awaits destruction, but not until it will pay 12 per cent to do so. Even the Gothic Revival build-

ings are disappearing, mourned only by the scholar architect, bosomed high in Tufton Street.

Preeminent in the London scene is the quality of contrast. Slums huddle almost to the walls of Buckingham Palace; London University stands among the disheveled decay of boarding houses; the dome of St. Pauls itself peers between towering office blocks. This spirit of contrast is characteristic of the Londoner as well as of London. A fierce worshipper of traditional ceremony, he is indifferent to the artistic heritage of the past. Cancel the trooping of the colors and a nation is aroused. The Adelphi is demolished in unprotesting silence except for the ineffective cries of intellectuals.

In the babel of styles which com-

bine to create the London scene, it is not surprising that an unpretentious building stands out like a masterpiece. The Underground Stations, the new University, Battersea Power Station, Simpson's Store, Broadway House, Universal House, Crawford's Offices, Broadcasting House, Mount Royal, the Curzon Cinema, the Cambridge theater—a miserable handful for a great city, but London has never been quick to learn and too late has heard of town-planning. It is unnecessary to speak of her famous glories: the Parks, Westminster Abbey; Greenwich Hospital, the city churches. It is not in these that London is unique, nor even in her position as the greatest port in the world and the center of world finance. It would not be difficult to live in London and remain unaware of these activities and powers. Her glory, in the spring or in the fall, lies in the ever-changing and contrasting elements of nature, architecture and atmosphere. The stonework, silver and soot-black, and starlings clustered on a floodlit cornice; winter mists on which London floats as on a gray and tranquil lake; shop windows and the hooting of steamers; the pagentry of uniforms and the smell of hot pennies; the nightly curfew in the city and the bright-lit tunnels of the Underground. For the rubberneck a frantic maze in which await discovery the elusive church, statue or gallery; for the leisurely wanderer a bewildering pattern of tiny units, paradoxical, fascinating and infinite in the variety of their appearance and mood.



THE ARCHITECT AND HIS PATRONS

By J. M. Richards

IT is the misfortune of architecture that it needs more than a school of enlightened architects to produce a generality of enlightened building. The architect cannot, like the painter or musician in the seclusion of his studio, labor at the production of masterpieces, and present them to the world whether the world welcomes them or no; leaving a perhaps distant posterity to appreciate their value. The architect is tied to his patron. Each of his works is the fulfillment of a particular program, not set, as with the artist, by the reaction of his own sensibilities to the circumstances that surround him or by the vision he himself creates, but set by the practical needs and wishes of some one else: only the quality of the work as art depends on his own vision. Architectural designs done on paper, "projects" as they are optimistically called, are in no sense architectural works; the method and the quality of actual building are so vital a part of architecture as such.

Further, the public, narrowed down to the "some one outside himself," whose word of command the architect's talent must await, for the purpose of patronage transforms himself into a sum of money. Architectural design, economically, equals capital invested in property. So the architect is tied to the existence of an actively interested public, and also to that public's economic system and organization.

Still more, of course, is he dependent on that public's views, prejudices and real or imagined requirements in the way of architecture for the degree in which he is to be allowed to produce the architecture that seems right to him—so we get the factor known as "taste"; though whether taste altogether molds the architect or the architect taste is a variable question that lies outside our province at the moment. And we are ignoring here the architectural practitioner—to be distinguished from the architect—who is merely the slave to taste and who designs, not according to his feeling and conviction, but to order.

It is typical of this generation that architectural patronage—the public interest that we have observed as the basis of the architect's very existence—is neither an informed one nor one pointed in a definite direction. We have suffered recently and still do suffer from the lack of any unity of purpose in our

architecture—fundamentally from the lack of any unity of purpose in the organization of our lives: our architecture responds to this. The public taste, which the mass of what I have called the architectural practitioners simply reflect, and which the true architect finds to a greater or less degree imposed on him, is formed of a whole confused array of half-assimilated ideas: snobberies, inaccurate generalizations, misdirected sentimentalities, fears and ambitions, that even an occasional leavening of simple common sense and honesty has no chance of molding into a habit of architectural thought expressive of anything but chaos. Now the modern architect seems to be alternately in the position of a leader of accepted form or of a revolutionary against it. Today—though a little less than yesterday—he is the revolutionary. In contrast to his position in, say, the eighteenth century, when he refined (invented new and revitalizing variations on, produced a personal expression from) a universal anonymous idiom that was the universal language of architectural thought, he is now fighting to establish a new contemporary, universal (and, in time, anonymous) idiom—inspired by the example of his predecessors and the unconscious invitation of his time. And he is fighting against the tide of casual eclectic "taste," commercial degradation and sterile antiquarianism into which his generation has drifted.

His success depends, as we have suggested, on patronage. His patron may take the form of a private client, a board of directors, a public corporation, an official body or a disembodied but none the less influential mass—public opinion; his patron, as distinguishable in these categories, varies in his appreciation of the modern idea (or, alternatively, in his resistance to it); in his degree of awareness of the essential vitality—the contemporaneity—of the new architecture; also in his degree of freedom from the compulsions of economic circumstance. The quantity of truly modern architecture that results from different kinds of patronage varies, therefore, quite independently of the quantity of work done or the quantity of money spent.

So, in the pages of illustrations that follow, showing typical modern buildings that have been put up in England, and in classifying the illustrations, I have

taken the type of patronage as the method of classification. For convenience sake—though at the expense of a certain amount of generalization—five categories have been made: first, municipal (or official or government) buildings; secondly, buildings for public services (the great public corporations that, to distinguish their function from the mere provision of service as a trade, owe some responsibility to the public); thirdly, these private enterprises (that provide service to the public but are responsible only to themselves)—we have called them community buildings; fourthly, industrial buildings—many of which the public does not even see; fifthly, buildings for private purposes—chiefly residences.

The first category—municipal or government buildings—it is quite safe to say shows the most reactionary attitude of the five. The government, national or local, as a patron, is particularly unaware of the possibilities of modern architecture, its essential modernity—even its existence, except as an alternative, rather “Bolshie” style. The idea of one contemporary architectural method seems not to have penetrated to any of its embodiments. Most of the few modern examples of local municipal architecture that exist owe their existence to some freak of circumstance, or to some enlightened personality in a responsible position who, more often than not, carries out his good work in opposition to the committee that appoints him. The illustrations in this category are given under the one title “municipal” (local government) because under the other half of our title, “government” (that is, central government), not a single modern example could be called to mind.

The most important central architectural authority in England, the Office of Works, that is in a sense both an architectural office and (as the relevant department of the government) a patron, has many virtues—of thoroughness, good manners and even scholarship, but the style of architecture it favors is the politely traditional, the simplified Georgian—brick and tile and small-paned windows—at the best, negative. The architectural office of the London County Council is the same—perhaps even more cautious and conservative: negative qualities that become tragic when it is seen how they stultify the opportunity that the present-day great housing program of the Council offers. In Liverpool the housing program has been fortunate in finding a more modern-minded architect to carry it out: L. H. Keay, the Liverpool Housing Director, has been doing some of the best official housing work of recent years. A few other cities are applying modern ideas to this essentially modern problem. More, unfortunately, are not. Official architects generally are conservative respectable practitioners, with little chance of being anything else seeing the way their art is regarded by the Councils that rule over them. Most Councils and Municipalities, however, employ no architect of their own, but hand over the architectural work instead to their

Engineer. This indicates their attitude to architecture; though in fact some of the Borough Engineers produce some excellent work, probably because their rulers regard them, for a change, as experts, not as the servants of their own “taste.” One encouraging exception: Recently the modern architectural group, Lubetkin and Tecton, were appointed official architects to one of the Metropolitan Boroughs in London, who plan to put in hand a large quantity of work.

Important municipal buildings, such as new Town Halls (of which, with the increase in bureaucratic complexity and the need for its accommodation, there have been a great number built recently) are rarely designed by official architects, but are put up for open competition. The chosen design, however, selected by an academic assessor appointed by the Royal Institute of British Architects, is usually of the tame Georgian variety; the modern architects, knowing that they have no chance, do not compete, and the best that can be expected is a simplified neo-Swedish as a change from the commoner neo-Sir Christopher Wren. The municipality gets what it wants, but it cannot be much of an exaggeration to say that this persistent reactionary attitude to architecture, this philistinism, on the part of those in official authority is chiefly responsible for the architectural chaos that still exists in this country. “Safety first,” the Wren-fixation, the snobbery of displayed expensiveness, between them maintain the false position of architecture in relation to reality, and its diffusion of purpose. And the modern architect is denied the experience of building for public appreciation; he is driven continually back to the enervating atmosphere of exclusive private patronage—out of which no universal modern idiom can ever grow. Modern architecture in England has not ever had the encouragement of official blessing, as in the short period of creative architecture in Germany between 1920 and 1931, or as today in Finland or Czechoslovakia.

In contrast to all this our second category of patrons shows us a little hope of a large-scale regeneration of architecture. The great public corporation, itself a typical product of the modern world, is sufficiently a *business*, depending on its efficiency for success, to appreciate and to wish to utilize modern technique to the full, and sufficiently autonomous in organization to be free from bureaucratic conservatism and *laissez-faire*. The public corporation, together, to a limited extent, with the great business house, has become the modern patron, the contemporary equivalent of the Renaissance prince-bishop. In the same way that poster art and advertisements successfully exploit modern art idiom—nonrepresentational design and abstract symbolism—to a degree that the public is slow to accept when the same idiom is presented to it as “fine art”; in the same way that window-dressing and posters and packaging and neon signs provide art more vital to the man in the street (though not necessarily recognized by him as such)

than that of any of the academies, the influence of rational forward-looking design sponsored by the great public corporations permeates the public consciousness and does something towards preparing the public mind for the reception of a new idiom.

In England the public body that has had the most beneficial influence in this way is the passenger transport Board, which is responsible for the passenger transport on road and rail throughout London and its neighborhood. Though only recently reconstituted as a semi-public Corporation, it previously, as a private company, set the same high standard of design. Much of the credit must be given to Mr. Frank Pick who, as publicity director and as managing director, gave the company its impetus in this direction and has maintained its vitality by constant experiment and advance.

In the field of posters most of the best work of McKnight Kauffer, an American and the most distinguished commercial artist working in this country, was done for and commissioned by the London Underground: for many years the Underground poster series has set a standard and *maintained an initiative* whose influence has been very widespread. The Underground Railway stations, mostly designed by Charles Holden, have dotted London with a series of decent efficient buildings that are modern without being outrageous and traditional without being stylistic. They must do a great deal of good in familiarizing unconsciously the crowds that use them with the practical virtues of modern architecture. They put to shame the average design standard of the suburbs in which they are planted. The Underground Railways, too, have maintained in their signs, their lamps, their roadside and station equipment a careful standard of good design, homogeneity and unobtrusiveness that has been of incalculable educational value. Their standardized lettering is based on an excellent model; the typography and format of their advertisements is sound and considered. Their actual vehicles, too, their busses, trams and trains have always been in the forefront of modern design.

Another public corporation that has shown intelligence as a modern-minded patron is the B.B.C., the British Broadcasting Company. When the B.B.C. built its new central headquarters in London, though the external expression of the building itself is unfortunately only of the simplified academic kind, for the interior design, decoration and equipment it appointed a team of young architects of the modern school, Raymond McGrath, Serge Chermayeff, Wells Coates; and this opportunity gives them also the impetus to a quantity of good modern interior design.

In the category of public services can also be placed the London Zoological Gardens, though actually the Royal Zoological Society that owns the Gardens is a private not a public concern. The past secretary of the Zoo, Sir Peter Chalmers Mitchell, as an enlightened patron of modern architecture, appointed

Lubetkin and the Tecton group of architects which he leads as the Zoo's architects, and this patronage is being continued by the present Secretary, Mr. Julian Huxley. The outcome has been a series of essentially modern experimental buildings to house various animals; buildings that have gained greatly by not being subject to the legal and technical restrictions to which the designer of shelter for human beings must conform, which show real formal imagination and which have made the London Zoo and the Society's Zoological park at Whipsnade places of architectural pilgrimage.

One other series of buildings ought to be specifically mentioned under this heading: those that the Miners' Welfare Committee has built at pit-heads in all the coal-mining districts of the country. Supplied with funds compulsorily subtracted for the purpose from the mine-owners' royalties, and employing its own group of architects, the Committee has erected a number of pit-head baths, wash houses, canteens and so on which, though they vary widely in architectural merit, at their best are an efficient and at the same time human expression of the problem which they meet, economically and logically solved.

Among business houses one would mention the Shell-Mex oil company in the field of art only, the series of posters they have commissioned from modern artists making important contributions to poster art and to the public awareness of art as a vital activity; but unfortunately the only considerable architectural venture, their new London headquarters, has not resulted in a modern building but, like the B.B.C.'s, in a simplified monumental one whose virtues are the negative one of inoffensiveness and the doubtful one of dramatic impressiveness by size and situation.

One would expect under this category to mention the various Universities as forces in the evolution of modern culture. But in spite of their capacities as leaders of education, their cultural contribution as yet is negligible. As architectural patrons they are academic: sometimes demanding actual period imitations; at best a more or a less imposing academic conservatism. The recent University Library at Cambridge, the new Bodleian at Oxford, now under construction, the new buildings for London University—the latter to a rather less extent—are examples of lost architectural opportunities.

Our third category, that which we have called community buildings, is the one of which the greatest number of illustrations is given simply because it spreads itself over the greatest number of building types and represents, apart from housing, the greatest expenditure on building. The number of its examples is not due to any concerted policy shared by the various committees, boards, proprietors, etc., that personify the patronage in this category; their very variety prevents. This is the category in which public taste is most accurately reflected — or what building

owners, cinema proprietors and chairmen of directors consider to be the public taste: by no means always the same thing. So we get the innumerable blocks of flats in a conscientiously English style, Tudor or Georgian, appealing to security and sentiment—and in contrast we get the occasional modern enterprise in the shape of flats whose owners have some faith in the public ability to recognize vitality when they see it, and the public common sense to prefer convenience and dignity to the burdens that affectation imposes. Though here we may notice that modern flats must still sell themselves on practical details of comfort and convenience: modern architecture as such is not a selling virtue. In this category also we get the hospitals and the schools, of which a fair number of modern examples exist, partly because the persons or committees that run them are not dependent on their judgment of public opinion in deciding whether or not they can afford to allow freedom of design to a modern architect, and partly because the nature of these building types—particularly of hospitals—needs the practical advantages that modern architecture can provide. In the case of shops the advertising value of modernity must be considered as an incentive to build in a modern way, though this advantage is qualified by two other factors: that the more modern architecture spreads the less attention one example of it will draw upon itself; and that patronage thus inspired does not distinguish between the modern and the “*moderne*.”

Little need be said about our fourth category, industrial buildings. Utilitarianism, that goes with industry, at least encourages modern design in its more negative sense of seeking practical solutions before stylistic effects. Industrial buildings are negatively modern, too, because their proprietors do not think it worth while to spend money on the embellishment that they might otherwise demand. They do not regard their buildings even as possible works of architectural art. But sometimes, industry is responsible for *positive* architectural virtues. The synthesis of a complex organizational program resolved by the hand of the architect into a legible whole, of good building craftsmanship applied with evident judgment and of formal sensibility, may produce a true architectural monument. Industry too produces sometimes those combinations of functional forthrightness and frank use of an obviously contemporaneous formal vocabulary, which gives them a possibly fortuitous but none the less genuine architectural significance. In the latter class are the great grain silos, dock works and warehouses that the historians of modern architecture have taught us to admire. In the former class the outstanding example in England is still the Boots factory at Beeston, designed by Sir Owen Williams in 1932. If not quite of the same architectural distinction—it has not the same elegance or formal interest—as the celebrated Van Nelle factory in Rotterdam, it has not been sur-

passed in this country as an architectural expression of industry in modern activity. Sir Owen Williams is an engineer, and is celebrated also as an innovator in reinforced concrete structure, but he has done work for which he has been, in effect, the architect whose influence towards directness of purpose and honest use of structure has been considerable amongst the contemporary architects who have been willing to learn.

Our fifth and last category is that of private patronage. It is probably true of all cultures that they are initially fostered by private individuals. A new culture enters the country through the minds of the intelligentsia, and active cooperation between these and the pioneer architects produces the first manifestations of a new way of thought. The private individual can afford to experiment as he is responsible for the result only to himself: in the economic sense he can afford to experiment as, in the type of building he is in a position to commission—usually the small house or the interior equipment of a flat—no great expenditure, relatively, is involved. But this kind of patronage, invaluable though it is, and essential while the experimental stage is in progress, has its dangers to the successful transition of an awakening into a culture. The intelligentsia, by virtue of their very characteristic of awareness in advance of their times, are “cranks”: they are not the nation but the sensitive antennae on the forehead of the nation. And a time in the development of a culture soon comes when the patronage of the intelligentsia is enervating rather than inspiring; when the architect must break free from his dependence on intellectual awareness and seek for response to his vision in a national feeling which the inevitability of his expression must gradually arouse. Patronage, that is to say, must move from the conscious to the unconscious.

In England it is approximately this position that modern architecture has reached. English architecture owes much to the private patron whose country villas and urban flats form the bulk of our uncompromisingly modern examples. What is known as the International Style owes its introduction into this country to their interest. But, to consider only the most practical reasons, modern architects must obtain experience of architecture in a wider public sense; the small house is not a relevant problem—the problems it sets give the architect no opportunity to demonstrate his peculiar aptitude for facing all the new challenges contemporary life presents; finally, a significant culture, as we have already suggested, must permeate the population as a live anonymous tradition. The present transitional stage between the hothouse or nursery period and the mature or unselfconscious period is one of the most vital ones that English architecture has passed through. The English architect can afford, if nothing more, to be optimistic. The future depends upon the relationship between himself and the widening circle of his patronage.

modern english examples

1. MUNICIPAL





2

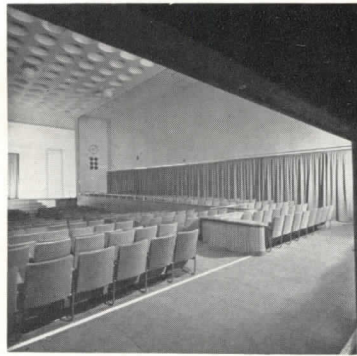

3

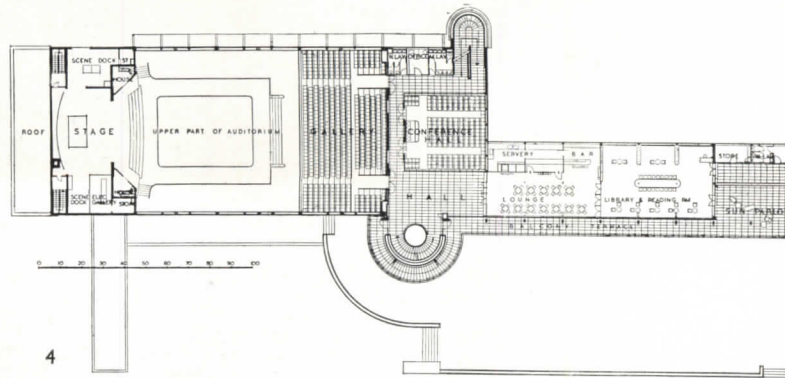

4

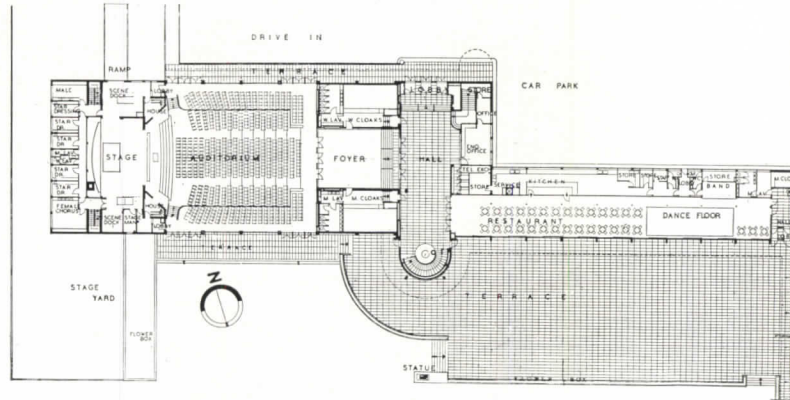

5

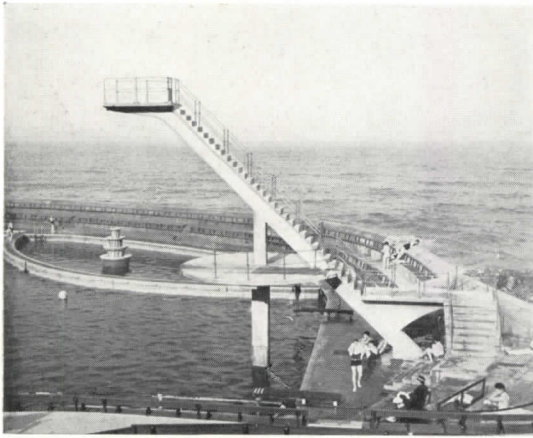

7

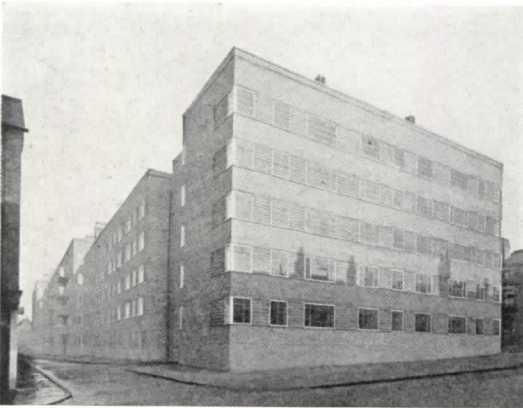

8



6

The Entertainments Pavilion at Bexhill, a seaside resort on the South Coast (Mendelsohn & Chermayeff, architects), is the most important modern building in the country erected under municipal patronage: indeed, displaying as it does, perhaps for the first time on an important scale, the essential modern characteristics of structural precision and exactness of finish, hitherto rare in this country. As explained in the foregoing introduction, official or municipal encouragement of architecture of a modern kind is rare: this pavilion is the result of an exceptionally well-organized open competition, won jointly by Serge Chermayeff, one of the leading modernists practicing in England, and Erich Mendelsohn, the celebrated German modernist. The competition scheme included a swimming

pool, yet to be built. The building, completed in 1935, has a welded steel frame and is finished in a cream-colored rendering. 1 (overleaf), The road front, showing staircase hung from its own cantilevered roof. 2, The sea front with sun decks. 3, The interior of the large theater or concert hall. 4 and 5, First and ground floor plans. 6, A detail of the large spiral staircase, glass-enclosed, on the sea front. Other seaside municipalities, in minor ways, have shown some architectural enterprise. 7, The diving tower of the swimming pool at Scarborough (designed by J. Paton Watson, the borough architect). 8, An example of working-class housing at Liverpool (L. H. Keay, Director of Housing, architect). Structural supports are outside, making possible a continuous curtain wall.

modern english examples
2. PUBLIC SERVICES

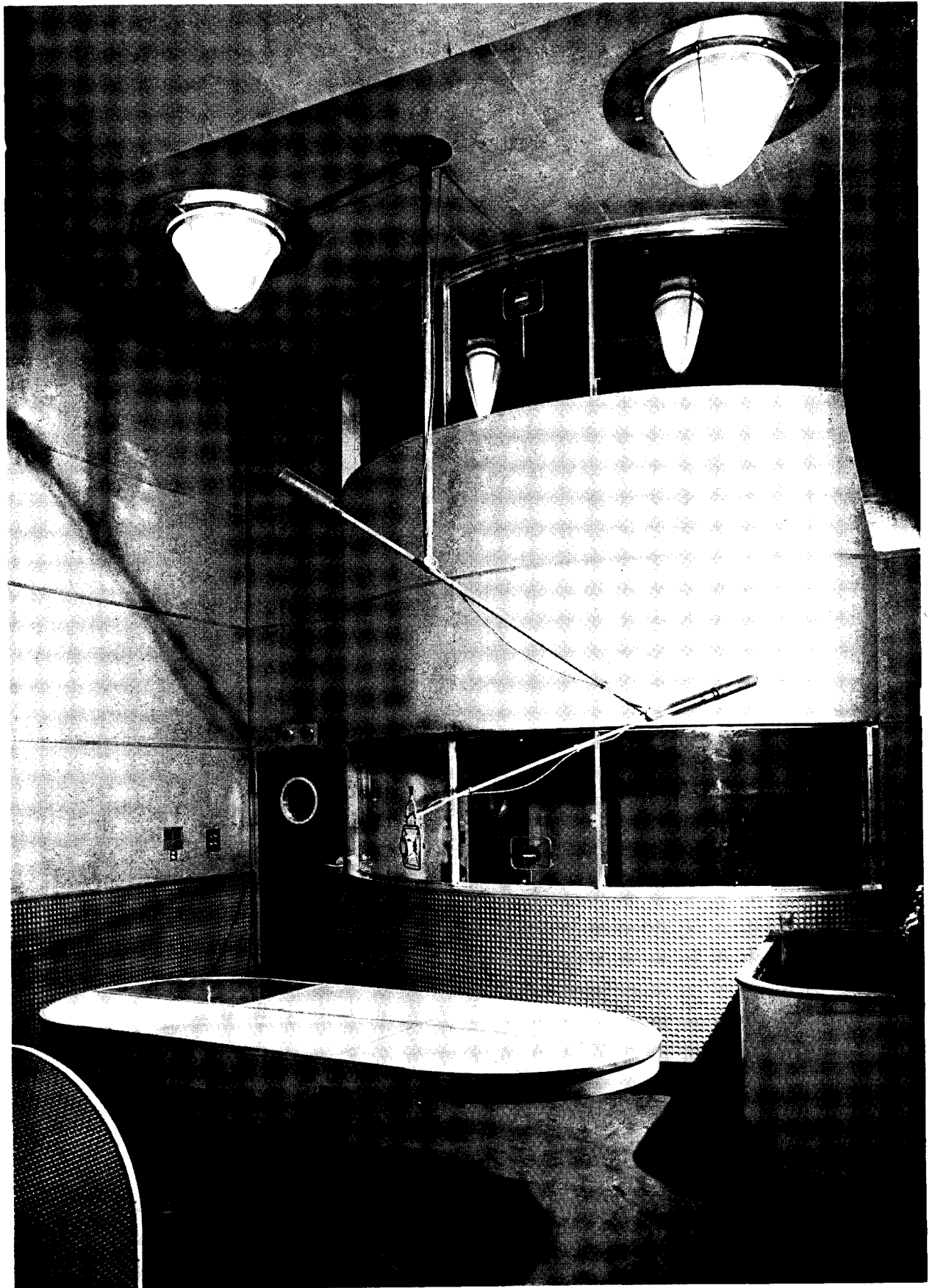

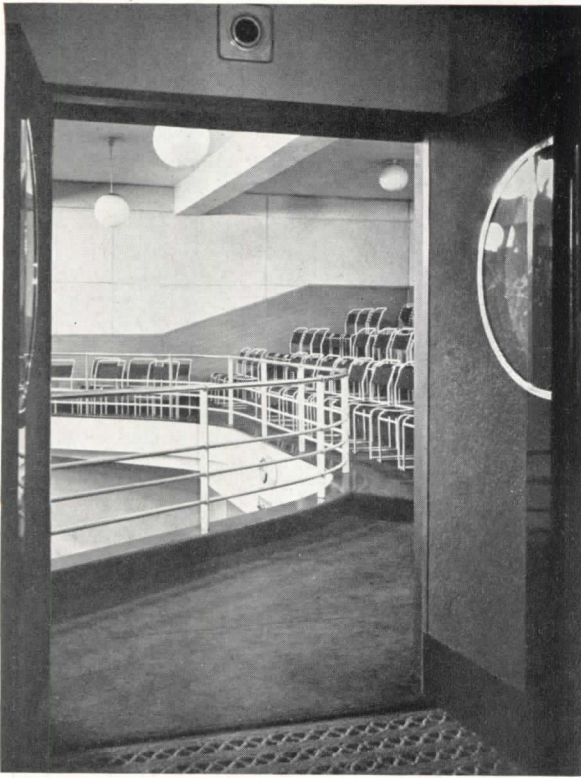

10



12

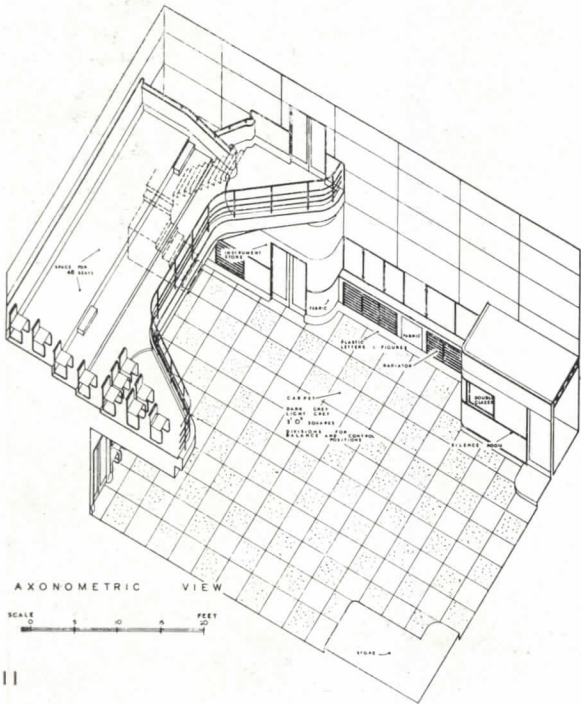

11



13

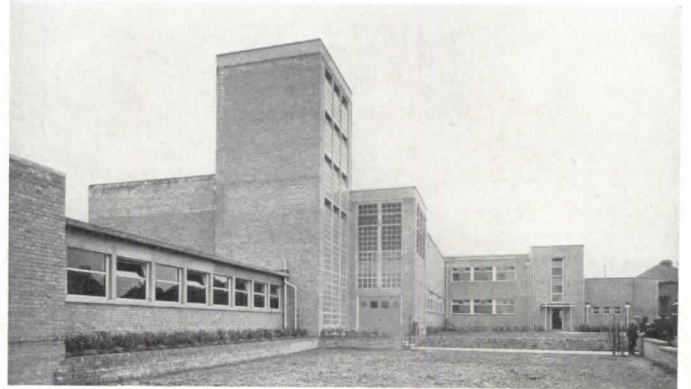

14

The British Broadcasting Corporation gave an impetus to the employment of modern architects as interior designers in 1932 by handing over the interior design of their London headquarters to a team of young modern men including Raymond McGrath, Wells Coates and Serge Chermayeff. 9 (overleaf), One of the Dramatic Effects studios in Broadcasting House, London (Wells Coates, architect). The furniture is in laminated wood and the walls and ceilings packed with 2 inches of Rock wool and covered with fabric. In their subsequent buildings in the Provinces, the B. B. C. have employed the same designers or ones with similar ideas. 10 and 11, The principal studio in Broadcasting House, Manchester (Raymond McGrath, architect, 1935). 12, The Listening and Gramophone room, Broad-

casting House, Birmingham (Serge Chermayeff, architect, 1934). The furniture is in Honduras mahogany, waxed. Railway architecture (except for the London Underground Railways) has produced little of a modern kind that is notable. But here, 13, is a large grain and general warehouse just completed for the Southern Railway at Nine Elms, beside the Thames on the edge of London (designed by Oscar Faber, a prominent engineer who, like Sir Owen Williams, has been responsible for some important architectural work). The building has a reinforced concrete frame with panel in-filling of brick. Reference has been made in the preceding article to the series of pithead baths erected by the Miners' Welfare Committee. 14, Pithead baths and canteen at Betteshanger Colliery (C. G. Kemp,

e x a m p l e s

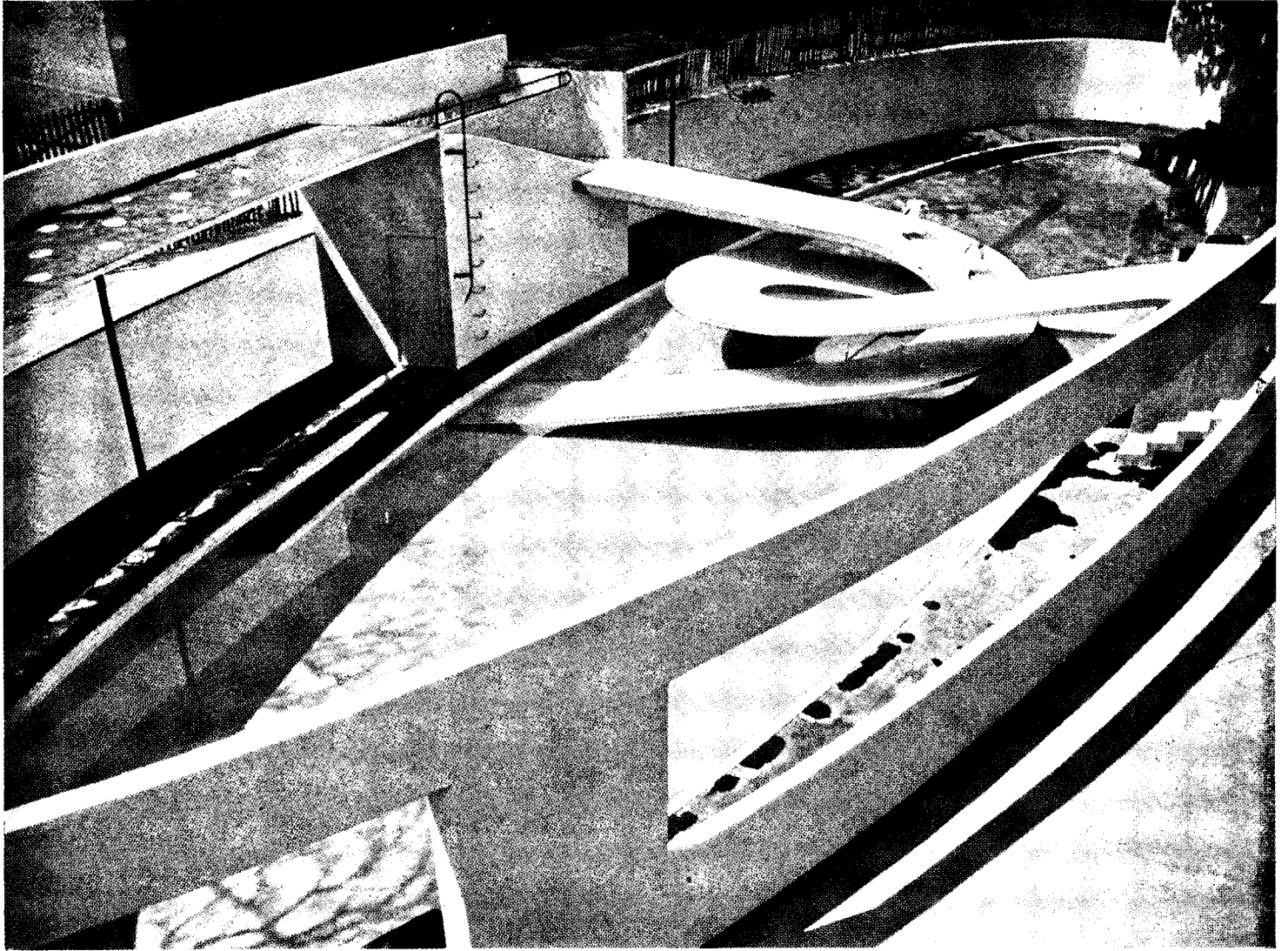

15

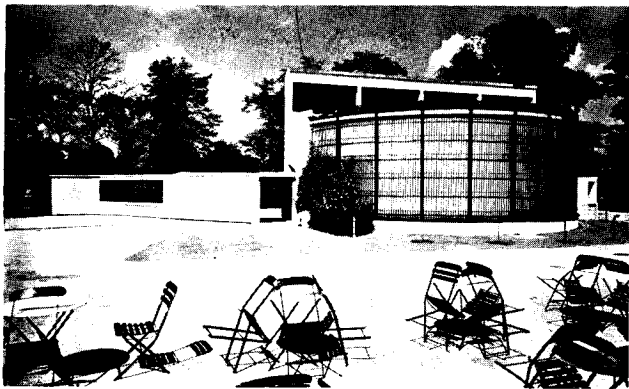

16

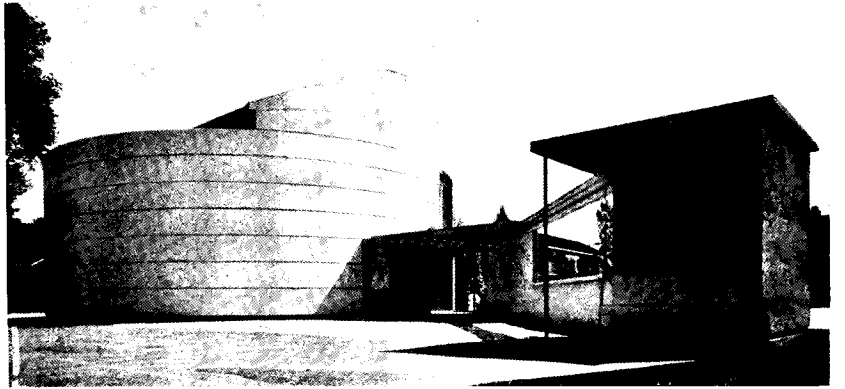

17

architect, 1934). A great deal of interest has been caused by the work done for the Royal Zoological Society, at their London Zoological Gardens and at their Zoological Park at Whippsnade, by Lubetkin, the Russian architect who works in England, and the group of young architects who have organized themselves to work under him, the whole Group being known as "Tecton." The plastic imagination shown by this work, which is mostly carried out in reinforced concrete with the collaboration of the Danish Engineer Ove Arup, has introduced quite a new element into modern English architecture. The Penguin Pool, 15, built in 1934, shows this imaginative use of structural form most clearly, and shows also a certain affinity with constructivist art,

with the continental exponents of which, after the war, Lubetkin was associated. The Penguin Pool is designed to display the peculiarities and characteristics of the birds both in and out of the water. The Gorilla House, 16 and 17, is also in the London Zoo. Completed by Lubetkin and Tecton in 1933, it is notable as a movable structure: one half of the circular drum forming the cage revolves. In winter it forms a public hall (so that the cage itself is only a semicircle in extent) and in summer or on fine winter days it disappears behind the permanent cage, leaving only a skeleton of bars which form an open-air cage for the gorillas. This building is in reinforced concrete and steel.

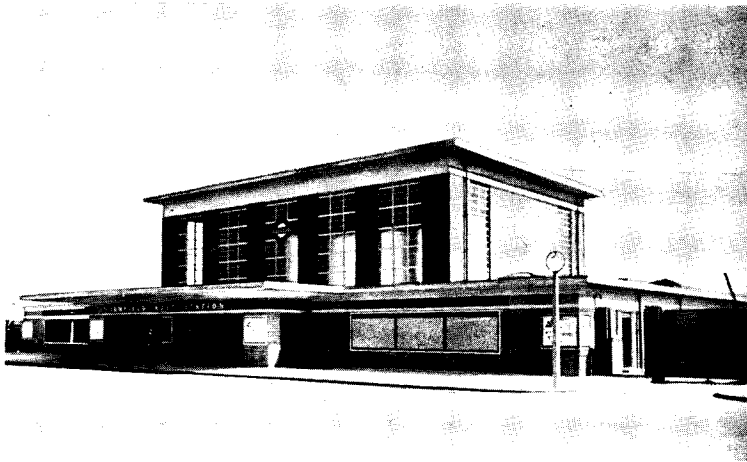

18



19

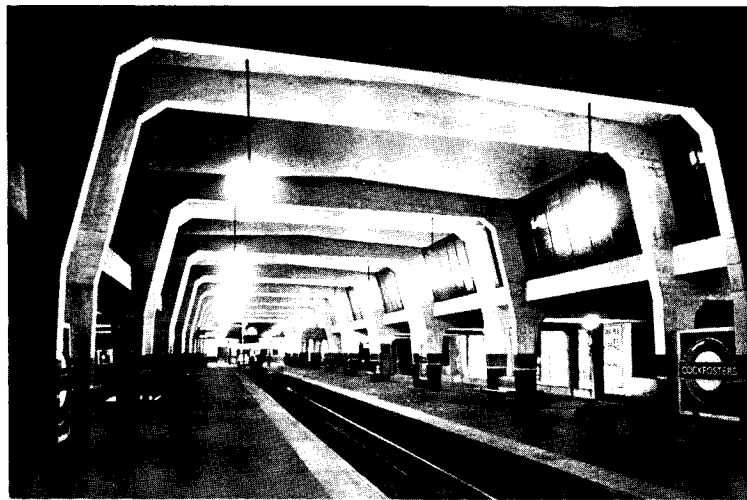

20

So far as appreciation of modern design by the man in the street is concerned (as distinct from understanding by the architect who should produce it), the greatest single influence of recent years has been that of the London Underground Railways. They largely fostered the revival of poster art in England, their standardized lettering and carefully designed signs, etc., have been an example of consistent good taste and dignity. Their stations, though traditional in the sense that they maintain a Georgian scale, display the modern virtues of straightforward nonmonumental planning and of restraint. 18

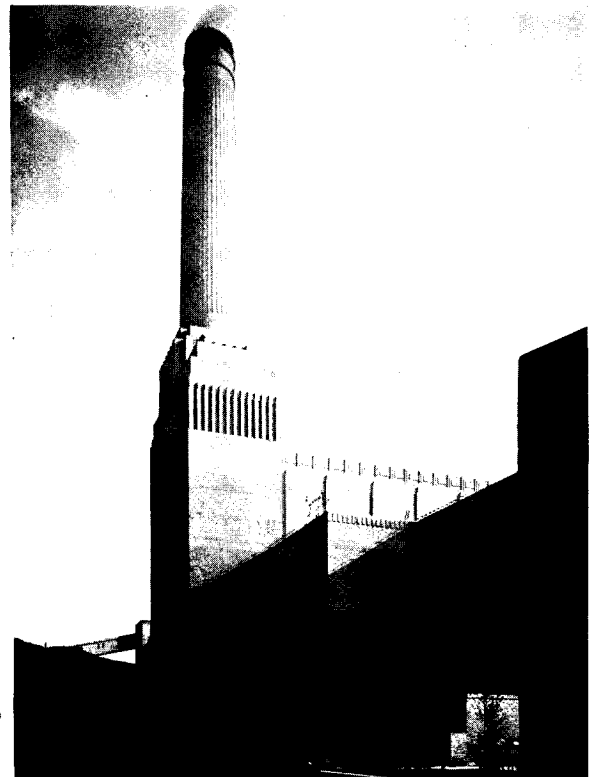

21

21

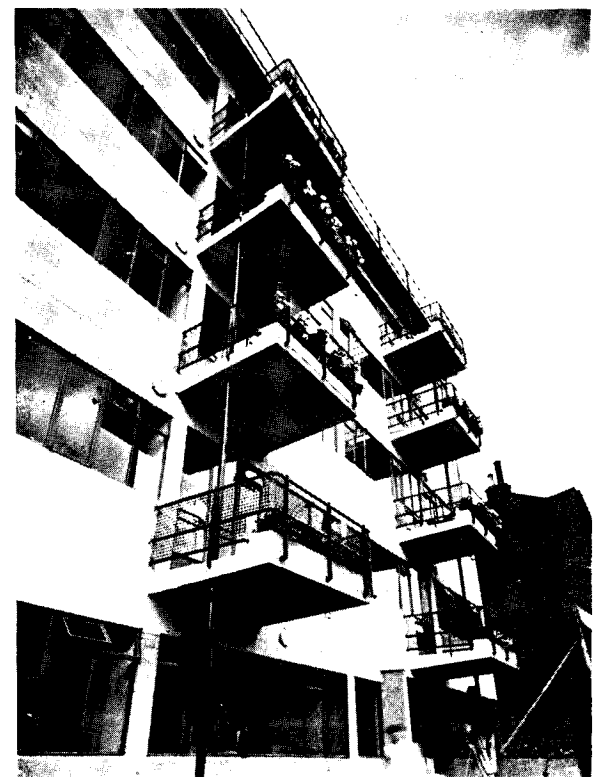

22

and 19, Enfield West Underground Station (Adams, Holden and Pearson and C. H. James, architects, 1933); the exterior and the booking hall. 20, Cockfosters Underground Station (Adams, Holden and Pearson, architects, 1934), the platforms. 21, Battersea Power Station, London, completed in 1934. (Dr. S. L. Pearse, engineer; Sir Giles Scott, consulting architect for the exterior). 22, Kent House, London, working-class flats in reinforced concrete forming part of a slum-clearance and rehousing scheme sponsored by the St. Pancras House Improvement Society (Connell, Ward and Lucas, architects, 1935).

modern english examples
3. COMMUNITY

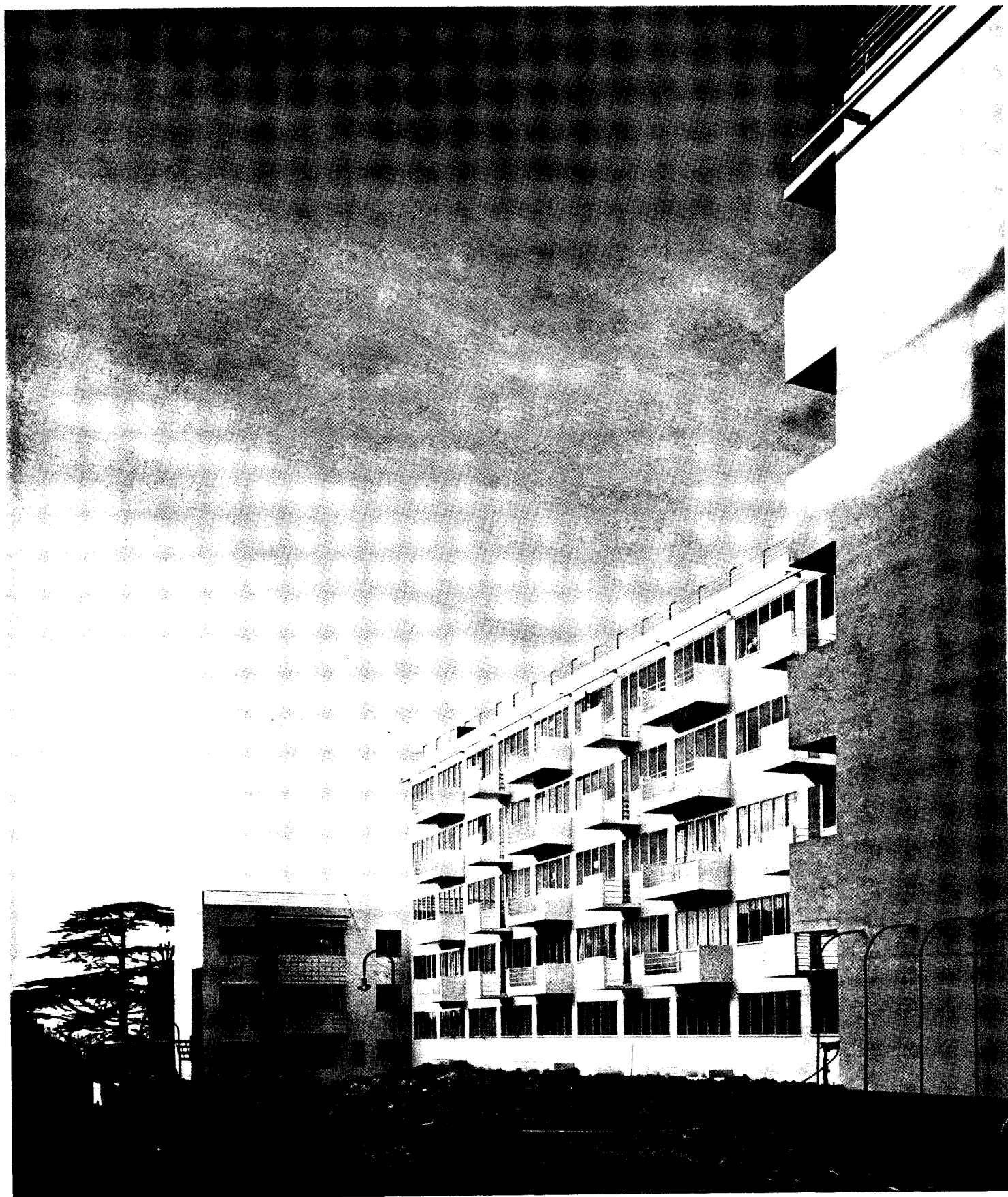



24



25

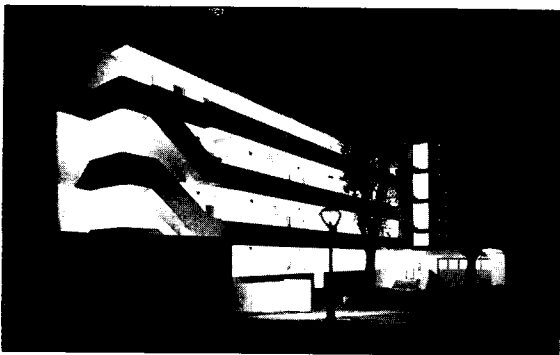

26

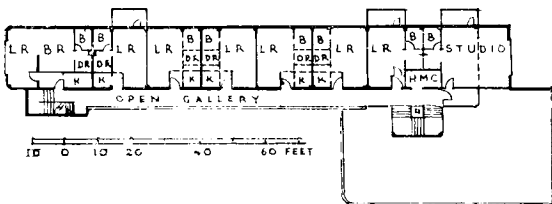

27

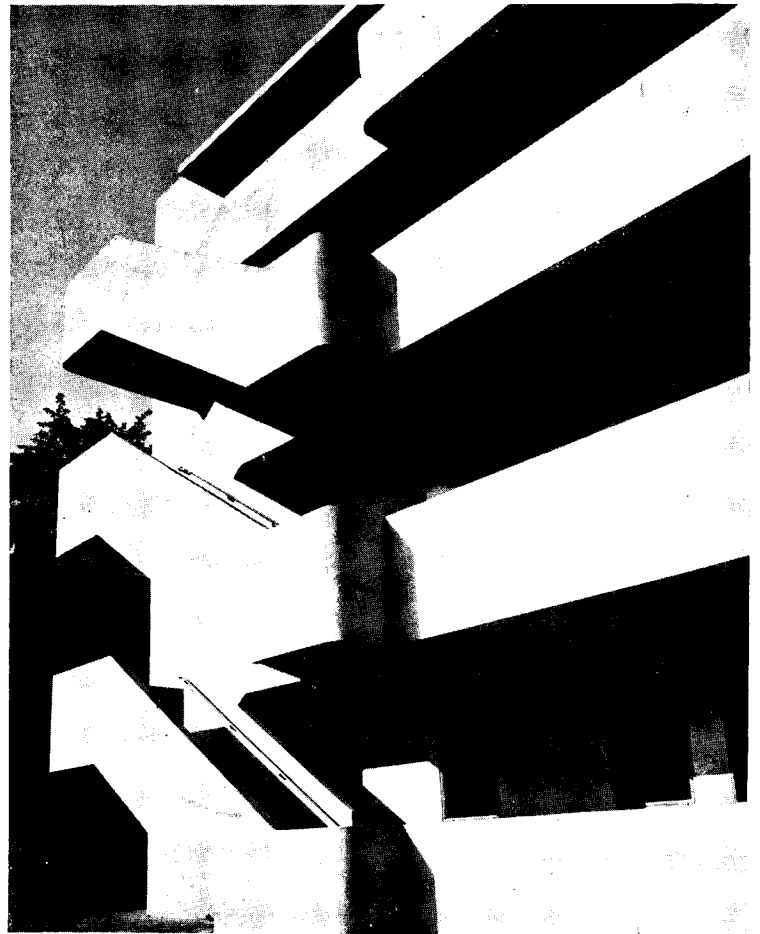

28

23 (overleaf), 24 and 25, A housing group in reinforced concrete at Streatham, a suburb of London (Frederick Gibberd, architect, 1935). The flats, for small middle-class incomes, are grouped in blocks of progressively increasing height as they set back from the road. The tall rear block overlooks a permanent open space behind. A large proportion of the accommodation consists of economical one-room flats (with kitchen and

bathroom) for single persons. There is a swimming pool in the forecourt. 26, 27 and 28, General view at night, typical floor plan and a detail of the access balconies at Lawn Road Flats, Hampstead (Wells Coates, architect, 1934). This building is also in reinforced concrete and the accommodation it provides is also chiefly one-room flats. Probably the most notable modern block of flats is Highpoint, a ten-story building in

e x a m p l e s

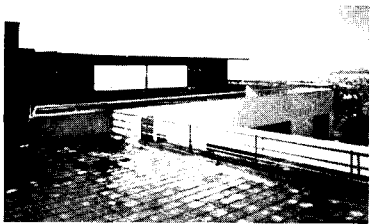

29



30



31



32



33

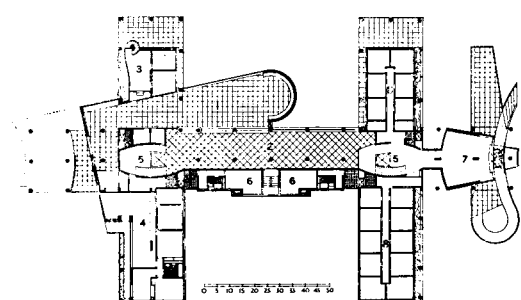

34

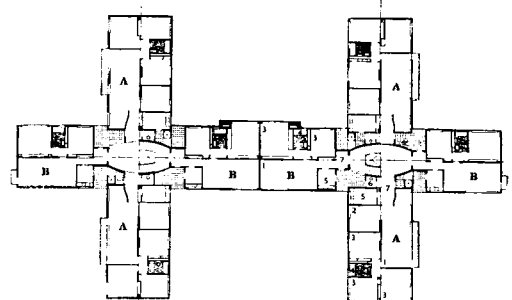

35

UPPER FLOOR: 1, Living room. 2, Dining recess. 3, Bedrooms. 4, Bathroom. 5, Kitchen. 6, Toilet. 7, Entrance hall.

GROUND FLOOR: 1, Hall and winter garden. 2, Hall. 3, Porter's flat. 4, Large flat. 5, Lifts and staircases. 6, One-room flats. 7, Tearoom. 8, Maids' bedrooms.

Highgate, standing on the highest ground in London. The architects were Lubetkin and the Tecton Group, who have already been referred to in connection with their Zoological work. The building, which was completed at the end of 1935 (also in reinforced concrete), has an interesting plan. It takes the form of a double cross, each arm containing one flat only, so there are practically no party walls between flats (and there-

fore no transmission of sound between adjacent flats); also there are plenty of opportunities for cross ventilation. The upper floor plans, 35, are standardized; the ground floor plan, 34, has a large entrance hall, 30 and 31, independent of the main structure which is supported at the ground floor on columns only. The roof, 29, serves as a communal recreation ground. 33, A general view from garden side.

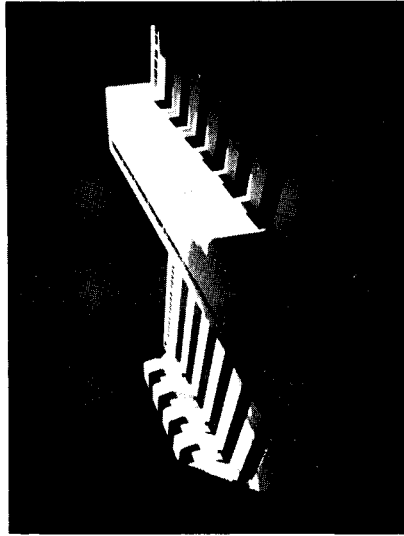

37

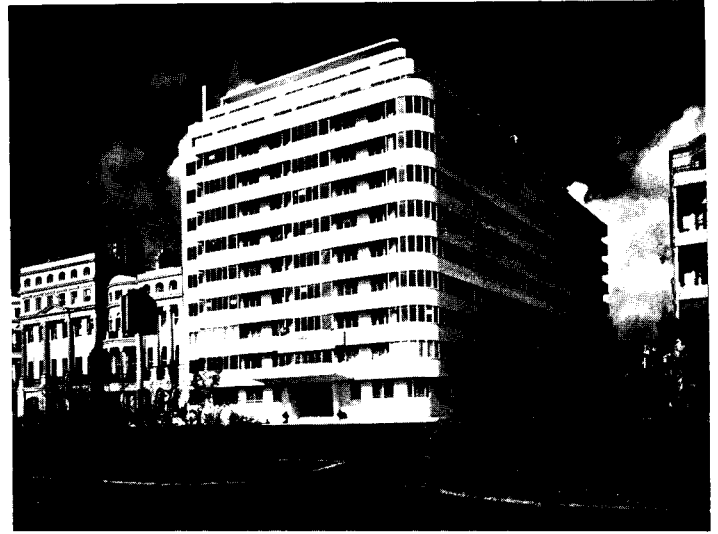

38

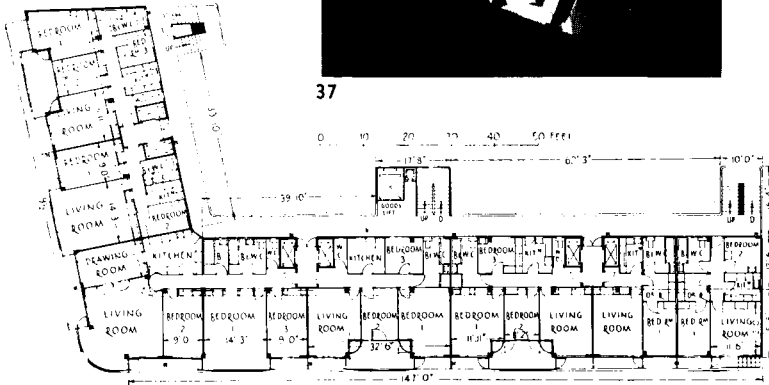

36

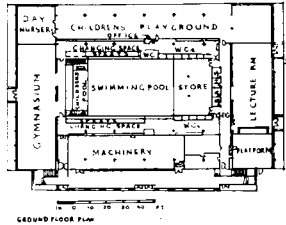

40

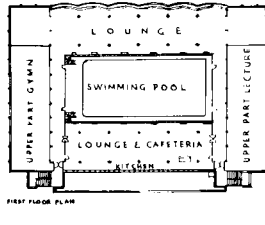

41

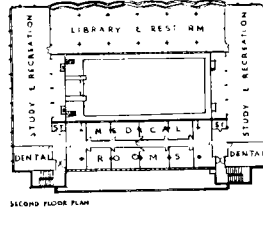

42

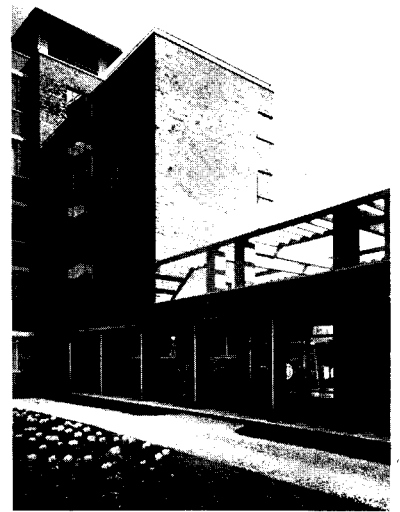

39



43



44

36, 37 and 38, Embassy Court, a block of luxury flats on the sea front at Brighton (Wells Coates, architect, 1935). 36, A typical upper floor plan. 37, The service galleries and escape stair at the rear. 39, Middle-class flats at Putney, near London, in brick, (Frank Scarlett, architect, 1936). 40-44, The Pioneer Health Center, Peckham, London, completed in 1935;

an interesting social experiment initiated partly for humanitarian and partly for research purposes by two doctors. It combines the functions of a medical and dietetical research bureau, a social and athletic neighborhood club, and a welfare clinic. The central feature of the plan is an inclosed swimming pool, visible through glass screens from the public and recrea-

e x a m p l e s

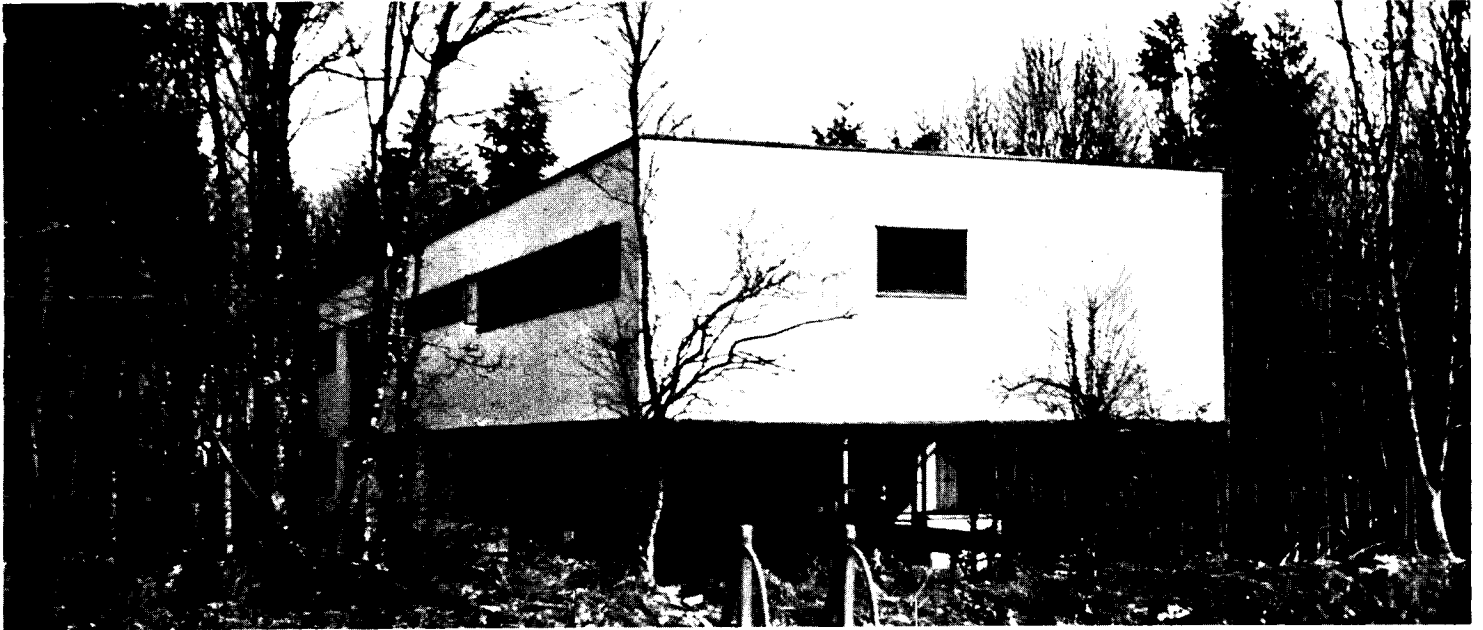

45

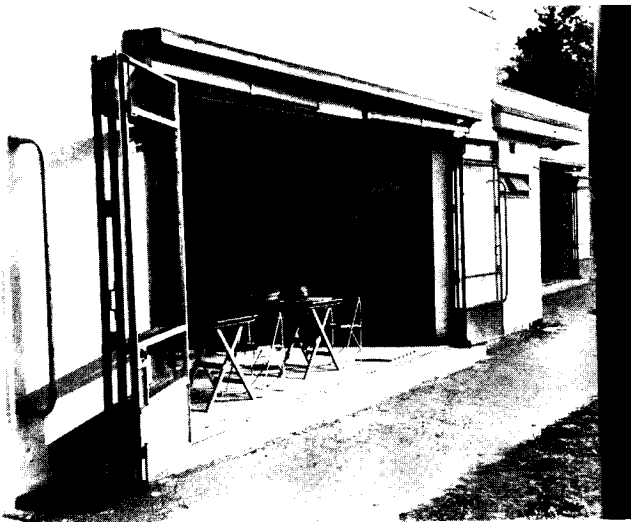

46



47

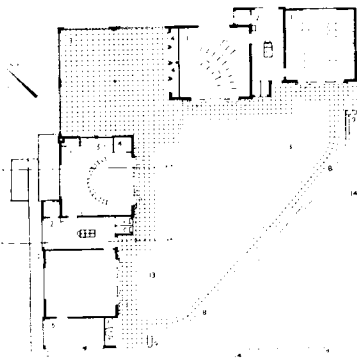

48

KEY: 1, Classroom. 2, Cloakroom. 3, Open covered playhall. 4, Cupboard. 5, Classroom stage. 6, Workshop. 7, Rabbit hutches. 8, Flower box with concrete table. 9, Bird bath. 12, Access ramp. 13, Grass-covered forecourt. 14, Playing field.



49

tion rooms. The designer was Sir Owen Williams, actually a reinforced concrete engineer. His work and influence is referred to in the preceding article. 45, One of the new school buildings designed in 1933 by the American architect William Lescaze, for Dartington School, an "advanced" educational center recently established at Totnes, in Devonshire.

46, 47 and 48, A small one-story building forming the new Junior School at the old-established King Alfred School, Hampstead. The building is specially designed for easy transference of the classes to the open air in fine weather (E. C. Kaufmann, architect, 1936). 49, Zoological Laboratories at Cambridge (Stanley Hall, Easton and Robertson, architects, 1934).

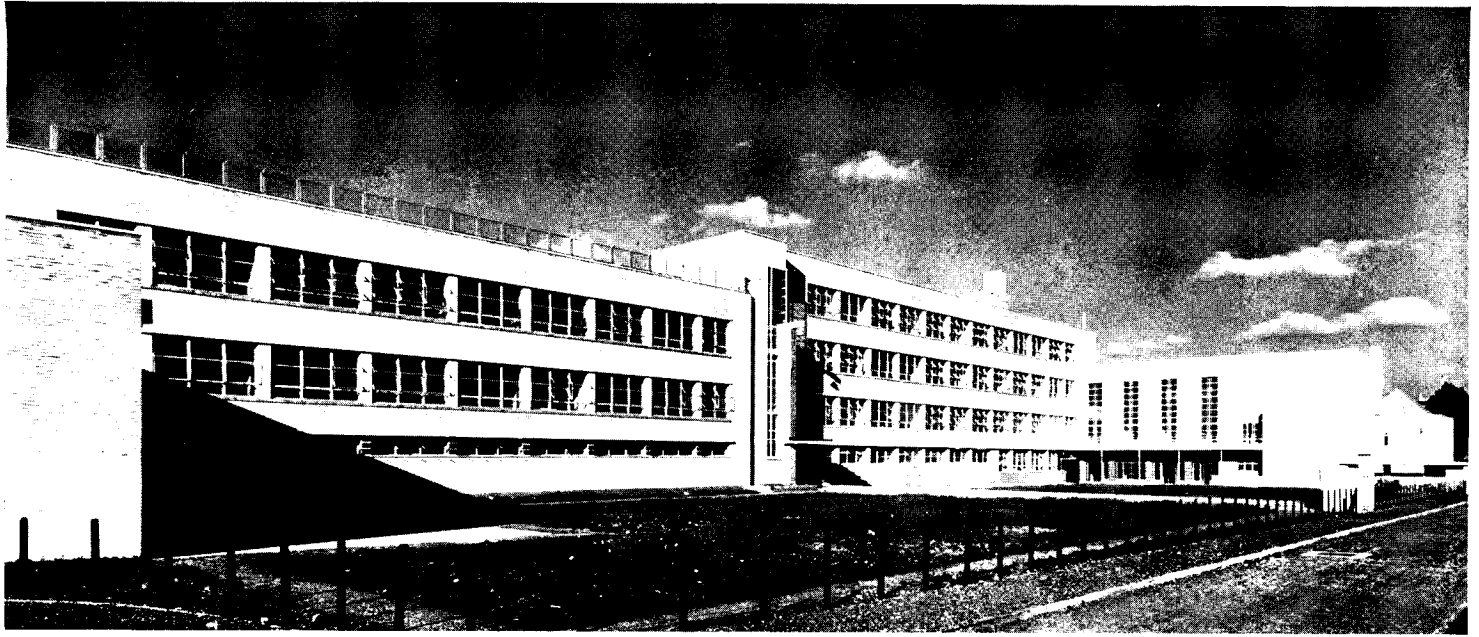

50

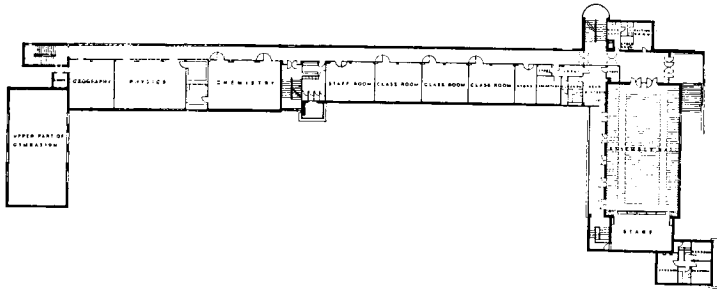

52

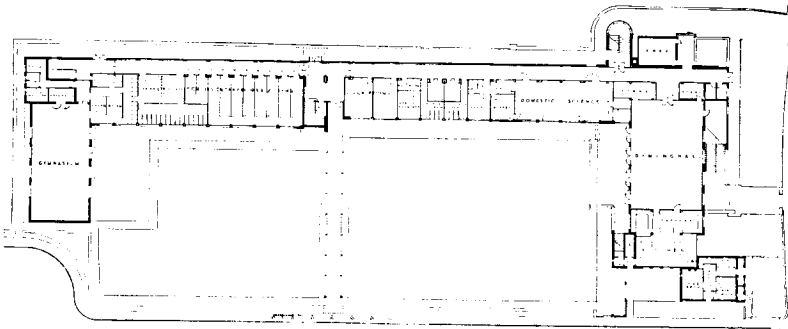

53

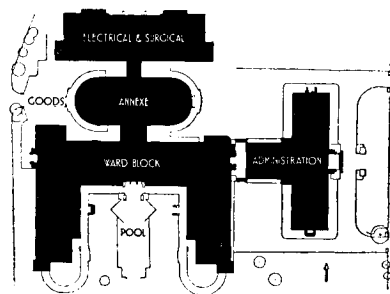

54

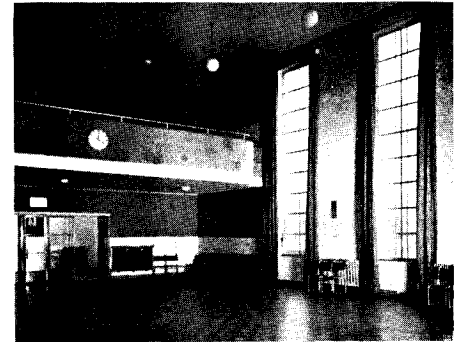

51

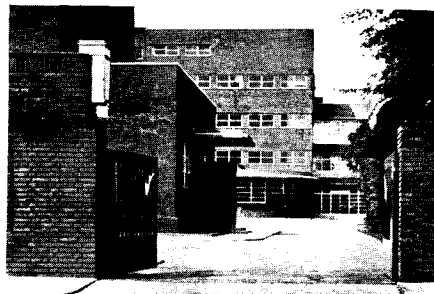

55

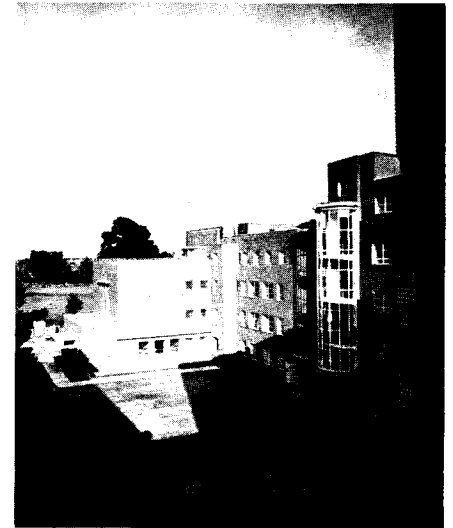

56

50, The exterior of the Burlington School for Girls, Hammer-smith, London (Sir John Burnet, Tait and Lorne, architects, 1936); the rebuilding of an old school of nonresidential "secondary" type. Construction is in steel and brick. The site is an open one on two sides, overlooking playgrounds. 52 and 53, First and ground floor plans. Two other stories contain classrooms and laboratories. 51, The assembly hall. 54, 55, 56,

A large hospital at Ravenscourt Park, London, built in 1933 by the same architects. As shown by the block plan, 54, it consists of several isolated blocks, ward block, administration block, service and operating block, and nurses' home, linked together by covering ways. 55, A view from the entrance, showing the side of the administration building. 56, A rear elevation showing the staircase of the ward block. This was notable for being

e x a m p l e s

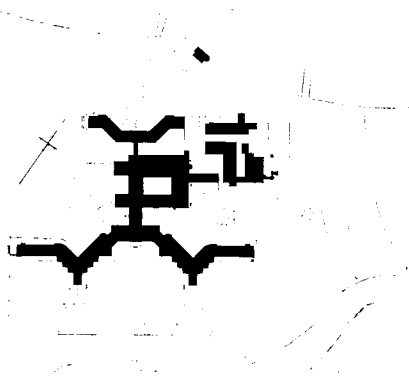

57



58



59



60

the first large building in England to use welded steelwork. 57 and 58, The Sully Tuberculosis Hospital in South Wales (Pite, Son and Fairweather, architects, 1936), with a similar type of unit planning. 59 and 60, The two most important London shops, both completed in 1936. 59, Simpson's men's store in Piccadilly (Joseph Emberton, architect). The exterior is specially designed for nocturnal floodlighting. Simpson's store

was one of the first buildings in London where electric welding was extensively used for complicated parts of the steel frame. 60, Peter Jones' department store, Sloane Square (Slater and Moberly and William Crabtree, architects; Professor C. H. Reilly, consulting architect). The structure is steel frame and the exterior is faced with panels of sheet glass divided by pressed aluminum strips.

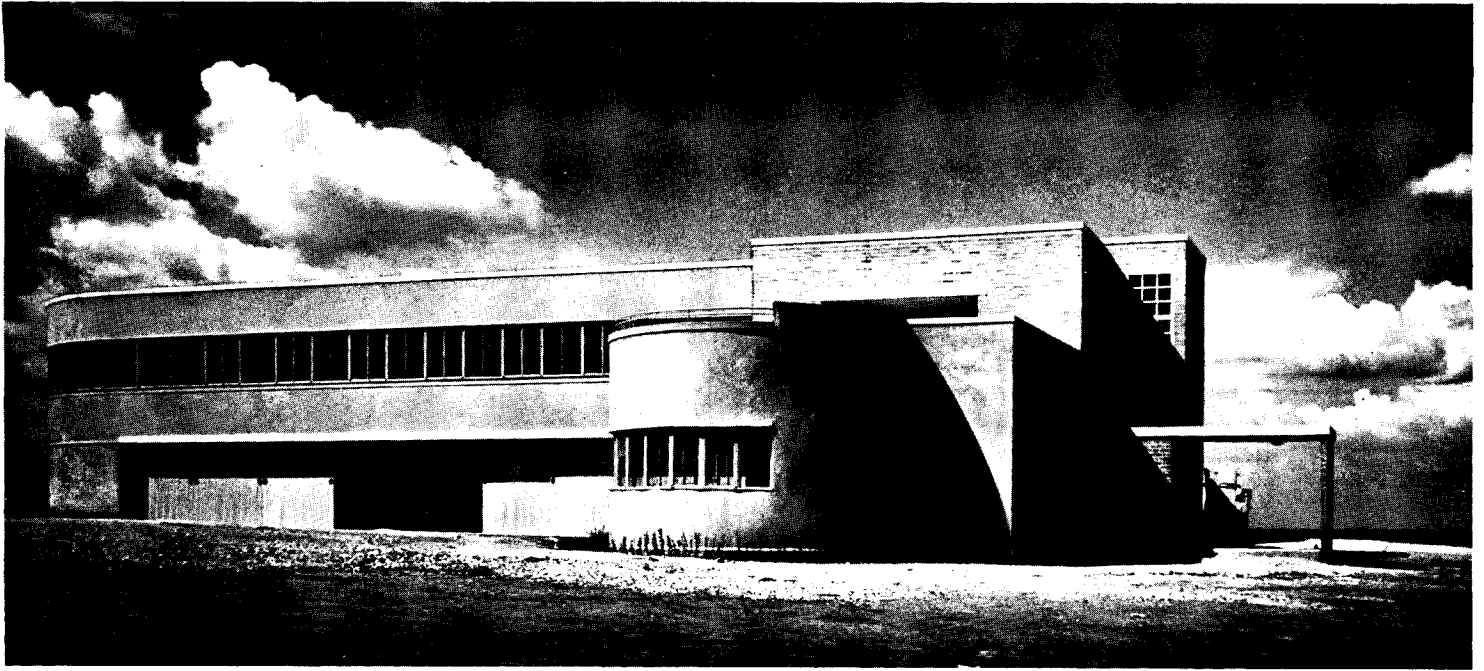

61

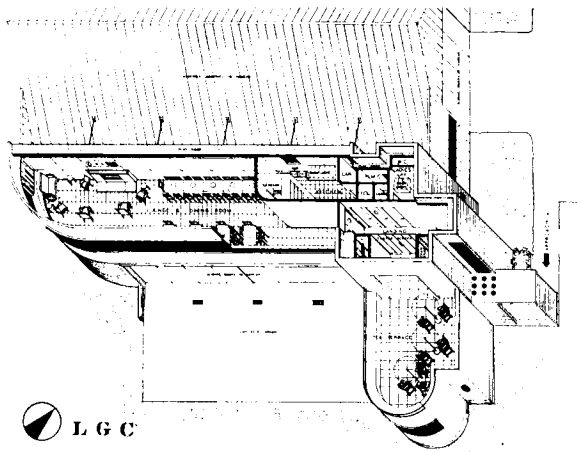

62

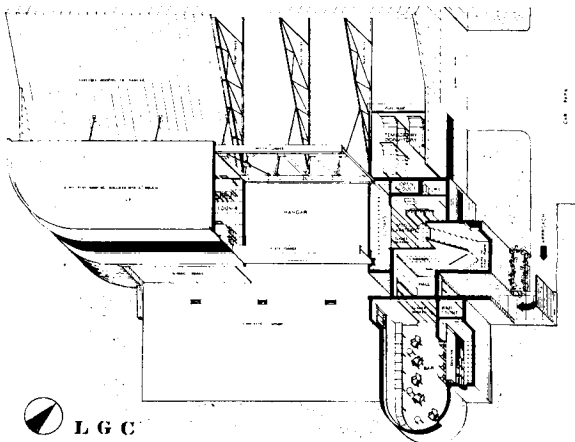

63

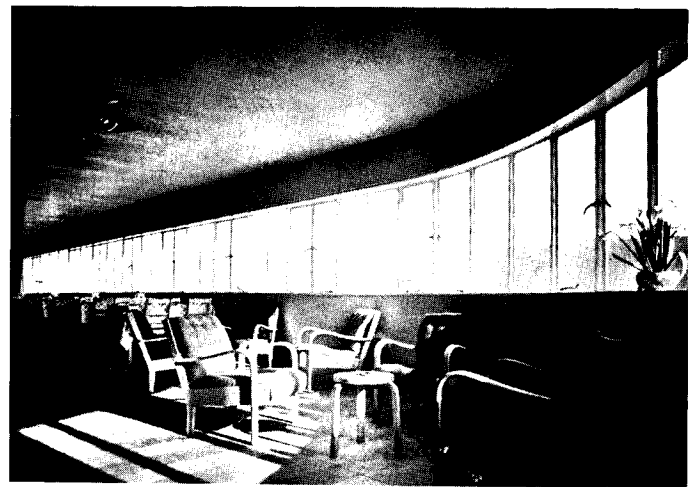

64

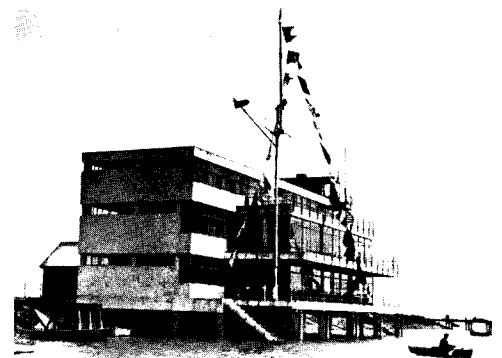

65

61, The London Gliding Club (Christopher Nicholson, architect, 1936), headquarters of gliding or sailplane flying in England, occupies a position below the chalk downs near Dunstable, the hills being used for launching the sailplanes. The building consists of a large hangar housing 25 machines, and the club quarters which include a long restaurant, 64, built over the main hangar door and a small amount of sleeping accommodation.

The drawings, 62 and 63, show the planning and the method of construction: a light steel frame on a brick base, the former covered with rendering on expanded metal, insulated with wall-board. 65, The Royal Corinthian Yacht Club, Burnham-on-Crouch (Joseph Emberton, architect, 1932); a reinforced concrete building with spacious balconies from which the sailing in the river can be viewed.

modern english examples
4. INDUSTRIAL

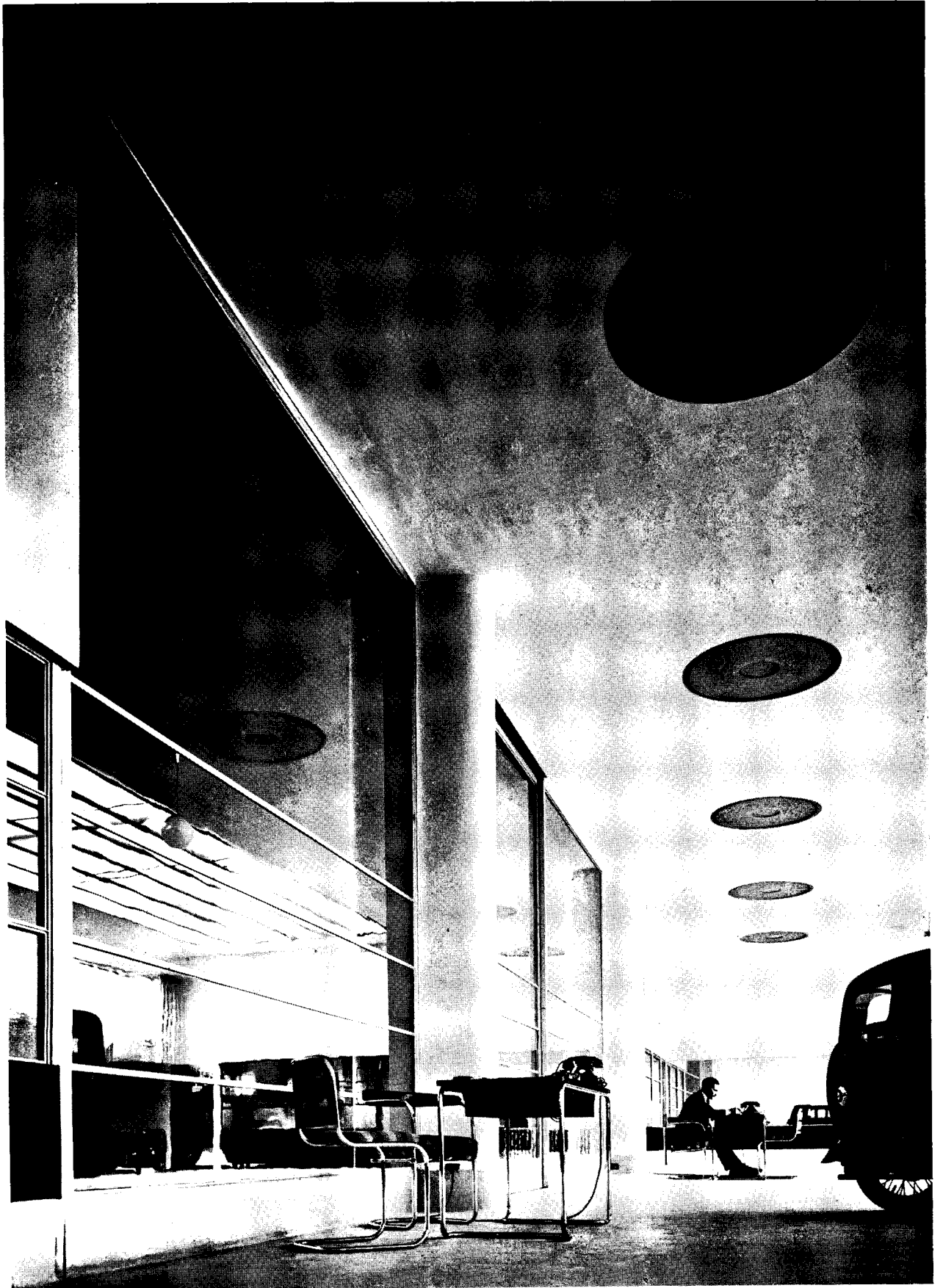

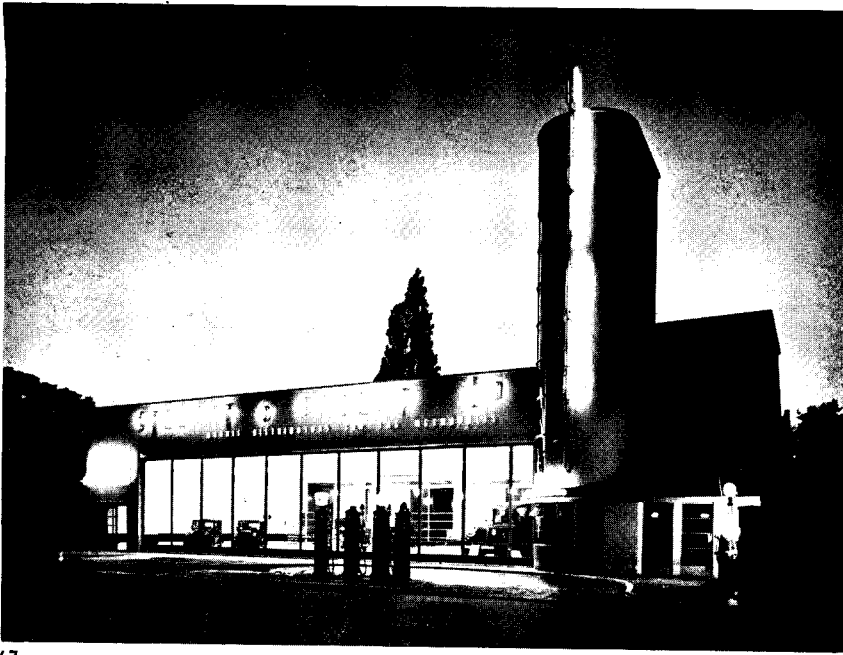

67

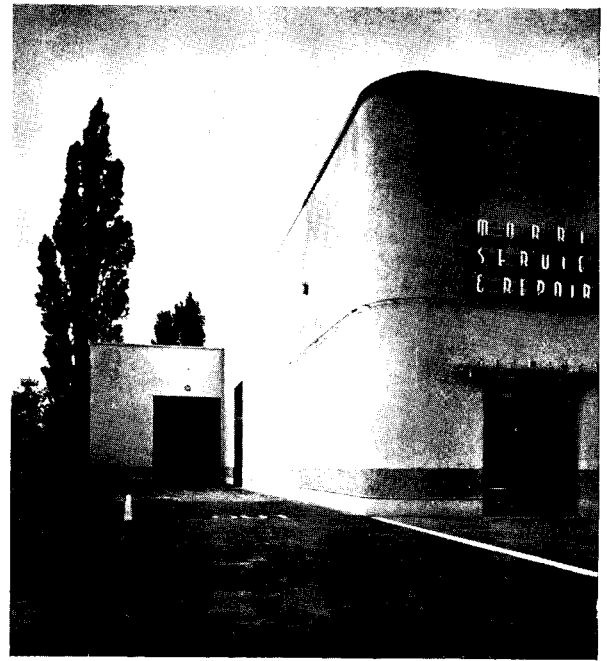

68

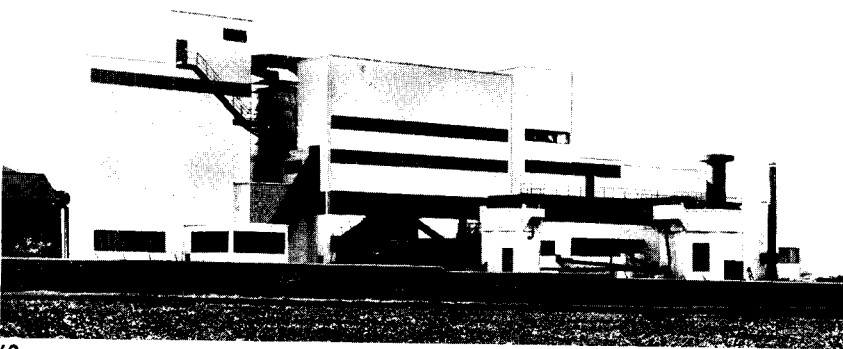

69

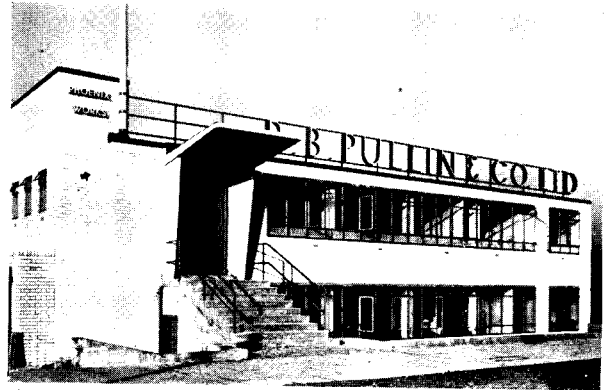

70

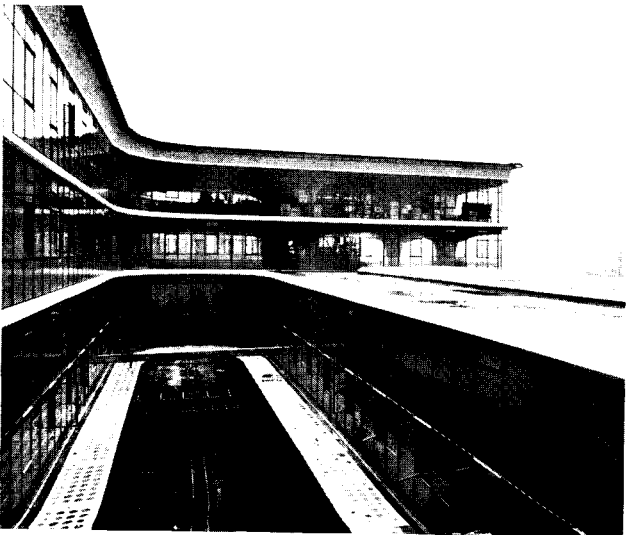

71

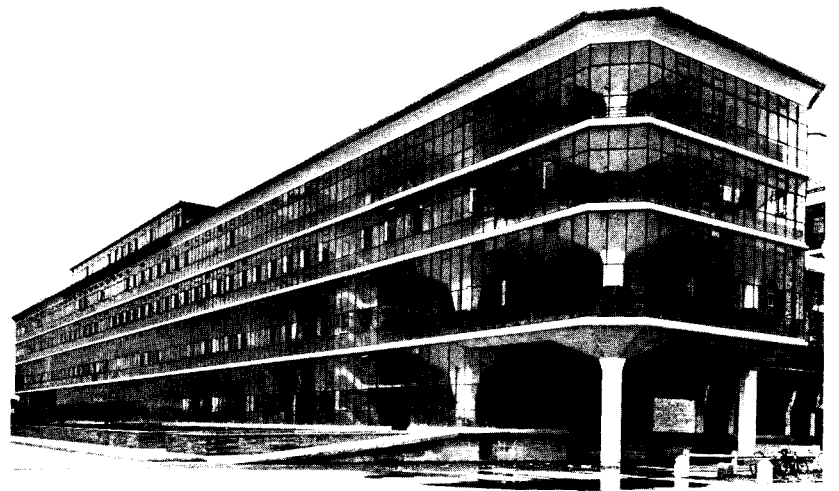

72

Though classified as industrial buildings, the series of combined service stations and motor-car display rooms recently built for the Morris Company are exceptions in this class in that their modernity has a public display value: they are not hidden and purely utilitarian, as are most private industrial buildings. 66 (overleaf), The showroom; 67 and 68, exteriors of the Morris Service station at Staines (Cameron Kirby, architect, 1934).

The building is in steel frame and rendered brickwork. 69, Coal-cleaning plant at the Rising Sun Colliery, Wallsend (R. A. Cordinley, architect, 1936). 70, A small factory near London (Percy Tubbs, Son and Duncan, architects, 1936). But still the most distinguished factory building in England, though it was completed (by Sir Owen Williams) in 1931, is the large concrete and glass monument at Beeston, 71 and 72.

modern english examples

5. PRIVATE

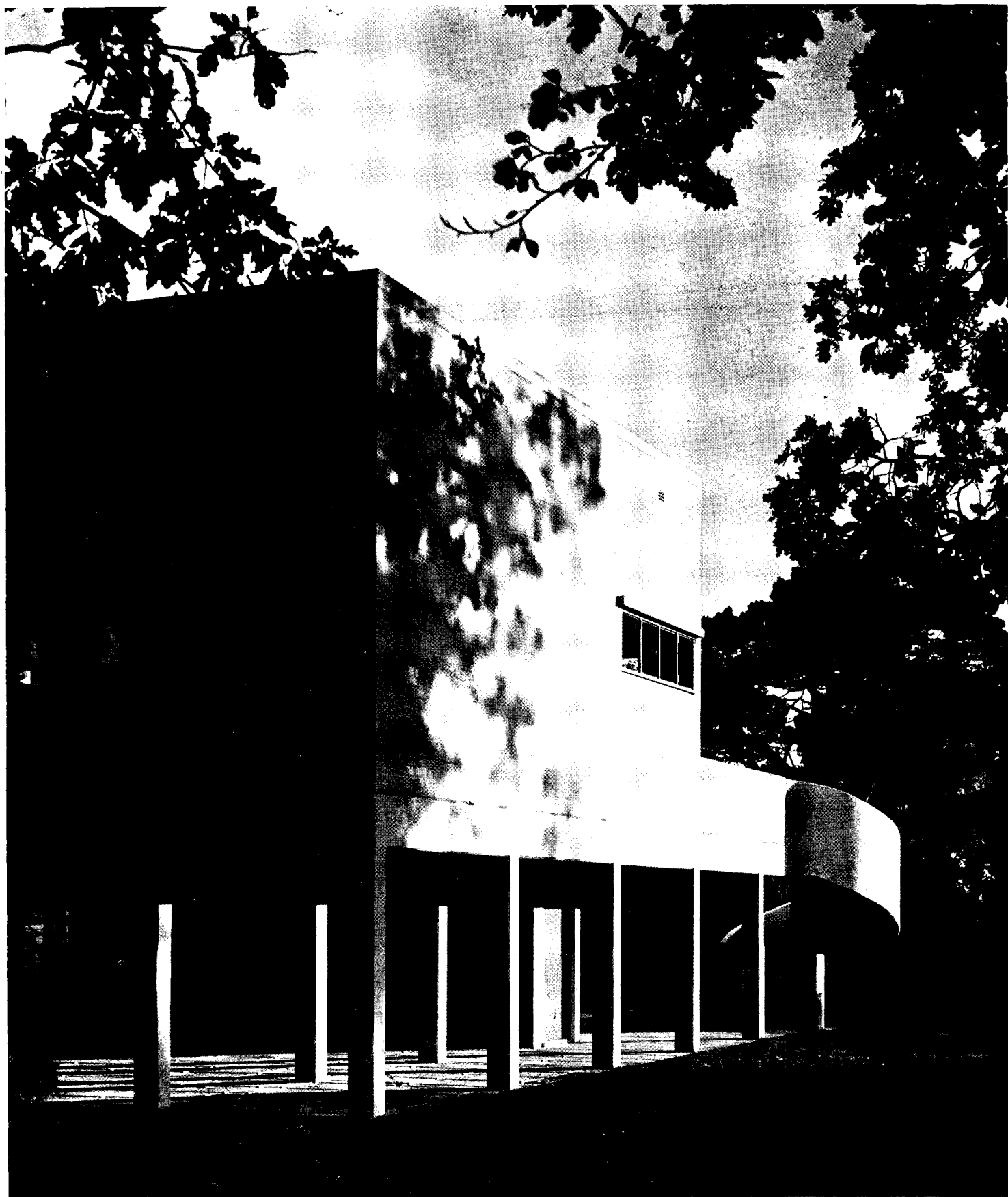

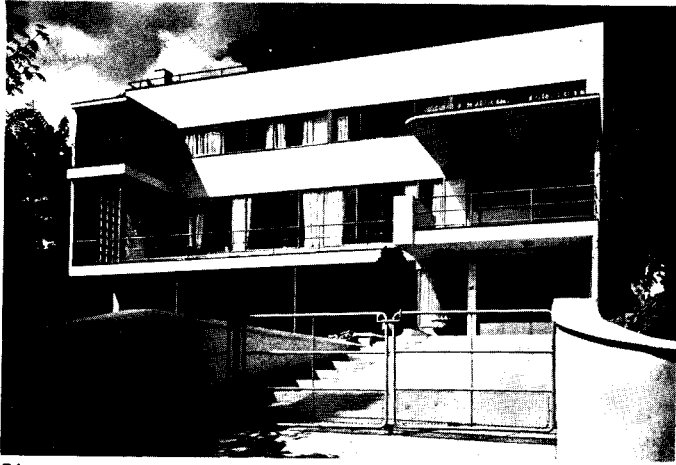

74

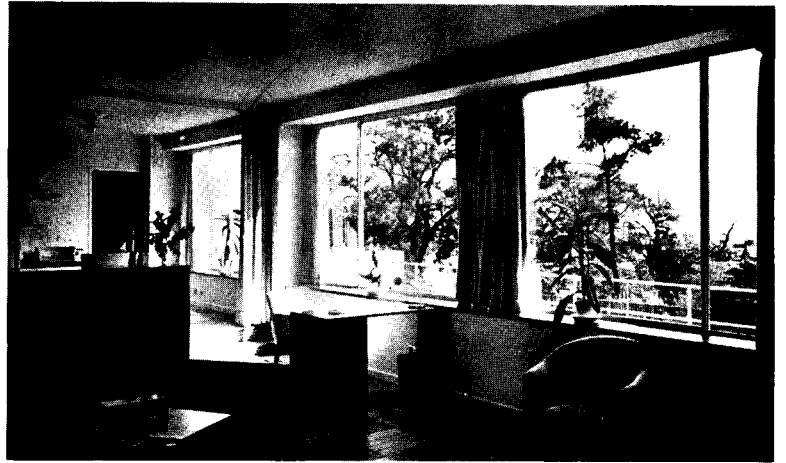

75

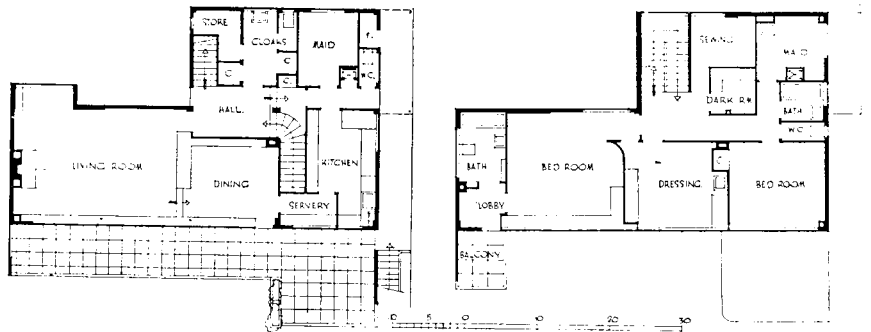

76



77

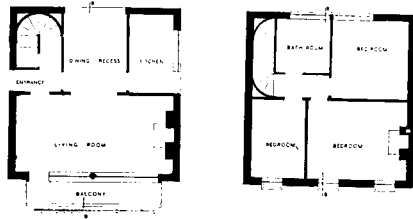

78

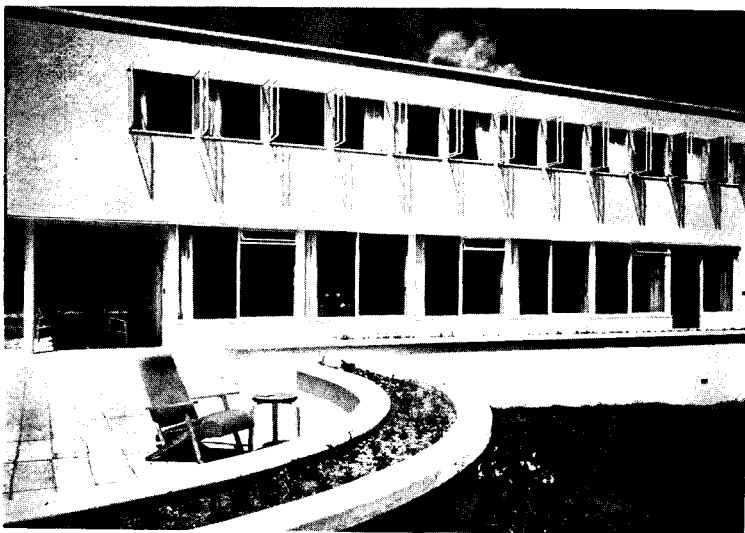

79



80

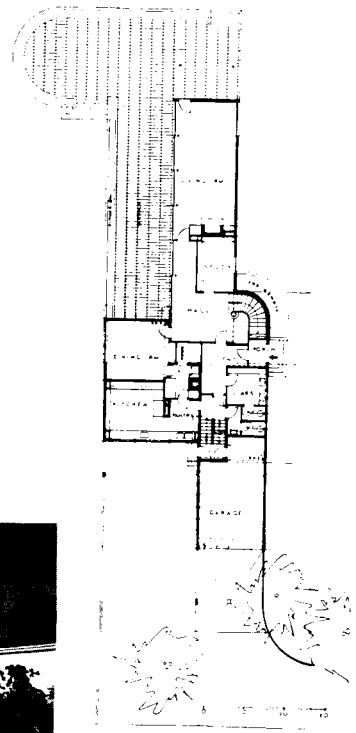

81

73 (overleaf), A freestanding studio, in concrete and brick, built on the grounds of his country house in Hampshire for Augustus John, the well-known painter (Christopher Nicholson, architect, 1935). 74, 75 and 76, A reinforced concrete house in Hampstead (E. Maxwell Fry, architect, 1936). 75, shows the internal effect of the great range of sliding windows to the

living room. The main floor of the house is at an upper level, the ground floor (not illustrated) containing only a garage and entrance vestibule. 77 and 78, One of a group of small houses on a building estate in Sussex: meeting a problem, that of speculative small-house development, that English architects are not often given the opportunity to tackle (Lubetkin and

e x a m p l e s

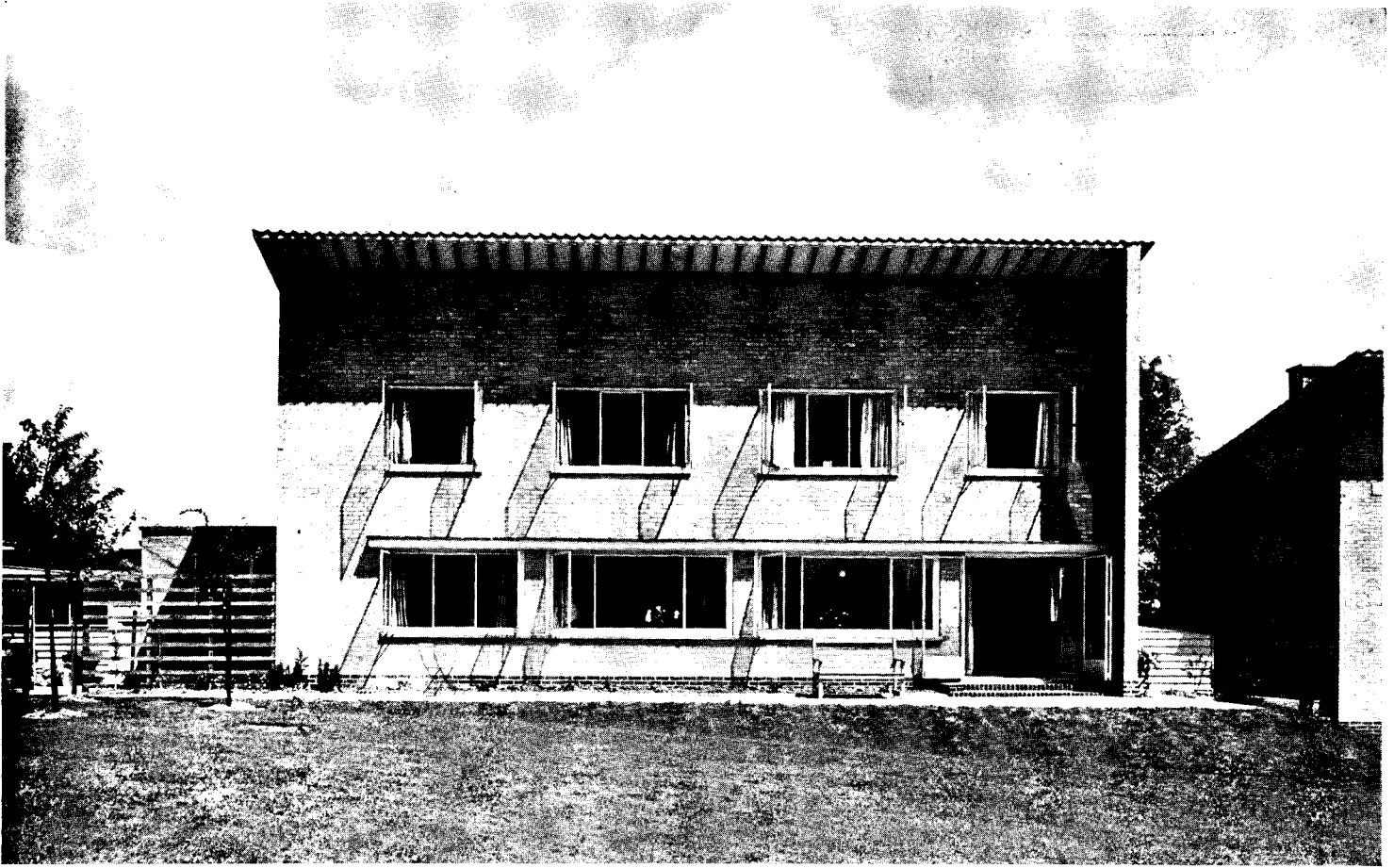

82

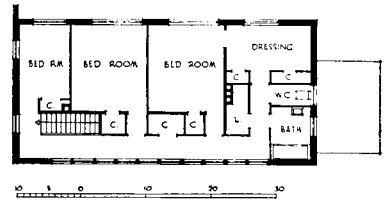
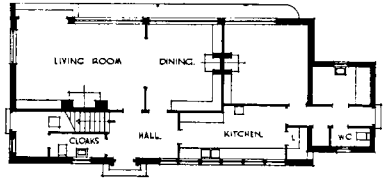
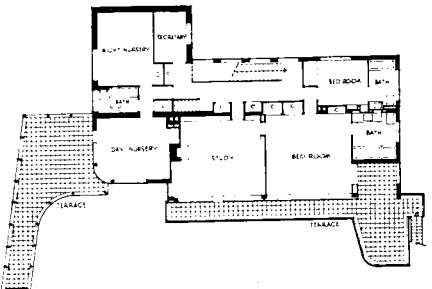

83

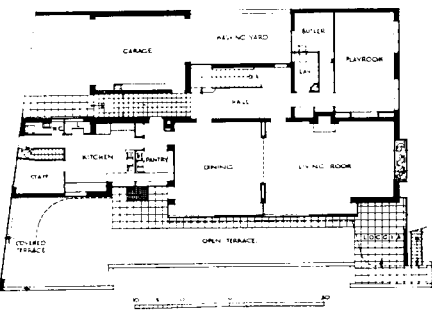

84



85

Tecton, architects, 1936). 79, 80 and 81, A luxury country house in Buckinghamshire, set in an old orchard (Mendelsohn and Chermayeff, architects, 1935). 80, The ground floor plan with its wide terrace forming an extension to the living room. 82, One of a group of three brick houses, also in an orchard setting, in Hertfordshire (Mary Crowley, architect, 1936). 84 and

85, A town house in Chelsea, London (Walter Gropius and E. Maxwell Fry, architects, 1936). On the top floor (not illustrated) are three maids' bedrooms and the large sun-terrace skeleton steel canopy seen in 85. The house is planned with its long side running away from the road, so that the principal windows overlook the garden, from which the photograph is taken.

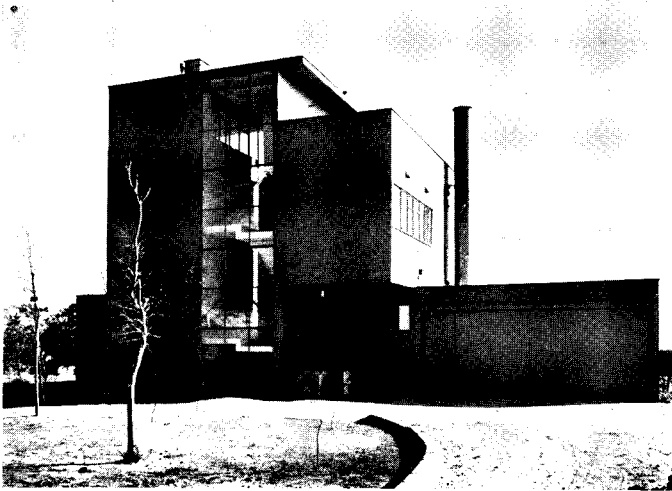

86

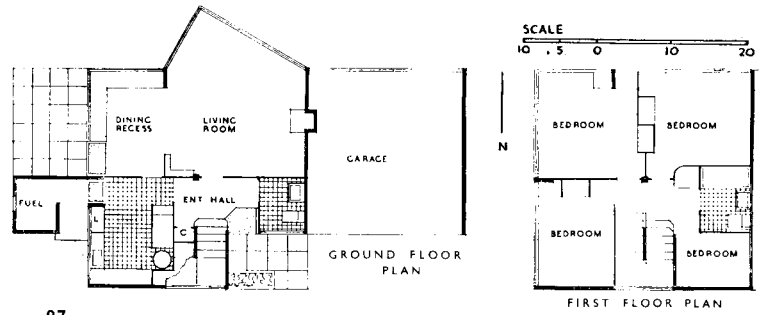

87



88



90



89



91

86 and 87, A reinforced concrete house for a doctor, in Sussex (Connell, Ward & Lucas, architects, 1936). Note the unusual detached cylindrical chimney. 88, A small country house in Buckinghamshire, L-shaped in plan, with the principal rooms facing inwards to a garden court (Harding and Tecton, architects).

89, A room in a London flat, redecorated and furnished by Serge Chermayeff, 1934. 90 and 91, The interior reconstruction of an older house in Bristol (F. R. S. Yorke and Marcel Breuer, architects, 1936). 90, The staircase with oak treads and steel string and railing painted gray and blue. 91, The dining room, with wall lined with corrugated asbestos sheeting, painted dead white, with aluminum chairs by Marcel Breuer.

Some

Personalities of the modern movement

MARCEL BREUER

Breuer is one of the distinguished European architects that unstable conditions, political and economic, have brought to England during the past few years. He received his architectural training at the Bauhaus at Weimar, where he was one of the most brilliant of Gropius's pupils. When the Bauhaus removed to Dessau in 1925, he joined it as a member of the staff. He practiced as an architect in Berlin, 1928-1931, in Budapest and Zurich, 1931-1935, and came to England, 1936. He practices here in partnership with F.R.S. Yorke. He has specialized in furniture design and was the inventor of steel tube furniture (1925) and of sprung aluminum furniture (1933).

BURNET, TAIT & LORNE

The association of the academic, but in his time progressive-minded, Sir John Burnet with the younger Thomas Tait, and later with the American-trained Francis Lorne, produced an architectural partnership, Sir John Burnet, Tait and Lorne, that has been a considerable influence on London's modern architecture. Sir John Burnet's most significant building was the photo-modern Kodak House, Kingsway (page 5). He was also responsible for the King Edward Gallery at the British Museum (page 6). The advent of Tait first made itself felt in the design for Adelaide House, London Bridge (page 6). The principal works of the present partnership have been: Ravenscourt Park Hospital (page 26), The Curzon Cinema, Mount Royal and Lowndes Square flats and the Burlington School (page 26).

SERGE CHERMAYEFF

Though of Russian birth (born in the Caucasus in 1900), Chermayeff was educated in England. He began his architectural life as designer for a decorating business in London. His name was first prominent as organizer and designer of the Waring and Gillow Modern Exhibition in 1929, an exhibition of historical importance as one of the first manifestations in England of the Modern

Movement in furniture and interiors. He started private practice in 1931 and later went into partnership with Erich Mendelsohn, the celebrated German architect who migrated to England in 1933; which partnership continued until the end of 1936.

CONNELL, WARD and LUCAS

This partnership has been chiefly engaged on domestic work and its members were among the pioneers of the modern small house half-a-dozen years ago. They work almost entirely in reinforced concrete. Amyas Connell and Basil Ward both come from New Zealand where they were born in 1901 and 1902, respectively. Colin Lucas was born in London in 1906 and educated at Cambridge. One of their concrete houses is illustrated on page 34.

JOSEPH EMBERTON



As distinct from that of most of the younger members of the modern English school, Emberton's practice has not been largely confined to domestic and interior work; he has carried out a number of important buildings which have been landmarks in the given establishment of the modern movement. His Universal House, on Southwark Bridge, London (1933), was a pioneer modern office building. Other notable works have been: Olympia Exhibition buildings, London (1930); Burnham Yacht Club (1932, page 28) and, in 1936, Simpson's store in Piccadilly, London (page 27).

FREDERICK GIBBERD

One of the younger modern architects; born 1908; studied architecture at Birmingham and on the Continent; began private practice in London in 1933.

He is a specialist on low-rental flats and their equipment.

E. MAXWELL FRY



Born 1899; educated at Liverpool. Is an authority on Town Planning, having practiced from 1927-1936 as the architect partner in the town-planning and architectural firm of Adams, Thompson and Fry (with the Thomas Adams who is chairman of the New York Regional Planning Committee). His most notable house, in Hampstead, is illustrated on page 32. He was one of the original members of the MARS (Modern Architectural Research) Group.

RAYMOND McGRATH

Born, Sydney, Australia, 1903; educated at Sydney and Cambridge Universities. Chiefly known as an interior designer, his interiors for Mansfield Forbes at "Finella," Cambridge, in 1929, are historically important. He was appointed Decoration Consultant to the British Broadcasting Company in 1931, and designed studios for them in London and Manchester (page 18). He published a book, "Twentieth Century Houses," written in Basic English.

WALTER GROPIUS



The reputation of Walter Gropius, the distinguished German architect, recently appointed Professor of Architecture at Harvard University, is so widespread that an account

of his career is hardly necessary. His greatest achievement was, of course, the establishment and direction of the Bauhaus (first at Weimar, then at Dessau), the university of design education that he founded in accordance with his own modern theories. His name is one of the great names of the Modern Movement. He is an authority on working-class housing (having built some very important Siedlungen) and on industrial design. He practices in partnership with E. Maxwell Fry, and his chief works in this country, to date, are a house in Chelsea (page 31), and a school in Cambridge-shire.

LUBETKIN and TECTON

The architectural firm "Tecton," was founded in 1931 by Lubetkin, the Russian architect (who, besides working in Russia, had had cosmopolitan experience, most recently in Paris). He organized under his leadership a group of young modern-minded architects (most of whom had just graduated from the architectural schools) to form under this name a working unit that should also provide an opportunity of collective experience. The membership, as was intended, has varied. The present members, besides Lubetkin, are R.F. Skinner and L.A.T. Drake.

CHARLES HOLDEN



Born in 1875 and educated at Manchester and the Royal Academy Schools. The partnership of which he is the leading member, Adams, Holden and Pearson, in the capacity of architects to the London Underground Railways, has had a great influence in disseminating the idea of good design. Besides a large number of Underground Stations (pages 6 and 20), Adams, Holden and Pearson built the head offices in Westminster for the London Transport Company.

CHRISTOPHER NICHOLSON

Born 1904; son of the well-known painter, Sir William Nicholson, and brother of the abstract painter Ben Nicholson; educated at Cambridge University. He was awarded the Davison Scholarship to Princeton University, U.S.A.,

where he took the graduate course in architecture.

P. MORTON SHAND

A writer on modern and historical architectural subjects and an architectural critic. His chief part in the development of modern architecture in England has been as an intermediary between England and the Continent. He was the first to translate Le Corbusier and Walter Gropius into English. He was one of the founders of the MARS group.

WELLS COATES



Born 1895; educated principally at Canadian Universities; studied in Paris and London; given his first public opportunity by the British Broadcasting Company, for whom he designed studio interiors in London in 1932 (page 17) and later at Newcastle. Principal works: the "Sunspan" type houses and Embassy Court, Brighton (page 24). One of the founders of the MARS (Modern Architectural Research) Group.

SIR OWEN WILLIAMS

Actually an engineer not an architect, Sir E. Owen Williams has been responsible for a number of large buildings that have their importance in the establishment of modern architecture in England. Born in 1890, he took first-class honors in engineering at London University; he was awarded the Telford Gold Medal of the Institution of Civil Engineers for a thesis: "The Philosophy of Masonry Arches." He specialized in reinforced concrete work, starting in private practice as a consulting engineer in 1919. He was engineer for the British Empire Exhibition at Wembley, 1923-1924.

F. R. S. YORKE

One of the younger group of architects, who has worked also as an architectural journalist. Born in 1906, he was educated architecturally at Birmingham University and has practiced in London since 1930. He works now in partnership with Marcel Breuer, chiefly on domestic interior (page 34) and exhibition work. He is also editor of "Specification," and author of the important anthology of international domestic architecture, "The Modern House" (1934).

THE ARCHITECTURAL SCENE

The Work of the Architect

In England, building work falls into two main categories, that which is designed by architects and that which does not employ an architect's services in any form whatever. A vast amount of the speculative suburban development, more especially in domestic work, is seldom touched by the architect, though of recent years the more enlightened building estate developer has employed partial architectural services, either through a private practitioner or by means of a salaried architect on the staff of the estate.

The work for which architects are responsible is again divided between architects in private practice and architects employed at a fixed salary by public authorities or large commercial concerns.

All the larger cities and country or borough councils have their own architectural departments, with a chief architect responsible directly to the local authority. A larger number have their architectural departments merged as a section of the engineer's or surveyor's department, the chief architectural assistant (as he is usually then called) being responsible to the engineer or surveyor only—with obviously less satisfactory results to the buildings concerned and, subsequently, to the public interests.

When works of a major character are to be undertaken, e.g., head offices, it is usual for commercial firms to employ an eminent architect to act in collaboration with or as consultant to their own staff architect.

Major public buildings and smaller public buildings in those districts where no highly organized official department exists, are usually the subjects of open competitions. The competition system in England is long established and the number of competitions held is increasing. They are for the most part organized by the promoters of the building, to the strict competition regulations of the Royal Institute of British Architects.

Private practice is still the ambition of nearly all young architects. At the present time there is on the whole less of the one-man practice and more of partnership or similar collaboration. Specialization of private firms is highly developed in certain directions, particularly in the field of hospitals, cinemas, factories and residential flats. The number of consultants is increasing, as well as their scope. In addition to the long-established custom of structural consultants we now have private practitioners as specialist consultants in acoustics, lighting problems, equipment, interior decoration, furniture, garden design.

L. W. THORNTON-WHITE

Professional Organization

The outstanding characteristic of professional architectural organizations in England is that such organizations have always in the past been formed from within the profession, and not officially from outside it; and have held their authority by usage and by tacit agreement rather than by statutory constitution. Only in recent years has there been any movement to place the control of the architectural

profession on a strictly legal basis.

The organization with most influence in professional affairs has been, for a great many years, the Royal Institute of British Architects. This Institute was founded in 1834 and, from its early beginnings as a learned society centralized in London, it gradually increased in membership and influence to a position of unique importance. Among the achievements of the R. I. B. A. (as it is usually called) have been: the establishment of a code of practice and a scale of fees to which all members are bound to adhere, of a Board of Architectural Education to supervise the work of the schools of architecture, and of the Allied Societies—smaller local organizations existing in all parts of Great Britain and throughout the British Empire, all affiliated to the parent body and forming with it a cohesive system of architectural inter-communication and control; and the acquisition of the right to appoint the architectural representatives on such bodies as the Building Research Board, the British Standards Institute and the British Schools at Rome and Athens.

At the present time the total membership of the R. I. B. A., with its Allied Societies, is rather over 13,000. Its president is recognized academically as the head of the profession, and it is to the R. I. B. A. Council that is allocated the appointment of assessors for architectural competitions. Membership of the R. I. B. A. (which carries with it the designation "Chartered Architect"), though without legal recognition was, until the passing of the Registration Act, generally accepted in a court of law as the proper qualification for an architect.

The R. I. B. A. has taken little part in the great program of slum clearance and working-class rehousing on which the country has been occupied in recent years. The tendency for the R. I. B. A. to represent only the more conservative school is accentuated by the fact that its control is in the hands of architects in private practice, from whose point of view its policy is largely considered. The most important change that recent years have seen in the profession of architecture is the great increase in the number of architects employed either by the government, by local authorities or by industrial and commercial firms, etc.; so that these now represent a large proportion of the total number of architects; and this change of balance in the profession has not yet resulted in a corresponding change in the R. I. B. A.'s organization.

There is, independent of the R. I. B. A., a small and not as yet very active "trade union" organization, the Association of Architects, Surveyors, and Technical Assistants, that exists to represent the employed members of the profession.

About ten years ago the first steps were taken towards fulfilling an object that had been discussed in architectural circles for many years—the presentation to Parliament of an architects' Registration Bill. The purpose of this bill was to place the profession of architecture on a legal footing by instituting a Register or list of officially qualified architects, after the same fashion as the Registers that had long existed of qualified members of the professions of medicine and law.

The measure was chiefly prepared and its terms discussed by the R. I. B. A. Council. After a large amount of controversy in architectural circles as to its desirability it was eventually (in a form greatly modified since its original inception) passed by both Houses of Parliament. It received the Royal Assent and became law in July 1931, and came into operation on the 1st of January 1932.

This Act of Parliament—the Architects

(Registration) Act, 1931—besides establishing the Register of qualified architects referred to above (under the present form of the Act only a voluntary one), inclusion in which carries with it the designation "Registered Architect," also establishes a supreme body to administer the Act, known as the Architects' Registration Council.

The Council consists of representatives appointed by the various professional organizations and by unattached architects (the number of representatives from each being in proportion to the total membership), and representatives of the allied professions of surveying and engineering and of the building trade. The Council is now, by virtue of its statutory foundation, the recognized governing body of the architectural profession; a position hitherto unofficially granted to the R. I. B. A. Admission to the Register is by examinations of about the same standard as those qualifying for Associateship of the R. I. B. A.

The remaining architectural body of political importance—there are, of course, many Societies and Associations of this and that of which space prevents mention, is the MARS (Modern Architectural Research) Group. This was formed three years ago as the English unit of the C. I. A. M. (Congrès International d'Architecture Moderne), at whose conferences and in whose work England had hitherto been unrepresented. It is the nucleus in England of the modern, rational or international school of design, at the opposite end of the scale to that represented unofficially by the Council of the R. I. B. A., and its small membership includes nearly all the architects in England who are doing "modern" work; most of those whose buildings are illustrated in the foregoing pages are members of MARS. MARS has an ambitious research program, both technical and sociological, and takes part in the C. I. A. M. collective program of research; but its chief importance at present is as a cohesive body of progressive-minded individuals, all of whom agree on fundamental principles and can unite, if necessary, to stand up for the modern ideas.

JAMES MACQUEDY

Education

The immediate aim of all regular architectural training in this country is to qualify students for membership of the Royal Institute of British Architects (R. I. B. A.). This is not a legally necessary qualification, and a considerable number of fully trained architects prefer not to be associated with the R. I. B. A. Moreover, by far the greatest number of new buildings have been designed by persons with no claim to full architectural training. In spite of this fact, the whole educational system for architects is centered round the R. I. B. A.

This body is thus able to exercise a general supervision of the training of architectural students, although it does not itself run any schools. The actual training is intrusted to independent schools, often connected with the universities. The traditional "pupilage" system, by which the student obtained all his training as an articulated pupil in the office of an architect, to whom he paid a fee for giving him personal tuition, is becoming obsolete. The schools have been granted varying degrees of autonomy. The largest and most important have in practice complete exemption from R.I.B.A. examinations, and their recommendation automatically entitles students to become Associates of the R. I. B. A. at the end of their training. Examples of schools in this category include among others the Architectural

Association School in London, and the University Schools of London, Edinburgh, Liverpool.

Next come the schools with partial exemption from R. I. B. A. examinations; these can pass students through the intermediate examination (at the end of three years) but no further. The most important example of this is the small school attached to Cambridge University.

There are also a number of smaller schools where students are coached in the curriculum for the R. I. B. A. intermediate and final examinations. Attendance at such a school cancels the need for the student to produce a "Testimony of Study."

A more concrete description of the curriculum at one school will serve as an example for all. The Architectural Association School is perhaps (with Liverpool) the most influential school in England. The course at this school lasts five years, with a voluntary addition of two years for studying the major aspects of housing and town-planning. The first three years are spent in solving and working out fairly elementary problems in design; at the same time construction and materials are demonstrated and learnt. After three years the great majority have reached the Intermediate standard; for the next two years they work on large planning schemes—Pre-Thesis and then Thesis. There is, in common with most of the better schools, very little dictation on the "style" of architectural design; though there may be remarked a tendency to regard design too much in the stylistic sense. There is a recognizable A.A. type of architecture, which might be described as a modernized or simplified academic one; but in all schools there are also independent-minded students working out their own salvations. Some of the schools, in contrast to these two, are extraordinarily unaware of modern architectural circumstances and persist in a course that is little more than a series of technical and academic exercises. There is often too little practical participation in building though expeditions to works in progress can be easily arranged. The success of the whole curriculum depends largely, as it should, on the initiative of the students themselves. For example, a group of students may, if they wish, collaborate and produce a joint scheme worked out in greater detail.

JOHN MADGE

Professional Practice

The architectural profession today is, materially, enjoying a boom, the extent of which is only comparable to that experienced during the few hectic years succeeding the Armistice. Assistant architects, especially those possessing experience and skill, are difficult to obtain, and the ordinary routine draftsman can be assured of employment at a wage more than commensurate with his ability.

Building conditions were improving with an even acceleration before the British Government decided to embark upon its great rearmament program; now that this enormous impetus has been added to the activities of the building industry, the practicing architect is faced with two problems of no insignificant importance. The first arises from the rapidly increasing cost of building due to demand overtaking supply; although this fact does not appear to be causing an immediate diminution in private-enterprise buildings, its detrimental influence may be expected to be felt during the next six months. Secondly, the architect is not able to produce his work with reasonable celerity because of the acute shortage of available assistance.

In addition to these emergency conditions,

which impede his desire to make the best of the boom while it lasts, there is always before him the ever-growing menace to his means of livelihood caused by the expansion of the sphere of the salaried and official architect. Many industrial and commercial concerns, chain store companies, county and borough councils and, by no means least of all, the Government, all employ permanent staffs of qualified architects to produce these building programs. The number of salaried men in the profession, many of whom have been forced by economic pressure to relinquish their status as private practitioners and work for these commercial, municipal and Government undertakings, is computed to account for no less than 70% of the membership of the Royal Institute of British Architects; and the number is still growing at the sacrifice of the smaller practicing architect.

As yet there is no definite indication that the big contracting firms are setting up architectural departments in their organizations to deal with their speculative building schemes, but there have been a few instances recently of practicing architects accepting commissions from building firms on an inclusive fee basis.

The majority of English practices are conducted on personal and individualistic lines by the architect aided by a small staff of one or two draftsmen. His yearly aggregate of commissions may range from £20,000 to £50,000 and, after paying all expenses, a profit will accrue varying from £800 to £2,000. These smaller practices occur particularly in the provincial towns of England, but there are many similar in London. In all, the chief personally plans, designs and supervises the erection of his job; he may be said to represent the backbone of the architectural profession.

Above him in quantitative value of executed work stands the architect whose chief ability lies rather in obtaining commissions, by negotiating sites and arranging building finance, than in an executive capacity. He employs a large staff, the chief of which is a skilled planner and designer and usually a qualified architect. These offices deal in hundreds of thousands of pounds worth of work a year and, as they are all highly organized, the profits invariably necessitate the payment of considerable super-tax to the Exchequer.

Another type of architect specializes in municipal buildings, hospitals, schools, swimming pools or cinemas; his commissions are usually obtained as a result of his being recognized as an expert in his particular sphere of work. Generally he has achieved his reputation through winning open architectural competitions.

English office procedure, generally speaking, is conducted in an intimate and easygoing atmosphere; there is but little outward sign of that peculiar type of over-organized business efficiency which is so trying to the temper and a hindrance to real, solid work.

JULIAN LEATHART

Building Legislation

With certain important exceptions which will be mentioned later, the public control of building in England is not the function of the central Government but of local authorities who administer regulations, called bylaws. These bylaws are made, and can be repealed or modified, by the local authorities themselves subject to approval by the Minister of Health. The position is confusing, as there are over 1,700 local authorities and there are many diversities in the bylaws. Attempts are continually being made to persuade all authorities to adopt one of the sets of model bylaws

which the Ministry of Health has drawn up. There are three such sets: a full urban model for large towns; a rural model; and an intermediate model. They deal with such matters as the level, width, construction and sewerage of new streets—the structure of walls, foundations, roofs, chimneys of new buildings for security stability and the prevention of fire and for purposes of health—the sufficiency of the space about buildings to secure ventilation and a free circulation of air—the drainage of buildings.

The requirements of the bylaws are purposely kept in general terms. For example, steel frame construction is controlled only by a clause which states that the steelwork must be adequate to secure due stability. Thus considerable differences of interpretation exist in different districts. Generally any dispute regarding interpretation must be settled in a court of law although in some cases the Minister of Health will act as an arbitrator.

It will be appreciated that with only general requirements, and local control, much depends on the individual official who, in practice, administers the law; and architects often complain at being at the mercy of an official who, conscientious as he may be, cannot help allowing his personal opinions and the ideas he has been brought up with as to what a building should look like, to influence his decision. Modern architecture often finds itself obstructed simply by the officials' natural conservatism of outlook.

A set of plans of any proposed building must be deposited with the local authority who, in most cases, is bound to approve or disapprove them within one month. Theoretically, provided the building complies with the bylaws there is no need to wait for this approval before the work is commenced.

In contrast to the foregoing, in certain places (of which London is the foremost example) building is controlled by a local Act of Parliament, i.e., an act which can only be modified by Parliament and which cannot be challenged in the Courts as ultra vires or unreasonable. This gives an inconveniently rigid system of control, especially in the case of London where, unlike the bylaws previously mentioned, there exists an extremely detailed set of regulations, particularly as regards structural matters which are now, owing to their age, obsolete in their requirements. An attempt was made to deal with this difficulty by passing an Act which gave the authority in this area (the London County Council) power to waive or modify most of the provisions of the Act. These waivers are, however, only granted on application which must be made for each job and the delay caused can be imagined. A further Act was therefore passed in 1935 giving the London County Council power to control buildings by means of bylaws in much the same way as other local authorities. At the time of writing proposed bylaws are under consideration.

Building legislation in London is also complicated by the fact that while the London County Council deals with most large structures, a local official, called the District Surveyor, sees that ordinary building regulations are complied with; drainage and some other matters are dealt with by another authority—the Borough Council—and the London Fire Brigade requires satisfaction as regards fire protection. Since several departments of the London County Council are usually concerned it is not uncommon for an architect for a large building to have to deposit five or six different sets of plans for approval. The District Surveyor, appeal against whose decisions is an elaborate business, is in a position of great power and his frequent conservatism again makes the work of a modern architect more difficult than it should be.

Throughout the country special types of buildings, such as cinemas, theaters, factories

employing more than a certain number of people, are also subject to special Acts of Parliament.

Building law has also been complicated throughout the country by the Town Planning Act. Under this Act local authorities have the power to "plan" or "zone" their area and control a building erected on any site as regards size, height, design and external appearance. Any buildings erected while this plan is being prepared must be made to conform with the requirements of the "plan" when published without compensation to the owner.

The English architect's life would be made ten times easier if some systematic revision of building law, its coordination throughout the country, and its recognition of modern technique could be brought about. The architect is in the position of an expert whose very expertness is continually called in question. Today he has to be also a diplomat.

W. E. J. BUDGEN

Planning in Town and Country

England may justly pride herself on having in the past played an original creative part in the evolution of town planning. Her contribution was of a special and valuable kind. Instead of dealing in grandiose window-dressing for the pleasure of autocrats she dealt in a domestic tradition, the building of towns for the benefit of the people living in them. In the seventeenth, eighteenth and early nineteenth centuries, at a period when she was making her greatest contribution to European architecture, England perfected the domestic town in street, crescent and square. The barbarism of the Industrial Revolution was a long and dreadful interruption, but even at the end of the nineteenth century England was still, this time through the Garden City idea, a pioneer in her emphasis on the domestic aspect of the town.

The Garden City idea is England's most recent contribution to town planning. It was inspired by a genuine distress at the conditions which industrialism had produced. But though the Garden City idea has been responsible in detail for some meritorious examples of improved living conditions, it is this very idea that is now responsible for much of the confusion in which town planning finds itself in this country.

Town and Country Planning is beginning to lose its position as a big idea. People are actually beginning to shudder at the words. To most they have come to suggest the acme of dreariness. The very smell of a solicitor's office, that dry stale musty depressing smell, is evoked at the mere mention of them. To some they have become nothing more than a bad joke. To others they bring the embarrassment of being reminded of illusions and enthusiasms that have faded. To still others they bring a sense of hopeless frustration that is expressed in anger or cynicism according to individual temperament. The only people to whom they bring any satisfaction, and then not much, are the handful of dull officials who get their living out of the business. From all of which it may be gathered that English town and country planning, in spite of its traditional vitality, is today in a bad way.

It is indeed. As it is conducted now it might almost as well not exist. (Perhaps it would be better if it didn't, for its condition is discrediting the whole important idea.) It is almost impossible to tell by merely looking at a district whether it is planned or not. You get the same shoddy untidiness, the same dreary confusion, in a planned as in

an unplanned area. The spoliation of the countryside goes on as gaily under planning as without it. So does the ruin of the town. Actually planning does here and there perform a certain usefulness in maintaining convenience. The line of a proposed road may be prevented from being blocked. A desirable open space may be preserved against building. But as for *appearance*, planning has done practically nothing. And appearance is still of some slight importance in the modern world.

Modern planning in England has failed in two ways: because of the inadequacy of the statutory means for its enforcement, and because of the inadequacy of the people engaged in it. These two reasons are, of course, interdependent, for the men engaged on the job have been largely responsible for the range of the statutory power that has been given them.

These men are housing reformers, garden city enthusiasts, in revolt against the horrors of Victorian industrialism. Their fault has been that they have never outgrown their early romanticism. They have concentrated on small things; unessentials; they have been woolly and unscientific. The great ideal of their town planning has been the prevention of long streets and the provision of large gardens. The New Jerusalem has been, and is today, a romantic suburbia. A modest ideal, and an attainable one. And unfortunately they have not only attained it but their concentration on it has limited the whole planning movement to dealing with trivialities. So at a time when the condition of the derelict industrial areas is creating a demand for a national planning scheme, when slum clearance is giving unprecedented opportunities for the re-creation of the civic ideal, the greatest proportion of town planning energy is given to seeing that houses are built at not more than twelve to the acre, and that they are built in the style of romantic country cottages. Moreover in some ways "planning" is actually acting as a drag on progress in other directions. The lovers of country cottages don't object at all to the shoddy Tudor villas which are littering England everywhere, but they do object to "modern" houses, and sometimes actually stop them from being built, for they have obtained the power to do so. So town planning, the idea of yesterday, is now listed by progressive architects as one of their principal "obstructions."

The statute under which these things are done is the Town and Country Planning Act of 1932. This is an extremely involved measure, and procedure under it is an extremely involved affair, so involved, indeed, that the "planners" who work it are generally mere administrators and not designers at all. Besides being principally concerned with (since it is the outcome of) the trivialities and prejudices of housing reformers of thirty years ago, this Town and Country Planning Act has two other great weaknesses. It is of a purely restrictive character, negative not positive in its scope, and it is unduly tender to the rights of property. Since any prohibition against building is likely to involve the local government authority in the payment of compensation, these authorities are naturally more than a little timid in making such prohibitions.

Can Town and Country Planning in England be regenerated? Before this question can be answered hopefully, it seems to us that we must have new powers, new personnel, a new Ministry, a new attitude towards land ownership and a new attitude towards towns; in fact, something altogether NEW. At the moment all to whom the maintenance or creation of a decent physical environment is a matter of some importance are in despair.

THOMAS SHARP

1, *Silbury*, from a painting by Paul Nash.

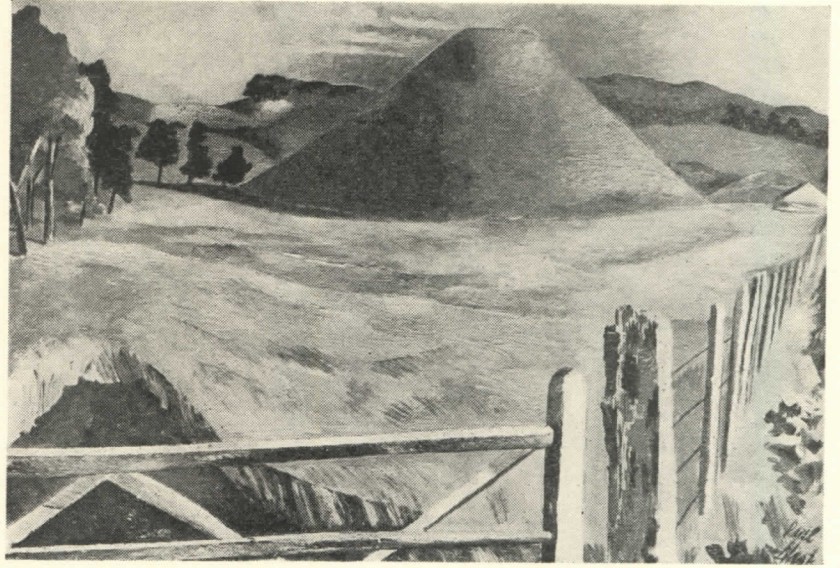

A Characteristic

By Paul Nash

THREE years ago when I was staying in Marlborough, in Wiltshire, I made several excursions to the neighboring village of Avebury, where stand or lie prone upon the fields the ruins of one of the oldest and most interesting architectural systems in the world.

Lately it is beginning to be known a little; in England, that is. I have no doubt that thousands of Americans and others have visited there for years. But it is a curious anomaly about the English that they inherit places and works of art, infinitely lovely and significant, which they have made or had made among them; yet so often these seem to them unimportant, if indeed they are aware of their existence.

The two monuments of Avebury and Silbury are cases in point. The admirable Dr. Stukeley, writing about the middle of the 18th century, remarks: "The mighty carcase of Stonehenge draws great numbers of people, out of their way every day, as to see a sight, and it has exercised the pens of the learned to account for it. But Avebury, a much greater work and more extensive in design, by I know not what unkind fate, was altogether overlooked, and in the utmost danger of perishing, through the humor of the country people. . . ." The humor of the country people expressed itself in elaborate and brutish attacks upon the megaliths. By laborious, expensive methods the silly farmers set about breaking the great stones, sinking them in pits, and splitting them by water, fire and the mallet. When, at last, they were made into walls of houses they proved, says Stukeley, damp and unwholesome, and rotted the furniture. However, there the remainder of them stand to this day, the holy stones of the Great Circle, propping up barns and jostled by ricks and dung-heaps—an uncomfortable comment on the perspicacity of the islanders. Not far away, close to the Bath Road, towers the strange bulk of Silbury; a vast truncated pyramid, 130 feet high and covering five acres of land; the largest earthworks in Europe. Like Avebury it has no certain history. At one period it was rather unscientifically plumbed and yielded some obscure vegetable remains. It may be a tomb as significant as those of Egypt. We do not know. On Sundays a good few couples climb to its summit to admire the view.

2



2, "The Fair Maid of Ken" (wife of the Black Prince): sculpture from the vaulting of Canterbury Cathedral.

Such reflections are inevitable in contemplating this peculiar scene. Imagine a monument so immense as Avebury; the prodigious, circular bank and dyke, the great circle of standing stones one hundred in number, sometimes twenty-seven feet apart, comprising an area of twenty-eight acres. Two smaller circles within, and an avenue without, fifty-three feet wide, stretching away over the hills to an extent of two hundred monoliths, seventy feet apart. This huge primitive complex, with its circles and avenues and its mighty gleaming pyramid of chalk, should have been one of the architectural wonders of the earth.

Now, some excuse may be made for the horrid innocence of the natives but we have to remember that Camden himself, who wrote the *Remains of Britain*, thought the mile-long avenue of parallel lines of megaliths evidence, merely, of plain rocks in their natural site. Dr. Childrey, author of *Britannia Baconica*, was of the same opinion; in fact, there must have been a popular conviction prevalent even in the enlightened 18th century, that any "remains" identified as pre-Roman were just *natural*.

It may seem a little fantastic to suggest, but I believe herein lies the seed of a fundamental misconception of that peculiar offering—the yield of the land, as it were, which is England's unique contribution to permanent beauty. As I made my drawings of Silbury, looking across the water meadows hedged by willows and groups of elms to where the earth reared up suddenly to such a surprising height, I felt I had divined the secret of that paradoxical pyramid. Such things *do* happen in England, quite naturally, but they are not recognized for what they are—the true yield of the land, indeed, but also works of art; identical with the intimate spirit inhabiting these gentle fields yet *not* the work of chance or elements, but directed by an intelligent purpose, ruled by an authentic vision.

With this theory in mind I began to make a small comprehensive collection of material which would be a detailed argument for my growing convictions. These had already overcome a suspicion that evidence of what I will describe as structural purpose was only sporadic or even illusory. Once sure that what I wanted to discover was a reality, it became curiously easy to find. To be explicit, the criteria set up were these. On the one hand a character which frankly disclosed a national inspiration, something whose lineaments seemed almost redolent of place and time within the limits of these shores. A thing one might describe, in no parochial sense, as *English*. On the other, a statement the design of which was large in plan and execution. We have been accustomed too long and slavishly to accept the prejudice of our connoisseurs and pedagogues whose understanding, for the most part, is at fault. Either they would have us believe that English art is essentially artless or that its formal expression is almost

entirely derivative. Neither suggestion is true. In the course of only a very perfunctory research, I have found abundant evidence that throughout the short history of English art not only does inspiration glow as though renewed by some constant spring, but in every age and in every field of invention the same lively qualities of interpretation are present. We do not claim for this art a high order of creative force; nothing here perhaps, of the first flight, has ever been achieved within the scope of the plastic arts; but it is time that the cloud of false witness was rolled away to make space for an intelligent illumination of the very distinct features of our true countenance.

In applying the term architectural to the various objects illustrated here it must be understood in its widest appeal. Clear manifestation of plan and direction are essentials, but the architectonic quality is variously interpreted.

The headpiece which introduces this essay has been included by request of the editor of this English number of THE ARCHITECTURAL RECORD. It was thought that some suggestion of the character of this part of the English countryside should be given as a background for speculation to readers unacquainted with our landscape. Between the gate and Silbury Hill are undulating grass meadows, at the moment ripe for the hay-makers, and so, constantly moving like water as the surface is broken by the shadows of passing clouds, the shafts of the sun or an occasional breeze. You will see how fantastic, how almost *Surreal* this landscape appears with its unprepared approach to the abrupt intrusion of a hill of such vast proportions. Yet we have seen such an effect before; the desert sands run almost as level to the foot of the Pyramids. . . .

Although it is not possible to give any impression of the ruins of Avebury which could do justice to their design, the groups of trilithons at Stonehenge leave no doubt of the original composition. Here is a simple and mighty conception precisely realized. A religious monument without parallel. Look down, next, upon the plan of Maidun, most formidable and perfect example of hill architecture. These separate precepts seem to me the symbols of our formal heritage. From their influence flowed out the inspiration of the early sculptors, the makers of the Saxon fonts and crosses. Of this breed is the marble knight of Dorchester Abbey, in Berkshire. Centuries later we find it in the best work of William Blake, on those too rare occasions when he escaped from the Gothic obsession. A hill, a tower, a teapot—the echo rings true throughout. Simple and large in aspect, the affinity becomes easy to trace, whether we compare Earls Barton with Stonehenge, or Carlton House Terrace or the Admiralty Stores at Portsmouth. Yet, when we come to examine the painting by Gainsborough we find another link. Both in Gainsborough's enchanting landscape and Nash's facade we find a subtle exercise of aerial perspective; each an architectural exploit of great distinction in different terms. Gainsborough's painting and the water colors of Cotman and Girtin seem to me admirable examples of a form of poetic expression peculiar to the English genius. But this is not the quality I wish to insist upon here. The portrait group and the sarcophagus are both very intelligently designed but the latter, together with Girtin's river scene, should be examined for their unique technical power. Here, again, is architecture, a truly *architectural* use of water-color painting; at which both Cotman and Girtin excelled beyond any artists of any period.

To complete the series a drawing worthy of our tradition was soon discovered once we had firmly turned our back on the "artists" of that dubious period (1880). Any excursions into our own times seemed too dangerous—even to begin. But it is obvious that with the complete decline of Impressionism and the exposure of the Pre-Raphaelite myth, English art has begun to grow into a healthy shape again. In twenty years we may be able to look back or even around with renewed confidence.

3



3. Maiden Castle, Dorsetshire, from the air. (R.A.F. official photograph: Crown Copyright reserved.)

4



4. Stonehenge, Wiltshire.

5



5. Effigy of a Knight in Purbeck marble: Dorchester Abbey, Wiltshire, circa 1310.

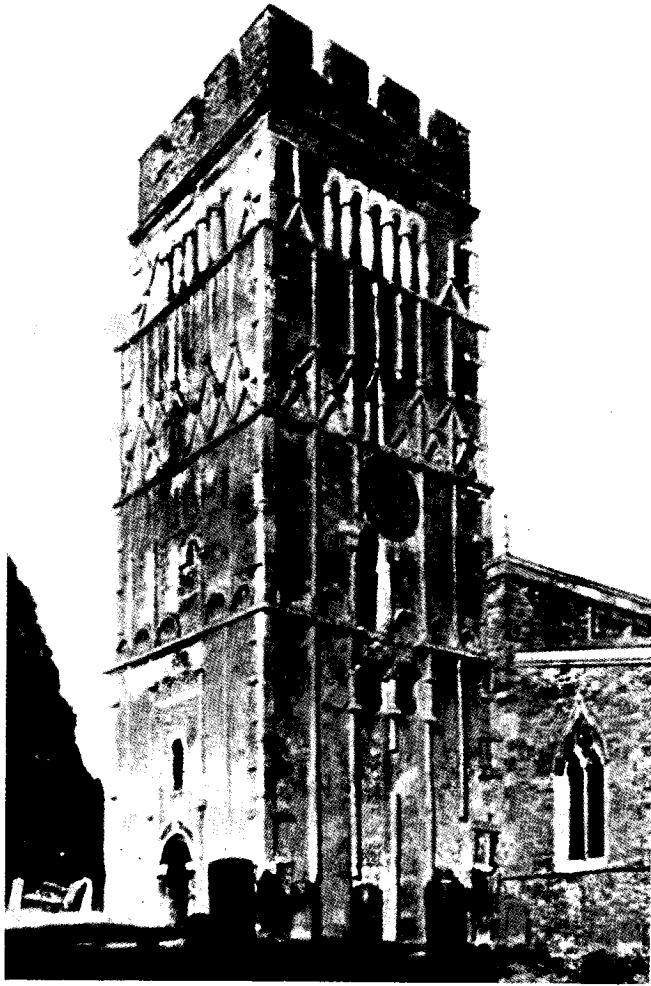

6



7

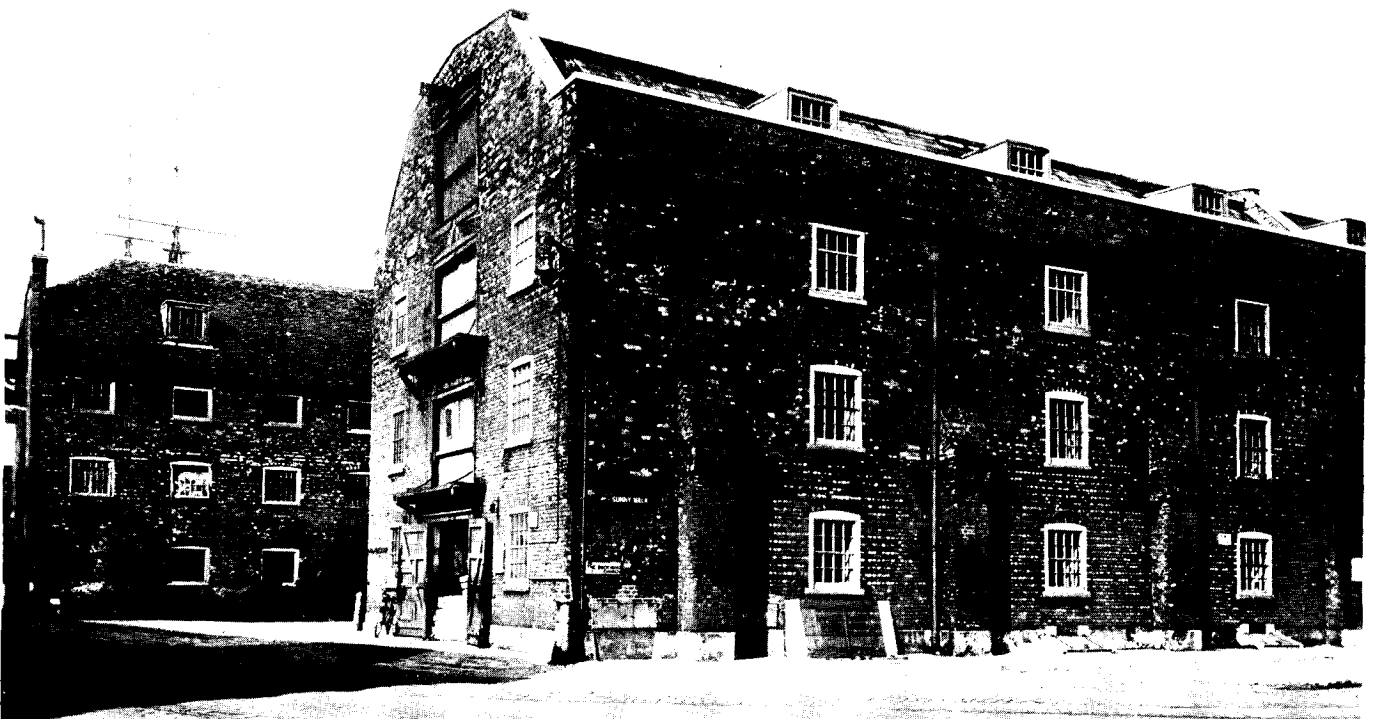

8



9

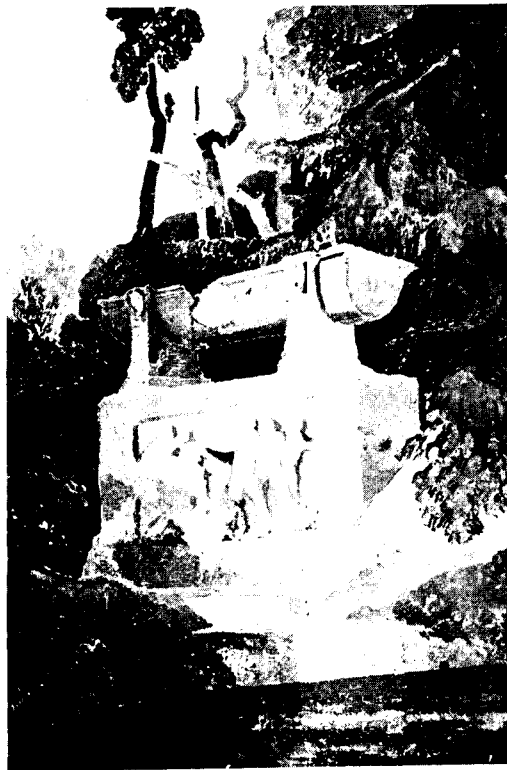

10



11



12

6. The Saxon tower of Earls Barton Church, Northamptonshire. 7. An English silver teapot, 1670. 8. Admiralty Stores at Portsmouth, 1771. 9. Painting, "Los and the Sun," by William Blake (1757-1827). 10. Water color, "Sarcophagus in a Park," by John Sell Cotman (1782-1842). 11. Painting, "Robert Andrews and His Wife," by Thomas Gainsborough (1727-1788). 12. Carlton House Terrace, London, designed by John Nash in 1828.

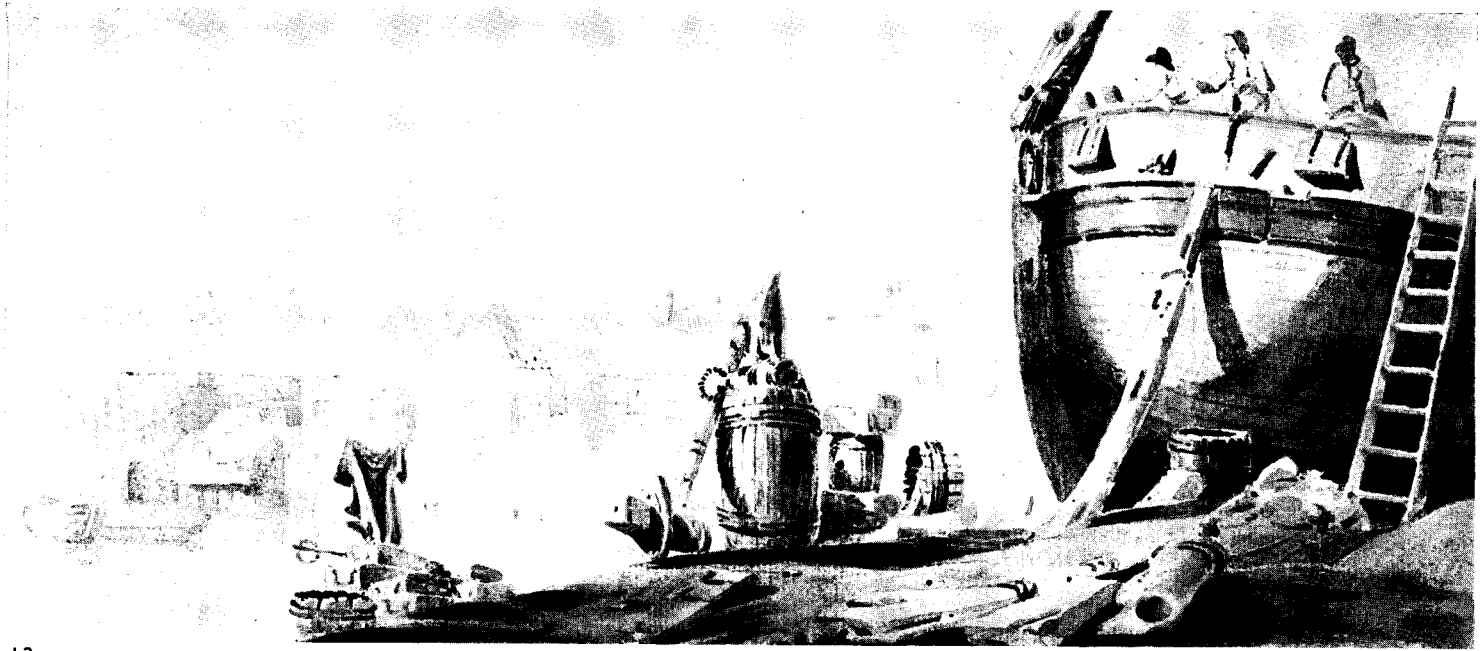

13

Plate 17

Vol III

LOCOMOTIVE PASSENGER ENGINE
"SUNSPIRE II"

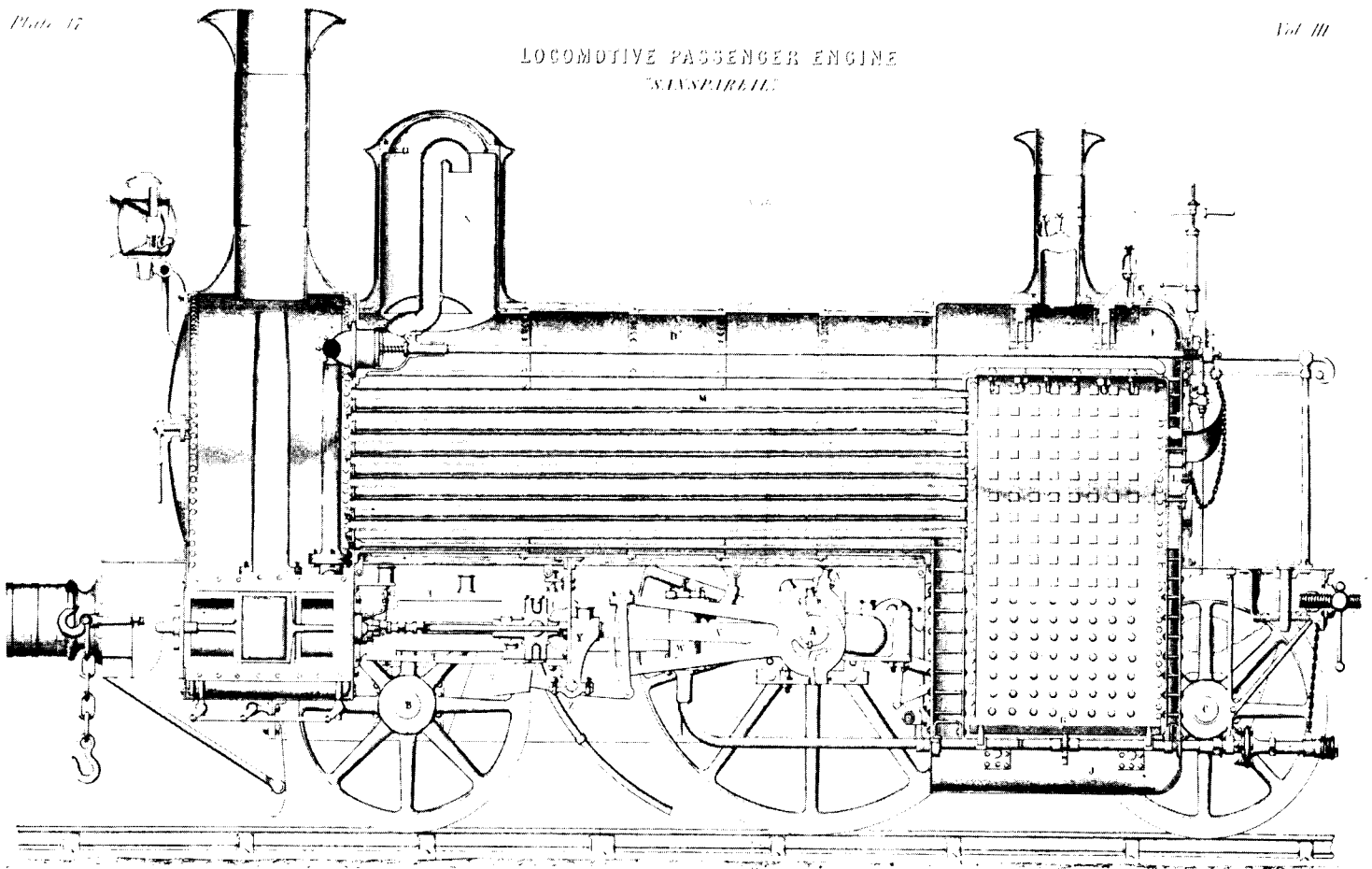

14

13. Water color by Thomas Girtin (1775-1802). 14. Engine drawing: circa 1880.

Where ENGLAND looks to AMERICA

By Herbert Read

FOR the average Englishman, American industry means Ford cars and skyscrapers, and there has not been much disposition on his part to treat these phenomena philosophically, to find a new canon of beauty in them. Indeed, the Englishman prefers to confine his philosophy to the cloistered precincts of the universities (where, incidentally, the existence of a philosophy of art is not recognized), and he does not even indulge in those genial moralizations which, I believe, characterize the American businessman in his leisure moments. The growth of any consciousness for the need of a new aesthetic has been very slow in our country; what uneasiness there has been during the last hundred years has always avoided the issue, turning away from the problems presented by the machine and yearning for the return of an idealized guild system of handworkers. This tendency which was rarely, if ever, the practical policy of industrialists themselves, was nevertheless taken seriously in some quarters; a movement was created, if only by poets, which forced the aesthetic problem of industrial production into some sort of international prominence.

What in England remained the practice of a few cranks became, on the Continent, a movement affecting industry as a whole. Dr. Nikolaus Pevsner in his recent book, *Pioneers of the Modern Movement*, has shown exactly by what steps, and through what agencies, all this happened—how it is possible that the logical outcome of William Morris was Walter Gropius. It is perhaps too early to claim that in its developed form this industrial aesthetic has hit England fair and square; but in many obscure and indirect ways the practical ideals of the *Bauhaus* have penetrated into this country. At least it would be fair to say that in architecture and the related industrial arts (furniture, lighting equipment, domestic utensils, etc.) we have learned more from Germany, Scandinavia, and France than from America. This is not to claim that we have learned much; we have so much more to unlearn than most countries. Nor does it exclude the possibility that in what we have absorbed from the Continent there is already an element which the Continent took from America.

I am not much given to defending the so-called common sense of my countrymen; it is but a polite name for a widespread inability to perform any mental operation involving intel-

lectual abstraction. I need not point out the advantages of this attitude in the field of politics. "Trust in God but keep your powder dry" is our national motto, and it implies that combination of blind faith and practical cunning which has made the British Empire what it is. It is true that we may on occasions change our faith, but not as a result of intellectual suasion; we change our faith, like our clothes because we have grown out of them, and they begin to pinch. A change of heart is not impossible, but a change of head would be regarded as a sign of weakness. "Ours not to reason why," to mention another national motto.

The application of these generalizations to our present subject is obvious. It means that the presentation of a logical aesthetic for modern architecture and industrial art in England is a purely idealistic activity. England will never proceed on *a priori* lines; she will take it or leave it, *it* in this case being any form of dogmatic aesthetic law. The only laws that are recognized are practical laws—for the most part laws defending the rights of property owners. Even those laws which to a casual observer might seem to have an aesthetic motive—town-planning regulations, preservation of rural amenities, etc.—are always given a pragmatic or utilitarian sanction; it is not for us a question of beauty, but of health. And, naturally, we do not consciously identify health and beauty, in the manner of Hitler.*

Confronted with the beauty of New York, the Englishman will instinctively begin to explain it away. He will point out that the skyscraper is an adventitious product—the inevitable product of fantastic land values on a confined space. He finds peculiar satisfaction in demonstrating that every progressive step in the development of the skyscraper can be explained on similar materialistic lines. If this attitude was due to a tender philosophical regard for the absolute nature of beauty, it would be admirably idealistic. But the actual motive is just the contrary: the wish to deny the existence of any aesthetic quality in such a product of the machine age. What Lewis Mumford has defined as the prerequisite of any further development of aesthetic capacity in the human race—the assimilation of the machine—that is, the step which so far the Englishman has refused

*Cf. His speech at the *Reichsparteitag*, Nuremberg, 1936: "Das Gebot unserer Schönheit soll immer heissen: Gesundheit."

to take. He sees a complete distinction between the vital and organic elements of his inherited concept of beauty and the purely mechanistic elements of machine production; and not being by nature a dialectician, he does not believe in the synthetic resolution of such contradictions.

Since I do not know America at first-hand, I cannot assume that it already offers us the completed synthesis. I only know that in a work like "Technics and Civilization" Mr. Mumford, an American, has clearly shown to us the way which we must all go. I also know that it is impossible that there should exist in America the formidable obstacles that face the English architect and designer whichever way he turns—the obstacle of entrenched and subsidized academic prejudice, and the still greater obstacle of prevailing traditionalism and conservatism. It is the presence of these obstacles which must determine our critical tactics. Here the struggle is primarily an ideological one. We have to break down an old concept of beauty before we can establish a new one. If in support of our theories we appeal to the evidence of the facts, the facts on which we rely are everywhere dominated by the residues of ancient civilizations. Conceive, if you can, the probability of an architect being allowed to build a vitally modern building within the sacred precincts of Oxford or Cambridge! But that is precisely the kind of difficulty which faces the industrial artist in England whichever way he turns. It may be that a not inconsiderable snobbery operates against the modern artist and architect in America, but snobbery can always be ridiculed and shaken. In the Old World we need the faith to move, if not mountains, at least monuments.

The new aesthetic must be based on the fundamentally new factor in modern civilization: large-scale machine production. It is here that we look to America: that method of production involves certain characteristics which contradict the accepted notion of beauty—they are generally indicated by the word *standardization*. In itself, standardization is not an aesthetic question. If a thing is beautiful, you do not diminish that beauty by reproducing it. You may complain that the reproduction is not exact, but again that has nothing to do with the question. Standardized machine products are exact replicas of one another, and

if one is beautiful, the rest are beautiful. What the critics of machine art object to when they talk about standardization is not the fact of standardization, but rather its failure to reproduce certain qualities which they regard as essential to art. Art, they would say, inevitably involves a unique personal element, an arbitrary and accidental quality peculiar to the moment of creation; and this element or quality, they assume, is not capable of being mechanically reproduced.

There are two possible answers to this objection. We may admit that certain forms of personal expression are not suitable for mechanical reproduction as standardized objects, but we claim that the creative will of the artist can and should be adapted to the new conditions. We draw attention to certain developments of modern art (abstract, nonrepresentational or constructivist art) which, while still remaining a very personal expression of the individual artists, are nevertheless the prototype of machine art. Actually such works of art could be reproduced without losing any of their aesthetic qualities; and more utilitarian objects which still express the same aesthetic qualities are actually reproduced in the standard products of modern industry.

The other answer is more drastic. It challenges the values inherent in the personal or individualistic criterion of beauty. The modern car, which incorporates the refined sensibility of a succession of designers, is a collective work of art of far greater value than the painting or statue which is the expression of the mood or thought of an individual. Even the past might be appealed to in support of this contention, and great impersonal works of art like the Pyramids of Egypt or the Gothic cathedrals are quoted as examples of collective works of art. The argument is perhaps a little specious but, it may surely be admitted that the tremulous idiosyncrasies which many critics regard as the final quality in art can be sacrificed if in their stead we can place qualities of precision and exactitude which have an equal claim on the aesthetic sensibility. Perhaps the only mistake we can make is to attempt to drive art into a single track. The mystery, the magic, the imponderable and incommensurable majesty of the Sphinx exist side by side with the geometrical exactitude, the mathematical precision of the Pyramids.



BUILDING TYPES

MARCH 1937



Photograph by George H. Van Anda

ONE-FAMILY DWELLINGS

HOUSES COSTING
LESS THAN \$10,000

IN THIS ISSUE

THE HOUSE COMES BACK

Thomas S. Holden, head of F. W. Dodge's Statistical Division, analyzes current trends in one- and two-family dwelling construction.

THE RECORD SCANS THE FIELD

A survey of the current activity of the busiest architects and operative builders in 37 eastern states.

WHAT THE CONSUMER WANTS

John C. Fistere, architectural editor of a consumer magazine, stresses the importance of recognizing consumer demands.

PORTFOLIO

Selected examples of recent one-family dwellings, built singly and in groups.

PLAN FOR REHOUSING AMERICA

Allie S. Freed, of the Committee for Economic Recovery, offers private industry's plan for playing an active role in housing.

PURDUE'S RESEARCH IN HOUSING

Benjamin F. Betts, Director of the University's research program, gives a summary of the past year's accomplishments.

STRUCTURAL SYSTEMS

Analyzing five current systems employing various materials, selected because of their recent application in moderate-cost dwelling construction.

ILLINOIS' RESEARCH IN HEATING

Dr. E. P. Kratz, in charge of the University's research in atmospheric control, writes on the necessity for closer integration of structural and mechanical designs.

STEADY IMPROVEMENT IN HEATING EQUIPMENT

John C. Hardigg gives an engineer's survey of current mechanical developments in the field of atmospheric control.

MODERN HOUSE DEMANDS MODERN ELECTRICAL SYSTEM

Carle Robbins, Nela Park engineer, stresses the importance of flexible electrical systems in modern homes.

N E X T M O N T H

Photograph by F. S. Lincoln



BUILDING TYPES SECTION ON SCHOOLS

Compilation of new practice in school planning, room arrangements, daylighting, equipment, construction, finishes. Such new schools as the following will be shown: Ansonia High School, Ansonia, Conn.—William Lescaze, Architect; Vernon F. Sears, Associate. Addition to the George Mason School, Richmond, Virginia—Lee, Ballou & Vandervoort, Inc., Architects and Engineers; Louis W. Ballou, Architect and Designer. John Adams Junior High School, Santa Monica, California—Marsh, Smith & Powell, Architects. Grade School at Northville, Michigan—Lyndon and Smith, Architects. Ralph Waldo Emerson Junior High School, Los Angeles, California—Richard J. Neutra, Architect. Beecher High School, Flint, Michigan—Lyndon and Smith, Architects.

IF ALL THE HOUSES IN AMERICA...



... were packed like sardines in a can—1 for each family, 10 to the acre—they would occupy only 70 of the 100 square miles indicated by the red square.

Double the area and you could pack away all buildings of every type—and still have 98.7% of the land left over!

Diagram courtesy THE AMERICAN CITY

THE HOUSE COMES BACK

by Thomas S. Holden

Architects have excellent reason to feel optimistic concerning the current revival of residential building. The record of such contracts let from architects' plans in the 37 eastern states has been as follows:

Year 1933.....	\$115,721,100
Year 1934.....	137,025,000
Year 1935.....	275,960,600
Year 1936.....	463,907,000

Not only has the dollar volume of architects' residential building increased threefold since 1933, but their percentage of total residential building has shown a gratifying increase. In 1933, 46 per cent of total residential work, by value, was planned by architects; in 1936, 58 per cent.

Naturally, the residential building volume of the lowest depression years was made up principally of modernization projects and very small buildings, mostly projects too small to afford architects' service. With the gradual upswing of recovery, more and more buildings of larger size and better grade have been undertaken, and more and more have architects participated in their design. It is in this better class of houses that architects find more general and more profitable employment than in the smaller types. The lower chart also shows a relatively greater increase in multiple-dwelling units than in 1- and 2-family units, another class of residential work that customarily offers larger opportunity for architects' participation.

While recovery progress to date has been substantial and indicative of further gains ahead, it is readily seen from the top chart that the total residential volume of the year 1936 was not quite equal to that of the year 1931. If the peak volume of 1928 is to be reached again in the current cycle, there is still quite a way to go. While every indication for 1937 is in the direction of further recovery progress, the country is still a considerable distance away from a residential building boom.

The favorable factors likely to affect further increases in residential building this year are so generally known that they scarcely call for detailed discussion. They include decreased vacancies, decreased foreclosures, increased real estate activity, larger and larger supplies of available credit on terms fairly favorable to the prospective home owner. Topping all other factors is the basic demand, enhanced by a long period of almost negligible new construction volume, a fairly ex-

tended period of recovery and improved incomes and, on the part of many families, the need for enlarged living quarters or the desire for better ones.

The one factor that is likely to act as something of a brake on recovery progress is that of costs. On all sides we hear of actual or anticipated rises in material prices and wages of building labor. There is a danger that too rapid cost increases might bring about a set-back in the building program. It is probably true that many owners who are now building have rushed their projects ahead in order to avoid high costs, and that others likely to build in the coming months may be easily discouraged, if they see fast-mounting prices and wages.

It is well in this connection to recall the experience of the year 1923, a year of recovery from depression when prices and wages began to mount. There was a falling-off in contract-letting, until there was an indication of stability in prices and wages, and then, after a few months' interruption, recovery proceeded to far greater heights than had been previously attained. Some such thing may happen in 1937.

With this latter consideration in mind, the Dodge organization has considered it wiser to estimate this year's probable gains on the conservative side, and has set 40 per cent as a safe guess for this year's increase in residential building volume. Such an increase would give approximately \$1,130,000,000 in dollar volume of residential work in the 37 eastern states. The numerical increase would be a little over \$300,000,000 and approximately equal the dollar increase of 1936 over 1935.

The figures for dwelling units given in the middle chart are those recorded for the 37 eastern states. According to Dodge estimates the amounts to be added for the eleven western states in each of the last two years should have been about 20 per cent. There are apparently variations in the proper percentage from year to year. On this basis, the total dwelling units erected in the entire United States would have been 90,000 in 1935 and 150,000 in 1936. The Dodge 1937 estimate for the entire country is 210,000 new family units. These estimates are smaller than many figures that have been published in recent months, but they are based upon factual records and not upon population estimates, which frequently lead to erroneous conclusions in connection with construction analyses.

DOLLAR VOLUME OF RESIDENTIAL BUILDING

Hotels Omitted—37 Eastern States

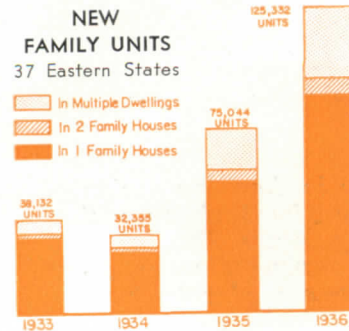
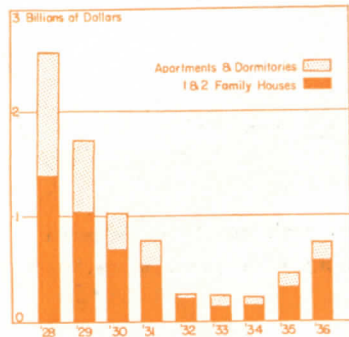



ORTY YEARS OF HOUSES

1917

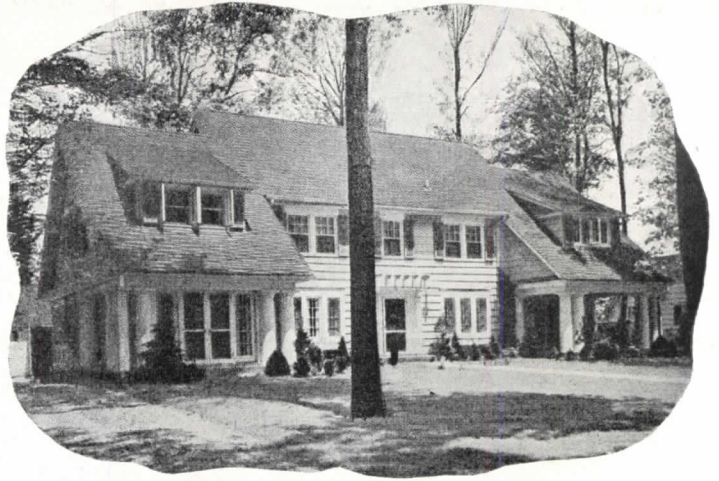

"Why then is modern work not always and indisputably superior to the old? The reply must go to the root of every style that is a conscious revival."

1897



"But the evidence that this dwelling afforded was that intelligent and artistic pains had been ungrudgingly bestowed on every smallest detail."

1927

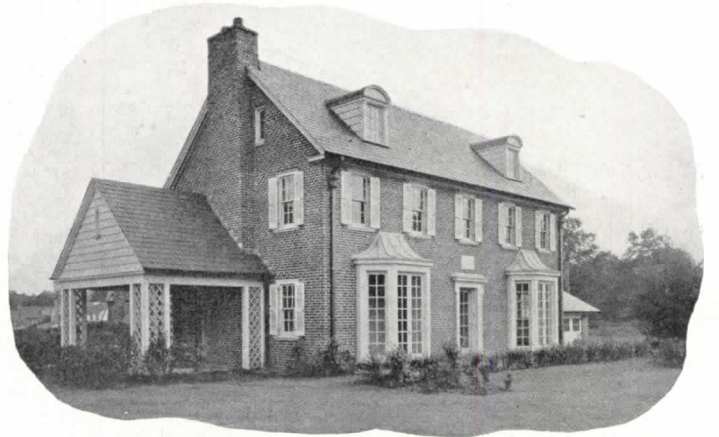

"Cottages, even tiny ones, peek out to us between the well-ordered planting with great allure."

1907



"Evidence of the greatest advance in the annals of history is apparent . . . the American Honey-suckle was used as the motif in the design and decoration of this house."

** Studies of trends in dwelling design are nothing new to The Architectural Record; for forty years the latest ideas have been conscientiously reported, as the above abstracts from old copies indicate.*

THE RECORD SCANS THE FIELD

1937 bids fair to be the best year for the home-building industry that the Thirties have yet seen. And to find out what is happening in the design, construction and distribution of one-family dwellings, THE ARCHITECTURAL RECORD made this survey. Using its exclusive access to Dodge Reports, THE ARCHITECTURAL RECORD questioned the most active architects and operative builders in the 37 eastern states. Follows an analysis of their considered replies, together with examples which they selected as "typical" of their current work.

The \$10,000 maximum should be borne in mind, as it modifies the answer to practically every question asked.

Answering some questions on the one-family dwelling costing under \$10,000.

ECONOMICS

What is the dominant price class in your work?

Far and away the largest group lay between \$5,000 and \$8,500. Below \$5,000 very little activity was evident—less than 9% reported any work in this price class. Above \$8,500 there was quite a bit of activity; many of those reporting indicated that a large part of their work ran far beyond the \$10,000 limit. Two facts were apparent: the increasing importance of the architect as the price rose (none reported any work on units costing under \$5,000), and the sharp decline in the unit cost of the architect's work in the past few years. (This trend seemed now somewhat reversed.)

There seemed to be no sharp regional differentials, except that reports from the Southern states indicated a lower average cost in both owner- and operative-built units. Only report of units costing under \$3,000 came from a Savannah (Ga.) builder who is erecting 25 houses for a local corporation and expects "in the next two years to erect in the neighborhood of 500 houses, the prices of which (including land) will range from \$2,000 to \$8,000." Of these, 80% will sell for between \$2,000 and \$4,000.

What income groups do you find building the one-family dwelling?

Although one builder reported that his clients lay "mainly among what is known as the working-class," the large majority found it otherwise. "Professionals," they said; "merchants and planters" (Mississippi), "average man" (Minnesota). All regions seemed agreed on this though, oddly enough, reports from New England indicated that the average was somewhat lower: "\$1,800 a year up" (New Hampshire), "\$1,500—\$2,400" (Rhode Island). That the middle class is the largest market for the one-family dwelling is clear—80% of those reporting had clients who were worth a minimum of \$2,400—\$3,000 a year.

ALABAMA



A. C. Kiely Photo

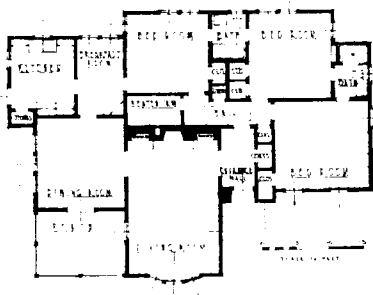

HOUSE FOR DAVE MARBURY,
BIRMINGHAM, ALABAMA
MILLER, MARTIN, AND LEWIS,
Architects and Engineers

CONNECTICUT

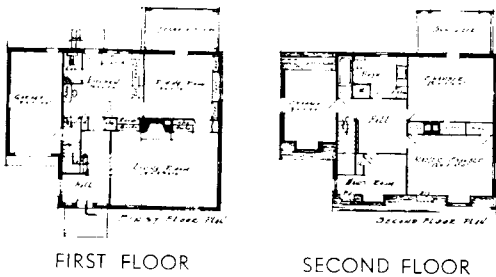

RESIDENCE,
HARTFORD,
CONNECTICUT
JOSEPH E. KANE,
Architect

FLORIDA

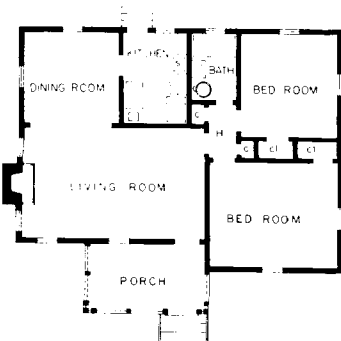
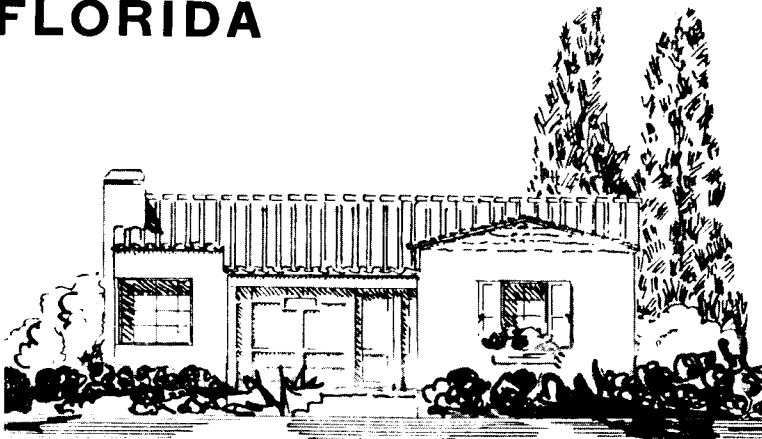

TYPICAL RESIDENCE AND PLAN,
MIAMI SPRINGS, FLORIDA
W. H. TOMPKINS, Builder

Do you anticipate an increase in this type?

On this point there was a chorus of "ayes," broken only by one or two dissenting voices. One—a structural engineer from Chicago—said "No. Too expensive to keep up—maintenance, taxes, interest, etc. My honest opinion is that only an unconscious public is building, knowing nothing of cost and expense of upkeep . . . apartments in receivership offer cheaper living."

And from North Dakota comes the shrewd comment that "the percentage of homes free from mortgages is small. Living and building costs are high in proportion to income; therefore, a large percentage of those who build are forced to resell or have the property taken over by the mortgagee." But—East, South, West—the majority of architects and builders are confidently expecting a big increase in this type of building.

or do you find other types—2-family, multi-family apartments—increasing in proportion?

Here opinion varied. Approximately 60% anticipated some activity, though not on a large scale and mostly in two-family or multi-family dwellings. The East proved most optimistic in this respect, although one New York architect warned that "another year will be required to answer this." And from Vermont the reminder that "Vermont people seem to prefer the single-family dwellings." South and West, where the apartment has always been less important, saw no signs of any important change, though from Baltimore came the report of "considerable activity in row and group housing built speculatively."

"We have had many calls for both two- and four-family houses," says an active Jacksonville (Fla.) architect, "the proportion is increasing rapidly." But from Hialeah comes a flat "No" and elsewhere throughout the South and West much the same answer: "Not in Des Moines. Single-family houses dominant" (Iowa). A Lincoln (Nebr.) architect expects "a few 4-family or small apartments this year," and mentions the conversion of large old houses into duplex apartments. From Rhode Island comes the same report: "Two- and 3-room apartments in marked demand—mostly renovated large one-family dwellings."

In your district what percentage of single-family dwellings do you find owner-built?

Estimates on this point varied from 5% owner-built around New York City to 95% owner-built in New Hampshire. Nor did there seem to be any consistent regional characteristic: from Texas came the estimate that 60% of the one-family units were owner-built, while estimates from Kansas varied from 50% to 75%. There did, however, seem to be a general feeling that the percentage of owner-built units was steadily declining, though at different rates of speed in the different regions. In this connection, there were several references to the trend among operative builders towards giving the client a wider range of choice—in terms of plan, style, construction—than heretofore; in other words, selling the house before construction started. This was particularly evident in the metro-

GEORGIA

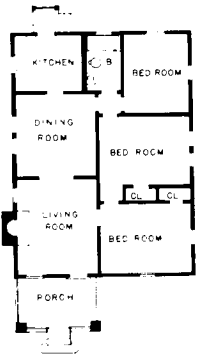

ONE-STORY FRAME RESIDENCE,
SAVANNAH, GEORGIA
CLARKE AND CLARKE, Contractors

ILLINOIS

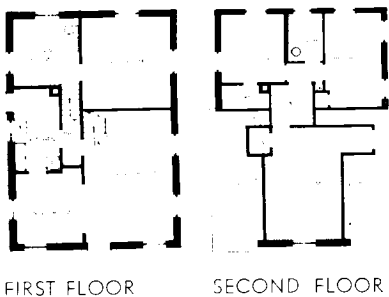

RESIDENCE, CHICAGO, ILLINOIS
ROUSSEAU AND DOUGLAS,
General Contractors

politan area of New York City where the practice is already general.

architect-designed?

No question drew a wider range of opinion than this—due perhaps to current confusion over the technical and economic application of the term. Reports from Illinois, Kansas, Texas and New Jersey gave the architect from 80% to 90% of this type of work; but the majority gave much lower estimates—10% in Alabama, 15% in Louisiana, 20% in Wisconsin.

These figures, however, merit much closer attention. Among the architects themselves the figure was generally conservative: "10% to 15%" writes Birmingham's most active firm; 25% from a prominent Nashville office; while a Miami Beach correspondent reminds us that Florida has a law requiring an architect on all houses costing over \$5,000. But, he adds parenthetically, "there is a lot of cheating." A Madison (Wis.) firm says that 20% are architect-designed, "in normal times 40%." But an active architect from Burlington (Vt.) hits an all-time low: "5%," says he.

There was, however, an important group of architects whose estimates were quite different. In answer to this question as to what percentage of one-family units were architect-designed, they gave as their considered opinion: "80%" (Dallas, Texas), "80%" (Jacksonville, Fla.), "All" (Chicago, Ill.), "80%" (Topeka, Kans.), "75%" (Hartford, Conn.), "95%" (Union, N. J.), "Nearly all" (White Plains, N. Y.). It is significant in this connection that nearly all the work of these firms lies with large-scale operative builders. And supporting this position is that of the builders themselves. "We have our own architect," says an active Georgia company. "All our houses are designed by architects" (Scarsdale, N. Y.). "Public demands good architectural design," according to one Florida correspondent, while a Long Island (N. Y.) firm has a "complete architectural division."

From this it seems clear that, because of rising standards of public taste, the *technical* services of the architect are in increasing demand; but his *economic* relationships to the building industry are changing. The architects most active in the small house field seem either to work for or with operative builders (as in the case of several New York architects) or to have built up a large-scale practice with operative builders (as in the case of a Jacksonville firm who has done plans for 48 single-family units and apartment houses for builders in the past year).

DESIGN

What "Style" do you employ most? Why?

Eighty-five per cent of the replies said "Colonial." The only regions where any other style had any appreciable sway were Florida and the West. From Hialeah came the answer "local types"; from Miami a cynical "call it Miami-Renaissance." The Westerners were more definite. Chicago prefers "English," Madison (Wis.) demands "English cottage," while Omaha (Nebr.) goes for "English brick." But the rest of the nation wants "Colonial" in all its variations.

IOWA

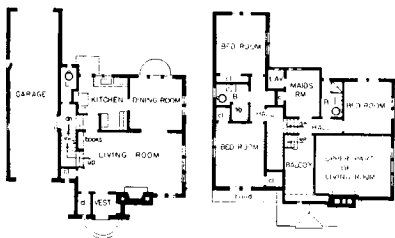

FIRST FLOOR

SECOND FLOOR

HOUSE for GEORGE GOLDSMITH,
COUNTRY CLUB KNOLLS,
DES MOINES, IOWA

RALPH E. SAWYER, Architect

What the public wants, however, and what the architect likes are two different things. Several correspondents confessed to a personal liking for "modern." Writes a Minneapolis architect: "In this climate the modern house has not been so much in demand but there will be those who will want this type in a year or two. Have had several clients asking about it . . ." And a Lincoln (Nebr.) architect confesses to having several houses under construction "in which I've departed a little more from the traditional Colonial . . . believe they will be quite successful." In the same fashion an active Nashville builder regrets that "the South seems loath to break away from old customs," while our White Plains correspondent "regrets the inability of the public to feel the need for more modern forms of design, but so far no manufacturers have produced substantial improvements to which traditional styles cannot be adapted." But a Miami Beach architect observes: "Now we run to extreme modern—glaring white, flat roofs, large windows—all demanded by Northern people and all 100% out of place for physical reasons."

It was apparent that sound business considerations underlay this question of style. Almost without exception the answers listed four reasons for the use of any particular style: (1) high consumer preference; (2) relative economy; (3) local tradition; (4) continued popularity (resale value).

LOUISIANA

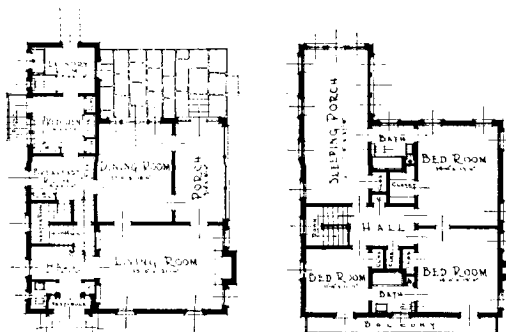

FIRST FLOOR

SECOND FLOOR

HOUSE for
WALTER BARNETT,
NEW ORLEANS,
LOUISIANA

PAUL G. CHARBONNET,
Designer and Builder

Do your clients express any preference for "open" planning—i.e., more intimate connection between house and grounds?

A majority—about 65%—said yes; but this trend had distinct regional characteristics. The West, for obvious reasons, felt that economy of construction and maintenance demanded a fairly compact plan. A Chicago firm felt it "immaterial; cost is the governing item," while most Nebraska, Minnesota and Kansas reports said merely "No." The East, on the other hand, was pretty generally agreed on the trend towards more open planning. Strangely enough it was the South which was least favorably inclined. A Baton Rouge (La.) firm finds no trend "but advocates open planning" for geographic reasons, while conservative Baltimore sees "no noticeable" tendency in that direction. New Orleans reports "yes," while our Miami Beach cynic says "yes, if it doesn't cost any more."

larger doors and windows?

A large majority, regardless of region, said yes.

larger and fewer rooms?

Nearly all saw a demand for larger rooms (especially living rooms); 50% for fewer rooms combining two or more functions.

elimination of halls?

A scant majority said yes, but several shrewdly spoke against their elimination at the risk of making traffic arteries of the main rooms.

MARYLAND



Blakslee-Lane Photo

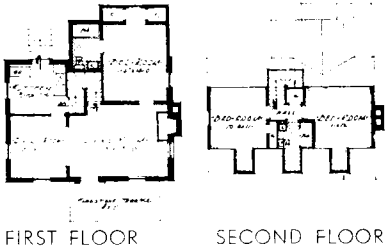

RESIDENCE,
BALTIMORE, MARYLAND
KENNETH C. MILLER, Architect

NEBRASKA



1. HOUSE for MR. WRIGHT,
LINCOLN, NEBRASKA
2. HOUSE for WORTH MINNICK,
LINCOLN, NEBRASKA
N. BRUCE HAZEN, Architect

is there any demand for separate dining rooms?

An overwhelming majority (93%) said yes. "Very necessary" (La.); "emphatically yes" (Md.); "practically always" (Ala.); "definitely" (Tenn.). But a Bismarck (N. D.) builder says "no," while an Indianapolis architect says the demand "is not as insistent as it was five years ago."

terraces and porches?

Except in the West, there was a strong demand for both porches and terraces; the West seemed doubtful about terraces, 60% for porches.

basement?

East and West were almost unanimously for basements, "though opinion is changing" in Indianapolis. In the East there is a current demand for basement recreation rooms (N.J., N.Y.). As would be expected, the South—especially the far South—is against them. "No need" (Fla.), "hardly ever" (Texas), "no, due to soil conditions" and "elevated basements" (La.). But several correspondents remarked that "new-type heating systems are modifying this demand" (Ala., Minn.).

more than one bath?

Yes. 99% agreed on this demand, the only limiting factor being cost.

attached garage?

Yes. Only two reports disagreed and they gave the sound reasons of small lot size (Ill.) and insurance penalties (Ala.).

Is there any trend towards more built-in equipment—kitchen and pantry cases?

There was 100% agreement on this score. "The more the better" (N.J.), "more complete all the time" (Iowa).

wardrobes?

Two-thirds of the report saw an increased demand for wardrobes. This was most marked in the West, least in the South. The canny East was all for them "if they didn't cost too much" (R.I.). But Maine said definitely "No."

other built-in furniture?

A majority saw demand increasing here also, although on more or less traditional lines. "Bookcases, toy cabinets, window seats" (Wis.), "corner cupboards" (Nebr.), "dressing tables in bathrooms" (Texas, Okla.), "telephone niches, shelves" (N.H.). In Alabama this sort of equipment is reported as "costing too much."

Do your clients demand orientation for sunshine?

Yes, everywhere except in New Orleans where "small

NEW HAMPSHIRE

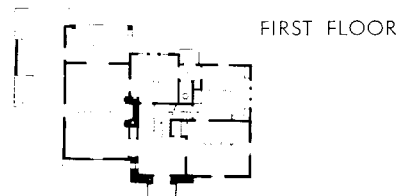

FIRST FLOOR

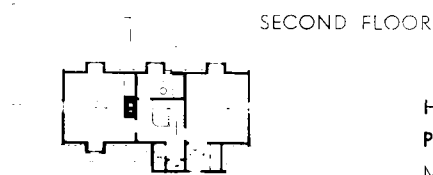

SECOND FLOOR

HOUSE for DENIS L. LONG,
PORTSMOUTH, NEW HAMPSHIRE
M. E. WITMER, Architect

NEW JERSEY



C. L. Warren Photo



FIRST FLOOR



SECOND FLOOR

RESIDENCE, SUMMIT, NEW JERSEY
EUGENE A. McMURRAY AND
EMIL A. SCHMIEDLIN, Architects

lots don't allow much leeway" and in Miami where they "try to create shade."

for prevailing winds?

This factor apparently gets attention everywhere to greater or less degree. In Florida it is "100% necessary" and "always done." In Birmingham "southern exposure is highly desirable," and in Nebraska the northwest winds are coolest in summer.

for view?

"When there is one" (N.J.), "lots for small houses have no view" (Fla.), "not important" (Okla.), "where obtainable" (N.Y.), "of course" (Ind.).

STRUCTURE

What type of structural system do you most commonly employ—frame, brick, concrete, metal?

It is apparent that the essential structure of this type of dwelling is still conservative; that there is a keen interest in new structural systems and materials; that first cost so far has prevented any appreciable use of them.

Frame 50%; brick veneer 25%; brick 20%; all other types 5%. This held true for all regions, though there were some surprising variations. For example, the East estimated the frame-brick ratio at 4:1, while South and West gave it as being 2:1 or thereabouts. Brick veneer construction ran second to wood, especially in the South and West, where its popularity seems much higher than in the East. Concrete structural systems, except in Florida, seem seldom used—"occasionally" in Iowa, "for its firesafe features" in Vermont. But in Florida there seemed to be a wide use of precast concrete systems—blocks, joist, floor slabs—as well as some monolithic pouring.

why?

It was apparent that the relative popularity of these various systems was conditioned first of all by cost. Next in importance came direct labor costs (in erection), public acceptance and—a poor third—consistency with tradition. Quite frank were the correspondents in admitting that such factors played a far larger part in selection of a structural system than did the fire-, earthquake-, or tornado-resisting properties of the newer processed (industrialized) systems.

In these structural systems are you using any technical innovations such as: New materials (plastics, plywoods, metals, etc.)?

By and large there was surprisingly uneven use of nationally-advertised new materials; first in importance, however, were wallboards—plywood, gypsum-, fiber-, and asbestos-boards. "Plywoods in playrooms" (Conn., Iowa), "only occasionally" (Va.), "veneered plywoods in recreation rooms" (Ill.).

NEW YORK

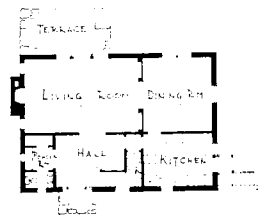

FIRST FLOOR

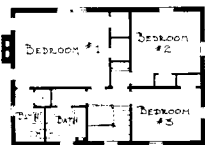

SECOND FLOOR

GEORGIAN COLONIAL
RESIDENCE,
HARTSDALE,
NEW YORK
DOROLYN BUILDING
CORPORATION

shop-fabricated units (plywoods or metal floor- and wall-units, etc.)?

Here again the trend was markedly negative. Less than 5% of the answers indicated any use of shop-fabricated units. An active Savannah (Ga.) building firm said "Some. We manufacture most of our materials"; and a New Jersey architect said "wall units about 25%" without specifying what type. Several correspondents indicated that this was no case of simple prejudice but rather the result of local conditions: "Our labor supply is best suited to traditional methods" (Ala.), "costs too much" (Ill.).

precast concrete (wall-units, floor joist, etc.)?

Although 90% replied in the negative, there were indications of activity in widely-separated parts of the country. From New Hampshire came a cryptic "not yet;" but Florida—impressed with recent hurricanes—is experimenting. A Miami architect finds "poured concrete corners with cement block walls" satisfactory, and a Jacksonville firm uses "concrete slabs on grade level, properly insulated against moisture" to foil termites. In Vermont, Minnesota and Nebraska there is "some" use of precast joist; and in White Plains (N.Y.) and Nashville (Tenn.) some use of precast wall units.

any other?

From Indiana, Iowa and Wisconsin come reports of satisfactory use of steel joist and steel framing systems. Prefit or unit windows were mentioned (Minn., Vt., Mass., Ill.) as increasingly popular, while glass brick and structural glass were reported as being increasingly popular in Massachusetts, Florida and Texas.

Have you made any use of prefabrication?

Most apparent was the fact that no two people agree upon what the word "prefabrication" implies—technically, commercially, socially. 85% of those reporting said "no"; but not content to leave it there, many undertook to elaborate. Although a Malden (Mass.) architect "designed 200 small prefabricated houses in 1923-25" he has done none since; and from Hartford (Conn.) "there have been erected a few prefabricated homes in this section. These have had more adverse criticism than favorable." A White Plains (N. Y.) correspondent describes himself as pleased with "one house entirely in precast blocks, joists, slabs and special stair and lintel units." From a Nashville architect: "Shop overhead seems to kill practicality so far." From Miami Beach: "We have well studied physical conditions here as to heat, dampness, heavy rains, winds, etc.; they prevent our playing with innovations."

Do you use insulation against heat and cold? What type (mineral wool, aluminum foil, wallboards)?

This question drew a 100% affirmative answer, with Florida and Louisiana stressing the importance of in-

OKLAHOMA

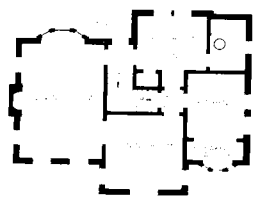
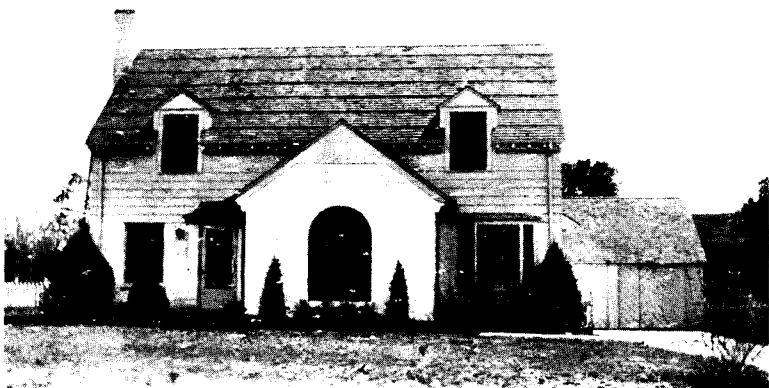

FIRST FLOOR

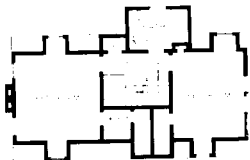

SECOND FLOOR

NEW ENGLAND TYPE RESIDENCE,
TULSA, OKLAHOMA
L. W. NIX, Architect

OKLAHOMA

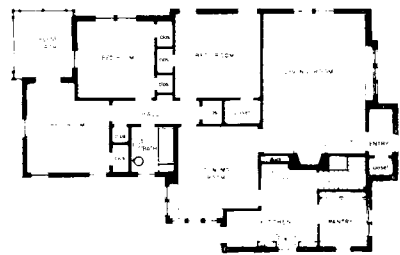

BRICK RESIDENCE, TULSA, OKLAHOMA
L. W. NIX, Architect

TEXAS

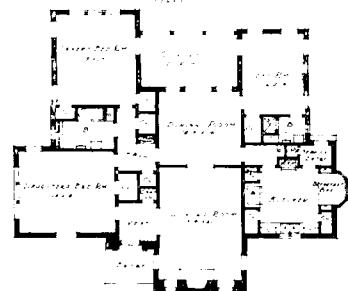
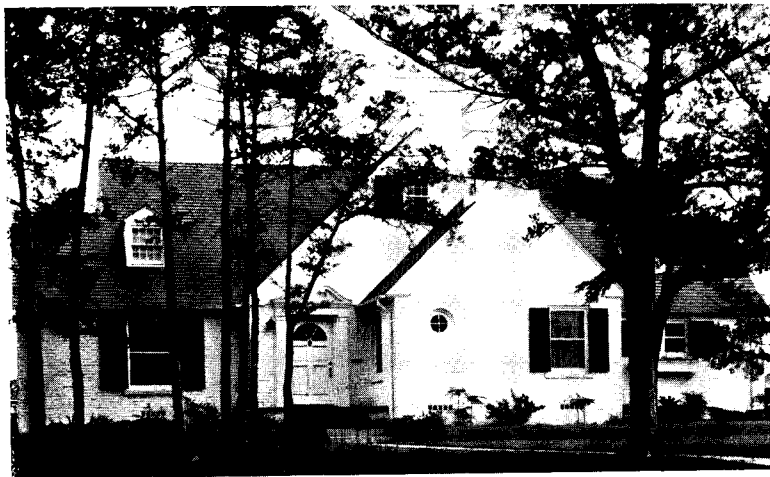

HOUSE for MR. and MRS. W. F. ATKINSON, DALLAS, TEXAS
HAL O. YOAKUM, Architect

sulation against sun heat. All types were popular, mineral wool having a slight edge on the others.

Do you use insulation against sound-transmission? What type?

About 50% indicated that they did, but seemed to attach no special importance to it. From Florida the comment: "With houses so close and windows always open, soundproofing useless in walls." There was some indication that this problem gets more attention in larger houses and apartments.

EQUIPMENT

What type of heating plant is most requested (vapor, hot water, hot air)?

Demand varies markedly with the regions according to these reports. In the South and West demand for hot-air systems is overwhelming—about 5:1 in relation to all other types. In the East, however, vapor and hot water remain the standard types, with hot air a poor third. Only in Florida is there any general use of unit heaters—gas, electric, oil.

Do you find much demand for systems which circulate the air?

There was a strong demand for circulated air; it is apparent that the old gravity-feed type is being supplanted by forced-feed—because of severe winters in the West, hot summers in the South. But even in the East, stronghold of steam and hot water as primary heat sources, circulated air is very much in demand. Lowest estimate was "20% of all jobs" from Rhode Island.

clean it?

The demand for this feature was practically 100%.

humidify it?

Both East and West seemed to attach more importance to this feature than the South, where it rated about 50%.

refrigerate it?

In the East 80% saw no real demand for refrigeration. "Too expensive" (Conn.), "some inquiries" (N.H.). In the South, however, there was keen interest. "Plenty of inquiries" and "provide for future installation" (Okla.), "wherever possible" (Tenn.), "not in this price class" (Tex.), "great deal of interest" (La.). But in spite of this, only two architects reported actual installations. In the West it was much the same story: "cost prohibitive" (Kans.), "cost too high to date—just highly recommended" (Wis.), "demand good but cost too great" (N.D.).

What type of fuel (coal, oil, gas, electricity)?

Varying by regions according to cost and availability.

VERMONT



HOUSE for WILLIAM HAZLETT
UPSON, BURLINGTON, VERMONT
HOWARD E. FIEDLER, Architect

the most-used fuels (in the order of their importance) were oil, coal, gas, electricity. In the East oil led coal only slightly, although a New Jersey architect estimated that 85% of his houses used oil. In the West oil was a clear winner with gas a close second, coal a poor third. In the South the proportion was about even, with a wide use of gas in the southwest (Oklahoma, Texas, Louisiana) offset by coal in the southeast. Only in Florida was electricity important in heating.

Do you use any departures from traditional fenestration (double glazing, fixed windows, glass brick, etc.)?

Probably due to climatic conditions the West showed a keen interest here. Practically every answer indicated that western architects and builders are dissatisfied with traditional fenestration. "Double glazing not very satisfactory but something needed" (Nebr.). "Just beginning to, but troubled by condensation between glazing" (Wis.). Fixed windows are increasingly popular in Kansas, glass brick used in Wisconsin and Kansas. "Storm sash on everything required" in Nebraska. The South seemed content with the old-fashioned sash and casement, except for "slight" use of glass brick in Florida. The East reported double glazing and storm sash as "often necessary," Maine, not to be outdone, having used prefabricated weatherstripped windows.

What do you think of the possibilities of standardized, mechanical units such as prefabricated kitchens (General Electric, American Radiator Company), prefabricated baths (Phelps-Dodge) or prefabricated bathroom units (American Radiator Company)?

Although all sections reported the demand small in this type of construction (greater in apartment and multiple-family units), comments for the future were optimistic, with the East somewhat skeptical. Here, too, price was an important consideration. From New York: "Very poor at present. Education to public, lower cost, will bring use in more frequently." Rhode Island. "No flexibility of design and wall treatment." The South responds with "good possibilities" (Va.), and "too costly as yet" (Fla.). "Demand will increase," according to Minnesota, and "very good, and in demand, if within reach" (Ill.).

IN GENERAL

Nobody recognizes more than the designer the fact that cost is the determining factor in design. From a Maine architect comes this statement: "We, in Maine, are probably rather conservative, but we have to look to past performances and records for our livelihood; therefore we cannot afford to experiment with materials. If we could build purely as experiment we could probably devise uses of new materials and new methods, but I doubt that any architect has the right to try new things at the owner's expense. Therefore all we can rightly do is to lay the facts before the owners and let them fully understand that the architects cannot assume responsibility for untried and untested materials and methods."

In agreement, but more emphatic, is this Madison (Wis.) firm: "During the past 6 years there has been too much bunk put out on the public without more thorough experimentation before it has been put on the market and greatly advertised. We have had to spend more time and energy to settle on what not to use than what to use. The manufacturer is inclined to make too many wild claims for his product which—when the human element is taken on to put it in place and the actual using conditions are forced upon it—falls way below the performance pictured for it. About 50% of the stuff leaves an owner with a feeling that he was properly gypped either in performance or price or both in the final analysis." And short and to the point is "I like experimentation with new materials, structural and decorative, but it always costs more and seldom justifies the added cost in the eyes of the client."

WHAT THE CONSUMER DEMANDS OF THE ARCHITECT

JOHN CUSHMAN FISTERE

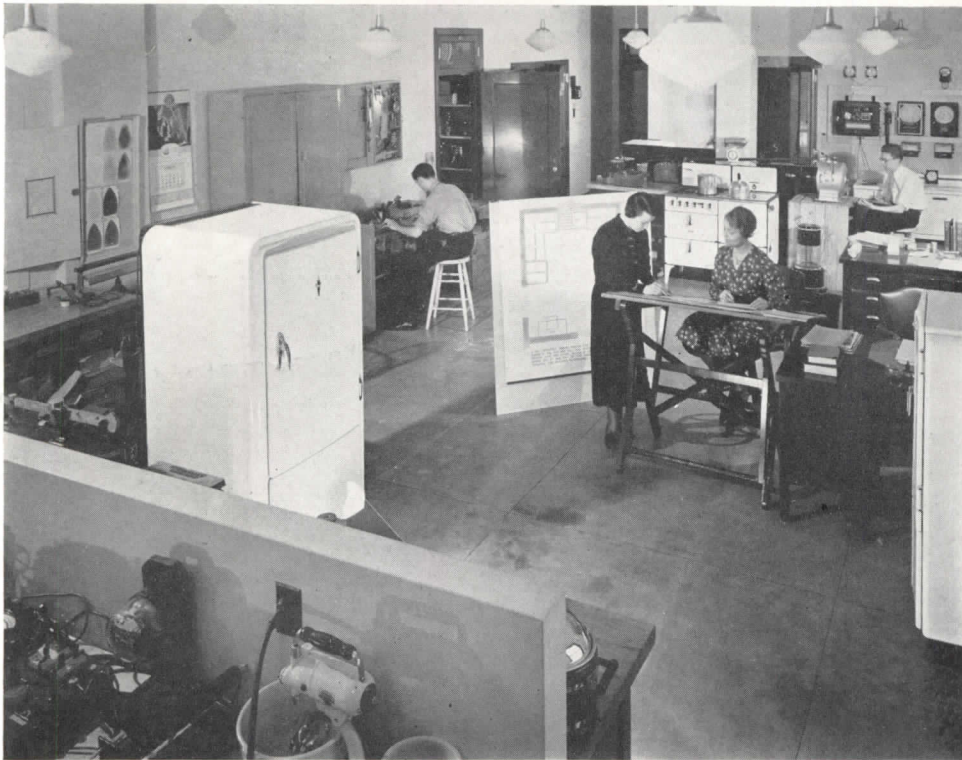

As Architectural Editor of the Ladies' Home Journal, John Cushman Fistere directs this research staff in its daily analysis of household equipment, furnishings and general planning problems. Mr. Fistere was formerly a staff editor of The Architectural Forum.

Mr. Fistere argues that women, as consumers of housing, are a basic factor in the industry.

Although architects may not believe it, every woman knows a lot about houses. It's not the kind of professional knowledge that goes with a beard, but it has just as much to do with the creation of a good, livable house.

It is unfortunately true that women and architects speak different languages—one the language of housekeeping and the other the language of house-planning. Architects know practically nothing about the first except that it's expensive, and women know little more about the second except that blueprints are fascinating to look at. This absence of a common meeting ground is at the root of most of the troubles between the two. It would seem well within reason that along with the useless projects that architectural students sweat night and day over, they might be given courses in the routine of running a household. While that suggestion may have practical difficulties, it would certainly result in a larger percentage of contented clients.

Discussions between architects and their women clients are further complicated by the fact that few women can visualize what their homes are going to be like from the drawings. Dimensions mean practically nothing to them, except in terms of a place big enough for all the brooms, plus the vacuum cleaner, plus the pails and the dustpans, plus the wide assortment of wet and dry mops that seem to accumulate. A woman can't tell you whether you have given her enough closet space for herself until she has had a chance to see whether her clothes will all get in or not.

It's true, too, that a woman's idea of a good house and your idea of one are likely to be two different things. While your aim undoubtedly is a slick, well-organized plan, she doesn't care whether it's well organized or not. She never heard of a parti, and while your own self-esteem is to be respected, she has to live in the house. While you may be working for economy and efficiency, there are other household factors a woman respects more—comfort and convenience, for instance, or that usually neglected idol—Livableness.

She has a mild appreciation for your efforts to save her steps and to save her husband money—but those are not the reasons she wants a house.

I think that the kitchen best illustrates the divergence of opinion between what women want and what architects give them. It has been pretty generally believed during the last few years that a small, compact kitchen where everything was within arm's reach was the ultima Thule of kitchen planning. As a matter of fact, it sounded so logical that many women economists spent their days counting steps, trying to eliminate needless activity.

In a recent issue of the *Ladies' Home Journal*, however, Grace L. Pen-nock expressed a belief that probably there were many women in the country who resented the attempts to make their kitchens over into factories. She pointed out that despite all the attempts to reduce the preparation and disposal of food to numbers of steps, kitchen activities were seldom carried out in production-line order. The constant interruptions during the day upset the routine and left the step-counters with

a pretty theory but not much else.

The response to her article was unusual. One of the most interesting letters came from novelist Rose Wilder Lane who said:

"May I swell the cheers for the article by Miss Pennock, 'Growing Pains?' The most sensible article on kitchens that's ever been printed. I want to remodel my farmhouse some day, and I'm daggers drawn with architects about the kitchen. The whole pressure is toward forcing on us Middle Western, middle-class, middling women who love kitchens the kind of cold scientific plant that maybe haughty servants, who have servants, like to work in; I wouldn't know. I want a kitchen that's not only efficient but fun to cook in.

"A place where the boys can bring their friends to raid the icebox and sit around and talk basketball with their mouths full; and where I can sit down to check up the grocer's slips—a little desk and a shelf for cookbooks; and a view that isn't over the sink; and a place to have a potted plant—nothing is handier than parsley growing in the kitchen; and room, when friends arrive just as the French bread's coming out of the oven, to tear a loaf apart and butter it and eat it. At the same time, I won't want the extra mileage of grandmother's kitchen. Try to tell that to an architect:

"I congratulate you-all on raising the banner for a warm-hearted kitchen. I hope it leads a great crusade."

To supplement her article Miss Pennock conducted a questionnaire among housewives, trying to determine what activities most women carried on in their kitchens besides the preparation and disposal of food. These are the results.

Do any activities take place in your kitchen aside from cooking, dishwashing and other food matters?

Yes	373	No	68
If so what is done there?			
Eating	321	As a resting place	2
Washing	144	Listening to radio	1
Entertaining ..	126	Growing flowers	1
Children's play	92	Others (not specified) ...	8
Ironing	91	Reading	1
Sewing	79	Bathing	1
Lessons-study .	5	Writing	1
Canning	5		
Keeping menus, acc'ts	3		

Do you like the idea of a kitchen which provides for more activities?

Yes .. 260 No .. 172 No answer .. 7

Or do you prefer a kitchen for food purposes only?

Yes
 129 |

But kitchens aren't the only things that women have strong opinions about:

Dining rooms. It is a well-recognized truth that on the basis of use during the day the dining room is an uneconomic space in most small houses. However, uneconomic though it may be, most women refuse to be interested

in the combination living-dining room. Even though they may eat only one meal a day in the dining room, they want that meal to be a family gathering, and eating in the living room apparently won't do for such occasions. The problem for architects is to discover other uses for the dining room and not to eliminate it completely.

First floor bedroom. Another frequent complaint from women is the lack of a bedroom and bath on the first floor of a house. It has dozens of possible uses—as a guest room away from the family, as a room for a father or mother-in-law, when that apparently inevitable day arrives. A good place to relax for a few minutes during the day—these are just a few of the possible functions of such a room.

Porches. And although few architects like to indicate them in their drawings, the screened-in porch is still a very definite part of family desires. Terraces and open decks are wonderful things to talk about, and eating outdoors is invariably pleasant on good days, but women recognize such things as rainy days and mosquitoes. And while they dislike the screens as much as architects do they are willing to face the fact that they make the space more usable.

Closets. Then there is the great problem of closet space—how many to have and where to locate them. Despite what it may do to the plan, it is imperative, from the woman's standpoint, to provide two closets for any room which two people are likely to occupy. Most architects feel pretty pleased with themselves if they provide two closets in the master bedroom and one in each of the others, but usually this is far from sufficient. Of course, I realize that closets have the nasty habit of breaking up a compact plan, but from the woman's standpoint they are always worth their space.

Broom closet. Another preference of women with respect to closets is the location of a broom closet on the second floor as well as on the first. There is just as much cleaning upstairs as down and if space can be provided it is very handy.

Laundry. Location of the laundry is a question on which women don't seem to agree. In some families a laundry adjacent to the kitchen is far preferable to one in the basement, but it's a matter of individual taste.

Furniture. In the opinion of women, architects are too frequently guilty of

TAKE THE KITCHEN, FOR INSTANCE:

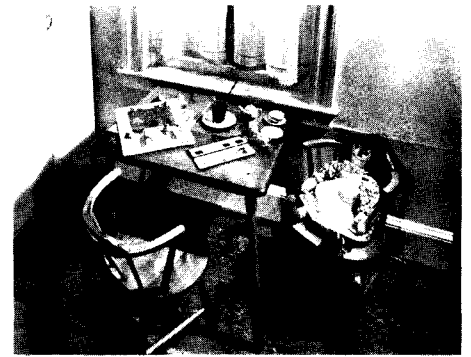

How many architects provide a play space in the kitchen?



A sewing machine in a kitchen may seem much more incongruous to the architect than to the woman who does her own cooking and sewing.

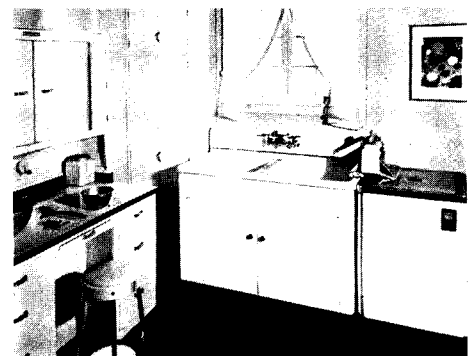

"Many a woman wants a laundry right in her kitchen, despite what precedent and architectural opinion may say to the contrary."

the fundamental error of failing to provide enough unbroken wall areas for the disposition of furniture. This, of course, is particularly true in the living room where often the only place for a sofa is in the middle of the room.

There may be other recommendations that most women would subscribe to. Such things as built-in cupboards are always a constant joy, but all or none of these might apply to the particular woman who is your client. It remains for the architect, as it did before, to find out just what every woman wants.



Photographs by Stephen H. Willard

GENERAL VIEW

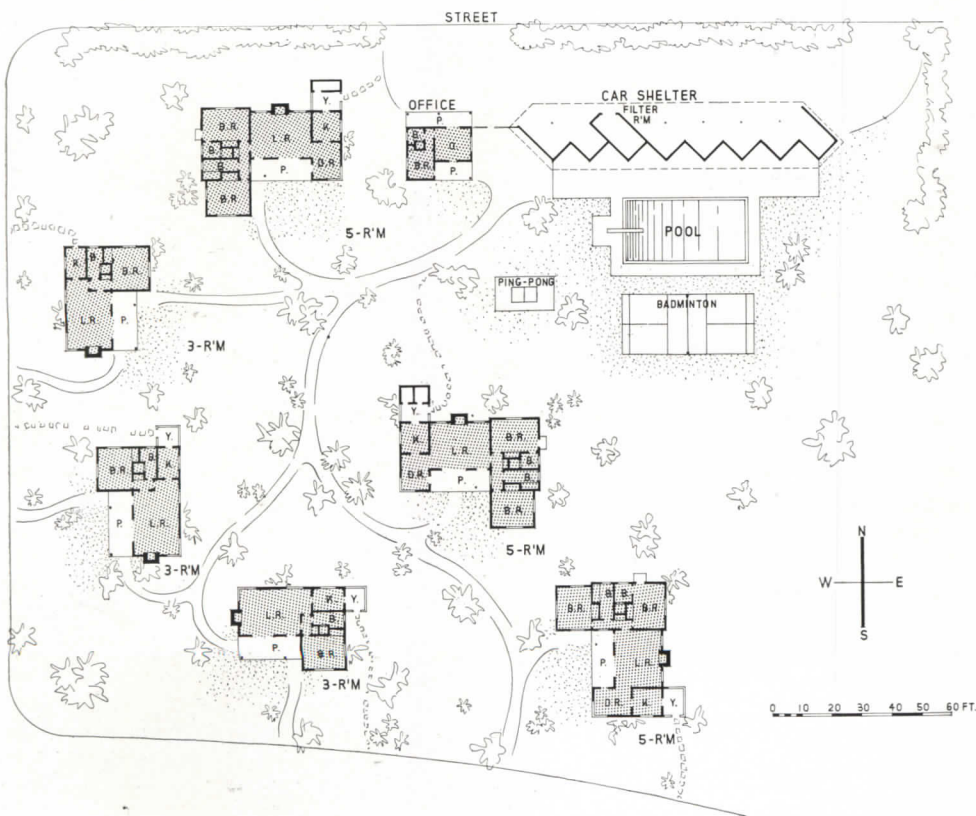

PLOT PLAN

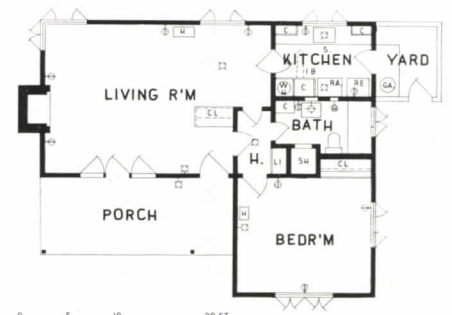

THREE-ROOM HOUSE

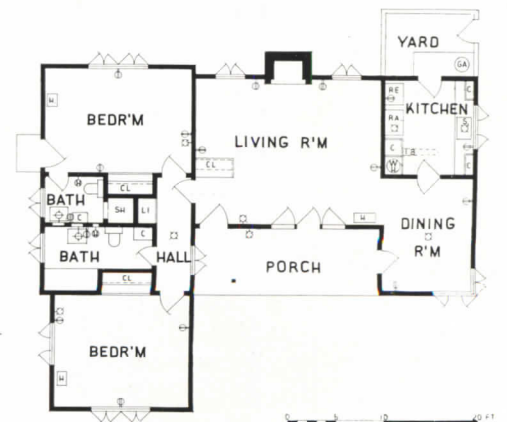

FIVE-ROOM HOUSE

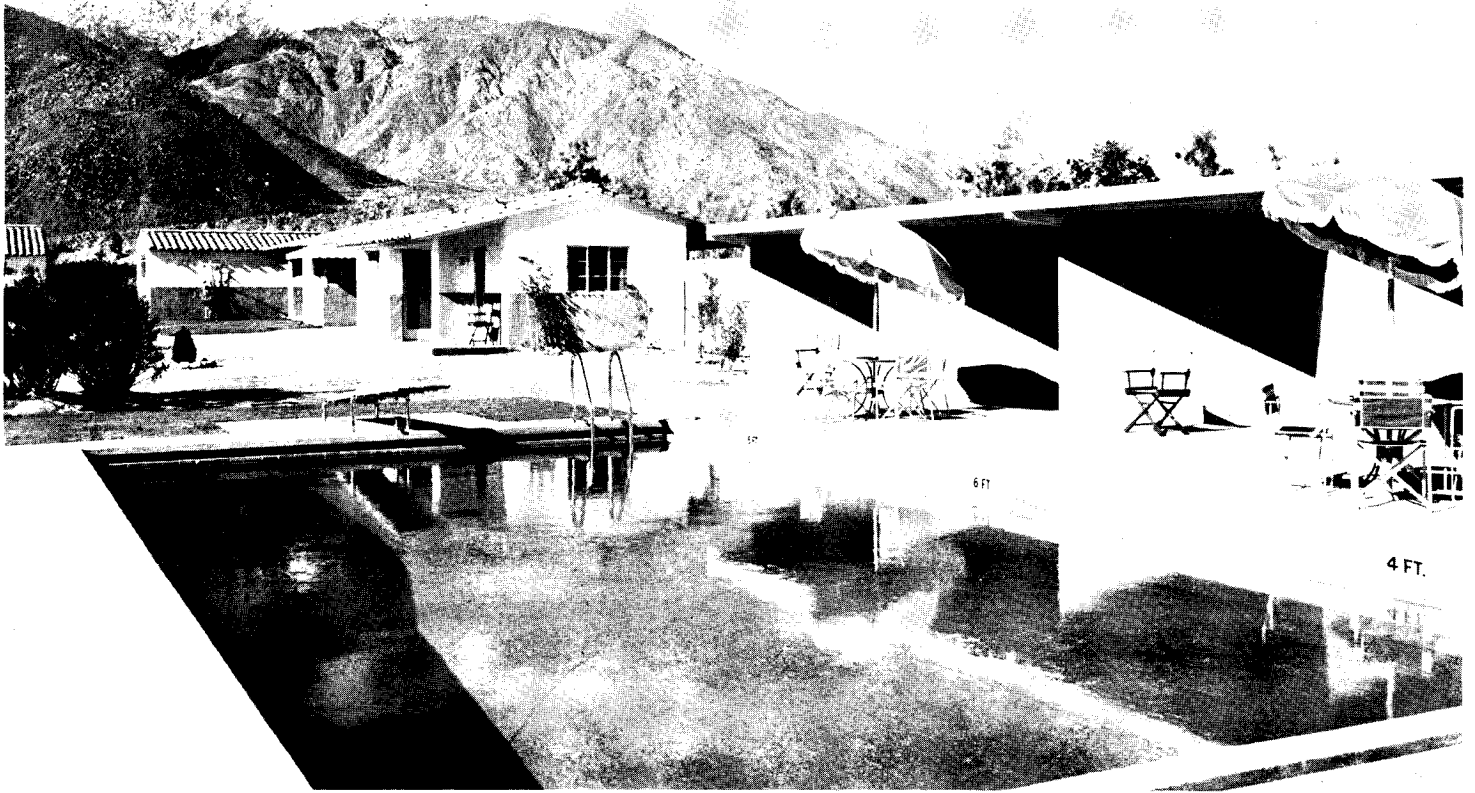

SWIMMING POOL

"La Siesta" is a residence court of six houses with complete residence facilities under one ownership and operation. Rent includes complete room service, and may extend over various periods of time.

The swimming pool is ingeniously combined with the car shelter, and is for the use of all tenants. Nearby, facing on the main thoroughfare which is one of the boundaries of the development, is the office for information and registration. There are no power poles to mar the view as all utilities are underground.

Two types of houses are used, three-room and five-room, each so placed on the property as to assure privacy for occupants, and to avoid monotony for onlookers. The exposures of the various houses played an important part in their planning. Each room has windows on at least two sides. The living room connects with the porch by large French doors, a very desirable feature in the desert climate of Palm Springs. The floors are of cement, with a colored finish. The walls are frame and stucco, and the roofs are of tile with a green color baked on.

The living and bedrooms are heated by vented gas console heaters, and the baths by radiating type electric heaters. The windows are all-steel casements.



Exterior of Typical Five-Room House



Interior of Same House

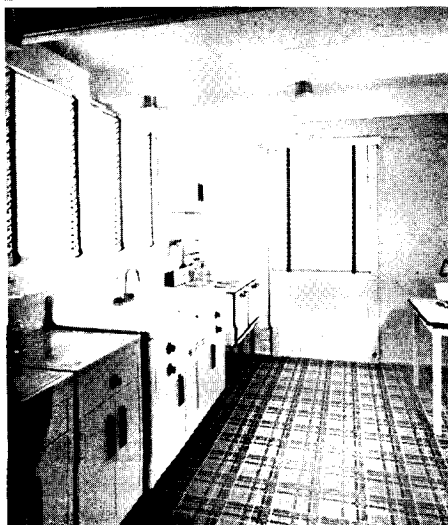
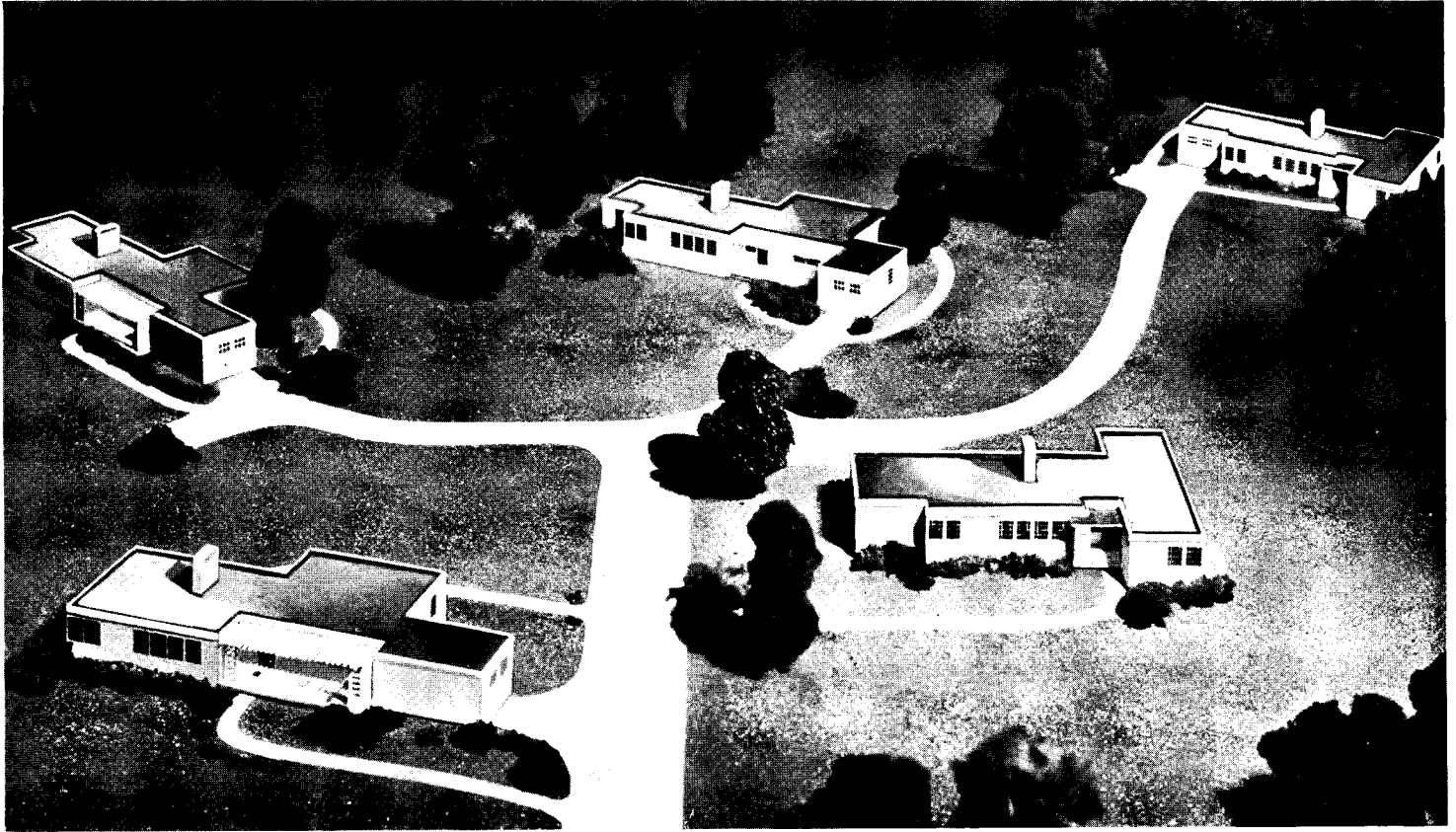

Sponsored by an operative builder in a Chicago suburb is this development of five prefabricated dwellings. They were designed by the staff of General Houses, Inc.,* erected for the builder and sold on an individual basis.

These steel-frame houses are placed on a standard reinforced concrete slab. The outside walls and interior partitions are made in panels, supported by the frame. Similar panels of heavier construction make up the combined roof and ceiling. When shipped, the panels are already insulated, and exterior and interior surfaces are prepared for painting. The exterior surface is asbestos cement.

The longest span practical in the present system is 15'-10". At present General Houses sells only single-story houses, but structural systems for two-story buildings will be available shortly. The purchase price includes complete equipment—heating, lighting, kitchen, and bath—as well as linoleum, carpeting, etc.: only landscaping and excavating are not included. The present General Houses line includes models ranging from \$3,400 to \$8,500, varying according to local labor and rough material costs.

Other General Houses are at South Bend, Indiana; Port Washington, Long Island; and Highland Park, Illinois.

* General Houses offers no design service, only a selection of standardized plans. A complete system affords sufficient flexibility for individual owners who desire their own architect.

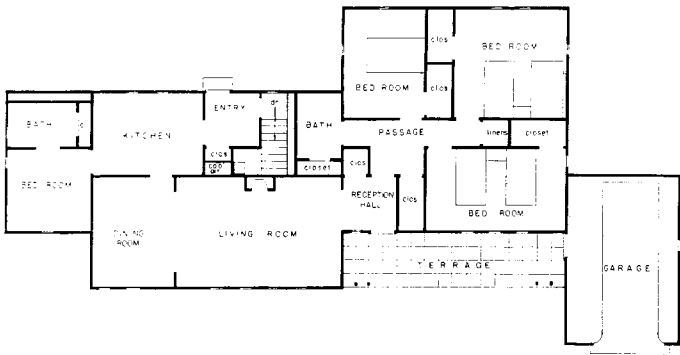

Seven-room house with terrace and attached garage. Steel casement windows provide maximum air and light.

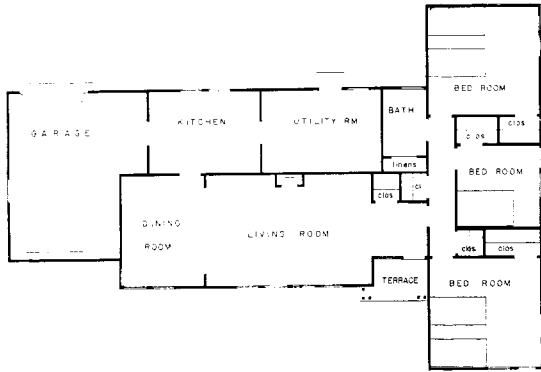
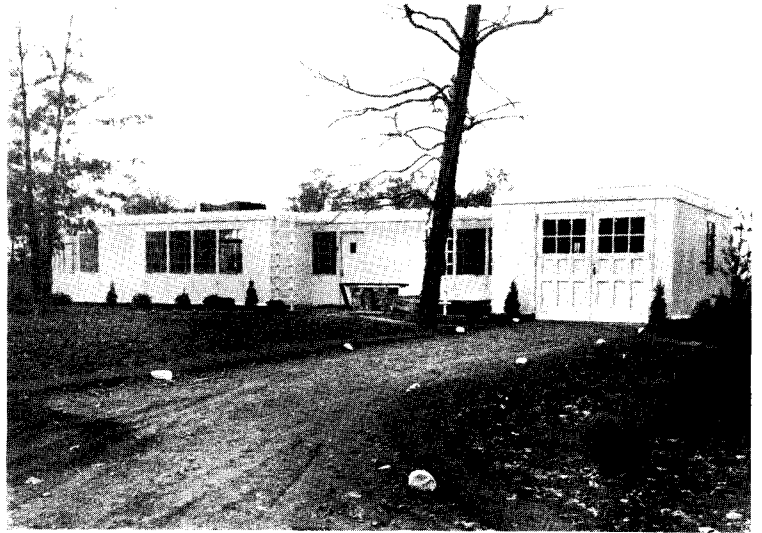

Kitchen and utility space are grouped together for convenience. Equipment in these rooms is an integral part of the houses, making for efficiency.

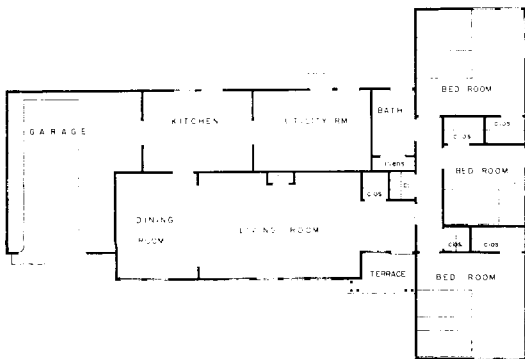
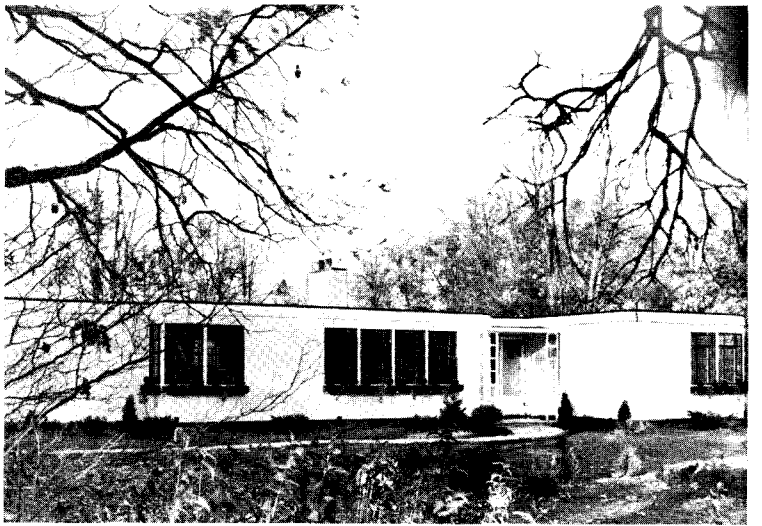

Same layout as above, but with garage entrance reversed. Simplicity of design.



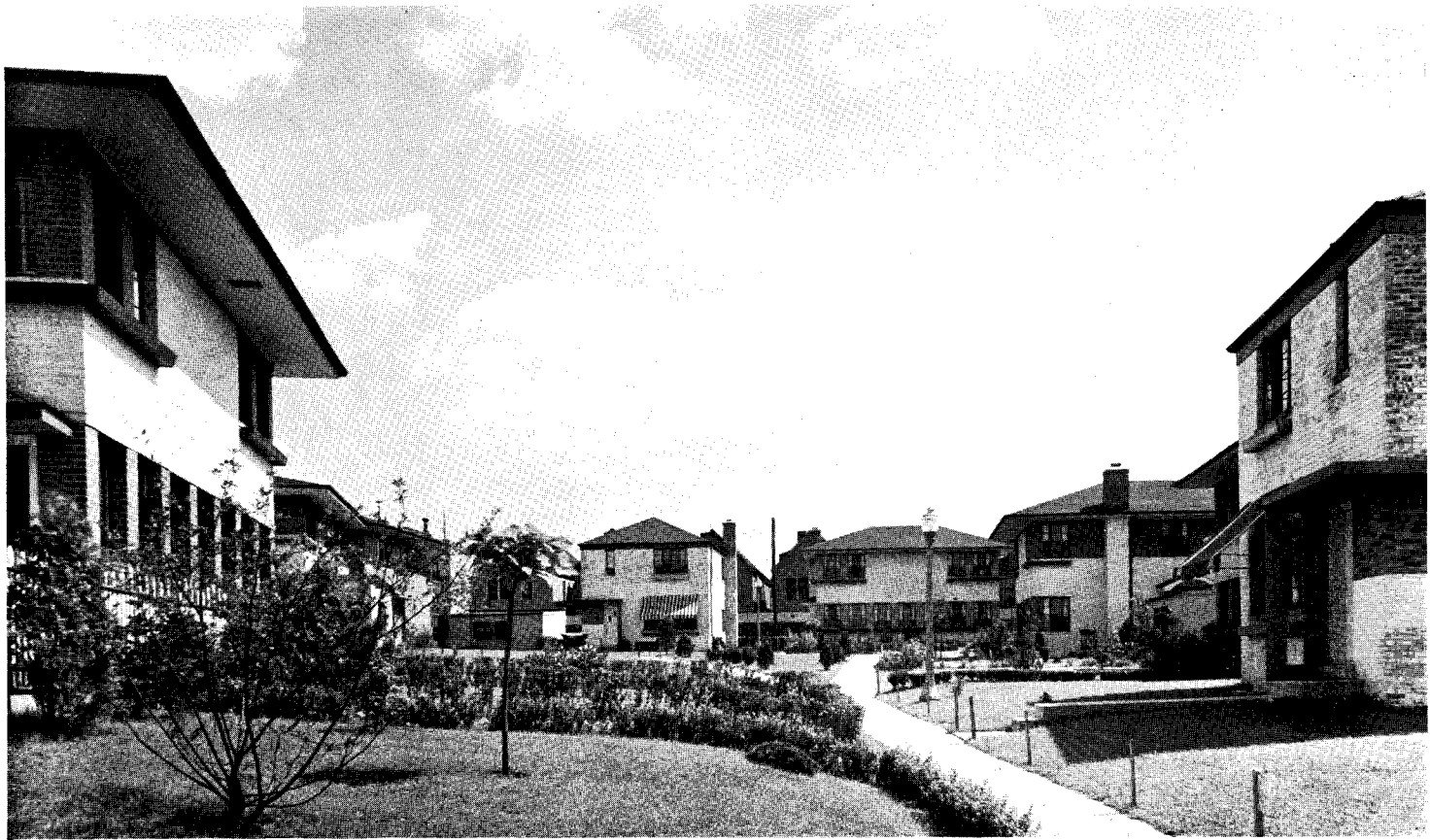

GENERAL VIEW, COURT SIDE

Photographs by George Van Anda

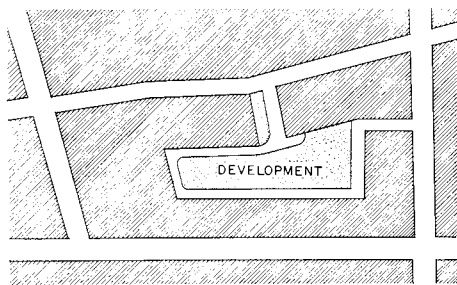

Above plan shows location of development in relation to the city block.
Right: Plan of entire development.

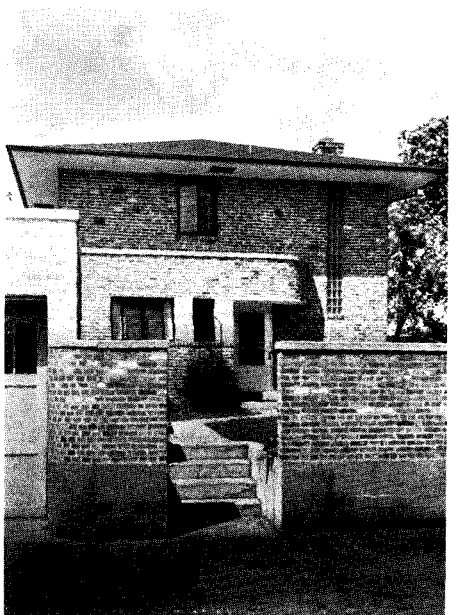
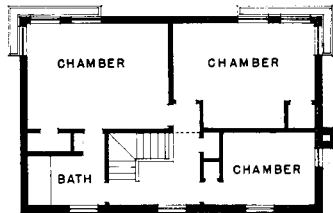
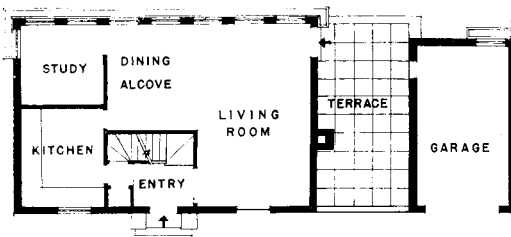
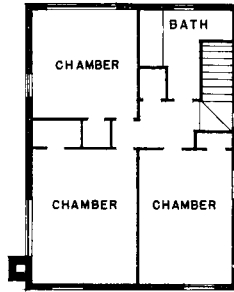
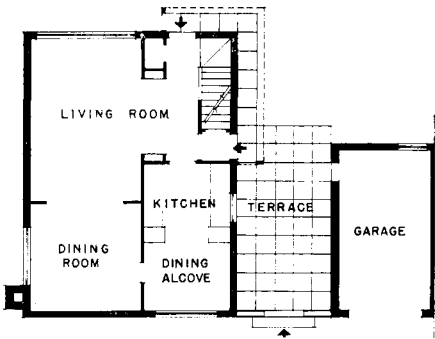
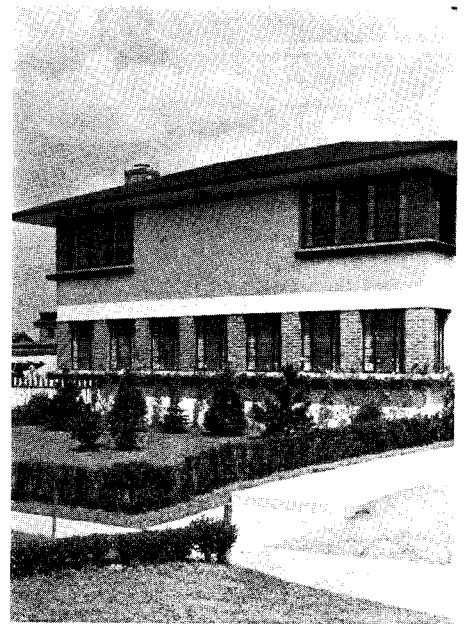
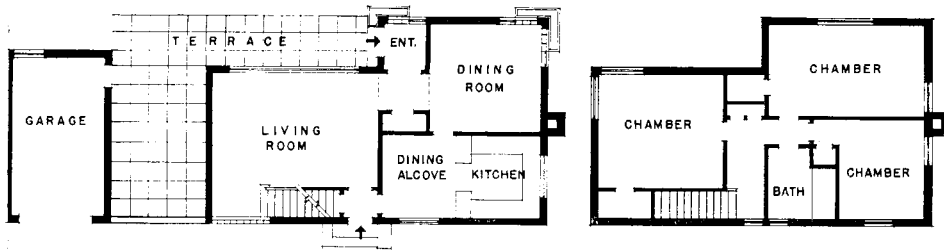

This new rental group in New Jersey involves an unusual use of the interior of a large city block. The houses face inward around a central court, each having private garage, service, etc., and an unusual degree of privacy.

The houses are all two-story, and the size varies, some having six and others seven rooms. All have excavated basements and recreation rooms. The materials used are in some cases brick, in others brick and frame. Color plays an important part, for some are painted brick

with a contrast of natural color brick, and accents in red, blue or green in the color of the flower boxes. The timber and brick houses have faced brick, with the timber painted in light colors. The roofs are of asphalt shingles in a uniform dark gray tone.

The windows are steel casement and unusually large, giving a maximum of light and air. The floors are hardwood throughout in all of the houses.

Right: Upper picture shows garden elevation of typical six-room house of painted and natural brick. Center and lower views give different surface treatments. Left, above: Plans of several typical houses.

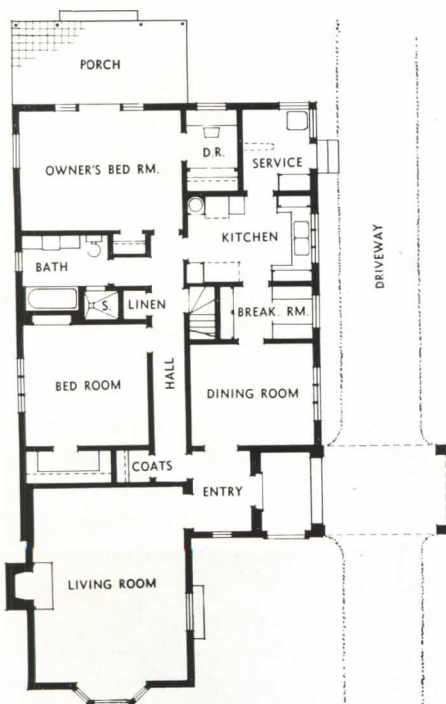
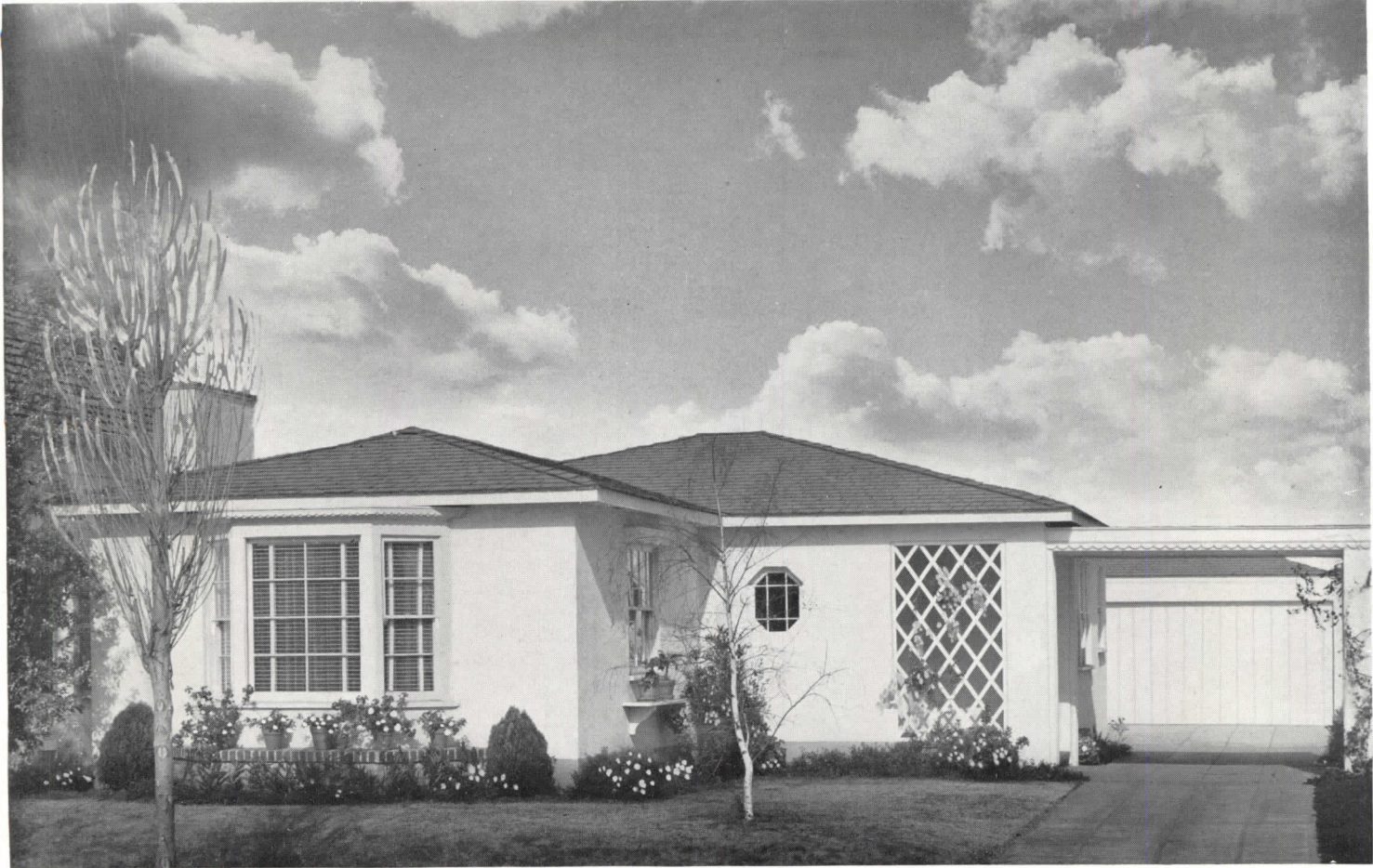

FIRST FLOOR

This is one of a number of houses designed for a subdivision, and was built without architectural supervision. The plan allows for free circulation. Its simple outline made possible simple roof, framing and foundations. The basement, though small, has room for heating equipment and hot-water heater.

FOUNDATION: concrete. **STRUCTURE:** wood framed, plastered; interior walls, plaster with wallpaper; paint over "Sanitas" in service portion and bath. **ROOF:** shingle. **FLOORS:** oak. **HEATING:** hot air. **BUILT-IN FEATURES:** "Swivelock" hinge on breakfast room table; shoe racks in closets; dressing table in dressing room. **LIGHTING:** Colonial brass; chromium plated in bath and kitchen; thin wall conduit wiring. **PAINT:** very pale green exterior walls with white trim, olive green painted dado. **WINDOWS:** wood double-hung; bronze screens; standard glass. **NET AREA:** 1,850 square feet, not including garage.

5 HOUSE 2W, WILLOUGHBY, OHIO
 HAYS, SIMPSON & HUNSICKER, ARCHITECTS

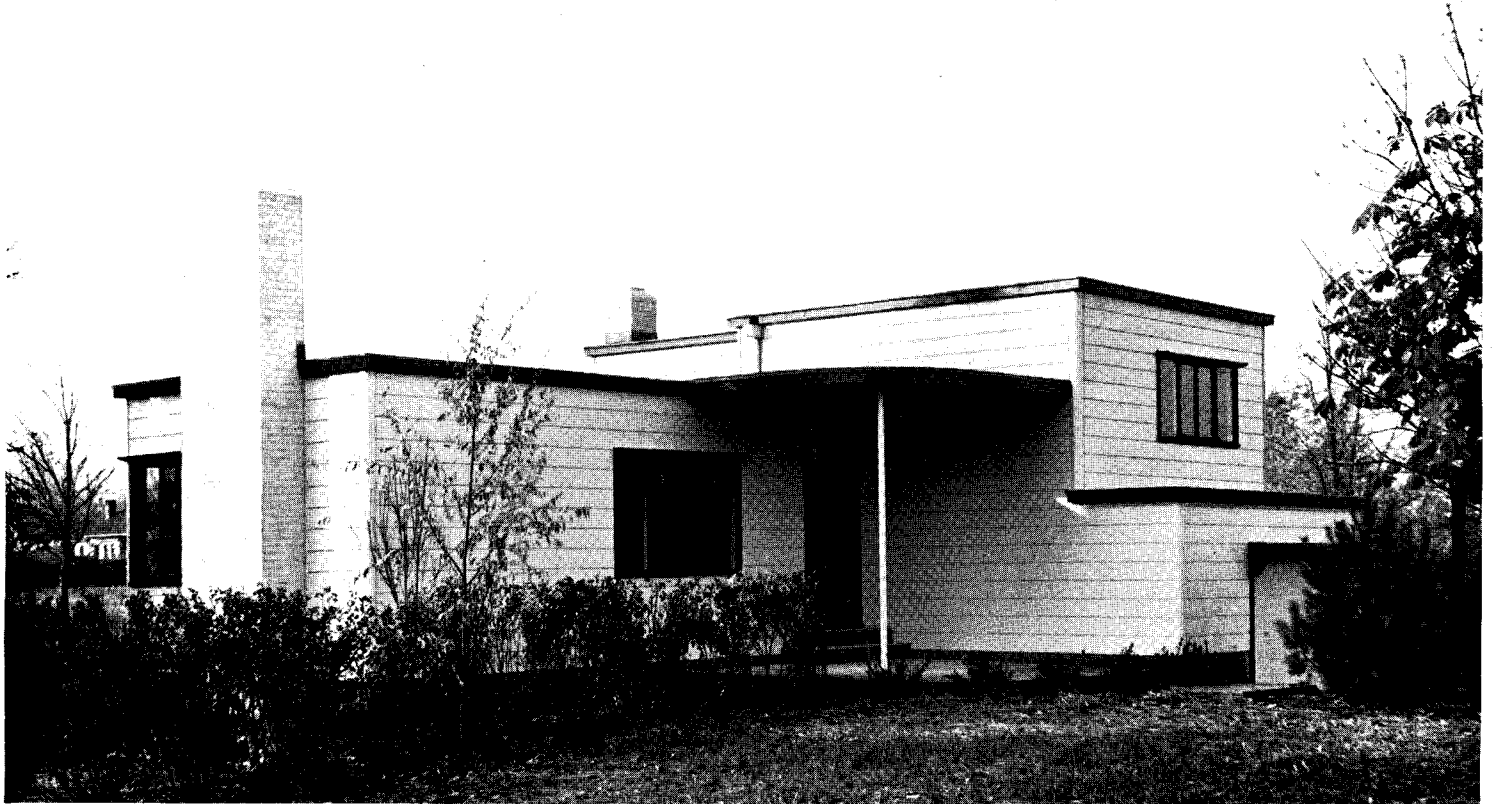

Photograph by Carl F. Waite

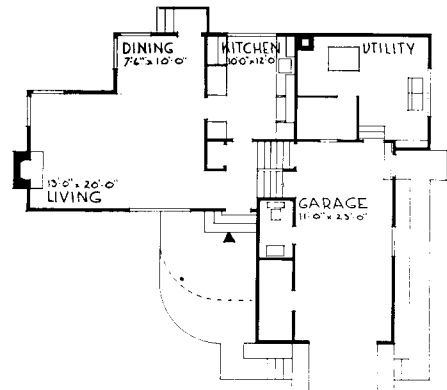

FIRST FLOOR

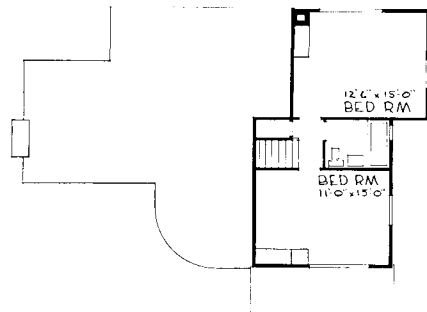

SECOND FLOOR

This house is a definite unit of a group plan. Instead of traditional exterior effects, the plan design was based on economy and livability.

FOUNDATION: concrete block. STRUCTURE: wood framed; 10' flush wood siding; interior walls plaster with wallpaper; linoleum walls in kitchen and bathroom. ROOF: four-ply tar and gravel. FLOORS: oak, except in kitchen and baths, where linoleum is used; cement in basement. HEATING: hot air, "Niagara" winter air conditioning. AIR CONDITIONING: air circulation and humidification. INSULATION: "Gimco" Rockwool bats; asphaltic waterproofing. BUILT-IN FEATURES: wardrobe in bedrooms; kitchen cupboards and equipment. LIGHTING: semi-indirect and flush, "Enterprise Electric"; knob and tube wiring. PAINT: Sherwin-Williams; off-white walls with maroon trim. WINDOWS: steel casement, "Vento"; copper screens; "Western" Venetian blinds; Pittsburgh plate glass, "Pennvernon."

6 **FULCHER HOUSE, FROST WOODS, MADISON, WISCONSIN**
 BEATTY AND STRANG, ARCHITECTS; GWENYDD BEATTY, ASSOCIATE

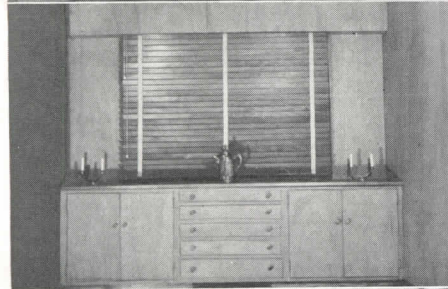
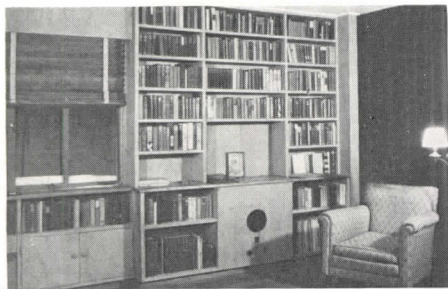

Built for three adults, this house stands on level ground. The curtain that divides the living and dining rooms is on a track which is recessed in the joint of the ceiling tile, opening up an entire side of the house. The deck opening off the study is part open, part screened.

FOUNDATION: poured concrete. **STRUCTURE:** brick superstructure; exterior walls, sand lime veneer; interior walls, plywood, painted or natural, except living room (Philippine mahogany plywood), and bath (Masonite). **ROOF:** four-ply, built-up, asphalt and felt. **INSULATION:** walls, 1/2" Balsam wool blankets; ceilings, 1/2" insulating tile and 4" Rockwool. **HEATING:** Wisconsin oil burner. **BUILT-IN FEATURES:** radio, buffet and bookcases in living room; bookcases and filing cases in study. **WINDOWS:** Fenestra steel casements. **OTHER EQUIPMENT:** water softener; electric water heater; electric well pump. **CUBAGE:** 29,000 cubic feet; 2,160 cubic feet for porch additional.

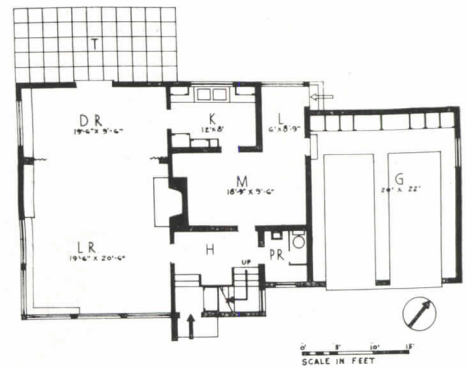

FIRST FLOOR



SECOND FLOOR

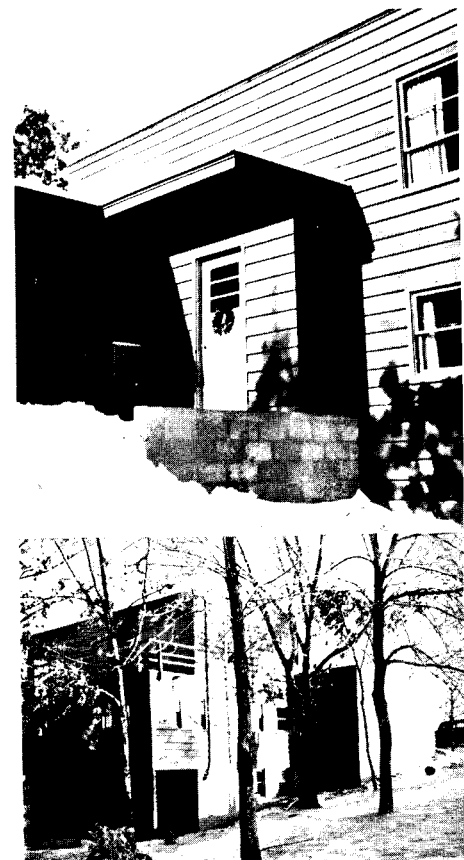
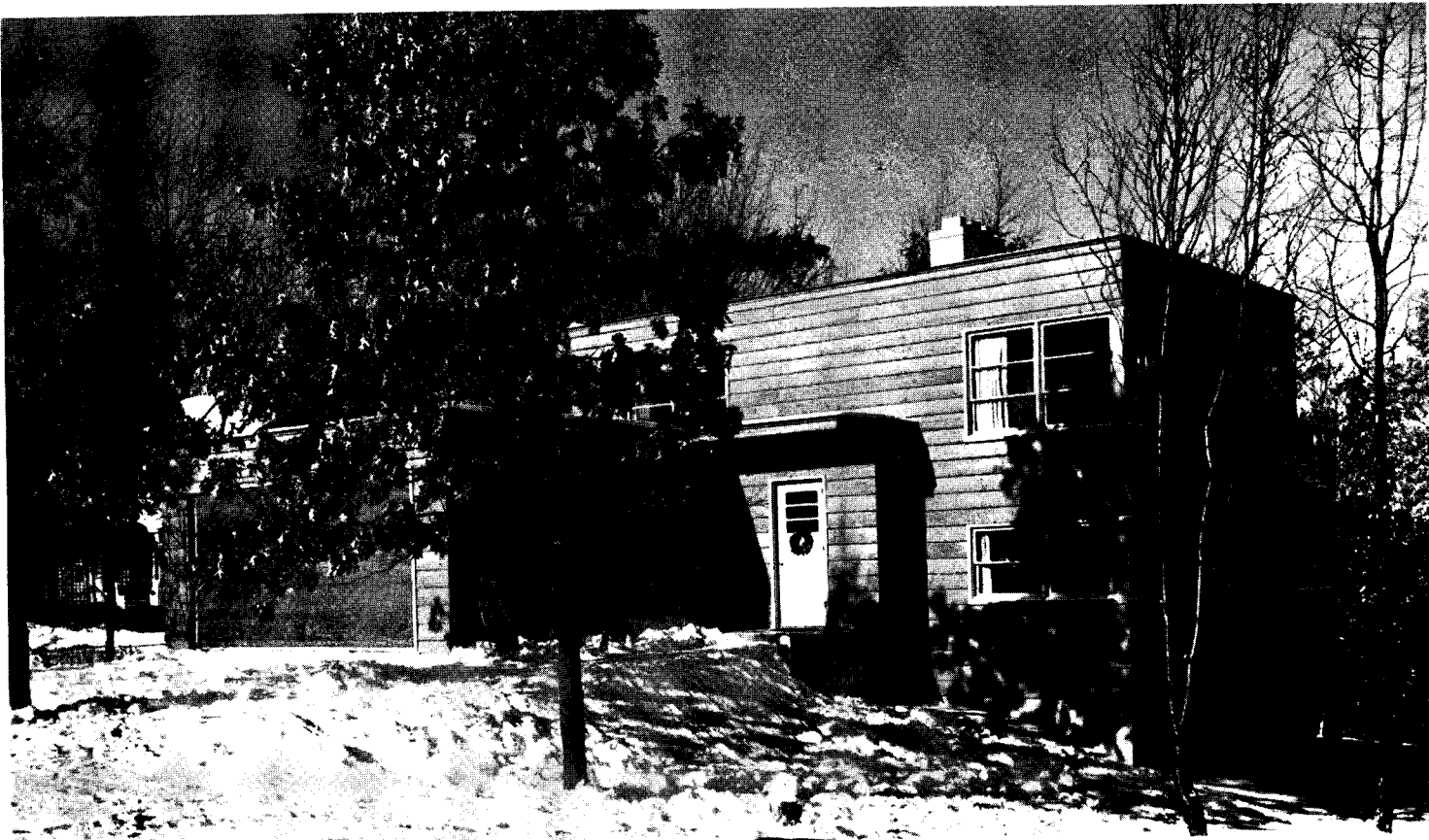

This residence was designed to house three occupants and one maid, with all bedrooms on what counts as the first floor. Because of the slope of the lot, nine feet from front to back of house, evident in lower view, the first floor in front becomes second floor in the rear. The ground floor is given over to recreation and laundry rooms, with space for the heating system. The simplicity shown in the design of the entrance is maintained throughout.

There are different floor levels made possible by the sloping lot.

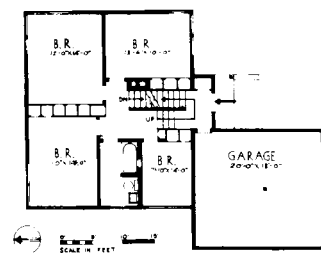

FIRST FLOOR

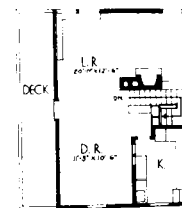

SECOND FLOOR

FOUNDATION: concrete. STRUCTURE: wood framed; 10" beveled cypress siding, natural stain; interior walls, Douglas Fir plywood; ceilings of bedrooms, Red Top Acoustical Tile. ROOF: four-ply, built-up, asphalt and felt. INSULATION: roof and bedroom floors over porch, 4" Red Top bulk wool; walls, Reynolds Metallation, Type "B." WINDOWS: wood, double-hung. CUBAGE: 25,036 cu. ft.; 1,302 cu. ft. for porch additional.



Photographs by Stephen H. Willard

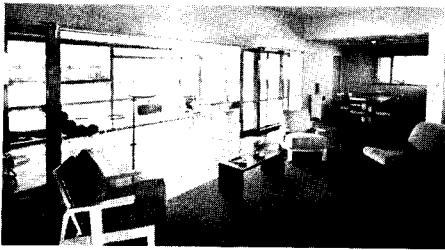

Living room, dining room and porch are so arranged that they can form one large living space, with a free passage of air. Further ventilation is obtained by screened louvers between the roof sheathing and the room ceiling, thus helping to avoid the usual intense heat from flat roofs. The car shelter also has louvers which exclude the sun, and ventilate at the same time.

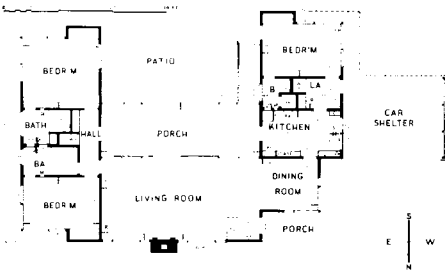

STRUCTURE: wood framed; exterior and interior walls, plaster. ROOF: built-up and gravel covered; sun deck, mineral-coated cap sheet; joists at overhangs tapered or full depth depending on structural requirements; metal flashing between composition roof and louvers; strip louvers for screened openings between joists. HEATING: vented gas console heaters in all rooms except bath (electric radiating-type heaters); built-in Heatilator lining for living room fireplace. WINDOWS: fixed, set in wood frames; steel ventilating sash, crank operators. PAINT: exterior: walls forming entrance to patio and house, coral red; walls under roof overhangs, jade green; all others, white; roof overhangs, light blue; trim, aluminum; interior: walls and window frames, jade green; walls at sides, neutral white; walls which form background, coral red; ceilings, light blue; living room mantel, black glazed brick facing.

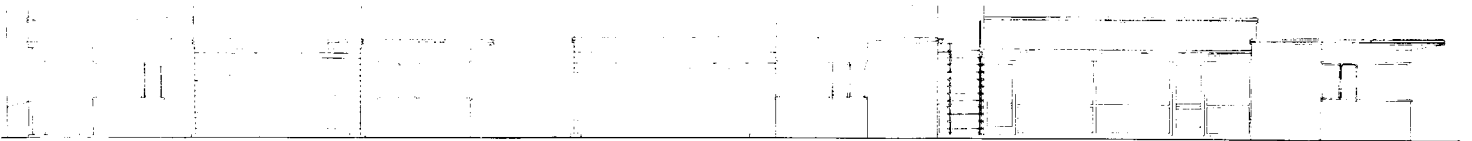

WEST ELEVATION

SOUTH ELEVATION

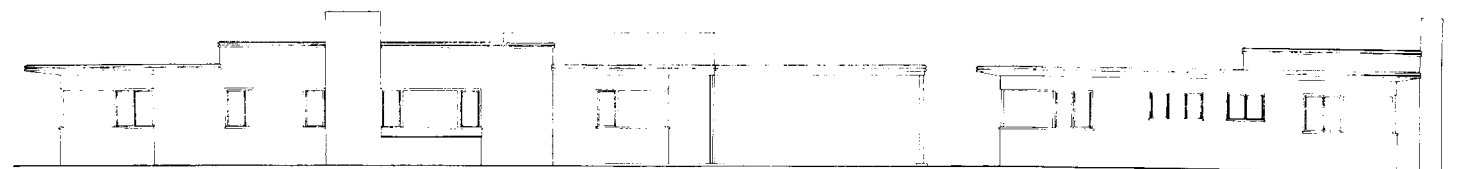

NORTH ELEVATION

EAST ELEVATION



Photographs by Wm. Hennessy



This house is so built as to provide for the future interior finishing of the portion above the garage. The plan allows for plenty of closet space in bedrooms and halls. Built-in features are the bookcases flanking the fireplace in the living room, and corner cupboards in the dining room. Wallpaper is used in the living room on the walls across from the fireplace, and natural finish wood on the fireplace wall and in the dining room.

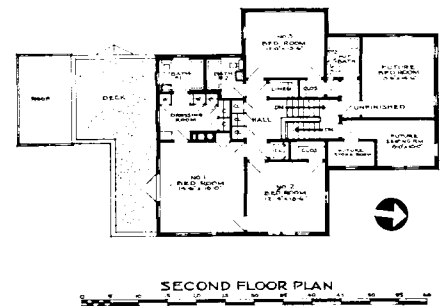
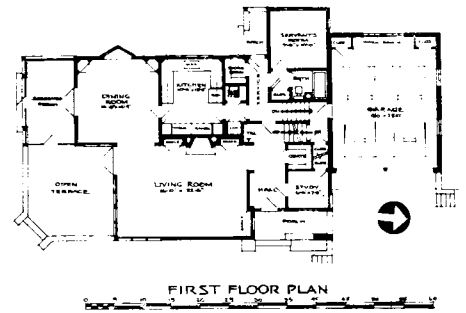



Photographs by George H. Van Anda

This house was carefully planned to fit the topography and to take advantage of the excellent view to the south. Simplicity was obtained by avoiding elaborate trim and decoration. The balancing of cut and fill was important in the location of the house. Provision has been made for the installation of a heating system, as the house is built for all-year occupancy.

FOUNDATION: concrete. **STRUCTURE:** wood framed; shingle facing; interior walls plaster with wall-paper, except living room (horizontal molded edge pine boards), hall and bath (painted plaster). **ROOF:** shingle. **FLOORS:** first floor, stone flags and cement; second floor, red oak. **INSULATION:** side walls, Cabot's quilt; over second floor ceiling, 4" J.-M. Rock-wool. **WATERPROOFING:** kitchen floor, Toch Bros. Marine Paint. **BUILT-IN FEATURES:** closet along one side of large bedroom with two openings for twin beds; beside the two beds are bookshelves with adjustable reading lamps; everything in kitchen built into one long counter with cupboards above and below. **LIGHTING:** hand-made scones made locally; soffit lights in kitchen and bath; wiring, BX flexible conduit. **PAINT:** Evans and Orbell's lead and oil paints; Cabot's shingle stain on roof; exterior color, putty (raw umber in white); blinds, soft gray green; oyster shell white trim on interior, except living room (white pine treated with Colonial stain), and large bedroom (powder blue trim). **WINDOWS:** casement and double-hung; copper screens; standard glass.

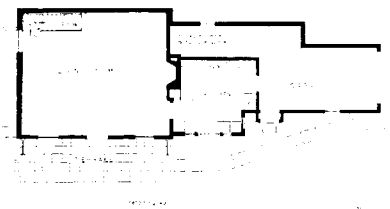

FIRST FLOOR

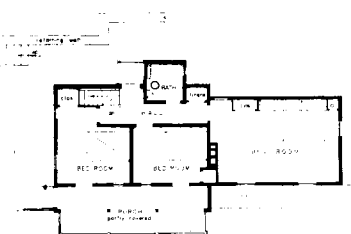

SECOND FLOOR

11 VAN PATTEN RESIDENCE, LOS ANGELES, CALIFORNIA

R . M . S C H I N D L E R , A R C H I T E C T

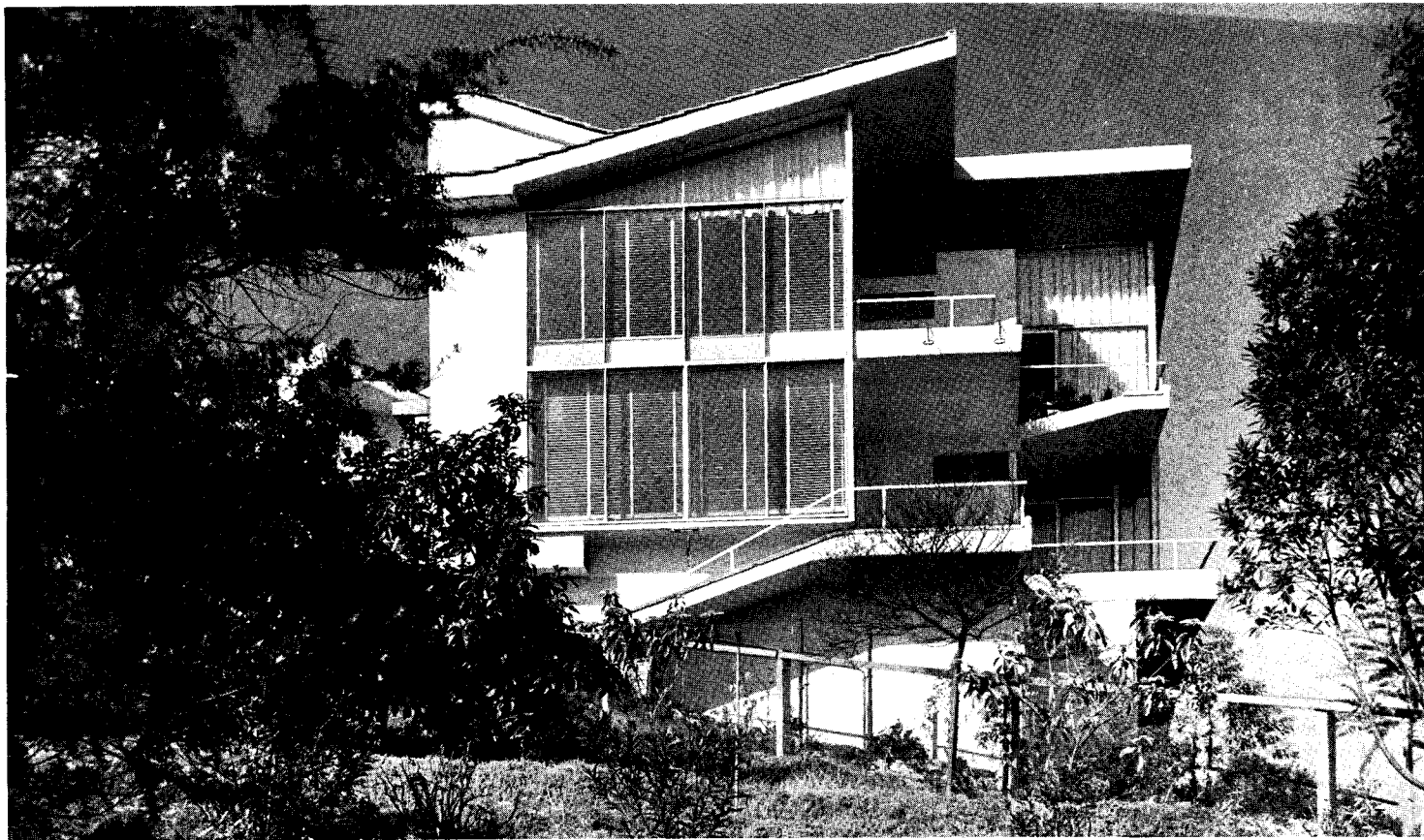

Photographs by W. P. Woodcock

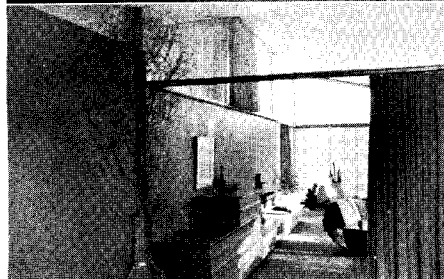
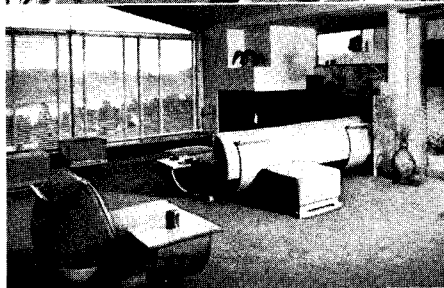
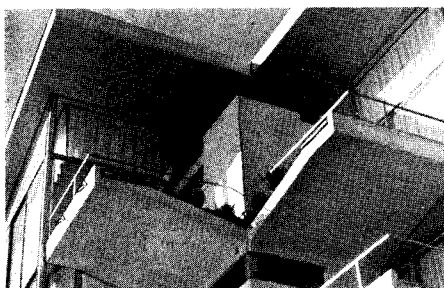

The gentle slope of the roof which the limitations of the lot made necessary became the basis of design for this house. The supporting members of the roof are architecturally suppressed in order to lighten the effect, and the metal windows are treated as a ranging glass curtain. Each room has two outlooks and a private terrace, which connects with the garden by means of a ramp. This, with the patio, gives ample opportunity for outdoor life. The front of the house is kept closed because of a poor view directly facing.

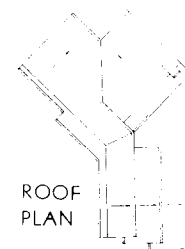

FOUNDATION: concrete. **STRUCTURE:** wood framed; exterior walls, stucco; interior walls, stained Russian ash; basement, concrete walls and beams. **ROOF:** tile. **WINDOWS:** sliding sheet metal sash. **PAINT:** variations of gray color.

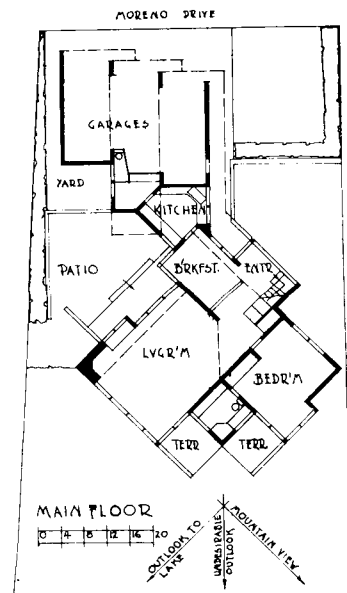
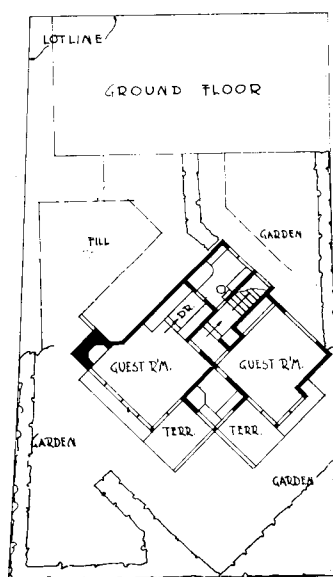

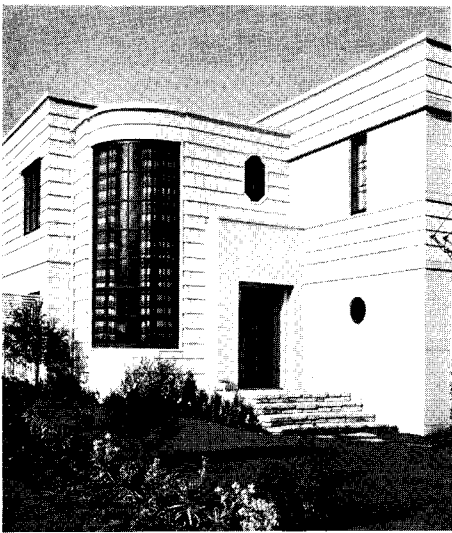
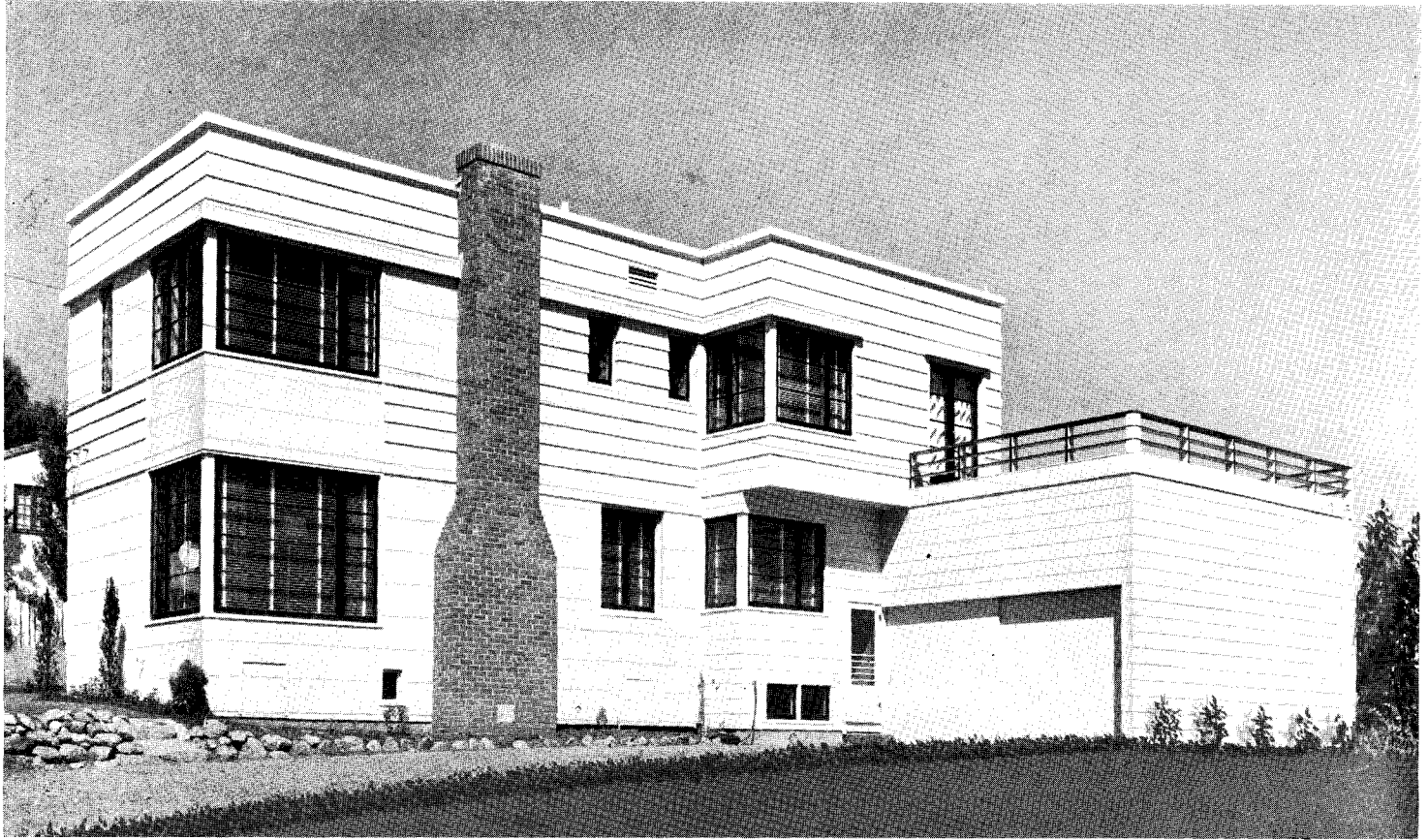

This house was built and sponsored by the Jones Hardwood Company of San Francisco, California, for Mr. and Mrs. Nelson E. Jones. Ornamentation and decoration here result from the use of wood and veneers, different effects being achieved by horizontals and verticals.

FOUNDATION: reinforced concrete. **STRUCTURE:** wood framed; exterior walls five-ply waterproof fir plywood, Redwood Rustic, Monterey shakes; interior walls, hardwoods throughout; kitchen and service portions, birch trim, birch doors; living room, dining room and entrance and upper halls, walnut plywood walls and trim, NuWood ceilings; breakfast room, Pearlwood paneling, Philippine Mahogany; guest bedroom, Philippine Mahogany walls and trim, with Magnolia band to meet head casing; master bedroom, birch plank walls and birch trim; son's bedroom, Art Ply walls and ceilings, Philippine Mahogany moldings and doors; stairs, walnut handrail, birch balusters. **ROOF:** tar and gravel. **FLOORS:** living room, dining room, breakfast room, entrance and upper halls, Teak plank; upper halls and guest room, oak block; master bedroom, herringbone oak; stairs, Teak treads, curly birch risers. **LIGHTING:** Boyd Lighting Co., San Francisco. **PAINT:** interior, National Lead Company lacquers and enamels; exterior, N.L.C. oils and leads. **WINDOWS:** casement windows throughout, hardware by Watertite Hardware Company.

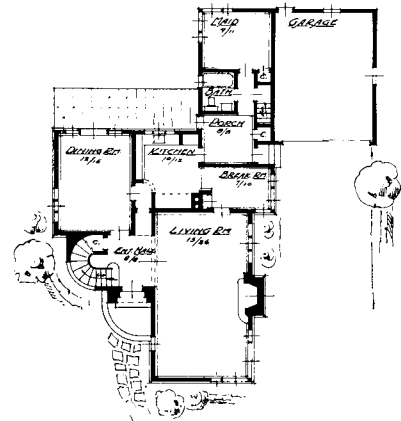

FIRST FLOOR

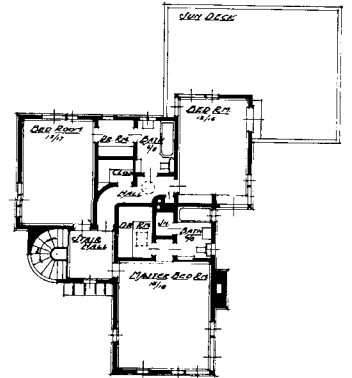

SECOND FLOOR

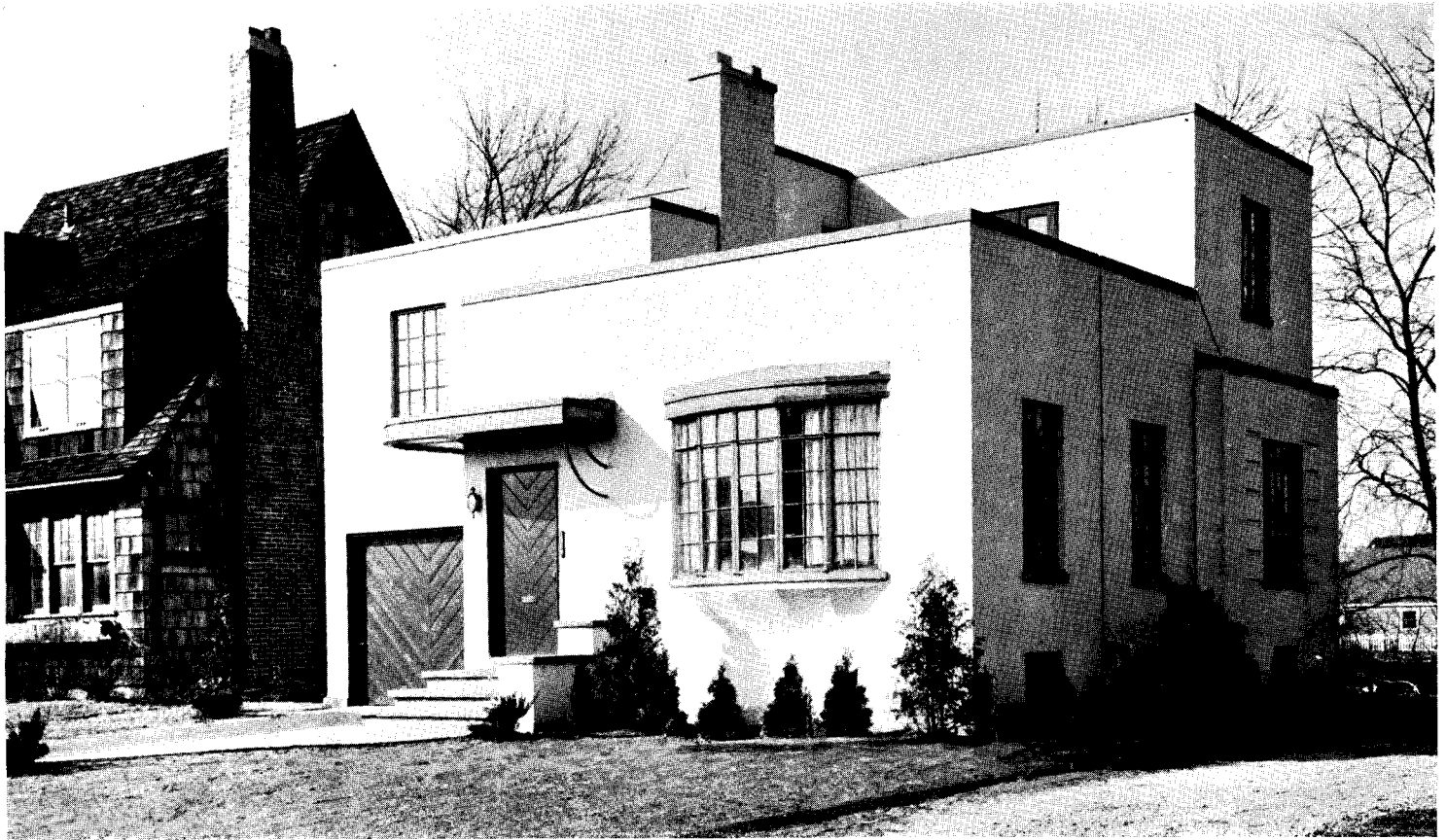

Staggered floor levels, quarry tile sun deck over living room, and built-in garage are interesting details of this all-steel house.

FOUNDATION: walls and basement, concrete blocks; concrete. **STRUCTURE:** Bethlehem steel frame, Steeltex and stucco; interior walls and ceilings, metal lath and plaster. **ROOF:** twenty-year bonded Carey Company on concrete slab; lead-coated copper flash. **FLOORS:** structural floor, 2" concrete steel joists; vestibule, tile; first floor, $\frac{5}{8}$ " Masonite; second floor, Battleship linoleum, Armstrong cork; bath, tile. **HEATING:** General Electric oil furnace and air conditioning unit; **AIR CONDITIONING:** air circulation and humidification. **INSULATION:** all exterior walls and under roofs; 4" Gimco Rockwool; 1" Celotex on concrete roof slab. **WATERPROOFING:** asphaltic. **BUILT-IN FEATURES:** General Electric dishwasher and sink, automatic water heater, refrigerator, ventilator fan, electric range; Hoosier kitchen cabinet. **LIGHTING:** indirect, with Vitrolite enamel fixtures; wiring, General Electric BX "Red Seal." **PAINT:** exterior, stucco painted with warm gray color "Medusa" waterproof cement paint; interior, ivory color. **WINDOWS:** "Truscon" steel casement windows, copper screens and storm sash; plate glass; door frames, all steel. **PLUMBING:** all copper water pipe.

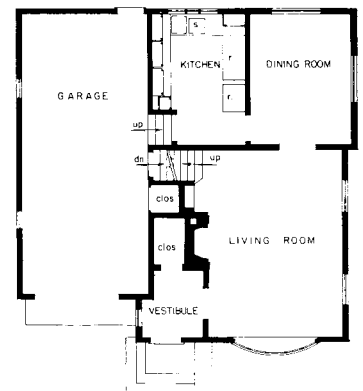

FIRST FLOOR

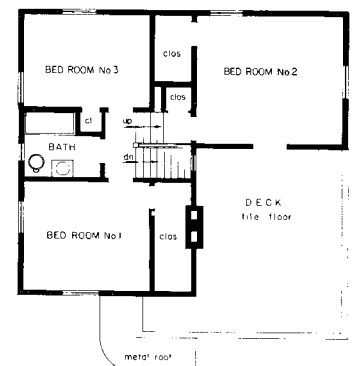

SECOND FLOOR

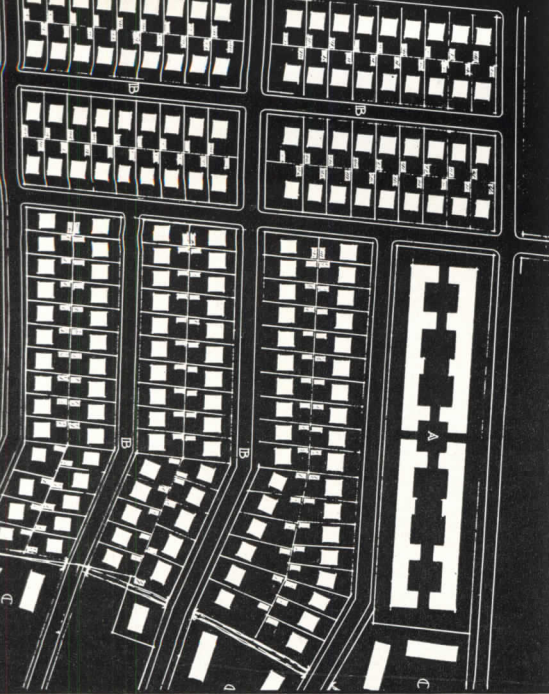

Short-sighted "planning" by random builders



... must give way to integrated communities.

INDUSTRY'S PROGRAM FOR REHOUSING AMERICA

By ALLIE S. FREED

The building industry must first integrate itself, commercially and technically, says Mr. Freed

Not so long ago a home for the average family was little more than a shell. In spite of the decline of the purchasing power of the dollar, similar shells could probably be built today at but slightly higher cost. Four walls, a floor and a roof, however, are no longer adequate. The introduction of plumbing, heating, electricity, have more than doubled the essentials of the average home. Many of our present-day necessities were the luxuries of yesterday. Modern home life is inadequate without their inclusion.

Even for the family who can afford to build their own home in accordance with these standards, other problems still remain. The new way of life has imposed standards of light and air and a recognition that no single house can properly be considered by itself. A man's home is his castle, but its security depends on what happens to his neighborhood. The solution of the housing problem is to be found not only in the building of homes but in the building of safeguarded communities.

The virtual cessation of building during the depression has justified the belief that economic recovery will bring with it a serious home shortage and, finally, a rent crisis. It is, therefore, especially desirable that in providing for this great need America should be motivated by long-term considerations rather than the usual ones of a feverish, speculative market that always invites substandard construction.

The America of an earlier day had traditions of good building and good community organization. Ironically, only those communities which an expanding economy left untouched, chiefly along the eastern seaboard, today suggest the outline of a good neighborly life. At the same time our newer towns and cities decayed and rotted at the core long before achieving their full economic growth. Now our unplanned home building proceeds in the building of potential suburban slums because of similar lack of proper planning.

The American scene has undergone numerous lightning-fast changes. On to the older cities were grafted new patterns which did not match, were

inadequate for future needs and were not of sufficient size to control their own destiny. These patterns were guided chiefly by a combination of old and new inefficiencies.

As homes became obsolete they descended the economic scale, serving low-paid workers, both white and colored. New construction never served this vast market. New homes were planned and built with the seeds of rapid obsolescence inherent in their construction.

The business of producing homes became a kind of shabby, small-time gamble. Land was seldom developed except for speculation. As industries grew where none had been before, somehow houses grew like Topsy. Population increases brought congestion. Land values soared ridiculously. Aided by unsound municipal taxation these imaginary values were frozen at levels which had little relation to economic or efficient use.

It became increasingly impossible for the average employed worker to provide his family with a decent house. He paid for accommodations, whether through rent or ownership, that were inferior in quality per dollar of purchase price to any other product of American industry. The moving picture was one of colossal waste, greed and abuse. Then for five or six years the picture stopped moving entirely. Population increase continued and new families appeared, though the family units were gradually becoming smaller. A tremendous potential demand was created. Mile after mile of the American scene was ugly and decayed. But very few houses were built in the old way and the nation had not yet found a new way that worked. A tremendous potential demand was not translated into effective demand.

Many reports and recommendations have been made by individuals and organizations as solutions of the problem of providing adequate homes for the average family. The obvious weakness in most of them was the tendency to "simplify the problem" and thereby present a simple solution which ignored the real underlying factors. Any one or more of these factors easily upset the solution.

Besides being president of Paramount Communities, Inc., Mr. Freed is also chairman of the Committee for Social and Economic Progress, of which he was one of the founders. This Committee, believing that revival of the home-building industry is essential to national recovery, has for two years been studying the industry; Paramount Communities is the outgrowth of these investigations.

The fact is that there is no simple solution to the problems involved in providing "better homes for millions of people at reasonable cost." There are so many factors involved in the accomplishment of that service that only by giving each one its proper weight and providing effective correction in relation to each of the others and the whole, can we progress to a solution which will give us the desired result. To improve one factor and ignore the rest makes some contribution, but does not provide solution.

The age-old inefficiencies in the building business caused the socially-minded to advocate publicly subsidized home building as the great solution. Appalled by the accumulation of inefficiencies in shelter and properly fearful that private industry would never do the job, a fine body of sincere citizens concentrated their efforts in obtaining public funds for home building, forgetting in the main the fundamental economic and political factors involved in this over-simplification.

On the side of private industry the proponents of the prefabricated house were wont to say, "With this house the problem is solved." This has been in spite of the fact that each of the proposed cures did not have the advantage of either quality or price. To them the "factory-built-house" will correct all the evils of uneconomic use of land, of inadequate, high-cost finance, of craft labor, of inefficient tax and foreclosure laws, and most of our governmental weaknesses.

It is not my purpose here to enter into technical discussion of prefabrication as applied to houses. We have progressively developed greater prefabrication of materials, and I hope we will continue to do so. The dream of a house manufactured, as is the motor-car, is one which even though realized would raise many more industrial, financial and governmental problems, that might delay indefinitely the results desired.

Meanwhile people must have homes. The Committee for Economic and Social Progress felt that it was logical to make the first start in turning the experience an dability f industry, finance and labor to he task of making more efficient use of men, money and existing materials. This means simply what industry knows as "integration," by definitely meeting the fundamental and elementary requirements of good modern dwelling units and organizing the means of production.

There are four basic premises which underlie any efforts at integration of building processes to serve the potential market. They are:

- (1) The development of an *analytic planning* technique.
- (2) The organization of *large-scale home building companies* as employers of this technique on an industrial rather than a professional basis.
- (3) The *planned neighborhood* as the unit of development.
- (4) The creation in each of such planned neighborhoods of a large core of *dwellings for rent* under single ownership and management, in addition to those houses built for sale to individual owners.

The acceptance of these basic premises gives a firm foundation for the start of a broad home building program. They are the analytical outcome of the recommendations of business and professional men contained in the Twelve-Point Program of the Committee for Economic and Social Progress. They form the basis for the industrial approach to the creation of a home building industry. It is on them that the first of the home building companies recommended by that Committee was formed—Paramount Communities, Inc.

This company began its existence under the inspiration and guidance of the late Henry Wright, who years ago developed living patterns of community planning. Sponsored by business men, its organization was developed to include personnel capable of handling the planning technique as defined above. Completely staffed and adequately capitalized, it began to function to plan the most economical development possible to achieve the desired result—better homes for more people at lower cost.

It is not a philanthropic organization. It is motivated by a desire for the legitimate profit which accrues to an efficient industrial operation. Obviously, the success of integrated operation in the home building business requires availability of capital, and capital demands its return. Not only must this new home building company produce a better product, but it must provide the technique of finance to make possible the delivery of the product to the consumer.

Recognition of this last fact is perhaps the most important step yet made in the advance toward solution of home

building problems. It opens up an entirely new field of community and neighborhood planning. It provided a new area for technical operations in design, architecture and construction. That, in turn, provided a new area for mortgage finance on a basis which bids fair to make possible that "liquidity of mortgages" about which so much has been heard in recent years.

Here, then, before a shovel touched the earth, we saw the importance of correlating the progress made in solution of the problem of any one phase of home building with the other factors involved and with the whole. The technical problem of producing homes in planned neighborhoods for both rent and sale, at prices which the potential market affords, required an attack upon every phase of shelter cost. The first step toward making concrete the theories developed by technicians was the acquisition of land suitable for community development and in areas where there was a real demand.

Paramount Communities, Inc., obtained two locations: one in Clarendon, Virginia, just across the Potomac River from Washington, D. C.; the other in the midst of the village of Tenafly, New Jersey, within a stone's throw of New York City. First, the market for shelter was analyzed, the requirements were surveyed and the types of dwelling accommodations determined. From that the plan was fitted to the topography. Then the architects harmonized the requirements with the plan. Materials and equipment were studied, alone and in combination. Using the known needs as to the size of the family units, these were grouped in the rental sections to produce the most economical structure units. As these took form on drawing boards, the research men and engineers pored over cost estimates.

Working on the basis of long-term investment, the company aimed to produce structures as free as possible from the factors which accelerate depreciation and obsolescence. The latest developments in electrification, refrigeration, plumbing and heating were studied, and then their use was subjected to severe cost analysis.

Always was kept in mind the ultimate cost to the tenant. Whatever could be given him which also protected the property against depreciation and obsolescence, was made the goal. It is a pleasure to note that as manu-

(Continued on page BT44)

PURDUE COMPLETES YEAR OF STRUCTURAL RESEARCH

By **BENJAMIN F. BETTS**

Mr. Betts, Director of Research, describes the work of the department, some of its conclusions.

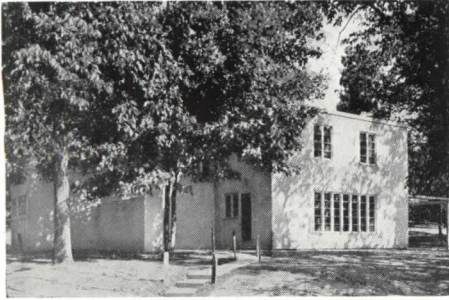

HOUSE NO. 1: This design of A. J. Foulhoux, architect, won in the A.I.A. competition.

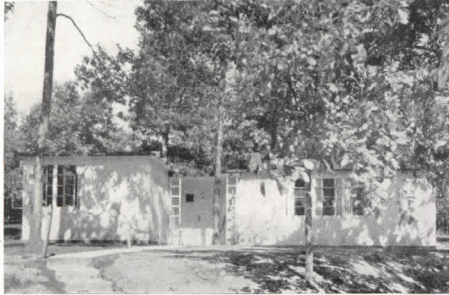

HOUSE NO. 2: General Houses, Inc., were the designers and builders.

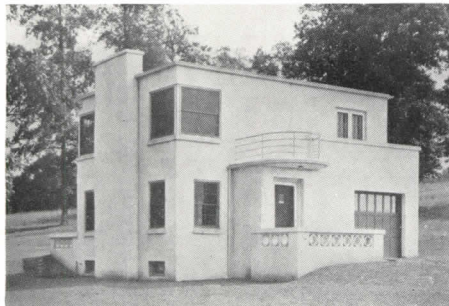

HOUSE NO. 3: Sponsored by the Portland Cement Association; McNally & Quinn, architects.

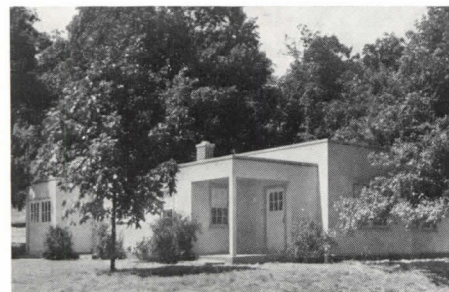

HOUSE NO. 4: Designed and built by Insulated Steel Construction Co.



HOUSE NO. 5: An all-wood project sponsored by the National Lumber Manufacturers Association.

Research, per se, is a process of finding out something. It does not proceed on a basis of proving something. In this it differs from experimentation which is done with the idea of proving that something is or is not possible of accomplishment. Work in housing at Purdue University has been one of research and not experiment.

Five houses were built by the Housing Research Department of Purdue University in 1936 for the purpose of cost analysis. Accurate records were obtained on four houses. It was impossible to obtain complete cost records on one house which is of the prefabricated type.

The cost analysis program was the result of numerous statistical studies which indicated houses costing \$5,000 or less to be America's most urgent housing need. This cost classification based upon family incomes represents approximately 75 per cent of the demand. Yet under present building costs and construction methods it is the most difficult one to satisfy. The crux of the situation appears from every angle to be construction costs.

Based upon the conviction that adequate housing for the majority of American families cannot be had until construction costs are in line with incomes, the first desirable step in housing research was one of obtaining first-hand knowledge of what houses cost and why. To make these studies of value it was also apparent that various types of construction should be used in a way that would provide a fair basis of comparison. This meant building several houses at the same time, in the same locality, and of approximately the same size.

In a program of this nature there existed the possibility of arriving at cost reduction through suitable combinations of various economical construction methods, materials and equipment. Or, it might be found that one or more essential items entering into construction might be a point of attack which if solved would mean greatly reduced costs. Or, who knows, some other answer hitherto overlooked, might be found.

Conclusions to date are not startling

or spectacular. They merely confirm what has been generally known. Small houses require in their construction numerous items no one of which is what might be termed excessive in cost. The total of all the items becomes a sizable amount. Only by a most careful adjustment of all items can the cost be kept down. No one method of construction now available appears to hold a marked cost advantage over any other method. And one may correctly assume that the cost of the shell of the house represents the largest single item of the total cost. Studies also indicate that distribution costs from material sources to the job are far in excess of the actual costs of the materials themselves. The cost analyses do alter the general opinion that the cost of labor and materials on the job are approximately equal. Based upon the construction of four different houses in Lafayette, Indiana, the cost ratio is more nearly one-third for labor and two-thirds for materials.

All five houses were designed to meet the needs of families having minimum requirements of a combination living-dining room, kitchen, three bedrooms, bath and one-car garage. They include houses with and without basements; one story and two stories in height. The following types of construction were used: House No. 1, wood frame, stucco exterior; House No. 2, steel frame and prefabricated panels; House No. 3, reinforced concrete; House No. 4, all-steel prefabricated panels; and House No. 5, all wood. Heating plants in three houses are of the forced warm-air type, one gravity warm air, and one one-pipe steam. Oil is used for fuel in two houses, gas in one and coal in two houses.

General contracts were let on all houses and all construction costs were paid out of Purdue Research Foundation funds. No price concessions or free contribution of materials or equipment were accepted since first-hand knowledge of actual cost to the consumer was desired. The cost of the steel frame and prefabricated panel house, House No. 2, was \$4,625. The four houses upon which detail cost rec-

ords were kept ranged from \$4,852 for House No. 1, to \$4,997 for House No. 3.

These studies can only indicate that if small houses are to be greatly reduced in cost, economy of materials and methods must be employed throughout. It is also apparent that major points of attack must concentrate on the shell and the mechanical facilities.

It is unlikely that any miracle material or method now unthought of will appear on the market or in the labora-

tory, that will cause drastic cost reduction. Two feasible possibilities do appear on the market or in the labora- appear on the horizon. They are not new ideas, but bear further exploration and development. They center in the fields of large-scale housing developments and in prefabrication. Both are merely the invasion of building by industrial methods which utilize the economics of mass buying, mass production, and possible reductions in distribution costs.

(See page BT 44 for further cost data.)

TOTAL COST	HOUSE NO. 1	HOUSE NO. 2	HOUSE NO. 3	HOUSE NO. 4	HOUSE NO. 5
	\$4,852.45	\$4,625.00	\$4,997.50	\$4,992.20	\$4,986.00

COST ANALYSIS OF 4 NON-PREFABRICATED HOUSES

CONSTRUCTION	UNIT	HOUSE NO. 1	HOUSE NO. 3	HOUSE NO. 4	HOUSE NO. 5
Excavation	cu. yd.	\$ 2.10	\$ 1.10	\$ 1.06	\$ 0.51
Foundation	total	91.85	503.60	365.55	251.30
Exterior Walls	sq. ft.	.508	.529	.50	(h) .594
Interior Partitions	sq. ft.	.376	.322	.46	(h) .442
Basement or Garage Floor	sq. ft.	none	.133	.118	.147
First Floor	sq. ft.	.639	.271	.361	.325
Second Floor	sq. ft.	.50	.31	none	.512-.54
Roof	sq. ft.	.50	.544	.572	.444
Sheet Metal	total	73.70	54.70	115.00	small
Millwork	total (a)	1006.10	949.50	703.90	751.65
Stairs	total	99.70	70.25	none	175.70
Painting	total	322.85	115.50	361.95	336.00
Exterior	sq. ft. (i)	75.30		.08	.07
Interior	sq. ft.	.039		.04	.034
Floors	sq. ft.	.031		.029	.034
Heating	total	491.95	290.00	330.00	400.00
Plumbing	total (b)	353.40	355.05	391.00	290.60
Electrical	total	113.35	205.00	125.00	153.65
	outlet (c)	2.76	4.02	(e) 3.05	(f) 3.14

(a) includes kitchen sink, (b) without kitchen sink, (c) 41 outlets, (d) 51 outlets, (e) 41 outlets, (f) 49 outlets, (h) plywood finish varied in cost from .104 to .229. Figure given is based on an average cost of plywood of .149 per sq. ft. (i) total cost of painting doors, windows, trim.

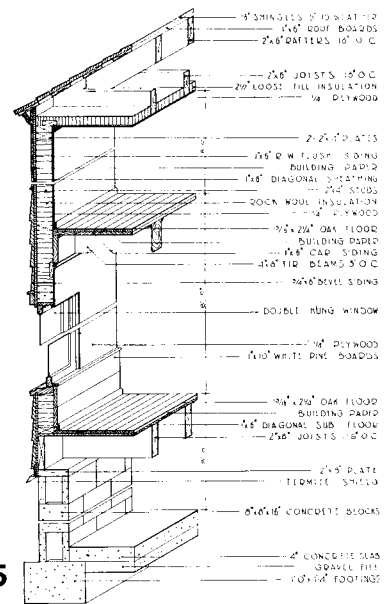

No. 5

All-wood system with plywood interior.

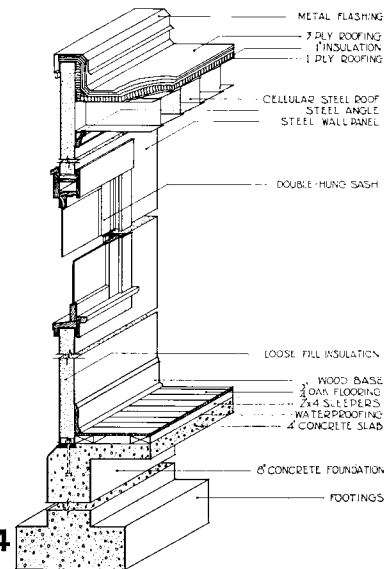

No. 4

Steel units for floors, walls, roof.

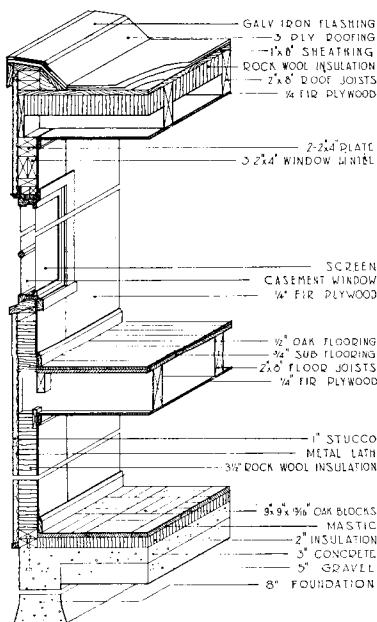

No. 1

Wood construction with stucco finish.

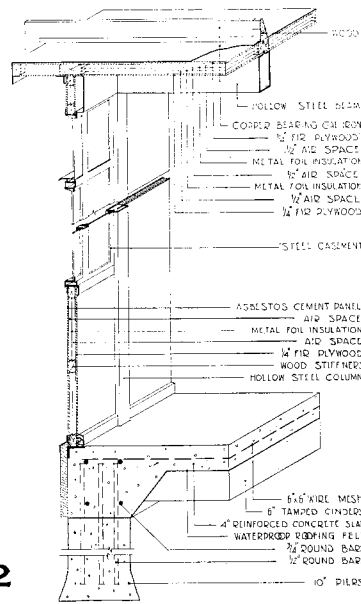

No. 2

Patented steel-and-asbestos wall units.

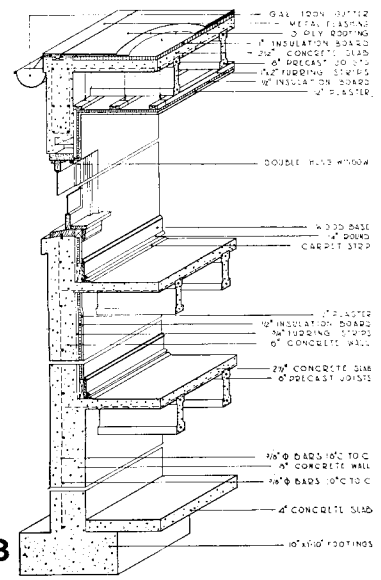

No. 3

All-concrete system, reinforced and precast.

STRUCTURAL SYSTEMS

STEEL

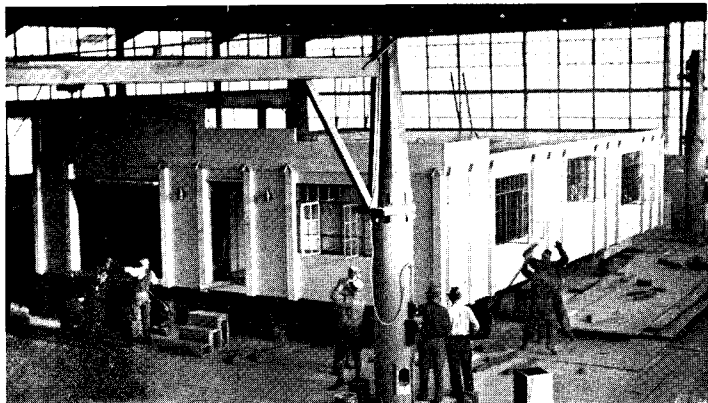

Complete to a fire in the furnace, the house is ready to ship.

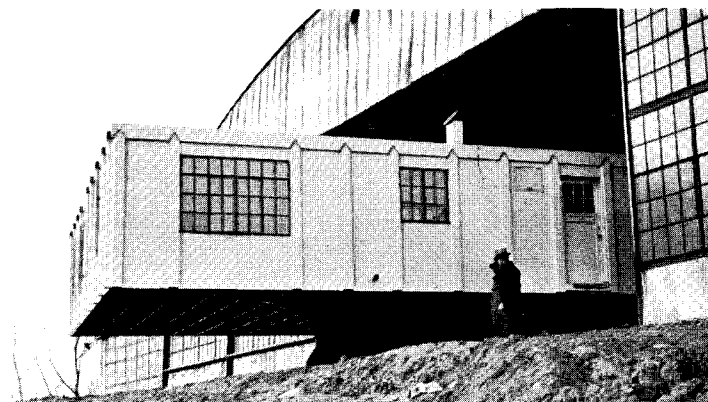

Being a completely rigid structure it is easily lifted by a crane

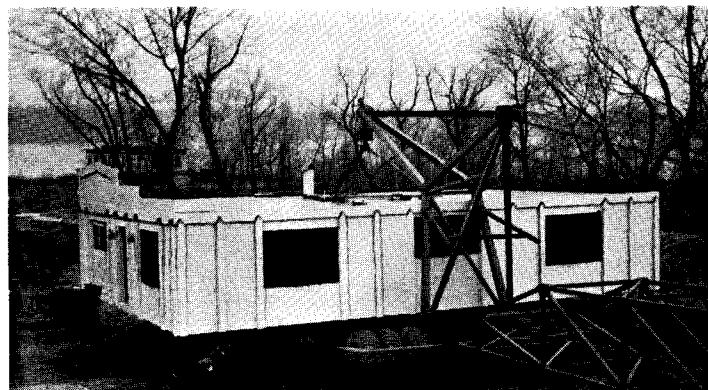

and is trucked down the highway towards the "building site."

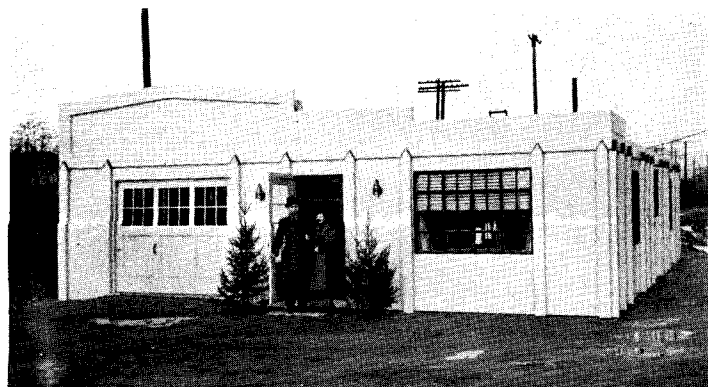

Four hours after delivery it is ready to be lived in.

Machinery company builds first all-steel "truckable" house

Until faced with the necessity of providing housing accommodations for its employees, R. G. LeTourneau, Inc., of Peoria, Illinois, manufactured only heavy grading and construction machinery. But the first house—described below—proved so successful that five more of this size and 30 two- and three-room models are now under construction; and, though no information on costs is available "because construction has not yet been put on a production basis," LeTourneau contemplates entering the field commercially.

Built complete, decorated, ready to move into, a full-size, five-room, electrically-welded steel house with garage incorporated was mounted on a semi-trailer and rolled out of the R. G. Le Tourneau grading machinery plant at Peoria, Illinois, recently.

There was coal in the two-ton hopper, the furnace was going and the house was comfortably warm. The 16-wheel trailer, towed out of the factory by a Caterpillar tractor and along the roadway by a 1½-ton truck, had no trouble with its 41-ton load.

On a space leveled off in the front factory yard, just as a home site would be leveled, the 32 x 44-foot house was gently set down by a tractor crane which took hold of the three steel rings on the roof, lifting it while the trailer rolled out from under. Within a few hours water, sewer and electric connections were made, drapes were up, floors carpeted, each room appropriately furnished, and the house was ready for occupancy.

This house is the first of a great number of similar cottages for Le Tourneau employees that are to be built complete inside the factory. When the next five houses, on which construction has started, are finished, the six dwellings are to be launched on the Illinois River, which flows past the factory, and towed on their own bottoms across to a Le Tourneau colony site.

These are believed to be the first all-steel houses ever built, as well as the first houses to be completed ready for occupancy inside a factory. The first house has asbestos board ceilings and living room walls, and wooden doors, but the dwellings now under construction and all future houses are to be entirely steel except for plumbing fixtures and Rockwool insulation between the wall sheathings and between ceiling and roof.

(Continued on page BT44)



The new LeTourneau houses will be all-steel and completely insulated.

STRUCTURAL SYSTEMS

STEEL

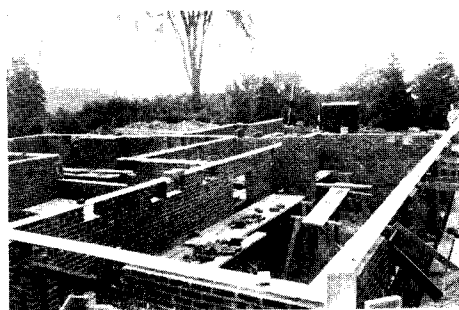

1. Foundations are brick or concrete.

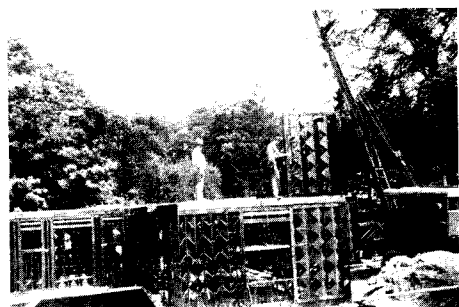

2. Wall units are swung into place.

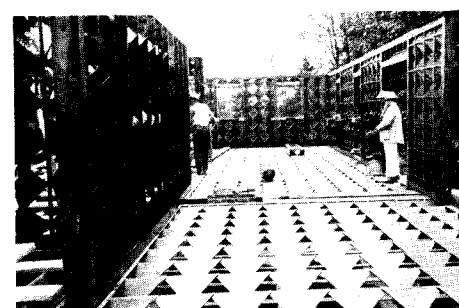

3. The same unit frames the floor.

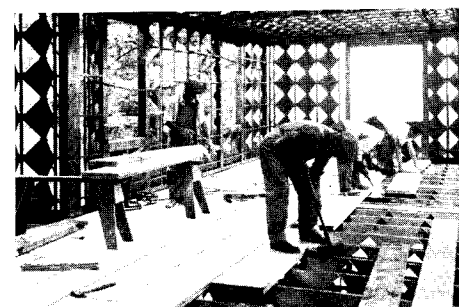

4. Laying the gypsum subfloor.

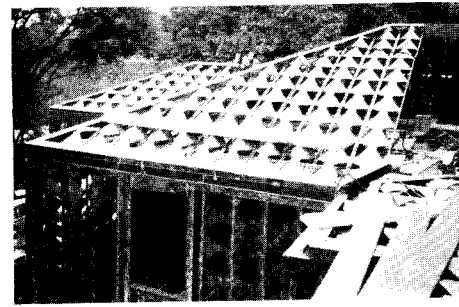

5. The roof is quickly framed.

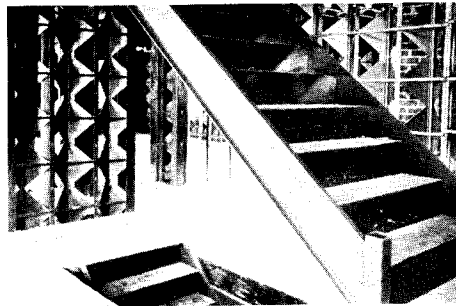

6. Stairs are one-piece welded steel.

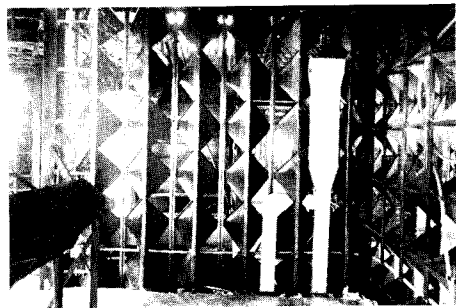

7. Ductwork in the bearing walls.

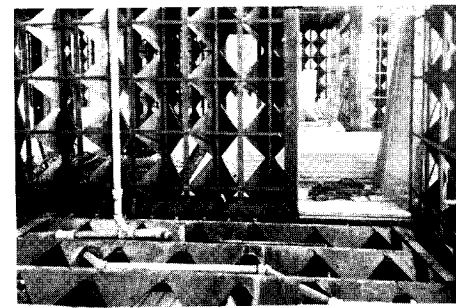

8. Cutting for plumbing is simple.



9. Paper-backed metal lath throughout.

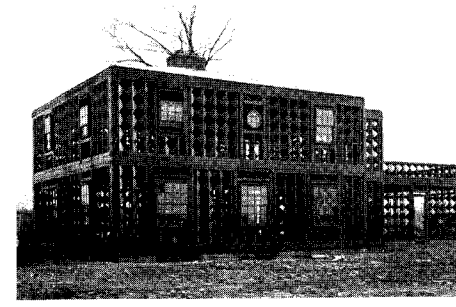

10. The structural shell complete.

Arcy system includes design, fabrication, assembly, equipment

Shown here are progress photos on one of the five houses recently completed in Cleveland Heights, Ohio, by the Arcy Corporation of New York City. For further details of the Arcy system, see Technical News and Research, November 1936.

The structural system of the Arcy Corporation involves an all-steel sectional frame of special design, fabricated of copper-bearing sheet steel in standard widths and in any desired lengths. The steel frame is stiff, and is wind, lightning, fire and vermin proof. Flexibility in planning these houses is possible because all partitions are non-load bearing. Foundations may be of brick or of concrete. Reinforced gypsum planks bound with tongue and groove flanges are used for the sub-floor, and the finish may be of wood, linoleum, or rubber, depending on the interior design. Insulation and sound-proofing are obtained by the use of corkboard. Heating is by gas or oil furnace, with air conditioning equipment. Exteriors may be finished in any desired medium — wood, stone, brick or stucco.

Panels in standard sizes and shapes are manufactured at the Pittsburgh plant of the Corporation, and shipped to the building site for field assembly. Four structural units constitute a panel; wall panels are 8'-6" high; floor panels can have as long a span as 28', and may be used in roof construction as well. The span and load do not affect the steel content, but this in turn does not affect the cost, as it is offset by the standardized fabrication. Structural steel sheets are spot-welded in angles to three 1" steel angles which run parallel along the middle fold. These units are then spot-welded together for floor and wall panels.

Every Arcy house comes complete with kitchen and bath fixtures, wardrobes in the bedrooms, gas or oil furnace, with air conditioning equipment for cleaning, filtering heating and humidifying the air. The kitchen has a sink of stainless steel; the cabinets are of hollow metal, Arcy designed and built; all working spaces are finished in linoleum bound with stainless steel.

(Continued on page 56 adv.)



1. Torch instead of saw for cutting.

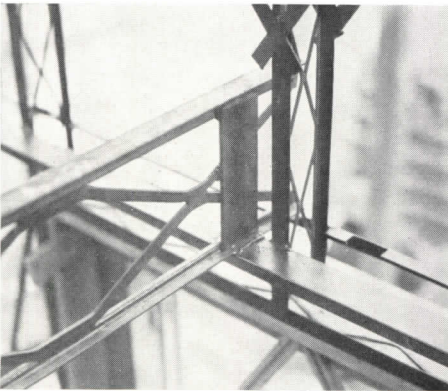

2. Joists are quickly fixed to bearing.



3. Torch replaces hammer and nails.

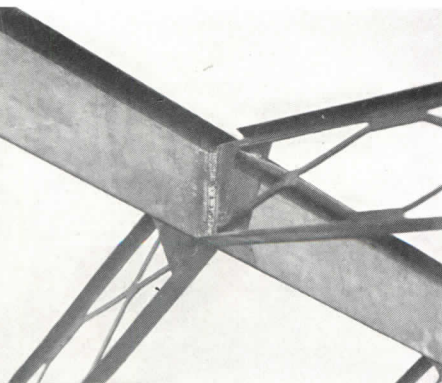

4. for quick and permanent welding job.

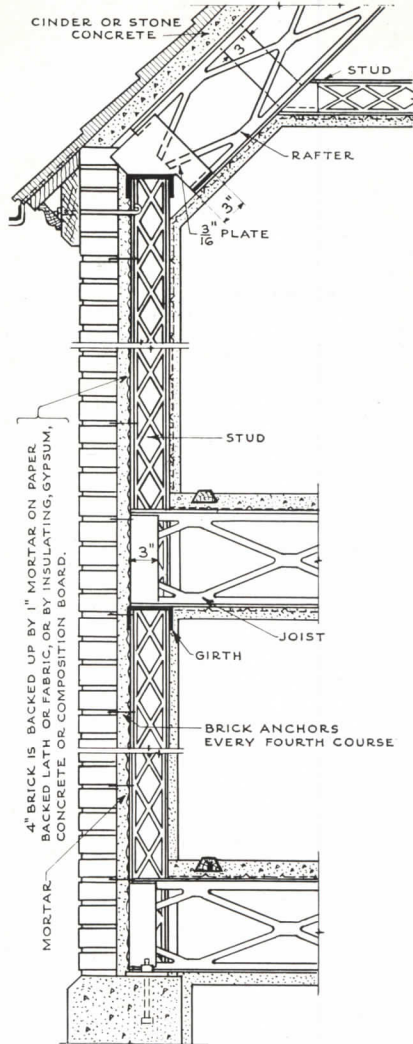

Vertical section through typical wall.

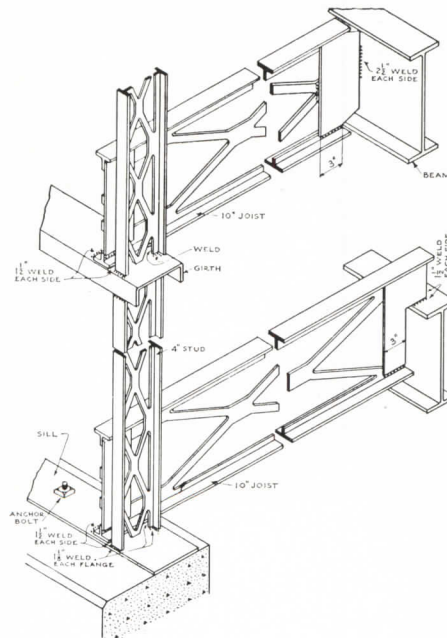

Isometric of steel framing assembly.

Bethlehem's lightweight members adaptable to traditional construction

The Robida house at Niagara Falls, N. Y., shown on page 31, employed the Bethlehem Steel framing system.

Illustrated is a light-load type of steel framing actively promoted by the Bethlehem Steel Company for residences and small buildings. Significant features of this type of steel construction are the hot-rolled open-web type joists and studs that it utilizes and a system of erection that capitalizes upon recent advances in electric arc welding and oxy-acetylene flame cutting. These light-load members are somewhat heavier per lineal foot than wooden joists or studding. But since they can be spaced on 24" or 30", rather than the 16" centers which are standard in framing of wood, the total weight of the erected framework is no greater than that of wood construction. They are delivered to the lot cut in standard lengths, just as wood framing might be. The field electric arc welder, substituted for hammer and nails, and the acetylene cutting torch for the saw, make it possible to erect the steel members in practically the same manner as wood for framing. While qualified welders attend to the actual fabricating of the steel, a man experienced in laying out ordinary framing supervises the work.

Indeed the strength and rigidity of welded steel construction often simplify problems that would present obstacles in wood framing. For example, steel framing is well adapted to long spans; and in such features as bowed windows steel members may be readily notched by means of flame cutting, and rewelded to meet the requirements of curved construction without sacrifice of strength. The steel framing makes possible fire-resistant floor and wall construction, provides lasting protection against termites, and also eliminates shrinkage.

The added cost of this construction, including the extra cost of fireproof subflooring and plastering on metal lath, is estimated to be 5 to 10 per cent more than for a similar house of wood construction. This estimate is based on subfloor construction consisting of 2" concrete slabs and metal

(Continued in adv. section)

"Gravelite" uses standardized forms, synthetic aggregate, in new design

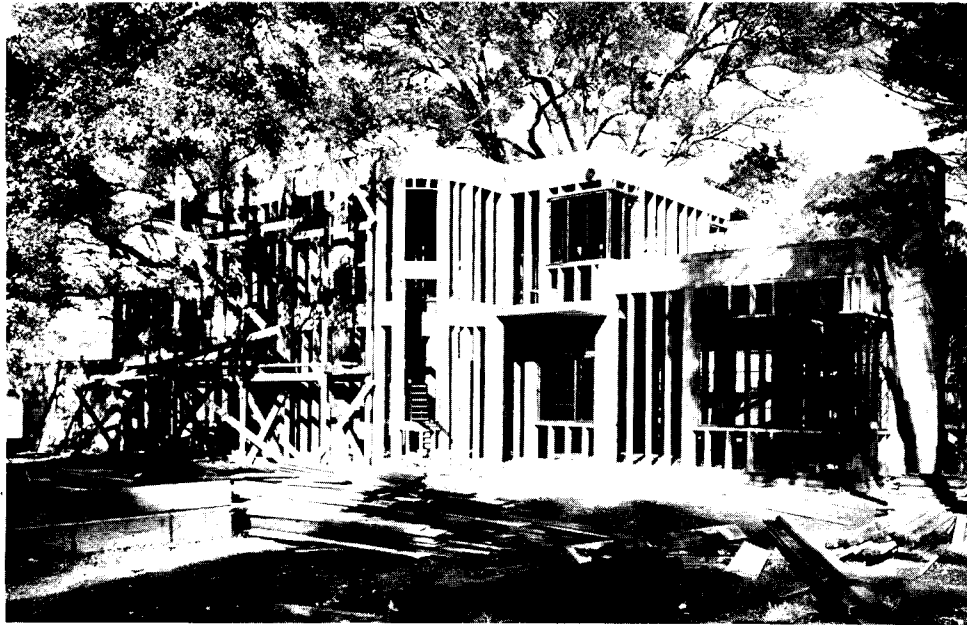

A California house employing new concrete framing.

Several houses recently completed in California employ a novel reinforced concrete frame (as distinct from solid concrete walls). This type of construction depends upon a standardized system of metal forms which are manufactured and rented by the Gravelite Co., Inc., Point Richmond, California. The same firm also produces "Gravelite," a lightweight aggregate of burned expanded clay.

Structural frames of reinforced concrete, in contrast to solid concrete walls, are being used for residences in California. Three features which give special interest to this construction are the use of a minimum of concrete, of steel forms rented for the duration of the pouring, and of a new lightweight synthetic aggregate. With only a minimum of concrete, a very stiff structure is obtained, due to the fact that the frame and solid frame floor slabs are poured monoliths. If concrete distribution were uniform, the concrete thickness in the entire wall surface would be only one inch, but the walls and columns of the structural frame are 6" thick, and requirements of the California building codes are more than met.

The steel forms which constitute so much of the newness in this method of construction are built to a simple pattern of pressed steel and 5-ply plywood strips. They can be rapidly assembled, placed, lined up and secured. There are four standard shapes, for side walls, inside corner columns, inside corners, and outside corners. In addition there is a standard spacer. For a single pour, the form set up includes columns, spandrel beams and floor forms. An entire story is poured in one operation and, with quick-setting cement, the forms may be stripped in three days. Except for the placement of a few 2" x 6" nailing studs and frames for doors and windows, the house frame is then complete. If, however, there is another story, the same frame may be re-assembled for use on the second floor. In the first pour, which is made all at one time and includes the floor level, regardless of whether the floor forms

(Continued in adv. section)

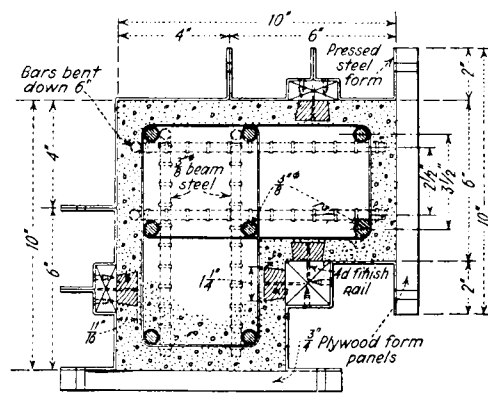

Cross section of standard corner column.

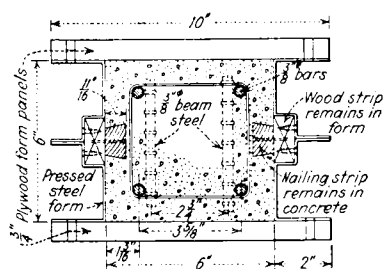

Cross section of standard inside column.

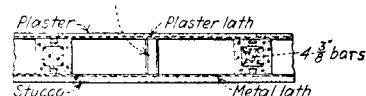

Cross section of typical wall, showing concrete columns, intermediate studs, interior and exterior finish and metal lath.

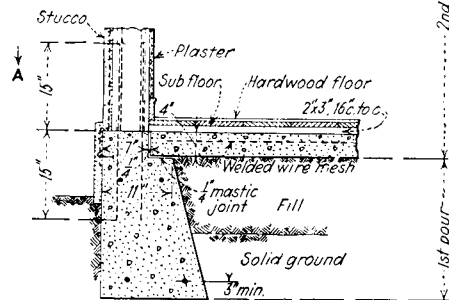
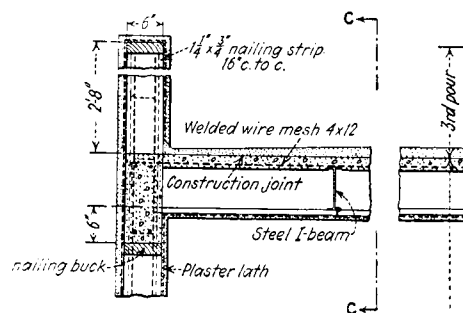

Vertical section of completed structure showing the sequence in which pouring takes place, so that steel forms can be used repeatedly.

"Farrenwall" system includes structural units of clay

Currently used in Nebraska because its insulating values are greater than traditional masonry construction. Farrenwall was used by N. B. Hazen, architect, in the two Lincoln, Nebraska, houses shown on page BT 9. This patented system is sold by the Western Brick and Supply Co., Omaha, Nebr.

"Farrenwall," a system of clay tile units of novel design, provides new insulation values, while it retains the same fire-and-termites-resistant factor of traditional masonry construction. The system has three main features: a double basement wall which provides a continuous integral cold air return from the first floor to the air conditioning system; a variation of this system for use above grade; and a novel construction system for floors involving a tile joist and floor slabs.

The basement wall, below the grade line, has a double brick, or "Farrenwall," construction, through which cold air is conducted to the tile subflooring of the basement, and thence to the furnace. A closure course runs continuously around the wall 30 inches below the closure course at the finished grade line. Cold air ducts from the upper floors extend below this second closure course, and connect with the double brick passage to the furnace.

The basement floor is of 1½" concrete with a subflooring of hollow tile, 3" x 12" x 12", through which cold air reaches a tunnel leading to the furnace. The tunnel has walls of 4" x 12" x 12" tile and a flooring of 2" concrete. The top is the 2" concrete basement flooring, reinforced at this point by ¾" stay-ribs.

Above the grade line, the wall construction consists of face brick for the exterior, a fill of Corolite, then hollow tile, with a row of channel brick every course of tile, and a plaster finish for the interior. The Corolite and the hollow tile are for insulation; the cold air is returned by pipes placed in each wall. Grilles, with shutters, at the floor level lead to these pipes.

The precast tile beams which carry the floors, spaced 29 in. on center, are fitted with wrought iron stirrups to carry the load. Under the stirrups is a brick fill. Both header and joist are of

(Continued on page 60 adv.)

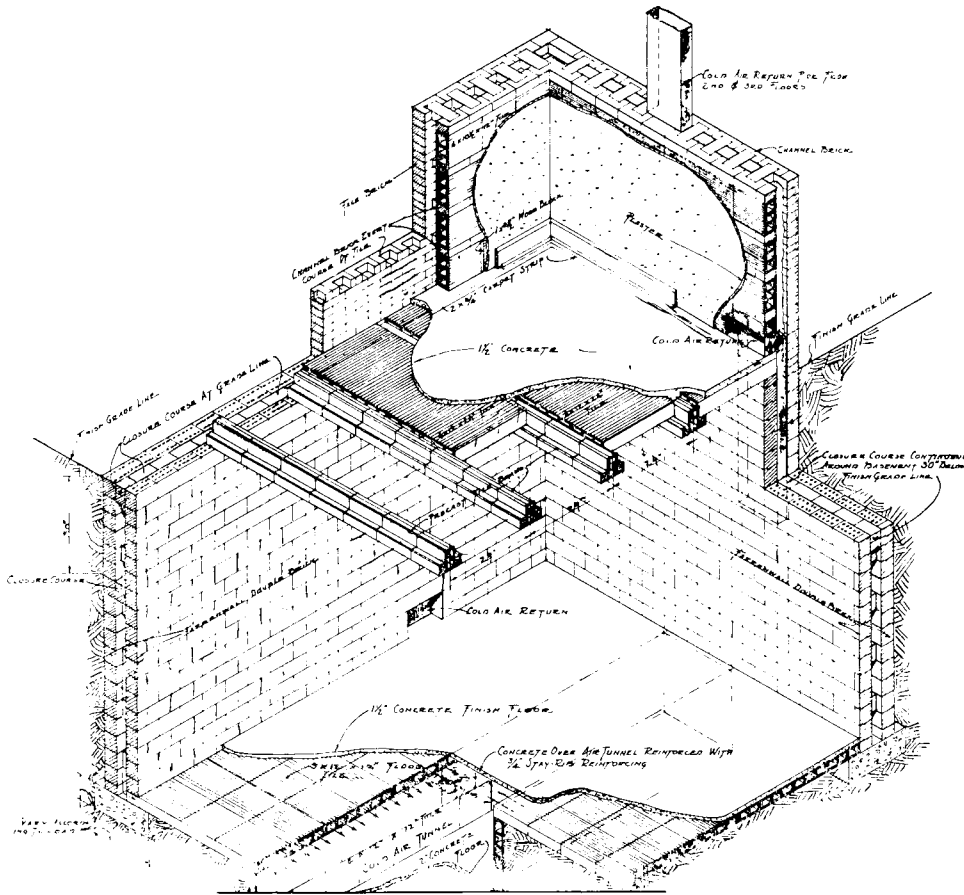

Isometric view of "Farrenwall" system, showing ventilating system incorporated in basement floor and walls.

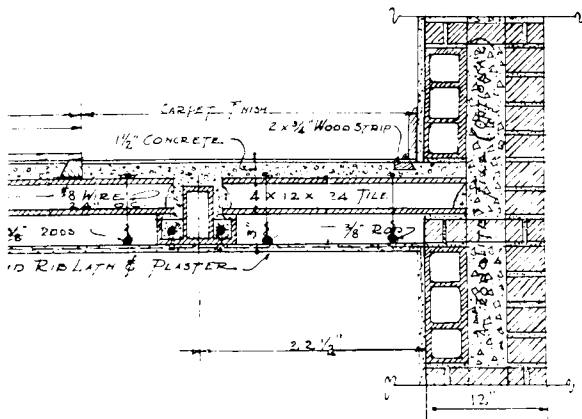

Cross section of typical floor construction.

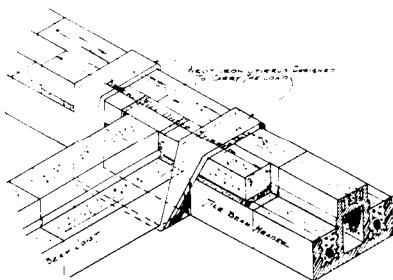

Detail of beam framing.

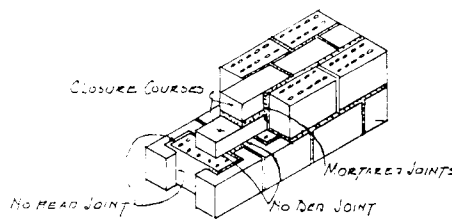

Detail of closure courses.

UNIVERSITY OF ILLINOIS RESEARCH IN HEATING AND VENTILATING SHOWS IMPORTANCE OF STRUCTURE

By DR. E. P. KRATZ

The problem of economical heating may be divided into two parts consisting of, first, the effective production and utilization of heat; and second, the effective conservation of the heat produced. While these two parts of the problem are of equal importance, most of the emphasis has been placed on considerations of the factors affecting the choice of equipment for efficient production and utilization of heat; and, until recent years, the use of insulation as a means of effective conservation of heat through the reduction of the heat loss from the building as a whole, has not received the consideration that it merits. However, the increasing popularity of the more expensive fuels, such as gas and oil, has given an incentive for the development of better methods of conservation, with the result that numerous forms of heat insulating materials for residences are now readily available.

The necessity for the use of effective heat insulation materials in cold storage rooms where the room temperature must be maintained considerably lower than that of the outdoor air, has been realized by refrigerating engineers for a great many years, and the principles underlying their use have been well established. These principles are not fundamentally different in the case of heating, where the room temperature to be maintained is higher than that of the outdoor air. However, the newness of this point of view to the general public and the sometimes conflicting claims regarding the available materials, have resulted in considerable confusion on the subject, thus creating an atmosphere of apparent mystery where no mystery actually exists.

If a building with the inside air and contents at 70 deg. F. is surrounded by outdoor air at less than 70 deg. F., it is obvious that there will be a continual loss of heat through the outside walls of the building as long as the temperature difference is maintained. It is also evident that if the temperature inside of the building is to be maintained, the heating system must supply the heat just as rapidly as it is lost from the building. Further consideration, therefore, indicates that no

matter how efficient the heating system is, if the building is poorly constructed and leaks heat rapidly, a large quantity of heat must be generated, and the heating cost will be high as compared with that for a building for which the heat leakage is less.

Heat escapes from the building in two ways. Wind blowing on the windward side forces cold air into the cracks around the doors and windows, and at the same time forces a corresponding weight of warm air out of the cracks on the other side. This warm air has been heated at the expense of fuel used in the heating plant and thus represents a preventable loss in fuel escaping through loose windows and doors. The remedy is to calk all cracks in the window frames, and to use either weatherstripping or tightly fitting storm sash on all windows. Tightly fitting storm sash have the additional advantage of saving about one-half of the heat that would normally escape through the glass, as well as practically all of that resulting from air leakage.

The second way in which heat escapes is by conduction through the materials forming the walls, floors, and ceilings of the rooms. The amount of heat conducted depends on the nature and thickness of the materials. The denser materials are, as a rule, the better conductors and hence the poorer insulators. All metals are very poor insulators; wood is a better insulator than stone, brick or concrete; and a dead air space, or one in which no air movement takes place, is about the best heat insulator known. For any given material, increasing the thickness reduces the amount of heat conducted in a unit of time. Hence, heat may be saved either by using the same thickness of a better insulator, or by increasing the thickness of a poorer one. Until the advent of the more expensive fuels, wood, brick, concrete and stone were considered sufficient for the purpose of insulation. In order to provide for the more expensive fuels, however, it has become advisable to use additional inexpensive materials, which are better insulators, and which reduce the cost over what would be necessary if the thickness of the common building

materials was increased to give the same degree of insulation. In all cases, the commonly accepted structural materials should be used to give the building strength, and the insulation should be used as additional materials. That is, the insulation should not be substituted for structural material.

It has been noted that a dead air space is a very good insulator. The better insulators owe their value to the fact that they are porous, and thus contain a large number of dead air cells. Most of the insulators on the market have approximately the same proportion of dead air cells. Therefore, their insulating values, for the same thickness of material, are not essentially different. It should be emphasized, however, that the commercial insulating materials are made in different thicknesses. More confusion has arisen from this practice than from any other. The insulating values should be compared on the basis of the same thickness, and not on the thickness as made. For really effective insulation, a thickness of at least 1½ inches should be used in addition to the regular structural materials.

In comparing insulators, even when used in the same thicknesses, some consideration must be given to the structure of the walls in which they are to be used. When the insulator is installed, only part of the original heat loss from the wall can be saved, and the percentage thus saved depends on the original heat loss. For example: assuming air-tight construction and good workmanship, with 70 deg. F. indoors and zero outdoors, approximately 16.2 heat units will be lost in an hour from each square foot of standard frame wall. If 1½ inches of insulation are added to this wall, only 8.3 heat units will escape per square foot of surface in the same time. Using this same insulation on a plain 8-inch brick wall, without any other interior or exterior finish, the heat loss would be 9.5 heat units per square foot of wall. However, the original heat loss from the uninsulated brick wall would have been 25.0 heat units as compared with the 16.2 units lost from the frame wall. Hence, the saving effected by

(Continued on page 62 adv.)

By J. C. HARDIGG



Clearly demonstrating the pressure which mechanical equipment exerts on the structural shell is this house in Cleveland. One of a group designed and built by Kelvinator Corporation to demonstrate the necessity for better integration between structure and equipment.

So much is being written on air conditioning that the layman (the client) becomes confused. It is here that the architect must be prepared to protect his client who may suggest forms of air conditioning which are not practical, not necessary, and as yet too far into the future, although within a decade they may be fully developed and taken as a matter of course.

Air conditioning as accepted today means the maintenance within prescribed limits of the temperature and relative humidity of the air within a house and, at the same time, cleaning and circulating it. Other treatments to air have been tried such as ionization—charging it with either positive or negative electricity; it may be possible to destroy, in part at least, any bacteria that pass through the air filters by using ultra violet rays. These other treatments should be applied only on prescription of the medical profession, and so far are not recommended for general air conditioning.

Air conditioning publicity has been so well handled and the public mind has proved so receptive that today the man with money to build a new house or remodel an old home expects to spend part of his money on air conditioning just as on excavation, walls or roof. The architect and the engineer bear the responsibility of advising a client on the type of air conditioning suitable to his house and to his pocket-book. In this they will find the manufacturer not only willing but eager to help. This attitude has two very logical reasons behind it: first, that of

Mr. Hardigg gives an engineer's survey of current trends in the field worth watching.

forwarding air conditioning development; second, the practical and equally laudable one of guarding against setback to a promising business which would result from unsuitable installations. The growing demand for one-family homes of approximately six rooms makes consideration of this type of air conditioning particularly timely.

Before going into consideration of selection of equipment the architect will be greatly helped by realizing just how much the client is willing to put into construction costs, and by this is meant provision for building detail that insures tightness against air and dust. But here again the client will need education. In most instances it will be safe to assume that the man who is willing to pay for first-class construction and insulation will be willing to pay a little more for windows, doors and frames. But there will be cases where the architect must stand prepared to guard his client against false economy.

As an example of extra dollars well spent, there is flashing. Flashing against air leakage in the form of weatherstripping for windows and doors is not a luxury but accepted good construction. This flashing is between window sash or door with its frame; the same should be true of the frame and the opening in the wall it is set into.

There are two schools of thought today in air conditioning of the six- to ten-room house. One school prepares the air completely in one place and then distributes it through ducts to each room. The other heats the house with conventional radiator system, does the rest of the air conditioning at one place and distributes it from one or two central points. In addition to these methods there is the split system of air conditioning whereby the bath, the kitchen and the garage are heated with radiators, whereas the rest of the house

is fully air conditioned.

Developments in both method and equipment have been made to reduce the cost of installation as well as operating costs. Today the installed cost for complete air conditioning in a six-room house is approximately \$1,000. The system can be run for \$150 a year. Comparison of these figures with those for steam heat only shows the complete air conditioning costs to be approximately 50% more. The low operating cost of the air conditioning equipment is due to better insulation, more accurate balancing of the equipment to the work to be done, and accurate control.

The heat for the air conditioning system employing ducts to each room is supplied by a steam or hot-water boiler. The domestic hot-water supply is made the year round in a copper coil installed inside the boiler below the water line. In warm weather when the system does not require heat for the house the boiler water is kept automatically just below steaming temperature by an aquastat whether the boiler burns coal, oil or gas. In a hot-water boiler the circulation to the heating coil in the system is automatically stopped. This method of supplying domestic hot water is a decided advantage. There is always an abundant supply of hot water without any care. The cost is less than where the hot water is made separately.

In cold weather the air is drawn by a fan through a filter, then either through a water spray or a humidifying pan and then through a heating coil supplied with steam or hot water by the boiler. The air then enters the fan which discharges into the main distribution duct. A large part of the air is returned in ducts by the fan. This air with a portion drawn in from the outside—fresh or ventilating air—passes again through the conditioner.

(Continued on page 65 adv.)

MODERN ELECTRICAL SYSTEM MUST BE FLEXIBLE

By CARLE ROBBINS

New radial wiring system provides for later expansion, increases resale value.

To begin with (and I believe any architect active in this field will agree), the typical client has a split personality. On one side is a hard-headed person bound to get the utmost in value from each penny spent, while on the other is a person absorbed in "style" and "what it will look like." Now, actually the problem facing the home builder is a different and much deeper one. He must build a house whose value is two-fold: *to himself and his family while they live in it, and to other families if he has to sell it.* For, in this age of change, the owner-built house must have one characteristic: salability. This in turn implies that the house must not be obsolete in a year or two, as regards plan, structure or equipment.

As this situation almost invariably arises with the architect who does a fair volume of medium-priced homes for private builders, I offer this method of planning, used by an architect who has been successful in this field. He seats his client and describes a house, not as a static pile of construction materials covered by a roof, but as a living, functioning entity, an organism designed to provide the owner with warm comfort in winter, with cooling, refreshing air in summer, to relieve him and his wife of all unnecessary toil and drudgery. Naturally the organism must have a good bone structure, be well muscled. There must be protective layers of fat to conserve bodily warmth.

Furthermore, this organism shall possess a brain, which will enable it to perform automatically. The possession of a brain presupposes the existence of a nervous system; and it is in this exposition of the nervous system of the projected organism that the architect does some of his most important work. He uses a chart, showing the nervous system of the house—the electrical wiring, in other words. This chart not only depicts the old methods of wiring which, through the increased use of electricity in the home, have become

totally inadequate, but it portrays the new system, *a radial system*, designed effectively to take care of modern demands.

The feature of this radial system is a succession of trunk or feeder lines of extra size which run to centrally-located circuit breakers. Then from the breaker two or three wires of ordinary size radiate to nearby outlets. The advantage of this planned wiring lies in the fact that all devices or appliances are fed with adequate amounts of current, and that there is no current loss as there is when, under the old system, there is overload and consequent heating of the overburdened lines.

"But what are circuit breakers?" the client asks. These will be explained as serving in a dual capacity, the first of which is that of master control switch, the second as a protector to its circuit branch against overload or shorting. About this time the client is sure to make a query concerning cost. The answer is: Balance the cost of the radial system against the miles of wire used in the old system and add the saving in current, and it will be found that the radial system costs no more.

Following an adequate explanation of these terminals of the main feeder lines of the system, the further ramifications of the system may be traced. For example, travel over the line leading to the kitchen; these wires will lead to the single outlets for the refrigerator, the electric sink which carries the dishwasher, and the garbage disposal unit. There are twin outlets of the double-duty type over the work surface to accommodate such appliances as toasters, mixers, etc., and two other outlets to accommodate the ventilator fan and the electric clock. Possibly some time should be devoted to explaining the special three-wire range outlet and the special outlet of the same type for the water heater. There are other ordinary outlets for the radio and the annunciator or bell system.

Or possibly he may ask: "Well,

what will a complete electric kitchen cost me?" The architect can explain that there is wide range in the price of complete electric kitchens. One which includes refrigerator, range, dishwasher and garbage disposal service may be purchased as a package for as little as \$700, and this cost may be carried with the mortgage as a slight additional monthly payment. At this stage it is well to discuss the rudiments of kitchen engineering, and by a small sketch show how proper kitchen planning saves an untold amount of energy.

Then back to the chart of the nervous system of the house. Lead him to the basement with its power outlet for the air conditioning equipment, oil burner, gas furnace. Naturally there must be a heating system in his house, therefore why not put one in which will provide constant temperature, proper humidification; that will eliminate the dirt of the old-type system and, furthermore, will function automatically, through its electrical nerves and brain?

"But I don't want air conditioning, do I?" (The client holds the belief that air conditioning may become practical in his grandson's day, but he's too smart to be hooked by experimental gadgets now.) The architect will explain that complete summer and winter air conditioning for a \$10,000 house would total about \$2,000, but it should also be explained that whether the owner does or does not desire summer air conditioning at the present, adequate preparation should be made as the house is built for the installation of such a system at a later date. The reason? Again, salability.

Then the architect should trace the lines to the laundry, the living room, the bedrooms, the attached garage, the recreation room, the dining room, the bathrooms, halls, stairs, passageways, then the main and side entrances, carefully explaining the need for ample outlets and the function of the electrical devices demanded in these rooms. *From flat plate ironers, operated electrically, to burglar alarms, and an illuminated house number, the architect travels from the terminals to the outlets on the radial wiring chart. An isometric view of a house so wired and equipped will be found extremely helpful.

*Mr. Robbins considers illumination (both artificial and natural) as a separate and specialized design problem; and takes it for granted that, in discussing the nervous system of the house, the electrification necessary for adequate illumination is all that need be discussed.

INDUSTRY'S PROGRAM FOR REHOUSING AMERICA

(Continued from page BT33)

facturers, producers, contractors, and dealers realized what was being attempted, they hastened to cooperate.

Paramount Communities, Inc. is a laboratory from which it is confidently expected will come demonstration units which will prove the necessity and efficiency of industrial integration in the home building business. The company has reached the conclusions that creation of a sound product for both rent and sale by an industrial corporation operating on a large scale will:

- (1) Produce better homes at lower cost.
- (2) Provide protection from encroachment of adverse factors tending toward depreciation and deterioration.
- (3) Improve the general community plan thereby improving the local tax structure without increasing consumer cost.
- (4) Secure stability of investment.
- (5) Stimulate the use of long-term savings in the production of homes.
- (6) Through the development of the planned rental sections develop a new type of mortgage security, insured by the Federal Housing Administration, which will provide for greater liquidity for mortgage investments.

Construction has already been started on a project at Clarendon, Virginia, to be known as Buckingham Community. It is ten minutes from the heart of the nation's capital, and is fitted to the home needs of the governmental employee group as well as others. Marlborough at Tenafly, New Jersey, will probably be started later in the year.

These two neighborhoods, as complete as industrial integration and technical skill can make them, stand at the gateways to centers of population where come people from the four points of the compass. Buckingham and Marlborough will be for others to see and from which others may gain. If they prove their worth, and if the experience gained in these developments will be accepted by others, they will have been worth while.

However, lest it be said that our belief in our plan has caused enthusiasm to run riot, it must be pointed out here that *we realize full well that the demonstrable economic and social values of such an activity are contingent upon a large-scale continuous operation.* These two projects can serve only to show the *possibilities inherent in such activity*, which possibilities can be fully realized only if properly and consistently repeated. Since investment capital is notoriously slow to enter the building field because of the mistakes of the past, those who believe as we do may be compelled to think and talk for some time in terms of large-scale national operations, while their work is subject to many of the limitations of small-scale operations.

We have faith that even the limited results we produce in a field of national proportions will convince others that social and economic progress will be more quickly stimulated by the application of industrial integration to the task of building better homes for more people at lower cost.

PURDUE COMPLETES YEAR OF STRUCTURAL RESEARCH

(Continued from page BT35)

Houses Nos. 1 and 4 are cellarless. Excavation costs of House No. 1, 0.4 per cent of the total cost and House No. 4, 0.9 per cent, reflect site conditions and also the increased

ground area of House No. 4, which is one story in height. This fact is also reflected in the foundation costs of 1.9 and 7.3 per cent. Allowance must also be made for the building of the foundation of House No. 4 between wooden forms as against trench-filled foundations for House No. 1. Excavation for House No. 3 ran 4.3 per cent and foundations 8.6 per cent; House No. 5, excavation 1.0 per cent and foundations 5.2 per cent. Both houses have basements. The wide variation in excavation and foundation costs was due to site conditions, weather, and construction methods.

Walls and partitions in the four houses showed relatively small variations of 23.4, 22.9, 23.9, and 21.5 per cent. Floors and roofs in a similar way were more or less uniform, their cost percentages being 17.0, 14.7, 21.2 and 16.0.

No marked variation in the cost of millwork developed. This item represented a cost of 20.7, 19.0, 14.2 and 15.0 per cent of the total cost of Houses Nos. 1, 3, 4 and 5. Sheet metal work in all cases was a negligible item amounting to 1.5, 1.1, and 2.7 per cent. Stairs in Houses Nos. 1, 3 and 5 accounted for 2.1, 1.4, and 3.5 per cent and accessories, 2.7, 4.3, and 2.7 per cent of the total cost. Painting costs were 6.6, 2.3, 7.2 and 6.8 per cent.

Heating, plumbing and electrical installations showed little variation in cost. The heating systems in Houses Nos. 1, 3, 4 and 5 represent 10.7, 8.9, 7.8 and 9.7 per cent of the total. House No. 5 is heated by a one-pipe steam system. The others are warm-air systems—forced or gravity and using oil, gas, or coal for fuel. Plumbing cost percentages were 7.6, 7.2, 7.8 and 5.8; and electrical, 2.4, 4.1, 2.5 and 3.1.

Contractors' overhead and profits showed considerable variation ranging 3.0, 1.2, 4.5 and 9.7 per cent of the total.

Excavation, foundations and contractors' overhead and profit showed the greatest variation with the exception of the painting and the reinforced concrete house which was considerably below that of the other houses.

Major costs are reflected in walls and partitions, floor and roof, millwork, and mechanical equipment (heating, plumbing and electric), the average cost of each being 23, 17.2, 17.2 and 19.4 per cent respectively. These four items make up more than 75 per cent of the total cost of the type of house studied at Purdue University.

Machinery company builds first all-steel "truckable" house

(Continued from page BT36)

Production methods, which are being perfected on the five houses now being built, will permit completing future houses with the economy, precision and speed employed in manufacturing scrapers and other Le Tourneau equipment. It is estimated that with present available space and facilities one house can be finished every three weeks.

In constructing these houses the floor is built first, upside down and in two sections. The floor plates are laid on a concrete and steel platform of the exact ground area of the house. The floor is built in two sections, two plates being tacked together into one half, two into the other. Atop these plates 6" junior I-beams are set crosswise at intervals of 2 feet and welded to the floor plates. Then 12" junior channels are placed along the outside edges, welded to the plates. Two girders, each consisting of two junior I-beams welded together, run the length of the floor. Water and soil pipes are installed, and fitted. The whole underside is then painted with a primer coat of noncorrode paint and with a black asphalt coat of noncorrode paint. The two halves are turned

(Continued on page 56 adv.)

A
C
K
N
O
W
L
E
D
G
M
E
N
T
S



E S T H E R B O R N

UNLESS OTHERWISE INDICATED, ALL PHOTOGRAPHS WERE TAKEN BY ESTHER BORN. DATA AND MATERIAL WERE COLLECTED AND ARRANGED BY ESTHER BORN AND ERNEST BORN. (Esther Born and Ernest Born were both students of architecture at the University of California under the distinguished teacher, John Galen Howard. Disgusted with the amateur photographs she took during a trip to Europe, Esther Born studied photography as preparation for specialization and as an aid to her future architectural work. Ernest Born is well known both in San Francisco and New York as a brilliant designer, and has been associated with THE ARCHITECTURAL RECORD and other publications in designing architecture, typographical layouts and editorial work.)

The collectors of this material wish to express their appreciation to all those persons who have helped to make this book possible. First in this group are the contributing architects and engineers, whose names are recorded on the following pages. They gave unstintingly of their time, not only with respect to information on their own work, but often by calling attention to work of their colleagues which might otherwise have not become known.

Particular thanks must, however, be expressed to the following architects: Carlos

Obregón Santacilia, Juan O'Gorman, Carlos Tarditi, José Villagrán García, Enrique de la Mora, Carlos Contreras, José A. Beltrán, Ignacio Diaz Morales, Luis Barragan, Ortiz Monasterio. With this group, appreciation must be expressed to: Federico Sanchez Fogarty, advertising manager of the Tolteca Cement Company; A. Misrachi of the Central News Company; Diego Rivera; José Rivera, Director of the Association Mexicana Automovilistica; William Harrison Furlong (Furlong Service, San Antonio, Texas); Justino Fernandez, assistant professor of art, University of Mexico; Wm. B. Richardson of the National City Bank, Mexico City, and his secretary, Ida Corcoran—all of whom contributed to this work in some vital way.

For data on buildings built with Federal funds throughout the Republic, appreciation to José López Moctezuma, Jefe de Departamento de Edificios, Secretaria de Comunicaciones y Obras Publicas; for data on buildings and works by the City of Mexico, appreciation to José L. Favela, Director de Obras Publicas y Servicios Urbanos, Departamento Central, and to Alberto Villa Corral.

Kodak Mexicana Ltd., last on the list, but without whose generous help and cooperation this work would have been next to impossible.

The unfailing helpfulness of the American Photo Supply Company is also gratefully acknowledged.